



HAL
open science

SCALP: a detector for (n,α) cross-section measurements

G. Lehaut, M. Bourgeot, B. Galhaut, D. Goupillière, M. Henri, F.R. Lecolley,
X. Ledoux, Lory J., L. Manduci, N. Marie, et al.

► To cite this version:

G. Lehaut, M. Bourgeot, B. Galhaut, D. Goupillière, M. Henri, et al.. SCALP: a detector for (n,α) cross-section measurements. EPJ Web of Conferences, 2020, 225, pp.01001. 10.1051/epj-conf/202022501001 . hal-02467342

HAL Id: hal-02467342

<https://hal.science/hal-02467342>

Submitted on 29 May 2024

HAL is a multi-disciplinary open access archive for the deposit and dissemination of scientific research documents, whether they are published or not. The documents may come from teaching and research institutions in France or abroad, or from public or private research centers.

L'archive ouverte pluridisciplinaire **HAL**, est destinée au dépôt et à la diffusion de documents scientifiques de niveau recherche, publiés ou non, émanant des établissements d'enseignement et de recherche français ou étrangers, des laboratoires publics ou privés.



Distributed under a Creative Commons Attribution 4.0 International License

SCALP: a detector for (n, α) cross-section measurements

G. Lehaut*, M. Bourgeot*, B. Galhaut[†], D. Goupillière*, M. Henri*, F.R. Lecolley*, X. Ledoux[‡], J. Lory*, L. Manduci[†], N. Marie*, J. Perronnel* and Ch. Vandamme*

*Laboratoire de Physique Corpusculaire de Caen, ENSICAEN/Univ. de Caen/CNRS-IN2P3, France.

[†]Ecole des Applications Militaires de l'Energie Atomique, BP. 19, 50115 Cherbourg Armées, France

[‡]GANIL, Grand Accélérateur National d'Ions Lourds, CEA-DSM/CNRS-IN2P3, BP 55027, 14076 Caen Cedex 5, France

Abstract—Neutron induced reactions on oxygen have been studied with strong interest because of the uncertainties generated on the helium production in fuel and on the neutron multiplication factor in nuclear reactors [1], [2]. Still large discrepancies exist and new measurements are welcome in order to acquire new data aiming at the uncertainty reduction [3].

SCALP (Scintillating ionization Chamber for ALPha particle production in neutron induced reaction) is a new scintillating ionization chamber [4] used as an active target to measure the cross section of (n, alpha) reactions on various gaseous targets such as ^{19}F or ^{16}O , from the reaction threshold up to 15 MeV. It consists of an ionization chamber filled with CF_4 (for fluorine measurements) or CF_4+CO_2 (for oxygen measurements) allowing the detection of the energy deposited by the light charged particles emitted in the (n, alpha) reaction. In addition, four Photo-Multiplier Tubes detect the scintillation light produced by the interaction of the particles in the gas active volume. Taking advantage of the fast response of the scintillation, the neutron kinetic energy can be inferred by time-of-flight measurements. SCALP is then well adapted to mono-energetic neutron beams or to white neutron beams that will be delivered at the NFS Facility [5].

Because of its good resolution, SCALP discriminates different channel outputs, enabling to disentangle the different reactions [6]. We will present the performances of the SCALP detector in terms of temporal and energetic features. We will also present tests made at the GENESIS plate-form at the LPSC Grenoble [7].

I. INTRODUCTION

In the context of global warming, nuclear reactors are considered as an important supply of nearly carbon free energy production. However, great efforts are still deployed to improve their safety as well as the reduction of the ^{235}U consumption in view of its exhaustion in the next century.

In this context, reactor simulations are recommended to make future plants more safe and efficient. Some codes (Monte-Carlo or deterministic) allow specific simulations in neutron transport (based on the Boltzman equation) and/or in the thermohydraulics. These simulations give access with a very high precision to the neutron flux in the reactor core or in the surrounding structure. The drawback is that, since these codes need measured or evaluated nuclear data inputs (such as nuclear cross sections, decay constants...), the uncertainties of the simulated results depend on those of the nuclear data.

For reactor calculations, all possible reactions will not have individually the same impact on integral observables.

The $^{16}\text{O}(n,\alpha)^{13}\text{C}$ figures among these key reactions because it affects the knowledge of helium production in the fuel since 25% of this helium is produced by $^{16}\text{O}(n,\alpha)$ and induces an uncertainty of a few hundred of pcm in the neutron multiplication factor (k_{eff}) which is a fundamental parameter for the reactor control [3]. Therefore this reaction belongs to the High Priority List of the NEA who demands more measurements for this reaction from its threshold up to 10 MeV.

The SCALP (Scintillating ionization Chamber for ALPha particle) detector was designed and built to satisfy this request. The section 2 presents a description of the detector and its electronic acquisition. Then in section 3, some results obtained with a tri- α -source and also with a 15 MeV neutron source are shown.

II. SCALP DETECTOR

A. Description

SCALP is an active gaseous target designed to estimate the cross-section of the $^{16}\text{O}(n,\alpha)^{13}\text{C}$ reaction. It consists of a Ionization Chamber IC coupled to four Photo-Multiplier Tubes PMTs which read the scintillating light produced by the neutron interaction in the CF_4 scintillating gas. Taking advantage of the fast response of the scintillation, the neutron kinetic energy can then be inferred by time-of-flight measurements.

Fig. 1 shows the SCALP detector. It is made of a sealed gas vessel with four quartz portholes to allow the scintillation from the gas to be detected by Hamamatsu R2059 PMTs having an extended wavelength photo cathode. In the gas volume there is also a IC delimited by two electrodes (surface $123\times 123\text{ mm}^2$) spaced by 125 mm and between which a potential difference of 4 kV is applied. A constant drift electric field is ensured in the active volume by field-shaping wires. The induction of the ionization signal takes place in the last 5 mm of the chamber thanks to a Frisch grid. The electrons produced during the ionizations are collected and this signal is then amplified by a charge preamplifier.

B. Detector acquisition system

The signals from PMTs are sent to a FASTER [8] Caras Module in QDC/TDC (charge/time digital converter) mode, where a Constant Fraction Discriminator is implemented to allow a good resolution of the time of PMT signal t_{PMT}

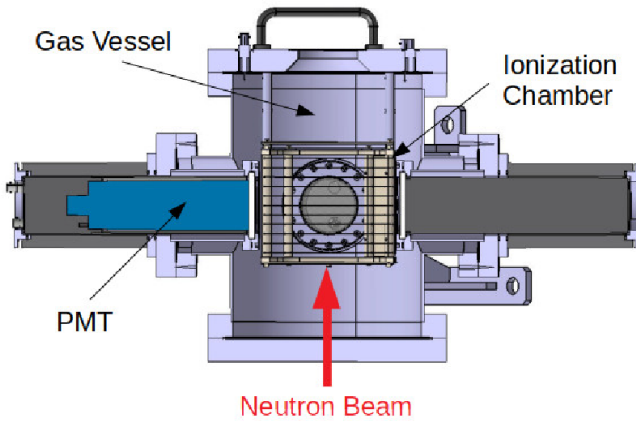

Fig. 1. Mechanical sketch of SCALP showing the principal component of the detector: a gas vessel, the PMTs and the ionization chamber.

(for a gate shape signal, the TDC achieves a resolution $\sigma_{TDC} \approx 10$ ps). The charge signal of each PMT is integrated over a 100 ns windows.

Also the IC signal is sent to a Caras Module in a ADC (amplitude digital converter) mode. The threshold trigger for the IC is carried out on a fast signal ($\tau_{shapping} = 60$ ns) at a time t_{IC} , the pulse height (PH) being measured after a spectroscopic filter ($\tau_{shapping} \sim \mu s$).

During the acquisition time, each signal is independent. PMT signals are merged in offline analysis with a temporal cut $\Delta t_{PMT} < 10$ ns. PMT and IC signals are also merged with the condition $\Delta t_{IC-PMT} < 10 \mu s$. In this way coincidences are selected and the event-by-event analysis can be done.

III. DETECTOR TEST

A. α -source response

In order to test the SCALP response in laboratory, an α -source was used. It was composed by 3 isotopes ^{239}Pu , ^{241}Am and ^{244}Cm , leading to α -particle mean energies of, respectively $E_{\alpha} = 5.14; 5.44; 5.8$ MeV.

The source was placed in the active volume in such a way as to emit in the half solid angle parallel to the electric-field. It was collimated.

The first tests were done with a pure CF_4 gas at 1 bar.

Fig. 2 shows the light output obtained for the α -particle source. The mean value is around 15 photo electrons (p.e.). With the help of coincidences among the photomultipliers, it is possible to reduce the background noise. The resulting curve is in red.

The correlation between the lights measured by two PMTs are shown on fig. 3. The similar response of the two PMTs are expected since their positions are symmetric relative to the source position.

The difference between PMT-time signals was also studied, see fig. 4. The dispersion around the average value is $\sigma_{CRT} = 1.15$ ns (corresponding to the coincidence resolving

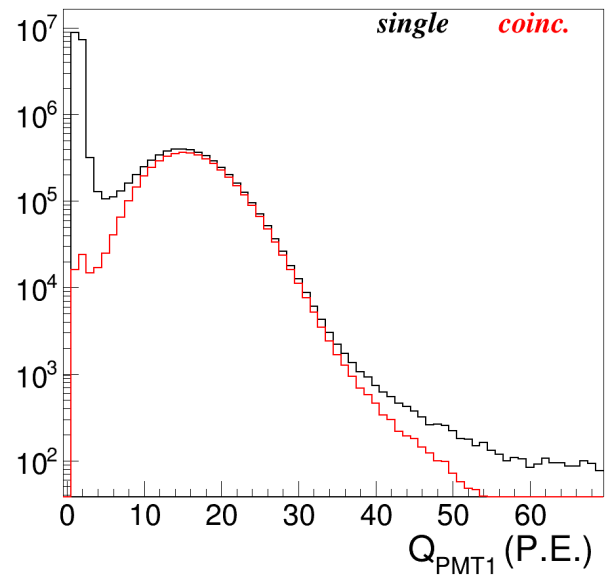

Fig. 2. Distribution of the light detected by a PMT for 5.5 MeV α -particles. The black curve shows all events and the red curve shows event in coincidence with at least one another PMT.

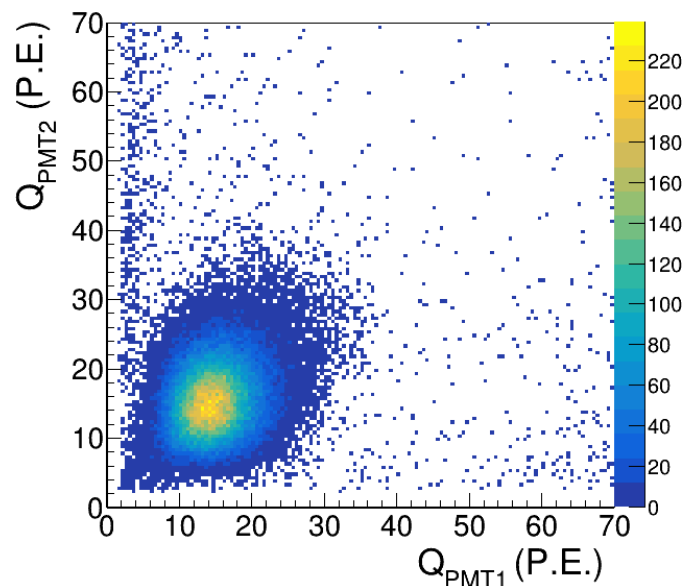

Fig. 3. Correlation between the light detected by two PMTs for the same set of events.

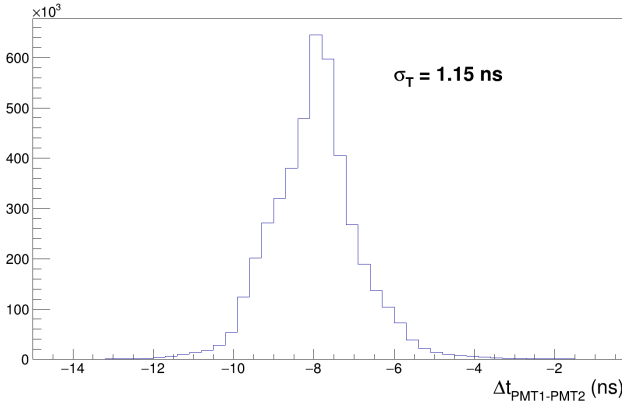

Fig. 4. Distribution of the time difference between two PMTs for the same set of events.

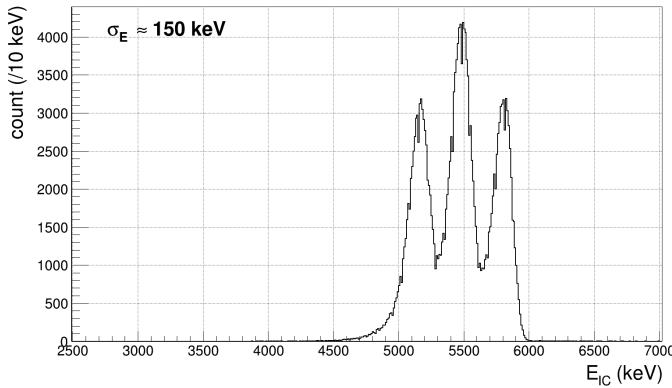

Fig. 5. Energy spectrum of the tri- α source, after calibration.

time of our set-up), which constitute a good result for our purpose.

With a linear energy calibration inferred from the tri- α source measurements, the α energy distribution obtained from the IC response is displayed in fig. 5. The energy resolution is about $\sigma_{IC} = 150$ keV, for the 5-6 MeV energy range.

SCALP allows also the vertex position determination, i.e., the distance of the interaction point from the Frisch Grid. This can be obtained using the time difference between the IC signal and the involved PMT signal: Δt_{IC-PMT} . In fact, using the correlation between the α -particle energy E_α and the time difference Δt_{IC-PMT} (as shown in the upper panel of fig. 6), one can observe different time values induced by the pulse height (due to the threshold trigger) and the difference of fews millimeters walked by each α . In the lower panel of fig. 6 are presented the Δt_{IC-PMT} distributions obtained for three different α -particle energy selections associated to each of the isotope of the tri- α -source and shown as rectangles in the upper panel.

Measurements of the time difference Δt_{IC-PMT} were done for different source positions along the electric field axis. The results inferred for each of the three α -particle

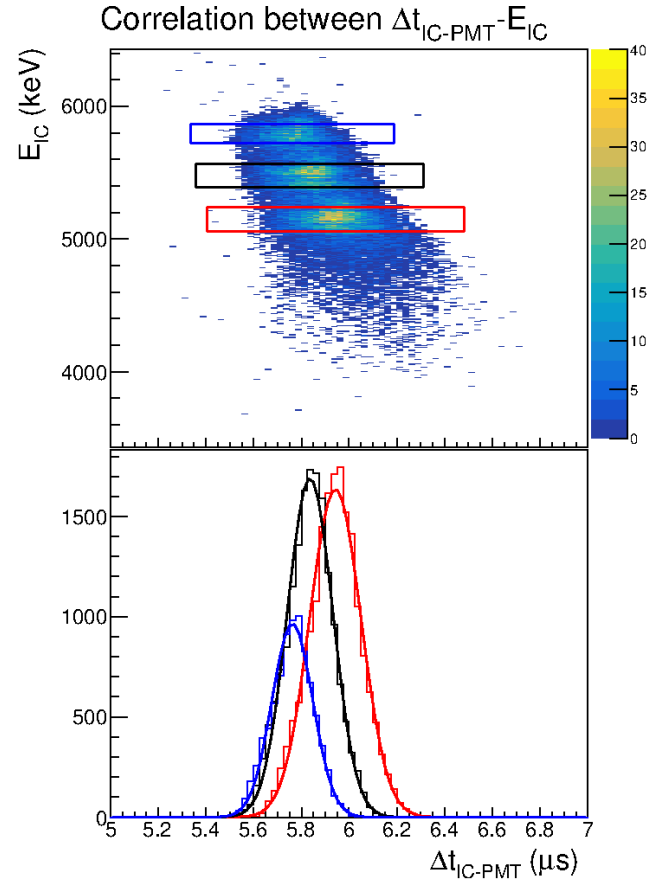

Fig. 6. Upper panel: Correlation between the difference between PMTs and IC time signals, Δt_{IC-PMT} and the α -particle energy, E_α , detected in the IC. Lower panel: Δt_{IC-PMT} distributions obtained for the three different α -particle energy selections associated to each of the isotope of the tri- α source and shown as rectangles in the upper panel.

energy selections are shown in fig. 7. A linear correlation between the difference Δt_{IC-PMT} and the source position is observed. The slope extracted, which correspond to the electron drift velocity, equals to $v_{drift}^e = 5.2 \pm 0.4$ cm/ μ s. This velocity value is in agreement with the one given in reference [9].

A second set of test was performed using a mixture of a few percent of CO₂ with the CF₄ gas. The CO₂ gas constitutes the target and its concentration in the active volume must be accurately determined. As expected, the introduction of even a small quantity of CO₂ changes the intensity of the output light. Fig. 8 displays the loss in light output as a function of the CO₂ concentration fraction. This loss amounts at nearly 40% for 3% CO₂ fraction. As expected, the resolution of the energy IC signal increases with the CO₂ concentration (see fig. 9). So, in order to maintain good specifications of our detector for physics measurements, the fraction of CO₂ in the active volume must not exceed 2-3%.

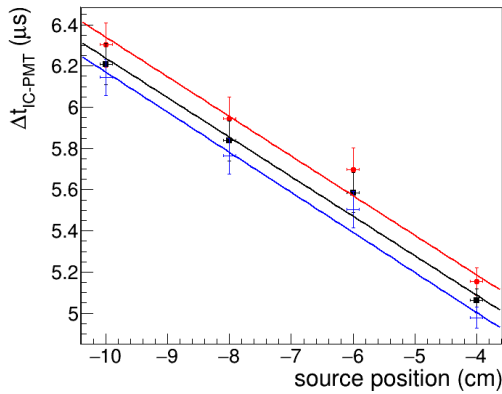

Fig. 7. Time difference Δt_{IC-PMT} for different source positions along the electric field axis and for each of the three α -particle energy selections.

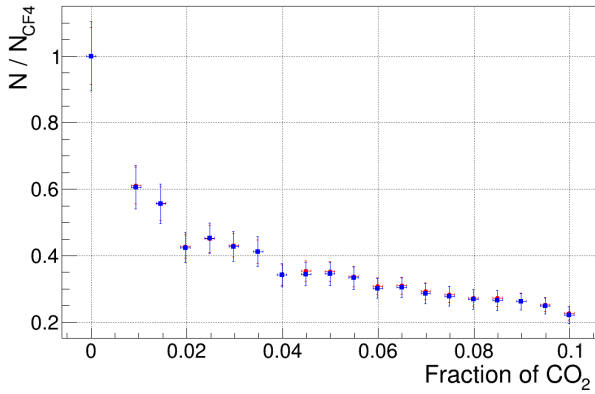

Fig. 8. Evolution of the light fraction detected by the PMTs as a function of the fraction of CO_2 gas added in the active volume. The evolutions obtained for two different PMTs are presented with red and blue points.

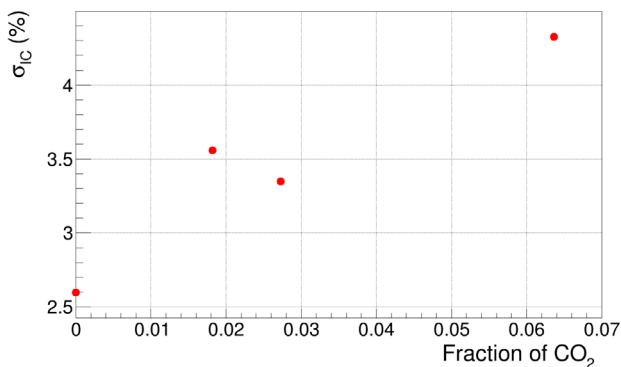

Fig. 9. Evolution of the IC energy resolution as function of the fraction of CO_2 gas added in the active volume.

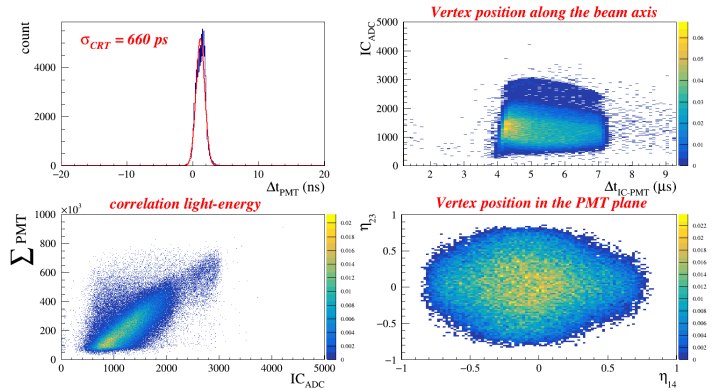

Fig. 10. Panel a): differences between the PMT time signals. Panel b): correlation between the time difference Δt_{IC-PMT} and the IC pulse height, ADC. Panel c): correlation between the ADC signal and the sum of lights detected by the four PMTs. Panel d): Correlation between the contrast variable of PMTs (see text for definition) along two orthogonal directions.

B. Test at GENESIS

To complete our tests done first with α -sources, the detector SCALP was installed at the GENESIS facility of the LPSC of Grenoble. This facility can deliver non-collimated neutron produced by $d(d, n)$ or $d(t, n)$ reactions using 220 keV deuteron electrostatic accelerator GENEPI2 [7]. For the SCALP test, a tritium target was used and neutrons were produced with an incident energy of $E_n = 15.19$ MeV.

Fig. 10 presents the response of the detector filled with pure CF_4 gas at a 1 bar pressure. In panel a), the time differences between the four PMT signals show that the detection of the neutron interaction time in the gas is achieved with a resolution of a $\sigma_{CRT} \approx 600$ ps. The event distribution in the whole active volume is illustrated in panel b) where the IC pulse height (ADC) is presented as a function of the time difference Δt_{IC-PMT} . Compare to the α source measurement at fixed position, the distribution of the time difference Δt_{IC-PMT} the neutron source distribution is larger corresponding to events distributed all along the electric field axis. In panel c), the correlation between the ADC signal and the sum of the lights detected by the four PMTs is presented. As expected, the correlation is linear (due to common origin of the scintillation and of the ionisation).

Defining the η_{ij} observable as it follows:

$$\eta_{ij} = \frac{QDC_i - QDC_j}{QDC_i + QDC_j}$$

and using these observable for face-to-face PMTs in the two orthogonal directions, one can obtain an image of the energy deposit in the active volume in a plane perpendicular to the PMT window (see panel d)). This combined with Δt_{IC-PMT} allows a 3D image of the interactions points.

All these results are quite good despite the fact that the detector was not operating at the nominal electric field because of a technical problem encountered.

IV. CONCLUSION AND OUTLOOKS

There is a need for new measurements of the $^{16}\text{O}(n, \alpha)$ cross-section. For this purpose, we developed a new detector, SCALP, allowing a simultaneous measurement of the time-of-flight of the incoming neutron and of the energy deposited by the charged particles produced in the reaction. This set-up makes use of both properties: scintillation and ionization of the CF_4 gas filling the detector active volume. First, laboratory tests were done with a tri- α -source of mean energy $E_\alpha \approx 5.5$ MeV. At this energy, the light detected by each PMT was estimated to be around 15 p.e.E for the pure CF_4 gas and 7 p.e. for a mixture of CF_4 and CO_2 (97/3). The coincidence resolving time of our detector was also extracted. It is of the order of one ns. Moreover, the energy resolution of the IC is 150 keV and 220 keV for respectively, pure CF_4 and a mixture CF_4/CO_2 . The time and energy resolutions are suitable for our experimental aim.

A test with a neutron source was also performed at the GENESIS platform at LPSC in Grenoble. The SCALP device is able to detect the neutron interaction in his entire active volume.

The next step of our program would consist in making the measurements at different neutron facilities (NFS@SPIRAL2, IRMM, Amade). The first campaign will be devoted to a pure CF_4 target in order to estimate the reaction rate of neutrons on carbon and fluorine nuclei. A follow-up campaign would be performed with a CF_4/CO_2 target. The data analysis and collaboration with evaluators will take place in frame of the SANDA (Supplying Accurate Nuclear Data for energy and non-energy Applications) project from H2020 program.

ACKNOWLEDGMENT

We would like to thank, the GENESIS team for providing the neutron source at the LPSC Grenoble: E. Labussière, S. Rey, M. Baylac, B. Cheymol and A. Billebaud. We also would like to thank colleagues, J.M. Fontbonne and L. Leterrier from LPC Caen for their technical support, especially for the IC instrumentation. This work was partially supported by the NACRE project of IN2P3 institute and by the NEEDS french program.

REFERENCES

- [1] M. Salvatores and R. Jacqmin, *Uncertainty and Target Accuracy assessment for innovative systems using recent covariance data evaluations* (International Evaluation Co-operation, NEA/WPEC-26, 2008), 464
- [2] M. B. Chadwick et al., *The CIELO collaboration*, Nuclear Data Sheets 118 (2014).
- [3] Courcelle, Nuclear Science NEA/WPEC-22, 2006
- [4] G. Lehaut, et al. *Scintillation properties of N 2 and CF 4 and performances of a scintillating ionization chamber*, Nucl. Instrum. Meth. A 797 (2015), 57-63.
- [5] X. Ledoux, et al., *The Neutrons for Science Facility at SPIRAL-2*, Nucl.Data Sheets 119 (2014) 353-356.
- [6] B. Galhaut, et al., *SCALP: Scintillating ionization chamber for ALPha particle production in neutron induced reactions*, EPJ Web Conf. 146 (2017) 03014.
- [7] <http://lpsc.in2p3.fr/index.php/fr/groupes-de-physique/enjeux-societaux/physique-des-reacteurs/plateforme-genesis>
- [8] <http://faster.in2p3.fr/>

- [9] J. Va'vra, P. Coyle, J. Kadyk, J. Wise, Nuclear Instruments and Methods in Physics Research Section A: Accelerators, Spectrometers, Detectors and Associated Equipment 324 (12) (1993) 113.