



HAL
open science

Advances in finite element modelling of the EUROSID-1 dummy

Jürgen Ruckert, Paul Marcault, Jutta Schlosser, David Lasry, Eberhard Haug, Jean Roger, Dominique Cesari, François Bermond, Robert Bouquet

► **To cite this version:**

Jürgen Ruckert, Paul Marcault, Jutta Schlosser, David Lasry, Eberhard Haug, et al.. Advances in finite element modelling of the EUROSID-1 dummy. ESV 1994, 14th International Technical Conference on the Enhanced Safety of Vehicles, May 1994, MUNICH, Germany. pp. 1058-1078. hal-02449669

HAL Id: hal-02449669

<https://hal.science/hal-02449669v1>

Submitted on 22 Jan 2020

HAL is a multi-disciplinary open access archive for the deposit and dissemination of scientific research documents, whether they are published or not. The documents may come from teaching and research institutions in France or abroad, or from public or private research centers.

L'archive ouverte pluridisciplinaire **HAL**, est destinée au dépôt et à la diffusion de documents scientifiques de niveau recherche, publiés ou non, émanant des établissements d'enseignement et de recherche français ou étrangers, des laboratoires publics ou privés.

Advances in Finite Element Modelling of the EUROSID-1 Dummy

Jürgen Rückert, Paul Marcault, Jutta Schlosser
Engineering System International, Eschborn, Germany
David Lasry, Eberhard Haug, Jean Roger
Engineering Systems International, Rungis, France
Dominique Cesari, Francois Bermond, Robert Bouquet
INRETS LCB, Bron, France

Paper No 94 S6 W 17

ABSTRACT

In occupant safety analysis the development of validated numerical models for car crash dummies is necessary to assess accurately occupant loadings and potential injuries. In the case of side impact events, the strong coupling between the car structure deformation and the occupant kinematics motivates the use of Finite Element techniques for the modelling of the occupant.

A previous publication of the authors presented the development and validation of a model for the EUROSID-1 thorax assembly. In this paper, further progress in the development of the full dummy is reported.

INTRODUCTION

In occupant safety assessment, numerical simulations of crash events provide a valuable tool for the automotive engineer. In this field, realistic models of the occupant, or the dummy as the surrogate in the development process, are of particular interest.

Commonly, dummy models based on the dynamics of linkages of rigid bodies are used to predict the behaviour of the crash victim. These models are based on data of the victim, its environment and the crash conditions. Validated data sets for the different types can make the modelling of a crash event very efficient. A significant shortcoming of such an approach, however, is the need to provide experimental force deflection data as input for the contact models. In addition the geometry of the real dummy is met only poor, e.g. by ellipsoids. Therefore the validity of such simulations is limited to those conditions that are used in the experimental evaluation of e.g. the force deflection characteristics.

Finite Element dummy models, on the other hand, can potentially cover a much wider range of loading situations. As the level of modelling is fundamentally different, such models are based essentially on material properties and the geometry of the surrogate to be discretized.

Experimentally derived characteristics of a dummy are not required as input, but serve as a source of validation for the model. Once a model is set up and validated against tests, it should not only yield good results in a specific loading case, but in any crash situation. Moreover, such Finite Element dummy models can also be used for dummy development purposes.

The development of a suitable fully deformable model for a side impact dummy, such as the EUROSID-1, is a complex process, if the goal is to obtain a numerical model that will respond correctly for a variety of impact speeds and loading situations. Also the organization of the model itself is of importance if the model is intended to be used by somebody not familiar with it.

In this paper the status of the model and its validation is reported. Aspects of the motivation for the different modelling strategies are outlined. The work is a joint project between INRETS and ESI. The code used for the simulations is the nonlinear explicit Finite Element code PAM-CRASH.

COMPONENT MODELS

When modelling the components of the dummy, the general aim was to follow the geometry as close as possible, but keeping in mind that the full model should have a size, in terms of number of nodes, elements etc., which can be handled reasonable on a workstation. If the model shall be used in a side impact simulation with a detailed FE model of the car e.g. it should not increase the computing time drastically. Therefore use was made of computationally cheap rigid elements whenever the deformations of the part to be modelled are not important for its behaviour.

Head

The EUROSID head is the same as that of the Hybrid 3 dummy and consists of an aluminium shell covered by a vinyl skin. In the model the aluminium is represented using rigid shells which are covered by a

layer of linear elastic solid elements that represent the vinyl skin. Figure 1 shows the FE model of the head.

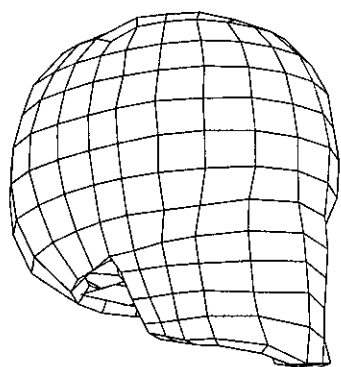

Figure 1: Head Model

The validation of the head model is based on the standard certification drop test, described in [1]. A corridor for the maximum acceleration is required, which is met by the model (see figure 2).

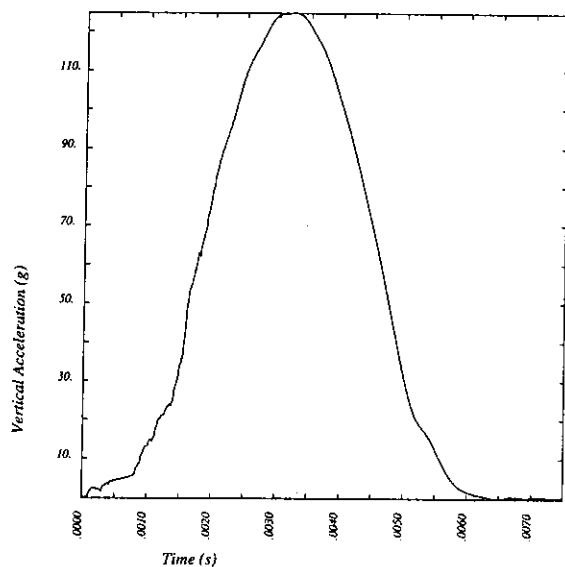

Figure 2: Head Drop Test (Acceleration at COG)

Neck

The neck consists of a central section rubber with two pivoting interfaces at top and bottom. Rubber buffers determine the rotational behaviour at the pivoting points. Figure 3 shows a cross-section view of the neck.

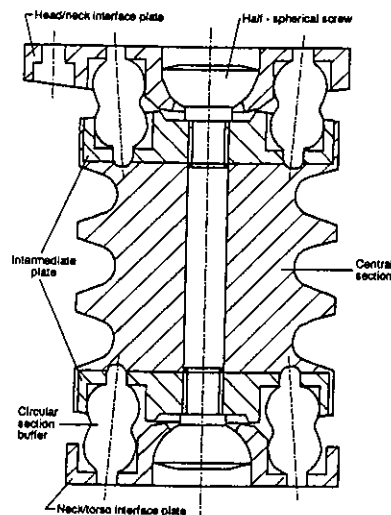

Figure 3: Cross-Section Neck

In the neck FE model the rubber is modelled with linear elastic solid elements. At the pivot point a rotational joint is located. The rubber buffers are represented using nonlinear bar elements with additional damping characteristics. (figure 4).

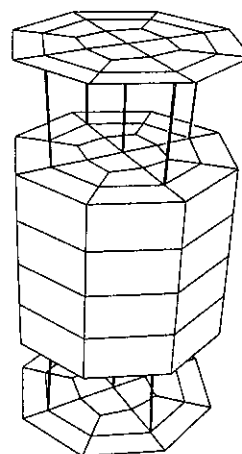

Figure 4: FE Model Neck

The certification procedure for the neck is a pendulum test with a rigid headform (see [1]). Requirements for the maximum lateral and vertical displacement, the flexion angle and the time at which these maximums occur are given. The following table compares the simulation results with the certification corridors.

	Requirement	Simulation
Lateral Disp.	87 - 107 mm	105 mm
Vertical Disp.	19 - 32 mm	22 mm
Flexion Angle	46 - 56 deg.	47 deg.
Time	50 - 62 ms	61 ms

Table 1: Neck Pendulum Test, Certification Requirements and Simulation Results

Shoulder

The EUROSID shoulder block consists of an aluminium spacer block and two plates at the top and the bottom of the spacer block. The clavicles are fixed to the block with a U-spring and can rotate against a cam. The initial position is determined with an elastic cord (see figure 5).

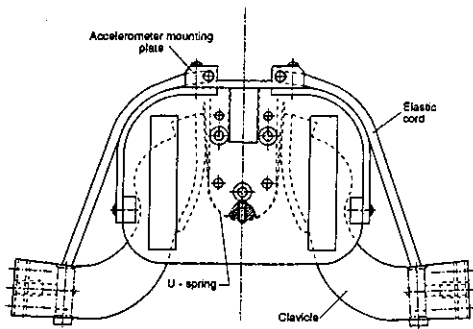

Figure 5: Cross-Section Shoulder

In the FE model of the shoulder block, spacer block, plates and clavicles are represented by rigid solid elements. By investigating the kinematics of the possible clavicle movements, a position for the center of rotation of the clavicle has been set. There a cardan joint element with adjusted spring and damping characteristics has been placed, allowing the clavicle to rotate only in the plane of the plates. It is clear that the assumption of one fixed center of rotation is not perfectly correct, and it has to be investigated whether this is sufficient. Figure 6 shows the model.

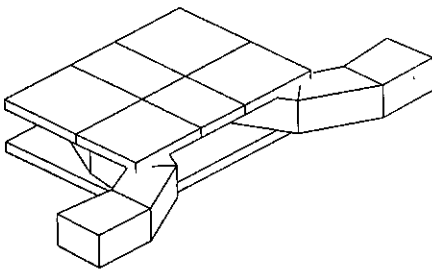

Figure 6: Shoulder Model

Arms

The arms consist of a plastic skeleton which is covered by polyurethane foam, the upper part of which is a high energy absorbing type and the lower part is a soft type. The skeleton is modelled with linear elastic shell elements and the foam with solids elements (see figure 7). There use has been made of a newly developed viscoelastic constitutive law for the foam description (Zener model [2]).

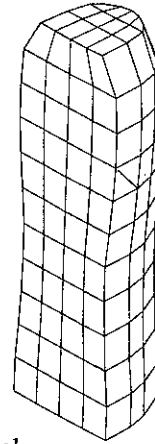

Figure 7: Arm Model

Thorax

The Thorax consists of three identical rib modules which are attached to a spine box. The rib modules themselves consist of a steel hoop covered with polyurethane foam. The 'wings' of the steel hoop are connected by a piston-cylinder assembly in parallel with a damper and a damper spring. The thorax model (figure 8) and its validation has been presented in an earlier work [3], so only some remarks are given here.

The main improvement against the earlier version is the use of a viscoelastic material for the foam. As the energy absorption of the foam is of importance for the rib behaviour, the viscous effects must be considered to let the model be valid in a broad range of loading situations and impact speeds.

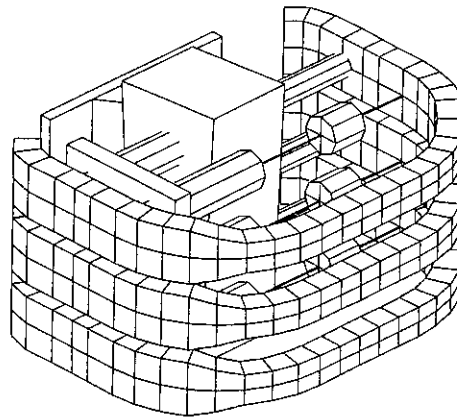

Figure 8: Thorax Model

Abdomen

The abdomen consists of a stiff central drum which is covered by a polyurethane foam. Between foam and drum, force transducers allow the measurement of abdominal impact forces. In the model the central drum is represented by rigid shell elements which are surrounded by solid elements for the foam. To allow correct interaction between lumbar spine and the drum it is modelled quite close to the real geometry. A contact definition between shells and solids allows the control of the impact force. Again the viscoelastic material type is used for the foam. A cutaway view of the model is shown in figure 9.

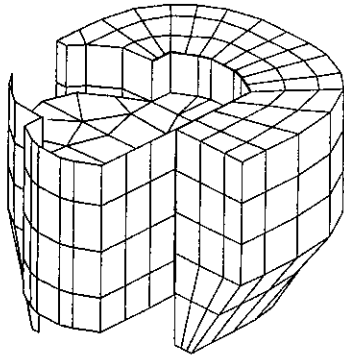

Figure 9: Abdomen Model

Lumbar Spine

The lumbar spine is comprised of a central rubber cylinder with metal plates at top and bottom. The plates are connected by a cable which allows the precompression of the cylinder. The model follows closely this setup. The rubber is represented with linear elastic solid elements and the plates by rigid shell elements. In the central hole the cable is modelled with bar elements. A contact definition between rubber and cable allows the interaction of these parts with each other. A cutaway view of the lumbar spine model is shown in figure 10.

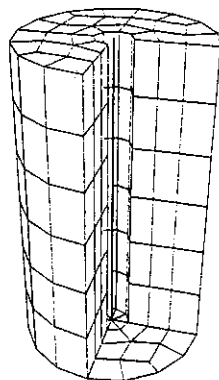

Figure 10: Lumbar Spine Model

As a means of validation of the model, the certification pendulum test from [1] is taken. The model satisfies the requirements as can be seen in Figures 11 and 12 where the lateral and vertical displacement time histories of the COG of the headform are given together with the certification corridors. It also became clear from these simulations, that the interior cable contact is important in the lumbar spine behaviour.

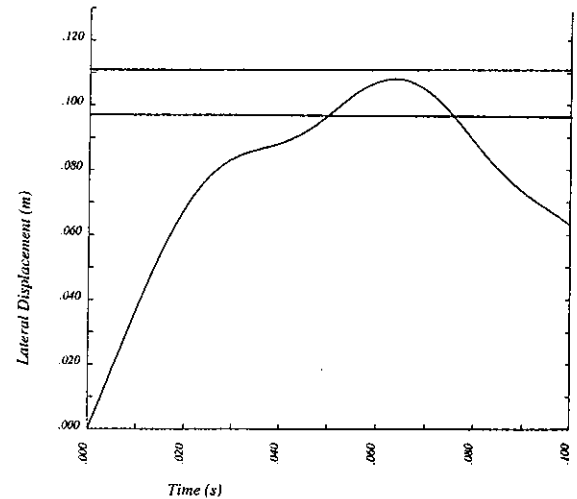

Figure 11: Lumbar Spine Pendulum Test - Lateral Displacement of COG Headform

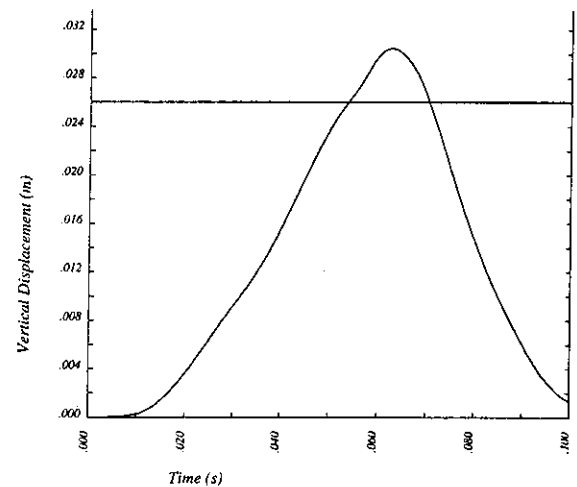

Figure 12: Lumbar Spine Pendulum Test - Vertical Displacement of COG Headform

Pelvis

The Pelvis of the EUROSID consists of a stiff sacrum block on which two plastic iliac wings are fixed at the rear by means of bolts. At the pubic symphysis the wings are linked together by a force transducer. Attached to the wings are the hip joint assemblies, which end in a metal plate onto which an open cell PU foam cylinder (H-foam Block) is connected. The whole assembly is covered by a PU foam flesh. The shape of the pelvis attempts to represent the way in which a

human sits on a car seat. Figure 13 shows a principal drawing of the pelvis.

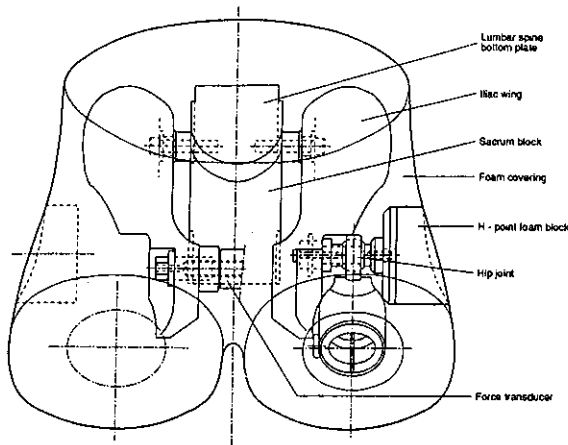

Figure 13: Pelvis - Principal Drawing

The modelling of the pelvis follows the same principles that have been used in the other components. Sacrum block and bolts are modelled with rigid brick and beam elements. The iliac wings are represented with elastic shell elements. At the hip joint locations spherical joint elements connect the iliac axes with the femur which is modelled with rigid beam elements. An elastic beam element is used for the force transducer. The foam covering is modelled with solid elements of viscoelastic material type as well as the H-foam blocks. Interior contact definitions allow the load transfer from the foam covering to the iliac wings. Figure 14 shows a cutaway view of the pelvis model.

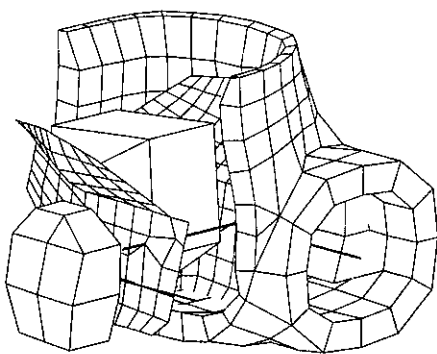

Figure 14: Pelvis Model

Legs

The legs of the EUROSID are based on the standard Hybrid II design. The leg model used here is based on the digitized outer shape of the legs. The femur is modelled with rigid shells which are covered by brick elements for the flesh. Connected to the femur is a rigid knee where the rigidly modelled lower leg is attached with a cardan joint element. In figure 15 the leg model is shown.

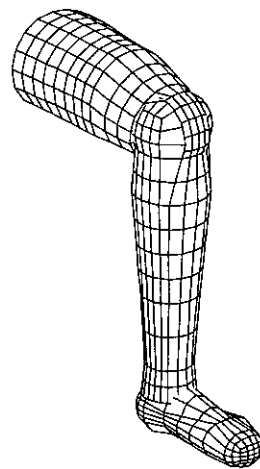

Figure 15: Leg Model

FULL DUMMY MODEL

Assembly

The previously described components have been assembled into a model of the full dummy. The connections between the components are realized both with rigid body definitions and with contact definitions between the components. Important contact definitions e.g. allow the interaction of the abdomen with the interior of the pelvis or the interaction of the lumbar spine with the abdominal drum. Also contacts between arms and thorax are defined.

For extracting the measurements that are possible with the instrumentation of the real dummy, corresponding nodes and elements are provided in the model which allow to analyse these values in detail. Figure 16 shows the full dummy model in its reference position.

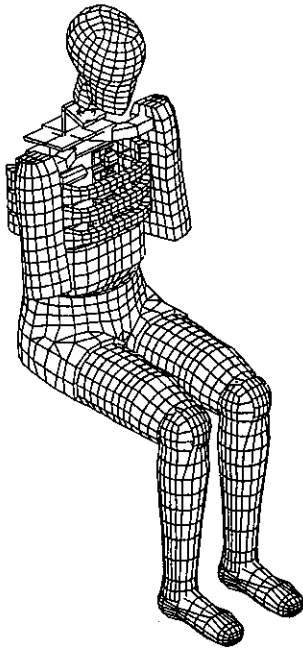

Figure 16: Full EUROSID Model

Thorax Impact Test

A first assessment of the full model performance was done with the results from an impactor test described in [4]. A linearly guided 23.3 kg impactor hits the dummy thorax at the middle rib with impact velocities of 4.3 and 6.7 m/s. The initial configuration is shown in figure 17.

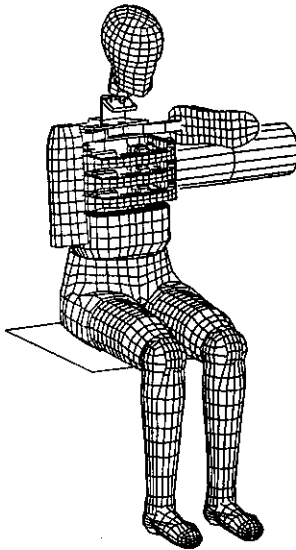

Figure 17: Thorax Impact Test - FE Model

Figures 18 to 20 show the deformed dummy at different simulation times. The impactor force time history is shown in figure 21. Peak values are in good agreement with the experiment, however the time at which the peak occurs differs a little.

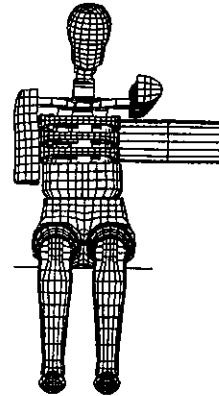

Figure 18: Thorax Impact Test, 4.3 m/s, Deformed Shape at $t=20\text{ms}$

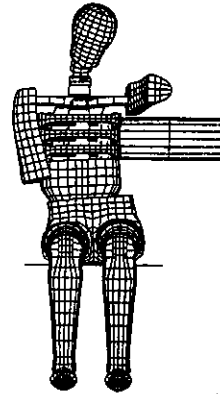

Figure 19: Thorax Impact Test, 4.3 m/s, Deformed Shape at $t=40\text{ms}$

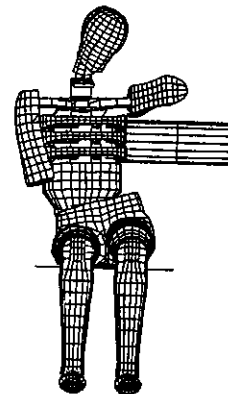

Figure 20: Thorax Impact Test, 4.3 m/s, Deformed Shape at $t=60\text{ms}$

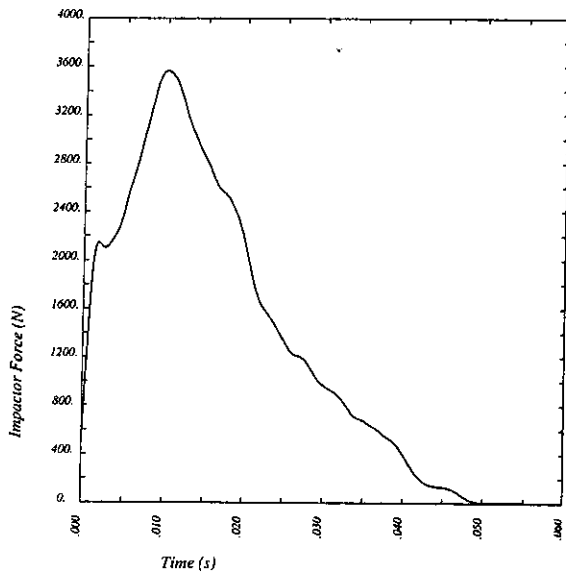

Figure 21: Thorax Impact Test, 4.3 m/s, Impactor Force

CONCLUSIONS

A fully deformable Finite Element model of the EUROSID-1 dummy has been developed and partly validated. First the single components of the dummy have been modelled and validated if this was possible by data on single component tests. The components were assembled into a full model, the functionality of which has been demonstrated on a limited number of loading cases. The work is constantly being continued to improve the performance and usefulness of the model for the use in side impact simulations.

REFERENCES

- [1] EUROSID-1 User's Manual, TNO 1990
- [2] PAM-CRASH User's Manual, ESI 1993
- [3] J. Rückert et al., A Finite Element Model of the EUROSID Thorax, 36th Stapp Conference, Seattle, November 1992
- [4] Japan Automobile Research Institute, inc. / Japan Automobile Manufacturers Association, inc. (JARI / JAMA) - Evaluation of Impact Responses of the EUROSID-1 and BIOSID, November 1991