



HAL
open science

Deep Learning for Ethoacoustics of Orcas on three years pentaphonic continuous recording at Orcalab revealing tide, moon and diel effects

Marion Poupard, Paul Best, Jan Schlüter, Jean-Marc Prévot, Helena Symonds, Paul Spong, Hervé Glotin

► To cite this version:

Marion Poupard, Paul Best, Jan Schlüter, Jean-Marc Prévot, Helena Symonds, et al.. Deep Learning for Ethoacoustics of Orcas on three years pentaphonic continuous recording at Orcalab revealing tide, moon and diel effects. OCEANS, Jun 2019, Marseille, France. hal-02445426

HAL Id: hal-02445426

<https://hal.science/hal-02445426>

Submitted on 20 Jan 2020

HAL is a multi-disciplinary open access archive for the deposit and dissemination of scientific research documents, whether they are published or not. The documents may come from teaching and research institutions in France or abroad, or from public or private research centers.

L'archive ouverte pluridisciplinaire **HAL**, est destinée au dépôt et à la diffusion de documents scientifiques de niveau recherche, publiés ou non, émanant des établissements d'enseignement et de recherche français ou étrangers, des laboratoires publics ou privés.

Deep Learning for Ethoacoustics of Orcas on three years pentaphonic continuous recording at Orcalab revealing tide, moon and diel effects

Marion Poupard ^(a,c), Paul Best ^(a), Jan Schlüter ^(a), Jean-Marc Prévot ^(a), Helena Symonds ^(b), Paul Spong ^(b)
Hervé Glotin ^(a)

(a) *Univ. Toulon, Aix Marseille Univ. CNRS, LIS, DYNI, Marseille, France*

(b) *Orcalab Alert Bay, Canada*

(c) *Biosong, France*

Email: {marion.poupard, paul.best, jan.schluter, jmp, glotin}@univ-tln.fr, {paul, helena}@orcalab.org

Abstract—One of the best ways of studying animals that produce signals in underwater environments is to use passive acoustic monitoring (PAM). Acoustic monitoring is used to study marine mammals in oceans, and gives us information for understanding cetacean life, such as their behaviour, movement or reproduction. Automated analysis for captured sound is almost essential because of the large quantity of data. A deep learning approach was chosen for this task, since it has proven great efficiency for answering such problematics. This study focused on the orcas (*Orcinus orca*) of northern Vancouver Island, Canada, in collaboration with the NGO Orcalab which developed a multi-hydrophone recording station around Hanson Island to study orcas. The acoustic station is composed of 5 hydrophones and extends over 50 km² of ocean. Since 2016 we are continuously streaming the hydrophone signals to our laboratory at Toulon, France, yielding nearly 50 TB of synchronous multichannel recordings. The objective for this research is to do a preliminary analysis of the collected data and demonstrate influence of environmental factors (tidal, moon phase and daily period) on the orcas' acoustic activities.

Index Terms—Ethoacoustics, Deep Learning, Convolutional Neural Networks, Orcas, Killer whales, Cetaceans, Bioacoustics, Environmental factors, Soundscape, Big data

I. INTRODUCTION

Orca (*Orcinus orca*) is a top-predator of the marine food chain [1]. The Northern Resident Killer Whale community is composed of several “pods” composed of matriline [2]. Several of those visit the area surrounding Hanson Island (Canada, north of Vancouver) due to the concentration of salmon [3]. For a more accurate description we suggest: The Northern Resident Killer Whale community is composed of more than 300 individuals (in 2018) organized into several pods comprised of matriline, each of which possess their own dialect (a repertoire of 7-17 discrete calls). Pods that share similar call types are classified into one of three acoustic clans.

We thank Biosong SA for the PhD funding of M. Poupard. This research is partly funded by FUI 22 Abyssound, ANR-18-CE40-0014 SMILES, ANR-17-MRS5-0023 NanoSpike and MARITTIMO EUR GIAS projects on advanced studies on cetaceans. We thank MI CNRS MASTODONS SABIOD.org and EADM MADICS CNRS scaled bioacoustic research groups, and SEAMED PACA project and CNRS platform support for J. Schlüter's Post doc grant.

There are no shared calls between clans. This odontocete can produce 3 different types of signals: clicks, whistles and pulsed calls [4]. This study focuses only on vocalizations (pulsed calls).

Some biological studies describe the communication of orcas [5]–[8], based on manual methods. Related work [9] compared dialects of orca using artificial neural networks and showed that acoustic similarities are significantly correlated with the group association patterns.

In order to analyze animal communication in different spacial and temporal contexts, automated analysis for captured sound is crucial. For that purpose, the field of bioacoustics has proposed numerous approaches using neural networks and deep learning [10]. We therefore investigated the latter methods to automatically detect orca calls emitted throughout 3 years of continuous recording from 2015 to 2017. The data collection system was built over years of fruitful collaboration between Orcalab and DYNI LIS CNRS Toulon University, that we call 'OrcalabToulon'.

II. MATERIAL

For 20 years, the NGO Orcalab developed and has maintained a unique multi-hydrophone recording station around Hanson Island (Northern Vancouver Island, Canada) to study orcas. This acoustic station is composed of 5 hydrophones and extends over 50 km² of ocean (Fig. 1).

A previous database from Orcalab called Orhive [11] was compiled from these recordings in 2013, congregating selected and segmented orca calls extracted from their context. It was the first open corpus allowing large scale analysis, but cannot be used to compute spatial long term behaviors of the orcas, or to link voicing with typical spatio-temporal events.

To help with solving this paradigm, in 2015 we have set up a continuous recording of all the hydrophones of this station. The aim is to allow observations and modelling bioacoustic activities of various species, at large spacial and temporal scales, including all details of their ecoacoustic niche, under various

geophysical and anthropophonic conditions, more particularly in order to build new knowledge about orcas.

The architecture of the global system is shown on Fig. 2. The hydrophones record the soundscape continuously. The recordings are transmitted to the OrcaLab station in real time via very high frequency (VHF) radio. Each analog signal is received by a radio receiver at Orcalab, then digitized on a Presonus analog-to-digital converter (ADC) and sent to a Linux OS portable DELL Latitude PC running continuously. The recordings are then compacted in segments of 2 minutes including all 5 channels, using lossless flac compression, with a sampling rate of 22050 Hz and resolution of 16 bits. Each segment is then sent to DYNi Toulon University big data NAS (Network Attached Storage) of 300 TB via wifi to Alert Bay, and then via the Internet. A buffer of 7 days on our local laptop in Orcalab allows to dealing with interruptions of the local or intercontinental Internet connection. The data transmission is automatically continued as soon as the connection is stabilized. The sampling rate of the ADC is chosen low enough so the system has spare bandwidth to transfer the buffer after a connection failure. In total, from July 2015 to 2017, around 50 TB of sound (about 14,500 h) was stored on our server.

III. DATA ANALYSIS

A. Automatic acoustic event extractor

We designed an automatic acoustic event extractor (inspired from [12]). The main steps of the algorithm (shown in Figure 3) are: (i) calculating the spectrogram (time frequency representation) of the recording using an STFT with a Tukey window of 1024 samples and 20% overlap; (ii) computing a binary image by comparing against the median over frequency band and time slice: if the value of a pixel is greater than 3 times the median plus 3 times the standard deviation of its row, and greater than 3 times the median plus 3 times the standard deviation of its column, it is set to 1, otherwise to 0; (iii) applying a “closing” and “dilation” filter for each pixel to remove the noise; (iv) finding connected components and removing small components and isolated pixels; (v) computing bounding boxes for remaining components.

Merging nearby boxes (with a gap of at most 0.2 s), and filtering out irregular ones (vertical boxes with a frequency range in Hz larger than 5000 times the time range in seconds, or boxes with a maximum spectral magnitude higher than 25 dB, too high to be orcas) helped us to get rid of a large amount of non-orca acoustic events. The remaining 3.5k (out of 14k) boxes were annotated as orca or noise manually.

B. Orca detector using deep learning

We built a dataset (resulting mainly from the above experiment) composed of 872 orca vocalization samples and 6801 noise samples (boats, rain, void...), which we split randomly with 20% for the test set, 60% for the training set and 20% for the validation set.¹ With that in hand, we trained a CNN [13]

¹A random split may sample train and test segments from nearby locations, giving an overly optimistic test error. We did not have enough annotated data for a chronological split avoiding this.

Table I
TEST SET PERFORMANCE OF DEEP LEARNING MODEL FOR ORCA DETECTION

	Accuracy	Area Under Curve
Training	0.97	0.88
Validation	0.96	0.89
Test	0.97	0.89

(originally designed for a bird detection task) to distinguish orca vocalizations (not clicks) from boats and background noise.

After training, when computing predictions, a threshold of 0.9 is applied to the output of the model. This reduces the risk of false positives. Table I and Figure 4 show the performance of the detector on our labeled test set, demonstrating that it produces reasonable results.

IV. RESULTS

A. Large scale statistics

Once trained, the model was run on 3 years of recordings (2015, 2016 and 2017) in 2 days of computation on an Nvidia Titan X Pascal GPU. The results in Figure 5 show the proportion of files with orca detections among all the recordings of each month, for each hydrophone. Orcas are present (acoustically) mostly during summer (June, July, August and September). This migration is confirmed by [14], orcas are abundant in Johnstone Strait between July and October, when salmon migrate into it.

Hydrophone 5 (Johnstone Strait) is the busiest location in every year. The second (smaller) peak, encompassing October-December, may additionally reflect the presence of vocal Humpback Whales [15] and/or other cetaceans in the area, that are often classified as orcas by our model.

B. Trajectory

In order to get an idea of animal trajectories, one can estimate the acoustic activity of orcas in the range of each hydrophone over time. This idea was applied for the 24th of August 2017 with several techniques. First we used the automatic acoustic event extractor (Section III-A), taking the number of detected events as a proxy for estimating the acoustic activity of orcas (Fig. 6). The trajectory from H5 to H1 can be deduced by the succeeding high detection rates of the hydrophones, but the signal is very noisy since this detector is not specific to orcas.

A second method was to use our deep learning model (Section III-B) trained for orca call detection, thus giving a much better estimate on orca activity over time and hydrophone (see Figure 7). The results confirm the primary deduction from the acoustic event detector (Fig. 6, trip from H5 to H1 at 5:30 am), but with a much cleaner signal.

C. Voicing statistics

In order to better understand the orcas’ voicing activities, we have located them in zones (Fig. 1) using the detection of voicing by hydrophone(s) (note that in the statistics, we

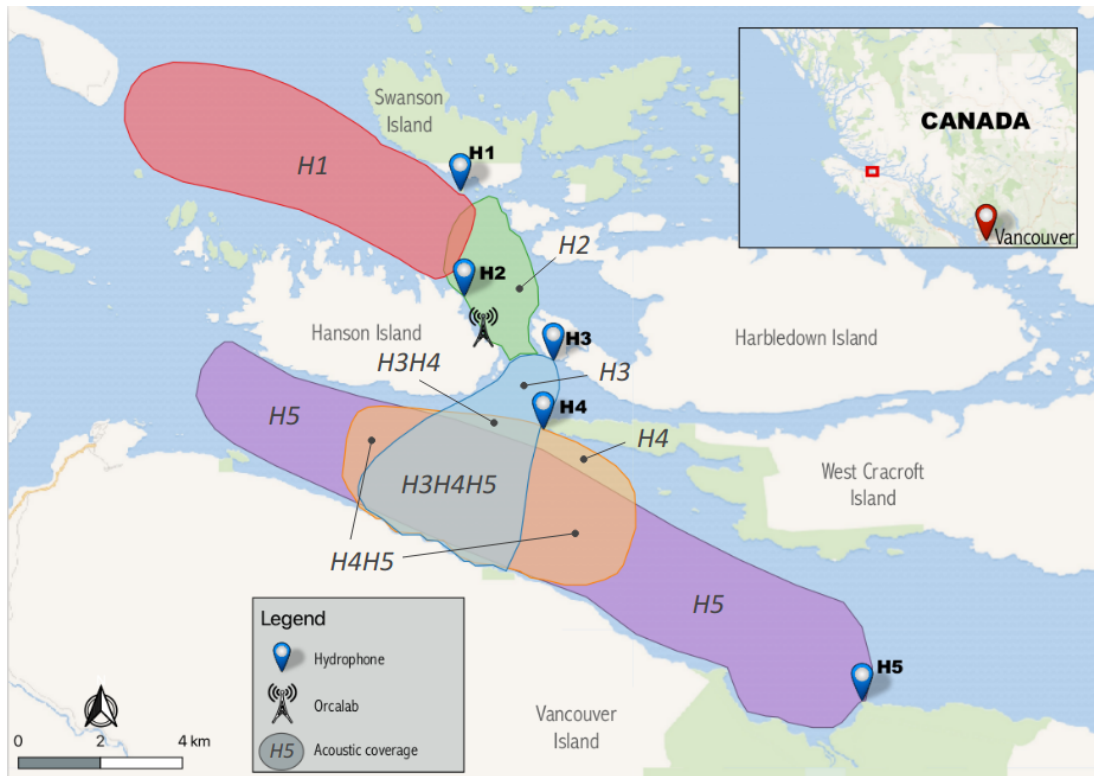

Figure 1. Map of the area and the listening range of the 5 hydrophones. Map pins with H1 to H5 in bold print denote the hydrophone locations. Detection zones indicate which hydrophones can capture orca calls in a particular area, according to experience of ten years of audio-visual observations of the orcas by the OrcalabTeam. Map generated by QGIS software (version 2.14 Essen).

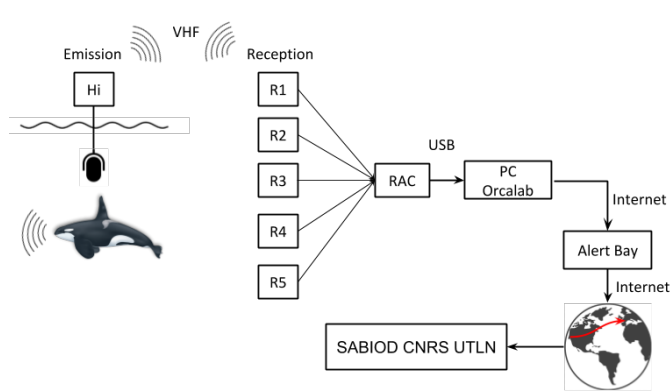

Figure 2. Representation of the data acquisition, from recording until storage on SABIOD CNRS UTLN server.

remove any intersection zone from each individual area, so that they are disjoint). The model described in III-B is used to determine if a recording contained orca calls or not. We use a simple heuristic to map each two-minute recording period to a detection zone in Fig. 1: If a period has orcas detected for a single hydrophone only, we assume they are in the zone covered by this hydrophone exclusively. If there are detections for multiple hydrophones that have overlapping ranges (e.g., H4 and H5), we assume they are in their joint

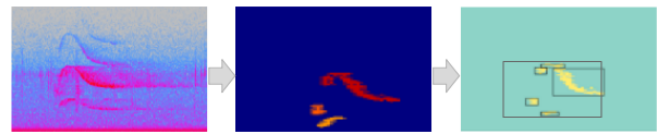

Figure 3. Main steps for the acoustic events extraction: Binarization and detection of connected components. The spectrogram shows frequencies from 0 to 6.5 kHz during 2.5 s.

detection zone. Simultaneous detections for hydrophones with non-overlapping ranges (e.g., H1 and H5) are discarded – we need a single zone to compute transitions, and this affected less than 1% of recordings. Using those zones not only gives us an idea of the common localization of the animals, but also of their most common trajectories (studying zone transition probabilities). We applied this study to the available recordings of June, July and August of 2015, 2016 and 2017, corresponding to 72109 5-channel recordings of 2 minutes (approximately 100 continuous days).

Using the zone transition probabilities, we estimated the most common travels done by the orcas. The numbers on the arrows (Fig. 8) correspond to the probability to arrive to a zone coming from another one (for instance, 52% of the times the orcas left the H3H4H5 zone, it was for the H4H5 area).

Figure 9, describing the proportion of recordings with orca

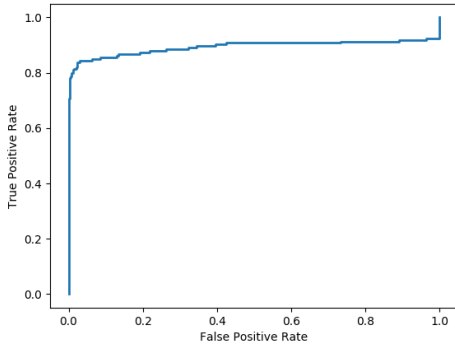

Figure 4. Receiver Operating Characteristics of the trained deep learning detector.

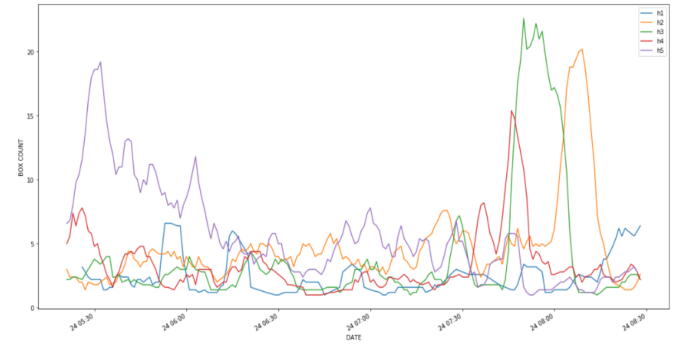

Figure 6. Evolution of the number of detected orca acoustic events from 5:30 to 8:30 am on August 24, 2017

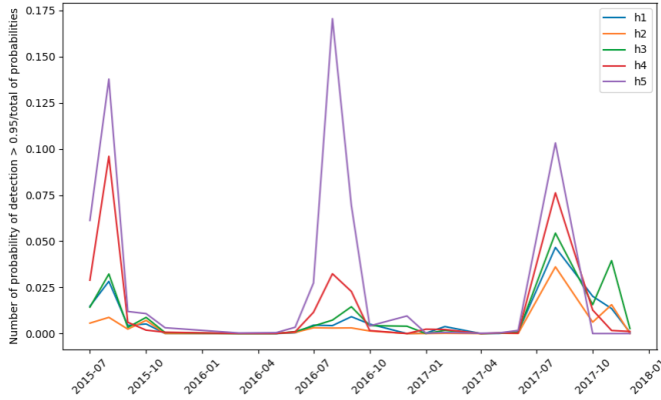

Figure 5. Proportion of two-minute recordings with detected orca calls per month and hydrophone, from 2015 to 2017.

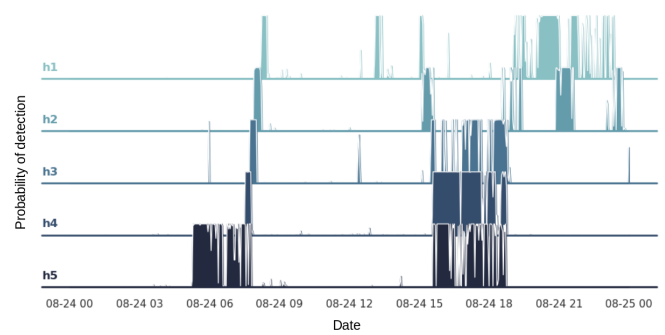

Figure 7. Example of the evolution of the probability of call detection for each hydrophone during one day (August 24, 2017). During the morning, a group of orcas comes from the east (see Figure 1) on H5, and is moving on H4, H3, H2 then on H1. Different round trips are made during the day.

calls per zone, supports the idea that zones' activation times are correlated with their sizes, except for H4. H4 is a small zone (covered only by the H4 hydrophone) through which the orcas pass in close proximity in order to travel to or from the adjacent passageway thus increasing the chances of detection.

We then analyzed the voicing activities in more detail, in space and within these time ranges:

- Day time is from 11 am to 5 pm (25% of the recordings).
- Night time is from 11 pm to 5 am (25% of the recordings).
- Full Moon time is from 4 days before to 4 days after a full moon (31% of the recordings).
- New Moon time is from 4 days before to 4 days after a new moon (24% of the recordings).
- Rising tide are times with a positive 40 cm differential of sea level (11% of the recordings).
- Falling tide are times with a negative 40 cm differential of sea level (11% of the recordings).

Those intervals were chosen to keep a significant difference for each factor (luminosity, moon phase, and currents).

We show (Fig. 10) the global evolution of voicings of orcas depending on these conditions. We see that the number of vocalizations is higher during the day, full moon and rising tide compared to night, new moon and falling tide respectively. Four times more recordings were including orca

calls during full moon (14%) compared to new moon (3%) and 8 times more during rising tides (25%) compared to falling tides (3%). In the second part of Figure 10, proportion of state changes depending on time conditions are described. It lets us get an idea of the periods of times when orcas are more active in terms of travelling.

More precisely, we computed the probabilities to detect orca calls in each zone during a given time interval, shown in Figure 11. This result shows the global patterns of the orcas' voicing activity in time and space, based on the continuous 3 years of recordings. It reveals variations in the voicing activities of up to a factor of four between conditions and zones. The biggest variation concerns the influence of tide and moon in zone H5. In fact, this area is subject to strong currents during tidal hours. The Johnstone Strait is relatively deep (450 m), so the trophic chain can change according to the moon phase [16] and influence the orca acoustic activities.

V. DISCUSSION

To the best of our knowledge, this is the first automatic large scale ethoacoustic analysis on orcas. The results are consistent with [17]–[19] that found that lunar phase is likely to be important in driving behavior of two species of cetaceans, suggesting that it is correlated with preys that migrate vertically [16]. It

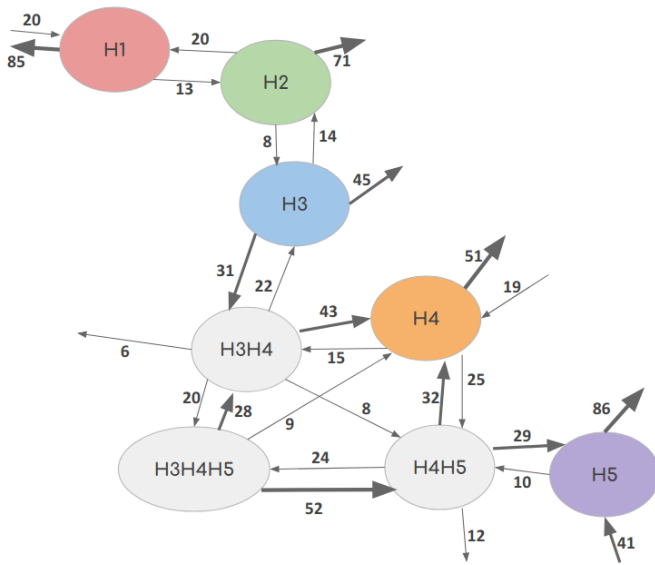

Figure 8. Directed graph of the main transition probabilities (%) between the detection zones of orca calls as defined in Fig 1. We set the transition probability $E(H_i, H_j)$ that an orca voices from the hydrophone zone H_i to zone H_j , such that the sum of $E(H_i, H_j)$ over all j different to i equals one. We only show here $E > 5\%$.

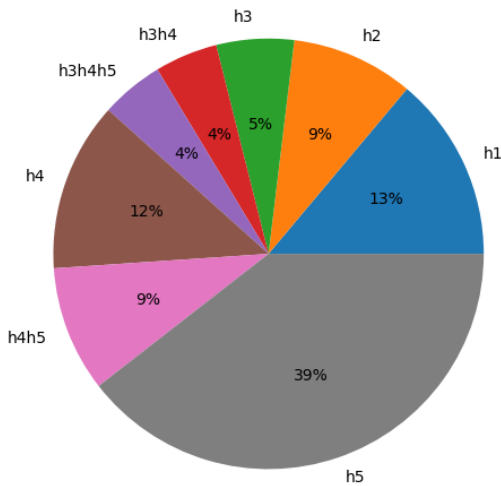

Figure 9. Proportion of recordings including orca calls per zone (%).

is assumed that during full moon, preys are more present in higher layers of water, thus making it easier for the orcas to reach them.

Tides also have an influence on presence (25% vs. 3%) and movement (40% vs. 35%) of orcas.

This result follows the conclusion of [20], [21] about the influence of the tide in a semi-enclosed environment.

Moreover, we demonstrate that acoustic activity as well as the proportion of movements changed between day and night (13% vs. 9% and 42% vs. 34%, respectively). The phenomenon was previously revealed for other odontocetes (variation of Guiana dolphin emissions according to day/night period [22]).

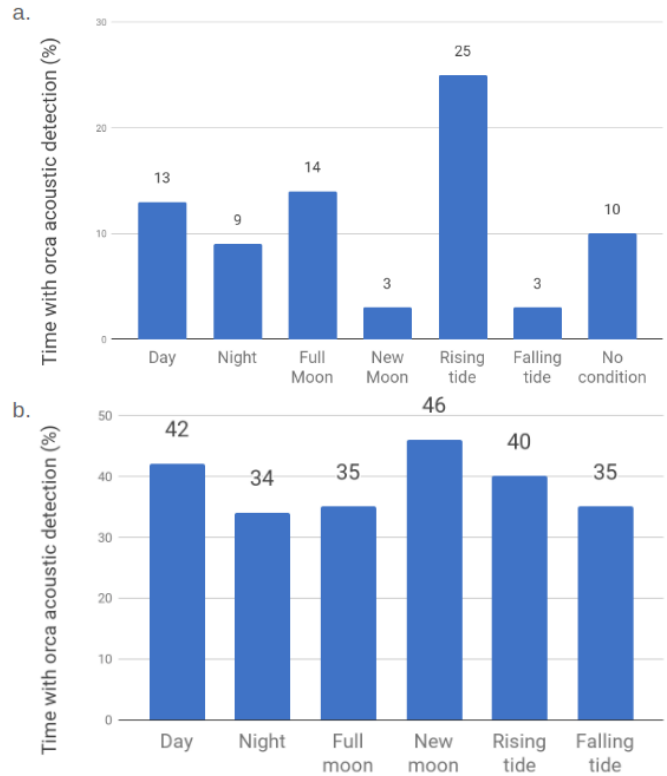

Figure 10. Global statistics of the detector. (a) Percentage of recordings with acoustic orca detections depending on time conditions. (b) Proportions of state changes, estimating the amount of movements done by the orcas.

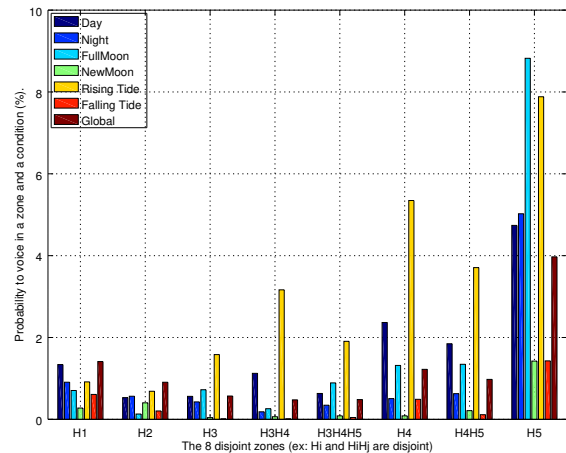

Figure 11. Probability of voicing of orca in a zone during a given condition. 'Global' refers to no specific condition. This probability is defined as the amount of recordings with orcas calls in a zone Z_i during a condition C_j , divided by the total amount of recordings in Z_i during C_j .

VI. CONCLUSION AND PERSPECTIVES

This preliminary work lays the basis for later high-level and large-scale analysis. The collected data, which is continuous over large time scales, allows us to understand more of the orcas' behaviour in relation to several factors.

A. Towards a spatio-temporal orca call and anthropophonic massive database

The previous Orchi [11] database, composed of selected segmented orca calls, has an important value to scientists working on understanding the orcas' voicing. Likewise, collecting and structuring continuous recordings could increase the scientists' materials to work on, and hopefully help elevate our knowledge of this cetacean, by correlating the voicings with other acoustic features. We show in this paper first results computed from the OrcalabToulon dataset. Current work is being done to measure potential correlations between orcas' acoustic activities and decibel levels in selected frequency bands, anthropophonic content, acoustic events or complexity of the soundscape [23].

B. Trajectory improvements

Some limited localization of the orcas is now possible by deducing from the hydrophones' activation as described in Section IV, but localization techniques presented here are quite inaccurate. We will investigate using the time difference of arrival (TDoA) between hydrophones to increase location accuracy [24], [25], and draw precise trajectories following specific pods. Large scale statistics on the orcas' travels, speed, and general presence will be computed from those improved localization techniques, helping to better understand orcas behaviour, or supporting existing hypotheses on larger scales. Indeed, the evolution of behaviour and acoustic activity on a large time scale could help us understand more about the long-term impact of human activity on orcas. In the near future, it will be possible to carry out an "ethoacoustic study" [26] and use the 48 dimensions (6 zones in 8 conditions) that can be reduced (e.g., using t-SNE [27]) in order to highlight the clusters that would be associated with the zones or time periods. A precise localization study could be set up for the orcas tracking with an antenna of 40cm of size at 2km away (to not interfere with animals) [28].

C. Call classification

We intend to extend our current detection model to a call type classifier. We will either investigate supervised methods using expert annotations (e.g., from Orcalab) and unsupervised techniques. The latter can be used to outline call characteristics of cetaceans in specific situations, for instance when changing direction or with approaching boat. We also assume that the orca voicing patterns change according to tides, moon phase, and time of the day. Our research program 'OrcalabToulon' also allows variations of orca voicing patterns during approaches and meetings of matriline in various hydrophones zones including acoustic classification of matriline.

D. Behavioural response to vessel traffic

Numerous studies [29]–[31] have focused on orcas' behavioural response to anthropogenic noise, using manually collected data in relatively small scales. They have shown that vessel traffic causes fleeing, decreased foraging time, or higher swim speed [32], thus being noxious to the animals. Moreover, "acoustic harassment devices" used by salmon farms have been shown to induce Killer Whale displacement [33]. Correlating the orcas' activity (position, speed, density of calls) with the anthropogenic noises in a larger scale could strongly support the current knowledge and might support the creation of local measures to mitigate the impact of human activity on the animals.

REFERENCES

- [1] TA. Jefferson, PJ. Stacey, and RW. Baird, "A review of killer whale interactions with other marine mammals: Predation to co-existence," *Mammal review*, vol. 21, no. 4, pp. 151–180, 1991.
- [2] MA. Bigg, PF. Olesiuk, GM. Ellis, JKB. Ford, and KC. Balcomb, "Social organization and genealogy of resident killer whales (*orcinus orca*) in the coastal waters of british columbia and washington state," *Report of the International Whaling Commission*, vol. 12, pp. 383–405, 1990.
- [3] MJ. Ford, J. Hempelmann, MB. Hanson, KL. Ayres, RW. Baird, CK. Emmons, JI. Lundin, GS. Schorr, SK. Wasser, and LK. Park, "Estimation of a killer whale (*orcinus orca*) population's diet using sequencing analysis of dna from feces," *Plos one*, vol. 11, no. 1, pp. e0144956, 2016.
- [4] JKB. Ford, "Acoustic behaviour of resident killer whales (*orcinus orca*) off vancouver island, british columbia," *Canadian Journal of Zoology*, vol. 67, no. 3, pp. 727–745, 1989.
- [5] JKB Ford et al., *A catalogue of underwater calls produced by killer whales (*Orcinus orca*) in British Columbia*, Department of Fisheries and Oceans, Fisheries Research Branch, Pacific ..., 1987.
- [6] RB. Tyson, DP. Nowacek, and PJO. Miller, "Nonlinear phenomena in the vocalizations of north atlantic right whales (*eubalaena glacialis*) and killer whales (*orcinus orca*)," *The Journal of the Acoustical Society of America*, vol. 122, no. 3, pp. 1365–1373, 2007.
- [7] BM. Weiß, H. Symonds, P. Spong, and F. Ladich, "Intra- and intergroup vocal behavior in resident killer whales, *orcinus orca*," *The Journal of the Acoustical Society of America*, vol. 122, no. 6, pp. 3710–3716, 2007.
- [8] O. Filatova, VB. Deecke, John KB. Ford, CO. Matkin, LG. Barrett-Lennard, MA. Guzev, AM. Burdin, and E. Hoyt, "Call diversity in the north pacific killer whale populations: implications for dialect evolution and population history," *Animal Behaviour*, vol. 83, no. 3, pp. 595–603, 2012.
- [9] VB. Deecke, JKB. Ford, and P. Spong, "Quantifying complex patterns of bioacoustic variation: Use of a neural network to compare killer whale (*orcinus orca*) dialects," *The Journal of the Acoustical Society of America*, vol. 105, no. 4, pp. 2499–2507, 1999.
- [10] H. Glotin, Y. LeCun, S. Artières T. Mallat, O. Tchernichovski, and X. Halkias, "Proc. nips4b : Neural information processing scaled for bioacoustics, from neurons to big data, joint to int. conference on neural information processing systems (nips)," 2013, <http://sabiord.org/nips4b>.
- [11] Steven Ness, *The Orchi: A system for semi-automatic annotation and analysis of a large collection of bioacoustic recordings*, Ph.D. thesis, University of Victoria, Canada, 2013.
- [12] M. Poupard, M. Ferrari, J. Schluter, P. Astruch, B. Schohn, B. Rouanet, A. Goujard, A. Lyonnet, P. Giraudet, V. Barchasz, V. Gies, P. Best, D. Dominici, T. Lengagne, T. Soriano, and H. Glotin, "Passive acoustics to monitor flagship species near boat traffic in the unesco world heritage natural reserve of scandola," in *Input Academy :International Conference on Innovation in Urban and regional planning*, April 2019.
- [13] T. Grill and J. Schlüter, "Two convolutional neural networks for bird detection in audio signals," in *2017 25th European Signal Processing Conference (EUSIPCO)*. IEEE, 2017, pp. 1764–1768.

- [14] LM. Nichol and DM. Shackleton, "Seasonal movements and foraging behaviour of northern resident killer whales (*Orcinus orca*) in relation to the inshore distribution of salmon (*Oncorhynchus* spp.) in British Columbia," *Canadian Journal of Zoology*, vol. 74, no. 6, pp. 983–991, 1996.
- [15] JD Darlings, J Calambokidis, KC Balcomb, P Bloedel, K Flynn, A Mochizuki, K Mori, F Sato, H Suganuma, and M Yamaguchi, "Movement of a humpback whale (*Megaptera novaeangliae*) from Japan to British Columbia and return," *Marine Mammal Science*, vol. 12, no. 2, pp. 281–287, 1996.
- [16] BB. Roper and DL. Scarnecchia, "Emigration of age-0 chinook salmon (*Oncorhynchus tshawytscha*) smolts from the upper south Umpqua river basin, Oregon, USA," *Canadian Journal of Fisheries and Aquatic Sciences*, vol. 56, no. 6, pp. 939–946, 1999.
- [17] KJ. Benoit-Bird, AD. Dahood, and B Würsig, "Using active acoustics to compare lunar effects on predator-prey behavior in two marine mammal species," *Marine Ecology Progress Series*, vol. 395, pp. 119–135, 2009.
- [18] H. Glotin, N. Enfon, R. Balestrio, A. Mishchenko, JM. Prévot, J. Razik, S. Paris, and J. Patris, "Moon phase and low frequency noises effects on physeter and other cetaceans monitored by neutrino observatory in Toulon (in French)," *Int. Pelagos Cetacean Sanctuary Edition, French Ministry of Environment, research program 13-040, sabiod.org*, 2013.
- [19] AE. Simonis, M. Roch, B. Bailey, J. Barlow, RES. Clemesha, S. Iacobellis, JA. Hildebrand, and S. Baumann-Pickering, "Lunar cycles affect common dolphin *Delphinus delphis* foraging in the southern California Bight," *Marine Ecology Progress Series*, vol. 577, pp. 221–235, 2017.
- [20] TH. Lin, T. Akamatsu, and LS. Chou, "Tidal influences on the habitat use of Indo-Pacific humpback dolphins in an estuary," *Marine Biology*, vol. 160, no. 6, pp. 1353–1363, 2013.
- [21] MN. de Boer, MP. Simmonds, P. Reijnders, and G. Aarts, "The influence of topographic and dynamic cyclic variables on the distribution of small cetaceans in a shallow coastal system," *PLoS One*, vol. 9, no. 1, pp. e86331, 2014.
- [22] LS. Deconto and E. Monteiro-Filho, "Day and night sounds of the Guiana dolphin, *Sotalia guianensis* (Cetacea: Delphinidae) in southeastern Brazil," *Acta Ethologica*, vol. 19, no. 1, pp. 61–68, 2016.
- [23] Jérôme Sueur, Almo Farina, Amandine Gasc, Nadia Pieretti, and Sandrine Pavoine, "Acoustic indices for biodiversity assessment and landscape investigation," *Acta Acustica united with Acustica*, vol. 100, no. 4, pp. 772–781, 2014.
- [24] Pascale Giraudet and Hervé Glotin, "Real-time 3D tracking of whales by echo-robust precise TDOA estimates with a widely-spaced hydrophone array," *Applied Acoustics*, vol. 67, no. 11–12, pp. 1106–1117, 2006.
- [25] Hervé Glotin, Frédéric Caudal, and Pascale Giraudet, "Whale cocktail party: real-time multiple tracking and signal analyses," *Canadian Acoustics*, vol. 36, no. 1, pp. 139–145, 2008.
- [26] M. Poupard, B. De Montgolfier, and H. Glotin, "Ethoacoustic by Bayesian non-parametric and stochastic neighbor embedding to forecast anthropic pressure on dolphins," in *IEEE/OCEANS*, June 2019.
- [27] Laurens van der Maaten and Geoffrey Hinton, "Visualizing data using t-SNE," *JMLR*, vol. 9, pp. 2579–2605, 2008.
- [28] M. Poupard, M. Ferrari, J. Schluter, R. Marxer, P. Giraudet, V. Giès, V. Barchasz, G. Pavan, and H. Glotin, "Real-time passive acoustic 3D tracking of deep diving cetacean by small non-uniform mobile surface antenna," in *Accepted to ICASSP*, 2019.
- [29] R. Williams, AW. Trites, and DE. Bain, "Behavioural responses of killer whales (*Orcinus orca*) to whale-watching boats: opportunistic observations and experimental approaches," *Journal of Zoology*, vol. 256, no. 2, pp. 255–270, 2002.
- [30] D. Lusseau, DE. Bain, R. Williams, and JC. Smith, "Vessel traffic disrupts the foraging behavior of southern resident killer whales *Orcinus orca*," *Endangered Species Research*, vol. 6, no. 3, pp. 211–221, 2009.
- [31] D. Briggs, *Impact of human activities on killer whales at the rubbing beaches in the Robson Bight Ecological Reserve and adjacent waters during the summers of 1987 and 1989*, Ministry of Parks, 1991.
- [32] S. Kruse, "The interactions between killer whales and boats in Johnstone Strait, BC," *Dolphin societies: Discoveries and puzzles*, pp. 149–159, 1991.
- [33] AB. Morton and H. Symonds, "Displacement of *Orcinus orca* (L.) by high amplitude sound in British Columbia, Canada," *ICES Journal of Marine Science*, vol. 59, no. 1, pp. 71–80, 2002.