



HAL
open science

Imaging Native Calcium Currents in Brain Slices

Karima Ait Ouares, Nadia Jaafari, Nicola Kuczewski, Marco Canepari

► **To cite this version:**

Karima Ait Ouares, Nadia Jaafari, Nicola Kuczewski, Marco Canepari. Imaging Native Calcium Currents in Brain Slices. *Calcium Signaling*, pp.73-91, 2020, *Advances in Experimental Medicine and Biology*, 10.1007/978-3-030-12457-1_4 . hal-02441768

HAL Id: hal-02441768

<https://hal.science/hal-02441768>

Submitted on 16 Jan 2020

HAL is a multi-disciplinary open access archive for the deposit and dissemination of scientific research documents, whether they are published or not. The documents may come from teaching and research institutions in France or abroad, or from public or private research centers.

L'archive ouverte pluridisciplinaire **HAL**, est destinée au dépôt et à la diffusion de documents scientifiques de niveau recherche, publiés ou non, émanant des établissements d'enseignement et de recherche français ou étrangers, des laboratoires publics ou privés.

1 *Adv Exp Med Biol*, in press

2

3

4

Imaging Native Calcium Currents in Brain Slices

5

6 **Karima Ait Ouares^{a,b}, Nadia Jaafari^{a,b}, Nicola Kuczewski^c and Marco Canepari^{a,b,d}**

7

8 ^a Univ. Grenoble Alpes, CNRS, LIPhy, F-38000 Grenoble, France

9 ^b Laboratories of Excellence, Ion Channel Science and Therapeutics, France.

10 ^c Centre de Recherche en Neurosciences de Lyon, INSERM U1028/CNRS UMR5292, Université
11 Lyon1, Lyon, France

12 ^d Institut National de la Santé et Recherche Médicale (INSERM), France.

13

Address of the submitting and corresponding author

14 Marco Canepari, Laboratoire Interdisciplinaire de Physique (UMR 5588), Bat. E45, 140 avenue de la
15 physique, Domaine univ., 38402 St Martin d'Hères cedex, France. Email: marco.canepari@univ-
16 grenoble-alpes.fr
17

18

19

20 *Short Title:* Imaging Native Calcium Currents

21

22

23

24

25

26

27

28

29

30

31

32

33

34

35

36

37 **Abstract**

38 Imaging techniques may overcome the limitations of electrode techniques to measure locally not only
39 membrane potential changes, but also ionic currents. Here, we review a recently developed approach
40 to image native neuronal Ca^{2+} currents from brain slices. The technique is based on combined
41 fluorescence recordings using low-affinity Ca^{2+} indicators possibly in combination with voltage
42 sensitive dyes. We illustrate how the kinetics of a Ca^{2+} current can be estimated from the Ca^{2+}
43 fluorescence change and locally correlated with the change of membrane potential, calibrated on an
44 absolute scale, from the voltage fluorescence change. We show some representative measurements
45 from the dendrites of CA1 hippocampal pyramidal neurons, from olfactory bulb mitral cells and from
46 cerebellar Purkinje neurons. We discuss the striking difference in data analysis and interpretation
47 between Ca^{2+} current measurements obtained using classical electrode techniques and the
48 physiological currents obtained using this novel approach. Finally, we show how important is the
49 kinetic information on the native Ca^{2+} current to explore the potential molecular targets of the Ca^{2+} flux
50 from each individual Ca^{2+} channel.

51

52 *Keywords:*

53 Calcium currents

54 Calcium imaging

55 Voltage sensitive dyes imaging

56 CA1 hippocampal pyramidal neuron

57 Olfactory bulb mitral cell

58 Purkinje neuron

59 Brain slices

60 Action potential

61 Synaptic potential

62 Biophysical modeling

63

64

65

66

67

68

69

70

71

72

73

74

75

76

77 1. Introduction

78

79 Optical measurements have been historically designed to monitor the electrical activity of the
80 nervous system, a task where the use of electrode techniques has clear limitations (1). In the last two
81 decades, the development of new organic voltage sensitive dyes (VSD), in parallel with the progress
82 of devices to excite and detect fluorescence (2), allowed optical recordings of sub-cellular membrane
83 potential (V_m) changes < 1 mV with a signal-to-noise ratio (S/N) comparable to that of patch clamp
84 recordings (3). This achievement suggested that voltage imaging can be used to investigate voltage-
85 dependent proteins, in particular voltage-gated ion channels, in their physiological environment. The
86 principal function of an ion channel is to allow an ion flux through a membrane, i.e. to produce an ionic
87 current. Thus, the study of the biophysics of ion channels is routinely performed by measurements of
88 ionic currents in single-electrode or two-electrode voltage clamp (4). A way to investigate the
89 biophysics of isolated native ion channels is to perform excised patches from *ex-vivo* membranes (5).
90 Alternatively, ion channels can be expressed in foreign cells such as oocytes or mammalian cell lines
91 (6) and studied by using patch clamp techniques (7). Yet, the physiological role and function of
92 voltage-gated ion channels must be investigated in their natural environment, i.e. in their native
93 cellular compartment and during physiological changes of V_m . To this purpose, the voltage clamp
94 electrode approach has serious limitations for several reasons. First, the ionic current is measured by
95 maintaining the cell at a given artificial V_m and even if the cell is dynamically clamped the V_m change
96 is never a physiological signal (8). Second, the current measured with the electrode is the summation
97 of the filtered currents from all different cellular regions, including remote regions where V_m is
98 unclamped, and no information is available on the site of origin of the current (9). Third, different ionic
99 currents contribute to the physiological change of V_m producing a functional coupling among the
100 different ion channels (10). Thus, a single native ionic current must be pharmacologically isolated
101 from the total current mediated by the other channels, but the block of these channels will make the
102 V_m change non-physiological.

103 In the last few years, we designed a novel approach to measure physiological Ca^{2+} currents from
104 neurons in brain slices (11). The method is based on fast Ca^{2+} optical measurements using low-
105 affinity indicators that can be combined with sequential (12) or simultaneous (13) V_m optical
106 recordings. The latter measurements can be calibrated in mV (14) using cell-specific protocols.
107 Individual cells are loaded with Ca^{2+} and V_m indicators using a patch clamp recording. In contrast to
108 voltage-clamp current measurements, the current approach permits independent recordings of the V_m
109 change and of the Ca^{2+} influx, i.e. the study of voltage gating during physiological V_m changes. Since
110 the Ca^{2+} current is reconstructed by the measurement of Ca^{2+} locally binding to an indicator, this
111 approach provides information on channels in different areas of the cell with a spatial resolution as
112 good as the optical recording allows. Finally, the Ca^{2+} current is recorded without blocking all Na^+ and
113 K^+ channels that are necessary to produce the physiological V_m change. The principle of obtaining an
114 optical measurement of a fast Ca^{2+} current is based on the analysis of the dye- Ca^{2+} binding reaction
115 in a cell, a scenario initially studied by Kao and Tsien (15). According to their theoretical estimates

116 and to our recent empirical measurements (16), the relaxation time of the dye-Ca²⁺ binding reaction is
117 less than 200 μs for low-affinity indicators with equilibrium constant (K_D) ≥ 10 μM such as Oregon
118 Green BAPTA-5N (OG5N, K_D = 35 μM, 17) or Fura-FF (K_D = 10 μM, 18). Therefore, a fast Ca²⁺
119 current with duration of a few milliseconds can be reliably tracked by low-affinity indicators if
120 fluorescence is acquired at sufficiently high speed. The goal of this methodological article is to provide
121 an exhaustive tool for those scientists aiming at performing this type of measurement. The next
122 section addresses in detail the problem of extracting the Ca²⁺ current kinetics from Ca²⁺ fluorescence
123 measurements under different cellular buffering conditions. The following section is devoted to the
124 technical aspects of how to set up combined V_m and Ca²⁺ optical measurements and to calibrate V_m
125 signals on an absolute scale. We then illustrate some examples of combined V_m and Ca²⁺ current
126 measurements and we finally discuss how to correctly interpret the results and how to use this
127 information to significantly advance our knowledge on Ca²⁺ channels function. All data shown here
128 were from experiments performed at the Laboratoire Interdisciplinaire de Physique and approved by
129 the Isere prefecture (Authorisation n. 38 12 01). These experiments were performed at 32-34°C using
130 brain slices from 21-40 postnatal days old C57Bl6 mice of both genders.

131

132

133 **2. Extracting Ca²⁺ current kinetics from Ca²⁺ fluorescence measurements**

134

135 **2.1 Biophysical foundations of Ca²⁺ currents imaging**

136 An optical measurement of a Ca²⁺ signal is ultimately a measurement of the Ca²⁺ indicator bound
137 to Ca²⁺ ions, which is proportional to the Ca²⁺ fractional change of fluorescence ($\Delta F/F_0$) if the indicator
138 is not saturated. If the kinetics of the Ca²⁺-binding reaction of the indicator is slower than the kinetics
139 of the Ca²⁺ source, and imaging is performed at higher rate, the time-course of Ca²⁺ $\Delta F/F_0$ essentially
140 tracks the kinetics of the chemical reaction. Alternatively, if the kinetics of the Ca²⁺-binding reaction is
141 faster than the kinetics of the Ca²⁺ source, the Ca²⁺ $\Delta F/F_0$ signal tracks the kinetics of the Ca²⁺
142 source. It follows that the equilibration (or relaxation) time of the Ca²⁺-indicator binding reaction is a
143 crucial variable to use the technique to investigate the biophysics and the physiology of the Ca²⁺
144 source. The relaxation of the Ca²⁺- binding reactions for early indicators was studied by Kao and
145 Tsien (15) who established that the rate of association for all these molecules is limited by diffusion
146 leading to an association constant of $\sim 6 \cdot 10^8 \text{ M}^{-1} \text{ s}^{-1}$. Thus, both the equilibrium constant (K_D) and the
147 equilibrium time are determined by the dissociation constant, i.e. the lower is the affinity of the
148 indicator the shorter is its equilibrium time. We have empirically demonstrated that indicators with K_D ≥
149 10 μM such as OG5N or FuraFF have relaxation time < 200 μs (16). Since the kinetics of activation
150 and deactivation of voltage-gated Ca²⁺ channels (VGCCs) during physiological changes of V_m (for
151 instance action potentials), is governed by the kinetics of the V_m transient, it follows that the relaxation
152 time for those indicators is shorter than the duration of the Ca²⁺ influx. Hence, since Ca²⁺ binds to the
153 indicator linearly in time, the Ca²⁺ $\Delta F/F_0$ is proportional to the integral of the Ca²⁺ influx, i.e. to the

154 integral of the Ca^{2+} current. In the cell, however, Ca^{2+} simultaneously binds to proteins that form the
155 endogenous buffer and this binding is competing with the binding to the indicator. An endogenous
156 buffer can be, in principle, at least as fast as the indicator in equilibrating. In this case, only a fraction
157 of Ca^{2+} is bound to the indicator, but this fraction is proportional to the total Ca^{2+} entering the cell and
158 therefore to the integral of the Ca^{2+} current. Alternatively, an endogenous buffer can equilibrate over a
159 time scale that is longer than the duration of the Ca^{2+} current. In this case, Ca^{2+} first binds to the dye
160 and later to the endogenous buffer, implying that part of Ca^{2+} moves from the indicator to the
161 endogenous buffer during its relaxation time. Under this condition, the Ca^{2+} $\Delta F/F_0$ is not linear with the
162 integral of the Ca^{2+} current over this time scale. To clarify this important concept we make use of two
163 simple computer simulations shown in Fig. 1, produced by a model that takes into account the
164 chemical reactions as well as an extrusion mechanism re-establishing the initial Ca^{2+} conditions over
165 a time scale >100 ms. We analyse what hypothetically can happen if a Ca^{2+} current with Gaussian
166 shape occurs in a cell filled with 2 mM OG5N. In the first simulation (Fig. 1a), the cell has only 1 mM
167 of a fast endogenous buffer behaving with the same association constant of the indicator and $K_D = 10$
168 μM . In the second simulation (Fig. 1b), the cell has additional 400 μM of a slower endogenous buffer
169 with association rate ~ 3 times slower than that of the indicator and $K_D = 0.2$ μM . In the first case, the
170 time derivative of the Ca^{2+} $\Delta F/F_0$ signal matches the kinetics of the Ca^{2+} current (Fig. 1a). In contrast,
171 in the presence of the slower buffer, the time derivative of the Ca^{2+} $\Delta F/F_0$ signal has a negative
172 component and does not match the kinetics of the Ca^{2+} current (Fig. 1b). In the next two paragraphs,
173 we present the analysis strategies that can be applied to extract the kinetics of Ca^{2+} currents from
174 Ca^{2+} imaging recordings.

175

176 **2.2 The case of linearity between Ca^{2+} influx and Ca^{2+} fluorescence changes**

177 The proteins expressed in a cell determine whether or not the time course of the Ca^{2+} $\Delta F/F_0$ signal
178 is linear with the kinetics of the Ca^{2+} current. As previously demonstrated (11), in the case of linear
179 behaviour, the Ca^{2+} $\Delta F/F_0$ signal must reach its peak and remain constant for a few milliseconds
180 afterwards, i.e. for the entire duration of the current. As shown in the simulation of Fig. 1a, the kinetics
181 of Ca^{2+} extrusion producing a slow decrease of the Ca^{2+} $\Delta F/F_0$ signal has negligible effect on the time
182 derivative. Thus, the estimate of the Ca^{2+} current kinetics is reliably obtained by the calculation of the
183 time derivative of the Ca^{2+} $\Delta F/F_0$ signal. This calculation, however, requires the signal noise to be
184 smaller than the signal change between two consecutive samples. The classical way to achieve this
185 necessary condition is to apply to the Ca^{2+} $\Delta F/F_0$ signal a “smoothing algorithm”, i.e. a temporal filter
186 that reduces the noise of the signal with minimal distortion of its kinetics. At 20 kHz acquisition rate,
187 we have found that the Savitzky-Golay algorithm (19) is an optimal filtering tool permitting noise
188 reduction of the signal without significant temporal distortion using time-windows of up to 20-30
189 samples (11). The applicability of this strategy has however limitations, i.e. if the signal or the region
190 of measurement are too small, or if the light is too dim, the smoothing of the signal might not be
191 sufficient to reduce the noise down to the level permitting calculation of the time derivative. In this

192 case, the alternative strategy to apply consists in fitting the raw or the filtered $\text{Ca}^{2+} \Delta\text{F}/\text{F}_0$ signal with a
193 model function obtaining a noiseless curve that mimics the time course of the $\text{Ca}^{2+} \Delta\text{F}/\text{F}_0$ signal. A
194 simple choice of function that resembles the time course of the $\text{Ca}^{2+} \Delta\text{F}/\text{F}_0$ transient is the sigmoid. In
195 particular, we found that the product of three sigmoid functions always provides an excellent fit of the
196 $\text{Ca}^{2+} \Delta\text{F}/\text{F}_0$ signal associated with a backpropagating action potential in CA1 hippocampal pyramidal
197 neurons (16). As shown in the example of Fig. 2a both strategies are faithful in correctly calculating
198 the time derivative of the $\Delta\text{F}/\text{F}_0$ signal. In this example, a CA1 hippocampal pyramidal neuron was
199 filled with 2 mM OG5N and the dendritic $\text{Ca}^{2+} \Delta\text{F}/\text{F}_0$ signal associated with a backpropagating action
200 potential was recorded at 20 kHz and averaged over 16 trials. This high sampling frequency was
201 necessary to avoid signal aliasing and therefore distortion of the kinetics of the current. The filtering
202 strategy is the straightforward approach that enables the calculation of the time derivative, but it
203 produces a curve with noise. The noise can be reduced (if possible) by increasing the number of trials
204 to average or by enlarging the dendritic area from where fluorescence is averaged. The fitting strategy
205 is less direct but it produces a noiseless curve and it is therefore the only possible approach when the
206 noise of the $\text{Ca}^{2+} \Delta\text{F}/\text{F}_0$ signal is above a certain level, as quantitatively estimated in an original report
207 (16). In particular, this is the case when the current must be extracted from single trials or when the
208 recording is obtained from small or relatively dim regions.

209

210 **2.3 The case of nonlinearity between Ca^{2+} influx and Ca^{2+} fluorescence changes**

211 The method of estimating the kinetics of a Ca^{2+} current by calculating the $\text{Ca}^{2+} \Delta\text{F}/\text{F}_0$ time
212 derivative fails when Ca^{2+} unbinds from the indicator over a time scale that is longer than the current
213 duration, but sufficiently short to distort the estimate of Ca^{2+} influx dynamics by fluorescence
214 measurement. In other words, this method fails when the $\text{Ca}^{2+} \Delta\text{F}/\text{F}_0$ signal decays rapidly, after
215 correction for bleaching, generating a negative component in its time derivative. Such a situation
216 occurs, for example, where slow buffering is produced by Calbindin-D28k (20,21) and Parvalbumin
217 (22,23). As shown in the example of Fig. 2b, the $\text{Ca}^{2+} \Delta\text{F}/\text{F}_0$ signal associated with a climbing fibre
218 excitatory postsynaptic potential (EPSP), recorded at 5 kHz from a dendritic region and averaged over
219 four trials, decays rapidly after its maximum resulting in a negative component of its time derivative.
220 The distortion from the linear behaviour produced by the slow buffers can be compensated by taking
221 into account the kinetics of Ca^{2+} unbinding from the indicator. We have recently developed a
222 successful method to achieve this goal (24). The strategy is based on fitting the decay time of the
223 $\text{Ca}^{2+} \Delta\text{F}/\text{F}_0$ signal with the result of a computer simulation of a model with a slow buffer. Initially the
224 input current is the Gaussian function fitting the rising phase of the time derivative (that is still a good
225 approximation of the initial part of the current). The kinetic parameters and the concentration of the
226 slow buffer are set to obtain the best fit of the decay phase of the $\text{Ca}^{2+} \Delta\text{F}/\text{F}_0$ signal. Then, the kinetics
227 of the Ca^{2+} current is obtained as summation of four Gaussian functions that maximise the match
228 between the result of the computer simulation and the experimental $\text{Ca}^{2+} \Delta\text{F}/\text{F}_0$ signal. Although this
229 new method provides only an indirect approximation of the kinetics of the Ca^{2+} current, this

230 information is crucial at understanding the activation and deactivation of different types of VGCCs. In
231 the dendrites of PNs, for instance, different Ca^{2+} current kinetics components are associated with the
232 activation of P/Q-type VGCCs (25) and T-type Ca^{2+} channels (26) that can be in principle separated
233 by pharmacological block of one component. Thus, the extrapolation of a curve that approaches the
234 kinetics of the Ca^{2+} current can be used to quantitatively investigate the variability of channels
235 activation at different dendritic sites, the modulation of channel activation due to physiological activity
236 or to pharmacological action. Finally, it is important to say that such a strategy can be extended to
237 estimate slower Ca^{2+} currents where the fitting procedure can be applied to the slower decay time due
238 to Ca^{2+} extrusion (27).

239

240

241 **3. Combining membrane potential and Ca^{2+} Imaging**

242

243 **3.1 Setting up combined voltage and Ca^{2+} fluorescence measurements**

244 To combine V_m and Ca^{2+} optical measurements, the VSD and the Ca^{2+} indicator must have
245 minimal overlap in the emission spectra. Water soluble voltage indicators with different excitation and
246 emission spectra have been recently developed (28). In particular, the red-excitable and IR emitting
247 VSD ANBDQPTEA (or PY3283) is suitable for coupling with other optical techniques (29).
248 Nevertheless, the most used VSDs for single cell applications are still JPW3028 (30) and the
249 commercially available JPW1114 (18). These indicators have wide excitation spectrum in the
250 blue/green region and they emit mainly in the red region. We have previously demonstrated that both
251 indicators can be optimally combined with Fura indicators that are excited in the UV region and emit in
252 the short green region (12). In this case, VSDs were excited at 543 nm using a laser and Fura
253 indicators were excited at 385 nm using a light emitting diode (LED) as shown in the scheme of
254 Fig.3a. Alternatively, simultaneous voltage and Ca^{2+} imaging can be achieved using Oregon Green,
255 Calcium Green or Fluo Ca^{2+} indicators using blue light (470 – 490 nm) to excite both VSDs and Ca^{2+}
256 indicators (31). Simultaneous imaging of JPW1114 and Oregon Green BAPTA-5N (OG5N) was
257 adopted to obtain the first combined measurement of V_m and Ca^{2+} currents using the configuration of
258 Fig.3b. This type of measurement, however, has several disadvantages. First, OG5N fluorescence
259 has a small tail component in the red region (31) which can be negligible or not depending on the ratio
260 of the two dyes at each site as well as on the ratio between the two signals. Thus, for example, it
261 works in proximal dendrites of CA1 pyramidal neurons for signals associated with action potentials
262 (11), where V_m fluorescence is stronger than Ca^{2+} fluorescence, but it does not in distal dendrites of
263 cerebellar Purkinje neurons (PNs, data not shown), where V_m fluorescence is weaker than Ca^{2+}
264 fluorescence. A second disadvantage is that the JPW1114 signal at 470 nm excitation is ~4 times
265 smaller than that at 532 nm excitation. If simultaneous recordings are not critical, one can replace
266 them with sequential recordings obtained by alternating 470 nm and 532 nm excitation as used in a
267 recent study (32). Finally, a third disadvantage is that JPW1114 absorbs more in the blue range than

268 in the green range, i.e. it exhibits toxic effects after fewer exposures. A crucial technical aspect to take
269 into consideration while setting up combined voltage and Ca^{2+} fluorescence measurements is the
270 ability to record the two signals simultaneously at high speed. To this purpose, the company
271 RedShirtImaging (Decatur, GA) has developed a dual-head version of the SMQ NeuroCCD (Fig. 3c).
272 This camera permits simultaneous image acquisitions from both heads at 5-20 kHz, i.e. at the
273 required speed. A demagnifier developed by Cairn Research Ltd (Faversham, UK) allows adjusting
274 the size of the image before it is split in two images at the emission wavelengths of the two dyes.
275 Thus, the alignment of the two heads of the camera allows obtaining, at each precise region of
276 interest, the V_m and the Ca^{2+} signal.

277

278 **2.2 Calibrating membrane potential fluorescence transients**

279 The calibration of V_m optical signals on an absolute scale (in mV) is crucial to analyse the gating of
280 Ca^{2+} channels at the same locations where Ca^{2+} recordings are performed. This is not, however,
281 straightforward. Indeed, the fractional change of VSD fluorescence is proportional to V_m (33), but the
282 linear coefficient between these two quantities depends on the ratio between the inactive dye and the
283 active dye that varies from site to site. The inactive dye is bound to membranes that do not change
284 potential and contributes only to the resting fluorescence, while the active dye is bound to the plasma
285 membrane and contributes to the resting fluorescence, but also carries the signal. In particular, in
286 experiments utilising intracellular application of the dye, inactive dye is the dye that binds to
287 intracellular membranes and organelles. Since the sensitivity of recording varies from site to site, a
288 calibration can be achieved only if a calibrating electrical signal that has known amplitude at all
289 locations is available. Such a signal is different in different systems. In mitral cells of the olfactory
290 bulb, the amplitude of an action potential is the same in the whole apical dendrite and it can be used
291 to create a sensitivity profile of the measuring system (34). Another type of calibrating electrical signal
292 can be a slow electrical change spreading with minimal attenuation over relatively long distances.
293 Such a signal can be used to reliably calibrate VSD signals in PNs (18). An example of this type of
294 calibration is reported in Fig. 4a. Starting from the resting V_m , that we assume nearly uniform over the
295 entire cell, long current hyperpolarising or depolarising current pulses are injected to the soma *via* the
296 patch pipette and the change in V_m is recorded. As shown by direct dendritic patch recording, the
297 dendrite is hyperpolarised by the same amount of the soma (35). Thus, the measurement of somatic
298 hyperpolarisation can be used as voltage reference to calibrate the dendritic VSD fractional change of
299 fluorescence ($\text{VSD } \Delta F/F_0$) optical signal, as shown in Fig. 4a. In contrast, a depolarisation step
300 attenuates along the dendrite. A third type of calibrating signal is a uniform depolarisation over the
301 entire dendritic tree using L-glutamate photolysis from 4-Methoxy-7-nitroindolyl-caged-L-glutamate
302 (MNI-glutamate) (14). This calibration procedure is applicable to all membrane expressing a relatively
303 large number of glutamate receptors, i.e. to dendrites with high densities of excitatory synapses. The
304 calibration is based on the principle that if the ionotropic glutamate receptor becomes the dominant
305 conductance in a particular neuronal compartment, its reversal potential will determine the membrane

306 potential of the compartment. Thus, in the area where dominance of glutamate receptor conductance
307 is obtained, the resulting V_m change will be the same and can be used to calibrate VSD signals. An
308 example of this protocol to calibrate backpropagating action potentials in CA1 hippocampal pyramidal
309 neurons is shown in Fig. 4b. The VSD $\Delta F/F_0$ signal associated with the backpropagating AP at
310 different sites of the apical dendrites is variable and cannot be directly correlated with the absolute
311 change of V_m . In the presence of 1 μ M TTX, to block action potentials, L-glutamate is photoreleased
312 to saturate glutamate receptors over the whole field of view. Since the recording is performed starting
313 from the resting V_m , the size of the VSD $\Delta F/F_0$ corresponds to this potential in the whole illuminated
314 area where V_m reaches the reversal potential of 0 mV. Thus, this information is used to extrapolate
315 the V_m at each dendritic site.

316

317

318 **4. Examples of combined voltage and Ca^{2+} current imaging**

319

320 **4.1 Ca^{2+} currents associated with backpropagating action potentials in CA1** 321 **hippocampal pyramidal neurons and in olfactory bulb mitral cells**

322 In many neurons, action potentials generated in the axon hillock adjacent to the soma do not only
323 propagate along the axon to reach neurotransmitter release terminals, but also backpropagate
324 throughout dendrites to signal cell activation at the sites where the neuron receives the synaptic
325 inputs. At least part of this information is given by the fast Ca^{2+} transients produced by activation of
326 VGCCs caused by the dendritic depolarisation associated with the action potential. The analysis that
327 can be performed using the present imaging method is therefore crucial at understanding signal
328 processing in individual neurons, as well as the specific role and function of the diverse VGCCs
329 activated in dendrites. The propagation of the action potential and the consequent activation of
330 VGCCs may be very different in different neuronal systems. In CA1 hippocampal pyramidal neurons,
331 action potentials attenuate along the dendrite and activate both high-voltage activated (HVA) and low-
332 voltage activated (LVA) VGCCs (36, 37). We have very recently demonstrated that HVA-VGCCs and
333 LVA-VGCCs operate synergistically to stabilise Ca^{2+} signals during burst firing (32). Somatic and
334 dendritic action potentials, at nearly physiological temperature, have 1-4 ms duration as in the
335 example shown in Fig. 5a. In agreement with this, the kinetics of the Ca^{2+} current is similar to that of
336 the action potential, with a peak delayed by a few hundred milliseconds from the peak of the action
337 potential. In total contrast to the CA1 hippocampal pyramidal neuron, in olfactory bulb mitral cells the
338 action potential does not attenuate along the dendrites (38). In addition, as shown in the
339 representative example of Fig. 5b, the somatic and dendritic action potential at near physiological
340 temperature (32-34 °C) has duration < 1 ms. Thus, in this system, the activation and deactivation of
341 VGCCs is also faster leading to a Ca^{2+} current with shorter duration and shorter delay from the V_m
342 waveform peak. This preliminary comparison between the two cases indicates that the role of
343 VGCCs, activated by the action potential, is different in different systems. For example, Ca^{2+} currents

344 with delays of $\sim 100 \mu\text{s}$ in presynaptic terminal where the function of this signal is to trigger
345 neurotransmitter release (39). Here, the kinetics of the Ca^{2+} current was obtained by calculating the
346 time derivative of the $\text{Ca}^{2+} \Delta F/F_0$ signal fit (16). VGCCs contribute to the shape of the action potential
347 directly and indirectly by activating K^+ channels, but also provide a precise time-locked Ca^{2+} transient
348 capable to select fast-activated Ca^{2+} binding proteins. The possibility to locally investigate, using
349 combined V_m and Ca^{2+} current optical measurements, the physiological occurrence of Ca^{2+} signals
350 mediated by VGCCs will contribute enormously, in the near future, to the understanding of complex
351 signal processing in neurons.

352

353 **4.2 Ca^{2+} currents associated with climbing fibre EPSPs in cerebellar Purkinje neurons**

354 In contrast to pyramidal neurons of the cortex and hippocampus, and to olfactory bulb mitral cells,
355 somatic/axonal action potentials in PNs do not actively propagate in the dendrites (40). The dendrites
356 of PNs, however, express P/Q-type HVA-VGCCs (25) and T-type LVA-VGCCs (26) that are activated
357 by the dendritic depolarisation produced by climbing fibre EPSPs. As shown in the example of Fig. 6,
358 the shape of the dendritic V_m , calibrated in Fig. 4a is quite different in the soma and in the dendrite,
359 mainly reflecting the absence of Na^+ action potentials in the dendrite. In this system, the low-affinity
360 Ca^{2+} indicator used to estimate the Ca^{2+} current was Fura-FF, since the larger Ca^{2+} signal produced
361 by OG5N contaminated the optical V_m measurement. The prominent dendritic depolarisation
362 produces a biphasic Ca^{2+} current, which is in this case obtained by applying our recent generalised
363 method (24). The fast and sharp component is nearly concomitant to the short period in which $V_m > -$
364 40 mV and it is therefore likely mediated by HVA-VGCCs. The slower and more persistent component
365 is instead mostly concomitant to the whole depolarisation transient and is therefore likely mediated by
366 LVA-VGCCs, as demonstrated by selectively blocking T-type VGCCs (unpublished data not shown).
367 The analysis of Ca^{2+} signalling associated with the climbing fibre EPSP is crucial for the
368 understanding of synaptic plasticity in PNs (41). Yet, while the role of the Ca^{2+} transient associated
369 with the climbing fibre EPSP has been postulated to be auxiliary to the principal Ca^{2+} signal mediated
370 by parallel fibre EPSPs, these first measurements of the Ca^{2+} current kinetics elucidate a quite
371 precise timing of occurrence of the Ca^{2+} source that may eventually provide a less ambiguous
372 explanation of the precise function of this spread dendritic depolarisation. In summary, the examples
373 illustrated in this section show the potentials of this novel optical method in providing physiological
374 information not available by using electrode techniques.

375

376

377 **5. Data interpretation and future prospective**

378

379 The method described here has been developed to overcome the limitations of single-electrode
380 or two-electrode voltage clamp techniques permitting the analysis of physiological Ca^{2+} currents of
381 native Ca^{2+} channels. Indeed, in contrast to patch-clamp recordings, these Ca^{2+} optical currents can

382 be measured in conditions of a physiological change of V_m and the measured currents are confined to
383 the sites where they are recorded, as shown in apical dendrites of hippocampal pyramidal neurons
384 (32). The additional information on local V_m change, necessary to correlate the behaviour of the
385 conductance with its biophysical properties, is obtained by combining VSD imaging. In cases of linear
386 behaviour between Ca^{2+} influx and Ca^{2+} fluorescence changes the kinetics of the Ca^{2+} current can be
387 extracted by calculating the time derivative of the Ca^{2+} $\Delta F/F_0$ signal using low-affinity Ca^{2+} indicators
388 (11, 16). In the case of nonlinear behaviour between Ca^{2+} influx and Ca^{2+} fluorescence, produced by
389 Ca^{2+} -binding proteins with slower kinetics with respect to the Ca^{2+} current, the kinetics of the Ca^{2+}
390 current can be still correctly estimated by taking into account the faster unbinding of Ca^{2+} from the
391 low-affinity indicator (24). In this last section we address the question of how data, obtained using this
392 technique, should be interpreted. In Ca^{2+} current recordings from channels expressed in heterologous
393 systems using voltage clamp, V_m is controlled artificially and its change is therefore independent of
394 the channel deactivation. Under physiological conditions, Ca^{2+} channels contribute to the V_m change
395 directly, through the ion flux, and indirectly by regulating other conductances. It follows that the
396 channel deactivation changes the V_m waveform. We have shown that in CA1 hippocampal pyramidal
397 neurons this phenomenon produces a modulation of LVA-VGCCs by HVA-VGCCs (32). More in
398 general, a Ca^{2+} current mediated by diverse VGCCs is always the result of a synergy among all
399 different ion channels contributing to the V_m waveform. It follows that in a Ca^{2+} current optical
400 measurement, a single component of the current cannot be extracted simply by blocking the
401 underlying channel, since this block may affect the residual current as well. This evidence has
402 important implications in the study of transgenic animals carrying Ca^{2+} channel mutations. In this
403 case, a certain phenotype is likely to result from the combined modification of function of many
404 different channels, rather than from the specific Ca^{2+} influx component, making the study of these
405 animals as models for disease challenging. In summary, the investigation of the role and function of
406 individual Ca^{2+} channels must be performed in the global context of activation of all channels
407 participating to the local V_m waveform.

408 Another important aspect of data interpretation is the relation of the kinetics of Ca^{2+} current with
409 the putative molecular targets of Ca^{2+} ions entering the cell. While importance is normally given to
410 possible molecular coupling between the Ca^{2+} channel and the Ca^{2+} binding protein, the kinetics of
411 the Ca^{2+} current can be a potent selector of the molecular pathway which is activated. To illustrate this
412 important concept we make use of computer simulations using the same theoretical framework for
413 simple Ca^{2+} -binding dynamics that we already used in the past (42). We imagine the possible
414 activation of two proteins: a “fast” protein with $K_{ON} = 5.7 \cdot 10^8 \text{ M}^{-1}\text{s}^{-1}$ and $K_D = 10 \text{ }\mu\text{M}$, expressed at the
415 concentration of $500 \text{ }\mu\text{M}$; and a “slow” protein with $K_{ON} = 4 \cdot 10^8 \text{ M}^{-1}\text{s}^{-1}$ and $K_D = 0.4 \text{ }\mu\text{M}$, expressed at
416 the concentration of $100 \text{ }\mu\text{M}$. In the first case, shown in Fig. 7a, the cell is receiving a fast Ca^{2+} current
417 with $\sim 2 \text{ ms}$ total duration which binds first to the fast protein and later to the slow protein. In the
418 second case, shown in Fig. 7b, the cell is receiving a slower Ca^{2+} current that is smaller in amplitude
419 but that carries approximately the same amount of Ca^{2+} . In this case the slow protein binds to Ca^{2+}
420 with a slower kinetics but the amount of the fast protein binding to Ca^{2+} is less than half with respect

421 to the first case. These simulations indicate that the ability to activate for a molecular pathway
422 triggered by the fast protein strongly depends on the kinetics of the Ca^{2+} current. Thus, the approach
423 described here should drastically improve our understanding of the physiological function of Ca^{2+}
424 channels by providing the possibility to explore the biophysics of native channels during physiological
425 activity locally within the complex neuronal architecture. The examples of combined V_m and Ca^{2+}
426 current optical measurements from CA1 hippocampal pyramidal neurons, olfactory bulb mitral cells
427 and PNs reported here are representative of the types of exploration that can be performed using this
428 novel approach.

429

430 **Acknowledgment**

431 This work was supported by the *Agence Nationale de la Recherche* through three grants: 1. Grant
432 *WaveFrontImag*, program number ANR-14-CE17-0006-01; 2. Labex *Ion Channels Science and*
433 *Therapeutics*, program number ANR-11-LABX-0015; 3. National Infrastructure France Life Imaging
434 “Noeud Grenoblois” ; and by the *Federation pour la recherche sur le Cerveau* (FRC) through the grant
435 *Espoir en tête* (in partnership with Rotary France).

436

437

438

439 **References**

440

- 441 [1] Braubach O, Cohen LB, Choi Y (2015) Historical Overview and General Methods of Membrane
442 Potential Imaging. *Adv Exp Med Biol* 859: 3-26
- 443 [2] Davies R, Graham J, Canepari M (2013) Light sources and cameras for standard in vitro
444 membrane potential and high-speed ion imaging. *J Microsc* 251: 5-13
- 445 [3] Canepari M, Willadt S, Zecevic D, Vogt KE (2010) Imaging Inhibitory Synaptic Potentials Using
446 Voltage Sensitive Dyes. *Biophys J* 98: 2032-2040
- 447 [4] Sakmann, B, Neher E (1986) Patch clamp techniques for studying ionic channels in excitable
448 membranes. *Annu Rev Physiol* 46: 455-472
- 449 [5] Gray R, Johnston D (1985) Rectification of single GABA-gated chloride channels in adult
450 hippocampal neurons. *J Neurophysiol* 54: 134-142
- 451 [6] Lester HA (1988) Heterologous expression of excitability proteins: route to more specific drugs?
452 *Science* 241: 1057-1063
- 453 [7] Guy HR, Conti F (1990) Pursuing the structure and function of voltage-gated channels. *Trends*
454 *Neurosci* 13: 201-206
- 455 [8] Antic SD (2016) Simultaneous recordings of voltage and current waveforms from dendrites. *J*
456 *Physiol* 594: 2557-2558.
- 457 [9] Williams SR, Mitchell SJ (2008) Direct measurement of somatic voltage clamp errors in central
458 neurons. *Nat Neurosci* 11: 790-798.

- 459 [10] Hodgkin AL, Huxley AF (1952) Currents carried by sodium and potassium ions through the
460 membrane of the giant axon of *Loligo*. *J Physiol* 116: 449-472.
- 461 [11] Jaafari N, De Waard M, Canepari M (2014) Imaging Fast Calcium Currents beyond the
462 Limitations of Electrode Techniques. *Biophys J* 107: 1280-1288
- 463 [12] Canepari M, Vogt K, Zecevic D (2008) Combining voltage and calcium imaging from neuronal
464 dendrites. *Cell Mol Neurobiol* 58: 1079-1093
- 465 [13] Vogt KE, Gerharz S, Graham J, Canepari M (2011a) High-resolution simultaneous voltage and
466 Ca^{2+} imaging. *J Physiol* 589: 489-494
- 467 [14] Vogt KE, Gerharz S, Graham J, Canepari M (2011b) Combining membrane potential imaging
468 with L-glutamate or GABA photorelease. *PLoS ONE* 6: e24911
- 469 [15] Kao JP, Tsien RY (1988) Ca^{2+} binding kinetics of fura-2 and azo-1 from temperature-jump
470 relaxation measurements. *Biophys J* 53: 635-639
- 471 [16] Jaafari N, Marret E, Canepari M (2015) Using simultaneous voltage and calcium imaging to study
472 fast Ca^{2+} channels. *Neurophotonics* 2: 021010
- 473 [17] Canepari M, Odgen D (2006) Kinetic, pharmacological and activity-dependent separation of two
474 Ca^{2+} signalling pathways mediated by type 1 metabotropic glutamate receptors in rat Purkinje
475 neurons. *J Physiol* 573: 65-82
- 476 [18] Canepari M, Vogt, KE (2008) Dendritic Spike Saturation of Endogenous Calcium Buffer and
477 Induction of Postsynaptic Cerebellar LTP. *PLoS ONE* 3: e4011
- 478 [19] Savitzky A, Golay MJE (1964) Smoothing and Differentiation of Data by Simplified Least Squares
479 Procedures. *Anal Chem* 36: 1627-1639
- 480 [20] Nägerl UV, Novo D, Mody I, Vergara JL (2000) Binding kinetics of calbindin-D(28k) determined
481 by flash photolysis of caged Ca^{2+} . *Biophys J* 79: 3009-3018
- 482 [21] Airaksinen MS, Eilers J, Garaschuk O, Thoenen H, Konnerth A, Meyer M (1997) Ataxia and
483 altered dendritic calcium signalling in mice carrying a targeted nullmutation of the calbindin
484 D28k gene. *Proc Natl Acad Sci USA* 94: 1488-1493
- 485 [22] Lee SH, Schwaller B, Neher E (2000) Kinetics of Ca^{2+} binding to parvalbumin in bovine
486 chromaffin cells: implications for $[Ca^{2+}]$ transients of neuronal dendrites. *J Physiol* 525: 419-
487 432
- 488 [23] Schmidt H, Stiefel KM, Racay P, Schwaller B, Eilers J (2003) Mutational analysis of dendritic
489 Ca^{2+} kinetics in rodent Purkinje cells: role of parvalbumin and calbindin D28k. *J Physiol* 551:
490 13-32
- 491 [24] Ait Ouares K, Jaafari N, Canepari M (2016) A generalised method to estimate the kinetics of fast
492 Ca^{2+} currents from Ca^{2+} imaging experiments. *J Neurosci Methods* 268: 66-77
- 493 [25] Usowicz MM, Sugimori M, Cherksey B, Llinás R (1992) P-type calcium channels in the somata
494 and dendrites of adult cerebellar Purkinje cells. *Neuron* 9: 1185-1199
- 495 [26] Isope P, Hildebrand ME, Snutch TP (2012) Contributions of T-type voltage-
496 gated calcium channels to postsynaptic calcium signaling within Purkinje neurons. *Cerebellum*
497 11: 651-665

- 498 [27] Miyakawa H, Lev-Ram V, Lasser-Ross N, Ross WN (1992) Calcium transients evoked by
499 climbing fiber and parallel fiber synaptic inputs in guinea pig cerebellar Purkinje neurons. *J*
500 *Neurophysiol* 68: 1178-1189
- 501 [28] Yan P, Acker CD, Zhou WL, Lee P, Bollensdorff C, Negrean A, Lotti J, Sacconi L, Antic SD, Kohl
502 P, Mansvelder HD, Pavone FS, Loew LM (2012) Palette of fluorinated voltage-sensitive
503 hemicyanine dyes. *Proc Natl Acad Sci USA* 109: 20443-20448
- 504 [29] Willadt S, Canepari M, Yan P, Loew LM, Vogt KE (2014) Combined optogenetics and voltage
505 sensitive dye imaging at single cell resolution. *Front Cell Neurosci* 8: 311
- 506 [30] Antic SD (2003) Action potentials in basal and oblique dendrites of rat neocortical pyramidal
507 neurons. *J Physiol* 550: 35-50
- 508 [31] Bullen A, Saggau P (1998) Indicators and optical configuration for simultaneous high-resolution
509 recording of membrane potential and intracellular calcium using laser scanning microscopy.
510 *Pflügers Arch* 436: 788–796
- 511 [32] Jaafari N, Canepari M (2016) Functional coupling of diverse voltage-gated Ca(2+) channels
512 underlies high fidelity of fast dendritic Ca(2+) signals during burst firing. *J Physiol* 594: 967-
513 983
- 514 [33] Loew LM, Simpson LL (1981) Charge-shift probes of membrane potential: a probable
515 electrochromic mechanism for p-aminostyrylpyridinium probes on a hemispherical lipid bilayer.
516 *Biophys J* 34: 353-365
- 517 [34] Djuricic M, Antic S, Chen WR, Zecevic D (2004) Voltage imaging from dendrites of mitral cells:
518 EPSP attenuation and spike trigger zones. *J Neurosci* 24: 6703-6714
- 519 [35] Roth A, Häusser M (2001) Compartmental models of rat cerebellar Purkinje cells based on
520 simultaneous somatic and dendritic patch-clamp recordings. *J Physiol* 535: 445-472
- 521 [36] Spruston N, Schiller Y, Stuart G, Sakmann B (1995) Activity-dependent action potential invasion
522 and calcium influx into hippocampal CA1 dendrites. *Science* 268: 297-300
- 523 [37] Canepari M, Djuricic M, Zecevic D (2007) Dendritic signals from rat hippocampal CA1 pyramidal
524 neurons during coincident pre- and post-synaptic activity: a combined voltage- and calcium-
525 imaging study. *J Physiol* 580: 463-484
- 526 [38] Bischofberger J, Jonas P (1997) Action potential propagation into the presynaptic dendrites of
527 rat mitral cells. *J Physiol* 504: 359-365
- 528 [39] Sabatini BL, Regerh WG (1996) Timing of neurotransmission at fast synapses in the mammalian
529 brain. *Nature* 384: 170-172.
- 530 [40] Stuart G, Häusser M (1994) Initiation and spread of sodium action potentials in cerebellar
531 Purkinje cells. *Neuron* 13: 703-712
- 532 [41] Vogt KE, Canepari M (2010) On the induction of postsynaptic granule cell-Purkinje neuron LTP
533 and LTD. *Cerebellum* 9: 284-290
- 534 [42] Canepari M, Mammano F (1999) Imaging neuronal calcium fluorescence at high spatio-temporal
535 resolution. *J. Neurosci. Methods* 1999; 87:1 -11
- 536

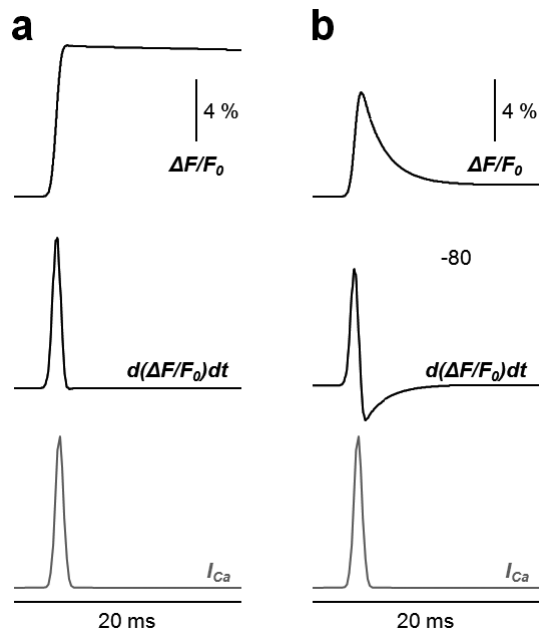
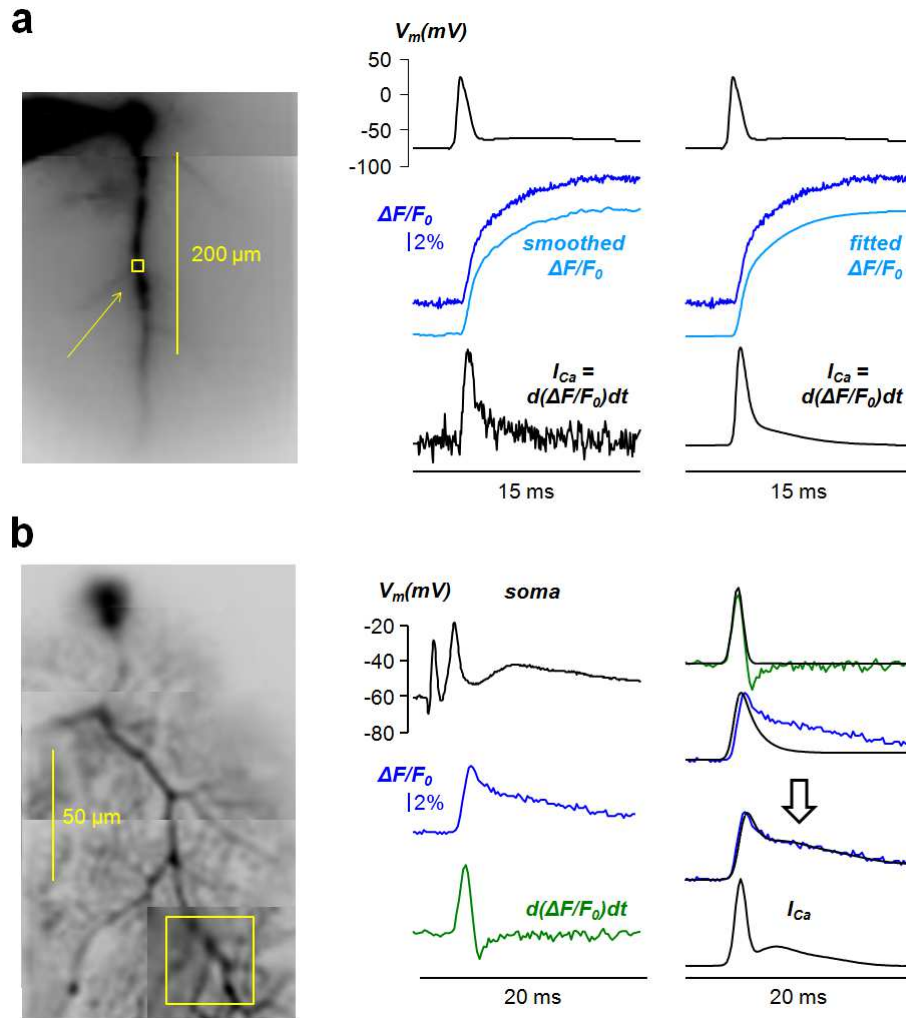

Fig. 1. Simulation of hypothetical Ca^{2+} $\Delta F/F_0$ signals from 2 mM OG5N in the presence of endogenous Ca^{2+} buffers. **(a)** Simulation of $\Delta F/F_0$ signal (top trace) following a Ca^{2+} current with simple Gaussian kinetics (I_{Ca} , gray trace on the bottom) in the presence of 1 mM of a fast endogenous Ca^{2+} buffer with same association constant of the Ca^{2+} indicator ($5.7 \cdot 10^8 \text{ M}^{-1}\text{s}^{-1}$) and $K_D = 10 \text{ }\mu\text{M}$. The kinetics of the $\Delta F/F_0$ time derivative (middle trace) matches the kinetics of the Ca^{2+} current. **(b)** Same as in the previous panel but in this case in the presence of additional 400 μM of a slower buffer with association constant equal to $2 \cdot 10^8 \text{ M}^{-1}\text{s}^{-1}$ and $K_D = 0.2 \text{ }\mu\text{M}$. The kinetics of the $\Delta F/F_0$ time derivative (middle trace) does not matches the kinetics of the Ca^{2+} current.

537

538



539
 540 Fig. 2. Different strategies to estimate the kinetics of a Ca^{2+} current (a) On the left, fluorescence
 541 image of CA1 hippocampal pyramidal neuron filled with 2 mM OG5N with a small region of the apical
 542 dendrite outlined and indicated by the arrow. On the right, somatic V_m change associated with an
 543 action potential (top black traces) and Ca^{2+} $\Delta F/F_0$ signal in the indicated region (blue trace). The $\Delta F/F_0$
 544 signal is either smoothed with a Savitzky-Golay algorithm (left) or fitted with a 3-sigmoid function
 545 (right). The Ca^{2+} current kinetics (I_{Ca}) is then estimated by calculating the time derivative of the
 546 processed $\Delta F/F_0$ signal. The kinetics of the current is the same using the two strategies, but the curve
 547 obtained with the strategy of data fitting is noiseless. Data, recorded at 20 kHz, were from averages of
 548 16 trials. (b) On the left, fluorescence image of PN filled with 2 mM OG5N with square region of
 549 interest outlined. On the right, somatic V_m change associated with a climbing fibre EPSP (top-left
 550 black trace) and Ca^{2+} $\Delta F/F_0$ signal in the indicated region (blue traces). The time derivative of the Ca^{2+}
 551 $\Delta F/F_0$ signal (green traces) does not match the kinetics of the current. To estimate the kinetics of the
 552 current we use a strategy that consists in matching the result of a computer simulation to the Ca^{2+}
 553 $\Delta F/F_0$ signal using an optimised two-buffer model (24). We start from the Gaussian function fitting the
 554 rising phase of the $\Delta F/F_0$ time derivative (top-right black trace). We then correct the current with three
 555 additional Gaussian components until a match of the computer simulation with the Ca^{2+} $\Delta F/F_0$ signal
 556 is obtained (process indicated by the arrow). The curve producing this match (I_{Ca} , bottom-right black

557 trace) is the estimate of the Ca^{2+} current kinetics. Data, recorded at 5 kHz, were from averages of 4
558 trials.

559

560

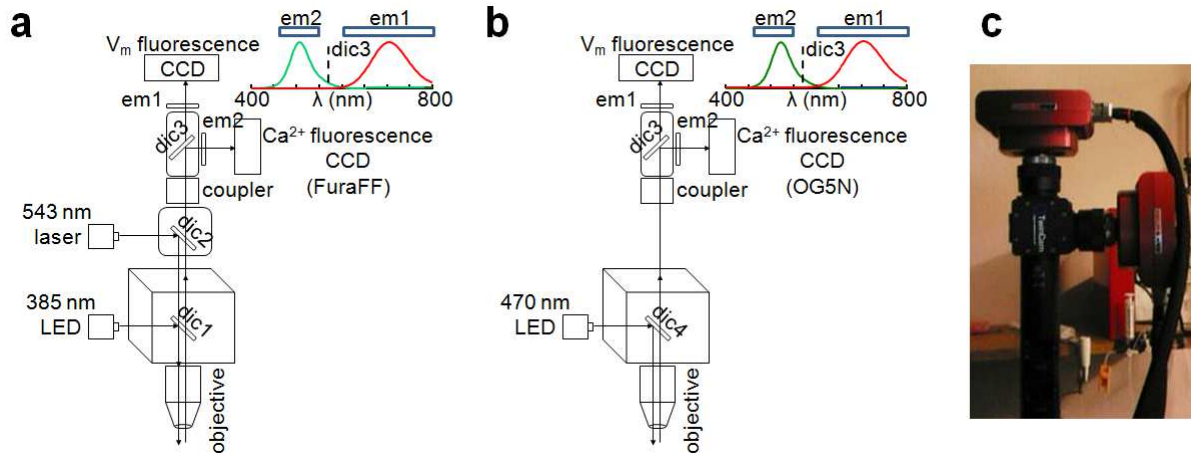

561

562 Fig. 3. Configurations and camera for combined voltage and Ca^{2+} fluorescence measurements. (a)
563 Schematic drawing of the apparatus for simultaneous voltage and Ca^{2+} imaging using the VSD
564 JPW1114 and the Ca^{2+} indicator FuraFF (13); 385 nm LED light via the epifluorescence port of a
565 commercial microscope is reflected by a 506 nm long-pass dichroic mirror (dic1); 543 nm laser light
566 via the top of the microscope is reflected by a dual-band dichroic mirror transmitting wavelengths
567 between 493 nm and 530 nm and wavelengths longer than 574 nm (dic2); the fluorescence images of
568 the two dyes are demagnified and separated by a 565 nm long-pass dichroic mirror (dic3); The V_m
569 image and the Ca^{2+} images are filtered by a 610 nm long-pass (em1) and by a 510 ± 42 nm band-pass
570 filter (em2) respectively, then acquired by two CCD cameras; the emission spectra of FuraFF (green)
571 and JPW1114 (red) are shown on the top-right. (b) Schematic drawing of the apparatus for
572 simultaneous voltage and Ca^{2+} imaging using the VSD JPW1114 and the Ca^{2+} indicator OG5N (11);
573 470 nm LED light via the epifluorescence port of a commercial microscope is reflected by a 495 nm
574 long-pass dichroic mirror (dic4); the fluorescence images of the two dyes are demagnified and
575 processed as in the previous configuration; the emission spectra of OG5N (green) and JPW1114
576 (red) are shown on the top-right. (c) The dual NeuroCCD camera designed by RedshirtImaging for
577 this type of measurement.

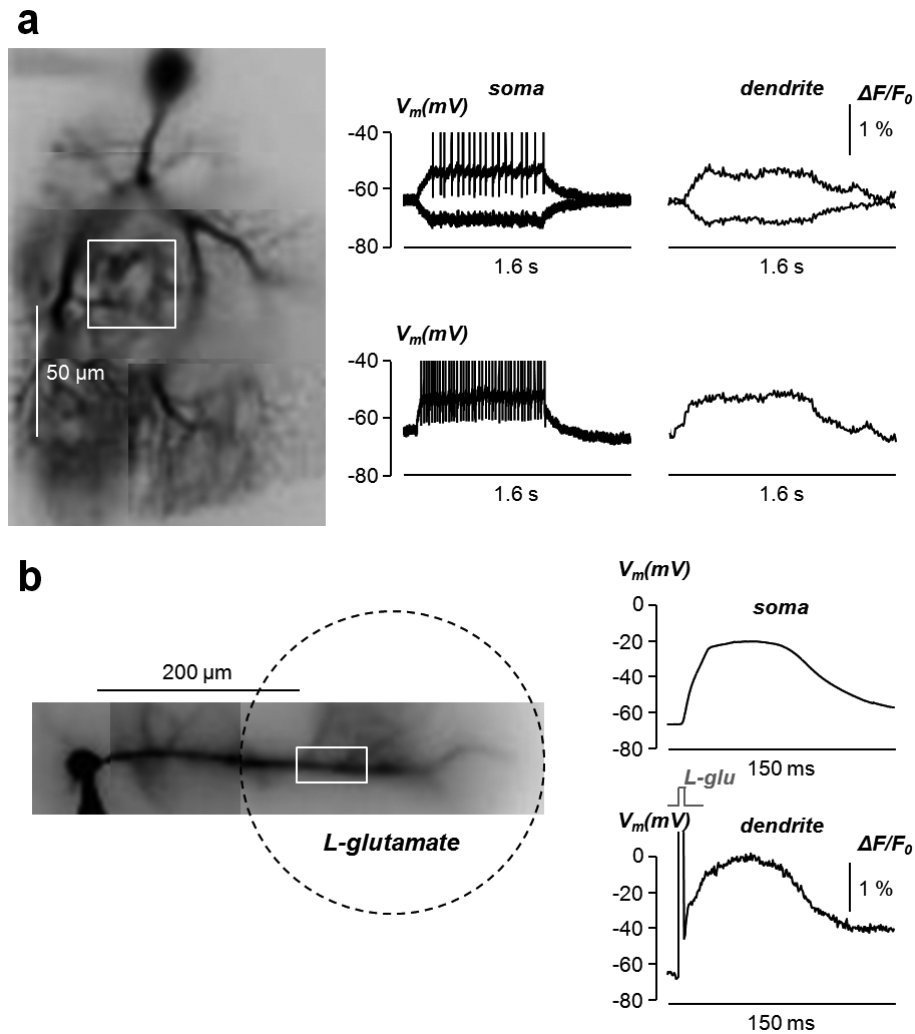

578
 579 Fig. 4. Calibration methods for dendritic V_m optical signals. (a) On the left, fluorescence image of PN
 580 with square region of interest outlined. On the right, somatic V_m change associated with long
 581 hyperpolarising or depolarising steps and associated dendritic VSD $\Delta F/F_0$ signals in the region of
 582 interest; the hyperpolarising step spreads to the dendrites with negligible attenuation (35) and is used
 583 to calibrate the VSD $\Delta F/F_0$ signals; the weak depolarising step on the top also spreads with minimal
 584 attenuation, but the associated somatic action potentials do not propagate into the dendrites; in
 585 contrast, the strong depolarising step on the bottom attenuates. (b) On the left, fluorescence image of
 586 CA1 hippocampal pyramidal neuron with rectangular region, 200-250 μm from the soma, outlined. On
 587 the right, somatic V_m change associated with L-glutamate photorelease from MNI-glutamate (14) in
 588 the area limited by the dotted line and in the presence of 1 μM tetrodotoxin blocking action potentials;
 589 the dendritic VSD $\Delta F/F_0$ signal is reported on the bottom; the saturating L-glutamate concentration
 590 depolarises the illuminated area from the resting V_m (~ -70 mV) to the reversal potential of AMPA
 591 receptors (0 mV). All calibrations were from single trials.

592
 593
 594
 595
 596

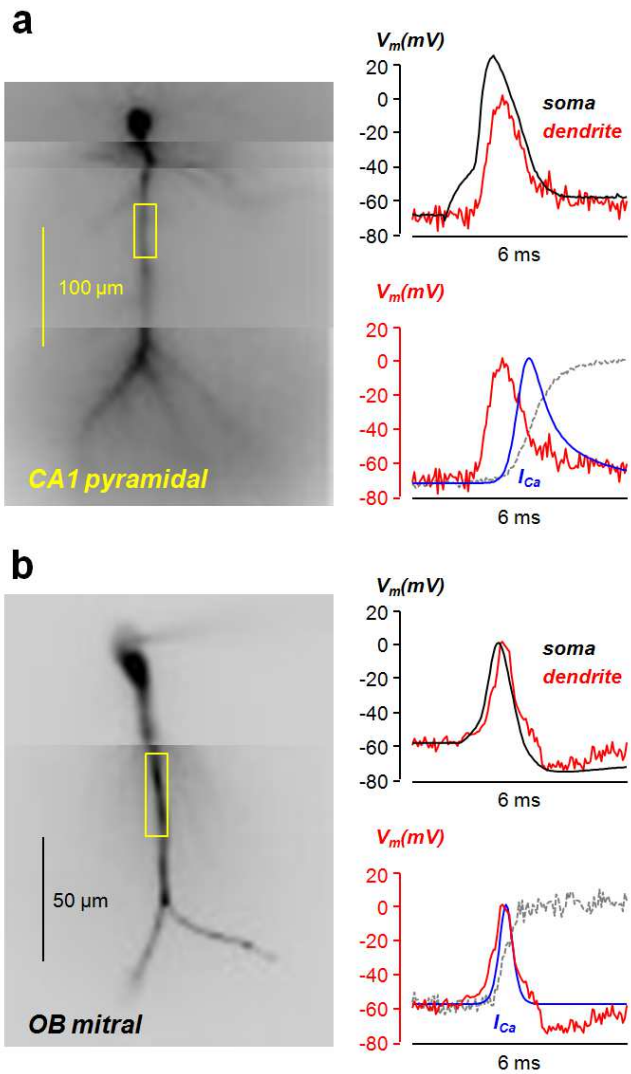

Fig. 5. Ca^{2+} currents associated with backpropagating action potentials in CA1 hippocampal pyramidal neurons and in olfactory bulb (OB) mitral cells (**a**) On the left, fluorescence image of CA1 hippocampal pyramidal neuron filled with JPW1114 and 2 mM OG5N with a region of the apical dendrite outlined. On the right, somatic V_m change associated with an action potential (black trace) in the soma and in the dendritic region. The associated Ca^{2+} current kinetics, obtained with the fitting strategy from the raw Ca^{2+} signal (dashed gray trace), is shown in the bottom. (**b**) On the left, fluorescence image of OB cell filled with JPW1114 and 2 mM OG5N with a region of the principal dendrite outlined. On the right, somatic V_m change associated with an action potential in the soma (black trace) and in the dendritic region (red trace). The associated Ca^{2+} current kinetics, obtained with the fitting strategy from the raw Ca^{2+} signal (dashed gray trace), is shown in the bottom (blue trace) superimposed to the dendritic action potential (red trace). Data, recorded at 20 kHz, were from averages of 4 trials. All experiments were performed at 32-34 °C.

598

599

600

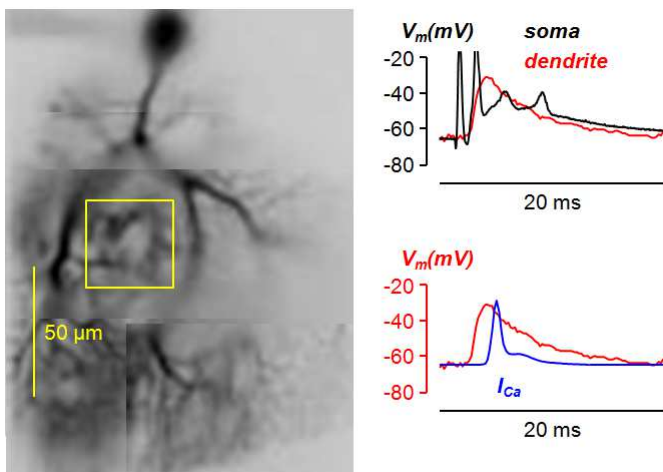

Fig. 6. Ca^{2+} currents associated with climbing fibre EPSPs in cerebellar Purkinje neurons. On the left, fluorescence image of PN filled with JPW1114 and 2 mM Fura-FF with a region of the dendrite outlined. On the right, somatic V_m change associated with climbing fibre EPSP (black trace) in the soma and in the dendritic region. The associated Ca^{2+} current kinetics, obtained with the generalised method (24), is shown in the bottom. Data, recorded at 5 kHz, were from averages of 4

trials. Experiments were performed at 32-34 °C.

601
602
603

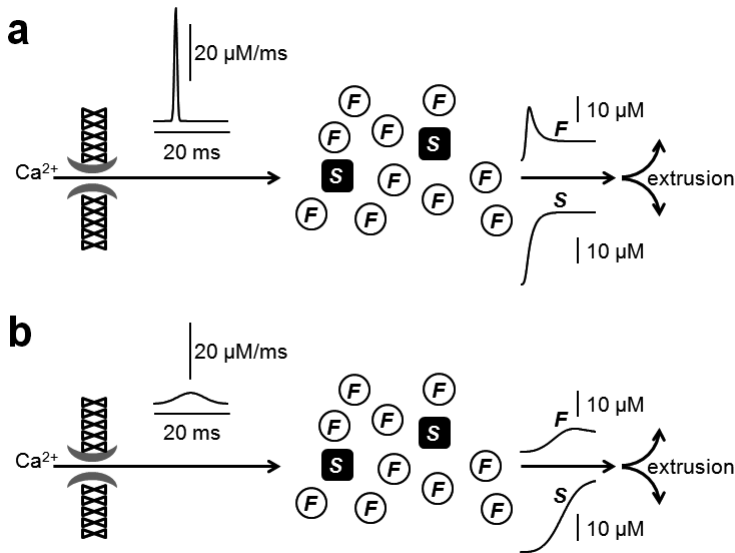

Fig. 7. Simulated activation of two different Ca²⁺-binding proteins by Ca²⁺ currents. (a) In a cell containing 500 μM of a fast (F) buffer with $K_{ON} = 5.7 \cdot 10^8 \text{ M}^{-1}\text{s}^{-1}$ and $K_D = 10 \text{ μM}$, and 100 μM of a slow (S) buffer with $K_{ON} = 4 \cdot 10^8 \text{ M}^{-1}\text{s}^{-1}$ and $K_D = 0.4 \text{ μM}$, the curves on the right report the binding to Ca²⁺ of the F and S proteins following the fast Ca²⁺ current reported on the left. (b) Same as in the previous panel but following the fast Ca²⁺ current reported on the left.

604
605