



**HAL**  
open science

## Minimal graphs for 2-factor extension

M.-C. Costa, Dominique de Werra, Christophe Picouleau

► **To cite this version:**

M.-C. Costa, Dominique de Werra, Christophe Picouleau. Minimal graphs for 2-factor extension. Discrete Applied Mathematics, 2020, 10.1016/j.dam.2019.11.022 . hal-02436792

**HAL Id: hal-02436792**

**<https://hal.science/hal-02436792>**

Submitted on 6 Jun 2022

**HAL** is a multi-disciplinary open access archive for the deposit and dissemination of scientific research documents, whether they are published or not. The documents may come from teaching and research institutions in France or abroad, or from public or private research centers.

L'archive ouverte pluridisciplinaire **HAL**, est destinée au dépôt et à la diffusion de documents scientifiques de niveau recherche, publiés ou non, émanant des établissements d'enseignement et de recherche français ou étrangers, des laboratoires publics ou privés.



Distributed under a Creative Commons Attribution - NonCommercial 4.0 International License

# Minimal graphs for 2-factor extension

M.-C. Costa <sup>\*</sup>      D. de Werra <sup>†</sup>      C. Picouleau <sup>‡</sup>

December 29, 2020

## Abstract

Let  $G = (V, E)$  be a simple loopless finite undirected graph. We say that  $G$  is (*2-factor*) *expandable* if for any non-edge  $uv$ ,  $G + uv$  has a 2-factor  $F$  that contains  $uv$ . We are interested in the following: Given a positive integer  $n = |V|$ , what is the minimum cardinality of  $E$  such that there exists  $G = (V, E)$  which is 2-factor expandable? This minimum number is denoted by  $Exp_2(n)$ . We give an explicit formula for  $Exp_2(n)$  and provide 2-factor expandable graphs of minimum size  $Exp_2(n)$ .

**Keywords:** 2-factor, minimum expandable graph, reliability.

## 1 Introduction

Much work in graph theory has concentrated on 2-factors which generalize perfect matchings (see for instance [3]). A characterization of graphs admitting a 2-factor can be found in [6] (Vol A, page 527 ). It is a challenging problem to characterize 2-factor edge critical graphs, i.e., graphs with no 2-factor but which have a 2-factor by adding any new edge. Since such a characterization seems hard to derive, in this paper we will restrict our attention to finding the minimum number of edges in a graph  $G$  on  $n$  vertices such that for any two non adjacent vertices  $u, v$  the graph  $G + uv$  has a 2-factor containing  $uv$ . Notice that contrary to the 2-factor edge critical graphs here  $G$  may contain a 2-factor or not. These graphs will be called *minimal 2-factor expandable*.

This work is motivated by the following reliability problem: In a complete graph  $(V, E)$  on  $n$  vertices edges are subject to breakdowns. We want to reinforce a minimal subset  $F$  of edges in such a way that any surviving edge in  $E - F$  can be expanded with reinforced edges to a 2-factor. A related problem of 1-factor expansion has been studied in [4] where a complete characterization of minimal 1-factor expandable graphs has been derived.

We now give some definitions required to formalize our problem.

---

<sup>\*</sup>Conservatoire National des Arts et Métiers, CEDRIC laboratory, Paris (France) and ENSTA-ParisTech. Email: [marie-christine.costa@ensta-paristech.fr](mailto:marie-christine.costa@ensta-paristech.fr)

<sup>‡</sup>Conservatoire National des Arts et Métiers, CEDRIC laboratory, Paris (France). Email: [christophe.picouleau@cnam.fr](mailto:christophe.picouleau@cnam.fr)

<sup>†</sup>Ecole Polytechnique Fédérale de Lausanne, Lausanne (Switzerland). Email: [dominique.dewerra@epfl.ch](mailto:dominique.dewerra@epfl.ch)

We will consider a simple finite graph  $G = (V, E)$  with  $n \geq 3$  vertices and  $m$  edges. A pair  $u, v$  of vertices is a *non-edge* if  $uv \notin E$ .

- A subset  $F \subseteq E$  is a *2-factor* if every vertex  $v$  has exactly two edges in  $F$  which are incident in  $v$ . Equivalently  $F$  is a collection of vertex-disjoint cycles covering all vertices.
- $G$  is *2-factor expandable* (or shortly *expandable*) if for every non-edge  $xy$  the graph  $G_{xy} = (V, E \cup xy)$  has a 2-factor  $F$  with  $xy \in F$ . In such a case we say that the non-edge  $xy$  has been *extended* to a 2-factor.
- For any fixed  $n \geq 3$  an expandable graph with a minimum number of edges is a *minimum expandable graph* (*meg*( $n$ )). The size of its edge set is denoted by  $Exp_2(n)$ .

We intend to determine, for any fixed integer  $n \geq 3$ , the value  $Exp_2(n)$  and to exhibit a graph  $meg(n)$ .

We now give the notations we use later. For any subset  $X \subseteq V$  the subgraph induced by  $X$  is denoted by  $G[X]$ . We write  $G - X = G[V \setminus X]$  and  $G - v$  for  $G - \{v\}$ .  $N(v)$  is the set of neighbors of a vertex  $v$ ;  $d(v) = |N(v)|$  is the degree of  $v$ ; a *p-vertex* is a vertex of degree  $p$ . If  $p = 0$  then  $v$  is an *isolated* vertex; when  $p = 1$  then  $v$  is called a *leaf*; if  $d(v) = n - 1$ , then  $v$  is *universal*. The closed neighborhood of  $v$  is  $N[v] = N(v) \cup \{v\}$ .  $\delta(G)$  (resp.  $\Delta(G)$ ) is the minimum (resp. maximum) degree of  $G$ . An induced path with  $p$  edges is called a *p-path*. By  $d(u, v)$  we denote the *distance* between  $u$  and  $v$ , i.e., the length of a shortest path (number of edges) between  $u$  and  $v$  in  $G$ .  $C_k$  (resp.  $K_k$ ) is the induced cycle (resp. complete graph) on  $k$  vertices.

For all definitions related to graphs, see [3].

We state our main result which will be proved in the following sections:

**Proposition 1.1** *The minimum size of a 2-factor expandable graph is:*

- $Exp_2(3) = 2, Exp_2(4) = 4, Exp_2(5) = 6, Exp_2(6) = 9, Exp_2(7) = 10, Exp_2(8) = 11, Exp_2(9) = 12;$
- $Exp_2(n) = \lceil \frac{11}{8}n \rceil, n \geq 10.$

The paper is organized as follows. In Section 2 some elementary properties of expandable graphs will be stated for later use. Section 3 will be dedicated to the presentation of  $meg(n)$  for  $3 \leq n \leq 9$ . In Section 4 a lower bound for  $Exp_2(n)$  will be established for  $n \geq 10$ , while it will be shown in Section 5 that it is best possible. Variations of the construction for  $n = 8p$  will be presented in Section 5.3 to handle the case  $n \not\equiv 0 \pmod{8}, n \geq 14$ . Finally constructions will be given for  $10 \leq n \leq 13$  in Section 5.4. Some conclusions and suggestions for further research are presented in Section 6.

## 2 Properties of expandable graphs

We shall state some basic properties of expandable graphs which will be used to determine  $Exp_2(n)$ .

**Fact 2.1** *If  $G = (V, E)$  is not expandable, then no partial graph  $G' = (V, E')$ , with  $E' \subset E$ , is expandable.*

Let  $G = (V, E)$  be an expandable graph.

**Property 2.1**  *$G$  is connected.*

**Proof:** If  $u$  and  $v$  are in two distinct components, then clearly  $uv$  cannot be extended.  $\square$

**Property 2.2** *If  $G$  has a leaf, then for  $n = 5$  we have  $m \geq 7$  and for  $n \geq 6$  we have  $m \geq \frac{3}{2}n$ .*

**Proof:** Let  $u$  be a 1-vertex of  $G$ . If  $G$  is expandable, then  $G - u$  induces a clique. So for  $n = 5$  we have  $m \geq 7$  and for  $n \geq 6$  we obtain  $m \geq \frac{3}{2}n$ .  $\square$

**Property 2.3** *If  $G$  contains a universal vertex and  $n \geq 5$ , then  $m \geq \frac{3}{2}(n - 1)$ .*

**Proof:** Assume that  $G$  has a universal vertex. If there is no leaf, then  $\sum_{u \in V} d(u) \geq n - 1 + 2(n - 1) = 3(n - 1)$ , else from Property 2.2  $m \geq \frac{3}{2}(n - 1)$ .  $\square$

**Property 2.4** *Let  $G$  contain a 2-vertex  $v$  with  $N(v) = \{a, b\}$  and  $ab \notin E$ . If there is  $c \in N(a) \cap N(b)$ ,  $c \neq v$ , then  $d(c) \geq 4$ .*

**Proof:** Consider any extension of  $ab$ : the triangle  $(a, b, v)$  is in the 2-factor. Since  $c$  is necessarily covered by another cycle, we have  $d(c) \geq 4$ .  $\square$

**Property 2.5** *Let  $G$  contain two 2-vertices  $u, v$ . If  $d(u, v) = 4$  with the 4-path  $uu'tv'v$ , then  $d(t) > 3$ .*

**Proof:**  $d(u, v) = 4$  implies that  $u'v' \notin E$ . Now if  $d(t) \leq 3$  the non-edge  $u'v'$  cannot be extended.  $\square$

**Property 2.6** *Let  $n \geq 7$ . If a vertex  $v$  is adjacent to two 2-vertices, then  $v$  is universal and  $m \geq \frac{3}{2}n$ .*

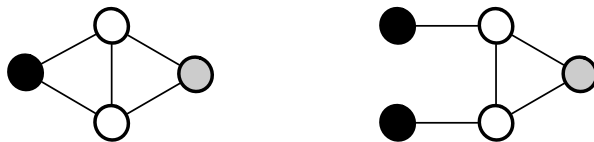

Figure 1: The diamond and the bull. In Property 2.7 a black vertex is a 2-vertices, the grey vertex is the head.

**Proof:** We can assume that  $\delta(G) \geq 2$  since, as seen in the proof of Property 2.2, if there is a leaf  $G$  has no 2-vertex.  $v$  is universal since, otherwise, there is a non-edge  $vw$  that can not be extended. If there are exactly two 2-vertices we have  $\sum_{u \in V} d(u) \geq (n-1) + 4 + 3(n-3) = 4n - 6$  and  $m \geq \frac{3}{2}n$  since  $n \geq 7$ . If  $a, b, c$  are three 2-vertices, then any non-edge  $xy$  with  $x, y \neq a, b, c$  cannot be extended since any 2-factor containing  $xy$  would use exactly two edges among  $va, vb, vc$ . Thus  $G - \{a, b, c\}$  is a clique. So we have  $m = 6 + \frac{1}{2}(n-3)(n-4) \geq \frac{3}{2}n$ , since  $n \geq 7$ .  $\square$

Before stating our next property we need to define two graphs. The diamond and the bull are shown in Figure 1. For each of these two graphs the grey vertex is called the *head*.

**Property 2.7** Let  $G = (V, E)$  be a connected graph with  $n \geq 10$ . If  $G$  contains two vertex disjoint induced subgraphs  $H_1$  and  $H_2$  such that:

- $H_i$  is either a diamond or a bull with head  $h_i$ ,  $i = 1, 2$ ;
- the three vertices inducing the triangle containing the head are 3-vertices;
- any other vertex is a 2-vertex in  $G$ ;
- $h_1 h_2 \in E$ ;

then  $G$  is not expandable.

**Proof:** If  $H_1, H_2$  are two diamonds, then  $G$  is the graph shown in Figure 2, but  $n = 8$ . So we can suppose that  $H_1$  is a bull. There is a non-edge  $xy$  in  $H_1$  such that  $x$  is 3-vertex  $x \neq h_1$  and  $y$  is a 2-vertex. Then since  $H_2$  is a bull or a diamond,  $xy$  cannot be extended.  $\square$

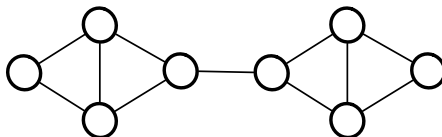

Figure 2: Two diamonds with  $h_1 h_2 \in E$ .

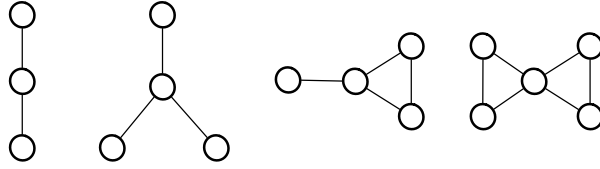

Figure 3:  $P_3$ , the claw, the paw, the butterfly (from left to right).

### 3 Meg(n) for $3 \leq n \leq 9$

We will compute  $Exp_2(n)$  for small values of  $n$ .

- $Exp_2(3) = 2$ : Trivially  $P_3$  the path on three vertices (Figure 3) is a  $meg(3)$ .
- $Exp_2(4) = 4$ : The paw (see Figure 3) is expandable. If  $G = (V, E)$  is a  $meg(4)$  with  $|E| < 4$ , then from Property 2.1  $G$  is a tree. So  $G$  is either  $P_4$  or the claw. None of those is expandable.
- $Exp_2(5) = 6$ : The butterfly (see Figure 3) is expandable. Suppose there is  $G = (V, E)$  a  $meg(5)$  with  $m \leq 5$ . From Property 2.2,  $\delta(G) \geq 2$ . So  $G = C_5$  which is not expandable.

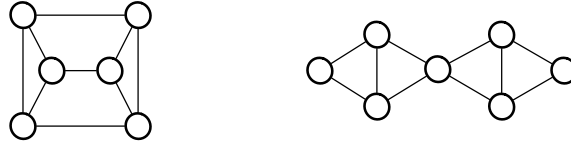

Figure 4:  $G_6$  and  $G_7$  two minimal expandable graphs with 6 and 7 vertices.

- $Exp_2(6) = 9$ : The graph  $G_6$  (see Figure 4) is expandable. Following Fact 2.1 it is sufficient to suppose that there is  $G = (V, E)$  an expandable graph with  $|E| = 8$ . If  $G$  has a leaf, then from Property 2.2  $|E| \geq 9$ , a contradiction. So  $\delta(G) \geq 2$ . Let  $n_2$  be the number of 2-vertices. We have  $2 \leq n_2 \leq 4$ .  
 Let  $n_2 = 2$ . Let  $d(v_i) = 2, 1 \leq i \leq 2$  and  $d(v_i) = 3, 3 \leq i \leq 6$ . Suppose that  $v_1v_2 \in E$ . W.l.o.g.  $v_1v_3, v_2v_4 \in E$ . If  $v_3v_4 \notin E$ , then  $v_3v_4$  cannot be extended. So  $v_3v_4 \in E$ . W.l.o.g.  $v_3v_5, v_4v_6 \in E$  but  $v_5, v_6$  cannot be 3-vertices. So  $v_1v_2 \notin E$ . If  $v_i \in N(v_1) \cap N(v_2)$ , then  $v_i$  is universal by Property 2.6, which is impossible. Thus w.l.o.g.  $N(v_1) = \{v_3, v_4\}, N(v_2) = \{v_5, v_6\}$ . So  $G[V - \{v_1, v_2\}] = C_4$ . W.l.o.g.  $v_3v_4, v_5v_6, v_3v_5, v_4v_6 \in E$ , but  $v_3v_6 \notin E$  cannot be extended.  
 Let  $n_2 = 3$ . W.l.o.g.  $d(v_1) = d(v_2) = d(v_3) = 2, d(v_4) = d(v_5) = 3, d(v_6) = 4$ . We have  $|N(v_6) \cap \{v_1, v_2, v_3\}| \geq 2$ , so  $v_6$  is universal a contradiction.  
 Let  $n_2 = 4$ . W.l.o.g.  $d(v_1) = d(v_2) = d(v_3) = d(v_4) = 2$ . If  $d(v_5) = d(v_6) = 4$ , then  $|N(v_6) \cap \{v_1, v_2, v_3, v_4\}| \geq 2$ , so  $v_6$  is universal a contradiction. So we have  $d(v_5) = 3, d(v_6) = 5$  but  $|N(v_5) \cap \{v_1, v_2, v_3, v_4\}| \geq 2$  and  $v_5$  is universal a contradiction.

- $Exp_2(7) = 10$ : The graph  $G_7$  (see Figure 4 ) is expandable. Following Fact 2.1 it is sufficient to suppose that there is  $G = (V, E)$  an expandable graph with  $|E| = 9$ . Since  $|E| < \frac{3}{2}n$ , from Property 2.2 we have  $\delta(G) \geq 2$ . Let  $n_2$  be the number of 2-vertices. From Property 2.6 two 2-vertices have no common neighbor, so  $n_2 \leq 3$ . If  $n_2 \leq 2$  we have  $|E| \geq 10$ . So  $n_3 = 3$ , w.l.o.g.  $v_1, v_2, v_3$  are the 2-vertices. Since  $|E| = 9$ , we have that  $v_4, v_5, v_6, v_7$  are 3-vertices. Using Property 2.6 again, w.l.o.g.  $v_1v_2, v_1v_4, v_2v_5, v_3v_6, v_3v_7 \in E$ . If  $v_6v_7 \notin E$  then  $v_4 \in N(v_6) \cap N(v_7)$  and from Property 2.4  $d(v_4) > 3$ , a contradiction. So  $v_6v_7 \in E$ , and w.l.o.g.  $v_4v_6, v_5v_7, v_4v_5 \in E$  but  $v_4v_7$  cannot be extended.

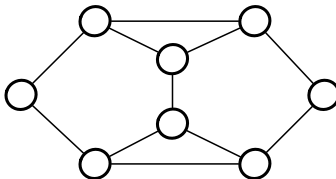

Figure 5: The graph  $G_8$  is a  $meg(8)$ .

- $Exp_2(8) = 11$ : One can check that  $G_8$  (see Figure 5) or the graph shown in Figure 2 are expandable. Following Fact 2.1 it is sufficient to suppose that there is  $G = (V, E)$  an expandable graph with  $|E| = 10$ . From Properties 2.2 and 2.6  $\delta(G) \geq 2$  and each 2-vertex has at least one proper neighbor of degree at least three. Thus there are at most four 2-vertices. Since  $|E| = 10$ , there are four 2-vertices, says  $v_1, v_2, v_3, v_4$ , and four 3-vertices  $v_5, v_6, v_7, v_8$  each of them linked to exactly one 2-vertex. W.l.o.g.  $v_1v_2, v_3v_4, v_1v_5, v_2v_6, v_3v_7, v_4v_8 \in E$ . From Property 2.4  $v_5v_6, v_7v_8 \notin E$ . So  $v_5v_7, v_5v_8, v_6v_7, v_6v_8 \in E$ , but  $v_5v_6$  cannot be extended.

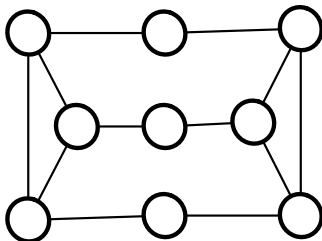

Figure 6: The graph  $G_9$  is a  $meg(9)$ .

- $Exp_2(9) = 12$ : One can check that  $G_9$  (see Figure 6) is expandable. Following Fact 2.1 it is sufficient to suppose that there is  $G = (V, E)$  an expandable graph with  $|E| = 11$ . Property 2.2 implies that  $\delta(G) \geq 2$  so there are at least five 2-vertices. From Property 2.6 each 2-vertex has a proper neighbor of degree at least three, which is impossible.

## 4 A lower bound for $Exp_2(n)$ , $n \geq 10$

We will first derive a lower bound of  $Exp_2(n)$  for  $n \geq 10$ . It will be shown in the next section that it is best possible.

**Lemma 4.1** *If  $G = (V, E)$  with  $n \geq 10$  is expandable, then  $m \geq \lceil \frac{11}{8}n \rceil$ .*

**Proof:** From Property 2.1  $G$  is connected. Since  $n \geq 10$ , we have  $\lceil \frac{3n-1}{2} \rceil \geq \lceil \frac{11}{8}n \rceil$ . If there is a 1-vertex then from Property 2.2,  $m \geq \frac{3}{2}n$ . If there is a universal vertex, then from Property 2.3,  $m \geq \lceil \frac{3n-1}{2} \rceil$ . If  $\delta(G) \geq 3$ , then  $m \geq \frac{3}{2}n$ . If two 2-vertices have a common neighbor, then from Property 2.6,  $m \geq \frac{3}{2}n$ .

So from now on we examine the case where  $\delta(G) = 2$ , there is no universal vertex and the following condition.

**Cond. 4.2** *For any two 2-vertices  $u, v$  we have  $N_G(u) \cap N_G(v) = \emptyset$ .*

Let  $W = \{v \in V : d(v) = 2\}$ . If  $|W| = 1$  then  $m \geq \lceil \frac{3n-1}{2} \rceil$ . So we assume now that  $|W| \geq 2$ . Let  $W_1 = \{v \in W : N_G(v) \cap W \neq \emptyset\}$  that is the subset of 2-vertices adjacent to another 2-vertex.

We will use a discharging procedure where a weight  $w(v)$  is assigned to every vertex  $v \in V$ . At each step of the process some  $w(v)$ 's are modified but  $\sum_{v \in V} w(v) = \sum_{v \in V} d(v)$  is invariant during the procedure. At the beginning we take  $w(v) = d(v)$  for every vertex  $v \in V$ . We will show that at the end of the procedure  $w(v) \geq \frac{11}{4}$  for every vertex  $v \in V$ , so when the procedure will be completed we will have  $\sum_{v \in V} w(v) = \sum_{v \in V} d(v) = 2m \geq 3n - \lfloor \frac{n}{4} \rfloor = \lceil \frac{11}{4}n \rceil$ .

We treat the vertices according to the following sequence of four steps 1, ..., 4. At the beginning the vertices with  $w(v) < \frac{11}{4}$  are 2-vertices. During the procedure these vertices are charged while  $k$ -vertices,  $k \geq 3$ , are discharged. At each step a 2-vertex  $v$  with  $w(v) < \frac{11}{4}$  is charged and  $u$  ( $u \neq v$ ) is defined as a 2-vertex such that  $d(v, u) = \min\{d(v, x) : x \in W\}$ . Notice that from Cond. 4.2 we have  $d(v, u) \neq 2$ . The vertices of  $W_1$  are treated in step 1. The vertices of  $W \setminus W_1$  are treated in steps 2, 3, 4. Let  $N(v) = \{v', v''\}$  and  $N(u) = \{u', u''\}$ .

1. For all  $v \in W_1$  ( $d(v, u) = 1$ ): Let  $u = v'$ . If  $d(v'') \geq 4$ , let  $w(v) \leftarrow w(v) + \frac{3}{4} = \frac{11}{4}$  and  $w(v'') \leftarrow w(v'') - \frac{3}{4}$ . Else  $N_G(v'') = \{v, y, y'\}$  with  $u \neq y, y'$ . Let  $w(v) \leftarrow w(v) + \frac{3}{4} = \frac{11}{4}$  and  $w(v'') \leftarrow w(v'') - \frac{1}{4}$ ,  $w(y) \leftarrow w(y) - \frac{1}{4}$ ,  $w(y') \leftarrow w(y') - \frac{1}{4}$ .
2. For all  $v \in W \setminus W_1$  ( $d(v, u) \geq 3$ ,  $d(v') \geq 3$  and  $d(v'') \geq 3$ ): Let  $w(v) \leftarrow w(v) + \frac{1}{2} = \frac{10}{4}$  and  $w(v') \leftarrow w(v') - \frac{1}{4}$ ,  $w(v'') \leftarrow w(v'') - \frac{1}{4}$ .
3. For all  $v \in W \setminus W_1$ :
  - If there is  $y \in N_G(v)$  such that  $d(y) \geq 4$ , let  $w(v) \leftarrow w(v) + \frac{1}{4} = \frac{11}{4}$  and  $w(y) \leftarrow w(y) - \frac{1}{4}$ ; (*Step 3.a*)
  - else



- if there is  $y$  such that  $d(v, y) = 2$  with  $d(y) \geq 5$  or  $d(y) = 4$  and  $N_G(y) \cap W_1 = \emptyset$ , let  $w(v) \leftarrow w(v) + \frac{1}{4} = \frac{11}{4}$  and  $w(y) \leftarrow w(y) - \frac{1}{4}$ ; (Step 3.b)
- else, let  $\mu = vv' \dots u'u$  be a shortest path between  $u$  and  $v$ : If  $d(v, u) \geq 4$ , let  $y \in N_G(v')$ ,  $y \in \mu$ . Let  $w(v) \leftarrow w(v) + \frac{1}{4} = \frac{11}{4}$  and  $w(y) \leftarrow w(y) - \frac{1}{4}$ . If  $d(v, u) = 3$ , let  $y \in N_G(v')$  with  $y \notin \mu$ . If  $d(y) \geq 4$  or  $d(y) = 3$  and  $w(y) = 3$ , let  $w(v) \leftarrow w(v) + \frac{1}{4} = \frac{11}{4}$  and  $w(y) \leftarrow w(y) - \frac{1}{4}$ . (Step 3.c)

4. For all  $v \in W \setminus W_1$  such that  $w(v) = \frac{10}{4}$ , let  $y$  be such that  $d(v, y) \leq 3$  and  $w(y) \geq 3$ : let  $w(v) \leftarrow w(v) + \frac{1}{4} = \frac{11}{4}$  and  $w(y) \leftarrow w(y) - \frac{1}{4}$ .

**Remark 4.1** Notice that there may be several 2-vertices  $u$  such that  $d(v, u) = \min\{d(v, x) : x \in W\}$ . We can choose any one.

We summarize the main facts of the procedure: After step 1 all vertices  $v \in W_1$  have a charge  $w(v) = \frac{11}{4}$ : it is important to note that from Properties 2.4 and 2.6, in the case where  $d(v'') = d(y) = d(y') = 3$ ,  $u$  cannot be adjacent to  $v'', y, y'$ . After step 3, a vertex  $v \in W \setminus W_1$  has a charge  $w(v) = \frac{11}{4}$  if there is  $x \in V$  verifying one of the following conditions:

- a)  $x$  is a  $k$ -vertex with  $k \geq 5$  and  $d(v, x) \leq 2$ ;
- b)  $x$  is a 4-vertex and  $d(v, x) = 1$ ;
- c)  $x$  is a 4-vertex,  $d(v, x) = 2$  and  $N_G(x) \cap W_1 = \emptyset$ .

Now we prove that when the discharging procedure is completed we have  $w(x) \geq \frac{11}{4}$  for every vertex  $x$  of  $G$ . First we prove that any vertex  $x$  with  $d(x) \geq 3$  has a charge  $w(x) \geq \frac{11}{4}$  at the end of the procedure. Then we prove that any 2-vertex  $x$  has a charge  $w(x) = \frac{11}{4}$  at the end of the procedure.

**Claim 4.1** At the end of step 3 any vertex  $x$  with  $d(x) \geq 3$  verifies  $w(x) \geq \frac{11}{4}$ . Moreover if  $d(x) \geq 5$  or  $d(x) \geq 4$  and  $N_G(x) \cap W = \emptyset$ , then  $w(x) \geq 3$ .

**Proof:** Let  $x$  be a discharged vertex. At the end of step 3,  $x$  was discharged only to charge 2-vertices at distance 1 or 2.

From Cond. 4.2,  $x$  has at most one 2-vertex in its neighborhood, and any neighbor of  $x$  has at most one 2-vertex in its own neighborhood so  $x$  has at most  $d(x)$  2-vertices at distance exactly 2.  $x$  sends a charge  $\frac{1}{4}$  or  $\frac{3}{4}$  to a neighbor, and/or a charge  $\frac{1}{4}$  to a 2-vertex at distance 2.

- $d(x) \geq 5$ . From above we have  $w(x) \geq 5 - (\frac{3}{4} + d(x)\frac{1}{4}) \geq 3$ .
- $d(x) = 4$ . Assume that  $N_G(x) \cap W = \emptyset$ . Since  $x$  sends a charge  $\frac{1}{4}$  to at most 4 2-vertices, we have  $w(x) \geq 4 - 4 \times \frac{1}{4} = 3$ .

Now  $N_G(x) \cap W \neq \emptyset$ . Let  $N_G(x) \cap W = \{v\}$ .

Assume that  $v \notin W_1$ .  $x$  sends a charge  $\frac{1}{4}$  to  $v$  at step 2 and another charge  $\frac{1}{4}$  at step 3.a. Moreover during steps 3.b and 3.c,  $x$  can send a charge  $\frac{1}{4}$  to a

2-vertex at distance 2: since  $v \notin W_1$ , there are at most  $d(x) - 1$  such 2-vertices. Thus we have  $w(x) \geq 4 - (2 \times \frac{1}{4} + 3 \times \frac{1}{4}) = \frac{11}{4}$ .

Now we assume that  $v \in W_1$ . Let  $x = v', u = v''$  with  $d(u) = 2$ . By step 1  $x$  sends a charge  $\frac{3}{4}$  to  $v$ . Moreover  $x$  can send a charge  $\frac{1}{4}$  to some 2-vertex  $z, z \neq u$ , with  $d(x, z) = 2$ . Assume that  $x$  charges three such 2-vertices. Let  $r, s, t$  be these vertices and  $r''r'r'x, s''s's'x, t''t't'x$  be the three corresponding paths. So  $N_G(x) = \{v, r', s', t'\}$  with  $d(r'), d(s'), d(t') \geq 3$ . From Cond. 4.2,  $r', s', t', r'', s'', t''$  are pairwise distinct. If  $d(r') \geq 4$  or  $d(r'') \geq 4$  then  $r$  is not charged from  $x$  and so  $w(x) \geq \frac{11}{4}$ . So we can assume that  $d(r') = 3$  and  $d(r'') \in \{2, 3\}$ . If  $d(r'') = 2$ , then from Cond. 4.2  $r'' \neq u$ , so  $r''r'r'xv$  is a 4-path between the 2-vertices  $r''$  and  $v$ , and by Property 2.5  $d(r') = 4$ , a contradiction. Thus  $d(r'') = d(s'') = d(t'') = 3$ , and  $r, s$  and  $t$  are not charged at step 1. Since  $r$  is charged by  $x$ , this can only be done at step 3.c (case  $d(v, u) = 4$ ): Here  $x$  plays the role of  $y$ , with  $d(x) = 3$  and  $w(x) = 3$ , and  $r$  corresponds to  $v$  in the path  $\mu$ , also  $x \notin \mu$ . So  $\mu$  is a 3-path  $rr'z'z$  with  $z \in W$ . Since  $d(v) = 4$ ,  $z' \notin N_G(x)$ , i.e.,  $xz' \notin E$ . If  $z = u$ , then  $xz'$  cannot be extended. Thus there is a 4-path  $zz'r'xv$  and from Property 2.5  $d(r') \geq 4$ , a contradiction. So  $x$  charges  $v$  and at most two 2-vertices and thus  $w(x) \geq 4 - (\frac{3}{4} + 2(\frac{1}{4})) = \frac{11}{4}$ .

- $d(x) = 3$ . Assume that  $x$  charges two 2-vertices  $u$  and  $v$  at step 1. We have  $u, v \in W_1$  and since  $d(x) = 3$ ,  $u$  and  $v$  cannot be adjacent. So there are a 2-vertex  $s$  adjacent to  $u$  and a 2-vertex  $t$  adjacent to  $v$ . If  $x \in N_G(u)$ , then from Cond. 4.2  $d(v, x) = 2$ . Hence there is a path  $suxv'v$  with  $\{xv, xs, uv, uv', vs\} \notin E$  and by Cond. 4.2 again  $sv' \notin E$ . Thus  $suxv'v$  is a 4-path and by Property 2.5 we have  $d(x) \geq 4$ , a contradiction. It follows that  $d(u, x) = d(v, x) = 2$  and there is a path  $suu'xv'vt$ . By step 1  $u', v'$  are 3-vertices. If  $u'v' \notin E$  it cannot be extended, so  $u'v' \in E$ . But now  $uv'$  cannot be extended. Hence  $x$  charges at most one 2-vertex at step 1.

Assume that  $x$  charges a 2-vertex  $t$  at step 2 and a 2-vertex  $v$  at step 1. We have  $t \in W \setminus W_1, v \in W_1, t \in N_G(x)$  and from Cond. 4.2  $d(v, x) = 2$ . So there is a path  $uvv''xt$  with  $u \in W_1$ . From Cond. 4.2 it is a 4-path and by Property 2.5,  $d(v'') \geq 4$ . But from step 1  $x$  cannot charge  $v$ . So a vertex  $x$  cannot charge a 2-vertex in step 2 and a 2-vertex in step 1. By Cond. 4.2  $x$  charges at most one 2-vertex in step 2. It follows that  $x$  charges at most one 2-vertex in steps 1 and 2.

So before step 3 we have  $w(x) \geq \frac{11}{4}$ . Since  $d(x) = 3$ , during step 3,  $x$  can be discharged only if  $w(x) \geq 3$ . Thus after step 3 we have  $w(x) \geq \frac{11}{4}$ .

Hence after step 3 every vertex  $x$  with  $d(x) \geq 3$  has a charge  $w(x) \geq \frac{11}{4}$ . □

Since in step 4 a vertex  $x$  is discharged only if  $w(x) \geq 3$ , we have the following:

*At the end of the procedure any vertex  $x$  with  $d(x) \geq 3$  verifies  $w(x) \geq \frac{11}{4}$ .*

Now we consider the 2-vertices.

**Claim 4.2** *At the end of the procedure any vertex  $v \in W$  verifies  $w(v) = \frac{11}{4}$ .*

**Proof:** After step 1 the vertices  $v \in W_1$  satisfy  $w(v) = \frac{11}{4}$ .

Now let  $v \in W \setminus W_1$ . At the end of step 2 we have  $w(v) = \frac{10}{4}$ .

- $d(v, u) \geq 5$ . From **a), b), c)** if there exists  $x$  a  $k$ -vertex with  $k \geq 4$  and  $d(v, x) \leq 2$ , then we have  $w(v) = \frac{11}{4}$  after step 3.b. Else let  $y$  be defined as in step 3.c. Any 2-vertex is at distance at least three from  $y$ . So  $y$  is not discharged for another 2-vertex before the treatment of  $v$ . Thus  $w(y) = 3$  and step 3.c can be applied to  $v$  and then  $w(v) = \frac{11}{4}$ .
- $d(v, u) = 4$ . There is a 4-path  $vv'xu'u$  and  $x$  has no adjacent 2-vertex. From Property 2.5  $d(x) \geq 4$  and from **c)** we have  $w(v) = \frac{11}{4}$ .
- $d(v, u) = 3$ . From Step 3.a, if  $v$  has a neighbor  $y$  with  $d(y) \geq 4$  then  $w(v) = \frac{11}{4}$ . From now any neighbor of  $v$  is a 3-vertex. There is a path  $v''vv'u'uu''$  such that  $vv'u'u$  is a 3-path. From Cond. 4.2  $u', u'', v', v''$  are pairwise distinct. Let  $N_G(v') = \{v, u', x\}$ . If  $x = v''$ , then  $v''u'$  cannot be a non-edge else it cannot be extended, so  $v''u' \in E$  but the non-edge  $vu'$  cannot be extended, thus  $x \neq v''$ .

Assume that  $w(v) = \frac{10}{4}$  after step 3. From step 3.c,  $x$  is a 3-vertex and  $w(x) = \frac{10}{4}$ . Moreover  $v', v''$  are 3-vertices (from step 3.a),  $3 \leq d(u') \leq 4$  and if  $d(u') = 4$ , then  $N_G(u') \cap W_1 \neq \emptyset$  (from step 3.b).

We assume that there is a 2-vertex  $t \in N_G(x)$  ( $x$  may discharge for  $t$  in step 2). Let  $N_G(t) = \{x, t''\}$ . If  $xu'$  is a non-edge it cannot be extended. So  $xu' \in E$ .

Assume that  $d(u') = 3$ . If  $t = u$  then  $x = u''$  and  $v'u$  cannot be extended. Hence  $t \neq u$ . From Cond. 4.2  $t'' \neq u'', v''$ . We have  $v''u'', v''t'' \in E$ , else they cannot be extended. Moreover  $u''t'' \in E$  else it cannot be extended. Since  $n \geq 10$ , it exists  $y \notin \{v, v', v'', u, u', u'', x, t, t''\}$ . Since  $v''$  is a 3-vertex,  $yv'' \notin E$  but  $v''y$  cannot be extended.

Hence  $d(u') = 4$  and  $u \in W_1$ . Since  $t$  is a 2-vertex and  $d(v, t) = 3$ ,  $t$  can play the role of  $u$  in step 3.c., and  $u'$  the role of  $y$  (see Remark 4.1). Then  $w(v) = \frac{11}{4}$ , a contradiction.

So we have  $N_G(x) \cap W = \emptyset$ . Let  $N_G(x) = \{v', x', x''\}$ . We assume that a 2-vertex  $z, z \neq v$  is adjacent to  $x'$  or  $x''$ . W. l.o.g.  $z \in N_G(x')$ . Since  $v \notin W_1$ , we have that  $vz$  is a non-edge. From Cond. 4.2  $vx', v'z \notin E$  and since  $x \neq v''$ ,  $vx \notin E$ . If  $x' \neq u'$ , then  $v'x' \notin E$ ,  $vv'xx'z$  is a 4-path and by Property 2.5  $d(x) \geq 4$ , a contradiction. Thus  $x' = u'$ . Since  $x' \neq x''$ ,  $N(x'') \cap W = \emptyset$ , the 2-vertex  $z$  is unique and  $z = u$ . Moreover  $xu' \in E$ .

Since  $w(v) = \frac{10}{4}$ ,  $x$  has discharged  $\frac{1}{4}$  to  $u$ ,  $u$  being the unique 2-vertex apart  $v$  at distance 2 from  $x$ . It follows that  $u'$  is a 3-vertex, hence  $B = G[\{u, u', v, v', x\}]$  is a bull with  $x$  for head. Moreover  $w(u) = \frac{11}{4}$  and  $u$  is charged from  $x$ .

We assume that  $w(x') = \frac{11}{4}$ . From Claim 4.1  $x'$  is a 3-vertex and it exists a 2-vertex  $z$  such that  $d(z, x') = 2$ ,  $z$  is charged by  $x'$ . So there is a 2-path  $zz'x'$

with  $d(z') = 3$ . Since  $u$  is charged by  $x$  and  $w(v) = \frac{11}{4}$ , we have that  $z \neq u, v$ . From Cond. 4.2 we have  $z' \neq u'', v''$ . Since  $d(z') = 3$ , we have  $z'v'' \notin E$  or  $z'u'' \notin E$  but this non-edge cannot be extended.

So  $w(x') \geq 3$  after step 3. Since  $d(v, x') = 3$ , it follows that  $w(v) = \frac{11}{4}$  and  $w(x') = \frac{11}{4}$  after step 4. From Property 2.7  $x'$  cannot be the head of another bull  $B'$  with the same conditions as in  $B$ . Hence step 4 can be applied for every vertex  $v$  such that  $w(x) = \frac{10}{4}$  after step 3.

Hence the procedure terminates with  $w(v) = \frac{11}{4}$  for every 2-vertex. □

So after the procedure  $w(x) \geq \frac{11}{4}$  for every  $x \in V$ . □

## 5 Meg(n) for $n \geq 10$

### 5.1 A basic module

To build the minimum expandable graphs we define their components. Figure 7 gives the component  $\mathcal{H}$ .

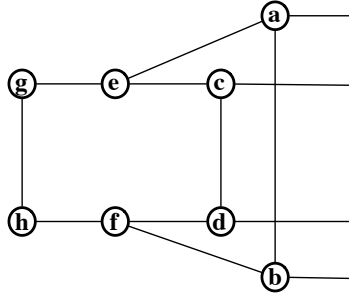

Figure 7: The subgraph  $\mathcal{H}$  with two 2-vertices and six 3-vertices.

The graph  $\mathcal{H}(2)$  is as follows (see Figure 8):  $\mathcal{H}(2)$  contains 2 copies  $\mathcal{H}_1, \mathcal{H}_2$  of  $\mathcal{H}$ . The vertices of  $\mathcal{H}_i$  are denoted by  $a_i, b_i, \dots, h_i, 1 \leq i \leq 2$ . The edges between  $\mathcal{H}_1$  and  $\mathcal{H}_2$  are  $a_1b_2, b_1a_2, c_1c_2, d_1d_2$ . Notice that since  $\mathcal{H}_2$  is a copy of  $\mathcal{H}_1$ , there are symmetries in  $\mathcal{H}(2)$ . In each module,  $a_i, c_i, e_i, g_i$  is symmetric to  $b_i, d_i, f_i, h_i$  and  $a_i$  (resp.  $b_i$ ) and  $c_i$  (resp.  $d_i$ ) play identical roles. As a consequence, if there is a 2-factor containing, for instance, the non-edge  $a_1f_1$  then, by *symmetry*, there is also a 2-factor containing  $c_1f_1$  as well as a 2-factor containing  $b_1e_1$  or  $d_1e_1, a_2f_2, b_2e_2, d_2e_2, c_2f_2$ . Also,  $a_1c_2$  plays the same role as  $a_1d_2$ .

The graph  $\mathcal{H}(p), p \geq 3$ , is built from  $\mathcal{H}(p-1)$  as follows (see Fig. 9): add one copy  $\mathcal{H}_p$  of  $\mathcal{H}$  to  $\mathcal{H}(p-1)$ . The vertices of  $\mathcal{H}_i = (\mathcal{V}_i, \mathcal{E}_i)$  are denoted by  $a_i, b_i, \dots, h_i, 1 \leq i \leq p$ . Remove the two edges  $b_1a_{p-1}$  and  $d_1d_{p-1}$  of  $\mathcal{H}(p-1)$ . Add the four edges  $b_1a_p, a_{p-1}b_p, d_1d_p, c_p d_{p-1}$ . The modules  $\mathcal{H}_i$  are arranged around a cycle and numbered clockwise from 1 to  $p$ . Notice that there is a symmetry on each side of  $\mathcal{H}_1$  between  $\mathcal{H}_i$  and  $\mathcal{H}_{p-i+2}$ , for  $i = 2, \dots, \lfloor p/2 \rfloor + 1$ . As for  $\mathcal{H}(2)$ ,  $a_i$  (resp.  $b_i$ ) and

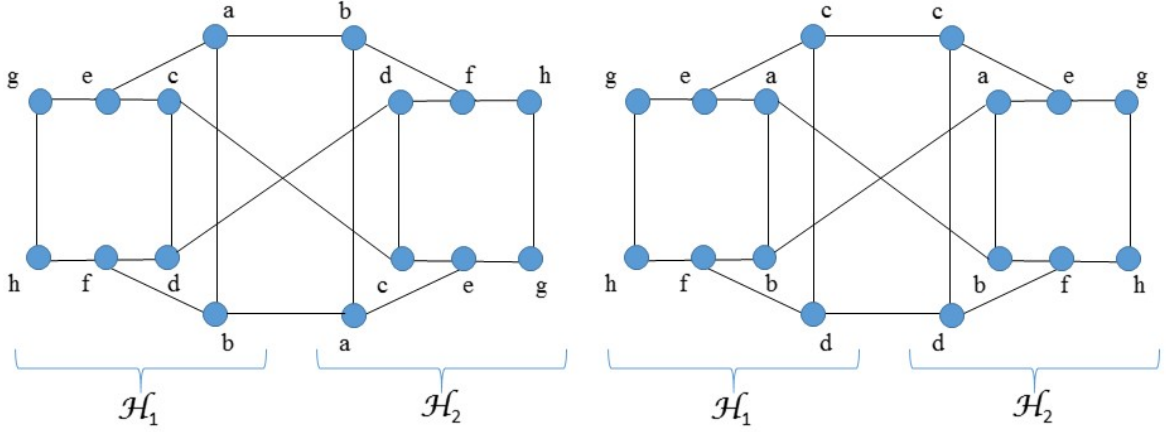

Figure 8: Two representations of  $\mathcal{H}(2)$ . (The vertices index are omitted).

$c_i$  (resp.  $d_i$ ) play identical roles: this can be seen by looking at Figure 9. If there is a 2-factor containing, for instance  $a_1f_2$ , then, there is also a 2-factor containing  $b_1f_5$  as well as a 2-factor containing  $c_1f_2$  or  $d_1f_5$ . Notice also that  $a_p b_1$  and  $d_p d_1$ , the two edges linking  $\mathcal{H}_p$  to  $\mathcal{H}_1$  play the same role.

In the following, we shall shorten many proofs by referring to all these properties as *symmetries*.

**Remark 5.1** *The graph  $\mathcal{H}_p$  has a 2-factor: for instance, take the cycle  $(a_1, b_2, a_2, \dots, a_p, b_1, a_1)$  and the  $p$  cycles  $(c_i, e_i, g_i, h_i, f_i, d_i, c_i)$ ,  $i = 1, \dots, p$ .*

**Remark 5.2** *The subgraph induced by  $\mathcal{V}_i \cup \mathcal{V}_{i+1}$ ,  $1 < i < p$ , is hamiltonian. A hamiltonian cycle is  $(a_i, b_i, f_i, h_i, g_i, e_i, c_i, d_i, c_{i+1}, d_{i+1}, f_{i+1}, h_{i+1}, g_{i+1}, e_{i+1}, a_{i+1}, b_{i+1}, a_i)$ .*

## 5.2 Meg(n) for $n = 8p$ , $p \geq 2$

We use a recurrence to prove that  $\mathcal{H}(p)$  is a  $meg(8p)$ .

**Property 5.1**  $\mathcal{H}(2)$  is a  $meg(16)$ .

**Proof:**  $\mathcal{H}(2)$  contains  $m = 22 = \lceil \frac{11}{8} \times 16 \rceil$  edges.

We show that  $\mathcal{H}(2)$  is expandable. Let  $xy \notin E$ . We give, first a chain  $(x, \dots, y)$ , and then, possibly, a set of cycles that provide a 2-factor of  $\mathcal{H}(2)$ .

- $xy = a_1c_1$ :  $(a_1, e_1, g_1, h_1, f_1, b_1, a_2, b_2, f_2, h_2, g_2, e_2, c_2, d_2, d_1, c_1)$ ; by symmetry  $b_1d_1, b_2d_2, a_2c_2$  can be extended;
- $xy = a_1d_1$ :  $(d_1, c_1, e_1, g_1, h_1, f_1, b_1, a_2, b_2, a_1), (d_2, c_2, e_2, g_2, h_2, f_2, d_2)$ ; by symmetry  $b_1c_1, b_2c_2, a_2d_2$  can be extended;

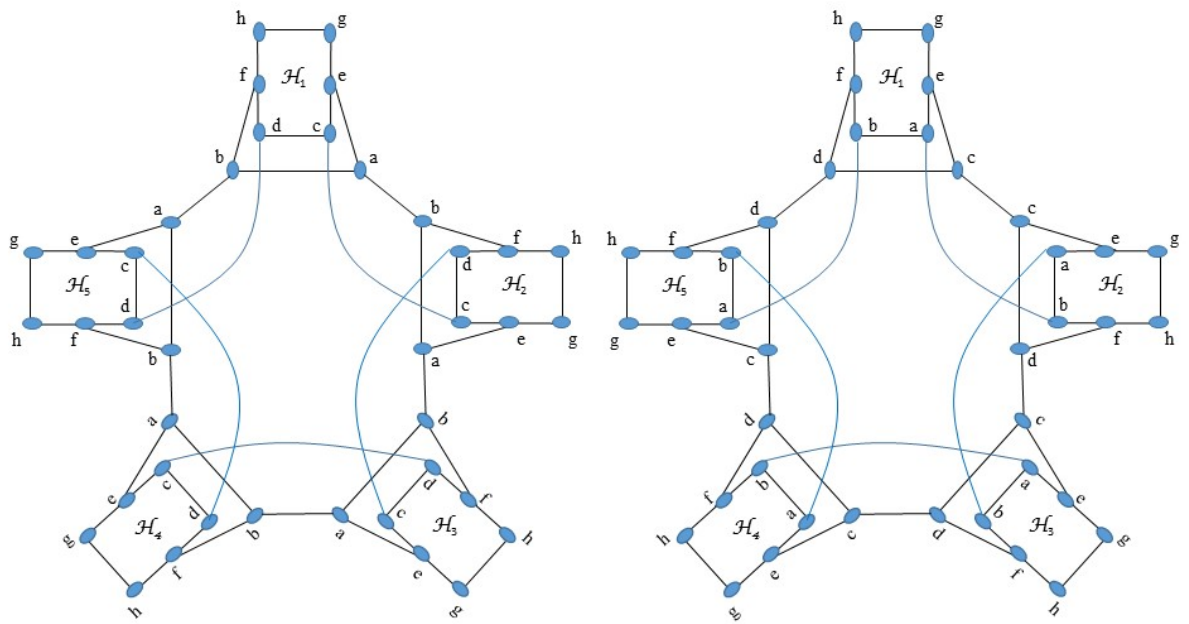

Figure 9: Two representation of  $\mathcal{H}(5)$ . (The vertex indices are omitted).

- $xy = a_1f_1$ :  $(f_1, h_1, g_1, e_1, c_1, d_1, d_2, c_2, e_2, g_2, h_2, f_2, b_2, a_2, b_1, a_1)$ ; by symmetry  $d_1e_1, c_1f_1, b_1e_1, c_2f_2, d_2e_2, a_2f_2, b_2e_2$  can be extended;
- $xy = a_1g_1$ :  $(g_1, h_1, f_1, b_1, a_2, b_2, f_2, h_2, g_2, e_2, c_2, d_2, d_1, c_1, e_1, a_1)$ ; by symmetry  $c_1g_1, b_1h_1, d_1h_1, b_2h_2, d_2h_2, a_2g_2, c_2g_2$  can be extended;
- $xy = a_1a_2$ :  $(a_2, b_1, f_1, h_1, g_1, e_1, c_1, d_1, d_2, c_2, e_2, g_2, h_2, f_2, b_2, a_1)$ ; by symmetry  $b_1b_2, c_1d_2, d_1c_2$  can be extended.
- $xy = a_1c_2$ :  $(c_2, d_2, d_1, c_1, e_1, g_1, h_1, f_1, b_1, a_2, e_2, g_2, h_2, f_2, b_2, a_1)$ ; by symmetry  $b_1d_2, b_1c_2, a_1d_2, b_2c_1, d_1b_2, a_2c_1, a_2d_1$  can be extended.
- $xy = d_1g_1$ :  $(g_1, h_1, f_1, b_1, a_2, b_2, a_1, e_1, c_1, c_2, e_2, g_2, h_2, f_2, d_2, d_1)$ ; by symmetry  $b_1g_1, c_1h_1, a_1h_1, c_2h_2, a_2h_2, d_2g_2, b_2g_2$  can be extended;
- $xy = e_1a_2$ :  $(e_1, g_1, h_1, f_1, b_1, a_1, b_2, f_2, h_2, g_2, e_2, a_2), (c_1, d_1, d_2, c_2, c_1)$ ; by symmetry  $b_2f_1, b_1f_2, a_1e_2, d_2e_1, c_2f_1, d_1e_2, c_1f_2$  can be extended;
- $xy = e_1b_2$ :  $(e_1, g_1, h_1, f_1, d_1, c_1, c_2, d_2, f_2, h_2, g_2, e_2, a_2, b_1, a_1, b_2)$ ; by symmetry  $a_2f_1, a_1f_2, b_1e_2, c_2e_1, d_2f_1, c_1e_2, d_1f_2$  can be extended;
- $xy = e_1f_1$ :  $(e_1, g_1, h_1, f_1), (a_1, b_1, a_2, e_2, g_2, h_2, f_2, b_2, a_1), (c_1, d_1, d_2, c_2, c_1)$ ; by symmetry  $e_2f_2$  can be extended;
- $xy = e_1d_2$ :  $(e_1, g_1, h_1, f_1, d_1, c_1, c_2, d_2), (a_1, b_1, a_2, e_2, g_2, h_2, f_2, b_2, a_1)$ ; by symmetry  $a_2e_1, c_2f_1, b_2f_1, c_1f_2, d_1e_2, a_1e_2, b_1f_2$  can be extended;
- $xy = e_1f_2$ :  $(e_1, g_1, h_1, f_1, b_1, a_1, b_2, a_2, e_2, g_2, h_2, f_2), (c_1, d_1, d_2, c_2, c_1)$ ; by symmetry  $e_1e_2, f_1f_2, e_2f_1$  can be extended;
- $xy = e_1h_2$ :  $(e_1, g_1, h_1, f_1, d_1, c_1, c_2, d_2, f_2, b_2, a_1, b_1, a_2, e_2, g_2, h_2)$ ; by symmetry  $e_1g_2, f_1h_2, f_1g_2, e_2g_1, f_2h_1, f_2g_1, e_2h_1$  can be extended;
- $xy = f_1g_1$ :  $(g_1, h_1, f_1), (b_1, a_1, e_1, c_1, d_1, d_2, c_2, e_2, g_2, h_2, f_2, b_2, a_2, b_1)$ ; by symmetry  $e_1h_1, f_2g_2, e_2h_2$  can be extended;
- $xy = g_1b_2$ :  $(g_1, h_1, f_1, d_1, d_2, c_2, c_1, e_1, a_1, b_1, a_2, e_2, g_2, h_2, f_2, b_2)$ ; by symmetry  $c_2g_1, a_2h_1, d_2h_1, a_1h_2, d_1h_2, b_1g_2, c_1g_2$  can be extended;
- $xy = g_1d_2$ :  $(g_1, h_1, f_1, d_1, d_2), (a_1, e_1, c_1, c_2, e_2, g_2, h_2, f_2, b_2, a_2, b_1, a_1)$ ; by symmetry  $a_2g_1, c_2h_1, b_2h_1, c_1h_2, b_1h_2, d_1g_2, a_1g_2$  can be extended;
- $xy = g_1h_2$ :  $(g_1, h_1, f_1, d_1, d_2, f_2, b_2, a_2, b_1, a_1, e_1, c_1, c_2, e_2, g_2, h_2)$ ; by symmetry  $g_1g_2, h_1h_2, h_1g_2$  can be extended;

□

**Property 5.2**  $\mathcal{H}(3)$  is a meg(24).

**Proof:**  $\mathcal{H}(3)$  contains  $m = 33 = \lceil \frac{11}{8} \times 24 \rceil$  edges.

We show that  $\mathcal{H}(3)$  is expandable. Let  $xy \notin E$ .

Case 1.  $x, y \notin \mathcal{H}_3$ . Looking at the 2-factors given for  $\mathcal{H}(2)$ , we observe that they all contain at least one of the two edges  $b_1a_2, d_1d_2$  and then we can build a 2-factor containing  $xy$  in  $\mathcal{H}(3)$  from a 2-factor  $F$  containing  $xy$  in  $\mathcal{H}(2)$ . If  $b_1a_2 \in F$  and  $d_1d_2 \notin F$ , we substitute  $b_1a_2$  for  $b_1a_3b_3a_2$  and we add the cycle  $(c_3, d_3, f_3, h_3, g_3, e_3, c_3)$  to obtain a 2-factor in  $\mathcal{H}(3)$ . The case  $b_1a_2 \notin F$  and  $d_1d_2 \in F$  is symmetric. If  $b_1a_2 \in F$  and  $d_1d_2 \in F$ , we substitute  $b_1a_2$  for  $b_1a_3b_3a_2$  and  $d_1d_2$  for  $d_1d_3f_3h_3g_3e_3c_3d_2$  to obtain a 2-factor in  $\mathcal{H}(3)$ .

Case 2.  $x, y \notin \mathcal{H}_2$ : by symmetry this is equivalent to Case 1.

Case 3.  $x \in \mathcal{H}_2, y \in \mathcal{H}_3$ . For each  $xy$ , we give, first a chain  $(x, \dots, y)$ , and then, possibly, a set of cycles that provide a 2-factor of  $\mathcal{H}(3)$ .

- $xy = a_2a_3$ :  $(a_2, b_3, f_3, h_3, g_3, e_3, a_3); (a_1, b_1, f_1, h_1, g_1, e_1, c_1, d_1, d_3, c_3, d_2, c_2, e_2, g_2, h_2, f_2, b_2, a_1)$ ; by symmetry  $b_2b_3, d_2d_3, c_2c_3$  can be extended;
- $xy = a_2c_3$ :  $(a_2, b_3, a_3, e_3, g_3, h_3, f_3, d_3, d_1, c_1, e_1, g_1, h_1, f_1, b_1, a_1, b_2, f_2, h_2, g_2, e_2, c_2, d_2, c_3)$ ; by symmetry  $d_2b_3$  can be extended;
- $xy = a_2d_3$ :  $(a_2, b_3, f_3, h_3, g_3, e_3, a_3, b_1, a_1, b_2, f_2, h_2, g_2, e_2, c_2, d_2, c_3, d_3), (c_1, d_1, f_1, h_1, g_1, e_1, c_1)$ ; by symmetry  $b_2c_3, c_2b_3, d_2a_3$  can be extended;
- $xy = a_2e_3$ :  $(a_2, b_3, a_3, b_1, a_1, b_2, f_2, h_2, g_2, e_2, c_2, d_2, c_3, d_3, f_3, h_3, g_3, e_3), (c_1, d_1, f_1, h_1, g_1, e_1, c_1)$ ; by symmetry  $f_2b_3, d_2f_3, e_2c_3$  can be extended;
- $xy = a_2f_3$ :  $(a_2, b_3, a_3, e_3, g_3, h_3, f_3), (a_1, b_1, f_1, h_1, g_1, e_1, c_1, d_1, d_3, c_3, d_2, c_2, e_2, g_2, h_2, f_2, b_2, a_1)$ ; by symmetry  $e_2b_3, f_2c_3, d_2e_3$  can be extended;
- $xy = a_2g_3$ :  $(a_2, b_3, a_3, e_3, c_3, d_2, c_2, e_2, g_2, h_2, f_2, b_2, a_1, b_1, f_1, h_1, g_1, e_1, c_1, d_1, d_3, f_3, h_3, g_3)$ ; by symmetry  $h_2b_3, g_2c_3, d_2h_3$  can be extended;
- $xy = a_2h_3$ :  $(a_2, b_3, f_3, d_3, c_3, d_2, c_2, e_2, g_2, h_2, f_2, b_2, a_1, b_1, a_3, e_3, g_3, h_3), (c_1, d_1, f_1, h_1, g_1, e_1, c_1)$ ; by symmetry  $g_2b_3, h_2c_3, d_2g_3$  can be extended;
- $xy = b_2a_3$ :  $(b_2, f_2, h_2, g_2, e_2, a_2, b_3, f_3, h_3, g_3, e_3, a_3), (c_1, d_1, d_3, c_3, d_2, c_2, c_1), (a_1, b_1, f_1, h_1, g_1, e_1, a_1)$ ; by symmetry  $c_2d_3$  can be extended;
- $xy = b_2d_3$ :  $(b_2, a_2, b_3, a_3, b_1, a_1, e_1, g_1, h_1, f_1, d_1, c_1, c_2, e_2, g_2, h_2, f_2, d_2, c_3, e_3, g_3, h_3, f_3, d_3)$ ; by symmetry  $c_2a_3$  can be extended;
- $xy = b_2e_3$ :  $(b_2, a_2, b_3, a_3, b_1, a_1, e_1, g_1, h_1, f_1, d_1, c_1, c_2, e_2, g_2, h_2, f_2, d_2, c_3, d_3, f_3, h_3, g_3, e_3)$ ; by symmetry  $f_2a_3, e_2d_3, c_2f_3$  can be extended;
- $xy = b_2f_3$ :  $(b_2, a_1, e_1, g_1, h_1, f_1, b_1, a_3, b_3, a_2, e_2, g_2, h_2, f_2, d_2, c_2, c_1, d_1, d_3, c_3, e_3, g_3, h_3, f_3)$ ; by symmetry  $e_2a_3, f_2d_3, c_2e_3$  can be extended;
- $xy = b_2g_3$ :  $(b_2, a_1, e_1, g_1, h_1, f_1, b_1, a_3, e_3, c_3, d_3, d_1, c_1, c_2, d_2, f_2, h_2, g_2, e_2, a_2, b_3, f_3, h_3, g_3)$ ; by symmetry  $h_2a_3, g_2d_3, c_2h_3$  can be extended;
- $xy = b_2h_3$ :  $(b_2, a_2, b_3, f_3, d_3, c_3, d_2, f_2, h_2, g_2, e_2, c_2, c_1, d_1, f_1, h_1, g_1, e_1, a_1, b_1, a_3, e_3, g_3, h_3)$ ; by symmetry  $g_2a_3, h_2d_3, c_2g_3$  can be extended;



- $xy = e_2e_3$ :  $(e_2, g_2, h_2, f_2, b_2, a_2, b_3, a_3, b_1, a_1, e_1, g_1, h_1, f_1, d_1, c_1, c_2, d_2, c_3, d_3, f_3, h_3, g_3, e_3)$ ; by symmetry  $f_2f_3$  can be extended;
- $xy = e_2f_3$ :  $(e_2, g_2, h_2, f_2, d_2, c_2, c_1, d_1, d_3, c_3, e_3, g_3, h_3, f_3)$ ;  $(a_1, e_1, g_1, h_1, f_1, b_1, a_3, b_3, a_2, b_2, a_1)$ ; by symmetry  $f_2e_3$  can be extended;
- $xy = e_2g_3$ :  $(e_2, g_2, h_2, f_2, b_2, a_2, b_3, a_3, e_3, c_3, d_2, c_2, c_1, d_1, d_3, f_3, h_3, g_3)$ ;  $(a_1, b_1, f_1, h_1, g_1, e_1, a_1)$ ; by symmetry  $h_2f_3, f_2h_3, g_2e_3$  can be extended;
- $xy = e_2h_3$ :  $(e_2, g_2, h_2, f_2, b_2, a_2, b_3, f_3, d_3, c_3, d_2, c_2, c_1, d_1, f_1, h_1, g_1, e_1, a_1, b_1, a_3, e_3, g_3, h_3)$ ; by symmetry  $g_2f_3, f_2g_3, h_2e_3$  can be extended;
- $xy = g_2g_3$ :  $(g_2, h_2, f_2, b_2, a_1, b_1, f_1, h_1, g_1, e_1, c_1, d_1, d_3, f_3, h_3, g_3)$ ,  $(a_2, e_2, c_2, d_2, c_3, e_3, a_3, b_3, a_2)$ ; by symmetry  $h_2h_3$  can be extended;
- $xy = g_2h_3$ :  $(g_2, h_2, f_2, b_2, a_1, b_1, a_3, e_3, g_3, h_3)$ ,  $(a_2, e_2, c_2, d_2, c_3, d_3, f_3, b_3, a_2)$ ,  $(c_1, d_1, f_1, h_1, g_1, e_1, c_1)$ ; by symmetry  $h_2g_3$  can be extended;

□

**Fact 5.1** *Let  $xy \notin \mathcal{H}(p)$ ,  $p \geq 3$ . If  $x, y \neq h_1$ , then any 2-factor containing  $xy$  contains  $a_p b_1$  or  $d_p d_1$ .*

**Proof:** Let  $F$  be a 2-factor containing  $xy$  and assume that none of  $a_p b_1$  and  $d_p d_1$  are in  $F$ . To cover  $b_1$  and  $d_1$ ,  $F$  must contain the edges  $b_1 a_1, b_1 f_1, d_1 c_1$  and  $d_1 f_1$ . Clearly these 4 edges cannot be completed in a 2-factor if  $x$  and  $y \neq h_1$ . □

**Property 5.3**  $\mathcal{H}(p)$  is a meg( $8p$ ),  $p \geq 4$ .

**Proof:**  $\mathcal{H}(p)$  contains  $m = 11p = \lceil \frac{11}{8} \times 8p \rceil$  edges.

The proof is by induction. From Properties 5.1 and 5.2,  $\mathcal{H}(2)$  and  $\mathcal{H}(3)$  are expandable. So for  $p \geq 3$  we assume that  $\mathcal{H}(p)$  and  $\mathcal{H}(p-1)$  are expandable.

We now prove that for any  $p \geq 3$ ,  $\mathcal{H}(p+1)$  is expandable.

Let  $xy \notin \mathcal{H}(p+1)$ . We examine several cases.

Case 1.  $x, y \notin \mathcal{V}_1 \cup \mathcal{V}_{p+1}$ . Let  $F$  be a 2-factor containing  $xy$  in  $\mathcal{H}(p)$ . From Fact 5.1,  $a_p b_1 \in F$  or  $d_p d_1 \in F$ . If  $F$  contains  $a_p b_1$  but not  $d_p d_1$ , then  $a_p b_1$  is replaced by  $a_p b_{p+1} a_{p+1} b_1$ ; adding the cycle  $(c_{p+1}, d_{p+1}, f_{p+1}, h_{p+1}, g_{p+1}, e_{p+1}, c_{p+1})$  we have a 2-factor in  $\mathcal{H}(p+1)$ . By symmetry, the case where  $d_p d_1 \in \mathcal{H}(p)$  and  $a_p b_1 \notin \mathcal{H}(p)$  is equivalent. If both  $a_p b_1$  and  $d_p d_1$  are in  $F$ , then  $a_p b_1$  is substituted for  $a_p b_{p+1} a_{p+1} b_1$  and  $d_p d_1$  for  $d_p c_{p+1} e_{p+1} g_{p+1} h_{p+1} f_{p+1} d_{p+1}, d_1$  to obtain a 2-factor in  $\mathcal{H}(p+1)$ .

Case 2.  $x \in \mathcal{V}_1$ .

Case 2.1.  $y \notin \mathcal{V}_p \cup \mathcal{V}_{p+1}$ . From our assumption  $xy$  can be extended in  $\mathcal{H}(p-1)$ . If the 2-factor in  $\mathcal{H}(p-1)$  contains  $a_{p-1} b_1$  but not  $d_{p-1} d_1$ , then  $a_{p-1} b_1$  is substituted

for  $a_{p-1}b_p a_p b_{p+1} a_{p+1} b_1$ ; adding the two cycles  $(c_j, d_j, f_j, h_j, g_j, e_j, c_j)$ ,  $p \leq j \leq p+1$ , we have a 2-factor in  $\mathcal{H}(p+1)$ . By symmetry, the case where the 2-factor in  $\mathcal{H}(p-1)$  contains  $d_{p-1}d_1$  but not  $a_{p-1}b_1$  is equivalent. If both  $a_{p-1}b_1$  and  $d_{p-1}d_1$  are in the 2-factor of  $\mathcal{H}(p-1)$ , then  $a_{p-1}b_1$  is substituted for  $a_{p-1}b_p a_p b_{p+1} a_{p+1} b_1$  and  $d_{p-1}d_1$  for  $d_{p-1}c_p e_p g_p h_p f_p d_p c_{p+1} e_{p+1} g_{p+1} h_{p+1} f_{p+1} d_{p+1} d_1$  to obtain a 2-factor in  $\mathcal{H}(p+1)$ . Finally, if  $a_{p-1}b_1, d_{p-1}d_1 \notin F$ , we add to  $F$  the hamiltonian cycle on  $\mathcal{V}_{p+1} \cup \mathcal{V}_p$  (see Remark 5.2) to obtain a 2-factor in  $\mathcal{H}(p+1)$ .

Case 2.2.  $y \in \mathcal{V}_p \cup \mathcal{V}_{p+1}$ . By symmetry,  $y \in \mathcal{V}_{p+1}$  is equivalent to  $y \in \mathcal{V}_2$  and, if  $p \geq 4$ ,  $y \in \mathcal{V}_p$  is equivalent to  $y \in \mathcal{V}_3$  seen just before.

It remains the case  $p = 3$ ,  $y \in \mathcal{V}_3$ : we remove from  $\mathcal{H}(4)$  the modules  $\mathcal{H}_2$  and  $\mathcal{H}_4$  and we obtain  $\mathcal{H}'(2)$  isomorphic to  $\mathcal{H}(2)$ . Looking at the 2-factors obtained in  $\mathcal{H}(2)$  for  $xy \notin E$ ,  $x \in \mathcal{V}_1, y \in \mathcal{V}_2$ , we see that they all contain exactly three edges among  $a_1b_2, b_1a_2, c_1c_2, d_1d_2$ . Thus in  $\mathcal{H}'(2)$ , any 2-factor  $F$  containing  $xy \notin E$ ,  $x \in \mathcal{V}_1, y \in \mathcal{V}_3$  contains also exactly three edges among  $a_1b_3, b_1a_3, c_1c_3, d_1d_3$  or, equivalently, they all miss exactly one edge among  $a_1b_3, b_1a_3, c_1c_3, d_1d_3$ . To obtain a 2-factor in  $\mathcal{H}(4)$ , we make the following substitutions: if  $a_1b_3 \notin F$ , we replace  $c_1c_3$  by  $c_1c_2d_2c_3$ ,  $d_1d_3$  by  $d_1d_4c_4d_3$ ,  $b_1a_3$  by  $b_1a_4e_4g_4h_4f_4b_4a_3$  and we add the cycle  $(b_2, a_2, e_2, g_2, h_2, f_2, b_2)$ ; if  $b_1a_3 \notin F$ , we replace  $c_1c_3$  by  $c_1c_2d_2c_3$ ,  $d_1d_3$  by  $d_1d_4c_4d_3$ ,  $a_1b_3$  by  $a_1b_2f_2h_2g_2e_2a_2b_3$  and we add the cycle  $(a_4, e_4, g_4, h_4, f_4, b_4, a_4)$ ; if  $c_1c_3 \notin F$ , we replace  $b_1a_3$  by  $b_1a_4b_4a_3$ ,  $a_1b_3$  by  $a_1b_2a_2b_3$ ,  $d_1d_3$  by  $d_1d_4f_4h_4g_4e_4c_4d_3$  and we introduce the cycle  $(c_2, e_2, g_2, h_2, f_2, d_2, c_2)$ ; finally, if  $d_1d_3 \notin F$ , we replace  $b_1a_3$  by  $b_1a_4b_4a_3$ ,  $a_1b_3$  by  $a_1b_2f_2h_2g_2e_2a_2b_3$ ,  $c_1c_3$  by  $c_1c_2d_2c_3$  and we introduce the cycle  $(c_4, d_4, f_4, h_4, g_4, e_4, c_4)$ .

Case 3.  $x \in \mathcal{V}_{p+1}$ .

Case 3.1.  $y \in \mathcal{V}_i$ ,  $i \neq 2$ . If  $y \in \mathcal{V}_1$ , by symmetry, this is equivalent to the case  $x \in \mathcal{V}_1, y \in \mathcal{V}_{p+1}$  treated in Case 2.

If  $y \in \mathcal{V}_i$ ,  $i = 3, \dots, p-1$ , these cases are equivalent to cases  $x \in \mathcal{V}_2, y \in \mathcal{V}_{p-i+3}$  which were treated in Case 1.

If  $y \in \mathcal{V}_p$ , this is equivalent to  $x \in \mathcal{V}_2, y \in \mathcal{V}_3$  treated in Case 1.

If  $y \in \mathcal{V}_{p+1}$ , this is equivalent to  $x, y \in \mathcal{V}_2$  treated in Case 1.

Case 3.2  $y \in \mathcal{V}_2$ ,  $p \geq 4$ . There are two adjacent modules  $\mathcal{H}_i$  and  $\mathcal{H}_{i+1}$  with  $i \neq 2$  and  $i+1 \neq p+1$ . We remove these modules and add the edges  $a_{i-1}b_{i+2}$  and  $d_{i-1}c_{i+2}$ . We obtain a graph  $\mathcal{H}'(p-1)$  isomorphic to  $\mathcal{H}(p-1)$  which has a 2-factor  $F$  containing  $xy$  by assumption. If  $a_{i-1}b_{i+2} \in F$  but  $d_{i-1}c_{i+2} \notin F$ , then  $a_{i-1}b_{i+2}$  is substituted for  $a_{i-1}b_i a_i b_{i+1} a_{i+1} b_{i+2}$ ; adding the two cycles  $(c_j, d_j, f_j, h_j, g_j, e_j, c_j)$ ,  $i \leq j \leq i+1$ , we have a 2-factor in  $\mathcal{H}(p+1)$ . By symmetry, the case where  $d_{i-1}c_{i+2} \in F$  and  $a_{i-1}b_{i+2} \notin F$  is equivalent. If both  $a_{i-1}b_{i+2}$  and  $d_{i-1}c_{i+2}$  are in the 2-factor of  $\mathcal{H}'(p-1)$ , then  $a_{i-1}b_{i+2}$  is substituted for  $a_{i-1}b_i a_i b_{i+1} a_{i+1} b_{i+2}$  and  $d_{i-1}c_{i+2}$  for  $d_{i-1}c_i e_i g_i h_i f_i d_i c_{i+1} e_{i+1} g_{i+1} h_{i+1} f_{i+1} d_{i+1} c_{i+2}$  to obtain a 2-factor in  $\mathcal{H}(p+1)$ . Finally, if neither  $a_{i-1}b_{i+2}$  nor  $d_{i-1}c_{i+2}$  are in the 2-factor of  $\mathcal{H}'(p-1)$ , then adding the hamiltonian cycle covering  $\mathcal{V}_i \cup \mathcal{V}_{i+1}$  (see Remark 5.2) we obtain a 2-factor in  $\mathcal{H}(p+1)$ .

Case 3.3  $y \in \mathcal{V}_2$ ,  $p = 3$ ,  $x \in \mathcal{V}_4$ . We remove the module  $\mathcal{H}_3$  from  $\mathcal{H}(4)$  and add the edges  $a_2b_4$  and  $d_2c_4$ : we get a graph  $\mathcal{H}'(3)$  isomorphic to  $\mathcal{H}(3)$  in which  $xy$  can

be extended. Let  $F$  be a 2-factor of  $\mathcal{H}'(3)$  containing  $xy$ .

Looking at the 2-factors given for  $\mathcal{H}(3)$  to complete an edge  $xy \notin \mathcal{H}(3)$  with  $x \in \mathcal{V}_2$  and  $y \in \mathcal{V}_3$ , we see that they all contain  $a_2b_3$  or  $d_2c_3$ . Equivalently,  $F$  contains  $a_2b_4$  or  $d_2c_4$ .

If  $F$  contains  $a_2b_4$  but not  $d_2c_4$ , then  $a_2b_4$  is substituted for  $a_2b_3a_3b_4$ ; adding the cycle  $(c_3, d_3, f_3, h_3, g_3, e_3, c_3)$  we have a 2-factor in  $\mathcal{H}(4)$ . By symmetry, the case where  $\mathcal{H}'(3)$  contains  $d_2c_4$  but not  $a_2b_4$  is equivalent. If both  $a_2b_4$  and  $d_2c_4$  are in  $F$ , then  $a_2b_4$  is substituted for  $a_2b_3a_3b_4$  and  $d_2c_4$  for  $d_2c_3e_3g_3h_3f_3d_3c_4$  to obtain a 2-factor in  $\mathcal{H}'(4)$ .  $\square$

### 5.3 Meg(n) for $n \not\equiv 0 \pmod{8}$ , $n \geq 14$

Now, we give minimal expandable graphs when  $n \geq 14$  is not a multiple of 8. The graphs  $\mathcal{H}^{-1}(p), \mathcal{H}^{-2}(p), p \geq 2$ , are obtained from  $\mathcal{H}(p)$  by contracting one edge  $g_ih_i$ , respectively two edges  $g_ih_i, g_jh_j, i \neq j$ . The vertex resulting of the contraction of  $gh$  is denoted by  $gh$ .

**Property 5.4**  $\mathcal{H}^{-1}(p)$  is a  $meg(8p-1), p \geq 2$  and  $\mathcal{H}^{-2}(p)$  is a  $meg(8p-2), p \geq 2$ .

**Proof:**  $\mathcal{H}^{-1}(p)$  contains  $m = 11p - 1 = \lceil \frac{11}{8} \times (8p - 1) \rceil$  edges.  $\mathcal{H}^{-2}(p)$  contains  $m = 11p - 2 = \lceil \frac{11}{8} \times (8p - 2) \rceil$  edges.

From Properties 5.1 and 5.3 we have  $\mathcal{H}(p)$  is a  $meg(8p), p \geq 2$ . The 2-factor of  $\mathcal{H}^{-1}(p)$ , resp.  $\mathcal{H}^{-2}(p)$ , corresponds to the 2-factor of  $\mathcal{H}(p)$  where the subsequence of two consecutive vertices  $g, h$  in  $\mathcal{H}(p)$  is replaced by the contracted vertex  $gh$  in  $\mathcal{H}^{-1}(p)$ , resp.  $\mathcal{H}^{-2}(p)$ .  $\square$

The graph  $\mathcal{H}^{+1}(p), p \geq 2$ , is obtained from  $\mathcal{H}(p)$  by adding a 2-vertex  $i$  and the two edges  $ig, ih$  to  $\mathcal{H}(p)$ .

**Property 5.5**  $\mathcal{H}^{+1}(p)$  is a  $meg(8p+1), p \geq 2$ .

**Proof:**  $\mathcal{H}^{+1}(p)$  contains  $m = 11p + 2 = \lceil \frac{11}{8} \times (8p + 1) \rceil$  edges.

Observe that all 2-factors of  $\mathcal{H}(p)$  contain  $gh$ . Let  $xy \notin E$ . If  $x, y \neq i_1$ , then the 2-factor of  $\mathcal{H}^{+1}(p)$  corresponds to the 2-factor of  $\mathcal{H}(p)$  where  $g_1h_1$  in  $\mathcal{H}(p)$  is replaced by  $g_1i_1h_1$  in  $\mathcal{H}^{+1}(p)$ . If  $x = i_1$ , then  $gy \notin E$  or  $hy \notin E$ . W.l.o.g. assume that  $gy \notin E$ . Then the 2-factor of  $\mathcal{H}^{+1}(p)$  corresponds to the 2-factor of  $\mathcal{H}(p)$  where  $h_1g_1$  in  $\mathcal{H}(p)$  is replaced by  $h_1i_1g_1$  in  $\mathcal{H}^{+1}(p)$ .  $\square$

The graph  $\mathcal{H}^{+2}(p)$  is obtained from  $\mathcal{H}(p)$  as follows: the two edges  $a_1e_1, c_1e_1$  are subdivided into the paths  $(a_1, i, e_1), (c_1, j, e_1)$ , respectively; the edge  $ij$  is added.

**Property 5.6**  $\mathcal{H}^{+2}(p)$  is a  $meg(8p+2), p \geq 2$ .

**Proof:**  $\mathcal{H}^{+2}(p)$  contains  $m = 11p + 3 = \lceil \frac{11}{8} \times (8p + 2) \rceil$  edges.

We show that  $\mathcal{H}^{+2}(p)$  is expandable. Let  $xy \notin E$ . In the case where  $x, y \notin \{a_1, c_1, e_1\}$  we proceed as follows: we know that  $xy$  can be extended in  $\mathcal{H}(p)$ ; the corresponding 2-factor contains either the subsequence  $a_1e_1c_1$ , or  $a_1e_1g_1$  or  $c_1e_1g_1$ . In

the first case the subsequence is substituted for  $a_1ie_1jc_1$ , in the second for  $a_1ije_1g_1$ , in the third for  $c_1jie_1g_1$ . So  $xy$  can be extended in  $\mathcal{H}^{+2}(p)$ .

Now let  $x = i$  (the case where  $x = j$  is similar). If  $y \neq c_1, g_1$ , we know that  $e_1y$  can be extended in  $\mathcal{H}(p)$ ; the corresponding 2-factor contains  $e_1g_1$ ; we replace it by  $ije_1g_1$ . If  $y = c_1$  (resp.  $y = g_1$ ): in  $\mathcal{H}(p)$ , the 2-factor corresponding to the non-edge  $g_1c_1$  (resp.  $g_1a_1$ ) contains  $c_1e_1a_1$ ; we replace it by  $c_1je_1ia_1$ .

If  $y = g_1$ : in  $\mathcal{H}(p)$ , the 2-factor corresponding to the non-edge  $g_1a_1$  contains  $c_1e_1a_1$ ; we replace it by  $c_1je_1ia_1$ .

So  $iy$  can be extended in  $\mathcal{H}^{+2}(p)$ .

Now let  $x = e_1$ . We know that  $g_1y$  can be extended in  $\mathcal{H}(p)$ ; the corresponding 2-factor contains both  $g_1h_1$  and  $a_1e_1c_1$  (or  $c_1e_1a_1$ , but by symmetry this case is the same). We substitute the first subsequence for  $e_1g_1h_1$  and the second for  $a_1ijc_1$  and  $e_1y$  can be extended in  $\mathcal{H}^{+2}(p)$ .  $\square$

The graph  $\mathcal{H}^{+3}(p), p \geq 2$ , is obtained from  $\mathcal{H}(p)$  by adding a triangle  $(i, j, k)$  and the two edges  $ia_1, ja_1$  to  $\mathcal{H}(p)$ .

**Property 5.7**  $\mathcal{H}^{+3}(p)$  is a meg( $8p + 3$ ),  $p \geq 2$ .

**Proof:**  $\mathcal{H}^{+3}(p)$  contains  $m = 11p + 5 = \lceil \frac{11}{8} \times (8p + 3) \rceil$  edges.

Let  $xy \notin E$ . If  $x, y \notin \{i, j, k\}$ , then the 2-factor of  $\mathcal{H}^{+3}(p)$  corresponds to the 2-factor of  $\mathcal{H}(p)$  plus the cycle  $(i, j, k, i)$ .

Let  $x = i$  (the case  $x = j$  is the same): note that  $y \notin \{i, j, k, a_1\}$ . Suppose first that  $y$  is not a neighbor of  $a_1$  in  $\mathcal{H}(p)$ :  $ya_1$  can be extended to a 2-factor and substituting  $ya_1$  for  $yikja_1, (i = x)$ , we have a 2-factor for  $\mathcal{H}^{+3}(p)$ . Now let  $y = e_1$ . We know that  $e_1f_1$  can be extended in  $\mathcal{H}(p)$ . The corresponding 2-factor contains  $(e_1g_1h_1f_1e_1)$  and a cycle  $C$  with the edge  $a_1b_1$ . Substituting  $a_1b_1$  for  $a_1jkie_1g_1h_1f_1b_1$  we have a 2-factor of  $\mathcal{H}^{+3}(p)$ . Let  $y \in \{b_1, b_2\}$ ;  $e_1f_1$  can be extended in  $\mathcal{H}(p)$ , and the corresponding 2-factor contains  $(e_1, g_1, h_1, f_1, e_1)$ , a cycle  $C$  with the edges  $a_1b_1$  and  $a_1b_2$ , and a cycle  $C'$  with the edge  $c_1d_1$ . So replacing  $a_1y$  by  $a_1jkiiy$  and  $c_1d_1$  by  $c_1e_1g_1h_1f_1d_1$  we have a 2-factor of  $\mathcal{H}^{+3}(p)$ .

For  $x = k$ , if  $y \neq a_1$  we proceed as above by replacing the sequence  $ikj$  by  $kij$ . If  $y = a_1$ , we do as follows: we know that  $g_1a_1$  can be extended in  $\mathcal{H}(p)$ ; the corresponding 2-factor contains  $e_1a_1g_1$ . Then substituting  $e_1a_1g_1$  for  $e_1g_1$  and adding  $(a_1, i, j, k, a_1)$  we obtain a 2-factor of  $\mathcal{H}^{+3}(p)$ .  $\square$

The graph  $\mathcal{H}^{+4}(p), p \geq 2$ , is obtained from  $\mathcal{H}(p)$  by adding a diamond  $(i, j, k, l), ij \notin E$  and the edge  $ia_1$  to  $\mathcal{H}(p)$ .

**Property 5.8**  $\mathcal{H}^{+4}(p)$  is a meg( $8p + 4$ ),  $p \geq 2$ .

**Proof:**  $\mathcal{H}^{+4}(p)$  contains  $m = 11p + 6 = \lceil \frac{11}{8} \times (8p + 4) \rceil$  edges.

Let  $xy \notin E$ . If  $x, y \notin \{i, j, k, l\}$ , then to obtain a 2-factor of  $\mathcal{H}^{+4}(p)$  we add the cycle  $(i, k, j, l, i)$  to the 2-factor of  $\mathcal{H}(p)$  obtained for the extension of  $xy$ .

For  $xy = ij$  we take a 2-factor covering  $\mathcal{H}(p)$  (see Remark 5.1) and the cycle  $(i, j, l, k, i)$  to obtain a 2-factor of  $\mathcal{H}^{+4}(p)$ .

Let  $x = i$ : we have  $y \notin \{i, j, k, l, a_1\}$ . First we suppose that  $y$  is not a neighbor of  $a_1$ . We know that  $ya_1$  can be extended in  $\mathcal{H}(p)$ , so in the corresponding 2-factor there is a cycle with the sequence  $ya_1$ . Substituting  $ya_1$  for  $ya_1$  and adding the cycle  $(j, k, l, j)$  we have a 2-factor for  $\mathcal{H}^{+4}(p)$ . Now let  $y = e_1$ : We know that  $e_1f_1$  can be extended in  $\mathcal{H}(p)$ . The corresponding 2-factor contains  $(e_1, g_1, h_1, f_1, e_1)$  and a cycle  $C$  with the edge  $a_1b_1$ . Substituting the sequence  $a_1b_1$  for  $a_1ie_1g_1h_1f_1b_1$  and adding  $(j, k, l, j)$  we have a 2-factor of  $\mathcal{H}^{+4}(p)$ . When  $y \in \{b_1, b_2\}$  we proceed as follows:  $e_1f_1$  can be extended in  $\mathcal{H}(p)$ , the corresponding 2-factor contains  $(e_1, g_1, h_1, f_1, e_1)$ , a cycle  $C$  with  $a_1y$ , and a cycle  $C'$  with  $c_1d_1$ . So substituting the sequence  $a_1y$  for  $a_1iy$ , the sequence  $c_1d_1$  for  $c_1e_1g_1h_1f_1d_1$  and adding  $(j, k, l, j)$  we have a 2-factor of  $\mathcal{H}^{+4}(p)$ .

Let  $x = k$  (resp.  $x = j$ ): We proceed as for  $x = i$  but instead of  $a_1i$  we take  $a_1iljk$  (resp.  $a_1ilkj$ ).  $\square$

The graph  $\mathcal{H}^{+5}(p)$ , is obtained from  $\mathcal{H}^{+2}(p)$  by subdividing the edge  $a_1b_1$  into the path  $a_1lk b_1$ , adding a 2-vertex  $r$  together with two edges  $rl, rk$ . See Figure 10.

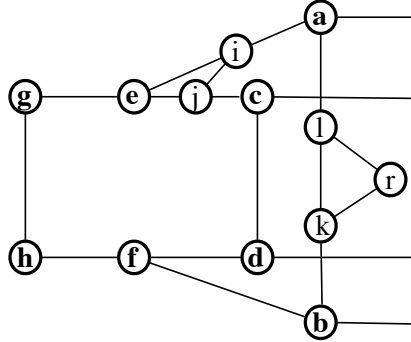

Figure 10: The graph  $\mathcal{H}^{+5}(p)$  is a  $meg(11p + 7)$ .

**Property 5.9**  $\mathcal{H}^{+5}(p)$  is a  $meg(8p + 5)$ .

**Proof:**  $\mathcal{H}^{+5}(p)$  contains  $m = 11p + 7 = \lceil \frac{11}{8} \times (8p + 5) \rceil$  edges.

From Property 5.6 we know that  $\mathcal{H}^{+2}(p)$  is expandable.

Let  $xy \notin E$ . If  $xy$  is also a non-edge of  $\mathcal{H}^{+2}(p)$  and the corresponding 2-factor contains  $a_1b_1$  then we substitute the sequence  $a_1b_1$  for  $a_1lrkb_1$ ; else if  $a_1b_1$  is not in the 2-factor, so we add the cycle  $(k, l, r, k)$  to the 2-factor. In both cases we obtain a 2-factor for  $\mathcal{H}^{+5}(p)$ .

Now let  $xy = a_1b_1$ :  $(a_1, b_2, a_2, b_3, a_3, \dots, b_p, a_p, b_1)$ ,  $(c_1, j, i, e_1, g_1, h_1, f_1, d_1, c_1)$ ,  $(c_i, e_i, g_i, h_i, f_i, d_i, c_i)$ ,  $2 \leq i \leq p$ , and  $(k, l, r, k)$  is a 2-factor.

Let  $x = k$  (the case  $x = l$  is symmetric). If  $y \neq a_1$ :  $a_1y$  can be extended in  $\mathcal{H}^{+2}(p)$ ; the corresponding 2-factor contains the path  $a_1 \dots y$ ; we substitute it for  $krla_1 \dots y$  and we have a 2-factor for  $\mathcal{H}^{+5}(p)$ . If  $y = a_1$ :  $(k, r, l, a_1)$ ,  $(c_1, d_1, d_p, c_p, d_{p-1}, c_{p-1}, \dots, d_2, c_2, e_2, g_2, h_2, f_2, b_2, a_2, b_3, f_3, h_3, g_3, e_3, a_3, b_4, f_4, h_4, g_4, e_4, a_4, \dots, b_p, f_p, h_p, g_p, e_p, a_p, b_1, f_1, h_1, g_1, e_1, i, j, c_1)$  is a 2-factor.

Let  $x = r$ . Remark that all 2-factors containing the non-edge  $ky$  contain also  $kr$ ; to extend  $ry$  we replace  $krla_1 \cdots y$  (resp.  $(k, r, l, a_1)$ ) by  $rkla_1 \cdots y$  (resp.  $(r, k, l, a_1)$ ) in the 2-factors above.  $\square$

## 5.4 Meg(n) for $10 \leq n \leq 13$

The constructions given in the previous sections do not cover the cases  $10 \leq n \leq 13$ . We give constructions for all the situations.

We start from the graph  $G_{10}$  shown in Figure 11. Note that  $G_{10}$  and  $G_{10} - a$  are hamiltonian.

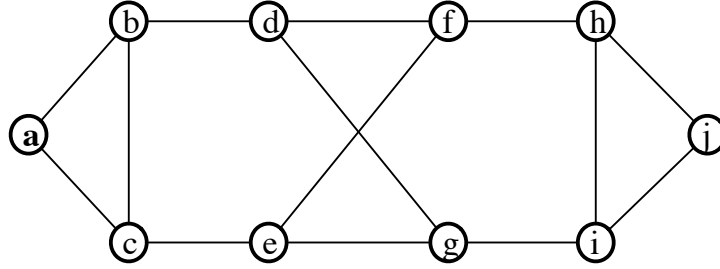

Figure 11: The graph  $G_{10}$  is a  $meg(10)$ .

**Property 5.10**  $G_{10}$  is a  $meg(10)$ .

**Proof:**  $G_{10}$  contains  $m = 14 = \lceil \frac{11}{8} \times 10 \rceil$  edges.

Let  $xy \notin E$ .

- $xy = ad$ :  $(a, b, c, e, f, h, j, i, g, d)$  yields a 2-factor; by symmetry  $ae, jf, jg$  can be extended;
- $xy = af$ :  $(a, b, c, e, g, d, f), (h, i, j, h)$  yields a 2-factor; by symmetry  $ag, jd, je$  can be extended;
- $xy = ah$ :  $(a, b, c, e, f, d, g, i, j, h)$  yields a 2-factor; by symmetry  $ai, jb, jc$  can be extended;
- $xy = aj$ :  $(a, b, c, e, f, d, g, i, h, j)$  yields a 2-factor;
- $xy = be$ :  $(b, a, c, e), (d, g, i, j, h, f, d)$  yields a 2-factor; by symmetry  $cd, hg, if$  can be extended;
- $xy = bf$ :  $(b, a, c, e, g, d, f), (h, i, j, h)$  yields a 2-factor; by symmetry  $cg, hd, ie, bg, cf, he, id$  can be extended;
- $xy = bh$ :  $(b, a, c, e, f, d, g, i, j, h)$  yields a 2-factor; by symmetry  $ci, bi, ch$  can be extended;

- $xy = de$ :  $(d, f, h, j, i, g, e), (a, b, c, a)$  yields a 2-factor; by symmetry  $fg$  can be extended.

□

The graph  $G_{11}$  shown in Figure 12 is obtained from  $G_{10}$  by the addition of the vertex  $k$ , the removal of  $dg, ef$  and the addition of  $dk, ek, fk, gk$  to  $E$ .

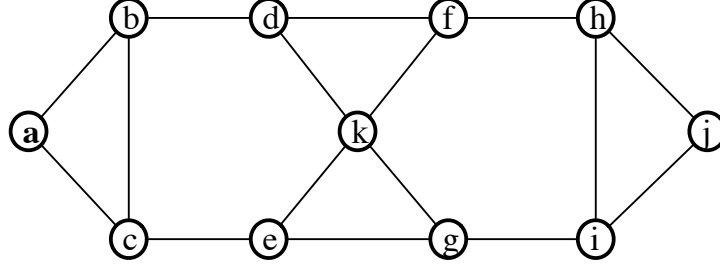

Figure 12: The graph  $G_{11}$  is a  $meg(11)$ .

**Property 5.11**  $G_{11}$  is a  $meg(11)$ .

**Proof:**  $G_{11}$  contains  $m = 16 = \lceil \frac{11}{8} \times 11 \rceil$  edges.

Let  $xy \notin E$ . If  $xy \notin \{dg, ef, kz \mid z \in \{a, \dots, j\}\}$  from Property 5.10  $xy$  can be extended to a 2-factor  $F$  in  $G_{10}$ . Since at least one of  $dg, ef, df, eg$  is an edge of  $F$ ,  $F$  can easily be modified to a 2-factor  $F'$  of  $G_{11}$  by replacing the edge by the 3-path passing through  $k$ .

- $xy = dg$ :  $(d, f, k, e, g), (a, b, c, a), (h, i, j, h)$  is a 2-factor; by symmetry  $ef$  can be extended;
- $xy = ak$ :  $(a, b, c, e, g, i, j, h, f, d, k)$  is a 2-factor; by symmetry  $jk$  can be extended;
- $xy = bk$ :  $(b, a, c, e, g, i, j, h, f, d, k)$  is a 2-factor; by symmetry  $ck, hk, ik$  can be extended.

□

The graph  $G_{12}$  shown in Figure 13 is obtained from  $G_{10}$  by the addition of the vertices  $k, l$ , the removal of  $dg, ef$  and the addition of  $dk, ek, fl, gl, kl$  to  $E$ .

**Property 5.12**  $G_{12}$  is a  $meg(12)$ .

**Proof:**  $G_{12}$  contains  $m = 17 = \lceil \frac{11}{8} \times 12 \rceil$  edges.

Let  $xy \notin E$ . If  $xy \notin \{dg, ef, kz, lz \mid z \in \{a, \dots, j\}\}$  from Property 5.10  $xy$  can be extended to a 2-factor  $F$  in  $G_{10}$ . Since at least one of  $dg, ef, df, eg$  is an edge of  $F$ ,  $F$  can easily be modified to a 2-factor  $F'$  of  $G_{12}$  by replacing the edge by the 4-path passing through  $k$  and  $l$ .

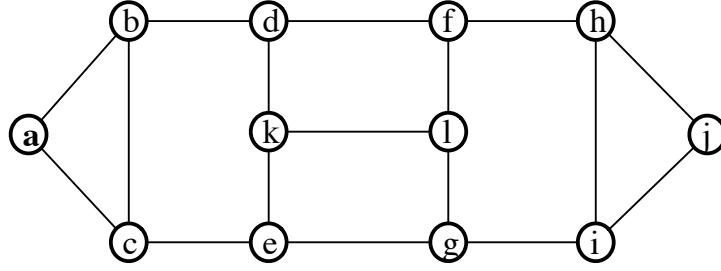

Figure 13: The graph  $G_{12}$  is a  $meg(12)$ .

- $xy = dg$ :  $(d, b, a, c, e, k, l, f, h, j, i, g)$  is a 2-factor; by symmetry  $ef$  can be extended;
- $xy = kf$ :  $(k, l, g, e, c, a, b, d, f), (h, i, j, h)$  is a 2-factor; by symmetry  $kg, dl, el$  can be extended;
- $xy = ka$ :  $(k, d, f, l, g, e, c, b, a), (h, i, j, h)$  is a 2-factor; by symmetry  $lj$  can be extended;
- $xy = kb$ :  $(k, d, f, l, g, e, c, a, b), (h, i, j, h)$  is a 2-factor; by symmetry  $kc, lh, li$  can be extended;
- $xy = kj$ :  $(k, l, g, e, c, a, b, d, f, h, i, j)$  is a 2-factor; by symmetry  $la$  can be extended;
- $xy = ki$ :  $(k, l, g, e, c, a, b, d, f, h, j, i)$  is a 2-factor; by symmetry  $kh, lb, lc$  can be extended.

□

The graph  $G_{13}$  shown in Figure 14 is obtained from  $G_{10}$  by the addition of the vertices  $k, l, o$ , the removal of  $ac$ .  $\{a, k, l, o\}$  induce the diamond with  $ao \notin E$ .

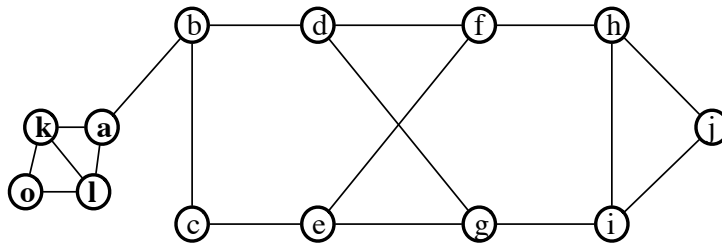

Figure 14: The graph  $G_{13}$  is a  $meg(13)$ .

**Property 5.13**  $G_{13}$  is a  $meg(13)$ .



**Proof:**  $G_{13}$  contains  $m = 18 = \lceil \frac{11}{8} \times 13 \rceil$  edges.

Let  $xy \notin E$ . If  $x, y \notin \{a, k, l, o\}$ , then we take  $F$  the corresponding 2-factor of  $G_{10}$ .  $F$  has  $bac$  as subsequence. Substituting  $bac$  for  $bc$  and adding  $(a, k, o, l, a)$  we have a 2-factor for  $G_{13}$ . If  $xy = ao$  then  $(a, k, l, o)$  and an hamiltonian cycle of  $G_{10} - a$  is a 2-factor for  $G_{13}$ .

Let  $x = a$ . If  $y \in \{d, f, h, j\}$  we know from Property 5.10 that there exists a 2-factor  $F$  for  $G_{10}$  which does not contain  $ac$ . So adding  $(k, l, o, k)$  we have a 2-factor for  $G_{13}$ .

- $y = c$ :  $(a, b, d, f, h, j, i, g, e, c), (k, l, o, k)$  is a 2-factor;
- $y = e$ :  $(a, b, c, e), (d, g, i, j, h, f, d), (k, l, o, k)$  is a 2-factor;
- $y = g$ :  $(a, b, c, e, f, d, g), (h, i, j, h), (k, l, o, k)$  is a 2-factor;
- $y = i$ :  $(a, b, c, e, g, d, f, h, j, i), (k, l, o, k)$  is a 2-factor.

Now when  $x \in \{k, l, o\}$  we use the 2-factors we obtained above for  $x = a$ : the first sequence begins with  $kola$  or  $loka$  or  $okla$  instead of  $a$ .  $\square$

## 6 Conclusion

We have determined the values of  $Exp_2(n)$  for all values of  $n$ . It could be interesting to characterize the  $meg(n)$ , for instance by a (finite ?) collection of forbidden induced subgraphs. Furthermore one could consider a generalization of the basic problem: the edges of a complete graph  $K_n$  are coloured in blue and in red. We want to color a minimal set of red edges in white so that any red edge  $uv$  can be extended to a 2-factor using only white edges. In our case, we had only white and red edges. Furthermore instead of just one red edge we could require that any appropriate subset of  $d$  red edges could be extended to a 2-factor by adding only white edges. More generally we could consider  $k$ -factors,  $k \geq 3$ , or even other structured set of edges.

**Acknowledgements:** The authors express their gratitude to the anonymous referee for its constructive comments and remarks, which helped to improve the readability and the correctness of this paper.

## References

- [1] B. Bai, H. Lu, Q. Yu, *Generalization of matching extensions in graphs (III)*, Discrete Applied Mathematics, 159-8 (2011) 727-732.
- [2] C. Berge, *Graphes*, Gauthier-Villars, (Paris, 1983).
- [3] J.A. Bondy, U. S. R. Murty, *Graph Theory*, Springer, (2008).
- [4] M.-C. Costa, D. de Werra, C. Picouleau, *Minimal graphs for matching extensions*, Discrete Applied Mathematics, 234 (2018) 47-55.

- [5] S. Grünewald, E. Steffen, *Independent sets and 2-factors in edge-chromatic-critical graphs*, Journal of Graph Theory, 45-2 (2004) 113-118.
- [6] A. Schrijver, *Combinatorial Optimization, Polyhedra and Efficiency*, Springer, (2003).
- [7] M.D. Plummer, *Extending matchings in graphs: A survey*, Discrete Mathematics, 127(1994) 277-292.
- [8] L. Lovász, M.D. Plummer, *Matching Theory*, Annals of discrete mathematics 29, North Holland, (1986).
- [9] J. Vandenbussche, D. B. West, *Extensions to 2-Factors in Bipartite Graphs*, The electronic Journal of Combinatorics, 20-3 (2013) Paper #P11.
- [10] X. Wang, Z. Zhang, Y. Lin, *Bipartite matching extendable graphs*, Discrete Mathematics, 308-23 (2008) 5334-5341.