



**HAL**  
open science

## A Novel Dual-Frequency Rectifier based on a 1800 Hybrid Junction for RF Energy Harvesting

Hakim Takhedmit, Laurent Cirio, Zied Saddi, Jean-Daniel Lan Sun Luk,  
Odile Picon

► **To cite this version:**

Hakim Takhedmit, Laurent Cirio, Zied Saddi, Jean-Daniel Lan Sun Luk, Odile Picon. A Novel Dual-Frequency Rectifier based on a 1800 Hybrid Junction for RF Energy Harvesting. 7th European Conference on Antennas and Propagation (EUCAP), Apr 2013, Gothenburg, Sweden. hal-02434887

**HAL Id: hal-02434887**

**<https://hal.science/hal-02434887>**

Submitted on 6 Feb 2021

**HAL** is a multi-disciplinary open access archive for the deposit and dissemination of scientific research documents, whether they are published or not. The documents may come from teaching and research institutions in France or abroad, or from public or private research centers.

L'archive ouverte pluridisciplinaire **HAL**, est destinée au dépôt et à la diffusion de documents scientifiques de niveau recherche, publiés ou non, émanant des établissements d'enseignement et de recherche français ou étrangers, des laboratoires publics ou privés.

# A Novel Dual-Frequency Rectifier based on a $180^\circ$ Hybrid Junction for RF Energy Harvesting

H. Takhedmit<sup>1</sup>, L. Cirio<sup>1</sup>, Z. Saddi<sup>1</sup>, J.D. Lan Sun Luk<sup>2</sup> and O. Picon<sup>1</sup>

<sup>1</sup> Université Paris-Est. ESYCOM (EA 2552), UPEMLV, ESIEE-Paris, CNAM, F.77454 Marne-la-Vallée, France, hakim.takhedmit@univ-mlv.fr

<sup>2</sup> Université de la Réunion. LE2P, EA4079, Faculté des sciences et technologies. 15, Avenue René Cassin – BP7151, Saint Denis, Ile de la Réunion 97715, France

**Abstract**—This paper reports the design and experimental characterization of a dual-band rectifier, based on a 3 dB  $180^\circ$  hybrid junction, and dedicated for electromagnetic energy harvesting. The proposed circuit achieves comparable performances at 1.8 and 2.45 GHz. DC output voltages higher than 900 mV and efficiencies more than 49 % were measured over a resistive load of 8.8 k $\Omega$  and for an RF input power of -10 dBm (100  $\mu$ W). The rectifier is powered by an RF signal including the two frequencies of interest.

**Index Terms**—dual-frequency rectifier; RF energy harvesting;  $180^\circ$  hybrid junction

## I. INTRODUCTION

The RF energy harvesting consists to capture and convert the ambient electromagnetic waves into useful electrical energy. The most important element of a harvesting system is called rectenna for rectifying antenna. It contains a receiving antenna, followed by an RF-to-dc conversion rectifier. Most systems reported in the literature operate on a single frequency band [1]. However, multi-band [2] and broadband [3] rectennas are also used to harvest a large amount of RF power.

The conversion circuit is strongly nonlinear. It usually contains one or several Schottky diodes. The impedance of the diode depends on the applied voltage, thus the RF input power. It is also frequency dependant. The main challenge of multi-band and broadband rectennas is the input impedance matching and the diode efficiency which are frequency dependant. One solution consists in using a radiating element and an RF-to-dc rectifier for each frequency band [4]. Multi-band matching networks [5]-[6] have been also be used.

In this paper, we propose a new topology of a dual band rectifier. The idea consists in separating the two frequencies coming from one antenna element using a 3 dB  $180^\circ$  hybrid junction [7]. These two signals are then rectified separately by two different structures.

## II. DESCRIPTION OF THE RECTIFIER

The proposed dual-frequency microwave rectifier is shown in Fig. 1. It is based on a 3 dB  $180^\circ$  hybrid junction, with comparable performances at 1.8 and 2.45 GHz frequency bands. This is made possible by adjusting the width of half of the ring. The different accesses of the circuit are denoted P-1 to

P-4. Ports 1 and 4 are referred as the sum and difference ports, respectively.

The designed rectifier has been simulated and optimized using ADS (Advanced Design System) software, by mixing Momentum electromagnetic and Harmonic Balance simulators.

The circuit is printed on Arlon 25N substrate ( $\epsilon_r = 3.4$ ,  $\tan\delta = 0.0025$  and  $h = 1.524$  mm). It contains 3 RF-to-dc rectifiers in series topology [8]. Rectifiers 1 and 3 operate at 1.8 GHz and the rectifier 2 operates at 2.45 GHz. All circuits are based on Skyworks SMS 7630 Schottky diodes and optimized separately to operate at -10 dBm (100  $\mu$ W) RF power level.

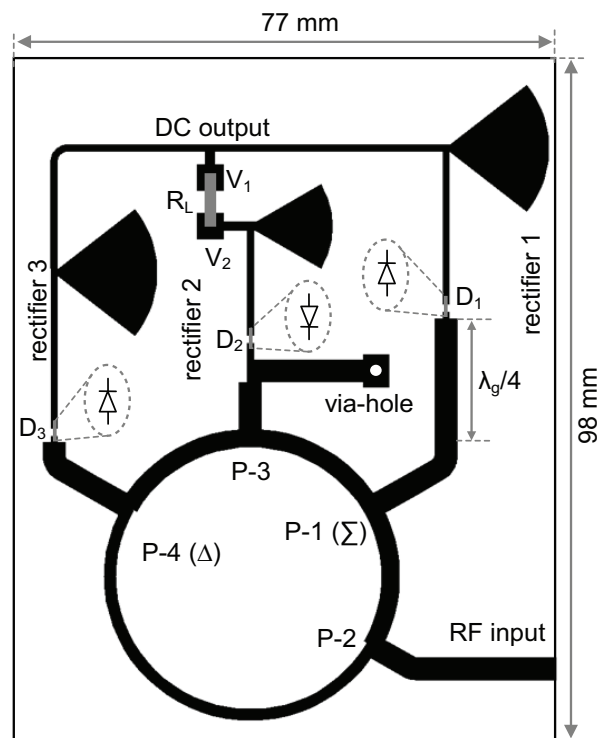

Figure 1. Layout of the dual-frequency microwave rectifier.

The original scattering matrix for the ideal 3 dB  $180^\circ$  hybrid junction has been modified by adding a quarter wavelength line ( $\lambda_g/4$  at 2.45 GHz) before rectifier 1 (Fig. 1). This gives the following form:

$$S = \frac{-j}{\sqrt{2}} \begin{bmatrix} 0 & -j & -j & 0 \\ -j & 0 & 0 & -1 \\ -j & 0 & 0 & 1 \\ 0 & -1 & 1 & 0 \end{bmatrix} \quad (1)$$

At 1.8 GHz, the RF power coming from the RF input (P-2) is equally split on ports P-1 and P-4 and converted by rectifiers 1 and 3. Rectifiers 1 and 3 have a good input matching level of -20 dB at 1.8 GHz and a strong mismatch ( $\sim -0.1$  dB) at 2.45 GHz.

Therefore, the 2.45 GHz RF power incoming from port P-2 is separated, reflected from rectifiers 1 and 3 and superimposed in phase on port P-3 due to the introduction of a quarter-wavelength line ( $\lambda_g/4$ ).

Consider that the  $a_i$  and  $b_i$  ( $i \in \{1, 2, 3, 4\}$ ) are the incident and reflected waves associated to the port  $i$  and  $\Gamma$  the reflection coefficient of rectifiers 1 and 3 at 2.45 GHz, thus:

$$a_1 = \Gamma b_1 \quad (2)$$

$$a_4 = \Gamma b_4 \quad (3)$$

From the scattering matrix (1) given above:

$$b_3 = -\frac{j}{\sqrt{2}}(-ja_1 + a_4) \quad (4)$$

Substituting (2) and (3) in (4), we obtain:

$$b_3 = -\frac{j}{\sqrt{2}}(-j\Gamma b_1 + \Gamma b_4) \quad (5)$$

From (1),  $b_1$  and  $b_4$  can be expressed as function of  $a_2$  and  $a_3$ . Equation (5) can be rewritten as:

$$b_3 = \left(-\frac{j}{\sqrt{2}}\right)^2 [-j\Gamma(-ja_2 - ja_3) + \Gamma(-a_2 + a_3)] \quad (6)$$

and finally:

$$b_3 = \Gamma a_2 \quad (7)$$

As both rectifiers 1 and 3 are mismatched at 2.45 GHz ( $|\Gamma| \approx 1$ ), almost all of the incident power from the port 2 is transmitted to port 3, at the frequency of interest.

To improve the dc output power and voltage, series and parallel rectifiers interconnections [9] were combined. The short-circuit quarter wavelength stub connected to the rectifier

2 is introduced to measure the dc voltage relative to the ground plane. It has no useful purpose for differential measurements.

Figure 2 depicts the simulated power budget, including the RF-to-dc conversion efficiency, the total losses in diodes and the reflection losses. These entities are expressed as a percentage of the total input RF power. The circuit is powered by an RF signal including the two frequencies  $f_1 = 1.8$  GHz and  $f_2 = 2.45$  GHz, balanced in power ( $P_{RF1} = P_{RF2}$ ). The output load is set to be optimal ( $R_L = 8.8$  k $\Omega$ ). It is clearly shown that the conversion efficiency increases with the input power between -20 and -6 dBm. However, losses in diodes ( $D_1$  to  $D_3$ ) decreases in the same power range. For input power level above to -6 dBm, the efficiency drops sharply. This is due to the reverse breakdown voltage of the Schottky diodes which limit the RF power level to be converted.

The reflection losses are less than 10% over the power range. They represent less than 1.5% around -10 dBm ( $P_{RF1} = P_{RF2} = -10$  dBm). This shows that the proposed rectifier is well matched around the power level for which it was optimized. The sum of all other losses are depicted in fig.2, it includes the insertion losses, the input and output high harmonics losses ...

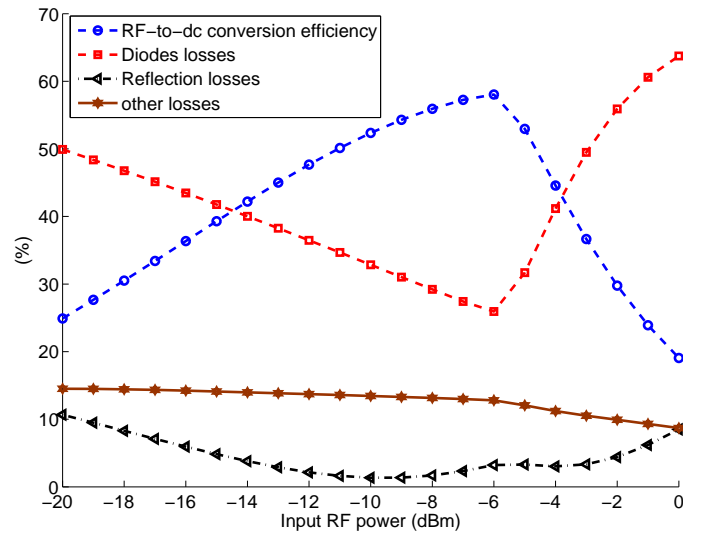

Figure 2. Power budget versus input RF power: efficiency, diodes losses and reflection losses

### III. EXPERIMENTAL CHARACTERIZATION

The reported structure was fabricated and measured. Measurements of the input return loss ( $S_{11}$ ) against frequency and the output dc voltage ( $V_{dc} = V_1 - V_2$ ) against frequency and RF power were made. The results are presented and discussed.

Figure 3 depicts the simulated and measured input return loss versus frequency between 1 and 3 GHz. The RF input power level and output load are set to be -10 dBm and 2 k $\Omega$ , respectively. ADS simulations show impedance matching levels of -24 dB at 1.8 GHz and -10 dB at 2.45 GHz. Measurements show a good impedance matching level at 1.8 GHz ( $S_{11} = -13$  dB) and a frequency shift of about 100 MHz at

2.45 GHz. An input return loss of -18 dB has been measured at 2.35 GHz.

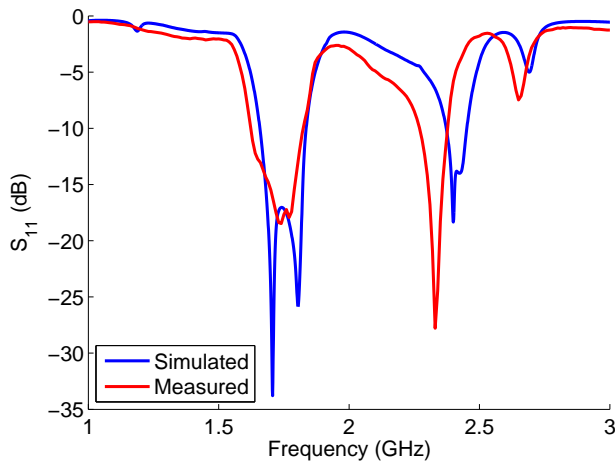

Figure 3. Simulated and measured input return loss versus frequency

The measurement setup is shown in Fig.4. It contains two RF sources ( $f_1$ ) and ( $f_2$ ), a power combiner, an hybrid coupler and a spectrum analyzer. A conventional voltmeter is used to read the output dc voltage ( $V_{dc} = V_1 - V_2$ ). Two kinds of measurements were performed. Measurements with a single frequency, where only one RF source was used ( $f_1$  or  $f_2$ ) and measurements with two frequencies, where the circuit is powered by a signal including frequencies  $f_1$  and  $f_2$ .

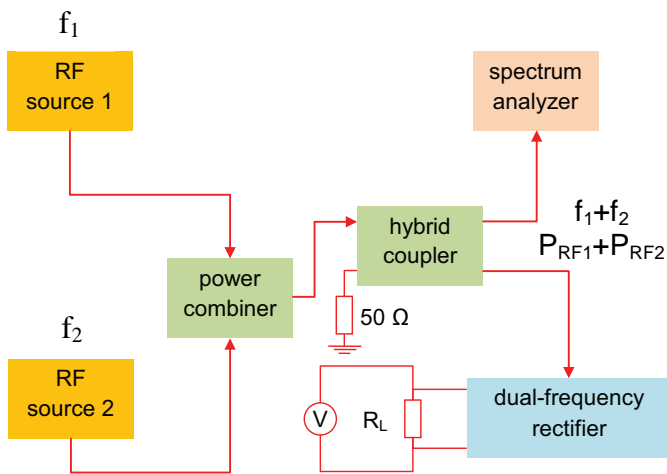

Figure 4. Measurement setup

Figure 5 depicts the measured output voltage and conversion efficiency as a function of the frequency from 1.5 to 3 GHz. This figure shows close results in both frequency bands around 1.8 and 2.45 GHz. These measurements were performed by setting the RF input power to -10 dBm and by varying the frequency. The optimal output load  $R_L$  was set to be 2 k $\Omega$ . Output dc voltages greater than 250 mV and

efficiencies higher than 30% have been achieved for the center frequencies.

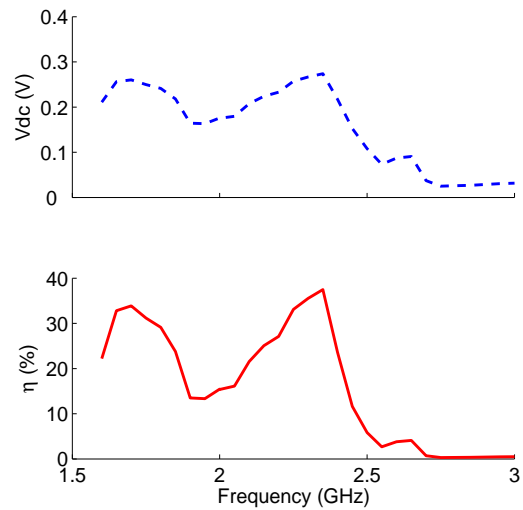

Figure 5. Measured output dc voltage and conversion efficiency against frequency

Figure 6 shows the measured output dc voltage and efficiency against input power from -20 to 0 dBm. Previously presented results show a frequency shift relative to the center frequencies, due to fabrication and measurement tolerances. Measurements at 1.75 and 2.35 GHz, where maximum performances have been obtained, were performed and results are illustrated in Fig. 6. For an input power level of 0 dBm, output dc voltages of 964 mV ( $\eta = 46.5\%$ ) and 990 mV ( $\eta = 49\%$ ) were measured at 1.8 and 1.75 GHz, respectively. Similarly, output dc voltages of 763 mV ( $\eta = 29.1\%$ ) and 1032 mV ( $\eta = 53.2\%$ ) were achieved at 2.45 and 2.35 GHz.

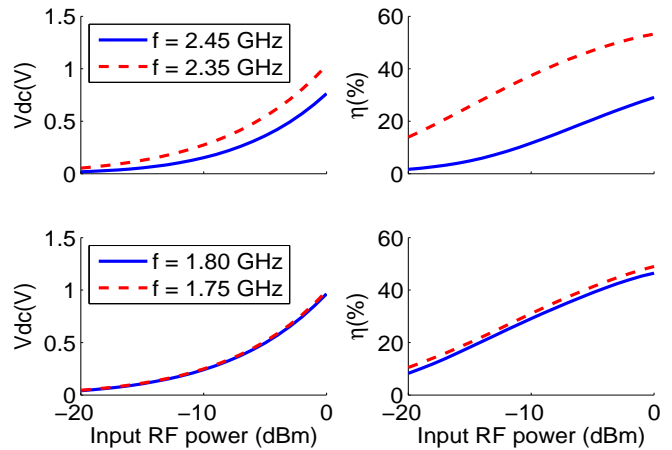

Figure 6. Measured output dc voltage and conversion efficiency versus input RF power level

Figure 7 compares the ADS simulated and measured output dc voltages and efficiencies against frequency. The circuit is powered by a signal including the two frequencies  $f_1$  and  $f_2$ , one fixed and the other varies. The RF power ( $P_{RF1} = P_{RF2}$ ) and

the output load are set to be -10 dBm and 8.8 k $\Omega$ , respectively. The shapes of the simulated and measured curves are similar.

An output dc voltage of 959 mV and a conversion efficiency of 52.2% were obtained by simulation for  $f_1 = 1.8$  GHz and  $f_2 = 2.45$  GHz. However, because of the frequency shift observed at 2.45 GHz band, the optimum measured performances are obtained for  $f_1 = 1.8$  GHz and  $f_2 = 2.35$  GHz. an output dc voltage of 932 mV and an efficiency of 49.4% have been measured. For  $f_2 = 2.45$  GHz, the circuit performances are lower ( $V_{dc} = 743$  mV and  $\eta = 31.4\%$ ).

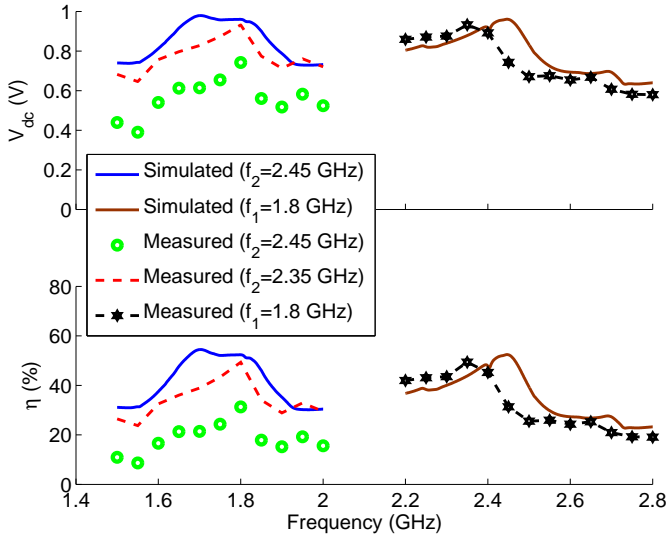

Figure 7. Simulated and measured output dc voltage and efficiency against frequency

Figure 8 depicts a comparison between simulated and experimentally obtained output dc voltage and efficiency versus input RF power. The low frequency  $f_1$  and the output resistive load are set to be 1.8 GHz and 8.8 k $\Omega$ , respectively.

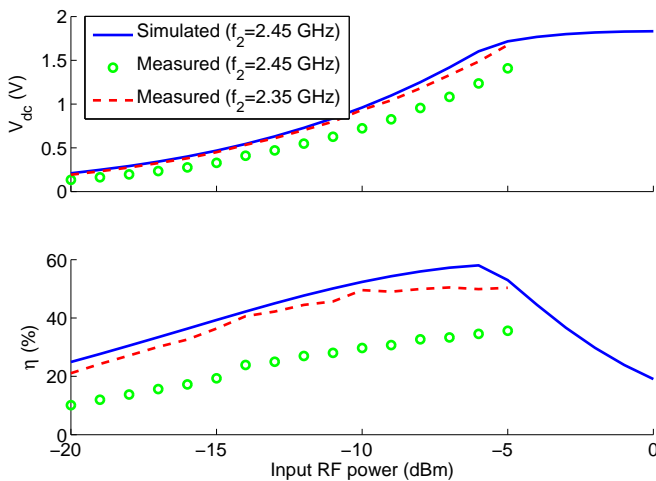

Figure 8. Simulated and measured output dc voltage and efficiency against input RF power

The shapes of simulated and measured curves are similar. The measured curve for  $f_2 = 2.35$  GHz is very close to that simulated for  $f_2 = 2.45$  GHz. This can be explained by the frequency shift, previously observed, at higher frequency band.

Efficiencies of 24.9% ( $V_{dc} = 209$  mV) and 52.9% ( $V_{dc} = 1716$  mV) have been simulated at -20 and -5 dBm. Comparable results were measured for  $f_2 = 2.35$  GHz. for the same power levels, efficiencies of 21.1% ( $V_{dc} = 192$  mV) and 50% ( $V_{dc} = 1674$  mV) were measured.

#### IV. CONCLUSION

In this paper, we have proposed a new low power dual-frequency rectifier at 1.8 and 2.45 GHz, based on a modified 180° hybrid junction and dedicated for RF energy harvesting. The circuit shows comparable performances in both frequency bands. More than 900 mV and 49 % output dc voltage and conversion efficiency were measured over an optimal resistive load of 8.8 k $\Omega$  and an input power of -10 dBm for each frequency. Higher voltages close to 1.8 V have also been achieved when increasing the RF power to -5 dBm.

#### REFERENCES

- [1] Y. J. Ren and K. Chang, "5.8-GHz Circularly Polarized Dual-Diode Rectenna and Rectenna Array for Microwave Power Transmission," *IEEE Trans. Microw. Theory and Tech.*, vol. 54, no. 4, pp. 1495-1502, Apr. 2006.
- [2] A. Costanzo, F. Donzelli, D. Mazotti and V. Rizzoli, "Rigorous Design of RF Multi-resonator Power Harvesters", *EuCAP 2010*, Barcelona, Spain, April 12-16, 2010, pp. 1-4.
- [3] J. A. Hagerty, F. B. Helmbrecht, W. H. McCalpin, R. Zane and Z. Popovic, "Recycling Ambient Microwave Energy with Broad-Band Rectenna Arrays", *IEEE Trans. On Microwave Theory and Techniques*, vol. 52, no. 5, May 2003, pp. 1548-1553;
- [4] J. Heikkinen and M. Kivikovski, "A novel Dual-Frequency Circularly Polarized Rectenna", *IEEE Antennas and Wireless Propag. Letters*, vol. 2, no. 1, pp. 330-333, 2003.
- [5] Y.-J. Ren, M. F. Farooqui and K. Chang, "A Compact Dual-Frequency Rectifying Antenna with High-Order Harmonic-Rejection," *IEEE Trans. On Antennas and Propag.*, vol. 55, no. 7, pp. 2110-2113, 2007.
- [6] Y.-H. Suh and K. Chang, "A High-Efficiency Dual-Frequency Rectenna for 2.45- and 5.8-GHz Wireless Power Transmission," *IEEE Trans. On Microw. and Tech.*, vol. 50, no. 7, pp. 1784-1789, 2002.
- [7] David M. Pozar, *Microwave Engineering*, 2<sup>nd</sup> edition, John Wiley & Sons, Inc., pp. 351-421.
- [8] H. Takhedmit, L. Cirio, S. Bellal, D. Delcroix and O. Picon, "Compact and efficient 2.45 GHz circularly polarised shorted ring-slot rectenna," *Electronics Letters*, vol. 48, no. 5, pp. 253-254, 2012.
- [9] Takhedmit, L. Cirio, B. Merabet, B. Allard, F. Costa, C. Vollaïre and O. Picon, "A 2.45-GHz dual-diode rectenna and rectenna arrays for wireless remote supply applications," *Intern. Journ. Of Microw. and Wireless Technolog.*, vol. 3, special issue 3, pp. 251-258, June 2011.