



**HAL**  
open science

## Modeling and Sizing Coils dedicated to boost converter for PV source

Lotfi Atik, Mohammed Amine Fares, Ghalem Bachir, Michel Aillerie

### ► To cite this version:

Lotfi Atik, Mohammed Amine Fares, Ghalem Bachir, Michel Aillerie. Modeling and Sizing Coils dedicated to boost converter for PV source. Algerian Journal of Research and Technology, 2019, 2 (1). hal-02431537

**HAL Id: hal-02431537**

**<https://hal.science/hal-02431537v1>**

Submitted on 13 Jan 2021

**HAL** is a multi-disciplinary open access archive for the deposit and dissemination of scientific research documents, whether they are published or not. The documents may come from teaching and research institutions in France or abroad, or from public or private research centers.

L'archive ouverte pluridisciplinaire **HAL**, est destinée au dépôt et à la diffusion de documents scientifiques de niveau recherche, publiés ou non, émanant des établissements d'enseignement et de recherche français ou étrangers, des laboratoires publics ou privés.



Algerian Journal of Research and Technology

[AJRTDZ@gmail.com](mailto:AJRTDZ@gmail.com)

<http://www.univ-usto.dz/AJRT/>



ISSN : .....  
xx

*A.J.R.T Volume 2 (N° 1) (2018) xx-*

## **Modeling and Sizing Coils dedicated to boost converter for PV source**

L. Atik<sup>1,2,a,b</sup>, M. A. Fares<sup>1,2,a,b</sup>, G. Bachir<sup>1,a</sup>, M. Aillerie<sup>2,b</sup>

<sup>1</sup>*Université des Sciences et de la Technologie Mohammed Boudiaf, Oran, Algeria*

<sup>2</sup>*Université de Lorraine, LMOPS-EA 4423, 57070 Metz, France*

<sup>a</sup>*Laboratoire de Développement Durable de l'Énergie Électrique (LDDEE)*

<sup>b</sup>*Centrale Supélec, LMOPS, 57070 Metz, France*

\*Corresponding author. E-mail: [lotfiatik31@gmail.com](mailto:lotfiatik31@gmail.com)

**Abstract.** The coil is a very important element in a wide range of power electrical systems as such used as converter or inverter dedicated to extract and to adapt the value and the shape of the intensity and the voltage delivered by renewable energy sources. Thus, knowing its behavior in converters is paramount to obtain a maximum conversion efficiency and reliability. In this context, this paper presents a global study of a DC/DC converter dedicated to photovoltaic sources based on the modeling of the behavior of the coil or the inductance as a function of the switching frequency.

**Keywords.** Magnetic energy, Coil, photovoltaic, Boost converter, Duty cycle, MPP.

## INTRODUCTION

In electromagnetic systems, only the magnetic energy is likely to be stored in enough density to be converted into another form of energy, in large quantities. Thus, in such system, the magnetic circuit is the central element of the converter as it assumes the storage and the transformation (**M. Marty et al., 2005**).

The coils can serve as a controlled switch in the context of the magnetic regulation. This one is a method of regulating a power electronics converter that uses the properties of saturable inductors. In fact, an inductance in the linear zone  $B(H)$  is generally used so that it does not change value, which is particularly important for maintaining fixed cutoff frequency of a filter. We can also locate it in magnetic and electronic ballasts for discharge lamp lighting i.e. the fluorescent lamps, metal halide lamps, etc.

Coils have an essential impact in different applications. They can be used as current transformers (CT) that can transform high current values (K.A) to low ones. They can be inserted in power electrical network as galvanic isolation transformers. They transform the grounding system (TT) into (IT) as regards corrugated networks that supply loads sensitive to disturbances, i.e. harmonics in the electrical generators.

The coils can locate in medical materials like Magnetic Resonance Imaging (MRI). The most commonly used magnets are superconducting electromagnets. They consist of a coil made superconducting by cooling liquid helium, surrounded by liquid nitrogen. They allow obtaining intense and homogeneous magnetic fields but are expensive and must be maintained regularly.

In previous contributions, authors have presented specific topology of DC/DC magnetically boost converter and their associated maximum power point tracker (**L. ATIK et al., 2016 – T. Z. TERNIFI et al., 2016**). The topology of the converter was a boost based on an inductor at its input. Even if the main objective of these contributions was elsewhere, the important role of the coil in these DC/DC converters was considered but not modeled and the fundamental importance of its sizing was not enlighten and evaluated. Nevertheless, this studied topology of converter proven effective in energy conversion, it was once again chosen for the current study here reported. In this paper, we focused on the sizing of inductor  $L$  dedicated to the boost converter, and then we presented the steps to follow for making a coil with  $N$  turns based on real results.

## THE TWO EXISTING MODELS OF COILS

Starting with general considerations and basics, a coil, or auto-inductor is a common component in electrical engineering and electronics. A coil consists of a winding of a conductive wire around a ferromagnetic core material called "ferrite core" (**J.L. COCQUERELLE et al., 1999**). The magnetic field is a manifestation of the energy. The coil receives electrical energy and transforms it into magnetic energy. Following this transformation, the coil has a number of properties. The flux produced by a coil is proportional to the current flowing through it; the coefficient of proportionality is called "inductance" whose symbol is  $L$ .

An induction coil is often called inductance and is constituted (**YAN LI et al., 2017**) by a soft magnetic alloy core and  $N$ -turn windings as shown on figure 1. A coil can be used for various functions consisting to eliminate the parasites of a power generator or an analog signal; it then plays the role of impedance. Shorten an antenna i.e. the coil acts as a signal amplifier. Give an impedance circuit. Create a filter for a particular frequency or frequency band. Smooth DC currents (to eliminate noise) or control current growth in power electronics devices.

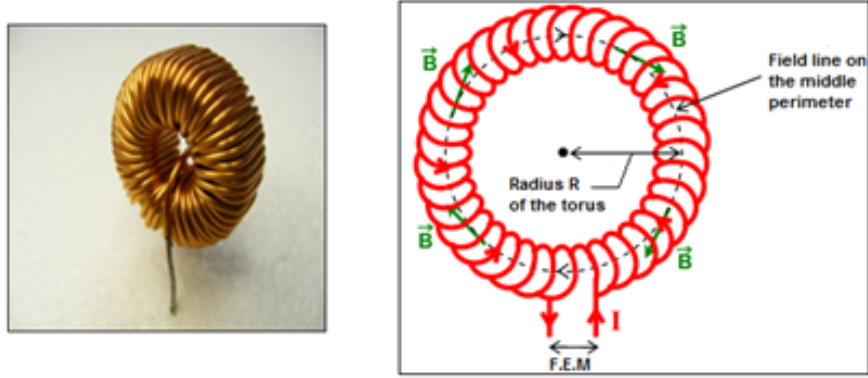

**Fig. 1.** A torical coil.

The stored electromagnetic energy has the usual form expressed by

$$E = \frac{1}{2} Li^2 \quad (1)$$

The ideal coil (YI CHEN et al., 2015) is modeled by a self-inductance denoted generally L. The real coil and specifically if it is wound around a ferromagnetic material. This one, it is a complex dipole with many parameters and the seat of physical phenomena some of which are the cause of non-linearity.

The simplest and most frequently used models are those corresponding to the combination of an inductance coil and a resistor. They are grouped in the dipole model family.

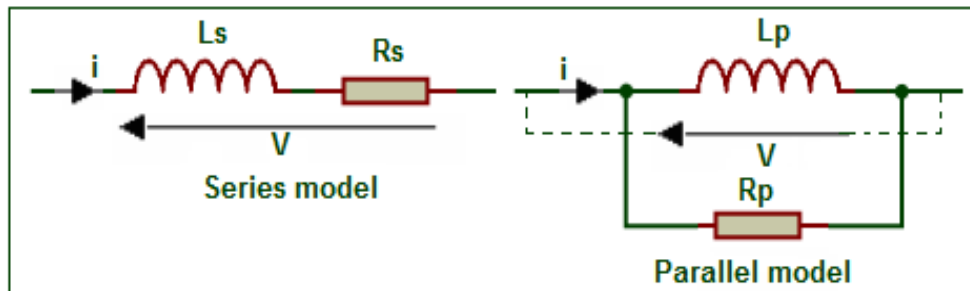

**Fig. 2.** Dipole models (series, parallel).

The series dipole model consists of the series connection of an inductance coil and a resistor. It corresponds to the following formula:

$$V = Ls \cdot \frac{di}{dt} + Rs \cdot i \quad (2)$$

The second one, i.e. the parallel dipole model consists of the parallel association of an inductance coil and a resistor. It corresponds to the following formula:

$$i = \frac{1}{Lp} \int_T u dt + \frac{V}{Rp} \quad (3)$$

## MODEL OF A BOOST CONVERTER

The energy provided by a single photovoltaic (M.A. FARES et al., 2017) panel is insufficient to satisfy the large loads in terms of power and consumption such as motors or similar charges. Add a several photovoltaic panels to build a PV field, is not the best solution because it isn't suitable for all people for its high price. Using power electronics, there are several

static converters that can serve this demand. This type of static converter was shown as an efficient powerful solution; it is named boost or parallel converter according to his notation in the literature as shown on figure3.

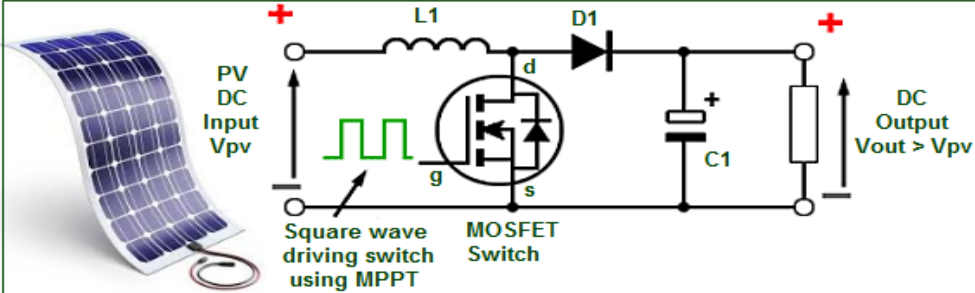

Fig. 3. Equivalent electrical circuit of boost converter.

A boost converter (GERARD ANG et al., 2017) (step-up converter) is a DC-to-DC power converter that steps up voltage (while stepping down current) from its input (supply) to its output (load). It is a class of switched-mode power supply (SMPS) containing at least two semiconductors (a diode and a transistor) and at least one energy storage element: a capacitor, inductor, or the two in combination. To reduce voltage ripple, filters made of capacitors (sometimes in combination with inductors) are normally added to such a converter's output (load-side filter) and input (supply-side filter). The key principle that drives the boost converter is the tendency of an inductor to resist changes in current by creating and destroying a magnetic field. In a boost converter, the output voltage is always higher than the input voltage. A schematic of a boost power stage is shown in Figure 3.

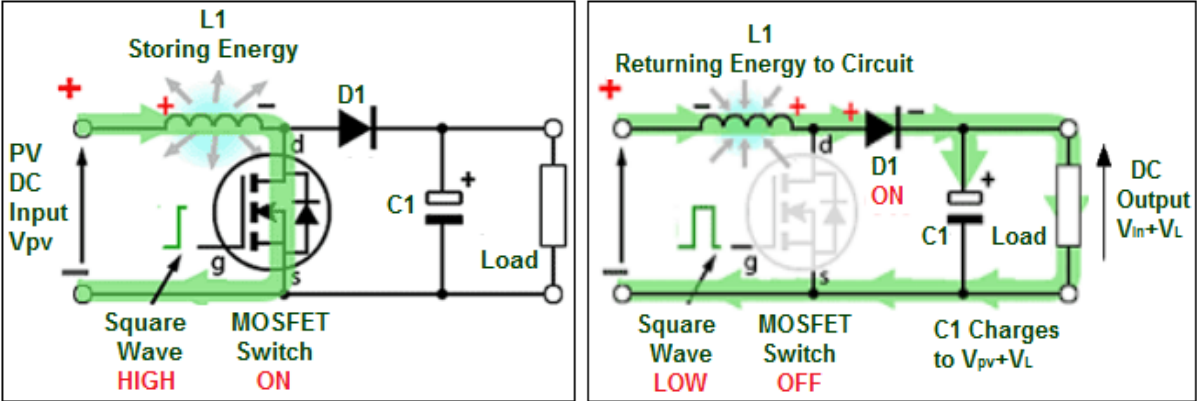
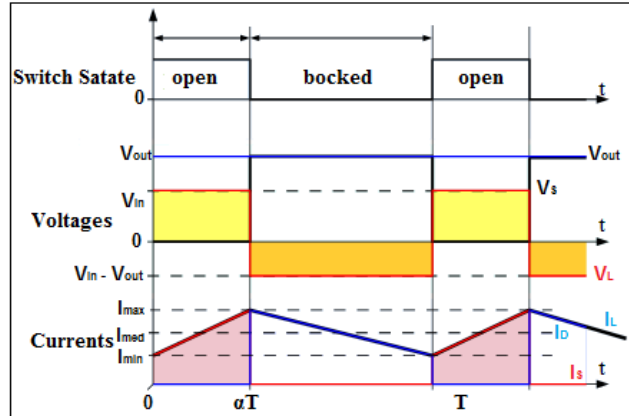

Fig. 4. The two current paths of a boost converter, depending on the state of the switch S.

The boost converter works in two different mode. The first mode, when the switch is closed, current flows through the inductor in clockwise direction and the inductor stores some energy by generating a magnetic field. Polarity of the left side of the inductor is positive. The second mode, when the switch is opened, current will be reduced, as the impedance is higher. The magnetic field previously created will be destroyed to maintain the current towards the load. Thus the polarity will be reversed (means left side of inductor will be negative now). As a result, two sources will be in series causing a higher voltage to charge the capacitor through the diode D, as shown on figure 4 above.

When a boost converter operates (N. SELVARAJU et al., 2017) in continuous mode, the current through the inductor  $I_L$  never falls to zero. Figure 5 shows the typical waveforms of currents and voltages in a converter operating in this mode. The output voltage can be

calculated as follows, in the case of an ideal converter (i.e. using components with an ideal behavior) operating in steady conditions



**Fig. 5.** Waveforms of current and voltage in a boost converter operating in continuous mode.

During the ON state, the switch S is closed, which makes the input voltage  $V_{IN}$  appear across the inductor, which causes a change in current  $I_L$  flowing through the inductor during a time period (t) by the formula:

$$\frac{\Delta I_L}{\Delta t} = \frac{V_{in}}{L} \quad (4)$$

Where L is the inductor value.

At the end of the ON state, the increase of  $I_L$  is therefore:

$$\Delta I_{Lon} = \frac{1}{L} \int_0^{\alpha T} V_{in} dt = \frac{\alpha T}{L} V_{in} \quad (5)$$

$\alpha$  is the duty cycle. It represents the fraction of the commutation period T during which the switch is ON. Therefore, D ranges between zero (0) (S is never on) and one (1) (S is always ON). During the OFF state, the switch S is open, so the inductor current flows through the load. If we consider zero voltage drop in the diode, and a capacitor large enough for its voltage to remain constant, the evolution of  $I_L$  is:

$$V_{in} - V_{out} = L \frac{dI_L}{dt} \quad (6)$$

Therefore, the variation of  $I_L$  during the OFF period is:

$$\Delta I_{Loff} = \int_{\alpha T}^T \frac{(V_{in} - V_{out}) dt}{L} = -\frac{(V_{in} - V_{out})(1 - \alpha)T}{L} \quad (7)$$

As we consider that the converter operates in steady-state conditions, the amount of energy stored in each of its components has to be the same at the beginning and at the end of a commutation cycle. In particular, the energy stored in the inductor is given by:

$$E = \frac{1}{2} L I_L^2 \quad (8)$$

Therefore, the inductor current has to be the same at the start and end of the commutation cycle. This means the overall change in the current (the sum of the changes) is zero:

$$\Delta I_{Lon} + \Delta I_{Loff} = 0 \quad (9)$$

It results:

$$\frac{V_{out}}{V_{in}} = \frac{1}{1 - \alpha} \quad (10)$$

According to expression (10), the output voltage is always upper than that the input one. Thereby, the duty cycle value is the only variable that will allow us to control the output voltage. As we chose a boost converter system connected with a photovoltaic panel, the duty cycle value is calculated according to a mechanism named maximum power tracking algorithm MPPT. This one allows controlling the system and it makes their operation always optimal against environmental changes.

## PV POWER SOURCE

As our system is connected with a photovoltaic panel, figure 6 presents curves (I-V) and (P-V) which are well known in the literature. These ones allows us to visualize the (MPP) at each climate change i.e. irradiation and temperature. Figure 6 also indicates the photovoltaic panel parameters cited as follows: optimal power ( $P_{OPT}$ ), optimal voltage ( $V_{OPT}$ ), optimal current ( $I_{OPT}$ ), open circuit voltage ( $V_{OC}$ ), short circuit current ( $I_{SC}$ ) and the maximum power point (MPP) that it is well shown in the figure 6.

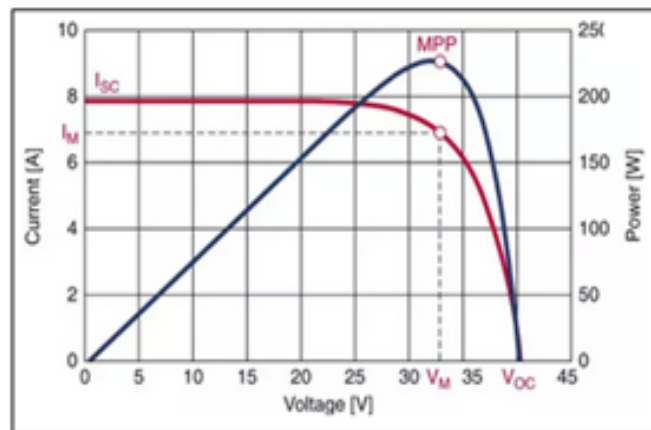

**Fig. 6.** I-V and P-V characteristics for a photovoltaic panel.

The type of the chosen photovoltaic panel to connect it with the system is referred ZAYTECH 180S mono. It is composed of 72 mono-crystal type cells connected in (series/parallel) according to the manufacturers. It technical sheet is well indicated on the following table (L. ATIK et al., 2017).

**Table 1.** Characteristics of the panel ZAYTECH 180S mono.

Panel Parameters	Indication	Values
Optimal Power [W]	Popt	180
Open voltage circuit [V]	Voc	44,71
Optimal voltage [V]	Vopt	36,79
Short-circuit curent [A]	Isc	5,53
Optimal Current[A]	Iopt	4,89
Panneau ZAYTECH 180S		

## SIZING COILS DEDICATED TO BOOST CONVERTER

Manufacturers strive to realize elements i.e. inductance whose inductive part is preponderant, this according to all uses condition. Nevertheless, it is impossible (J. S. JEON et al., 2017) to realize an element that is purely inductive as it is illustrated in the following figure.

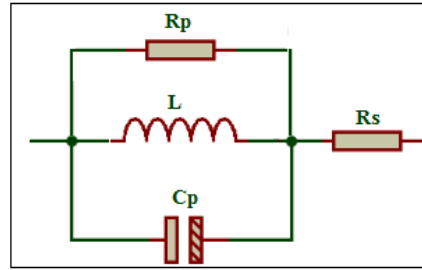
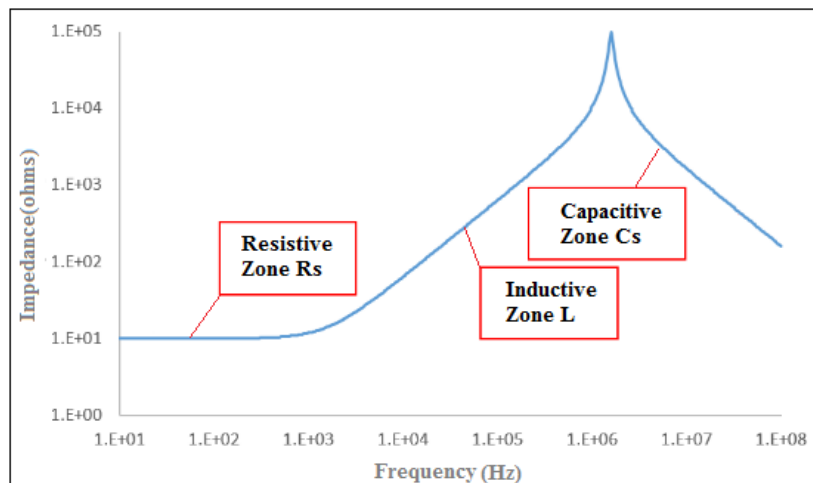

**Fig. 7.** Equivalent model of impedance  $Z$ .

Knowing that:

- $C_p$ : parasitic capacitance (connection wires, inter-turns capacitance).
- $R_s$ : parasitic resistance series (connection wires and winding).
- $R_p$ : parallel parasitic resistance (magnetic losses).
- $L$ : Inductance.

Figure 8 illustrates the module of the impedance (ohms) of an inductance coil as a function of frequency (Hz), calculated with the model presented in figure 7. According to this curve, it is possible to define three zones:



**Fig. 8.** The module of the impedance  $Z$ .

Resistive zone characterized by the series resistance  $R_s$ . This value limits the maximum current in the inductance, therefore the energy that it is possible to store. For inductive zone, it is characterized by inductance  $L$ . This is the usual working zone of the inductor. The capacitive zone characterized by the capacity  $C_s$ . This is a zone to avoid in practice since the inductor has an impedance that decreases as a function of frequency, which is the opposite of its desired behavior. Thereby, we note that the value of the coil (inductor) can never be purely inductive whatever the frequency used by the manufacturer.

To realize a coil dedicated to boost converter, we will follow the known steps cited in the literature as well as in accordance to magnetic standards by respecting the impedance limit values indicated on the curve above. To calculate the inductance value, the output parameters of the photovoltaic panel are considered ideal and especially the current  $I_{OPT}$  in order to avoid a spike of current who can afterwards gives us wrong values, joule effect losses of the coil conductor wire and magnetic interference which may adversely affect to electronic components of the system.

We supposed that the optimal current provided by the PV panel is ideal



$$I_{PV \max} = I_{OPT} \cdot \sqrt{2},$$

Knowing that ( $I_{PV}=I_{IN}$ ) and ( $V_{PV}=V_{IN}$ ).

For:

$\Delta I\% = 5\%$ , which is between (5%) to (15%) supposed by the manufacturer).

$$\Delta I_{PV \max} = I_{PV \max} \cdot \Delta I\%$$

To calculate the inductance value L (H), we use equation 12.

$$\Delta I_{pv \max} = \frac{V_{pv}}{L} \alpha_{max} T \quad (11)$$

$$L = \frac{V_{pv} \cdot \alpha_{max}}{\Delta I_{pv \max} \cdot f} \quad (12)$$

Where:

- $V_{PV}(V)$ : the optimal voltage supplied by the photovoltaic panel.
- $\alpha_{MAX}$ : the maximal duty cycle.
- $F(KHz)$ : The switching frequency. (Chosen between 20 to 100 KHz).

The chosen torus is of material 3E25 in accordance to the frequency band used in the literature. This model can satisfy the desired turn's number of coil, heat resistant, and it reduces losses energy at high temperature (joule effect losses). Its toroid inductance value is 3820 (nH/tr<sup>2</sup>). It is also necessary to provide a torus with a large diameter enough to pass the desired number of wire turns.

To calculate the turn's number of coil, we used the following equation

$$L = N^2 \cdot AL \quad (13)$$

With:

- L: inductance (H).
- N: laps number.
- AL: Toroid inductance (nH/tr<sup>2</sup>).

After calculate the laps number, which gives the desired inductance value choosing the torus model 3E25 of a dimension of (40x20x10) mm, we obtain the magnetic coil presented in figure 9.



**Fig. 9.** Realized coil of 2.48 mH.

## BEHAVIOR OF MAGNETIC COIL BOOST CONVERTER

In this part, we presented an experimental test of the coil presented on figure 9 by chosen different values of frequency then see its behavior via these values. By respecting the frequency band that can support the chosen torus model i.e. between 10 kHz, and 100 kHz according to the literature. These measures have been done by the digital RLC METER referred (BENCHTOP 894 Series B&K Precision). The following table shows the behavior of the coil inductance value as a function of the chosen frequency values in (kHz).

According to relation 12, we note that the inductance value  $L$  is proportionally positive with the variation of the frequency i.e. as long as the frequency value is high, the inductance value will gradually increase by a very midget uncertainty. This allows having a precision at obtaining the experimental inductance value  $L$ . At the experimental test, the manufacturers can never realize a coil corresponding to the theoretical calculation because it is depend by the coil turns number. For example, if a constructor results 22 coil turns number at the theoretical calculation which results an inductance value of 2mH. Except that in experimental case, the coil value is between the 20<sup>th</sup> and the 21<sup>st</sup> turns number to have a coil value  $L$  closer to its theoretical calculations.

Afterwards he can adjust the coil value by a frequency band chosen by himself. The chosen frequency must also be suitable for other electronic circuit components such as the transistor. This one has a frequency band to respect, which allows it to switch without energy losses i.e. losses Joule effect.

**TABLE 2.** Inductance as a function of the frequency.

Inductance (mH)	Frequency (kHz)
2,33	10
2,48	20
2,61	40
2,77	60
2,95	80

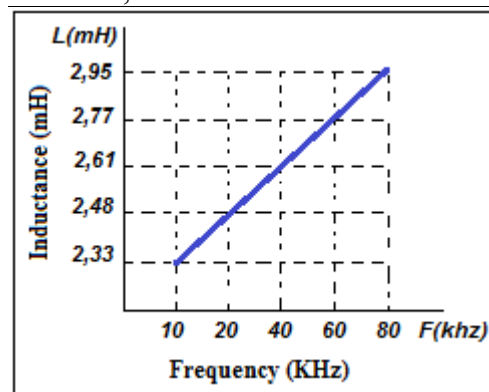

**Fig. 10.** Frequency sweep and the influence of inductance.

## RESULTS AND DISCUSSION

In this part, we presented the simulation results of the used system i.e. the boost converter, the presented results corresponds to the output parameters of the photovoltaic panel such as output power, output voltage and the output current. As a photovoltaic panel powers the system, the obtained results are taken in standard environmental conditions i.e. fixed temperature 25°C and

fixed irradiation  $1000\text{W}/\text{m}^2$  as a reason to seeing the coil behavior under the system. These results were obtained under (MATLAB /Simulink) environment.

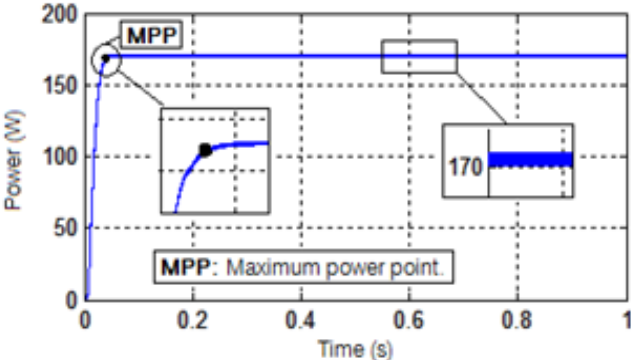

Fig. 11. The output power  $P_S$  of boost converter.

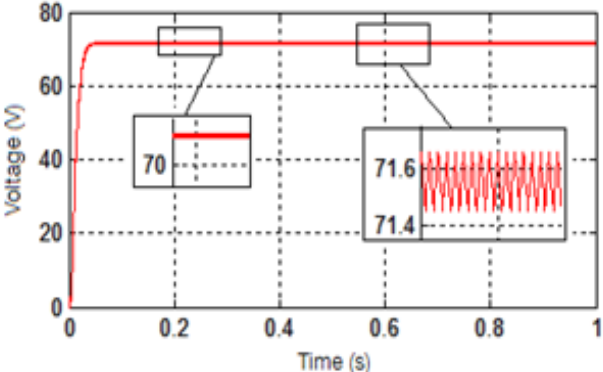

Fig. 12. The output voltage  $V_S$  of boost converter.

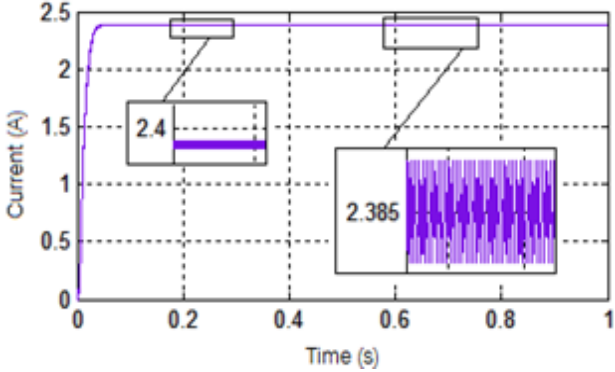

Fig. 13. The output current  $I_S$  of boost converter.

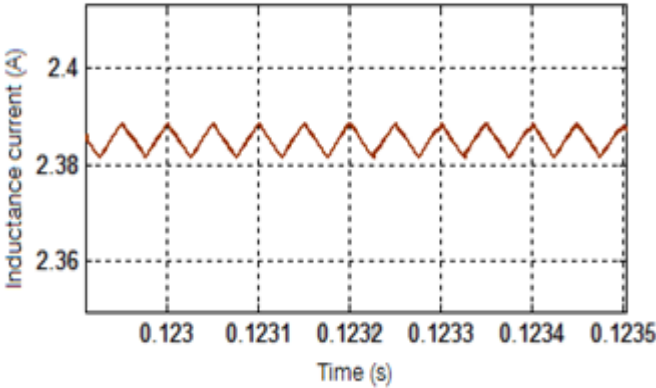

Fig. 14. Current through the inductor  $i_L$ .

At the beginning of the test, corresponding to the step, does not represent practical situation but is actually proposed by us to simulate the influence of temperature changes in PVG behavior. It avoids making long duration tests but it allows by extended the present simulating results, to simulate slow changes of temperature due, as example, presence or not of clouds above the panels. . For a better visibility of the result, we chose a simulation time equal to 1(s). These curves was performed under same standard conditions i.e. for a temperature equal to 25°C, and an irradiation of 1000W/m<sup>2</sup>.

Figure 11 shows the output power of the system i.e. boost converter as a function of time (s). The system is powered by a continuous photovoltaic source, the temperature and irradiation are maintained fixe to see the behavior of the coil under system. By using a maximum power point tracking mechanism MPPT, it create the oscillation when searching the MPP. This procedure must be repeated periodically, forcing the system to oscillate until that reached the MPP, and around the MPP at steady state as shown on “Fig. 8”. At the steady state, the average power is at 171 W compared to the provided PV power, which results an excellent efficiency.

According to figures 12 and 13, we note that the decrease of the output current is proportional with the increase of the output voltage by comparing them with the photovoltaic panel parameters. The decrease of the current resulting from the stored energy in the inductance L which subsequently generates a magnetic field, when the switch is open, the current reduces because the impedance is higher. The magnetic field created at the OFF state will be destroyed to maintain the current to the load. The increase of the output voltage of the system is done when the switch is open as shown on figure 12. As a result, two sources will be in series causing a higher voltage to charge the capacitor through the diode D, which is called the booster effect.

Figure 14 shows the evolution of the current ( $I_{MAX}$ ,  $I_{MED}$  and  $I_{MIN}$ ) through the inductance as a function of time (s). The current  $i_L$  is the form of saw tooth called hysteresis form in the literature, it depends on the state of the switch (ON/OFF), that means the evolution of the current  $I_L$  is always proportional with the duty cycle ( $\alpha$ ) when a boost converter operates in continuous mode corresponds to our case.

## CONCLUSION

In this paper, we have presented one of the most used converters i.e. the boost converter. This one is used in several applications such as in regulated DC power supplies, in regenerative braking of DC motors, in portable device applications, and in battery powered applications where there is space constraint to stack more number of batteries in series to achieve higher voltages. We quoted their operating principle as well a modeling was presented. A part of this paper has been devoted to the modeling and sizing of the coil by showing its electrical and magnetic behavior under system. We presented some details about the photovoltaic solar energy, which was the power source of our system by indicating the model of the chosen PV panel. Lastly, a simulation results under (MATLAB/Simulink) environment was presented of the output parameters system such as power, voltage and current.

The boost converter proved once again its adaptation by coupling with photovoltaic sources ensuring a smooth operation at commissioning with an excellent performance. The boost converter has also proven to work well in a frequency band chosen by us by respecting the frequency that can support the switch on opening and closing. we noticed that the maximum power point tracking mechanism MPPT is well adapted with the system by it connecting with the trigger of the transistor, this was done using a specific algorithm that extract the maximum power of the panel by transforming it to a square signal called the duty cycle which depend of

the external parameters variation of the PV panel i.e. irradiation and temperature. The coil plays a very important role under boost converters system by dint of the EMF created at its terminals when the current circulate in the coil by generating a magnetic field around the coil which depend on its calculated value Its EMF is added with the input voltage of the PV panel resulting in a higher voltage rating.

## REFERENCES

Marty. M, Dixneuf. D, Gilabert. D.G, 2005. Principes d'électrotechnique. Coil induction .Cours et exercices corrigés. Paris. Dunod. Coll. 670-688.

Atik. L, Touhami. Z.T. Bachir. G, Sawicki. J.P, Petit. P, Aillerie. M, 2016. Comparison of four techniques MPPT. AIP Conference Proceedings. 030047.1- 030047.11.

Ternifi. T. Z, L Atik. L, Bachir. G, Belarbi. A.W, Petit. P, Aillerie. M, 2016. Quality improvement of the AC electrical energy produced by a modular inverter dedicated to photovoltaic applications. AIP Conference Proceedings. 030048.1- 030048.10.

Cocquerelle. J.L, Ferrieux, F, 1999. Alimentations à découpage. Convertisseurs à résonance. Dunod, 3e édition. Chapter 2. 25-95.

Yan Li, Chao Yang, Zhe Yan, Bin Guo, Ning Mei, 2017. Analysis of the icing and melting process in a coil heat exchanger. Energy Procedia. 450-455.

Chen. Y, Hongxing. Y, 2015. Thermal Performances Comparison between Dry-Coil and Wet-Coil Indirect Evaporative Cooler under the Same Configuration. Energy Procedia. 3162-3167.

Fares. M.A, Atik. L, Bachir. G, Aillerie. M, 2017. Photovoltaic panels characterization and experimental testing. Energy Procedia. 945–952.

Ang. G, Arcibal. P.J, Lorien Marie R. Crisostomo, Conrado F. Ostia, Jose Emmanuel C. Tabuton, 2017. Implementation of a fuzzy controlled buck-boost converter for photovoltaic systems. Energy Procedia. 641-648.

Selvaraju. N, Shanmugham. P, Somkun. S, 2017. Two-Phase Interleaved Boost Converter Using Coupled Inductor for Fuel Cell Applications. Energy Procedia. 199-204.

Atik. L, Petit. P, Sawicki. J. P, Ternifi. Z. T, Bachir. G, Della. M, Aillerie, 2017. Maximum power point tracking algorithm based on sliding mode and fuzzy logic for photovoltaic sources under variable environmental conditions. AIP Conference Proceedings. 020063.1-020063.12.

Jeon. J. S, Seung-Rae. L, 2017. Suggestion of a Load Sharing Ratio for the Design of Spiral Coil-type Horizontal Ground Heat Exchangers. Energy Procedia. 292-298.