



HAL
open science

Output Voltage Changes in PV Solar Modules after Electrical and Thermal Stresses. Experimental Analysis

Jean Zaraket, Michel Aillerie, Chafic Salame, Etienne Losson

► To cite this version:

Jean Zaraket, Michel Aillerie, Chafic Salame, Etienne Losson. Output Voltage Changes in PV Solar Modules after Electrical and Thermal Stresses. Experimental Analysis. TMREES, Sep 2018, Athènes, Greece. pp.1404-1411, 10.1016/j.egypro.2018.11.305 . hal-02429852

HAL Id: hal-02429852

<https://hal.science/hal-02429852v1>

Submitted on 13 Jan 2021

HAL is a multi-disciplinary open access archive for the deposit and dissemination of scientific research documents, whether they are published or not. The documents may come from teaching and research institutions in France or abroad, or from public or private research centers.

L'archive ouverte pluridisciplinaire **HAL**, est destinée au dépôt et à la diffusion de documents scientifiques de niveau recherche, publiés ou non, émanant des établissements d'enseignement et de recherche français ou étrangers, des laboratoires publics ou privés.



Technologies and Materials for Renewable Energy, Environment and Sustainability, TMREES18,
19–21 September 2018, Athens, Greece

Output Voltage Changes in PV Solar Modules after Electrical and Thermal Stresses. Experimental Analysis.

Jean Zaraket^{a,b,c}, Michel Aillerie^{b,c,*}, Chafic Salame^{a,d}, and Etienne Losson^e

^aCEER, Faculty of Sciences II, Lebanese University, B.P 90656 Jdeidet El Mten, Lebanon

^bLaboratoire Matériaux Optiques, Photonique et Systèmes, LMOPS, EA 4423, Université de Lorraine, Metz, 57070, France

^cLaboratoire Matériaux Optiques, Photonique et Systèmes, LMOPS, CentraleSupélec, Université Paris-Saclay, Metz, 57070, France

^dCNRS-L, National Council for Scientific Research, Beirut, Lebanon

^eUniversité de Lorraine, LCOMS, EA 7306, Metz, F-57070, France

Abstract

Partial shading and dirt areas are the main external reasons inducing via electrical and thermal stresses hot spots in photovoltaic (PV) modules or panels reducing their instantaneous performances and at best their lifetime, at worst a rapid total degradation of the functioning. Even if manufacturers add by-pass diode in the topology of the PV panel, performances of the panel under or after stresses are not taken into consideration in their datasheet which only gives the characteristics under Standard Test Conditions (STC).

To test the role of electrical and thermal stresses on the performance of PV module, we performed several series of experimental measurements in the most used commercial modules, i.e. a series of monocrystalline silicon ones.

Using a Deep Level Transient Spectroscopy (DLTS) spectrometer based on a double-boxcar system in the post-stress period, this work focusses on the analysis of defects present in stressed PV solar modules for measurements of electrical characteristics of the module. Various reverse currents and temperature levels were applied to induce the stress in dark condition into the solar module structure. The output voltage was measured before and after the applying stress in the same condition for several common periods of time. The changes in efficiency and parameters of PV cells and modules being exposed to shadow effects compared to that in normal working mode are discussed based on output voltage done in the present study.

© 2019 The Authors. Published by Elsevier Ltd.

This is an open access article under the CC BY-NC-ND license (<https://creativecommons.org/licenses/by-nc-nd/4.0/>)

Selection and peer-review under responsibility of the scientific committee of Technologies and Materials for Renewable Energy, Environment and Sustainability, TMREES18.

Keywords: Solar cell/module, Electrical Stress, Thermal Stress, DLTS spectrometer, Electrical characteristics.

* Corresponding author.

E-mail address: aillerie@metz.supelec.fr

1. Introduction

The photovoltaic (PV) effect transforms in a semi-conductor element, via a quantum energy conversion process the light energy coming from solar rays into electrical energy. In practice, this transformation is done in PV cells assembling in PV panels mostly based on silicon technology. (Except in contrary indications, in the following of the publication, we will use the word module to design PV cell or PV panel). Characteristics and performances of PV modules are always given by the manufacturer in the datasheet of the module and correspond to data providing from measurements done under Standard Test Conditions (STC). As well known, STC approximately equals to the power of the sun at noon, on a sunny day, at the equator and thus, are nothing like the real world in temperate zones. The NREL laboratory has defined the Photovoltaics for Utility Scale Applications Test Conditions, or PTC. PTC indicates that the system's output will be about 10% below the STC rating. Considering practical integration of PV module on a roof, even without shading or dirt areas, the roof pitch and the orientation is not free to be optimized and currently, we consider the production at a level between 70 to 80% of the possibilities in ideal conditions given by the PTC. Whatever the season is, the duration in a day of cloudy or dim light is relatively important and corresponds to time during which, the PV module doesn't work at its optimum power possibility. Moreover, many practical localizations or implementations of modules, decrease again more the performances compare to PTC due to shading or dirt areas generated, for examples by trees, chimneys, and post shadings or droppings of birds and dead leaves directly on the module. These last situations correspond to the worst functioning cases for a PV module due to the presence of a reverse current in the shading zones of the PV cell leading to electrical and thermal stresses in the module inducing huge degradations of the macroscopic and internal physical, quantum and electrical properties of the module. The macroscopic or external physical degradations of the component can be induced by a delamination process of the interfaces between electrodes or encapsulation and the cell. Using a scanning electron microscope (SEM) we have qualitatively confirmed on our modules under tests the occurrence of surface damage between a non-burned zone and a burned zone of the same cell before and after inducing electrical stress in temperature. These pictures, Fig. 1, clearly show the changes of the surface, the structure of the encapsulation material and delimitation between this surface and the surface of the cell.

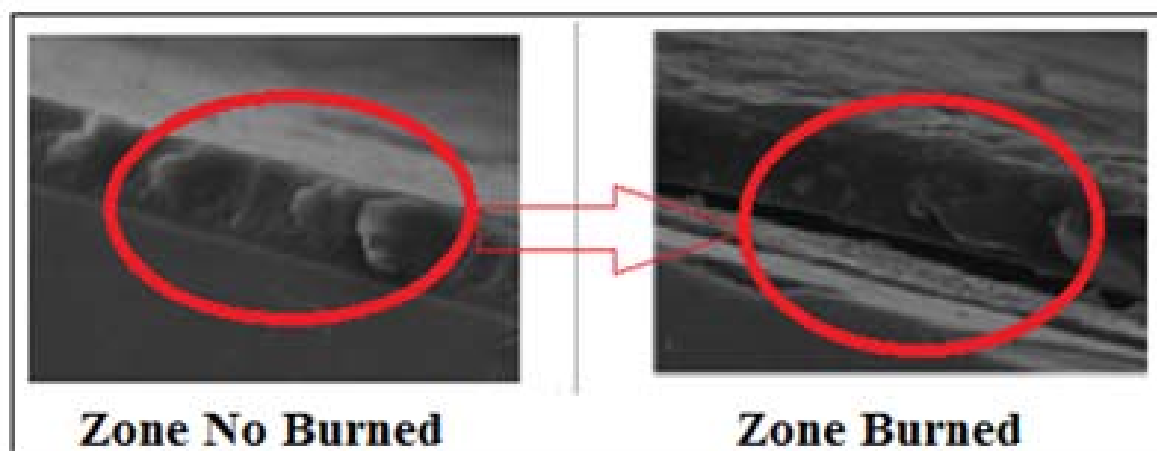

Fig. 1: Scanning electron microscope (SEM): zone no burned and burned [1]

On the other hand, a qualitative analysis is not possible to characterize internal changes induced by stresses to the internal properties of the cell or semi-conductor junction due to the presence of defects in the modules that cause malfunctions and deterioration of the electrical characteristics of the photovoltaic modules. For this purpose, experimental studies can be supported by several models currently used to describe the functioning of a module.

Among these models, the two diodes model is the most used when internal properties are considered as it takes into consideration the precise behavior of seven physical and electrical parameters as function of the irradiation level and thermal changes in PV cells or PV modules. These two diode models is composed of two ideal diodes associated with a series resistor R_s , a shunt resistor R_{sh} . The electrical currents are the reverse saturation current, I_{02} linked to the generation of electrons and holes in the depletion region and the reverse saturation current, I_{01} linked to the diffusion of electrons and holes in the P and N sides of the cell. In this model, the seventh parameter is the ideality factor, A , representing the efficiency of the cell or the module [2]. This ideality factor is important for the qualification of a PV system. It is found close to 1 for a module without stress, corresponding to the ideal cases whereas, in stressed cases, it increases indicating the degradation in performances.

For all above mentioned reasons related to the stress in PV modules, the practical ones for manufacturers and installers and the fundamental ones for researchers in view of the improvement of the PV materials and system properties, the knowledge and experimental quantification of the changes in all these parameters are fundamental. In the current contribution, we focus on the study and discuss the induced change of the PV module parameters induced by an electric and thermal stress. The $I(V)$ and $C(V)$ measurements are indirect results, based on a model of the defects in the photovoltaic modules. To have a direct characterization, we extended these studies by using a Deep Level Transient Spectroscopy (DLTS) spectrometer from SULA technology. For that, we specially focus on the changes of the output voltage as function of times under different temperatures by using a double-boxcar spectrometer. Generally, this kind of spectrometer is associated to the DLTS technique for the characterization of defects in the gap of semi-conductor junctions. As our study, concerns PV modules that are complex structures constituted by an association of PV cells in series and parallel, the DLTS spectrometer and technique cannot straightforwardly give the fundamental parameters of natural or induced defects like it is done when a single junction or a diode is characterized. Nevertheless, we have taken the opportunity of the high sensitivity of the experimental apparatus constituting by the DLTS spectrometer to measure the relative changes induced in the modules after electric and thermal stresses.

Our experiments were performed in PTC, on a low-power commercial module in dark conditions, before and after applying the electric and thermal stresses. The double-boxcar spectrometer associated to the DLTS technique allows obtaining the output voltage evolution as function of times in the PV module under test. The presented results and discussion below offered aimed to contribute to understand the evolution of performances and efficiency of PV material and modules.

2. Experiments

The experiment procedure based on measurements using a DLTS spectrometer

The Deep Level Transient Spectroscopy (DLTS) was developed in 1974 by DV Lang [3], to investigate "deep" level in the space of semiconductor structures load in PN junction or Schottky barriers. The DLTS technique is connected on the measurement of transient capacitances resulting from the relaxation process after electrical excitation as a function of temperature. The experiment procedure based on DLTS spectrometer is what follows: at first, the internal electronic defects are filled during a voltage pulse applied onto the semi-conductor junction, in a second phase starting after the pulse, the output voltage is measured. In diode or simple semi-conductor junction, the recorded data responds to an Arrhenius law that allows the determination of the main parameters of the defects as the activation energy and the effective capture section. In complex systems as PV modules in which we are concerned, the recorded data allows the determination of the behavior of the module after the appearance of a disruption of its operation.

Characteristics of the PV modules under test and experimental conditions

In this experiment, we used commercial solar modules 4x4 (16 cells) 2V, 60 mA and 0.12W, collected from the local consumer market.

The experimental procedure is schematically presented in Fig. 2.

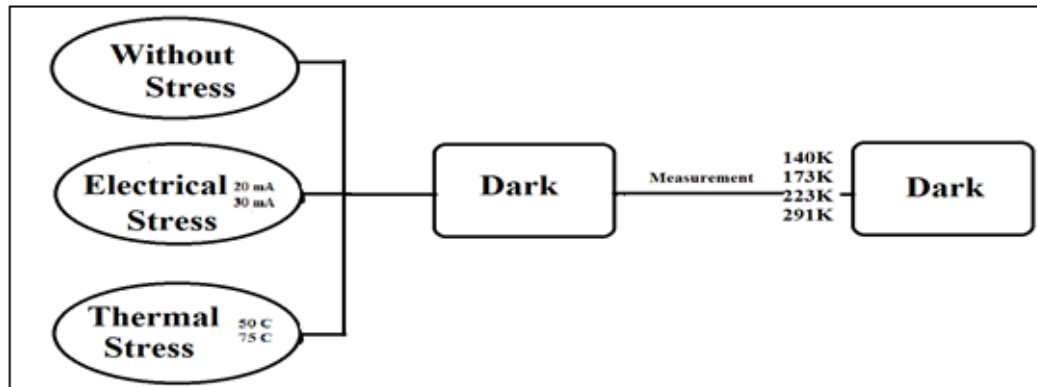

Fig. 2: Experimental procedure

In a first phase, the modules are stressed as explained in Refs [1, 7]. The experimental conditions of this “stressed phase” are that the electric stress was created in modules by injecting in dark environment and during 10mn for each level of stress, an inverse electric current equal to 20mA, 30mA. We have applied this procedure at various fixed temperature levels equal to RT, 50°C, 75°C. In the second phase, that can be noted the “output pulse”, we record the response of the modules to a voltage pulse following the DLTS procedure. This process was done in dark condition at different temperature levels between 140K and 291K. During that phase shown in fig.3, a negative voltage equal to -9V duration having 2 ms is applied to the module except a pulse of 100 μ s duration having an amplitude of +4V. The response of the module to this pulse was considered by the record of its output voltage. This measurement was done for the virgin modules and for the stressed ones.

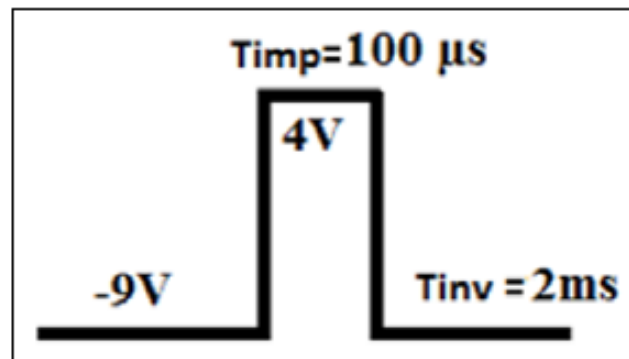

Fig. 3: Pulses used for the characterized module

3. Results and Discussions

As mentioned above, in the stressed phase, the reverse current was injected in the module to induce the electric stress at various temperatures. Nevertheless, we choose here to report in Fig. 4 the output voltage responses recorded in the DLTS phase at various temperatures for the virgin.

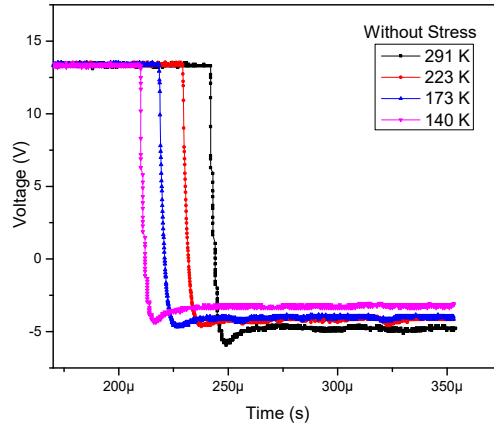

Fig. 4: V(v) vs Time (s) for the virgin module measured at different temperatures

First general comments in the observed response can be done in this figure relative to the virgin module. The responses of the virgin module (Fig. 4) present the expected response shape to the voltage pulse. It is to be noted that compared to more results that are classical obtained in single semi-conductor junction with the DLTS procedure, in which no observable delay exists in the response after the applied voltage pulse, we notice here a non-constant delay in the response of the module to this pulse. We attribute this delay in the time response to the presence in the module under test of parasitic resistances and capacitances due to its intrinsic physical nature including a multi-junction structure, metallic electrodes and encapsulation elements. By else, our study confirms that the DLTS procedure cannot be easily and fully applied to the determination of internal defect characterization in semi-conductor junctions with photovoltaic modules due to their complex structure.

Finally, we also notice in Fig. 4 that the delay and the amplitude of the response increase with the temperature applied in this phase.

In general, the structure of the module is composed of several cells in parallel and in series, and since there are impurities in the materials of the modules, then these two important factors are responsible for the degradation of the modules. The semiconductor crystalline contains metallic impurities and crystalline defects. The component processing, the semiconductor growth, and the operating conditions can be considered the primary source of defects. These impurities and defects induce an additional energy level in the band gap.

We report in Fig. 5, the responses for the electrically stressed modules after a stress induced at room temperature by two different values of the reverse current, i.e. with a reverse current equal to 20mA and 30mA, respectively. Similarly, we report in Fig. 6, the responses for the thermally stressed modules induced with two temperature steps, 50°C and 75°C.

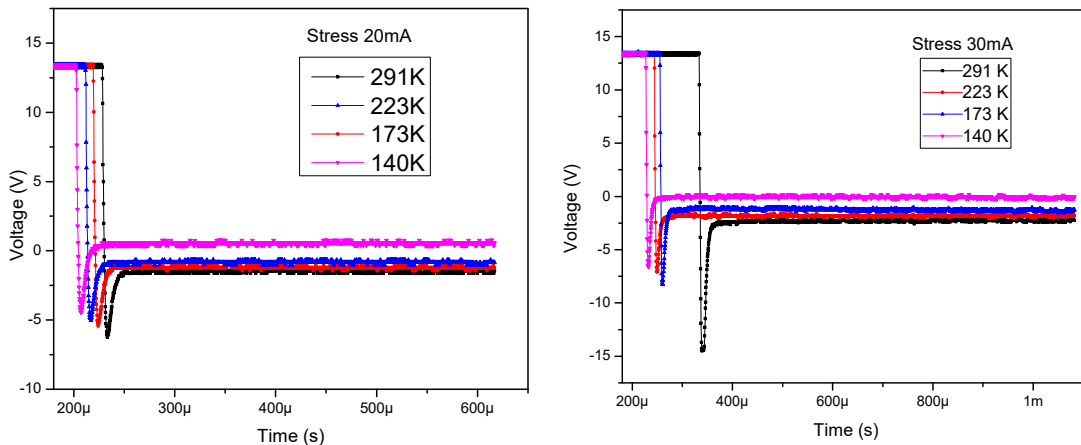

Fig. 5: V (v) vs Time (s) after electrical stress, measured at different temperatures

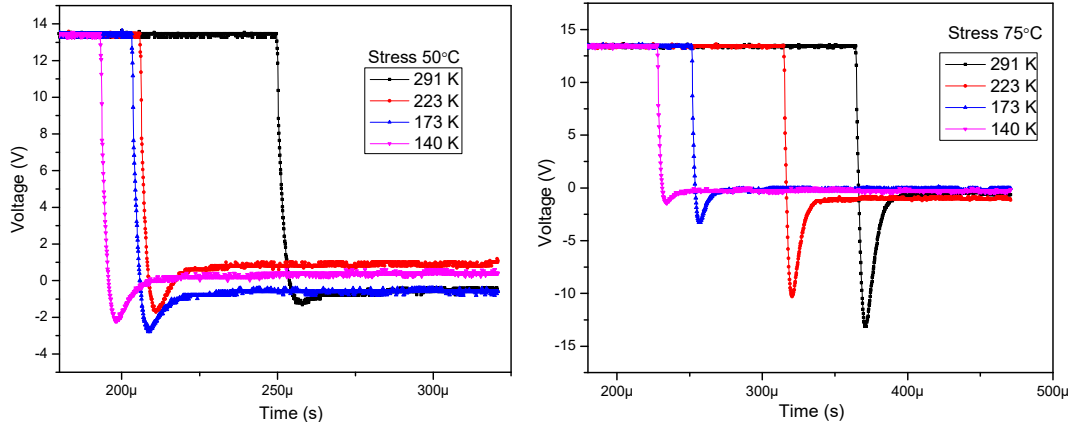

Fig. 6: V (v) vs Time (s) after thermal stress, measured at different temperatures

The same explanation as in the case of the response of the virgin module regarding the form of output voltage $V(t)$ can be made in measurements with the electrically stress modules (Fig. 5) after with the response of the thermally stressed modules (Fig. 6). In contrast, in these two figures, we can notice the influence of the stress, electric or thermal, on the value of the response delay to the voltage pulse and on the amplitude of this response peak. When the stress increases, the response delay time and maximum amplitude increase. These results for virgin and stressed modules indexed with the time and the amplitude of the induced stress are reported in Figs.7 and 8 considering the characterization temperature as input parameter.

Fig. 7 shows the delay as function of temperature, this shift of the output voltage $V(t)$ was observed the module because it was a complex structure. Indeed, for photovoltaic module, we have a large surface area and whose quality cannot be ensured over the entire surface but in one cell, the surface of the junction is small, and we did not see this shift [4, 5]. Furthermore, the module also has a very large exchange surface with the metal forming the electrodes and the leakage current is greater than one cell where the current flow is provided by two single wires.

In figure 8, we show the maximal amplitude as function of temperature, in virgin and stressed cases. This amplitude increases when the stress is applied. In particular cases, when the module is stressed by a reverse current of 30 mA and 75°C of thermal stress.

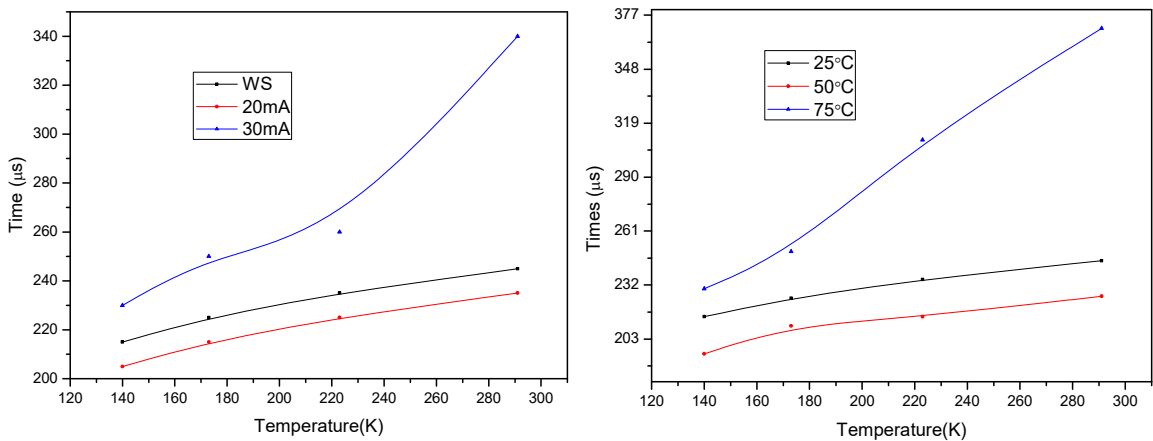

Fig. 7: Delay vs temperature before and after stress

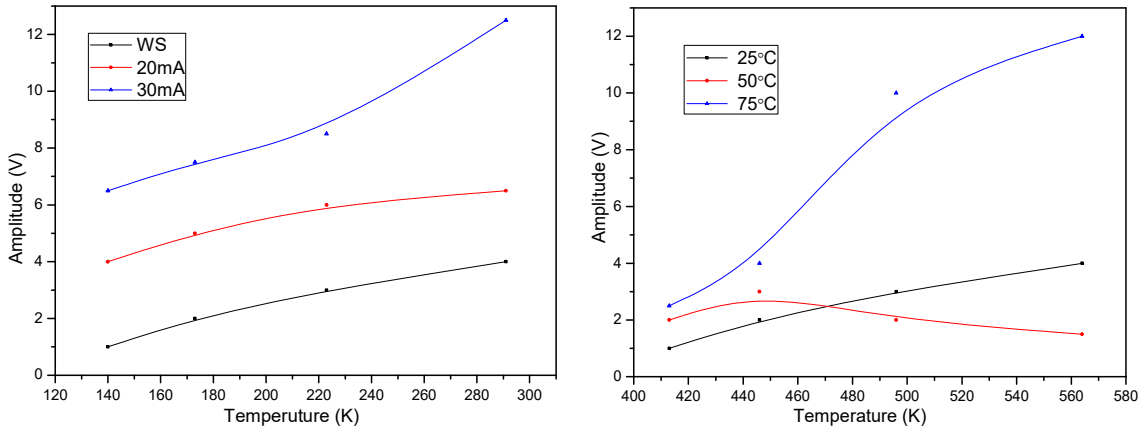

Fig. 8: Amplitude vs temperature before and after stress

Figs. 7 and 8 clearly point out the same behavior with the experimental temperature during measurements of the response of the PV module after it was stressed by an electric current or after a temperature increase in the considered ranges in this study. Additionally, and in both stress cases, the changes with temperature of both, the delay time and the amplitude differ for the most stressed module compared to those of the virgin and the low stressed modules. We attribute this phenomenon to the fact that for characterization done at very low temperature, the main relative change in the response is linked to the internal electronic properties of the semi-conductor junctions, i.e. the defects in the electronic gap, whereas when this temperature increases, the influence of macroscopic defects in the module will induce more contributions in the high-stressed module than in the virgin or low-stressed ones. These results could you enlighten the qualitative existence of a threshold range under which the damage induces a light degradation of the performance but above which the induced damage will present a large decrease of the performance. Thus, within the module tested in this work, we can estimate the damage threshold for the electric stress between 20 mA and 30 mA and the damage threshold for the thermal stress between 50 °C and 75 °C. In practice, the stress levels corresponding to the threshold range can be associated to the maximum acceptable stress level in a classical functioning mode, i.e. with an acceptable decrease of performance and lifetime. Above this threshold, performances of the stressed module hugely decrease up to its possible full deterioration by burning. This phenomenon can rapidly occur when the module suffers of shading or dirt areas inducing a hot-spot phenomenon in the dark zone of the module by a huge increase of the electric and thermal stresses.

By going back to results published in Refs. [1, 6-9], which present the stress applied (electrical and thermal) in dark condition and the measurements obtained in the same cases, we qualitatively obtained that the value of R_{sh} is important with a decrease with the applied stress. This decrease of the shunt resistance means the increase of the leakage current, with the increase of the reverse current and temperature. Moreover, within the limits of precision of the devices and methods used, we found the ideality factor for a module without stress, close to 1 corresponding to the ideal case. In the case of stressed modules, we have obtained a higher value than 1 indicating a degradation of performance. These degradations may be due to the physical degradation of the component, for example at the interfaces between the electrodes and the cell, or the encapsulation which has been confirmed by SEM.

The results were obtained on modules composed of several cells. This structure is complex which creates a delicate electrical environment of the cells at the origin of the output voltage, shown the shift of the temporal responses with the measurement temperature. The presence of defects in the modules generally causes malfunctions and deterioration of the electrical characteristics of the photovoltaic modules. In fact, the SULA Tech capacitance meter used in our measurements only gives reliable results for leakage currents of less than 100 μ A.

4. Conclusions

For the characterization of performances of photovoltaic (PV) modules under specific experimental modes, several measurement techniques can be used depending on the type of excitation (electrical or optical, under irradiation or in dark) and depending on the measured parameters (voltage, current or capacity). In this contribution, we have used a Deep Level Transient Spectroscopy (DLTS) spectrometer, for the evaluation on the performances of commercial PV modules of the electric and thermal stresses. It is to be noted that usually, DLTS technique is performed for the characterization with high sensitivity of the parameters of defects in the gap of a pure or single semiconductor junction. Here, we have developed this technique for the characterization of PV modules which are complex electronic structures compared to single-junction system as single diode.

At first, in our measurements with all modules, i.e. the virgin and the stressed ones, we have observed, a shift in the position of the voltage peak corresponding to the output response of the module following the voltage pulse. We have shown that the amplitude and the time delay of this voltage peak in the response, both increases with the characterization temperature. This specific behavior is attributed to the complex topology of the module composed by electronic multi-junctions on a large area and with external components as metallic electrodes and encapsulation layers. By else, we have shown that this behavior increases with the increase of stress intensities. These observations confirm the degradation of the performance of the cells having undergone a stress. Moreover, when a stress threshold level is over gone, it will induce the creation of hot spots as far as the possible destruction of the module. Thus, the aging of the modules is directly related to the stress applied.

Finally, within the current study, we clearly notice that the behavior of the output voltage of a PV module obtained as a result of the experimental procedure can qualitatively explain the degradation of the performances of the modules before and after electrical or thermal stresses. These results may be applicable for the qualitative characterization of modules, arrays, or even a farm of arrays creating a PV solar generator.

References

- [1] J. Zaraket, M. Aillerie and C. Salame, “Dark and Illuminated Characteristics of Photovoltaic Solar Modules. Part I: Influence of Dark Electrical Stress”, AIP-CF 1758, 020016, 2016.
- [2] H. Tsai, C. Tu, and Y. Su, “Development of generalized photovoltaic model using Matlab/Simulink”, Proceedings of the World Congress on Engineering and Computer Science 2008, WCECS 2008, October 22 - 24, San Francisco, USA, 2008.
- [3] D.V. Lang “Deep-level transient spectroscopy: A new method to characterize traps in semiconductors”, J. Appl.Phys., Vol 45, Issue 7, pp.3023-3032, July 1974.
- [4] N. Abboud, “Titre Etude et caractérisation de structure à base de silicium”, Thèse cotutelle entre l’université libanaise (Liban) et l’université de Montpellier II (France), 2011.
- [5] P. Arnolda, titre “ La création de défauts de déplacements atomiques dans le silicium et son impact sur les composants électroniques à applications spatiales”, thèse à l’université de Toulouse, 2011.
- [6] J. Zaraket, M. Aillerie and C. Salame, “Dark and Illuminated Characteristics of Photovoltaic Solar Modules. Part II: Influence of Light Electrical Stress”, AIP-CF, 1758, 030052, 2016.
- [7] J. Zaraket, T. Salame, M. Aillerie and C. Salame, “Parameters and Characteristics of PV Solar Modules Under the Influence of Thermal Stresses”, AIP-CF, 1814, 020055, 2017.
- [8] J. Zaraket, M. Aillerie and C. Salame, “Capacitance Evolution of Photovoltaic Solar Modules under the Influence of Electrical Stress”, Energy Procedia, Elsevier, 1466-1475, Vol 74, 2015.
- [9] J. Zaraket, M. Aillerie and C. Salame, “Capacitance evolution of PV solar modules under thermal stress”, Energy Procedia, Elsevier 702–708, vol 119, 2017.