



HAL
open science

Electronically Re-Writable Chipless RFID Tag Using Solid State Metal-Insulator-Metal Switches on Paper Substrate

Methapettyparambu Purushothama Jayakrishnan, Arnaud Vena, Brice Sorli, Etienne Perret

► **To cite this version:**

Methapettyparambu Purushothama Jayakrishnan, Arnaud Vena, Brice Sorli, Etienne Perret. Electronically Re-Writable Chipless RFID Tag Using Solid State Metal-Insulator-Metal Switches on Paper Substrate. 2019 IEEE/MTT-S International Microwave Symposium - IMS 2019, Jun 2019, Boston, United States. pp.400-403, 10.1109/MWSYM.2019.8701004 . hal-02429460

HAL Id: hal-02429460

<https://hal.science/hal-02429460v1>

Submitted on 13 Jan 2020

HAL is a multi-disciplinary open access archive for the deposit and dissemination of scientific research documents, whether they are published or not. The documents may come from teaching and research institutions in France or abroad, or from public or private research centers.

L'archive ouverte pluridisciplinaire **HAL**, est destinée au dépôt et à la diffusion de documents scientifiques de niveau recherche, publiés ou non, émanant des établissements d'enseignement et de recherche français ou étrangers, des laboratoires publics ou privés.

Electronically Re-Writable Chipless RFID Tag Using Solid State Metal-Insulator-Metal Switches on Paper Substrate

M.P. Jayakrishnan¹, Arnaud Vena², Brice Sorli² and Etienne Perret^{1,3}

¹ Univ. Grenoble Alpes, Grenoble INP, LCIS, 26000 Valence, France.

² Institut d'Electronique et Systèmes (IES), Université de Montpellier 2, Montpellier 34095, France.

³ Institut Universitaire de France, 75005 Paris, France.

jayakrishnan.mp@lcis.grenoble-inp.fr, arnaud.vena@umontpellier.fr, brice.sorli@ies.univ-montp2.fr
etienne.perret@lcis.grenoble-inp.fr

Abstract— In this article, we present the design and results of an electronically re-writable chipless RFID tag on paper substrate. This tag consists of two resonators build around a modified shorted dipole, integrated with a non-volatile Metal-Insulator-Metal (MIM) switch, which tunes the electrical length of each resonator to resonate at two different frequencies, depending on state of the switch. One can electronically reconfigure the tag using low power DC pulses to change its RF signature. The integrated MIM switch has a layer architecture of Silver-Nafion-Aluminum, formed exclusively using an in-house process in ambient laboratory conditions, notably without the use of any ‘clean room’ facilities. Operating mechanism of the tag is validated with the help of developed electrical equivalent model. This study proves the concept of realizing ‘electronically reconfigurable’ chipless tags on flexible and low cost substrates, with a fabrication process compatible with mass production.

Keywords— Rewritable Chipless RFID, CBRAM, MIM Switch, Reconfigurability

I. INTRODUCTION

Chipless RFID is a rapidly developing concept in the field of contactless object identifiers [1]. Presently, optical barcodes are the most convenient identifiers used due to their reliability, data capacity and low cost. Nevertheless, chipless RFID in its current developmental rate would hopefully overrun this trend in near future [1]. In contrast to optical barcode systems, chipless RFID technology has various advantages like out-of-optical-range readability, sensor integration capability, reconfigurability etc., which cannot be implemented with the former technology at present [2]–[4]. Some groups of researchers worldwide have reported works on ‘reconfigurable’, or more exactly “writable” chipless RFID tags [5]. This was to tackle the issue of low cost production for the realization of chipless tag by using a two-step process. Step-1 the main geometry of the tag is mass produced using classical techniques like photolithography or screen printing. Step 2 – these blank tags are configured (or write) for defining special tag IDs later, using organic conductive inks with the help of an inkjet printer, which does not require a sintering process [2], [5]. Contrary to that, recently, a revolutionary idea of encoding information using non-volatile MIM/CBRAM switches has been introduced [6], [7]. In this, a consistent solution of ‘Electronic Reconfigurability or electronic write/rewrite feature’ is introduced. This is done by adding a

Metal-Insulator-Metal (MIM) switch [8], to a resonator in order to vary its electrical length depending on the state of the switch. Despite of present cost considerations this is an interesting feature. A MIM switch could be compared to a parallel plate capacitor, in which the electrolyte is replaced by an ion-conducting polymer such as Nafion [8], which is used in this study. One of the electrodes of this cell is an electrochemically active metal like silver or copper and other is a relatively inert metal like aluminium or gold. Application of a positive voltage with respect to active electrode would cause active metal ions to migrate through the ion-conductor layer to form a conductive filament to the inert electrode, there by dropping total resistance of the cell, and establishing the ‘set’ state. Similarly a voltage of opposite polarity could be used to dissolve the filament and establish the ‘reset’ state. State of the switch thus formed is non-volatile and persists till the next programming without the need for any maintaining power supply. This switch topology could be re-written/re-programmed for several times allowing recycling of RF-tags [6], [7]. A similar device reports more than 2000 cycles of operation [9].

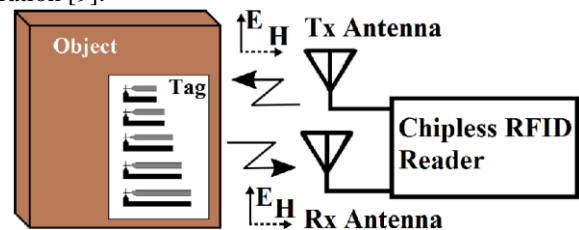

Fig. 1. Bistatic Radar used for RCS measurements of chipless RFID tag.

However, a great opportunity of exploiting the impact of OFF state capacitances of these CBRAM/MIM switches is not discussed in these articles. It is obvious from the point of view in terms of the equivalent circuit reported in [6] that tuning the OFF state capacitance could be used as a data encoding strategy for chipless RFID tags.

In this article, we report for the first time the design and results of an electronically rewritable multi-bit chipless RFID tag on paper substrate. We try to give a good insight to the utilization of OFF state capacitance of MIM switches for encoding data in a chipless RFID tag, through the help of simulation studies. This experiment is a proof of concept of realization of re-writable chipless tags without the use of any

clean room technology, and on common substrates available all around, like paper. This feature to electronically rewrite allows for bulk manufacture of a generic group of tags (with required number of resonators for the required bit-length) without a specific or predefined identity code (ID). Then each tag could be field programmed using low power DC pulses to generate a specific tag-ID. This particular tag could be integrated on to a package at a very low cost, thus forming a ‘disposable and field programmable electronic label’. The tag could be read using a bi-static radar setup as shown in Fig. 1, up to distances of a few tens of centimeters, and programmed at the time of application as shown in the inset of Fig.2.

II. STUDY OF MIM CELL FOR REWRITABLE CHIPLESS RFID

An MIM cell (as shown in Fig. 2) could be modelled as an RC parallel network [8] with resistance R_{MIM} equivalent to the filament resistance measured across the cell and capacitance C_{MIM} equivalent to the calculated parallel plate capacitance due to geometry of electrodes and dielectric properties of the ion conductor used. From [8] one could observe the difference of MIM switches from conventional switches, that MIM switches have a significant OFF/reset state capacitance. Now we investigate the idea of integrating such non-ideal switches in a chipless RFID tag for data encoding. An N-bit tag with MIM switches integrated into (as used in this study), could be modelled as a combination of serial RLC networks for the antenna mode and structural mode of the tag [6]. In which the electrical equivalent of MIM switch, which is an RC parallel network is added in series with the antenna mode of each resonator as shown in Fig.3. In this experiment we do some simulation studies on the effect of shift in resonance frequency as a function of R_{MIM} and C_{MIM} . This is done by optimizing the equivalent circuit of Fig.3 for a resonator topology as shown in Fig.2 as R1, whose values are summarized on Table 1. Results of simulation are given in Fig.4 (a) and (b).

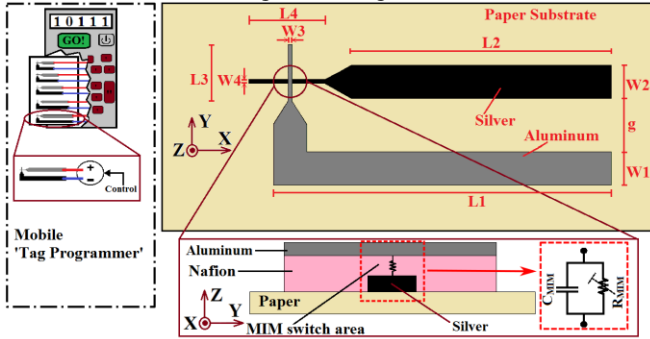

Fig. 2. Topology of REP used and electrical model of MIM Switch (Layers not up to scale). Inset shows a cut out view of a mobile ‘Tag-Programmer’. $W1=W2=g=3\text{mm}$, $W3=160\mu\text{m}$, $W4=140\mu\text{m}$. $L3=3\text{mm}$, $L4=4\text{mm}$. Resonator1 (R1): $L1=37\text{mm}$, $L2=30\text{mm}$, Resonator2 (R2): $L1=18\text{mm}$, $L2=11\text{mm}$.

From Fig.4 it is clear that resonance frequency of the resonator for reset state (higher resistance) depends significantly on C_{MIM} of the switch. Capacitance C_{MIM} could be controlled by adjusting the electrode area of the MIM cell for a given thickness of ion-conductor. This could be achieved by controlling the width of overlapping sections where a MIM

switch is integrated, as shown in Fig.2 as ‘w3’ and ‘w4’. Please note that this is also governed by the minimum achievable feature size in terms of fabrication tolerances.

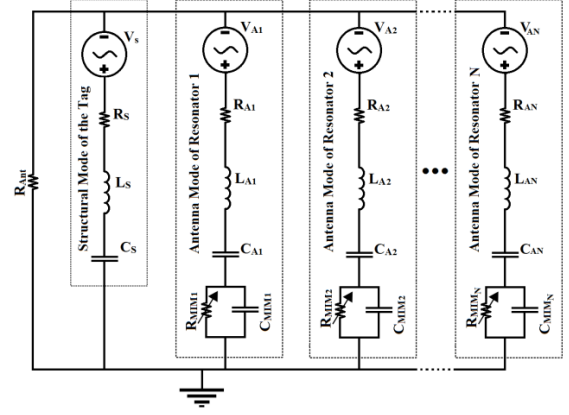

Fig.3. Electrical model of electronically re-writable chipless RFID tag.

Table 1: Electrical Equivalent Model of the Reconfigurable Tag

Element	Value	Element	Value	Element	Value
R_S	20Ω	R_{A1}	3Ω	R_{A2}	2Ω
L_S	1nH	L_{A1}	14nH	L_{A2}	10nH
C_S	0.2pF	C_{A1}	0.66pF	C_{A2}	0.255pF
V_S	$30\text{mV}/0^\circ$	R_{MIM1}	$1\Omega/1\text{M}\Omega$	R_{MIM2}	$1\Omega/1\text{M}\Omega$
V_{A1}, V_{A2}	$1.5\text{mV}/0^\circ$	C_{MIM1}	1.3pF	C_{MIM2}	1pF

R_{Ant} is a small value resistance for connecting Voltage probe in PSpice.

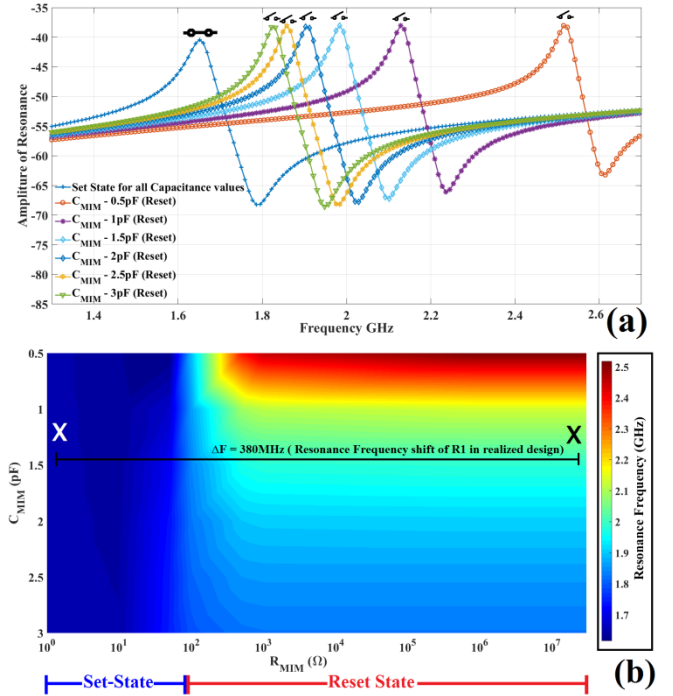

Fig. 4. Dependence of resonance frequency on C_{MIM} and R_{MIM} (a) Resonance Pattern, R_{MIM} in set case is 1Ω and in reset case is $1\text{M}\Omega$ (b) Resonance frequency map.

In Fig. 4, a variation of C_{MIM} from 3pF to 0.5pF would force a difference in resonance frequency, of 170MHz to 860MHz respectively in the reset state, from the set state resonance frequency. An empirical formula (polynomial fit)

for relation of the frequency of resonance in GHz and C_{MIM} in pF, derived from the results in Fig. 4 (b) for the reset state ($R_{MIM} = 1M\Omega$ and above) is given as (1).

$$F_{Reset} = -0.09C_{MIM}^3 + 0.64C_{MIM}^2 - 1.51C_{MIM} + 3.12 \quad (1)$$

To encode a tag ID based on this phenomenon several options could be thought of. Like two simple examples described below using a tag with ‘N’ resonators R_1 to R_N depending on the capacitance value that can be achieved with a chosen realization process, in order to maximize the coding capacity. First is a crisscross configuration, if low resolution realization process is used, where reset state C_{MIM} can be significant (e.g. 3 pF in Fig. 4) due to large electrode area. In such case the frequency shift is small ($\Delta F \approx 170$ MHz) in reset case, which would be compliant with chipless coding as shown in Fig. 5 (a). Second is a plain configuration, see Fig. 5 (b), for highly accurate realization processes with which smaller C_{MIM} values could be easily achieved (with very small electrode areas). With these values it is possible to shift the resonance to higher frequencies (like $\Delta F = 800$ MHz for 0.5pF in Fig. 4) in reset case. Please note that ‘N’ resonators like presented herewith could represent 2^N combinations, combining set and reset cases.

In this paper we present this strategy of multi bit coding, with the maximum shift that could be achieved with our available technology. Following sections explain the design of a 2-bit chipless RFID tag using this concept, in which geometry of the MIM switch is optimized to achieve an OFF state capacitance of 1pF to achieve a shift of 380MHz. The tag consists in it two resonators R_1 and R_2 as shown in Fig. 6, whose dimensions are given in Fig.2. Resonator which works as the RF-Encoding Particle (REP) is similar to the scatterer used in [6]. The design is first simulated using CST Microwave Studio, in frequency domain solver. The full wave simulation results, which are in perfect fit with the experimental results, are not included in this article due to space constrains. This tag is fabricated using in-house laboratory equipments similar to an industrial setup, without the use of ‘clean room’, as explained in following paragraphs. Substrate used for the process is a surface treated paper of thickness $70\mu m$. On this with the help of a Nickel pattern mask, one arm of the resonator is deposited using thermal vapor deposition technique. Metal used for this active layer is silver. Thickness of this deposit is $1\mu m$. Then a layer of ion-conductor (Nafion) is deposited by spin coating the ‘Nafion resin solution’, at a rate preset for a thickness of 600nm. This layer is air dried. Then other arm of the resonator is thermal vapor deposited with the help of a suitable nickel mask, using Aluminum, to obtain a thickness of $1\mu m$. Photograph of fabricated RF-Tag and micro-photograph of the MIM switch area are shown in Fig. 6.

III. PRINCIPLE OF OPERATION

MIM switch in the resonator (ref. Fig.2) is set/reset using voltage pulses generated using Keithley 2400 source meter similar to as reported in [8]. Switching pulses are applied to

metallic parts of resonators on the tag with the help of ordinary conducting wires bend to the shape of ‘paper clips’.

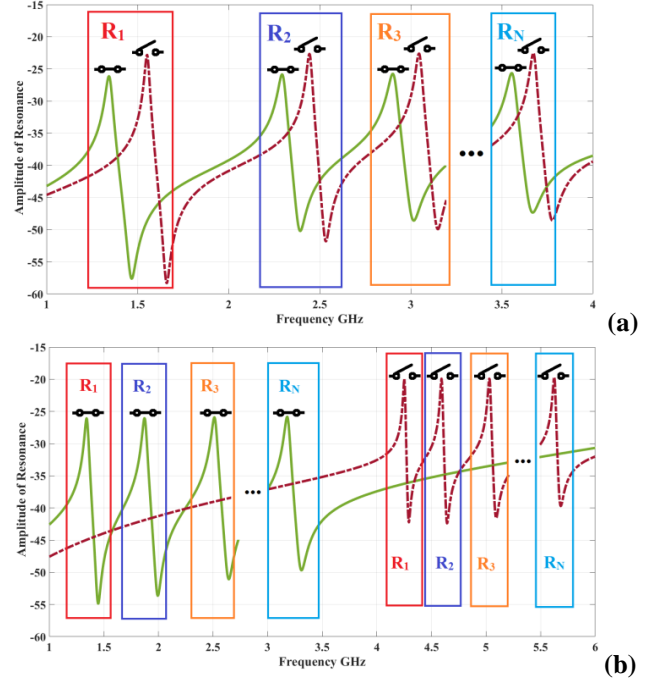

Fig. 5. Data encoding strategies (a) crisscross (b) plain.

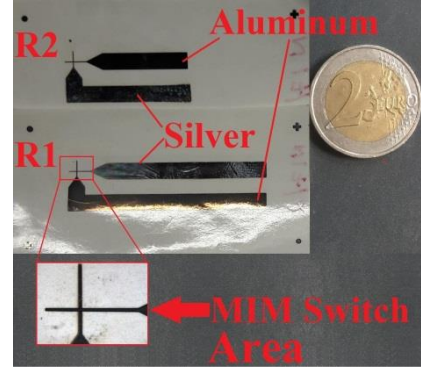

Fig. 6. Photograph of fabricated electronically rewritable chipless RFID tag with microphotograph of MIM switch area in the inset.

Switch is set/reset using a triangular pulse of peak voltage 12V and a flat negative voltage level of -20V, respectively. Operating mechanism of rewritable tag could be explained with respect to electrical equivalent circuit of the tag given in Fig. 3. In this experiment we use two resonators and hence we have two antenna mode networks and one structural mode network (corresponding to entire structure of the tag) as shown in Fig. 3 and Table 1. In the set state of the switch, filament resistance R_{MIM} would be very low, and thus effectively short circuits C_{MIM} , neglecting it from the current path. Thus, the frequency of resonance would be entirely dependent on R_A , L_A , and C_A . During a reset, the conducting filament is broken and hence R_{MIM} would be a very high value similar to an open circuit, which adds C_{MIM} to the current path of R_A , L_A , and C_A leading to reduction of net capacitance. This forces the resonator to resonate at a higher frequency. Value

of R_{MIM} is similar to experimentally observed filament resistance of MIM cells. C_{MIM} is similar to calculated parallel plate capacitance due to layer structure of MIM cell.

IV. RESULTS

RCS response of the fabricated tag are recorded in a ‘Bistatic Radar’ setup using Agilent N5222A Network analyzer and two broad band horn antennas in co-polarization inside an anechoic chamber, similar to the setup as shown in Fig.1, where the network analyzer is used as reader hardware, using a signal processing reported in [10]. Experimentally recorded RCS responses of the tag for all switch combinations are given in Fig. 7 (a). It could be seen that both the resonance frequencies are easily distinguishable for each resonators and are separated by at least 380MHz. This is close to the interpretation of resonance frequency in Fig. 4 (b), between 330MHz for 1.5pF and 470MHz for 1pF. Filament resistance of the MIM switch is observed to be 1Ω - 10Ω for set state and $1M\Omega$ - $30M\Omega$ for reset state for several cycles. This 2-bit tag could be used to represent four different combinations depending on the states of MIM switch as shown in result plots. Results of electrical equivalent circuit simulation are given in Fig.7 (b). Slight difference among the experimental and simulated response could be justified with unaccounted losses associated with the paper substrate used for experiment.

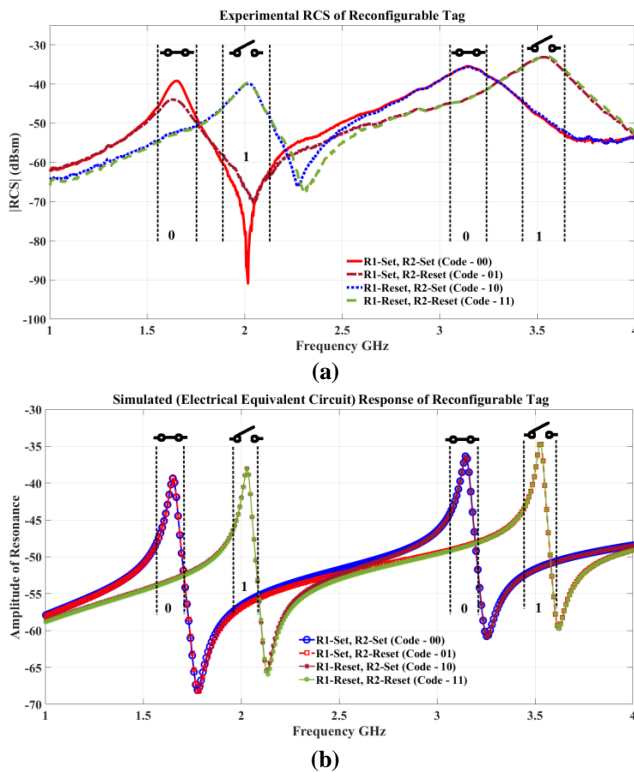

Fig. 7. RF response of electronically rewritable chipless RFID tag on paper substrate (a) Experimental (b) Electrical equivalent model.

V. CONCLUSION

In this experiment we demonstrate for the first time, the design, fabrication and results of an electronically rewritable

2-bit chipless RFID tag on paper substrate. The results are affirmative and serve as a proof of concept for a new revolution. Choice of paper substrate and outcome promises the application of this technique for commercial contactless identifiers. The tag is tested for more than 50 cycles of operation and is still functional. These results also add to our confidence in the realization of electronically rewritable RF paper-labels which could be ‘field printed’ and ‘field programmed’ by user at the time of application. Printing of the tag on substrates like sticker papers could be achieved by utilizing an inkjet printer and suitable metallic inks and electrolytes/ion-conductors. Field programming could be done using an electronic logic device with an electrode array, of the size of a credit card reader as shown in Fig.2. An attempt to realize fully printed rewritable chipless tags is in progress with the authors and is expected to be published soon.

ACKNOWLEDGEMENT

This project has received funding from the European Research Council (ERC) under the European Union’s Horizon 2020 research and innovation program (grant agreement No 772539). This work was also supported by Univ. Grenoble Alpes, and by the Institut Universitaire de France.

REFERENCES

- [1] S. Tedjini, N. Karmakar, E. Perret, A. Vena, R. Koswatta, and R. E-Azim, “Hold the Chips: Chipless Technology, an Alternative Technique for RFID,” *IEEE Microw. Mag.*, vol. 14, no. 5, pp. 56–65, Jul. 2013.
- [2] Etienne Perret, *Radio Frequency Identification and Sensors: From RFID to Chipless RFID*. Hoboken, NJ, USA: Wiley, 2014.
- [3] M. Borgese, F. A. Dicandia, F. Costa, S. Genovesi, and G. Manara, “An Inkjet Printed Chipless RFID Sensor for Wireless Humidity Monitoring,” *IEEE Sens. J.*, vol. 17, no. 15, pp. 4699–4707, Aug. 2017.
- [4] F. Costa *et al.*, “Progress in green chipless RFID sensors,” in *2017 11th European Conference on Antennas and Propagation (EUCAP)*, 2017, pp. 3917–3921.
- [5] L. Zheng, S. Rodriguez, L. Zhang, B. Shao, and L.-R. Zheng, “Design and implementation of a fully reconfigurable chipless RFID tag using inkjet printing technology,” in *ISCAS 2008. IEEE International Symposium on Circuits and Systems*, 2008, pp. 1524–1527.
- [6] M. P. Jayakrishnan, A. Vena, B. Sorli, and E. Perret, “Solid-State Conductive-Bridging Reconfigurable RF-Encoding Particle for Chipless RFID Applications,” *IEEE Microw. Wirel. Compon. Lett.*, vol. 28, no. 6, pp. 506–508, Jun. 2018.
- [7] J. Methapettyparambu Purushothama, A. Vena, B. Sorli, and E. Perret, “Electronically Re-Configurable, Non-Volatile, Nano-Ionics-Based RF-Switch on Paper Substrate for Chipless RFID Applications,” *Technologies*, vol. 6, no. 3, p. 58, Jun. 2018.
- [8] M. P. Jayakrishnan, A. Vena, A. Meghit, B. Sorli, and E. Perret, “Nafion-Based Fully Passive Solid-State Conductive Bridging RF Switch,” *IEEE Microw. Wirel. Compon. Lett.*, vol. 27, no. 12, pp. 1104–1106, Dec. 2017.
- [9] J. Jian, H. Chang, A. Vena, and B. Sorli, “Study and design of resistive switching behaviors in PMMA-based conducting-bridge random-access memory (CBRAM) devices,” *Microsyst. Technol.*, vol. 23, no. 6, pp. 1719–1725, Jun. 2017.
- [10] A. Vena, E. Perret, and S. Tedjini, “Chipless RFID Tag Using Hybrid Coding Technique,” *IEEE Trans. Microw. Theory Tech.*, vol. 59, no. 12, pp. 3356–3364, Dec. 2011.