



**HAL**  
open science

## Non-Volatile Conductive-Bridging Metal-Insulator-Metal Switches for Rewritable ‘RF Barcodes’

Jayakrishnan Methapettyparambu Purushothama, Arnaud Vena, Ira Susanti,  
Brice Sorli, Mamadou Balde, Etienne Perret

► **To cite this version:**

Jayakrishnan Methapettyparambu Purushothama, Arnaud Vena, Ira Susanti, Brice Sorli, Mamadou Balde, et al.. Non-Volatile Conductive-Bridging Metal-Insulator-Metal Switches for Rewritable ‘RF Barcodes’. 2019 IEEE International Conference on RFID Technology and Applications (RFID-TA), Sep 2019, Pisa, Italy. pp.157-162, 10.1109/RFID-TA.2019.8892122 . hal-02429343

**HAL Id: hal-02429343**

**<https://hal.science/hal-02429343>**

Submitted on 13 Jan 2020

**HAL** is a multi-disciplinary open access archive for the deposit and dissemination of scientific research documents, whether they are published or not. The documents may come from teaching and research institutions in France or abroad, or from public or private research centers.

L’archive ouverte pluridisciplinaire **HAL**, est destinée au dépôt et à la diffusion de documents scientifiques de niveau recherche, publiés ou non, émanant des établissements d’enseignement et de recherche français ou étrangers, des laboratoires publics ou privés.

# Non-Volatile Conductive-Bridging Metal-Insulator-Metal Switches for Rewritable ‘RF Barcodes’

Jayakrishnan M.P.  
Université Grenoble Alpes,  
Grenoble INP, LCIS,  
26000 Valence, France  
jayakrishnan.mp@lcis.grenoble-inp.fr

Brice Sorli  
Institut d’Electronique et des  
Systèmes (IES),  
Université de Montpellier / CNRS,  
34095 Montpellier, France  
brice.sorli@ies.univ-montp2.fr

Arnaud Vena  
Institut d’Electronique et des  
Systèmes (IES),  
Université de Montpellier / CNRS,  
34095 Montpellier, France  
arnaud.vena@umontpellier.fr

Mamadou Balde  
Institut d’Electronique et des  
Systèmes (IES),  
Université de Montpellier / CNRS,  
34095 Montpellier, France

Ira Susanti  
Faculty of Mathematics and Natural  
Science,  
Bandung Institute of Technology,  
Bandung, Indonesia  
irasusanti.itb@gmail.com

Etienne Perret<sup>1,2</sup>  
<sup>1</sup> Université Grenoble Alpes,  
Grenoble INP, LCIS,  
26000 Valence, France  
<sup>2</sup> Institut Universitaire de France,  
75005 Paris, France  
etienne.perret@lcis.grenoble-inp.fr

**Abstract**—This paper address the advantage and additional functionalities obtained by using integrated nonvolatile nanionic conductive bridging metal-insulator-metal (MIM) switches for rewritable chipless RFID applications. Improvement in reliability and ease of fabrication on using Nafion as an ion-conductor for MIM switching applications is discussed. A brief review of devices realized using the proposed technique is given. A novel idea of realization of a shape and frequency rewritable resonator structure for chipless RFID applications is also discussed with the help of full wave electromagnetic simulation studies.

**Keywords**—CBRAM, MIM Switches, RF Switch, Electronic Reconfigurability, Chipless RFID, Rewritable Chipless RFID

## I. INTRODUCTION

Chipless RFID technology is a great innovation as smart object identifiers in the 21<sup>st</sup> century [1]–[3]. Among remarkable chipless RFID techniques reported till date, technology of multi-scatter based tags is the most versatile technique according to authors [1]–[4]. Multi scatter based chipless RFID is a technique in which an identifier is distinguished based on a unique electromagnetic signature in the form of RCS resonant peaks distributed at preset positions in a given bandwidth [1], [4], [5]. Chipless RFID is often referred to as ‘RF barcode of the future’ [6], [7] due to its similarity in operation to an optical barcode system. However a chipless RFID system has much more to offer in terms of functionality and versatility in contrast to the optical barcode system, like out of optical line of sight readability, sensor integration capability, write/rewrite capability and so on [1], [4], [8]–[12].

In this article we focus on the reconfigurability or write/rewrite capability of a chipless RFID tag. First concern that comes into picture about the reconfigurability solution for chipless RFID tag is the choice of an RF switching technology. Desired features of such a switching technology are that, it should be a non-volatile solution (no power supply is required to maintain an impedance state), it should be capable of easy integration to a target design on rigid as well as flexible substrates, it should be of low cost (i.e. the desired complete solution has to be fully printable), it should have a wide band frequency response and so on. RF engineering

domain in its present status offers a variety of switching solutions for reconfigurable devices [13]–[18]. Among these genius concepts, the necessity and uniqueness required for this application is ‘non-volatile’ nature of chosen technology. An available solution to this is the concept of memristive switches which are generally non-volatile.

In this study, we choose the memristive switching technology called Metal-Insulator-Metal (MIM) switches, which is derived from the concept of Programmable Metallization Cell (PMC) technology [19]. These devices were initially identified as Conductive Bridging Random Access Memory (CBRAM) technology [20], and later proved its metal for RF switching solutions [17], [18], [21], [22].

A Metal-Insulator–Metal switch as its name indicates has a layer structure in which two electrochemically asymmetric electrode pairs sandwich a layer of ion conductor as shown in Fig. 1. One of the electrodes is an active ion donor like silver (Ag) or copper (Cu) and the other is a relatively inert electrode like aluminum (Al) or gold (Au). The ion-conductor is a compound which is an ‘ion conductor’ and an electronic insulator. Upon the application of an electric field, which is positive with respect to the active electrode, would initiate a redox mechanism. Enabling the electro-migration of dissolved positive ions from the donor electrode, leading to an electro-deposition (set operation) of a metallic filament towards the inert electrode, resulting in a low impedance state across the cell. An electric field of inverse polarity to the former would reverse the process and lead to dissolution of filament (reset operation) leading to increase of impedance across the cell.

A MIM cell could be modeled as an RC parallel network as shown in Fig. 1, whose resistance ( $R_{\text{MIM}}$ ) is the filament resistance observed across cell and capacitance ( $C_{\text{MIM}}$ ) similar to the calculated parallel plate capacitance due to geometry of electrodes, dielectric spacing, and dielectric properties of ion conductor used [9], [21].

In this article we address some techniques, and their advantage, of using CBRAM/MIM technology for rewritable chipless RFID applications. We also revisit the benefits of using Nafion as an ion conductor for potentially printable MIM switch applications, using fabrication steps compatible

for mass production, and necessarily without using any ‘clean room’ technologies.

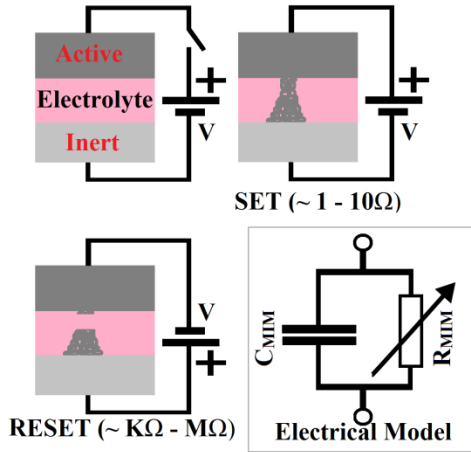

Fig. 1. Layer architecture of MIM switch and its Electrical Model.

## II. REWRITABLE CHIPLESS RFID TAGS

A multi scatter based chipless RFID system, as explained in brief in the introduction part, is composed of an identifier, which is generally referred to as the ‘tag’, and a reader system similar in operation to a bistatic radar system [5], [10]. The tag consists in it a group of RF resonators that exhibit narrow band resonance at certain preset position in a given bandwidth, to represent a predefined code. The data encoding is made by assigning a frequency position to each resonator on the tag and this could be easily identified by looking at the radar cross section (RCS) response of the tag. Numbers of resonators on the tag, or resonant frequency positions in the RCS response, are directly proportional to the coding capacity of a tag. One of the great advantages of a chipless RFID system is the flexibility obtained with respect to reader system. Any reader system with desired accuracy for capturing the RCS response could be used with all types of tags [5]. Our efforts are in the direction such that the chipless RFID technology could be used as a versatile identifier, as popular, or even beyond the current optical barcode system. Fig. 2 shows the proposed typical chipless RFID system.

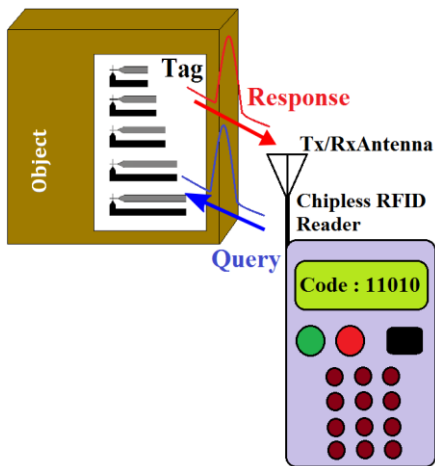

Fig. 2. Multi scattered based chipless RFID system.

Another ground breaking functionality that would embolden the concept of multi scatterer based chipless RFID is ‘electronic rewriteability’. One of the limitations to

widespread use of this technology, in comparison to the often referred counterpart, the optical barcode system, is the manufacturing cost per unit tag. Despite the fact that at low cost, metallic traces could be realized on flexible substrates like paper, using techniques like inkjet printing and flexography [23], each code combination on a chipless tag is achieved by reconfiguring the size of a metallic resonator to introduce a frequency shift in its resonance. For this, it is necessary to provide individual attention to each scatter, right from the design stage, till the end of manufacturing processes, which impacts too much on the total financial budget and time. Some of the reported improvements to this issue are the mechanical reconfigurability. This is achieved by manufacturing the entire combination of chipless tags in a batch as a single copy, and then using techniques like micro machining, or laser lithography, or metallic inkjet printing etc. to reconfigure each scatter, on each tag to represent a desired code [24], [25].

However, one consistent solution to the issue of reconfigurability is the addition of a non-volatile RF switch to a chipless tag. Such an approach would be complimented by the following advantages. If the electrical size of a resonator could be electronically reconfigured to obtain multiple resonance frequencies using an integrated switch (like the proposed MIM switch), and if a dedicated low cost process is optimized for this technique, then one could manufacture the entire combination of chipless tags in a batch, as a single copy. Then, each tag could be electronically written or rewritten by the consumer, at the time of application, to constitute a desired code combination. Thus cutting down the budget and time invested on each unit tag. Fig. 3 explains this concept, by showing the advantage on integration of the proposed MIM switch in a RF resonator for chipless RFID technology. The coding capacity ‘N’ of such a tag with ‘k’ number of resonators is given by eq. (1) [4], [9]. Where,  $\Delta f$  is the total bandwidth allocated to a tag and  $df$  is the bandwidth of resonance of each resonator.

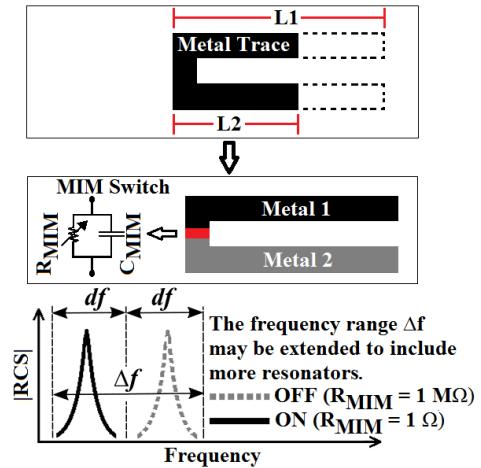

Fig. 3. Concept of reconfigurable/rewritable chipless RFID tag.

$$N = \left\lfloor \frac{\Delta f}{df} \right\rfloor^k \quad (1)$$

In the following sections, we explain in detail about the proposed MIM switches and its fabrication process. We also present some examples of proposed electronically rewritable resonators for use in chipless RFID tags.

### III. NAFION BASED NANO-IONIC CONDUCTIVE BRIDGING MIM SWITCHES

Conductive bridging MIM switches are identified as a versatile and promising RF switching solution since the past few years. This technology has certain specific advantages like improved reliability, ease of fabrication, lower process temperature and similar, in comparison to sibling counter parts of memristive switching family, like the Phase Change Memory (PCM) switches [16], [26]. Several compositions of ion-conductors are found suitable for MIM switch applications. Some commonly used compounds are silicon dioxide [27], chalcogenide glass [18], [19], ion-conducting polymers like PEO [28], and even precisely controlled thin air gaps [17].

Ease of fabrication and compatibility with mass industrial production is a key point in the choice of a technology. One could observe in most cases cited above, that these technologies necessarily require a ‘clean room’ facility for fabrication, and this increases the complexity of mass production. However, we could see that the choice of moldable polymers like PMMA or Nafion bring a great relief and innovation to this problem, enabling realization of CBRAM/MIM switches integrated into passive RF devices using simple fabrication steps. [21] and [9] reports a process for fabrication of Nafion based MIM switches for RF applications, with simple fabrication steps, and without using any ‘clean room’ techniques. These articles respectively present an RF switch and a rewritable resonator for chipless RFID applications. [29] reports the extension of this technology, once again simplified, for fabrication of RF switches and rewritable resonators on flexible paper substrates.

In this section, we present an example of MIM switches fabricated on a classic substrate to prove the switching reliability of the proposed technology. Then we discuss the merits of reported devices, fabricated using this technique. Fabrication process of the proposed MIM switches is as follows, and the topology of these devices is depicted in Fig. 4. Realization of the device is done on a classic FR-4 epoxy substrate. The MIM module consists of three layers, bottom electrode (Cu), ion-conductor (Nafion), and top electrode (Al). An electro-polishing of Cu was performed to minimize surface roughness to get a smooth surface for deposition of ion conductor, this is explained in detail in the following paragraphs. Ion conductor layer is formed by spin coating Nafion perfluorinated resin solution (supplied by Sigma Aldrich), with a spin rate of 500 rpm for 30s (preset rate for a thickness of 500-600nm). Ion-conductor layer thus formed is dried on a hot plate at 45°C for 30s. Nafion layer thickness is a critical parameter which influence the standard ON (set) and OFF (reset) state resistance of MIM switches. Aluminum is chosen as the inert electrode and is formed by thermal vapor deposition technique, using a dedicated Nickel mask with an engraved aperture of 121 dots of 1mm each in diameter (See Fig. 4). Thickness of copper and aluminum layers are respectively 35µm and 1µm.

Electrical measurements are done at room temperature with a Keithley 2400 sourcemeter, using a dedicated Labview GUI, on a probe station. An optimized current limited voltage waveform as shown in Fig. 5 is used to study the switching dynamics of MIM cells. This waveform consists of two parts, for ON/set (triangular waveform period I and II) and OFF/reset (square pulse, period III) process of

the switch as shown in Fig. 5. This is explained in detail in a following paragraph.

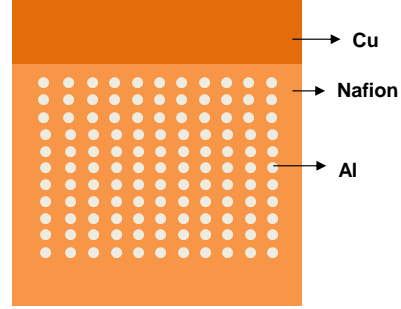

Fig. 4. Topology of MIM cells fabricated on copper clad FR-4 substrate.

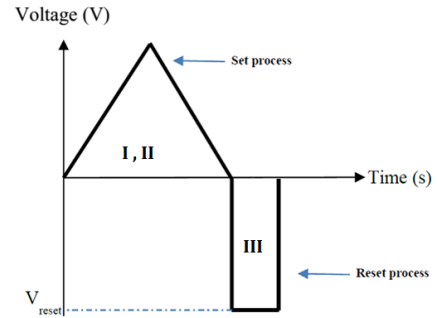

Fig. 5. ON (set)/ OFF (reset) waveform.

In order to lower copper roughness, an electro-polishing has been performed. In electro-polishing process, FR-4 with laminated Cu is immersed in a bath of electrolyte and serves as anode, which is connected to the positive terminal of a DC power supply. A platinum (Pt) cathode is attached to negative terminal of the DC power supply. A current flow from anode to cathode would lead to oxidization of copper and its dissolution in electrolyte, giving a smooth copper surface. At cathode, a reduction reaction occurs, which produces hydrogen. We realize four samples with the same electro-polishing process for proving reproducibility. Conductivity and copper roughness after treatment are shown in TABLE I. for the four different samples. One can note that conductivity is close to the value of bulk copper, and roughness is between 225 nm and 515 nm.

TABLE I. shows experimental conditions and experimental results of Al/Nafion/Cu resistive switching devices for samples after electro-polishing of copper. For these four samples, out of 121 memory cells tested on each, at least 80% show reliable resistive switching characteristics with more than 50 cycles of operation. These results also highlight that a better switching reliability is obtained when Cu roughness is lower.

TABLE I. PERFORMANCE OF AL/NAFION/CU MIM SWITCHES FOR DIFFERENT EXPERIMENTAL CONDITIONS

Sample No.	Conductivity and Roughness of Cu after electro-polishing	Number of cells switching, at least 50 cycles, among 121
1	$5.03 \times 10^7 S m^{-1} / 442.8 \text{ nm}$	100 (80%)
2	$5.67 \times 10^7 S m^{-1} / 226.8 \text{ nm}$	121 (100%)
3	$5.13 \times 10^7 S m^{-1} / 225.5 \text{ nm}$	121 (100%)
4	$5.96 \times 10^7 S m^{-1} / 515.8 \text{ nm}$	100 (80%)

As shown in Fig. 6, to program resistance switches, we define a maximum set voltage ( $V_{set}$ ), a reset voltage ( $V_{reset}$ ), and a compliance current, of 12V, -20V, and 0.5mA, respectively. The switching process can be divided into three time frames. In time frame I, Al/Nafion/Cu device begins to form the conductive-filament and the resistance is still high  $5.1 \times 10^7 \Omega$ . After this, we see the set of a switch marked by an abrupt fall in voltage and rise in current as shown between 3-5 seconds in Fig. 6. In time frame II, the conductive-filament has already been formed, the circuit is in ON-state and resistance transited from high to low value. In time frame III, an inverse voltage is applied to the Al/Nafion/Cu device, which makes the conductive-filament to dissolve.

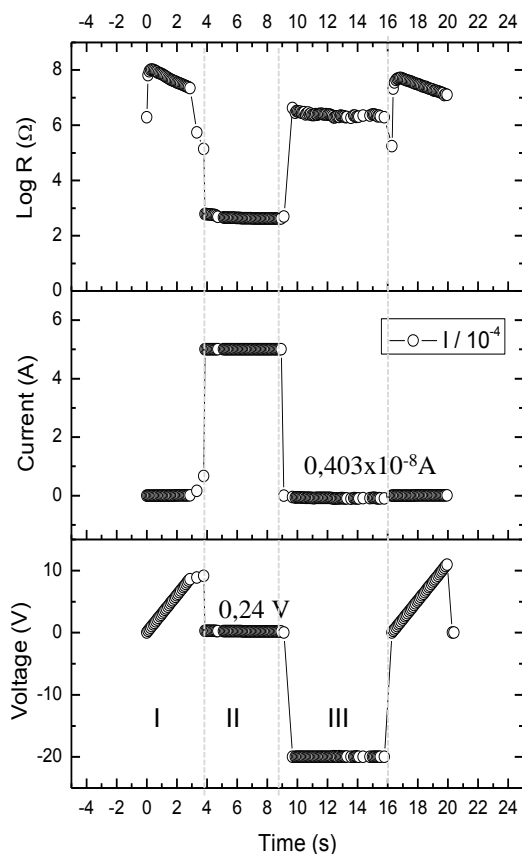

Fig. 6. V, I and R response of MIM switch with one ON-OFF cycle.

Now cell is in OFF-state and resistance changes from low to high value. The measured time-dependent resistance for aforementioned four samples is shown in Fig. 7 and Fig. 8. In this experiment, observed resistance fluctuation for each cell during continuous switching is low. We can observe that ratio of  $R_{OFF}$  to  $R_{ON}$  for each device during 500 s ( $\sim 50$  cycles) is around  $10^6 \Omega$ . Sample 4, has the highest  $R_{OFF}/R_{ON}$  ratio,  $10^6 \Omega$ .

One could see in this experiment that a MIM switch with the proposed structure, realized using a simple fabrication process is capable of switching at least 50 cycles in around 500s, continuously, without damage. This proves the switching reliability of these devices. These results are also proved to be reproducible for all switches in a sample, for several batches. This experiment also proves the feasibility of proposed fabrication process, for Nafion based MIM switches. Without any clean room technologies, and

compatible with mass production, thus satisfying the primary objective of this study.

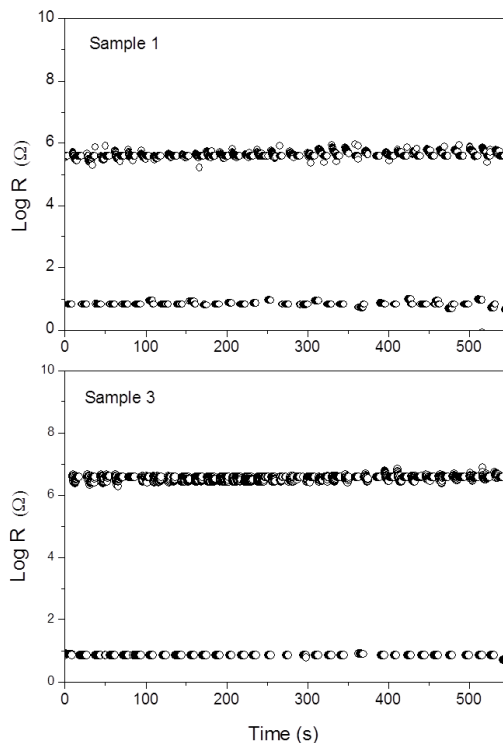

Fig. 7. Performance of Al/Nafion/Cu MIM switches with varying result of electro-polishing : Sample 1 and Sample 3.

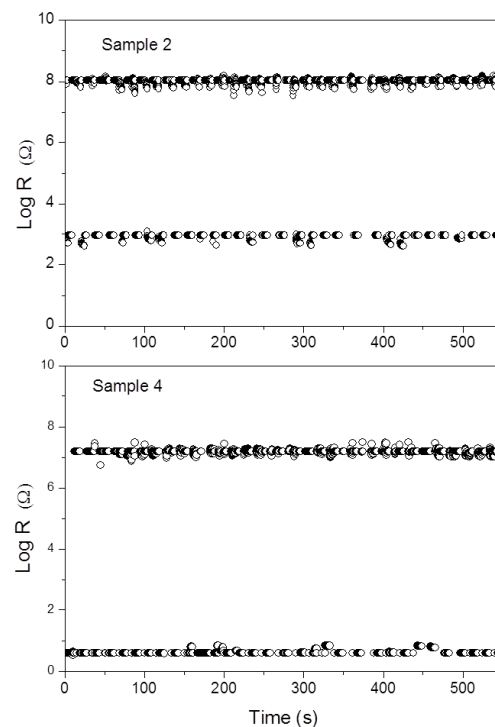

Fig. 8. Performance of Al/Nafion/Cu MIM switches with varying result of electro-polishing : Sample 2 and Sample 4.

#### IV. FIRST RESULTS OF MIM BASED RF SWITCH AND ELECTRONICALLY REWRITABLE CHIPLESS RFID TAG WITH ONE RESONATOR

We could see from the above experimental results that the CBRAM/MIM switch technology is a good non-volatile



switching technology. [21] and [9] reports respectively a potentially printable CPW based RF switch and a reconfigurable resonator for multi-scatterer based chipless RFID applications. [29] reports the extension of these devices on flexible paper substrate using a 3-step process compatible for mass production. Fig. 9 to Fig. 12 shows the photograph and captured RF performance, of these devices for immediate information to the readers.

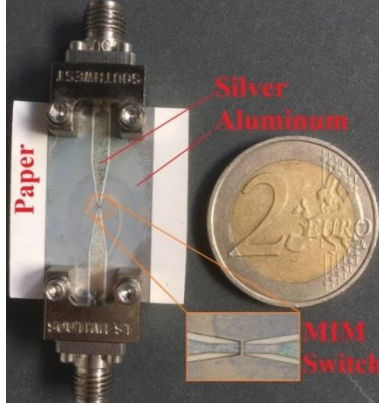

Fig. 9. CBRAM/MIM based CPW shunt mode RF-switch on paper substrate showing the microphotograph of MIM switch area in inset [29].

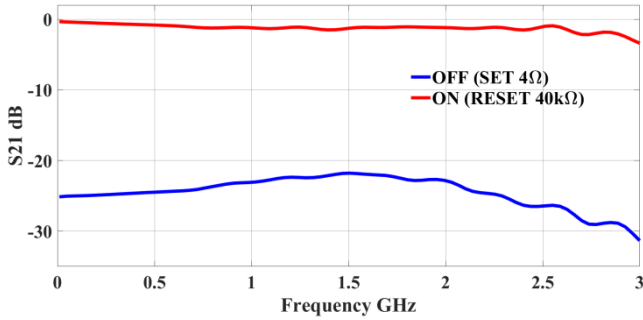

Fig. 10. Experimentally obtained S21 response of CBRAM/MIM based CPW shunt mode RF-Switch [29].

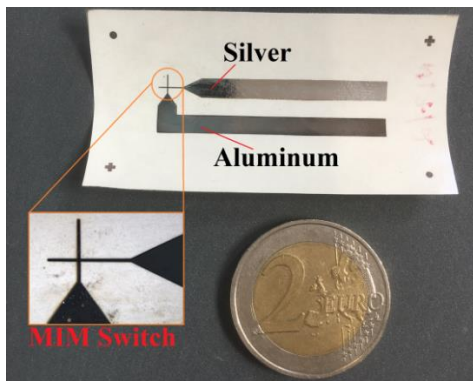

Fig. 11. Photograph of CBRAM/MIM switch integrated, electronically reconfigurable, resonator for chipless RFID applications, on paper substrate [29].

## V. PROPOSED MULTI SHAPE RECONFIGURABLE RESONATOR FOR CHIPLESS RFID APPLICATIONS

To go beyond, with inspiration from these results, we propose here a shape reconfigurable unit cell resonator element for chipless RFID applications. Topology of the proposed unit cell is depicted in Fig. 13. This unit cell is

composed of short metallic traces, connected among two adjacent traces by 9 MIM switches modeled as its respective electrical model with  $R_{MIM} = 1\Omega$  (set),  $1M\Omega$  (reset) and  $C_{MIM} = 1pF$ . These values are chosen through experience from previous realizations and its electrical models [9], [21], [30]. A particular shape/current path could be defined in the unit cell by respectively switching ON (set) MIM switches, for a desired frequency response. Fig. 13 shows three paths modeled, in full-wave simulation studies, whose results are depicted in Fig. 14. MIM switches along these paths are in ON (set) state and all other switches are kept OFF (reset).

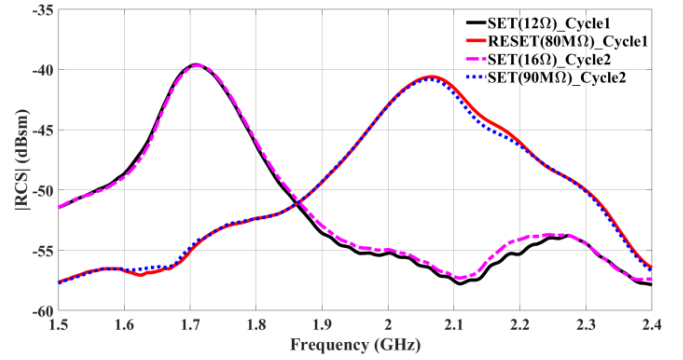

Fig. 12. RCS response of electronically reconfigurable resonator for chipless RFID tags on paper substrate [29].

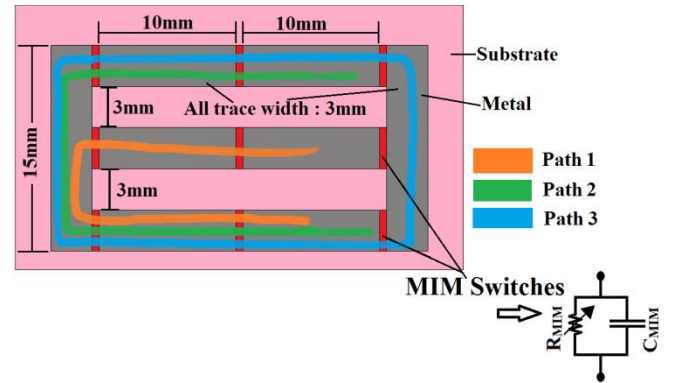

Fig. 13. Topology of proposed shape/frequency reconfigurable resonator unit cell for chipless RFID applications.

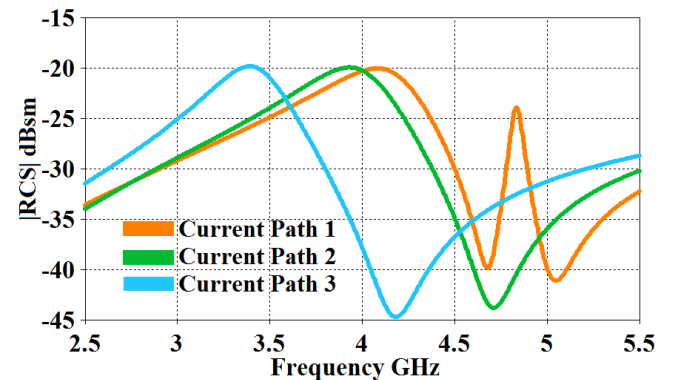

Fig. 14. Simulated RCS response of proposed shape/frequency reconfigurable resonator unit cell, for chipless RFID applications.

One could observe here, that the RCS response of presented resonator could be reconfigured electronically by switching the MIM cells to constitute a desired code. These simulation results serve to present an immediate idea of proposed technique, to the reader. Electrical model of MIM switches used in this unit cell resonator would be replaced by

modifying the structure to integrate real MIM switch layers. Multiple unit cells could be cascaded to achieve a response of desired bit length, for a required number of combinations. Authors are currently working on the real world implementation of the idea, and whose results are expected to be published soon.

## VI. CONCLUSION

In this article, we have presented the significance of proposed non-volatile CBRAM/MIM switching technology for electronically rewritable chipless RFID tags. We have proved the dynamic switching reliability of Al/Nafion/Cu CBRAM/MIM switches through experimental results. This work shows the potential of Nafion as solid electrolyte (ion-conductor) in resistive memory based switches and explores the understanding of switching mechanisms. At least 80 % of all MIM cells of Al/Nafion/Cu shows reliable switching for a minimum of 50 switching cycles. These results indicate that switching characteristic of Al/Nafion/Cu metal insulator metal (MIM) structure makes it a technology compatible for low power applications, having non-volatile switching requirements.

We have presented the simulation studies of a unit cell of shape-reconfigurable resonator, utilizing MIM switches. This unit cell could be cascaded to a grid of required size and then reconfigured by set/reset of corresponding MIM switches to obtain a required shape/electromagnetic response. Optimizations for realization of these techniques are in progress with the authors and are expected to be presented in near future.

## ACKNOWLEDGMENT

This project has received funding from the European Research Council (ERC) under the European Union's Horizon 2020 research and innovation program (grant agreement No 772539). This work was also supported by Univ. Grenoble Alpes, and by the Institut Universitaire de France.

## REFERENCES

- [1] Etienne Perret, *Radio Frequency Identification and Sensors: From RFID to Chipless RFID*. Hoboken, NJ, USA: Wiley, 2014.
- [2] S. Tedjini, N. Karmakar, E. Perret, A. Vena, R. Koswatta, and R. E-Azim, "Hold the Chips: Chipless Technology, an Alternative Technique for RFID," *IEEE Microw. Mag.*, vol. 14, no. 5, pp. 56–65, Jul. 2013.
- [3] N. C. Karmakar, "Tag, You're It Radar Cross Section of Chipless RFID Tags," *IEEE Microw. Mag.*, vol. 17, no. 7, pp. 64–74, Jul. 2016.
- [4] Arnaud Vena, Etienne Perret, and Smail Tedjini, *Chipless RFID based on RF Encoding Particle: Realization, Coding and Reading System*. New York, NY, USA: ISTE-Elsevier.
- [5] Marco Garbati, Etienne Perret, Romain Siragusa, *Chipless RFID Reader Design for Ultra-Wideband Technology - 1st Edition*, 1st ed. ISTE Press - Elsevier, 2018.
- [6] I. Jalaly and I. D. Robertson, "Capacitively-tuned split microstrip resonators for RFID barcodes," in *2005 European Microwave Conference*, Paris, France, 2005, vol. 2.
- [7] S. Preradovic and N. C. Karmakar, "Chipless RFID: Bar Code of the Future," *IEEE Microw. Mag.*, vol. 11, no. 7, pp. 87–97, Dec. 2010.
- [8] E. M. Amin, M. S. Bhuiyan, N. C. Karmakar, and B. Winther-Jensen, "Development of a Low Cost Printable Chipless RFID Humidity Sensor," *IEEE Sens. J.*, vol. 14, no. 1, pp. 140–149, Jan. 2014.
- [9] M. P. Jayakrishnan, A. Vena, B. Sorli, and E. Perret, "Solid-State Conductive-Bridging Reconfigurable RF-Encoding Particle for Chipless RFID Applications," *IEEE Microw. Wirel. Compon. Lett.*, vol. 28, no. 6, pp. 506–508, Jun. 2018.

- [10] A. Vena, E. Perret, and S. Tedjini, "Chipless RFID Tag Using Hybrid Coding Technique," *IEEE Trans. Microw. Theory Tech.*, vol. 59, no. 12, pp. 3356–3364, Dec. 2011.
- [11] A. A. C. Alves, D. H. Spadoti, and L. L. Bravo-Roger, "Optically Controlled Multiresonator for Passive Chipless Tag," *IEEE Microw. Wirel. Compon. Lett.*, vol. 28, no. 6, pp. 467–469, Jun. 2018.
- [12] A. Vena, B. Sorli, Y. Belaizi, B. Saggini, and J. Podlecki, "An Inkjet Printed RFID-Enabled Humidity Sensor on Paper Based on Biopolymer," in *2018 2nd URSI Atlantic Radio Science Meeting (AT-RASC)*, 2018, pp. 1–3.
- [13] S. L. Chen, P. Y. Qin, W. Lin, and Y. J. Guo, "Pattern Reconfigurable Antenna with Five Switchable Beams in Elevation Plane," *IEEE Antennas Wirel. Propag. Lett.*, vol. PP, no. 99, pp. 1–1, 2018.
- [14] G. Chaudhary, Y. Jeong, and J. Lim, "Dual-Band Bandpass Filter With Independently Tunable Center Frequencies and Bandwidths," *IEEE Trans. Microw. Theory Tech.*, vol. 61, no. 1, pp. 107–116, Jan. 2013.
- [15] C. L. Goldsmith, Z. Yao, S. Eshelman, and D. Denniston, "Performance of low-loss RF MEMS capacitive switches," *IEEE Microw. Guid. Wave Lett.*, vol. 8, no. 8, pp. 269–271, Aug. 1998.
- [16] M. Wang, Y. Shim, and M. Rais-Zadeh, "A Low-Loss Directly Heated Two-Port RF Phase Change Switch," *IEEE Electron Device Lett.*, vol. 35, no. 4, pp. 491–493, Apr. 2014.
- [17] S. Pi, M. Ghadiri-Sadrabadi, J. C. Bardin, and Q. Xia, "Nanoscale memristive radiofrequency switches," *Nat. Commun.*, vol. 6, p. 7519, Jun. 2015.
- [18] James Nessel and Richard Lee, "Chalcogenide nanoionic-based radio frequency switch," US 7.923,715 B2, 12-Apr-2011.
- [19] Michael N. Kozicki and William C. West, "Programmable metallization cell structure and method of making same," U.S. Patent 5,761,115, 02-Jun-1998.
- [20] Adesto Technologies, "RM24C32DS 32-Kbit 1.65V Minimum Non-volatile Serial EEPROM I2C Bus." Adesto Technologies, 2016.
- [21] M. P. Jayakrishnan, A. Vena, A. Meghit, B. Sorli, and E. Perret, "Nafion-Based Fully Passive Solid-State Conductive Bridging RF Switch," *IEEE Microw. Wirel. Compon. Lett.*, vol. 27, no. 12, pp. 1104–1106, Dec. 2017.
- [22] M. Dragoman, M. Aldrigo, and G. Adam, "Phased antenna arrays based on non-volatile resistive switches," *Antennas Propag. IET Microw.*, vol. 11, no. 8, pp. 1169–1173, 2017.
- [23] A. Vena *et al.*, "Design of Chipless RFID Tags Printed on Paper by Flexography," *IEEE Trans. Antennas Propag.*, vol. 61, no. 12, pp. 5868–5877, Dec. 2013.
- [24] A. Vena, A. A. Babar, L. Sydanheimo, M. M. Tentzeris, and L. Ukkonen, "A Novel Near-Transparent ASK-Reconfigurable Inkjet-Printed Chipless RFID Tag," *IEEE Antennas Wirel. Propag. Lett.*, vol. 12, pp. 753–756, 2013.
- [25] L. Zheng, S. Rodriguez, L. Zhang, B. Shao, and L.-R. Zheng, "Design and implementation of a fully reconfigurable chipless RFID tag using inkjet printing technology," in *ISCAS 2008. IEEE International Symposium on Circuits and Systems*, 2008, pp. 1524–1527.
- [26] N. El-Hinnawy *et al.*, "Low-loss latching microwave switch using thermally pulsed non-volatile chalcogenide phase change materials," *Appl. Phys. Lett.*, vol. 105, no. 1, p. 013501, Jul. 2014.
- [27] Y. Busby *et al.*, "Direct observation of conductive filament formation in Alq<sub>3</sub> based organic resistive memories," *J. Appl. Phys.*, vol. 118, no. 7, p. 075501, Aug. 2015.
- [28] M.-J. Song, K.-H. Kwon, and J.-G. Park, "Electro-Forming and Electro-Breaking of Nanoscale Ag Filaments for Conductive-Bridging Random-Access Memory Cell using Ag-Doped Polymer-Electrolyte between Pt Electrodes," *Sci. Rep.*, vol. 7, no. 1, p. 3065, Jun. 2017.
- [29] J. Methapettyparambu Purushothama, A. Vena, B. Sorli, and E. Perret, "Electronically Re-Configurable, Non-Volatile, Nano-Ionics-Based RF-Switch on Paper Substrate for Chipless RFID Applications," *Technologies*, vol. 6, no. 3, p. 58, Jun. 2018.
- [30] J. Methapettyparambu Purushothama, A. Vena, B. Sorli, and E. Perret, "Investigation of Integrated Solid State Nano-Ionic Metal-Insulator-Metal Switches for Electronically Reconfigurable Band Stop Filter Applications," *IET Microw. Antennas Propag.*, May 2019.