

# Study of convective condensation in a thermosiphon loop

Majed Eddine MOUSTAID

Cyril BUTTAY

Vincent PLATEL

23/07/2019

# Table of contents

- Project presentation
- Thermosyphon
- Condenser
- Results
- Conclusion

## Electronic project specifications

Thermal power per half-bridge ( <b>maximum</b> )	1,8 (4) kW
Power of module ( <b>worst case</b> )	600 (1330) W
Heat flux ( <b>worst case</b> )	4,3 (9) W cm <sup>-2</sup>
Baseplate temperature	70 °C
Atmosphere maximum temperature	40 °C

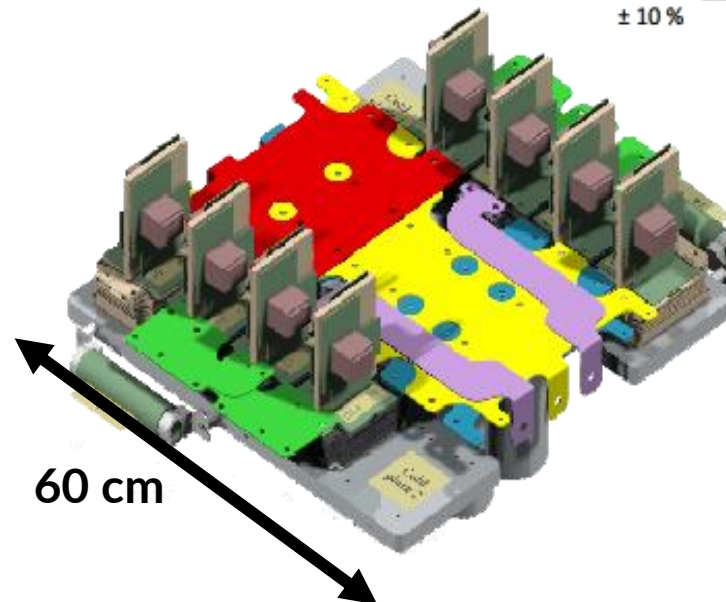
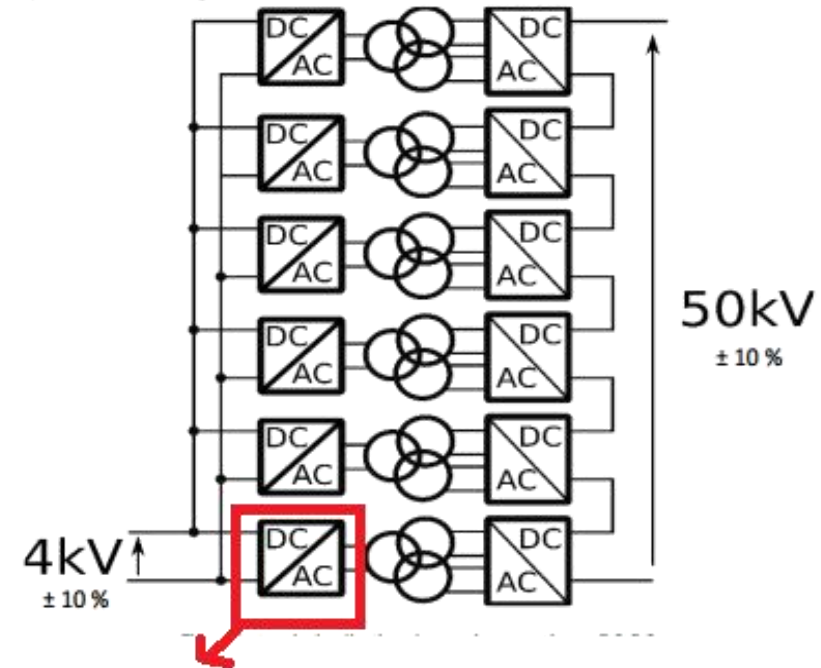

# Electronic project specifications

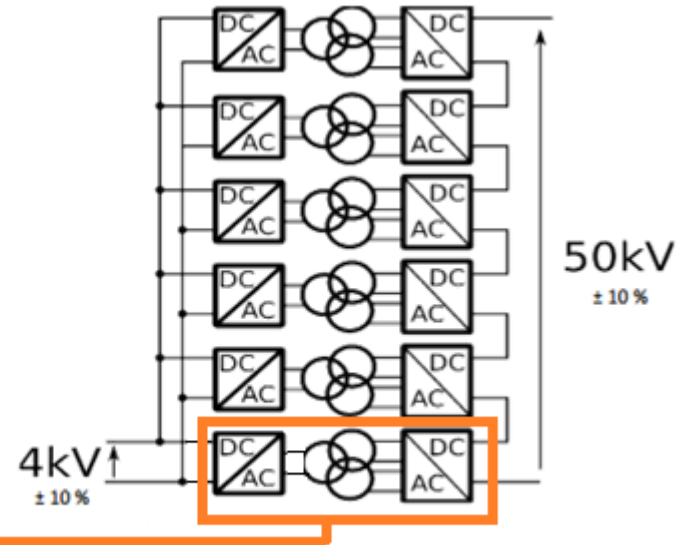
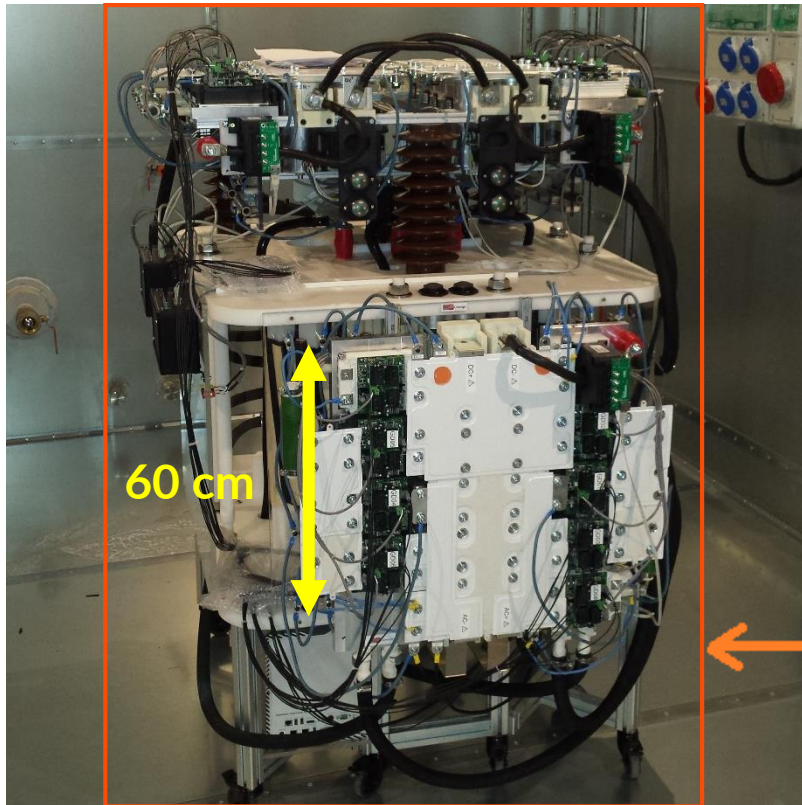

## Thermosiphon : general description

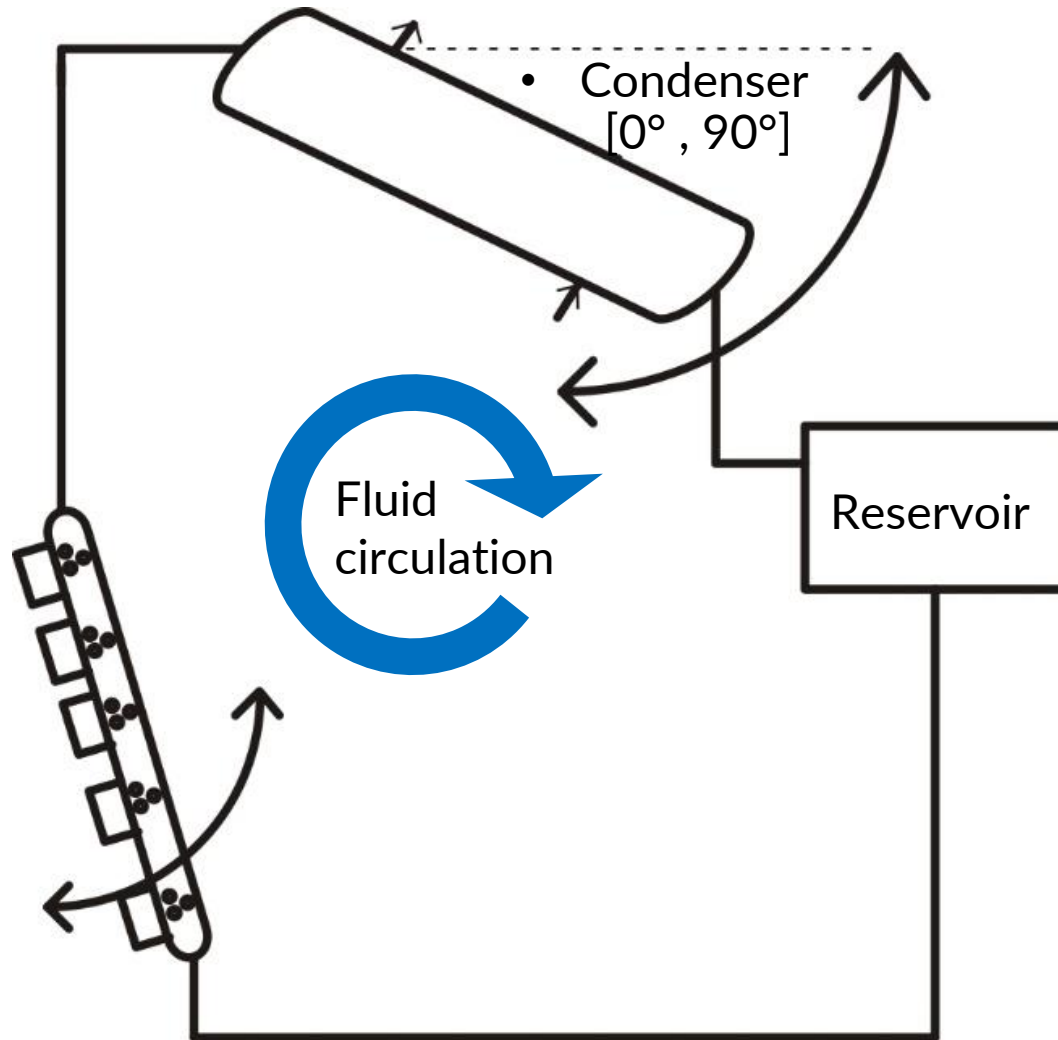

- Evaporator  
[0° , 90°]  
Power : 4 x 1100 W

- Condenser  
[0° , 90°]



# Thermosiphon : general description

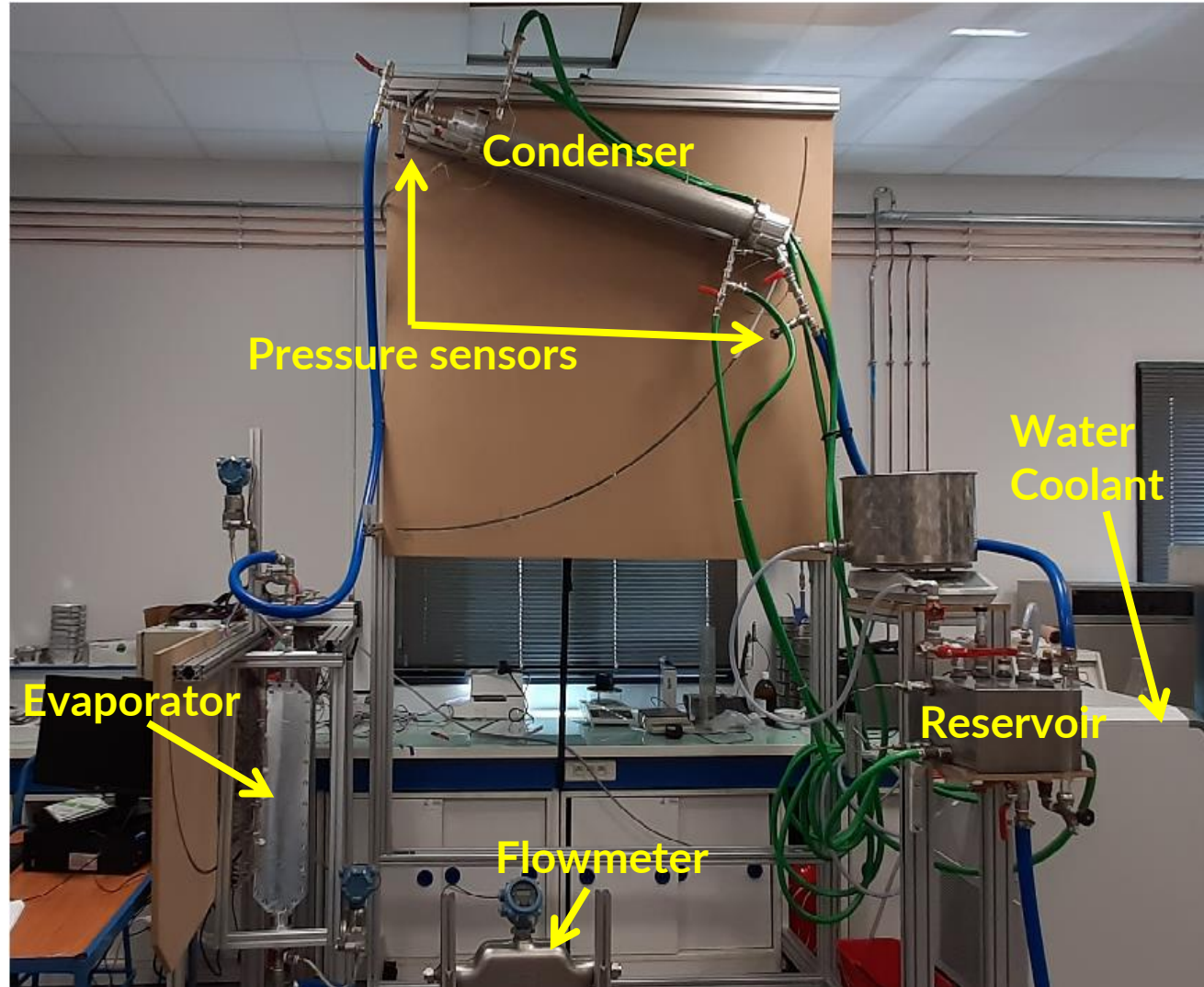

## Thermosiphon : evaporator

Material : aluminum

Hot plates : 1100 W each

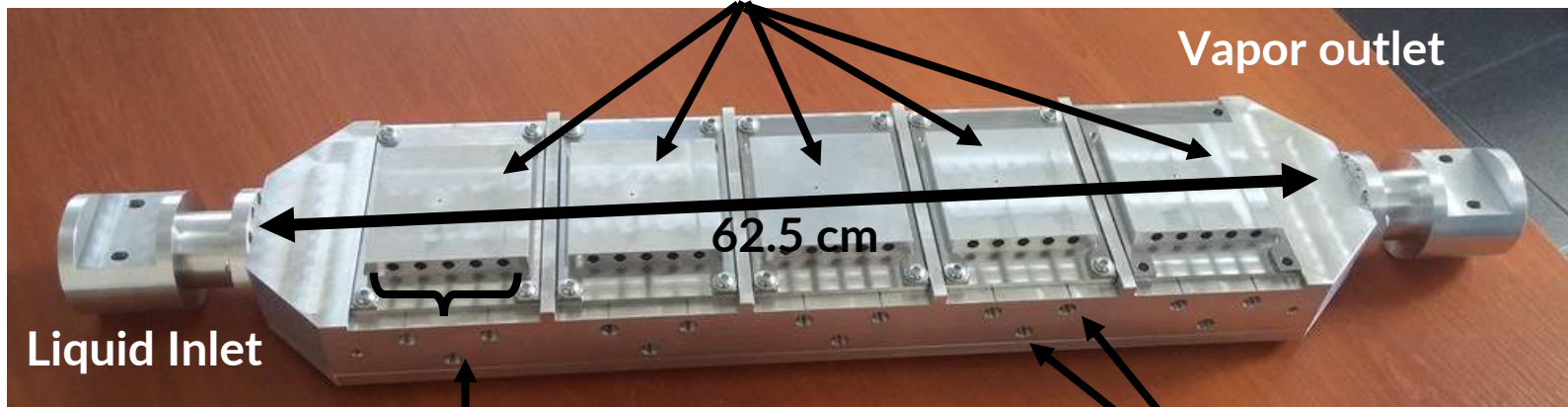

Cartridge heater entry

Thermocouple entry

## Thermosiphon : Fluid



Boiling Temperature °C (1 bar)

Liquid density  $\rho_L$  (kg m<sup>-3</sup>)

Vapor density  $\rho_V$  (kg m<sup>-3</sup>)

Latent heat  $H_{lv}$  (kJ kg<sup>-1</sup>)

Thermal conductivity (W m<sup>-1</sup> K<sup>-1</sup>)

Surface tension (mN m<sup>-1</sup>)

ODP (ozone)

GWP (global warming potential)

Non flammable

Solidification temperature (°C)

	<b>N649</b>	<b>R245fa</b>	<b>Water</b>
Boiling Temperature °C (1 bar)	<b>49</b>	15	100
Liquid density $\rho_L$ (kg m <sup>-3</sup> )	<b>1600</b>	1553	990
Vapor density $\rho_V$ (kg m <sup>-3</sup> )	<b>5,73</b>	5,9	0.1
Latent heat $H_{lv}$ (kJ kg <sup>-1</sup> )	<b>88</b>	180	2200
Thermal conductivity (W m <sup>-1</sup> K <sup>-1</sup> )	<b>0.059</b>	0.086	0,6
Surface tension (mN m <sup>-1</sup> )	<b>10,8</b>	14	70
ODP (ozone)	<b>0</b>	<b>0</b>	<b>0</b>
GWP (global warming potential)	<b>1</b>	<b>1030</b>	
Non flammable	✓	✓	✓
Solidification temperature (°C)	<b>-100</b>	-107	<b>0</b>



## Condenser : calculation

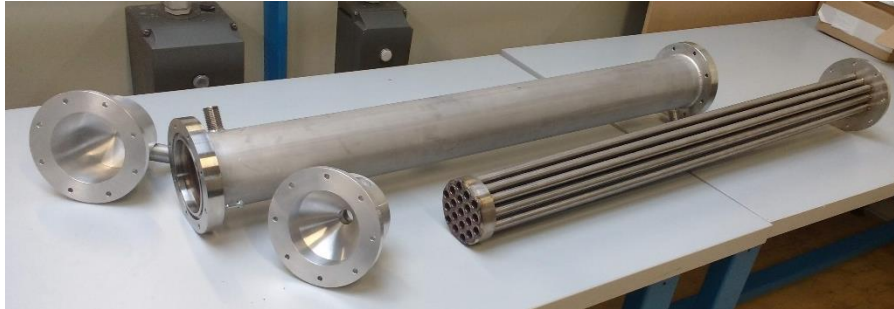

Calculating  $N$  the necessary number of tubes to condense the maximum power :

- Fluid at saturation at the inlet
- Mass and void fraction is set at 1 (full vapor)
- Cavallini & al correlation for condensation [1]
- Identical tubes
- Tubes length is set to 1m

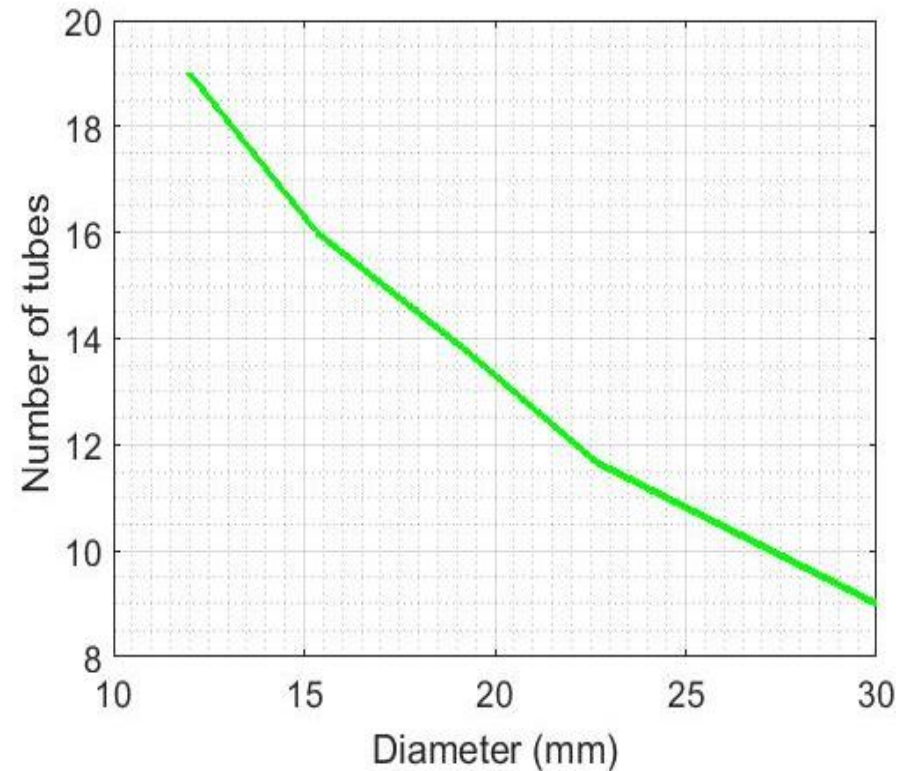

# Condenser : general description

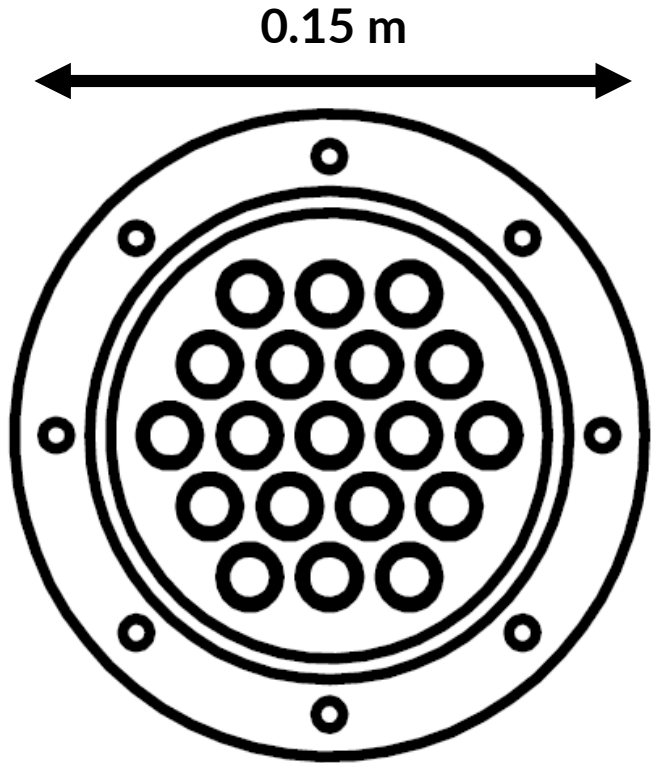
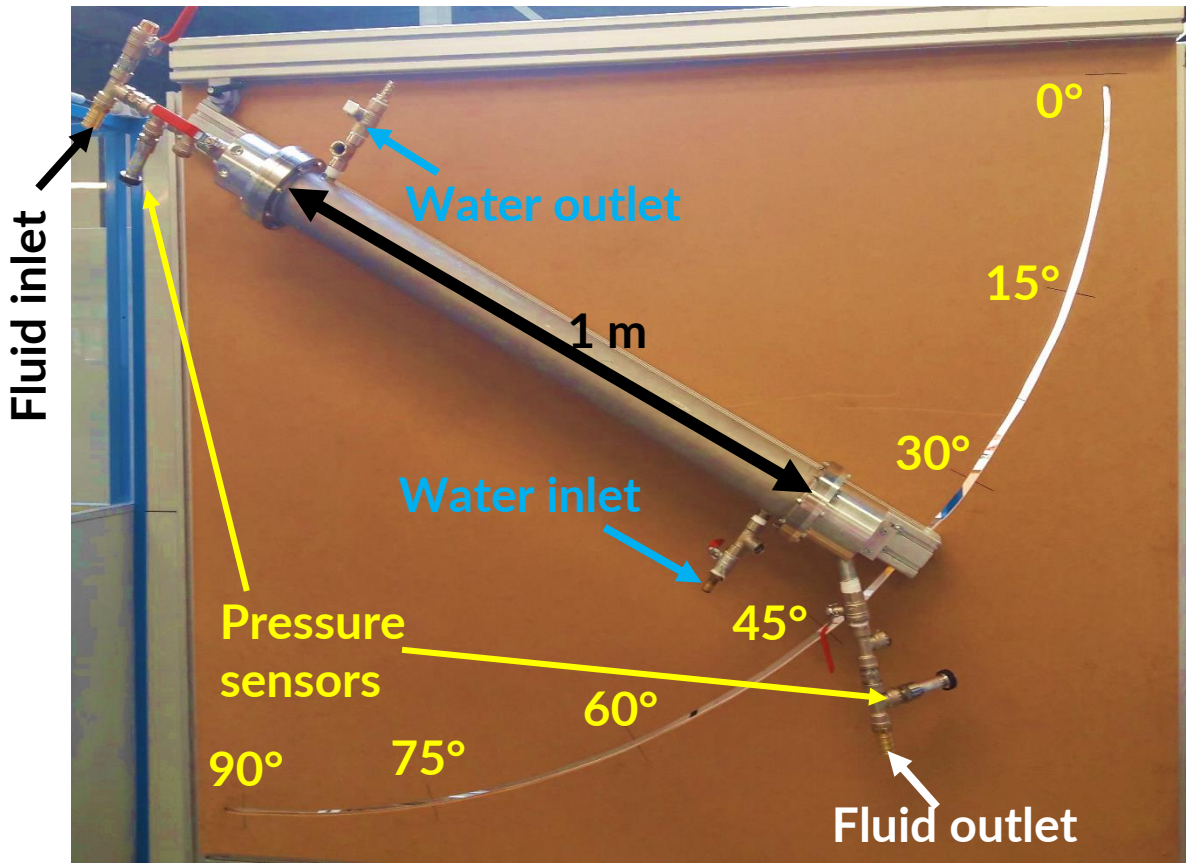

**Material : stainless steel**

## Test setup

Comparison criteria

$$\Delta T_{fw} = T_{fo} - T_{wo}$$

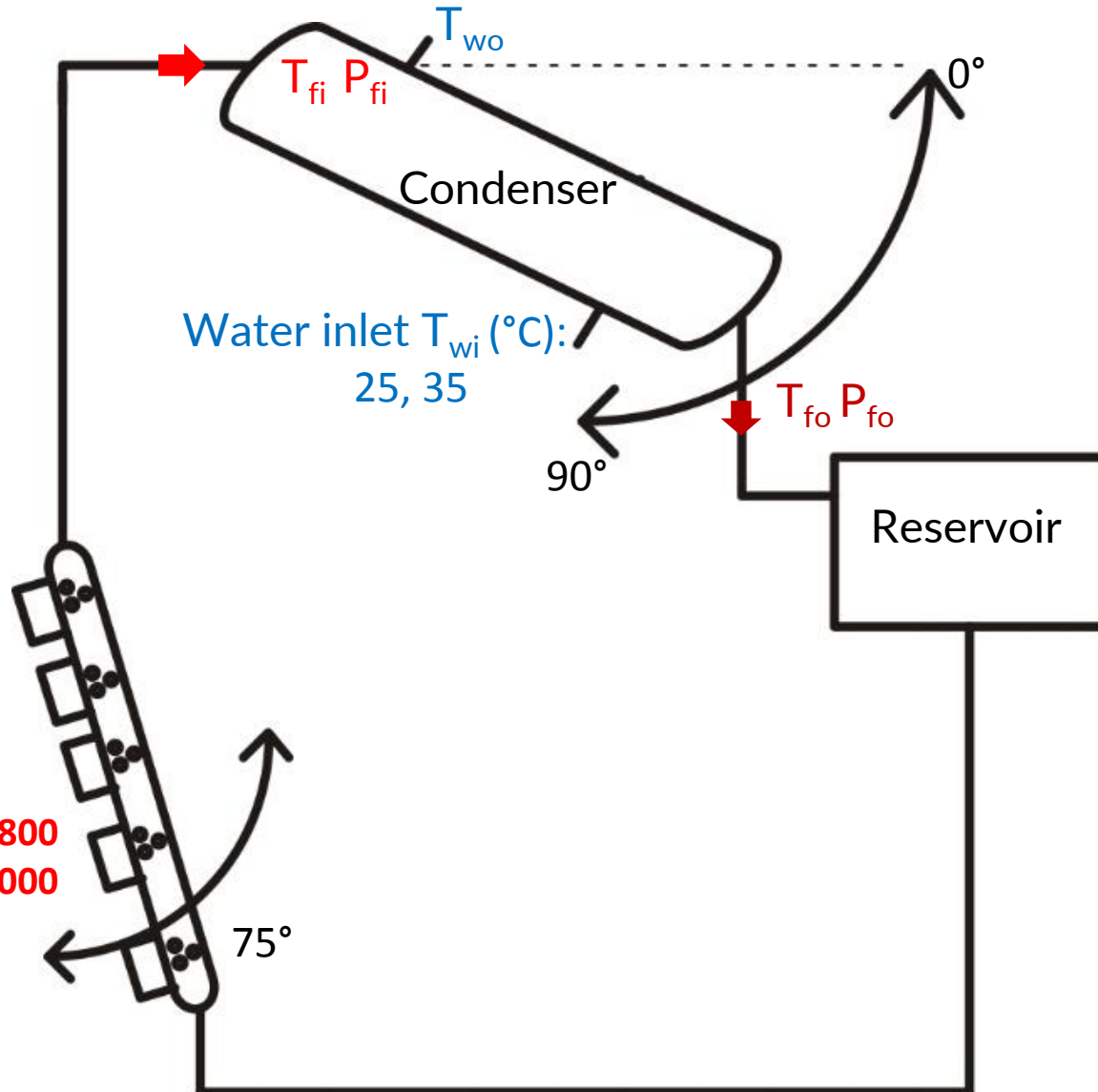

**Power input (W)** | 600, 900  
1200, 1500, 1800  
2100, 2400, 3000

## Results : Temperature measurement

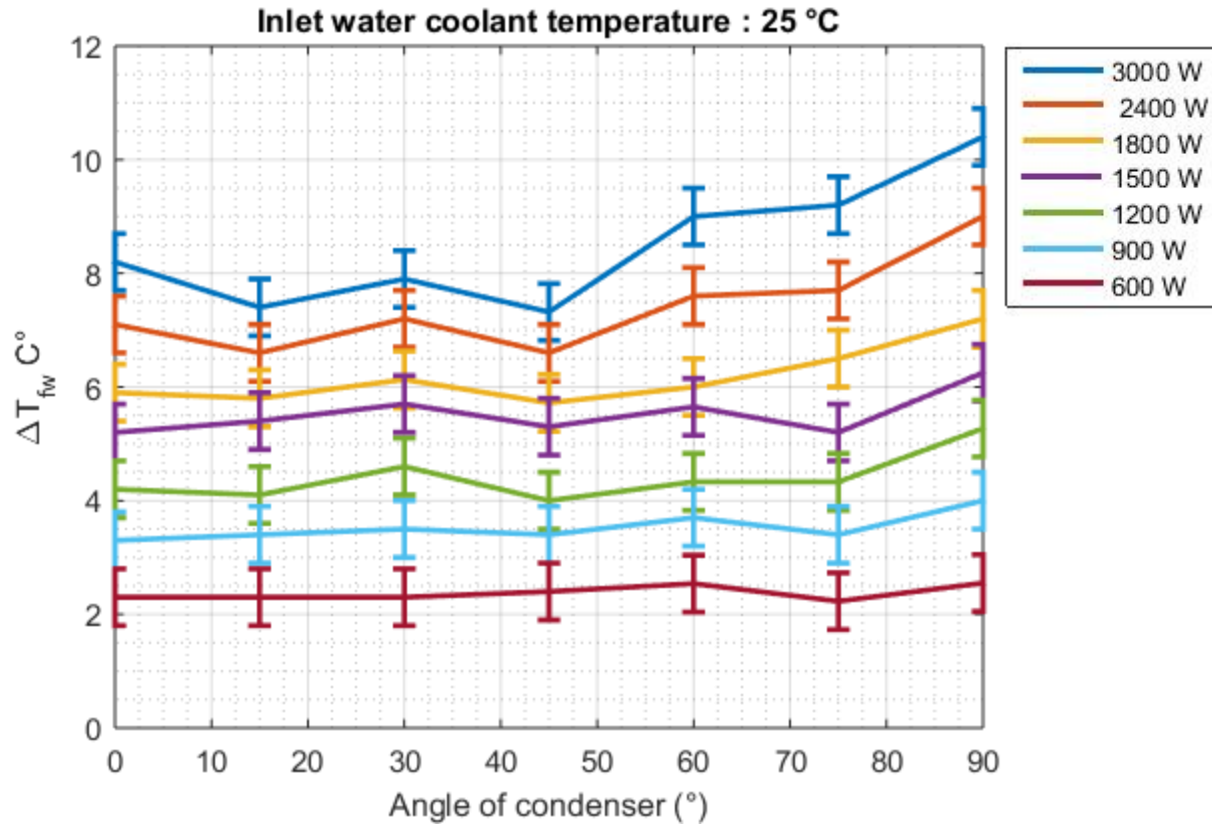

## Results : temperature measurement

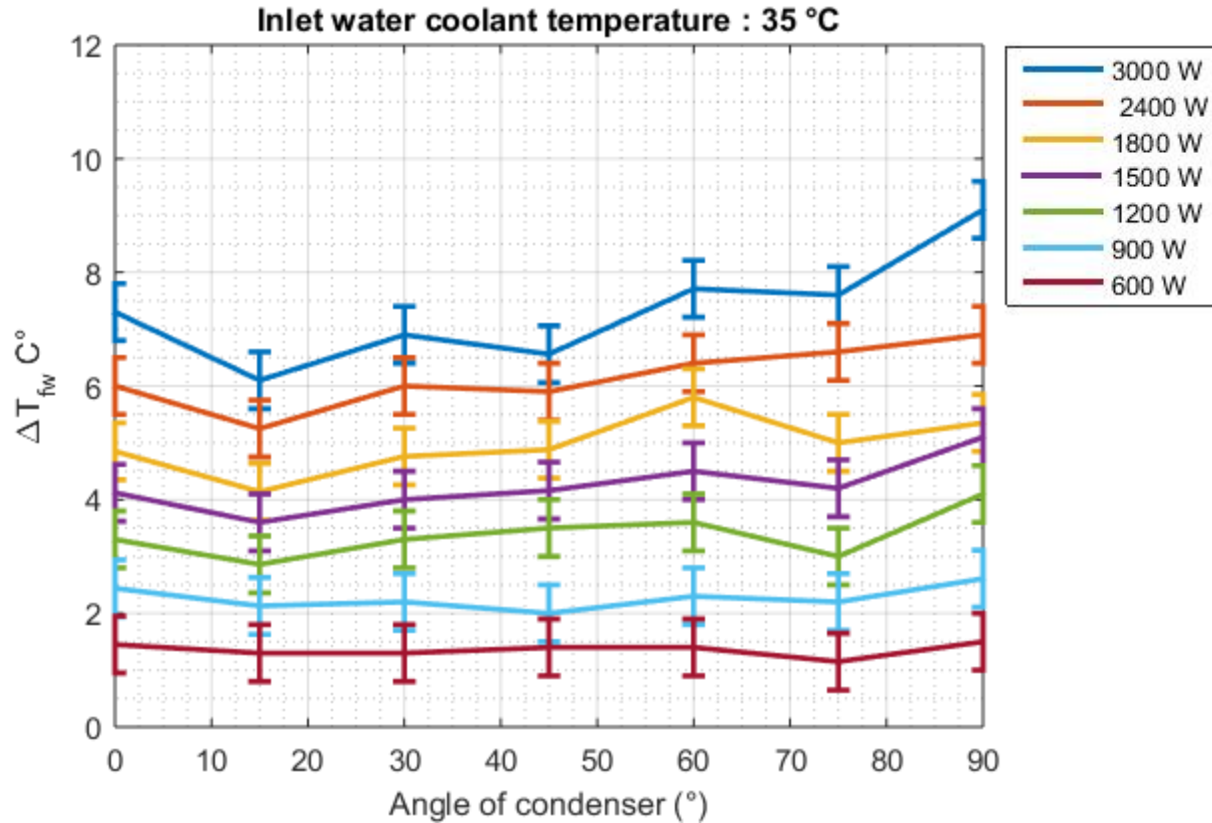



## Results : pressure measurement

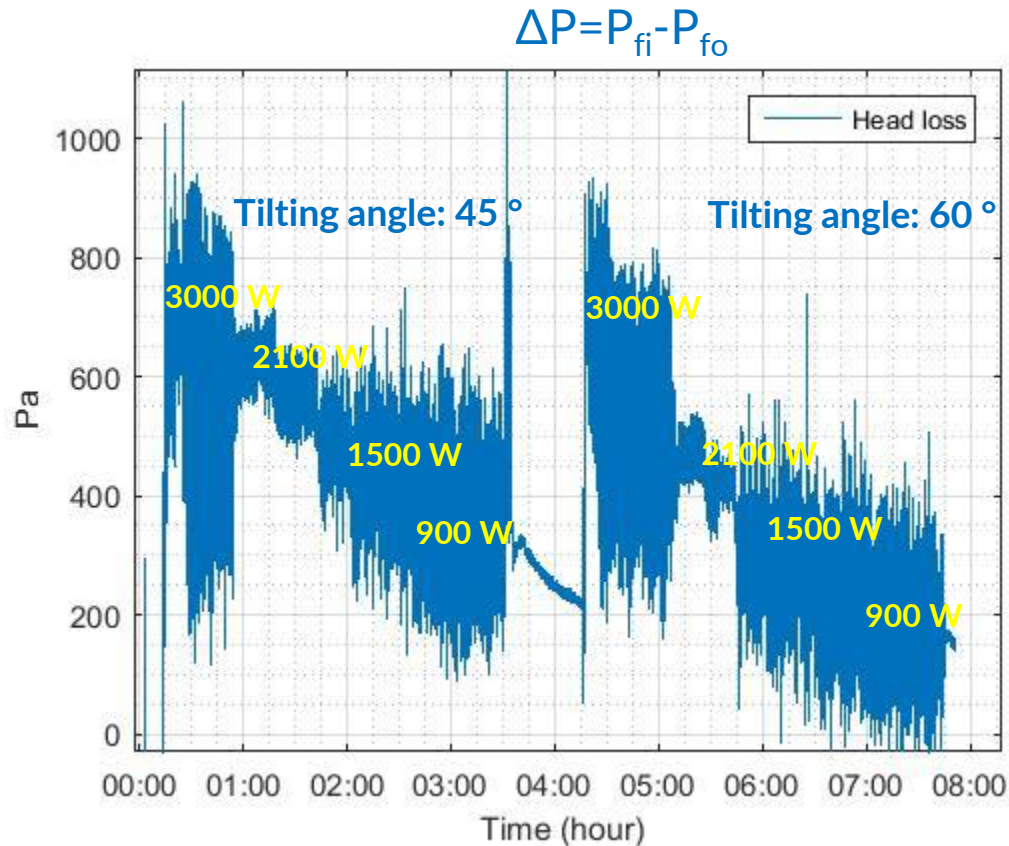

**Thermosyphon affects the fluid flow dynamic and makes it difficult to measure the condenser head loss**

## Results : pressure measurement

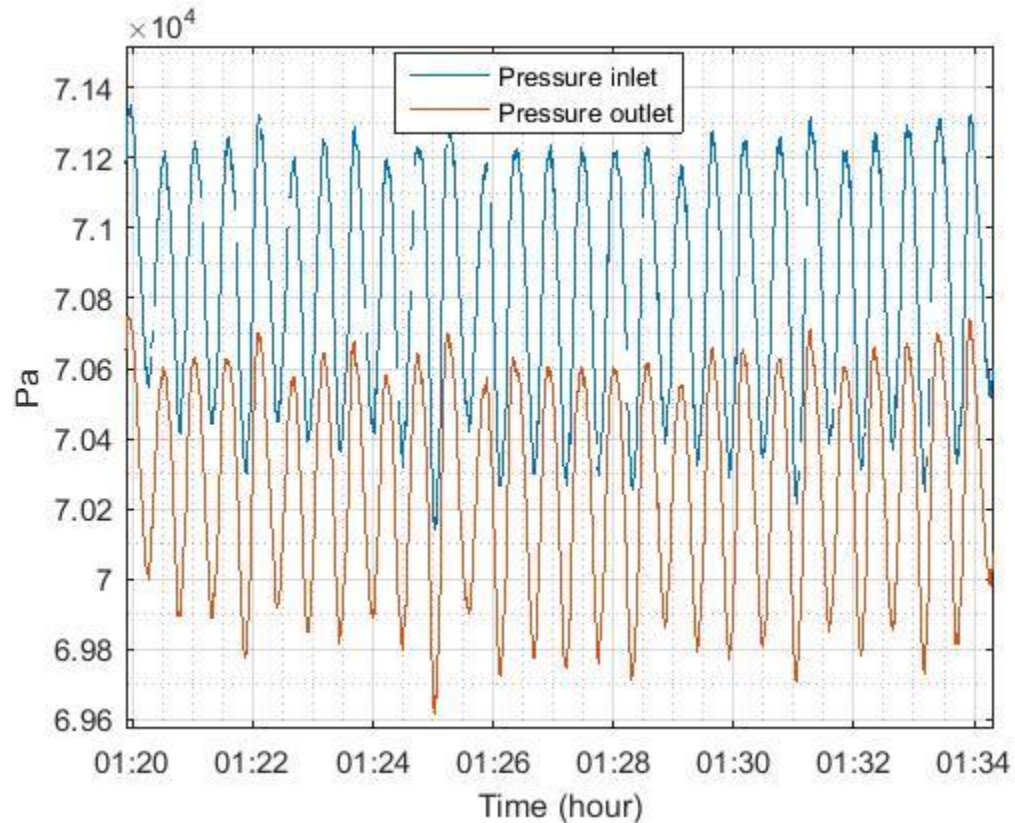

- Oscillation between evaporator and reservoir affects the dynamic in the condenser.
- Period of liquid coming and going in the thermosiphon : 30 s

## Conclusions

- Thermosyphon dynamic is characterized by fluid oscillation in its movement between evaporator and the reservoir: frequency and amplitude vary depending on the power input
- Study of temperature difference between the outlets of the condenser and the water cooler has shown two main results :
  - Minimum at  $45^\circ$  and  $15^\circ$  after repetitive testing
  - Maximum temperature difference is at  $90^\circ$  for both water coolant temperatures in accordance with previous studies