



HAL
open science

Fuel irradiation devices Test of sealed passages with optical fibres in support of the development of innovative instrumentation

S. Gaillot, G. Cheymol, J. Brinster, D. Picard, G. Chichereau, N. Housse, P. Degousee, C. Destouches

► To cite this version:

S. Gaillot, G. Cheymol, J. Brinster, D. Picard, G. Chichereau, et al.. Fuel irradiation devices Test of sealed passages with optical fibres in support of the development of innovative instrumentation. IGORR, Mar 2019, Jordan, Jordan. hal-02411092

HAL Id: hal-02411092

<https://hal.science/hal-02411092v1>

Submitted on 16 Dec 2019

HAL is a multi-disciplinary open access archive for the deposit and dissemination of scientific research documents, whether they are published or not. The documents may come from teaching and research institutions in France or abroad, or from public or private research centers.

L'archive ouverte pluridisciplinaire **HAL**, est destinée au dépôt et à la diffusion de documents scientifiques de niveau recherche, publiés ou non, émanant des établissements d'enseignement et de recherche français ou étrangers, des laboratoires publics ou privés.

INSNU Project - FRANCE

Fuel irradiation devices

Test of sealed passages with optical fibres

in support of the development of innovative instrumentation.

AUTHORS: S.GAILLOT (1), G.CHEYMOL (2), J.BRINSTER (1), D.PICARD (1),
G.CHICHEREAU (1), N.HOUSSE (1), P.DEGOUSEE (1), C.DESTOUCHES (3)

(1) CEA, French Alternative Energies and Atomic Energy Commission, Division of Nuclear Energy, DTN/STCP, CEA Cadarache. 13108 Saint Paul lez Durance. France.

(2) CEA, French Alternative Energies and Atomic Energy Commission, Division of Nuclear Energy, DPC/SEARS/LISL Bât 467 CEA Saclay. 91191 Gif / Yvette Cedex. France.

(3) CEA, French Alternative Energies and Atomic. Energy Commission, Division of Nuclear Energy, DER/SPEX/LDCI Bat 238, CEA Cadarache. 13108 Saint Paul lez Durance. France

Contact Person : Stephane.Gaillot@cea.fr

ABSTRACT

Within the scope of developing the experimental reactor means for the Jules Horowitz reactor (JHR) in France, certain R&D actions are currently focusing on technological building bricks. The action covered in this paper concerns fuel irradiation devices, in particular the fabrication and testing of leak tight feedthroughs equipped with optical fibres under thermal hydraulic conditions (155 bar and 100°C) that are representative of those in certain irradiation devices heads operating under pressurised water reactor (PWR) conditions.

The test performed with these leak tight feedthroughs lasted five days and was representative of certain experimental power ramp-up scenarios on a fuel rod (conditioning, ramp-up, high power plateau for 24 hours, and cooling). The results of this test make it possible to validate the recommended technology. It therefore seems feasible to implement innovative instrumentation equipped with optical fibres in irradiation devices operating under similar experimental conditions.

Following a general description of the project and the JHR facility currently under construction at the CEA Cadarache centre in France, this paper describes the relevant fuel irradiation devices. We have focused on the leak tight feedthroughs going through the device head, in particular those containing the optical fibres.

We discuss the tests performed, their results and several future prospects with respect to the utilisation of optical fibres as a means to support the development of innovative instrumentation.

1. Introduction

In the frame of development of the experimental fleet for the RJH reactor, some measures involve the development of technological blocks. The action described in this paper concerns fuel irradiation devices and especially the realization and testing of experimental feedthroughs equipped with fibre optics to the Thermal Hydraulic conditions of the heads of certain irradiation devices (155 bar, 100°C).

2. Context Reminder

The Jules Horowitz reactor currently under construction at the CEA Cadarache centre (Bouches-du-Rhone department, France) is a material testing reactor (MTR). It will be used to perform irradiation tests on Fuel and Material samples as part of support Programmes for current Nuclear (Gen II and III) and future (Gen IV and fusion) reactors. This reactor will also be used to produce radioelements (mainly Mo-99) for medical purposes and will meet 50% of the European demand in this field.



Fig.1a: JHR facility. v12-2018

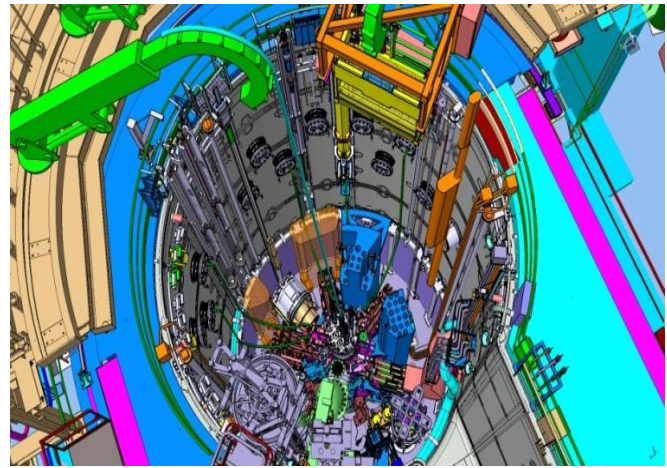





Fig.1b: JHR reactor pool overview. CAD illustration

3. Main Characteristics Of The Reactor

3.1 Introduction

The main characteristics of the Jules Horowitz reactor are recalled below [R1]:

- ✓ the compact core is designed to generate a nominal power of 100 MW_{th},
- ✓ it is cylindrical in shape, with a diameter of 60 cm and a height of 60 cm,
- ✓ the reactor is immersed under 9.3 m of water (level with the mid-height plane) in a pool that is 12 m deep,
- ✓ the core is under-moderated in order to generate strong fast neutron fluxes, i.e. up to $5 \cdot 10^{14}$ n.cm².s⁻¹, E > 1MeV,
- ✓ the primary system is closed and slightly pressurised (12 bar upstream of the core),
- ✓ the cooling water in the core flows upwards at a rate of about 10 m/s,
- ✓ gamma heating in the core is about 15 to 20 W/g (maximum local value),
- ✓ the beryllium reflector is 30 cm thick and surrounds the core vessel to thermalize the neutrons produced in the core. The thermal neutron flux in the reflector is $3 \cdot 10^{14}$ n.cm².s⁻¹.

	
<p>Figure 2a: view of the JHR fuel compartment (<i>casier</i>)</p>	<p>Figure 2b: view of the JHR vessel head</p>
	
<p>Figure 2c: view of the JHR reactor block (vertical section)</p>	<p>Figure 2d: view of the JHR upper internals</p>

Ten experimental locations will be available in the core and another ten in the reflector, including six on the displacement systems, which are designed to modify the distance between the samples and the core.

✓ Startup of the JHR irradiation experiments:

After the divergence phase of the reactor, the start-up phase of the experimental equipments is planned over a one-trial period spanning 12 to 18 months. Once this stage is reached, the experimental loops will be operational and ready to meet the needs of future customers.

3.2 Experiments in the Core

In the core, various experiments are possible. The first possible configuration involves placing the irradiation device in the first crown of the core, and particularly in the center of a fuel element. This privileged position allows researchers to produce important fast neutron fluxes on the samples. These fluxes, translated into displacements per atom, (dpa) are typically 15dpa/year with 100MWth reactor power. These conditions make it possible to carry out accelerated ageing campaigns on the samples. Other sites in the 2nd and 3rd crown presenting reduced fast neutron fluxes are considered. In addition, the devices can be located in the position of a fuel assembly to increase the embedded capacity of the samples.

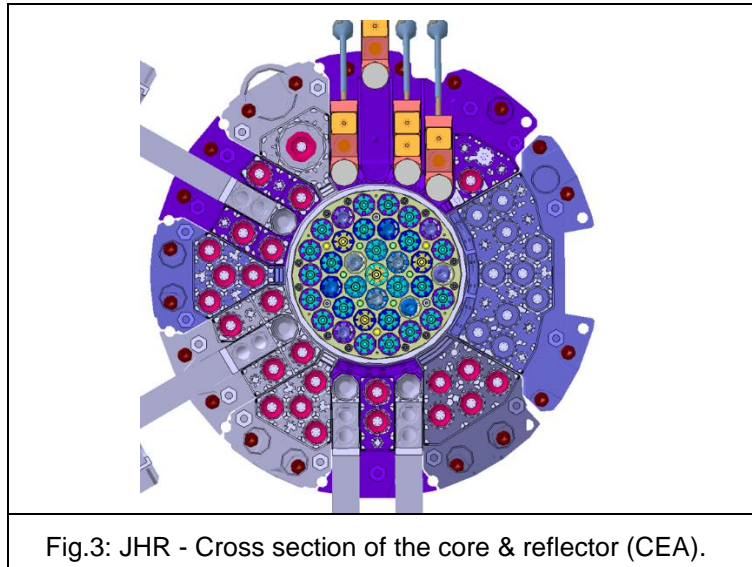

Fig.3: JHR - Cross section of the core & reflector (CEA).

3.3 Experiments in the Reflector

The Beryllium reflector has ten sites where it is possible to conduct experiments. Six sites are possible in fixed positions and four others are foreseen for mobile systems (SAD). The different positions available will enable researchers to obtain conditions of neutron fluxes compatible with the needs for fuel rod irradiation tests in LWR (PWR,BWR) or VVER conditions.

4. The JHR Irradiation Loop for Fuel Power Ramps Tests.

4.1 Main Features:

An experimental irradiation loop dedicated to rod irradiation functioning under LWR conditions is under study (cf. fig.4). This loop is called ADELIN [R1].

This fuel irradiation loop is composed of an in-core part located in the reactor pool and of another part located in the operation zone of the experiments (BUR, CEDE).

The in-core part includes the irradiation device equipped with a rod, the underwater lines and the fluid & electrical connections through the experimental penetrations of the pool. The other part is made up of the fluid circuit, a tight bunker and connection of the circuit with the utilities of the JHR facility. The fluid circuit is equipped with circulating pumps and pressurization systems, making it possible to obtain the circulation of water-cooling towards the device and to reach the required thermal-hydraulic conditions at the bottom of the test channel (155 bar, 270°C, 200g/s). The experimental loop under study also takes into account the feedback of this kind of loop much like the ISABELLE irradiation loop, which was used on the OSIRIS irradiation reactor located in SACLAY (France) up to 2015.

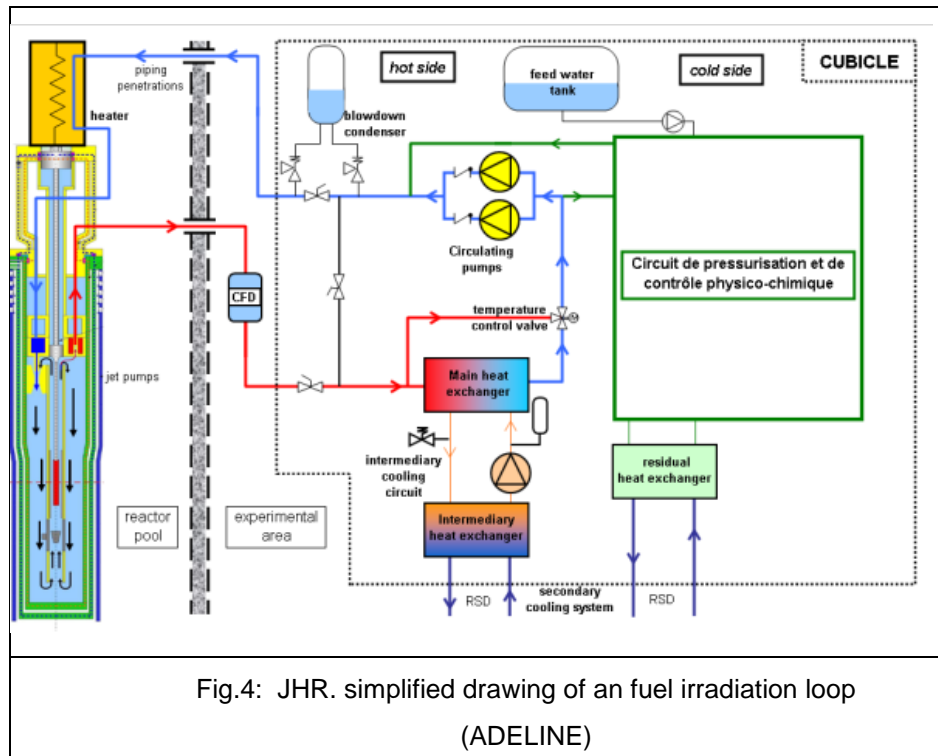

4.2 Planned Performances of the Loop

The experimental rod is composed of a UO₂ type or MOx, irradiated or not.

The standard profile of power during the test is described hereafter:

- ✓ conditioning phase with low power ($100\text{W}\cdot\text{cm}^{-1}$) ranging from a few hours to a few days,
- ✓ power ramp test with kinetics going up to $700\text{W}\cdot\text{cm}^{-1}\cdot\text{min}^{-1}$,
- ✓ power aimed at the high level of $620\text{W}\cdot\text{cm}^{-1}\pm 10\text{W}\cdot\text{cm}^{-1}$ for one maximum duration of 24h,
- ✓ withdrawal of the device according to the power decrease scenario.

The physical parameters around the rod correspond to the following PWR conditions: 155b, 320°C with a fluid flow of 0.2kg/s and 73b, 280°C for BWR conditions.

Regarding the displacement system (SAD), it can move to or from the core tank. It allows implementing linear power variations simply and quickly on the sample and reaching representative power level and fission products inventory during conditioning phase and before a soliciting test.

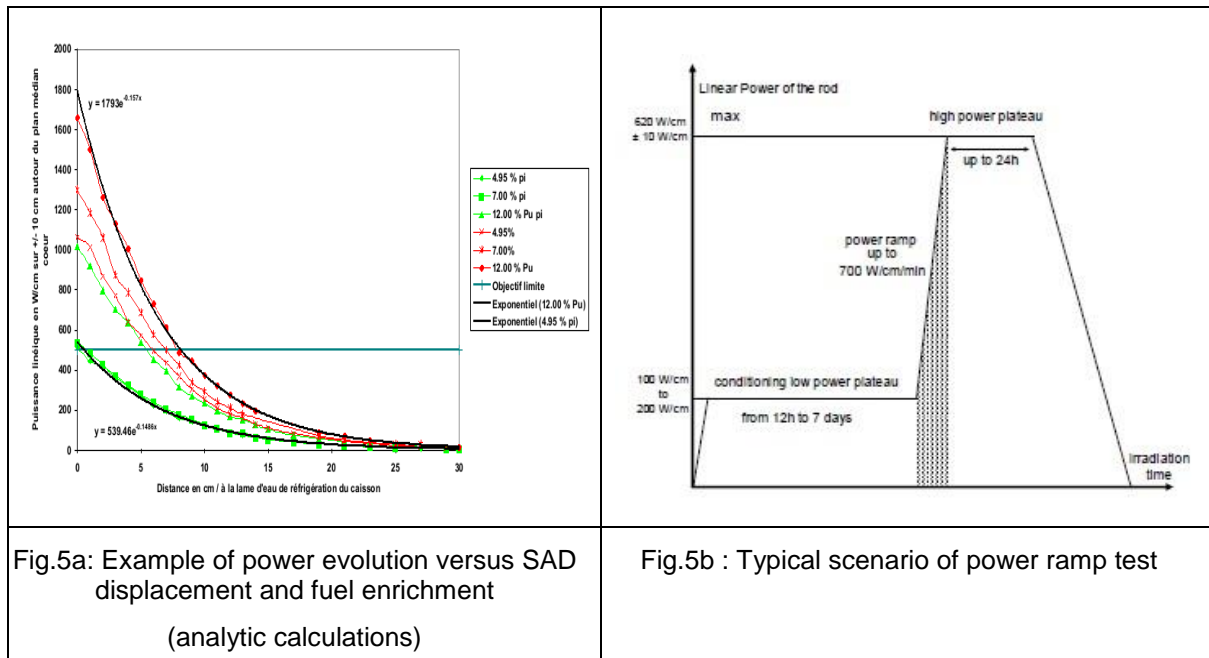

Fig.5a: Example of power evolution versus SAD displacement and fuel enrichment (analytic calculations)

Fig.5b : Typical scenario of power ramp test

Such a concept is convenient for operation (easy to handle, even during the operating cycle of the core) and for safety, the backward position and the off normal conditions of the device are not directly coupled to the core operations.

4.3 Instrumented Experimental Rod

The experimental rod is fixed on a sample holder (PE), metallic structure, which offers an axial and radial rod position during irradiation (cf. fig.6). The head of the sample holder is used as a tight closure of the device.

For this configuration, the rod can be equipped with lengthening sensors at its ends (of LVDT type) enabling us to measure its elongation during the test. According to the objective of the test, the rod may also be more instrumented (fuel, clad temperature measurements, deformation).

This embedded instrumentation can characterize the consequences of the irradiation on the rod more precisely. Note that this instrumentation, placed on the sample holder is consumable.

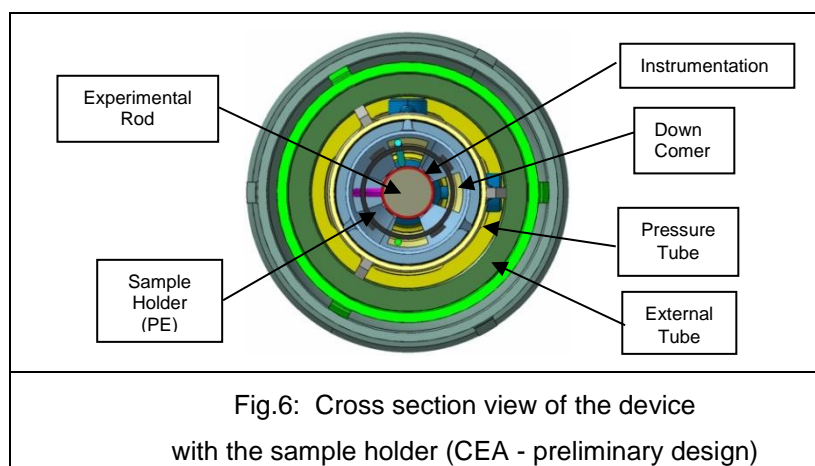

During the irradiation phase, the experimental rod can be subjected to various stresses: swelling, elongation, wear. For the purpose of following these phenomena, innovating instrumentation is now being developed. One of these R&D actions involves the use of an

optical-mechanical sensor permitting the on-line deformation measurement of the rod. This low-size sensor integrates an optical module, in a pressurized and deformable tight enclosure making it possible to follow rod deformation. The range of the sensor is from 0 to 1.5 mm with a precision of 10 microns. The effective range of expected rod deformation during the test varies from about 0 to 0.5 mm [R2].

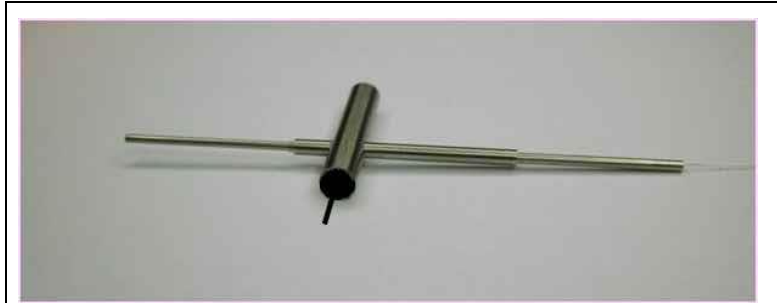

Fig.7: Optical module of the sensor inserted in a body with a piston simulating the feeler piece (CEA, R&D).

4.4 Support Qualification Tests

In response to the experimental requirements described above, qualification tests are required. The test described in this paper concerns the implementation of tight feedthroughs with fibre optics in a fuel irradiation device.

Optical fibres are composed of silica, diameter 125 microns and are inserted in tightness feedthroughs.

The tested FO flange is equipped with two welded tightness feedthroughs fixed on a flange and a tight passage (Pet) mounted with a screw fitting.

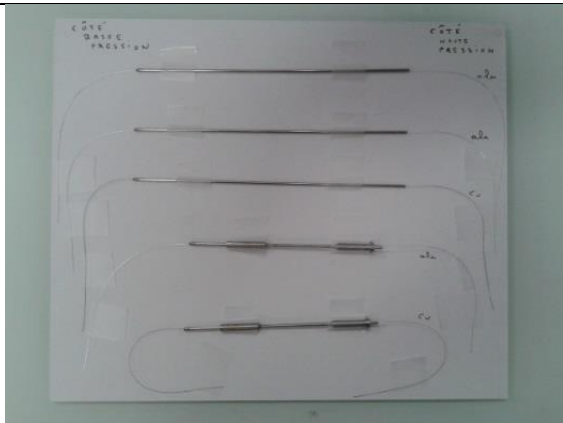

Fig.10a : Typology
of tested feedthroughs.



Fig.10b : Mock-up for
feedthrough welding qualification

The experimental conditions for these tests correspond to the TH conditions at the level of the heads of devices.

Numerical simulations have been carried out and led to clarify the maximum temperatures reached in this zone, which is about 100 °C.

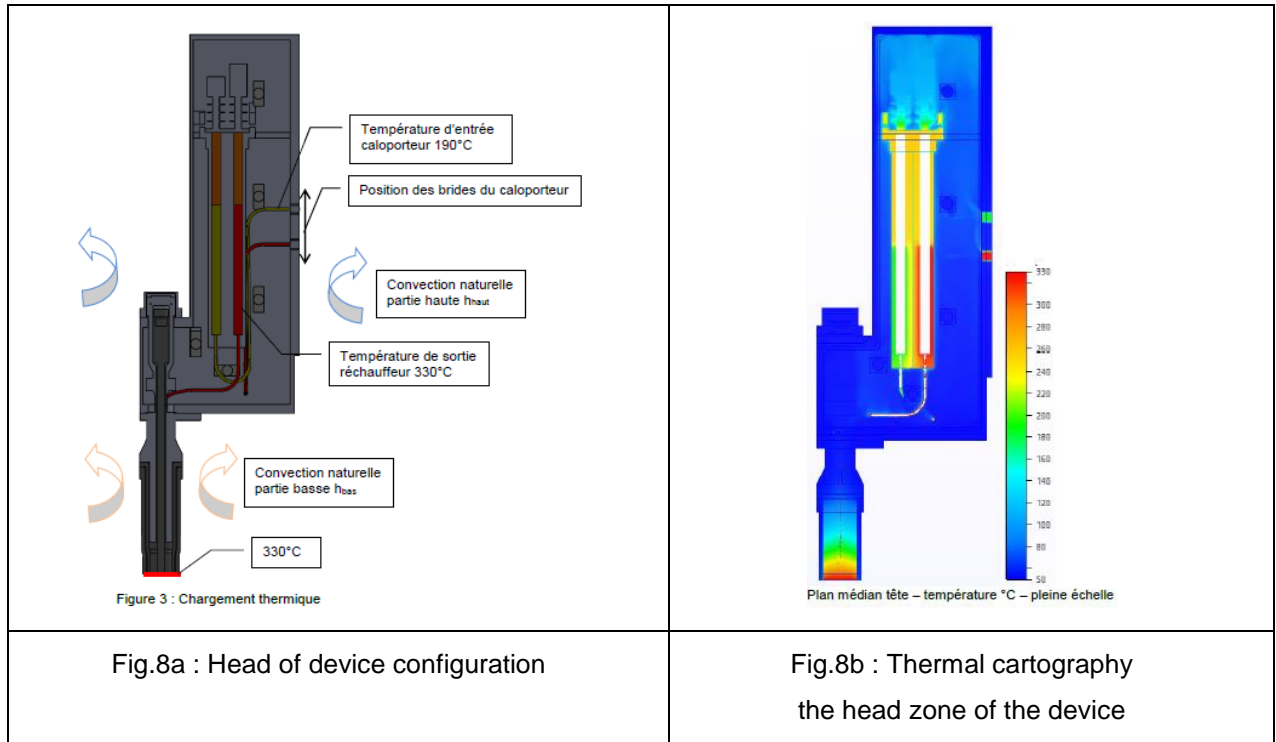

4.5 Experimental Tests

The test facility is the experimental out of pile BIKINI loop operated by CEA-CAD-DTN. The main characteristics of this loop are recalled below:

- test section height = 2,5m.
- thermal hydraulic parameters: 155 bar, 330°C, 5m³/h.
- demineralised water : pH (25°C) = 5.45

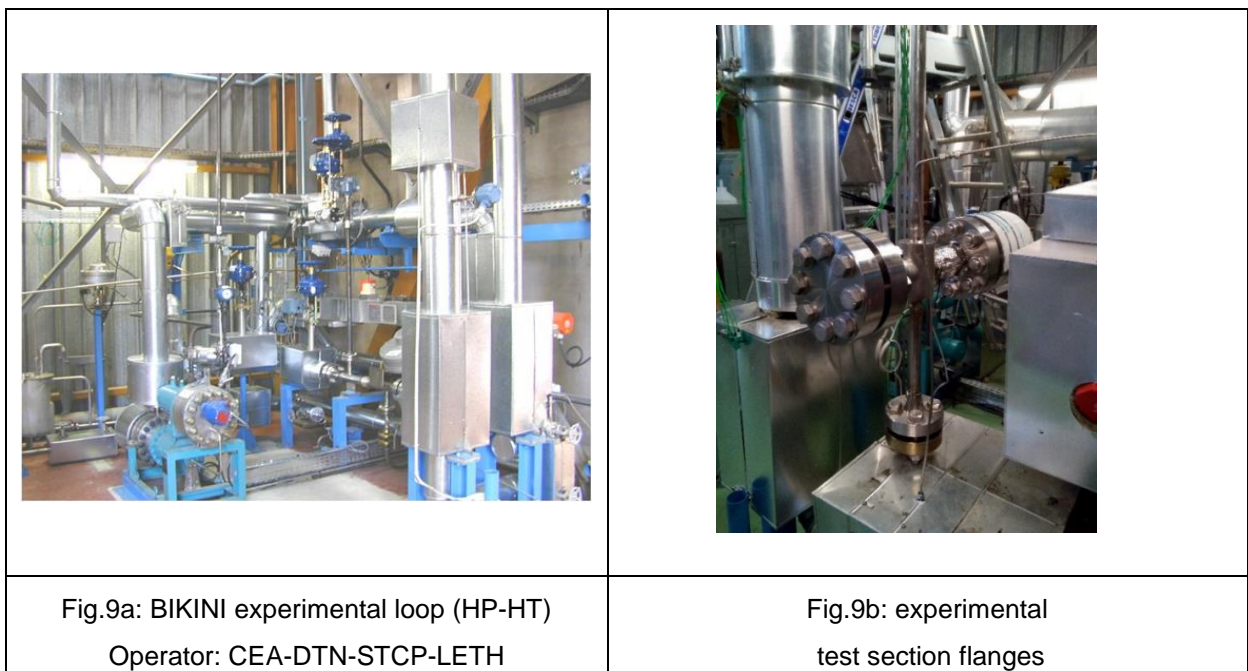

Hereafter are reminded the main parameters of the experimental test:

Title	Description	Note
Test startup	Me 04.07.18 14h15	Test duration : 5 days
End of Test	Lu 09.07.18 14h30	
Process pressure	155 bar +/-2 bar	
OF Flange Temperature	100°C	Fluid TC in front of the OF Flange
Process flow rate	1000 kg.h ⁻¹	Ascending flow
OF flange flow		No flow

During the test, control of the experimental feedthroughs called PET2 (welded), PET3 (screwed) & PET5 (welded).

Note: The rate of leakage of the sealed passages is monitored by differential pressure sensors placed below the flange (range 0-62 hPa).

The graph below shows the evolution in time of the differential pressure measurement obtained by sensors P02, P03 and P05 (these sensors permit to check the apparition of a leak at the level of the sealed passages PET2, PET3 and PET5 respectively).

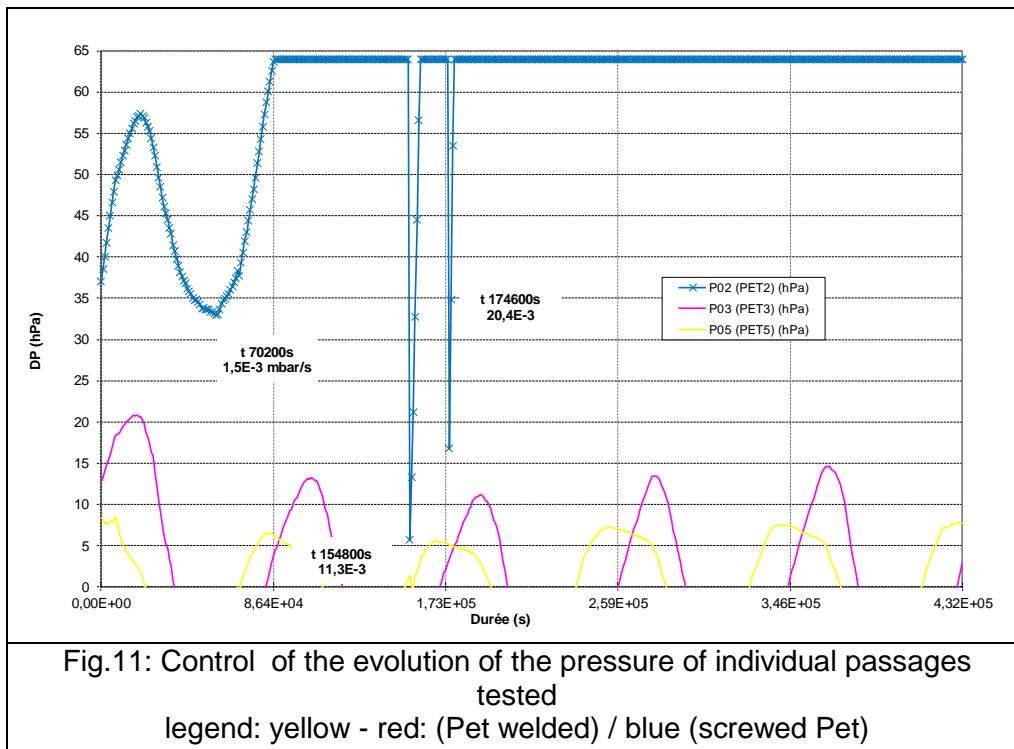

Note: the time $t = 0$ s represents the beginning of the endurance phase.
After the five-day trial, the loop was operated to ambient pressure & temperature conditions.

From the completed script, it can be concluded the preliminary results below:

- ✓ The OF (Optical Fibers) flange has been tested on the test BIKINI loop to the thermal conditions of the head of the ADELINÉ for 5 days to 155 bar, 100 °C,

- ✓ The PET3 and PET5 feedthroughs (welded passages) remain perfectly sealed throughout the test. The observed fluctuations are due to atmospheric fluctuations (pressure and temperature of the test hall).

Note: feedthrough noted PET2-sensor P02 (Pet mounted screw connection) is waterproof up to 19 h 30 min after the start of the trial.

At this moment, there is the appearance of a saturation with a speed increase in the pressure of $1.5 \times 10^{-3} \text{ h.Pa.s}^{-1}$.

After the test, the FO flange was removed for inspection.

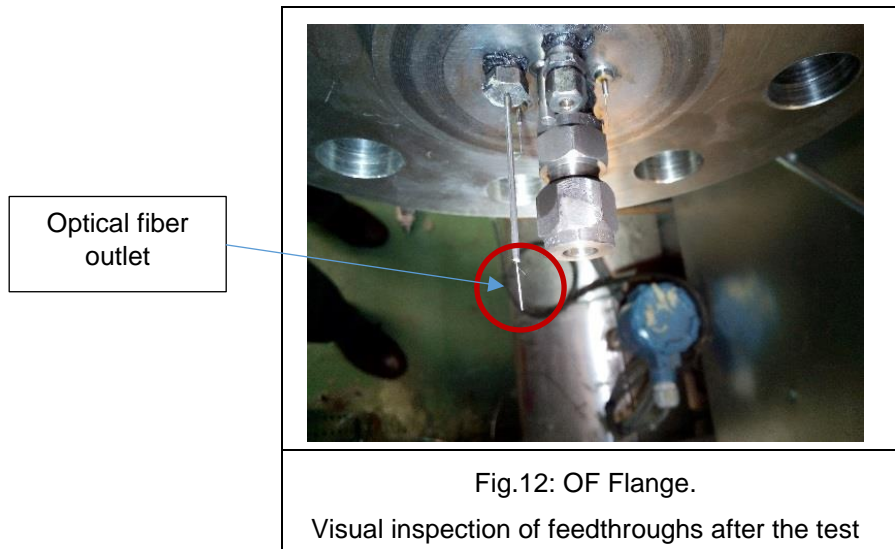

The visual examination of the flange shows that the ends of the tight passages (coated optical fibers) have not been altered by the endurance test.

5. Conclusion:

In the frame of JHR Program, some ongoing actions concern the development of irradiation devices. These devices will allow, among other things, the power ramps test on fuel rods. To characterize online behaviour of fuel rod during the test, innovative instrumentation is studied.

In particular, some instrumentation will integrate optical fibres in order to achieve, among others, interferometric measurements to characterize in-situ swelling of a rod (range 0-1,5 mm).

One of the point identified in the phase of development of this type of instrumentation is to check the mechanical performance of tight feedthroughs to thermal hydraulic conditions representative of ADELIN type devices (head zone, 155 bar, 100°C). This test was performed on a duration of five days.

The first results obtained identify technology "fittings welded" potentially usable for ADELIN tight type passages.

The futures tests will be designed to validate the following points:

- Resistance of this type of feedthrough to thermal hydraulic pressurised water conditions (PWR) for 24 hours.
- Optical function verification with this type of feedthroughs test in these conditions.

6. References

[R1] IGORR 2009

JHR. The ADELINe irradiation loop in the Jules Horowitz MTR. Testing a LWR fuel rod up to the limits with a high quality level. Experimental process.

S.GAILLOT, D.PARRAT, G.LAFFONT, C.GONNIER, C.GARNIER
CEA, DEN, CEA CADARACHE, F-13108 Saint-Paul-lez-Durance, France.

[R2] PHYSOR 2014

Jules Horowitz Reactor, France. Development of an experimental loop INTEGRATING AN optimized irradiation process.

S.GAILLOT, S.VITRY & T.DOUSSON
CEA, DEN, CEA CADARACHE, F-13108 Saint-Paul-lez-Durance, France.

[R3] IGORR 2013

JHR Project. Fuel irradiation device . Innovative instrumentation proposal for experimental real time measurement.

S.GAILLOT, G.CHEYMOL
CEA, DEN, CEA CADARACHE, F-13108 Saint-Paul-lez-Durance, FRANCE
CEA, DEN, CEA SACLAY, F-91191 Gif sur Yvette, FRANCE.

