



**HAL**  
open science

# Turbocharger Heat Transfer Determination with a Power Based Phenomenological Approach and a CHT Validation

Bojan Savic, Xunan Gao, Roland Baar

► **To cite this version:**

Bojan Savic, Xunan Gao, Roland Baar. Turbocharger Heat Transfer Determination with a Power Based Phenomenological Approach and a CHT Validation. 17th International Symposium on Transport Phenomena and Dynamics of Rotating Machinery (ISROMAC2017), Dec 2017, Maui, United States. hal-02410334

**HAL Id: hal-02410334**

**<https://hal.science/hal-02410334>**

Submitted on 13 Dec 2019

**HAL** is a multi-disciplinary open access archive for the deposit and dissemination of scientific research documents, whether they are published or not. The documents may come from teaching and research institutions in France or abroad, or from public or private research centers.

L'archive ouverte pluridisciplinaire **HAL**, est destinée au dépôt et à la diffusion de documents scientifiques de niveau recherche, publiés ou non, émanant des établissements d'enseignement et de recherche français ou étrangers, des laboratoires publics ou privés.

# Turbocharger Heat Transfer Determination with a Power Based Phenomenological Approach and a CHT Validation

Bojan Savic<sup>1\*</sup>, Xunan Gao<sup>1</sup>, Roland Baar<sup>1</sup>

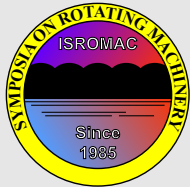

ISROMAC 2017

International  
Symposium on  
Transport Phenomena  
and  
Dynamics of Rotating  
Machinery

Maui, Hawaii

December 16-21, 2017

## Abstract

We present from our work on models to determine heat flows on turbochargers. A Conjugate-Heat-Transfer simulation has been carried out on the turbine for validation of the approach. Results have shown that isentropic efficiencies fit well for values of turbine inlet temperatures of 600°C. For other temperatures the differences between the determined values and CHT are greater. The differences rise with higher temperatures. Hence, an additional dependency of turbine inlet temperatures has been implemented in the model. The modification has shown better results and smaller differences to CHT results. Especially at low speeds where the former approach has had big differences the modification improves the distribution. A wastegate turbocharger has been investigated from small gasoline engine applications. In future investigations the approach will be tested on the compressor with a modification, too, as well as on different turbochargers. The objective is to create a methodology for parameterization of a thermal network model based on the modified approach as a start point. Recently the experimental basis has been developed to determine heat flows on radial turbines and compressors. It has been validated for the compressor with experimental data under near adiabatic conditions. For the turbine a CFD simulation has been carried out. Both comparisons have shown good results for turbine inlet temperatures of 600°C.

## Keywords

Turbocharger — Heat Transfer — Isentropic Efficiencies — Conjugate Heat Transfer

<sup>1</sup> Department of Powertrain Technologies, Technical University Berlin, Germany

\*Corresponding author: b.savic@tu-berlin.de

## INTRODUCTION

The conventional measurement of turbochargers on hot gas test benches is thermodynamically adapted on realizable options in terms of measuring devices, possibilities and costs. For today's high requirements of the application e.g. in automotive systems, this procedure leads to differences between reality and measurement because of the met assumptions and the considered operating range. Several studies including our own investigations have shown that the expansion and compression process is not adiabatic. Heat flows occur between the compressor and the turbine which lead to falsified isentropic efficiencies. Additionally heat flows occur between the turbocharger and the ambient. Some of the heat flows are consumed by the lubrication oil and if available the cooling water. However, the heat flow phenomenon on a turbocharger is quite complex and it is illustrated in Figure 1.

One way to decrease the influence of heat transfers is measurements under adiabatic conditions. This procedure is thermodynamically feasible on the compressor so that the isentropic efficiencies can be transferred to the hot gas measurements. On the turbine side, the operating points change significantly between these two experimental modes so that there is no possibility to assign and transfer the isentropic efficiencies. Another problem is the inhomogeneous flow at the turbine outlet, which needs special measurement equipment for reliable  $T_4$  data (temperature at turbine outlet)[1].

This is the critical value for determining the turbine isentropic efficiency directly from measured data. Only in adiabatic measurements does this procedure lead to real isentropic efficiencies. In hot gas tests, the results are superimposed by heat flows and without the possibility to transfer the real isentropic efficiencies from adiabatic tests there is no knowledge about the quantity of outgoing heat. Another way to obtain the real turbine isentropic efficiencies is a CFD or a CHT simulation, requiring geometrical data and high computational costs. Other possibilities for heat flow determination are specific empirical approaches for the compressor, the turbine or the friction, to calculate the power balance. But these empirical approaches are commonly validated on specific turbochargers and have a limited prediction behavior on new ones. Please refer to [2] for detailed literature information.

Therefore a powerbased approach has been developed in previous works to determine heat flows on compressors and turbines. It led to some advantages in relation to transfer issues on new turbochargers because the model does not have to be calibrated. It only needs measurement data. The basis for the approach was precisely described in [1] and [3] and summarized in [2]. The test bench setup has been described in [2] as well. An illustration of the turbocharger setup is presented in Figure 19. The essential measurement of the turbine exit temperatures of the highly inhomogeneous flows with a mixer has been described in [1] and [3]. A new adiabatic criterion and the characteristic turbine power

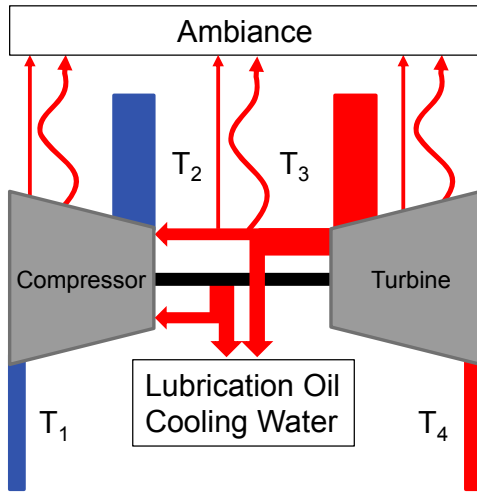

Figure 1. Heat flows in a turbocharger

curves has been investigated on four different sized turbochargers[4][5]. It has been shown that the approach works without geometrical data and is applicable on various devices. In [2] the new phenomenological approach was expanded on the compressor. Furthermore the recalculation of the isentropic efficiencies of a wastegate turbocharger has been shown and validated for both the compressor and the turbine.

## 1. METHODS

### 1.1 POWER BASED APPROACH

The approach has been firstly described in [4] and consists of a power based consideration. The reason for a power based consideration has been motivated by the following issue. For compressors it is possible to apply boundary conditions to minimize heat transfer. The real aerodynamic behavior is then described almost with conventionally used thermodynamic procedures. Because the inlet conditions of the compressor do not change significantly between adiabatic and hot gas tests the so obtained efficiencies can be transferred. At the turbine side the situation is different because of the changing inlet conditions. There is no possibility of transition of the isentropic efficiencies from one test mode to the other. The reduced values e.g. massflows and speeds change significantly so that comparability is not available. By trying to find a way to solve this problem as well as to find a criterion to evaluate how adiabatic the experiments really are, the power based approach has been developed. In figure Figure 2 the idea has been schematically emphasized. When plotting measured effective turbine powers against isentropic compressor powers these lines occur. It has been visible that there are similarities between adiabatic lines in blue and hot gas lines in red. The exact motivation of the choice of axes are described in [2],[4] and [5]. However, this approach showed that one difference between the two test modes is an offset of the measured effective turbine powers. In [2] the procedure has been shown how to correct the measured powers with

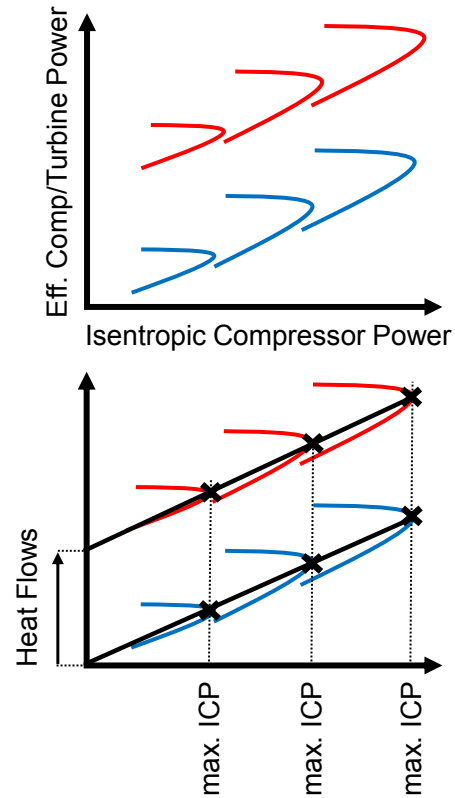

Figure 2. Heat flow approach

a simple shift. These values can be used then to recalculate the isentropic efficiencies with Equation 1 and Equation 2. Firstly it has been only applied on turbines and proved to work also on compressors[2]. Comparisons with adiabatic test data showed good validity.

$$\eta_{Cis_{corr}} = \frac{\Delta h_{Cis}}{\Delta h_{C_{corr}}} = \frac{\frac{P_{Cis}}{\dot{m}_C}}{\frac{P_{C_{corr}}}{\dot{m}_C}} = \frac{P_{Cis}}{P_{C_{corr}}} \quad (1)$$

$$\eta_{Tis_{corr}} = \frac{\Delta h_{T_{corr}}}{\Delta h_{Tis}} = \frac{\frac{P_{T_{corr}}}{\dot{m}_T}}{\frac{P_{Tis}}{\dot{m}_T}} = \frac{P_{T_{corr}}}{P_{Tis}} \quad (2)$$

On the turbine side a CFD calculation has been applied and the comparison showed good agreement at  $T_3 = 600^\circ\text{C}$ . In both cases the largest differences were localized at lowest speeds. The explanation has been due to sensor accuracies which are very sensitive at low speeds. For a summary of the works please refer to [6] and [7].

In the present work the approach has been tested at four turbine inlet temperatures ( $400^\circ\text{C}$ ,  $600^\circ\text{C}$ ,  $800^\circ\text{C}$ ,  $950^\circ\text{C}$ ). The main object of this investigation is the turbine. A CHT simulation has been carried out to prove the validity. For further information to the CHT setup and calculation please refer

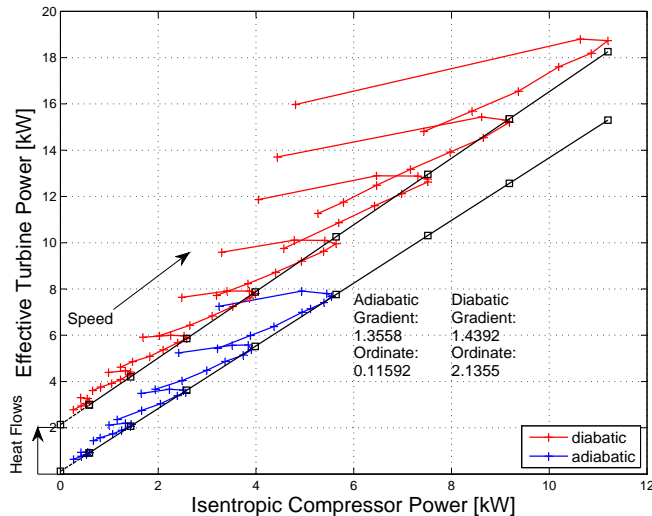

**Figure 3.** Turbine effective power against isentropic compressor power

to the next chapter. A detailed description of the CHT study will be published soon.

## 1.2 CONJUGATE HEAT TRANSFER

### 1.2.1 Computational mesh

The rotational region was meshed by a structural hexahedral grid in the fluid domain. The volute and diffuser have been meshed with unstructured tetrahedrals together with 10 prism layers at the detached region. The solid domain has been meshed with a tetrahedral grid due to the geometric complexity. The dimensionless first grid wall distance ( $y^+ <$ ) has been regulated below 5 for all fluid domains to obtain a high resolution of boundary layers. A Grid independency study has been carried out to eliminate the grid-induced errors. An additional ambient domain has been built in order to model the convective heat transfer between turbine housing and ambient which has been validated by a previous study. Figure 4 shows the overview of the computational model. The complete model contains 17.1 Million elements. The turbocharger mesh contains 8.5 Million elements.

### 1.2.2 Numerical Setup

The commercial code ANSYS CFX 17.2 has been employed as the solver, which uses the element-based finite volume method. In the fluid domain, steady RANS (Reynolds Averaged Navier-stokes) equations have been solved with closure brought by the SST turbulence model (Shear Stress Transport). Energy equations were solved simultaneously for the solid domain. The global timestep was set to  $1/w$ , where  $w$  is the angular speed of the turbine. A specified “pseudo” timestep has been applied for solid domain to accelerate convergence because of the significant disparity in timescale between fluid flow and solid conductive heat transfer. The frozen-rotor method has been employed for the interfaces between rotational and stationary regions using GGI (General Grid Interface) mesh connection technology. The smooth

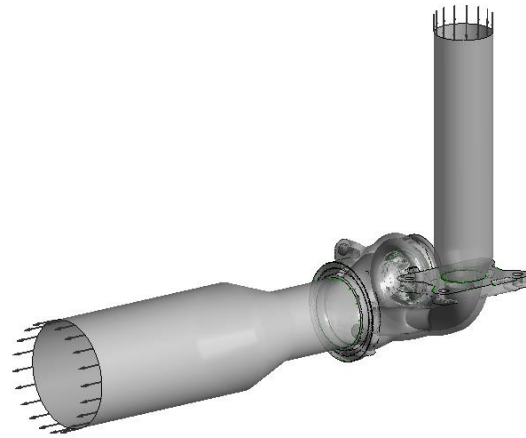

**Figure 4.** Turbinemesh structure without ambient domain

and no-slip assumption has been applied for wall boundaries of fluid domains. At turbine inlet, total pressures and total temperatures have been set as boundary conditions. While at turbine outlet, static pressures have been specified in accordance with experimental data. 3 additional thermal couples fixed at the flanges of turbine housings have served as boundary conditions of simulation. To validate the simulation model a comparison has been made between simulation and experimental data under adiabatic condition.

## 2. RESULTS AND DISCUSSION

### 2.1 CHT and Adiabatic Approach

The experiments has been applied under various conditions such as inlet temperatures of lubrication oil, cooling water and exhaust gas. In the present work the influence of the turbine inlet temperatures has been investigated on the approach. The correction described in ?? has been employed and the isentropic turbine efficiencies have been corrected. The isentropic turbine efficiencies are plotted against isentropic compressor powers to stay consistent with the power based approach. The values for  $400^{\circ}\text{C}$  are plotted in Figure 5. Standard hot gas measurement data is in red. They are calculated with the temperature difference between  $T_3$  and  $T_4$ . This shows the typical influence of heat transfer at low speeds due to the fact that the enthalpy differences decreases here stronger than the heat transfers. The lowest speed line reaches implausible values of 2.4. The CHT results are in blue and show that the isentropic efficiencies stay in an approximately constant range of values over the speed lines. Although this scale is not appropriate to evaluate the values in detail, it is reasonable enough to make a statement of the qualitative trends.

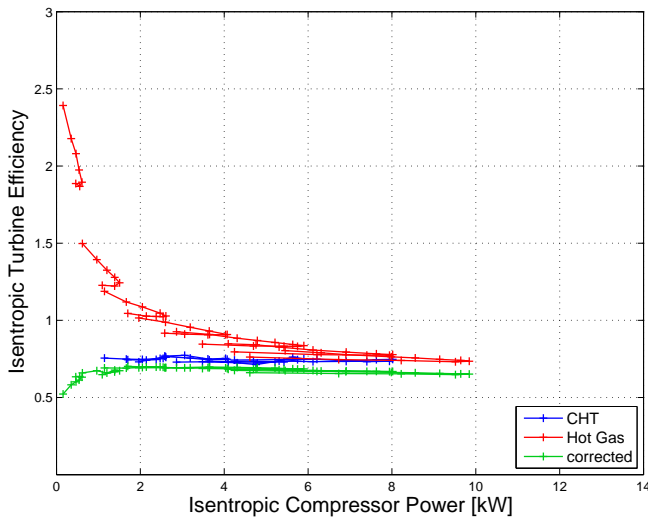

**Figure 5.**  $T_3=400^\circ\text{C}$ : Isentropic efficiencies against isentropic compressor power

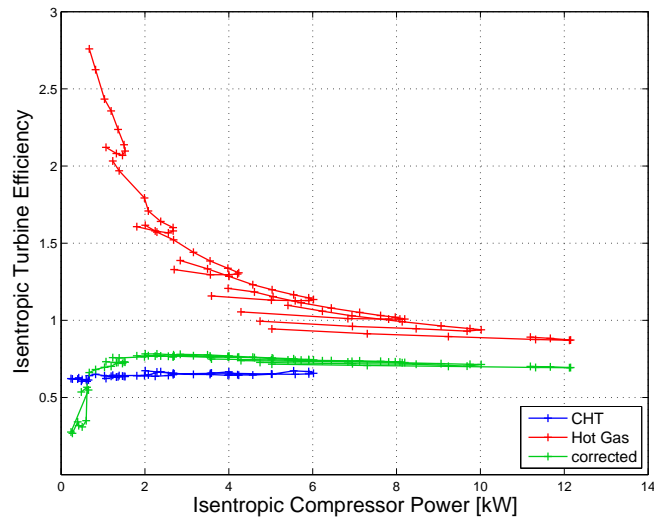

**Figure 7.**  $T_3=800^\circ\text{C}$ : Isentropic efficiencies against isentropic compressor power

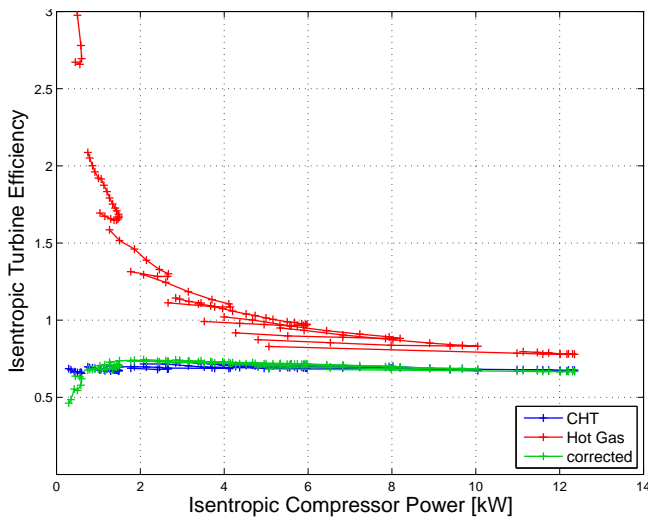

**Figure 6.**  $T_3=600^\circ\text{C}$ : Isentropic efficiencies against isentropic compressor power

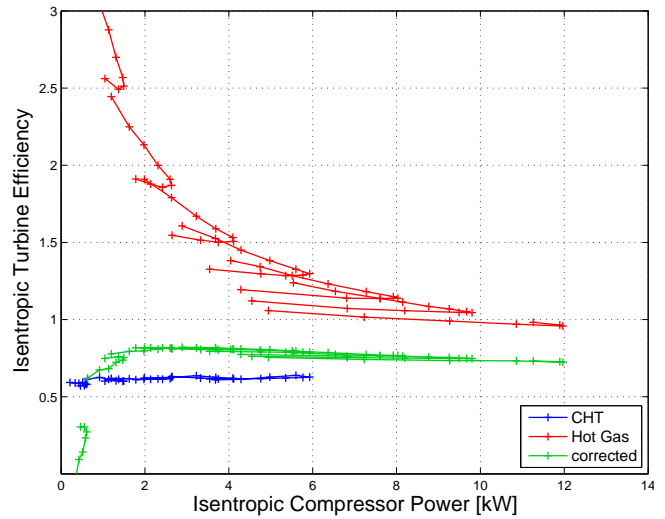

**Figure 8.**  $T_3=950^\circ\text{C}$ : Isentropic efficiencies against isentropic compressor power

The results will be shown in a larger scale in the next section. The corrected speed lines are in green and approach the CHT values much better. There is a constant offset to lower values, especially for lowest speeds. The heat flows are overestimated and so isentropic efficiencies are underestimated.

The lines for  $T_3=600^\circ\text{C}$  are presented in Figure 6. There are more speed lines than for  $T_3=400^\circ\text{C}$ . This is due to test bench limits of  $p_3$ . As the turbine inlet temperature decreases the massflow has to rise so that the turbine can provide bearings and compressor power. The temperature difference and the massflow are the only two parameters that can change the effective turbine power.

The red lines are heavily influenced by heat flows. The lowest speed lines have values over 3. The ordinate maximum value is throughout the paper at the same value, although the lowest speed lines are out of range with respect to comparability and size of the relevant areas. They are not important for the discussion. The corrected lines fit very well to the CHT results with a slight difference at middle speeds. Only at low speeds they have bigger differences to each other.

The heat flows are generally underestimated with rising turbine inlet temperatures. In Figure 7 the isentropic efficiencies are overestimated in a wide range. Approximately 10%-15% is the offset in comparison to CHT. The lowest speed-lines show a big offset and the isentropic efficiencies are underestimated. This trend continues in Figure 8 with higher



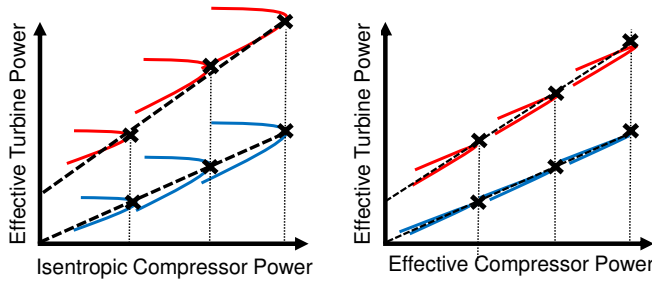

**Figure 9.** Modification of the choice of axes

temperatures and heat flows. These results show that there is an obvious  $T_3$  impact on the heat transfer which is not fully considered by the correction method. There is another parameter which has to be investigated additionally to the difference in the ordinate intercept between adiabatic and hot gas test data in Figure 2. The gradient of the connecting line of maximum isentropic compressor powers has a slightly different value from adiabatic line. It is always bigger than in the cold case. This difference increases with higher values so that there are actually two factors to be considered.

## 2.2 Modification of the Approach

Firstly, the approach has been extended with a second correction term for the gradient. Heat flows are increasing linearly with speed. The results show a better fitting with CHT isentropic efficiencies in relation to the overall offset. But they keep the trend at low speeds where the isentropic efficiencies tend to decrease intensely. This is obviously a better approach but there are still unconsidered influences. A promising concept has been found in the process of investigating combinations of axes. The motivation of it has been the question from which axes can we get specific information because the approach itself is new and still not investigated from different perspectives. The best results came up with a change of the isentropic power as the abscissa to effective compressor power. This combination is schematically illustrated in Figure 9. Here the speed lines are much flatter and tend to appear as a line. In the former approach the speed lines rise with a polynomial that is slightly higher than linear.

The new approach has a clear and linear progress when comparing Figure 2 and Figure 10. The angle bisector would be the hypothetical state of no friction and the turbine power equals the compressor power. The real gradients are slightly bigger than that. However, the advantage of this approach is that the question of how to consider different points of the same speed lines is less important because they lie on the same line. Nevertheless this aspect has to be investigated more detailed in future. This approach will be used as basis for further considerations and calculations. Only for comparability the corresponding isentropic compressor power of each operating point will be used for illustration. For calculation the modified approach has been used and for

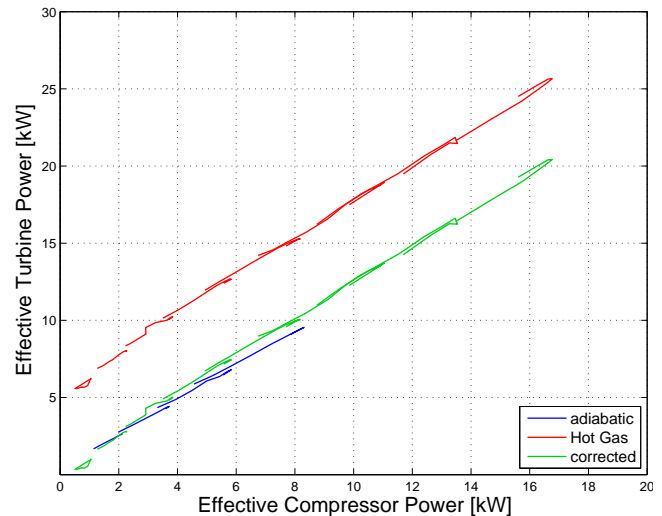

**Figure 10.**  $T_3$  800°C: Modification of the adiabatic approach at high temperatures

illustration the use of the old axes has been chosen for comparability. The results are plotted in Figure 11. The estimation of isentropic efficiencies is slightly better in relation to CHT at 400°C turbine inlet temperature. The differences are similar at low speeds and they underestimate the isentropic efficiencies. A better view is allowed in Figure 12. At middle and high speeds there is an offset of about 10% points to CHT. The map of 600°C has a much better alignment in Figure 13. The distribution fits very well with a slight offset. Especially low speeds show a better fit than before. The differences are approximately 5% points over the speed lines in Figure 14. This is a good result because a simple correction method as proposed is possible to obtain values for the isentropic turbine efficiencies which are in the same range of a CHT simulation. It is important to understand that geometrical or material data here is not needed. The calculation takes a few seconds. For higher temperatures the results show good agreement with CHT. This statement can be comprehended in Figure 15. The alignment is much better here than in the former approach. There is a small difference at low speeds to CHT where the isentropic efficiencies are underestimated.

The hot gas data has one speed line missing. The first line is intensely superimposed by heat flows so that it is outside the right scale. The results in Figure 16 are quite promising. Two operating points at small isentropic compressor powers show bigger differences. The modified approach works here as well as for higher temperatures. It is obvious that the influence of turbine inlet temperatures now is considered. There is a small offset in Figure 17 where the isentropic efficiencies are overestimated. Hence, the heat flows are slightly underestimated. Two operating points show underestimated efficiencies at small speeds. The mean offset is about 7% points. These results emphasize the consideration of the linearly increasing heat flows with higher speeds. The comparison shows better results with a change from constant

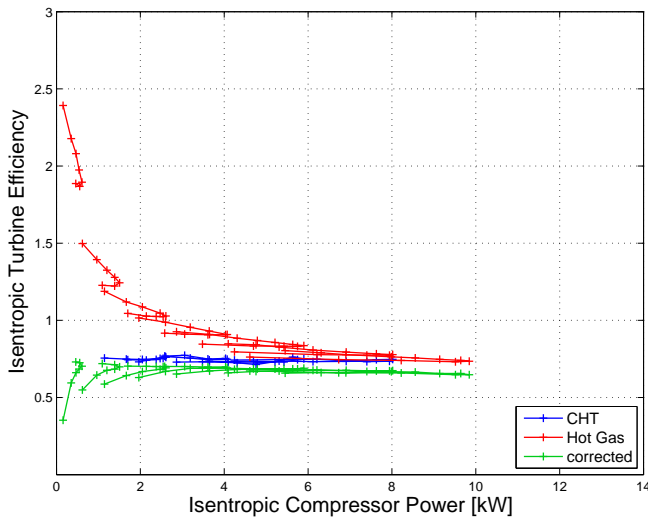

Figure 11.  $T_3$  400°C: Results of the modification at lower temperatures

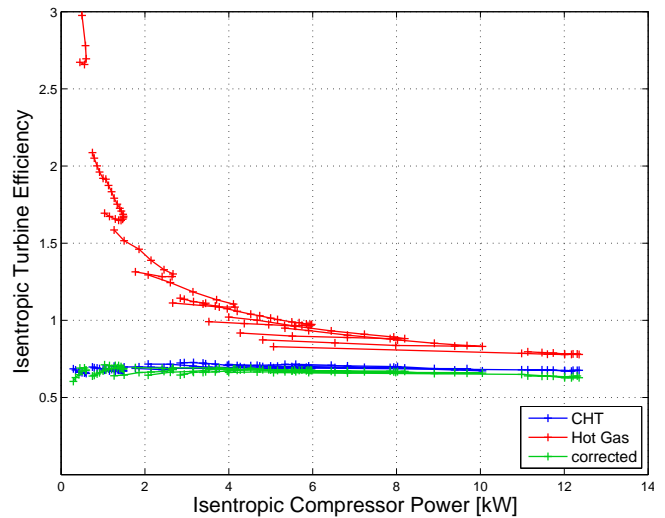

Figure 13.  $T_3$  600°C: Results of the modification at standard temperatures

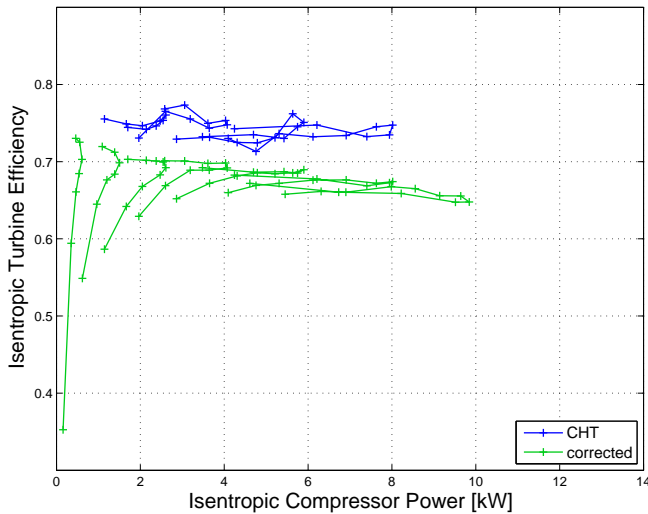

Figure 12.  $T_3$  400°C: Larger scale

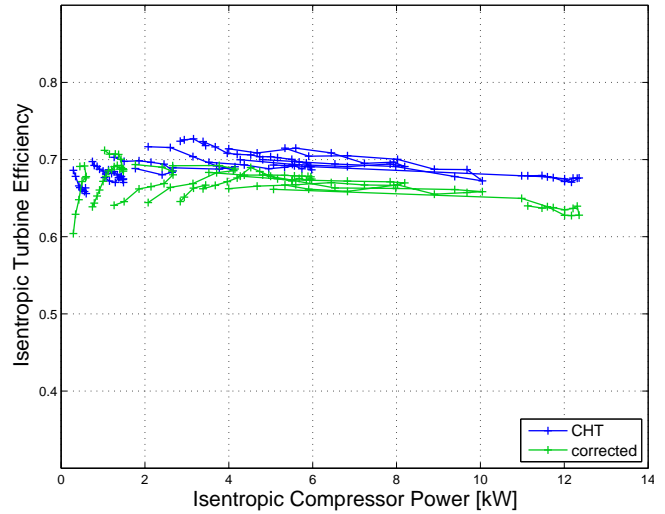

Figure 14.  $T_3$  600°C: Larger scale

value approach to an additional correction of the slope.

### 3. CONCLUSION

The approach showed in previous investigations its validity on different turbochargers in terms of the typical power based lines. The comparison of a wastegate turbocharger showed further good agreement in terms of isentropic turbine efficiencies for a certain turbine inlet temperature of 600°C. In the present work this investigations has been continued. A Conjugate-Heat-Transfer model has been set up and simulations of four different turbine inlet temperatures has been carried out.

The comparison shows that the approach has a good agreement for 400°C and even better for 600°C. In the first case the isentropic turbine efficiencies is underestimated. The results show disagreement with CHT for low speeds in both cases. The distribution has increasing differences with rising turbine inlet temperatures. The heat flows are underestimated and the isentropic efficiencies are overestimated for 800°C and 950°C.

This trends lead to the conclusion that some  $T_3$  influences were still not considered, although the most obvious effect of the heat flows, the offset in the ordinate direction has been calculated. This has been shown in previous works. Two factors describe the connecting line between the points of maximum isentropic compressor power. The first is the ordinate intercept and the second the gradient. The latter has not been considered yet and has been in all cases greater in

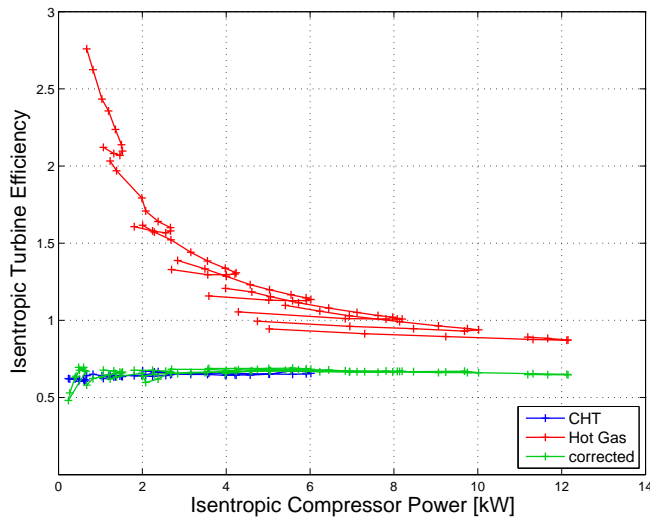

**Figure 15.**  $T_3$  800°C: Results of the modification at high temperatures

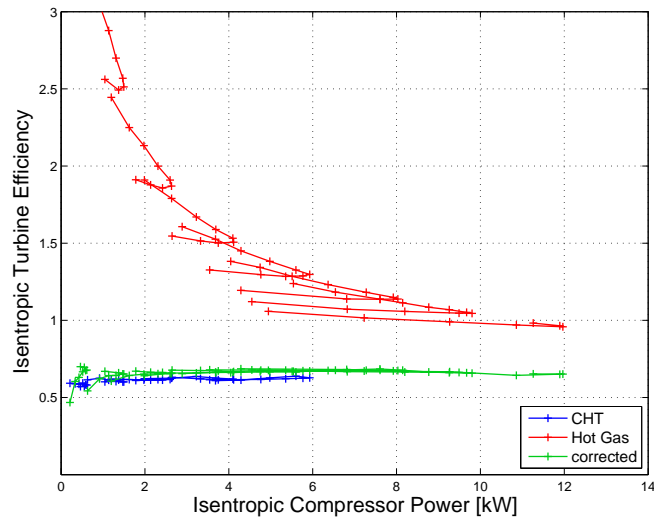

**Figure 17.**  $T_3$  950°C: Results of the modification at highest temperatures

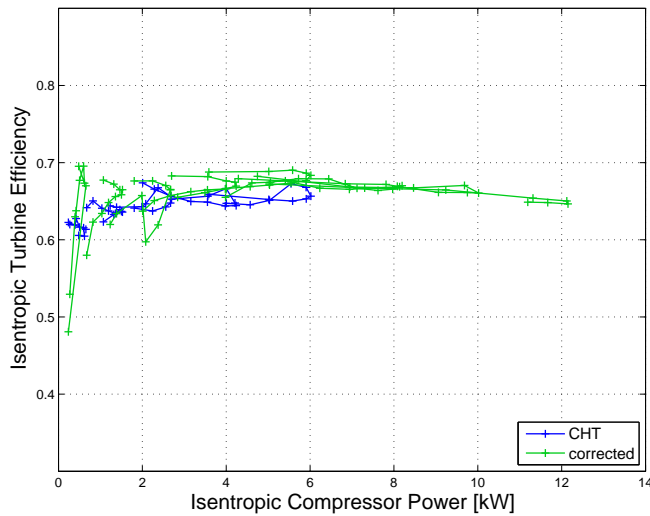

**Figure 16.**  $T_3$  800°C: Larger scale

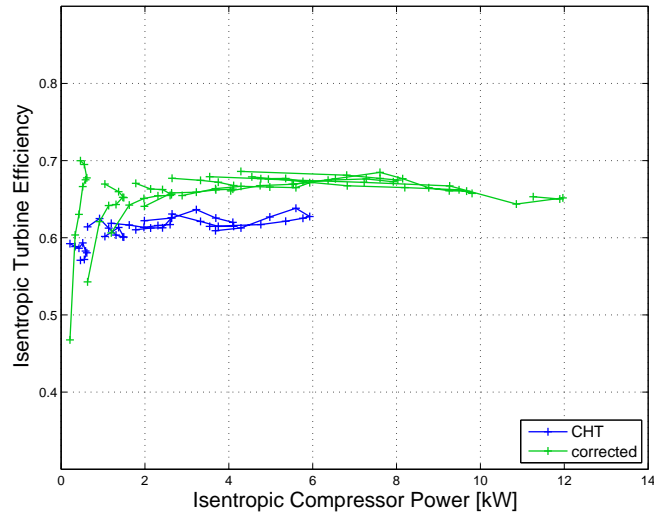

**Figure 18.**  $T_3$  950°C: Larger scale

hot gas tests than in adiabatic ones.

Investigations that has been carried out show better alignment with CHT results by correcting additionally the slope. This improved the offset with higher turbine inlet temperatures.

Another abscissa solved the problem. Instead of isentropic, the effective compressor power has been applied. This approach also ensures a good alignment at low speeds as well as over the hole range of turbine inlet temperatures. Results show that only at 400°C the alignment to CHT data of the modified approach is similar to the former one. Therefore the modified approach will be used in future works.

It is a big advantage to know the quantity of heat flows from experimental test data for various applications. The exact information of turbocharger aerodynamics is increasingly important with higher legislative expectations for

combustion engines. Thermal management or turbocharger matching would be interesting fields e.g. that could profit from approaches with low computational cost and no calibration effort. On the other hand the approach showed good agreement with CHT simulations.

The main challenge and motivation of the work is that turbochargers are fluid machines but they are described thermodynamically because it is simple to measure temperatures and pressures. In reality there are heat flows which superimpose the measurements. Technically it would be much more interesting to determine isentropic efficiencies aerodynamically but the measurement of these parameters is much more difficult.

It is important that the approaches developed in research are applicable in industrial boundary conditions because only then they can be used to optimize the existing processes.



## REFERENCES

- [1] Baar, R.; Biet, C.; Boxberger, V.; Mai, H.; Zimmermann, R. (2013): *Moeglichkeiten der direkten Bestimmung des isentropen Turbinenwirkungsgrads*. In: Aufladetechnische Konferenz. Dresden. 2013.
- [2] Savic, B., Zimmermann, R., Jander, B., Baar, R., (2017). *New Phenomenological and Power-Based Approach for Determining the Heat Flows of a Turbocharger directly from hot gas test data*. In: 12th European Conference on turbomachinery, ETC, , Stockholm, Sweden
- [3] Baar, R.; Biet, C.; Boxberger, V.; Mai, H.; Zimmermann, R. (2014): *New Evaluation of Turbocharger Components based on Turbine Outlet Temperature Measurements in Adiabatic Conditions*. In: ISROMAC-15, Honolulu, Hawaii. 2014.
- [4] Baar, R.; Biet, C.; Zimmermann, R. (2015): *Experimental Modelling of Adiabatic Turbocharger Conditions to Investigate the Isentropic Turbine Efficiency*. In: Engine Processes. Berlin. 2015.
- [5] Zimmermann, R.; Baar, R.; Biet, C. (2016): *Determine the isentropic turbine efficiency due to adiabatic measurements, and the validation of the conditions via a new criterion*. In: 12 International Conference on Turbochargers and Turbocharging. London. 2016.
- [6] Baar, R.; Savic, B., Zimmermann, R. (2017): *Ein neues Verfahren zur Bedatung von aerodynamischen, thermischen und mechanischen Turboladermodellen*. In: Der Verbrennungsmotor - ein Antrieb mit Vergangenheit und Zukunft. Springer Vieweg, Wiesbaden. 2017. ISBN 978-3-658-19290-7. Pages 37-59.
- [7] Zimmermann, R., Savic, B., Baar, R. (2017): *Erweiterte Turboladermodellbildung mittels Heißgasprüfstandsdaten, eine Retrospektive und Ausblicke eines innovativen Ansatzes*. In: Aufladetechnische Konferenz. Dresden. 2017

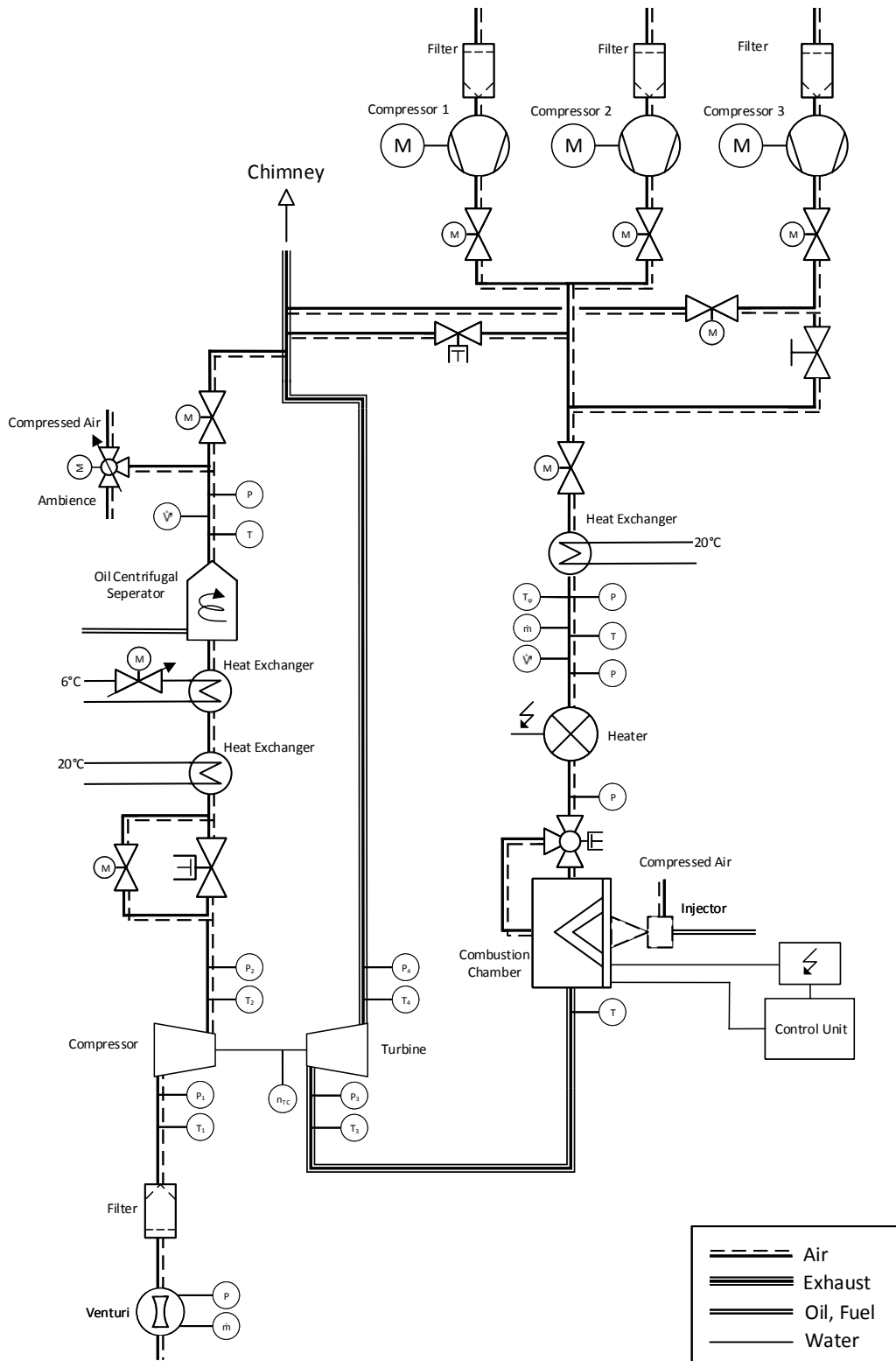

Figure 19. Turbocharger test bench Technical University Berlin (DIN EN ISO 10628-2, DIN 28000-4, DIN 28000-5)