



HAL
open science

Low-temperature synthesis of α -alumina nanosheets on microfibrillar-structured Al-fibers for Pd-catalyzed CO oxidative coupling to dimethyl oxalate

Chunzheng Wang, Weisong Xu, Zhengxing Qin, Xinmei Liu, Svetlana Mintova

► To cite this version:

Chunzheng Wang, Weisong Xu, Zhengxing Qin, Xinmei Liu, Svetlana Mintova. Low-temperature synthesis of α -alumina nanosheets on microfibrillar-structured Al-fibers for Pd-catalyzed CO oxidative coupling to dimethyl oxalate. *Catalysis Today*, 2020, 354, pp.158-166. 10.1016/j.cattod.2019.03.005 . hal-02409902

HAL Id: hal-02409902

<https://hal.science/hal-02409902>

Submitted on 27 Nov 2020

HAL is a multi-disciplinary open access archive for the deposit and dissemination of scientific research documents, whether they are published or not. The documents may come from teaching and research institutions in France or abroad, or from public or private research centers.

L'archive ouverte pluridisciplinaire **HAL**, est destinée au dépôt et à la diffusion de documents scientifiques de niveau recherche, publiés ou non, émanant des établissements d'enseignement et de recherche français ou étrangers, des laboratoires publics ou privés.

Low-temperature synthesis of α -alumina nanosheets on microfibrrous-structured Al-fibers for Pd-catalyzed CO oxidative coupling to dimethyl oxalate

Chunzheng Wang^{a,*}, Weisong Xu^a, Zhengxing Qin^a, Xinmei Liu^a, Svetlana Mintova^{a,b}

^a State Key Laboratory of Heavy Oil Processing, College of Chemical Engineering, China University of Petroleum (East China), Qingdao 266580, China

^b Laboratoire Catalyse et Spectrochimie (LCS), Normandie Université, ENSICAEN, UNICAEN, CNRS, 6 boulevard Maréchal Juin, Caen 14050, France

* Corresponding author. E-mail: *czwang@upc.edu.cn*

Abstract

We reported the low-temperature synthesis of α -Al₂O₃ nanosheets on the microfibrillar-structured Al-fibers at 800 °C. The boehmite (AlOOH) nanosheets were initially formed on the Al-fibers through in situ endogenous growth. Then the AlOOH/Al-fibers was transformed to the α -Al₂O₃/Al-fibers composite at 800 °C by a single heating step. The low-temperature phase transformation was tentatively attributed to the Al metal in the AlOOH/Al-fibers. Palladium was then dispersed on the α -Al₂O₃/Al-fibers composite, and the resulting Pd/ α -Al₂O₃/Al-fibers catalyst was examined in the strongly exothermic CO oxidative coupling to dimethyl oxalate (DMO) reaction. High CO conversion of 58 % and DMO selectivity of 95 % were obtained and maintained for at least 150 h using a feedgas of CH₃ONO / CO / N₂ (1 / 1.4 / 7.6, mole) at 150 °C with a gas hourly space velocity of 20000 mL g⁻¹ h⁻¹. Computational fluid dynamics calculations and experimental results indicated that the Pd/ α -Al₂O₃/Al-fibers catalyst remarkably decreased the hot-spot temperature of catalyst bed due to its enhanced thermal conductivity.

Keywords: Structured catalyst; Alpha alumina; Nanosheet; Phase transformation; Aluminum fiber; Dimethyl oxalate.

1. Introduction

Alpha alumina (α -Al₂O₃) is of fundamental and technological importance for plenty of applications in the petroleum industries and environmental protection [1–3]. In general, α -Al₂O₃ is derived from the thermolysis of gibbsite, boehmite, other hydrated alumina and undergoes a lot of transitional phases (η -, γ -, δ -, θ -, χ -, κ -Al₂O₃) [4,5]. However, these methods commonly require a high calcination temperature above 1100 °C and thus lead to high energy consumption. This becomes a reason for developing a low-temperature synthesis procedure of α -Al₂O₃. Several groups reported on the use of additives such as seeds, oxidants, chelating agents, mineralizers and special reactors (laser or microwave) to lower the formation temperature of α -Al₂O₃ [6,7]. Suchanek et al. reported the synthesis of α -Al₂O₃ nanosheets using AlOOH under hydrothermal treatment in the presence of α -Al₂O₃ seeds and additives (H₂O₂, SiO₂ and H₃BO₃) at 380–450 °C under 6.9–14.5 MPa [8,9].

The α -Al₂O₃-based catalysts are usually loaded in the fixed-bed reactors as randomly packed pellets of several millimeters. Such packed beds suffer from the large pressure drop, low intraparticle/interbed heat transfer and irregular flow pattern, which is detrimental to high-throughput, diffusion-determining and strongly exothermic/endothermic reactions [10,11]. To solve these problems, α -Al₂O₃ is directly manufactured into the structured foam and honeycomb monoliths, but the mechanical strength of the structure is very poor [12]. Furthermore, α -Al₂O₃ is deposited on the structured foam (Ni, Al) and honeycomb (cordierite) monoliths by coating techniques, which combines the merits of α -Al₂O₃ support with structured substances [13]. The catalysts using Al₂O₃-coated structured substances as supports, showed the high catalyst utilization and enhanced heat-transfer performance [14,15]. However, the conventional coating techniques are subjected to the nonuniformity and detachment of the coating layer as well as harmful contamination of the binder [16,17].

Recently, the conversion of non-petroleum syngas (CO/H₂) into chemicals and liquid fuels is a promising alternative to the petrochemical-based routes [18]. The gas-phase carbonylation of methyl nitrite (CH₃ONO) to dimethyl oxalate (DMO, (CH₃OCO)₂) is a pivotal step from syngas to ethylene glycol (DMO hydrogenation) [19]. This process is self-closing and includes chemical-looping with two main reactions: (1) Pd-catalyzed CO oxidative coupling to DMO: $2 \text{CH}_3\text{ONO} + 2 \text{CO} \rightarrow 2 \text{NO} + (\text{CH}_3\text{OCO})_2$; and (2) noncatalytic CH₃ONO regeneration: $2 \text{NO} + 2 \text{CH}_3\text{OH} + 1/2 \text{O}_2 \rightarrow 2 \text{CH}_3\text{ONO} + \text{H}_2\text{O}$. The overall reaction ($2 \text{CO} + 2 \text{CH}_3\text{OH} + 1/2 \text{O}_2 \rightarrow (\text{CH}_3\text{OCO})_2 + \text{H}_2\text{O}$) is highly efficient and environmentally benign. However, the industrial Pd/ α -Al₂O₃ catalyst for CO oxidative coupling to DMO, needs a high Pd content of 2 wt.% (the-state-of-the-art), leading to a compromised economy of the DMO production [20]. The on-going efforts have been dedicated to reduce the Pd content by proper tuning of the Pd size/shape, Pd-support interactions and adding of a promoter [21–23]. Peng et al. reported a high-performance Pd/ α -Al₂O₃ catalyst with Pd content of only 0.13 wt.% [22]. Nevertheless, little attention is paid to the α -Al₂O₃ support used in the strongly exothermic CO oxidative coupling to DMO ($\Delta H_{25\text{ }^\circ\text{C}} = -159 \text{ kJ mol}^{-1}$). The real application of α -Al₂O₃ a few millimeters in size, may provoke large temperature rise with undesired hot spot in the reactor bed, which decreases the product selectivity and even makes the temperature control difficult [21,23]. To overcome this problem, a structured Pd-Fe/ α -Al₂O₃-coated-cordierite catalyst was prepared, but the Pd loading was as high as 1.0 wt.% [21]. Therefore, it is important to develop a highly efficient, low Pd-loaded catalyst with enhanced heat transfer for both fundamental study and commercial application.

Herein, we revealed the low-temperature synthesis method of α -Al₂O₃ nanosheets on the microfibrillar-structured Al-fibers through the phase transformation of AlOOH nanosheets at 800 °C. Both the metal Al-promoted phase transformation of AlOOH and the formation of α -Al₂O₃ were

carefully studied. The Pd/ α -Al₂O₃/Al-fibers catalyst was prepared by incipient-wetness impregnation using the as-obtained α -Al₂O₃/Al-fibers composite, and was tested in the strongly exothermic CO oxidative coupling to DMO reaction. Such microfibrinous-structured catalyst showed a combination of improved heat transfer, low pressure drop, good activity, and excellent stability. The computational fluid dynamics (CFD) simulation was carried out to probe the heat-transfer ability of the microfibrinous-structured catalyst.

2. Experimental

2.1. Catalyst preparation

A thin fibers felt (2.0 m length \times 1.0 m width \times ~1.3 mm thickness) of 60- μ m Al-fibers (99.9 wt.% Al) was employed as a substrate; it was purchased from Shanghai Xincal Network-microstructured Material Co. Ltd. (China). The circular Al-fibers (8 mm diameter; equal to the internal diameter of fixed-bed reactor) were tailored from the purchased fibers felt, and treated with 0.1 wt.% NaOH solution at 25 °C for 2 min to remove the protective oxide layers from the surface. Subsequently, the pre-treated Al-fibers were loaded into a quartz tube, and oxidized in steam flow at 120 °C for 6 h to form the boehmite (AlOOH) nanosheets on the Al-fibers surface (denoted as AlOOH/Al-fibers) [24]. The as-prepared AlOOH/Al-fibers were heated to 800 °C in air with a ramping rate of 2 °C min⁻¹ and kept at that temperature for 2 h to obtain the α -Al₂O₃/Al-fibers composite.

The catalysts with a theoretical Pd content of 0.3 wt.% were prepared, as described elsewhere [23]. 0.0128 g of palladium acetate (Pd(CH₃COO)₂, 47 wt.% Pd, Sinopharm Chemical Reagent Co., Ltd., China) was dissolved in 3.7 g of toluene (C₆H₅CH₃) and the solution was used to impregnate 2.0 g of the α -Al₂O₃/Al-fibers composite. After drying at 100 °C for 2 h, the pre-impregnated Al-fibers were calcined at 300 °C in air for 2 h to obtain the catalyst denoted as Pd/ α -Al₂O₃/Al-fibers. For reference,

an α -Al₂O₃ (60–80 mesh; Alfa Aesar (China) Chemical Co. Ltd.) support was used to prepare the Pd/ α -Al₂O₃ catalyst by the same preparation method.

2.2. Characterizations

Scanning electron microscope (SEM) observations were conducted on a Hitachi S-4800 instrument. Transmission electron microscope (TEM) images were obtained with a FEI TECNAI G² F30 instrument at 300 kV. The shell of the α -Al₂O₃/Al-fibers composite was carefully removed by a cutter knife and then the obtained powder (i.e., the shell) was used for the TEM analysis. X-ray diffraction (XRD) patterns of samples were recorded on a Rigaku Ultima IV diffractometer with Cu K α radiation (35 kV and 25 mA). Diffuse reflectance infrared Fourier transform spectroscopy (DRIFTS) spectra were recorded in a Bruker Tensor 27 spectrometer equipped with a Harrick Scientific HVC-DRP-4 cell and a liquid N₂ cooled mercury-cadmium-telluride (MCT) detector. The actual Pd loading was measured using inductively coupled plasma-atomic emission spectroscopy (ICP-AES) with a Thermo IRIS Intrepid II XSP apparatus. Prior to the analysis, the sample was dissolved in aqua regia. Pd ICP standard solutions with concentrations of 5, 10 and 20 $\mu\text{g g}^{-1}$ were used to obtain the calibration curve. Nitrogen physisorption was performed at $-196\text{ }^{\circ}\text{C}$ using a Quantachrome Quadrasorb-evo instrument. The specific surface area and pore size distribution were estimated using the Brunauer-Emmett-Teller (BET) theory and Barrett-Joyner-Halenda (BJH) method based on the desorption branch of the isotherms. X-ray photoelectron spectroscopy (XPS) spectra were obtained on an Escalab 250xi spectrometer with an analyzer pass energy of 30.0 eV and an Al K α X-ray source (300 W). The results were referenced to the adventitious carbon, C1s peak at 284.6 eV prior to fitting the spectra. H₂-temperature programmed reduction (H₂-TPR) was conducted on a Tianjin XQ TP-5080 apparatus equipped with a thermal conductivity detector (TCD). 100 mg of sample was treated with He (flow of

40 mL min⁻¹) at 300 °C for 1 h and then cooled to 25 °C. Subsequently, a gas mixture of 5 vol.% H₂/N₂ was introduced into the reactor at 40 mL min⁻¹. After the baseline of TCD signal was steady, the sample was heated to 300 °C at 10 °C min⁻¹.

2.3. Catalytic tests

The catalytic behavior of the Pd/ α -Al₂O₃/Al-fibers and Pd/ α -Al₂O₃ catalysts was tested in a vertical fixed-bed, continuous down-flow quartz tube microreactor (internal diameter of 8 mm, length of 760 mm) (Scheme 1) [25]. Three calibrated mass flow controllers were employed to regulate the flow rates of N₂, CO, the gas mixture of methyl nitrite (CH₃ONO) and N₂. The weight of the catalyst was 0.12 g at gas hourly space velocity (GHSV) of 20000 mL g⁻¹ h⁻¹ and 0.04 g at GHSV of 60000 mL g⁻¹ h⁻¹. The reaction temperature was varied in the range of 120–200 °C. Prior to the test, the catalyst was in situ activated by performing the CO oxidative coupling to DMO at 200 °C for 2 h with a gas mixture of CH₃ONO / CO / N₂ (1 / 1.4 / 7.6, mole) [23]. The outlet gas was analyzed by an on-line gas chromatography (GC; Shanghai Ouhua 9160, China) equipped with a thermal conductivity detector (TCD) and flame ionization detector (FID). The TCD and FID were connected to a ShinCarbon ST packed column (DIKMA) and Innowax PEG-20M capillary column (HP), respectively. The six-way valve for FID and partial gas pipelines were heated at 120 °C to avoid the condensation of reaction products. The calculations of the turnover frequency (TOF), CO conversion, DMO selectivity and “methanol + methyl formate” (ME + MF) selectivity were presented in the Supporting Information.

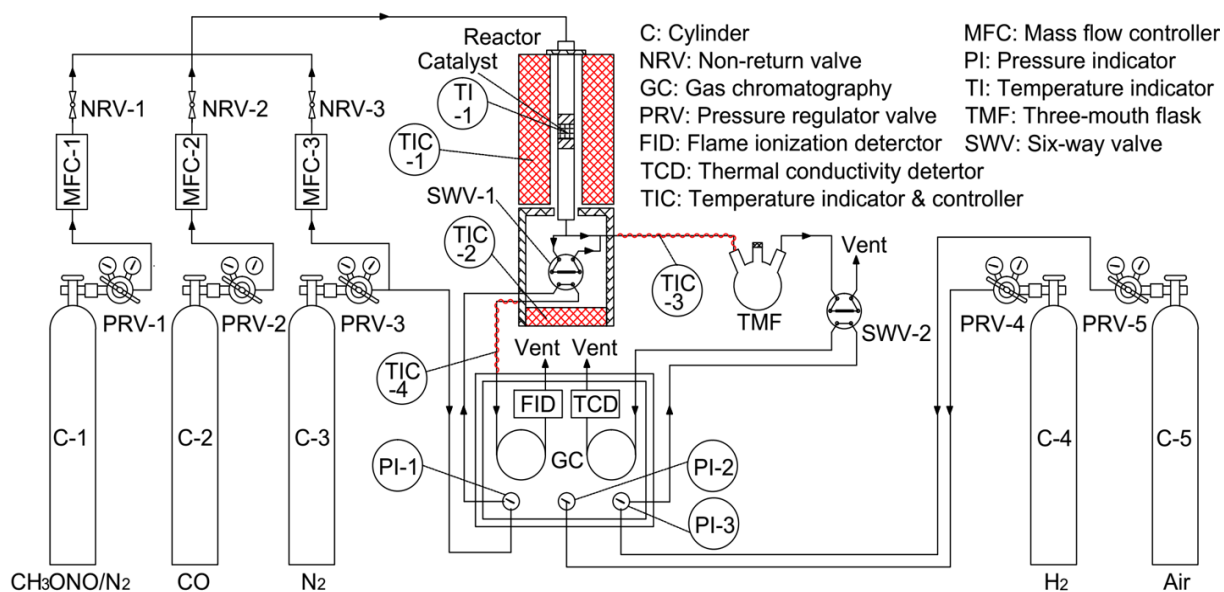

Scheme 1. Schematic diagram of the apparatus used for catalyst testing (the red parts are heated).

3. Results and discussion

3.1. Low-temperature synthesis of α - Al_2O_3 nanosheets on microfibrrous-structured Al-fibers

3.1.1. Feature of α - Al_2O_3 /Al-fibers composite

Figure 1A schematically illustrates the endogenous growth of AlOOH nanosheets on the microfibrrous-structured Al-fibers and the subsequent formation of α - Al_2O_3 nanosheets by low-temperature treatment (calcination). Circular Al-fibers with entirely open three-dimensional (3D) network, consisting of 10 vol.% 60- μm Al-fibers and 90 vol.% void volume were employed as the pristine substrate (Fig. 1B). The Al-fibers had a smooth surface as shown in the SEM images (Fig. S1). With the aid of the steam-only oxidation between Al metal and H_2O at $120\text{ }^\circ\text{C}$ ($2\text{ Al} + 4\text{ H}_2\text{O} \rightarrow 2\text{ AlOOH} + 3\text{ H}_2$), the uniform and honeycomb-like AlOOH nanosheets were endogenously generated, and aligned to a nanosheet array (shell) on the Al-fibers (core) (Fig. 1C) [24]. The thickness of the AlOOH shell was about $0.7\text{ }\mu\text{m}$ (inset of Fig. 1C) corresponding to an AlOOH content of 7.5 wt.% [24]. The as-prepared AlOOH/Al-fibers composite was calcined in air at $800\text{ }^\circ\text{C}$. The nanosheets were

preserved (Fig. 1D) but the microstructure of these nanosheets was slightly changed, possibly due to the dehydroxylation of the AlOOH (Fig. S2). It should be noted that the metal Al (core) could not leak from the core-shell AlOOH/Al-fibers composite even at high-temperature treatment at 800 °C (melting point of Al is 660 °C), due to the obstruction of densely packed AlOOH nanosheets (shell). The similar observations were obtained on the Al alloys (Ni-Al and Fe-Al), indicating that the protective alumina scale on the alloys surface could provide excellent oxidation resistance above 1000 °C [26-28]. The characteristic diffraction peaks of metal Al (JCPDS 04-0787) were clearly observed in the pristine Al-fibers (Fig. 1E, pattern a). The weak diffraction peaks at 28.2 and 49.3° 2 theta were attributed to the boehmite (JCPDS 21-1307) (Fig. 1E, pattern b). After the calcination at 800 °C, the α -Al₂O₃/Al-fibers composite showed the formation of α -Al₂O₃ phase (JCPDS 10-0173) confirmed by the appearance of the diffraction peaks at 25.6, 35.1, 43.4, 52.6, 57.5, 66.5 and 68.2° 2 theta (Fig. 1E, pattern c). In addition, the DRIFTS spectrum of AlOOH/Al-fibers composite contained five bands at 3336, 3126, 1066, 857 and 788 cm⁻¹ that correspond to boehmite (Fig. 1F). The broad bands in the region 3600–3100 cm⁻¹ were assigned to O-H stretching vibrations of water, while the bands at 950–600 cm⁻¹ are the Al-O bending stretching mode of α -Al₂O₃ [29,30]. The DRIFTS results were in a good agreement with the XRD results. The as-prepared α -Al₂O₃/Al-fibers composite had a BET specific surface area of 4.0 m² g⁻¹ and a total pore volume of 0.012 cm³ g⁻¹ (including the Al-fibers) (Fig. 1G). After the Al-fibers content of ~93 wt.% was subtracted, it was calculated that the α -Al₂O₃ shell had a large BET surface area of ~50.0 m² g _{α -Al₂O₃}⁻¹ and total pore volume of ~0.150 cm³ g _{α -Al₂O₃}⁻¹. The α -Al₂O₃/Al-fibers composite displayed a type-IV isotherm and mesopores with a size in the range of 4–19 nm. The appearance of type-H3 hysteresis loop at P/P₀ > 0.5 was attributed to the voids formed by stacking of α -Al₂O₃ nanosheets (Fig. 1G).

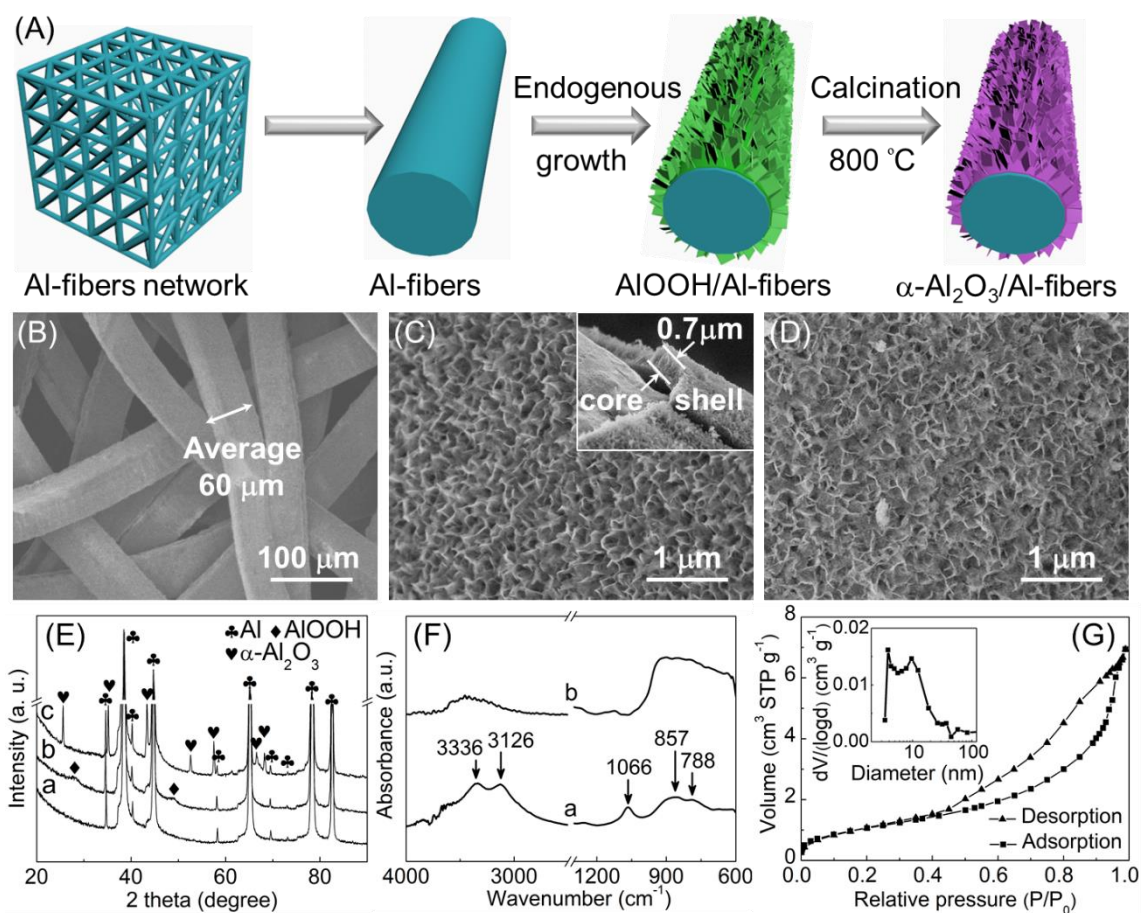

Fig. 1. (A) Schematic presentation of the top-down strategy applied for preparation of the core-shell α -Al₂O₃/Al-fibers composite. SEM images of (B) microfibrillar-structured Al-fibers, (C) AlOOH/Al-fibers (*Inset*: core(Al-fibers)-shell(AlOOH) structure) and (D) α -Al₂O₃/Al-fibers composite. (E) XRD patterns of the (a) Al-fibers substrate, (b) AlOOH/Al-fibers and (c) α -Al₂O₃/Al-fibers composite. (F) DRIFTS spectra of (a) AlOOH/Al-fibers and (b) α -Al₂O₃/Al-fibers composite, and (G) N₂ sorption isotherm of the α -Al₂O₃/Al-fibers composite (*Inset*: BJH mesopore size distribution obtained from the desorption branch of the isotherm).

The shell of the α -Al₂O₃/Al-fibers composite was carefully removed by a cutter knife and the obtained powder (the shell) was analyzed by TEM (Fig. 2). TEM images showed that the shell of the α -Al₂O₃/Al-fibers composite was composed of nanosheets (Fig. 2A). This observation was in

agreement with the nanosheet array observed in the SEM image (Fig. 1D). The nanosheets structure remained intact after calcination at 800 °C, indicating the good thermal stability. The thickness of the nanosheets was 2–6 nm as measured by TEM (Fig. 2A). From the HRTEM image, the lattice spacing of the nanosheets of 0.25 nm was calculated, which possibly corresponds to the (104) lattice plane of α -Al₂O₃ crystals (JCPDS 10-0173). This result further verified the formation of α -Al₂O₃ on the α -Al₂O₃/Al-fibers composite, which was consistent with the XRD and DRIFTS results (Fig. 1E and Fig. 1F).

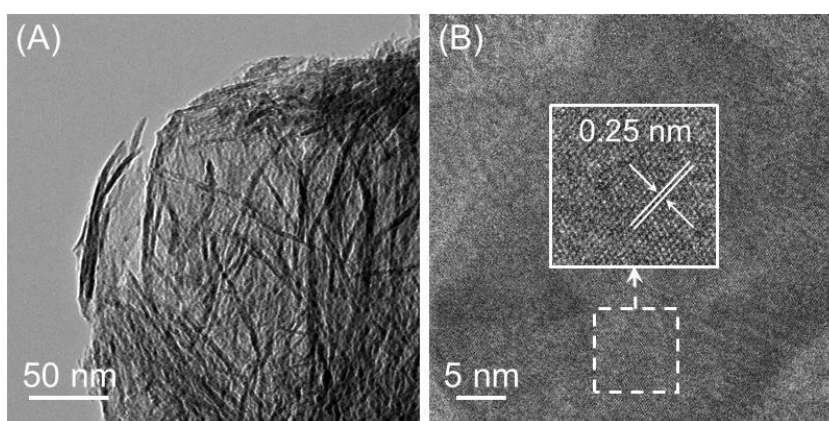

Fig. 2. TEM images of the α -Al₂O₃/Al-fibers composite: (A) scale bar, M = 50 nm and (B) scale bar, M = 5 nm (*Inset*: enlarged area of the composite with a lattice spacing of the nanosheets of 0.25 nm).

3.1.2. Phase transformation of AlOOH in the Al-fibers

Fig. 3 shows the XRD patterns of the AlOOH/Al-fibers composite calcined at various temperatures. After calcination at 600 °C, the diffraction peaks at 45.8 and 67.1° 2 theta were assigned to γ -Al₂O₃ (JCPDS 80-0956) (Fig. 3, pattern a). This revealed that the AlOOH on the Al-fibers could convert to γ -Al₂O₃ at 600 °C. The peak intensity of 67.1° 2 theta increased gradually but the γ -Al₂O₃ phase remained unchanged with arising the calcination temperature from 600 to 750 °C (Fig. 3, patterns a–c). However, the AlOOH on the Al-fibers was transformed into α -Al₂O₃ at 800 °C (Fig. 3, pattern d). The

composite after calcination at 600 °C was calcined again at 800 °C, and the XRD pattern was identical with that of the composite calcined at 800 °C (Fig. 3, patterns d,e). This suggested that the γ - Al_2O_3 on the Al-fibers converted to α - Al_2O_3 at 800 °C. This result confirmed that the AlOOH on the Al-fibers is transformed according to the following scheme: $\text{AlOOH} \rightarrow \gamma\text{-Al}_2\text{O}_3 \rightarrow \alpha\text{-Al}_2\text{O}_3$.

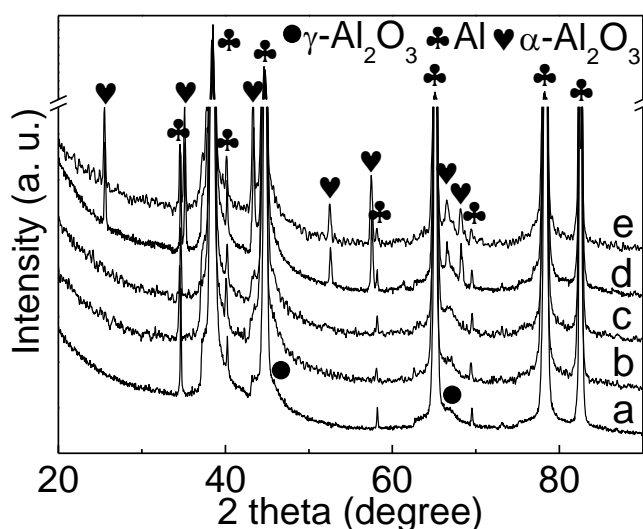

Fig. 3. XRD patterns of the AlOOH/Al -fibers composite after calcination: (a) 600 °C for 2 h, (b) 700 °C for 2 h, (c) 750 °C for 2 h, (d) 800 °C for 2 h, (e) 600 °C for 2 h and subsequent 800 °C for 2 h.

Fig. 4 shows the XPS spectra of the Al 2p and O 1s regions for the AlOOH/Al -fibers composite before and after calcination. As shown in Fig. 4A, these four composites had a binding energy (BE) of 74.0–74.6 eV, which was attributed to Al^{3+} in alumina [31]. The absence of Al 2p peak at 72.5 eV indicated that the Al-Al bond (Al metal) was not present on the surface of these four composites [32]. This further confirmed the SEM observation that the metal Al could not leak from the Al-fibers under calcination at 800 °C (Fig. 1D). The full width at half-maximum (FWHM) of Al 2p peak on the AlOOH/Al -fibers (1.5 eV) without calcination was lower than of the other three composites (2.0–2.3 eV) (Fig. 4A and Table 1). The Al 2p peak with a characteristic FWHM of 1.5 eV was attributed to boehmite [33], suggesting the presence of AlOOH on the surface of the AlOOH/Al -fibers. This result

was consistent with the XRD and DRIFTS results (Fig. 1E and 1F). As shown in Fig. 4B, the broad O 1s spectra were decomposed into two component species: Al-O (530.7 eV) and Al-OH (532.1 eV) [34,35]. From the XPS results one can see that the peak area ratio of Al-O and Al-OH gradually increased, due to the desorption of hydroxyl groups at high temperature (Fig. 4B and Table 1).

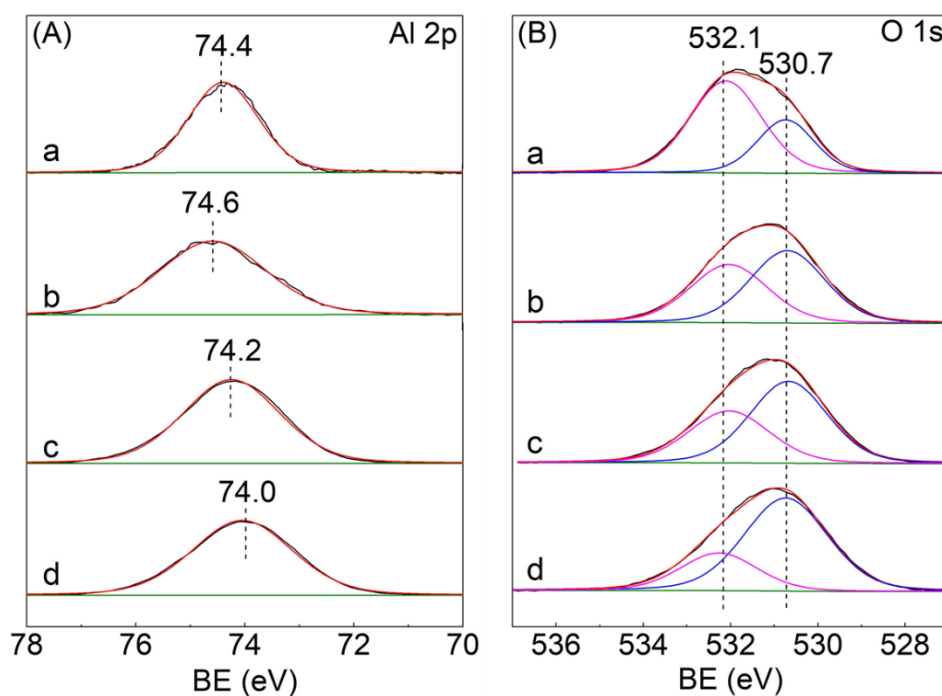

Fig. 4. XPS spectra of (A) Al 2p and (B) O 1s regions of the AlOOH/Al-fibers composite (a) without calcination and after calcination for 2 h at (b) 600 °C, (c) 700 °C and (d) 800 °C; the XPS peaks were deconvoluted using the Gaussian-Lorentzian sum function and Newton iteration method after a linear background subtraction.

Table 1. Parameters obtained from the XPS spectra^a.

Sample ^a	Al 2p		O 1s at 530.7 eV		O 1s at 532.1 eV		O 1s Ratio ^b
	BE (eV)	FWHM (eV)	FWHM (eV)	Area	FWHM (eV)	Area	
a	74.4	1.5	1.9	738	1.5	1584	0.46

b	74.6	2.3	2.1	1172	2.0	977	1.20
c	74.2	2.0	2.2	1313	2.1	771	1.70
d	74.0	2.1	2.1	1489	2.3	549	2.71

^a XPS spectra of the AlOOH/Al-fibers composite without calcination (a) and after calcination for 2 h at (b) 600 °C, (c) 700 °C and (d) 800 °C.

^b Area ratio of O 1s peak at 530.7 eV to the peak at 532.1 eV.

3.1.3. Low-temperature synthesis of α -Al₂O₃: promotion of Al metal

The low-temperature phase transformation from AlOOH to α -Al₂O₃ was initially attributed to the presence of Al metal. Firstly, reference AlOOH nanosheets were synthesized from a bayerite precursor as described elsewhere (Fig. 5A, pattern a) [36]. Even though the average thickness of the reference AlOOH nanosheets (1–5 nm measured by TEM images) was similar to the counterpart of nanosheets of the AlOOH/Al-fibers (Fig. 2A) [36], the former was totally transformed into γ -Al₂O₃ after calcination at 800 °C (Fig. 5A, pattern b). This was consistent with the previous reports revealing that the boehmite could not convert to α -Al₂O₃ at 800 °C [37,38]. Secondly, to study the effect of the Al metal, the AlOOH/Al-fibers composite calcined at 600 °C was treated with an excess of NaOH solution (4.0 wt.%) to remove the Al metal. Note that the concentration of NaOH solution should be carefully controlled, otherwise the composite will be completely dissolved in a concentrated solution. After the treatment, the rest of the AlOOH/Al-fibers composite calcined at 600 °C showed the characteristic diffraction peaks corresponding to the γ -Al₂O₃ phase (Fig. 5B, pattern a). The rest of the AlOOH/Al-fibers composite after the calcination at 600 °C and the subsequent NaOH treatment, was treated at 800 °C but the γ -Al₂O₃ crystalline phase remained (Fig. 5B, pattern b). Both γ -Al₂O₃ and AlOOH on the Al-fibers could transform to the α -Al₂O₃ at 800 °C as previously stated (Fig. 3, patterns d,e) while only the γ -Al₂O₃ without the Al-fibers could not (Fig. 5B). The phase transformation to α -Al₂O₃ is governed

by nucleation and grain growth mechanism [39,40]. It has been confirmed experimentally and by modeling that the α - Al_2O_3 can be formed at low temperature (900–1100 °C) on Al alloys such as Fe-Al and Ni-Al, due to the promoted α - Al_2O_3 nucleation at the oxide/metal interface [7,41]. It is thus reasonable to infer that the formation of α - Al_2O_3 at 800 °C was possibly attributed to the Al metal in the AlOOH/Al -fibers composite, which lowered the nucleation energy barrier of α - Al_2O_3 at the oxide/Al metal interface.

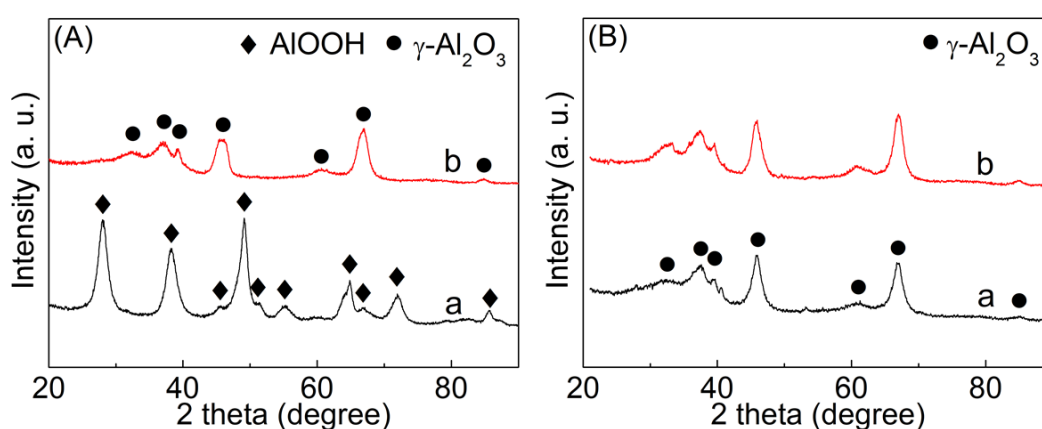

Fig. 5. (A) XRD patterns of the reference boehmite nanosheets (a) before and (b) after calcination at 800 °C. (B) XRD patterns of AlOOH/Al -fibers composite (a) calcined at 600 °C for 2 h and then treated with an excess of NaOH solution (4.0 wt.%) for 24 h, and (b) calcined at 600 °C, treated with NaOH solution and then calcined at 800 °C for 2 h.

3.2. Microfibrinous-structured $\text{Pd}/\alpha\text{-Al}_2\text{O}_3/\text{Al}$ -fibers catalyst for CO oxidative coupling to DMO

3.2.1. Features of $\text{Pd}/\alpha\text{-Al}_2\text{O}_3/\text{Al}$ -fibers catalyst

The $\text{Pd}/\alpha\text{-Al}_2\text{O}_3/\text{Al}$ -fibers catalyst was prepared by incipient-wetness impregnation method using the as-prepared $\alpha\text{-Al}_2\text{O}_3/\text{Al}$ -fibers as support. As shown in Fig. 6A, the nanosheet array of $\alpha\text{-Al}_2\text{O}_3$ was well retained after the Pd loading. No diffraction peaks of PdO (JCPDS 88-2434) and Pd (JCPDS 01-1201) were detectable except the peaks corresponding to Al and $\alpha\text{-Al}_2\text{O}_3$, possibly due to a good

Pd dispersion (Fig. 6B). In fact, the Pd was homogeneously dispersed on the α -Al₂O₃/Al-fibers composite, with an average particle size of 4.4 ± 0.9 nm (Fig. 6C). The stacks of nanosheets of the catalyst were clearly observed, consistent with the catalyst support (Fig. 2A and Fig. 6C). The Pd/ α -Al₂O₃/Al-fibers catalyst contains mesopores with a size of 4–19 nm and the BET specific surface area is $3.9 \text{ m}^2 \text{ g}^{-1}$ with a total pore volume of $0.011 \text{ cm}^3 \text{ g}^{-1}$ (including the Al-fibers mass), which were almost equal to the α -Al₂O₃/Al-fibers composite (Fig. 1G and Fig. 6D).

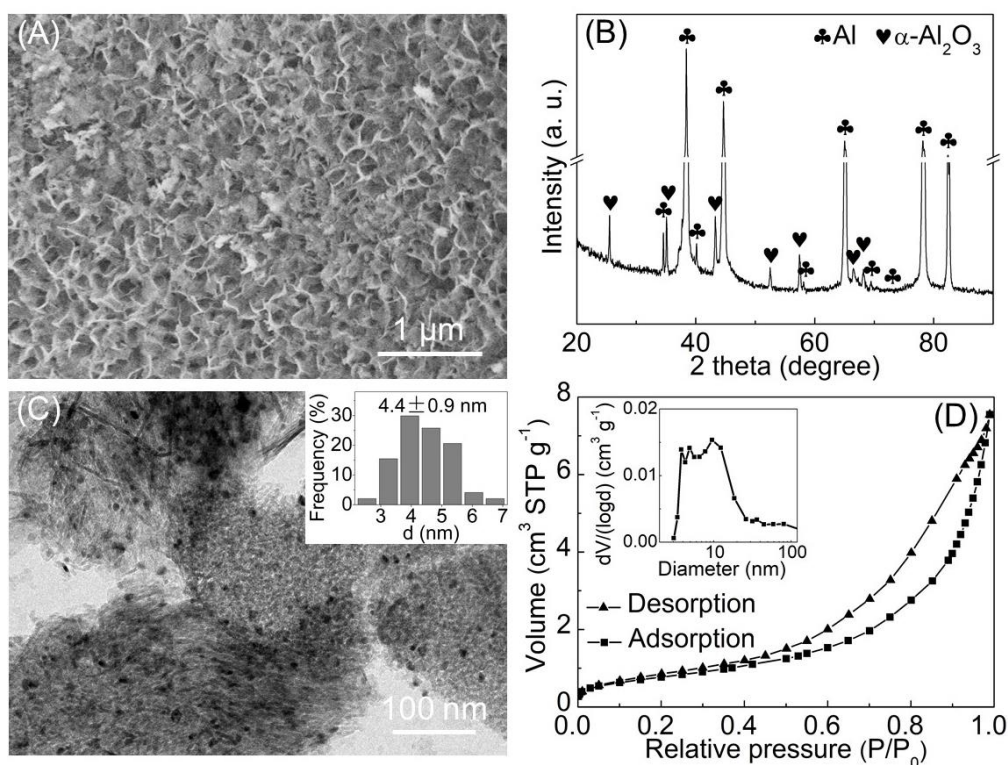

Fig. 6. (A) SEM image, (B) XRD pattern, (C) TEM image and (D) N₂ sorption isotherm (*Inset*: BJH mesopore size distribution obtained from the desorption branch of the isotherms) of the Pd/ α -Al₂O₃/Al-fibers catalyst.

3.2.2. Catalytic performance of Pd/ α -Al₂O₃/Al-fibers catalyst

The microfibrinous-structured Pd/ α -Al₂O₃/Al-fibers catalyst was tested in the CO oxidative coupling to DMO using a GHSV of $20000 \text{ mL g}^{-1} \text{ h}^{-1}$ and a feedgas of CH₃ONO / CO / N₂ (1 / 1.4 / 7.6, mole). Compared to the reference catalyst of Pd/ α -Al₂O₃, the Pd/ α -Al₂O₃/Al-fibers delivered similar CO

conversion, DMO selectivity and “methanol + methyl formate” (ME + MF) selectivity in the range of 120–140 °C (Fig. 7). Interestingly, the Pd/ α -Al₂O₃/Al-fibers showed higher CO conversion, DMO selectivity, and lower “ME + MF” selectivity than the reference Pd/ α -Al₂O₃ catalyst at temperatures ranging from 150 to 170 °C (Fig. 7). This evolution behavior was initially assigned to the different thermal conductivity of microfibrrous-structured Al-fibers and the α -Al₂O₃. It should be pointed out that the CO oxidative coupling to DMO is highly exothermic ($\Delta H_{25\text{ }^\circ\text{C}} = -169\text{ kJ mol}^{-1}$), which may induce large temperature rise with unexpected hot spot in the reactor bed [23]. To examine the reaction heat effect, the thermocouple was inserted in the upper side of the catalyst bed. For example, the temperature rise detected (the temperature obtained from the thermocouple minus the reactor wall temperature of 150 °C) was 5 °C on the Pd/ α -Al₂O₃/Al-fibers catalyst and 11 °C on the Pd/ α -Al₂O₃ catalyst. The decomposition of the CH₃ONO reactant ($4\text{ CH}_3\text{ONO} \rightarrow \text{CH}_3\text{OCHO} + 2\text{ CH}_3\text{OH} + 4\text{ NO}$) was very sensitive to the reaction temperature [42,43], and was boosted in the range of 150–170 °C on the Pd/ α -Al₂O₃ catalyst. It was concluded that the low temperature rise inhibited the inefficient decomposition of the CH₃ONO reactant and thus led to the enhanced activity on the Pd/ α -Al₂O₃/Al-fibers catalyst. Clearly, our Pd/ α -Al₂O₃/Al-fibers catalyst exhibited better conversion and selectivity at high temperature of 150–170 °C, which would be an advantageous feature compared to the reference Pd/ α -Al₂O₃ catalyst, by considering the strong exothermicity of the CO oxidative coupling to DMO.

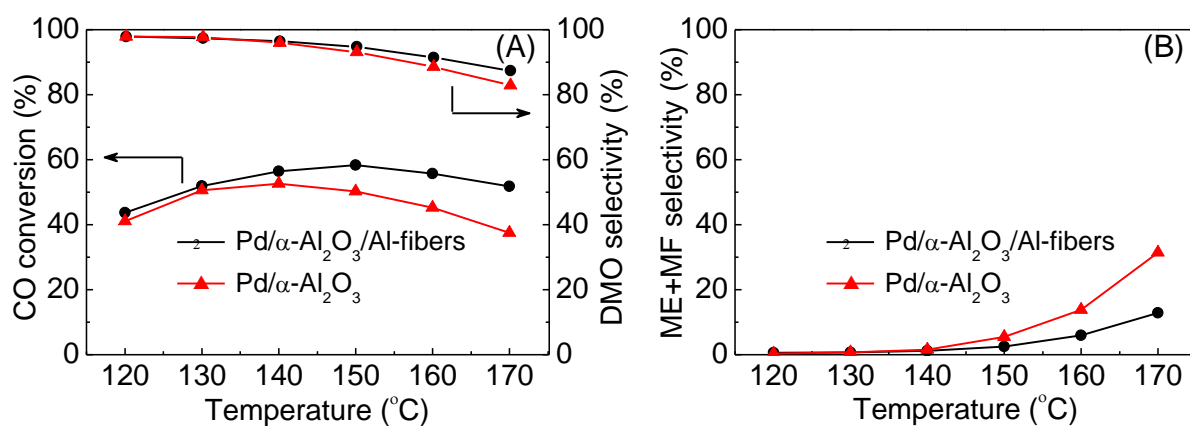

Fig. 7. (A) CO conversion, DMO selectivity and (B) “methanol + methyl formate” (ME + MF) selectivity for temperature-dependent CO oxidative coupling to DMO on the Pd/ α -Al₂O₃/Al-fibers and Pd/ α -Al₂O₃ catalysts. Reaction conditions: 0.12 g catalyst, CH₃ONO / CO / N₂ = 1 / 1.4 / 7.6 (mole), GHSV = 20000 mL g⁻¹ h⁻¹, 1 bar. Each point was an average of 3 measurements conducted. The DMO and “ME + MF” selectivity were based on the CO and CH₃ONO, respectively (details were provided in the Supporting Information).

The catalyst characteristics and intrinsic activity (i.e., TOF) of the Pd/ α -Al₂O₃/Al-fibers and Pd/ α -Al₂O₃ were summarized in Table 2. The Pd loadings of the two catalysts were determined to be 0.25 wt.% and 0.26 wt.% by ICP-AES analysis. The average Pd particle sizes (d) in the Pd/ α -Al₂O₃/Al-fibers and Pd/ α -Al₂O₃ were 4.4 nm and 2.0 nm (TEM images in Fig. 6C and Fig. S3), corresponding to the Pd dispersion (D) of 0.25 and 0.56, respectively (the D was calculated using the formula $D = 1.12 / d$ [23]). Similar H₂-temperature programmed reduction (TPR) curves for the two catalysts were measured, which showed the catalysts could be completely reduced at about 120 °C (Fig. S4). As a control experiment, the CO conversion was decreased to be < 6% at 120 °C and GHSV of 60000 mL g⁻¹ h⁻¹ for the TOF calculation. The TOFs of 0.7 and 0.5 s⁻¹ for the two catalysts, respectively were obtained, indicating comparable intrinsic activity. Clearly, the Pd/ α -Al₂O₃/Al-fibers and Pd/ α -Al₂O₃ catalysts have similar Pd contents, reduction behavior, comparable Pd particle size and intrinsic activity. These results suggested that the α -Al₂O₃/Al-fibers composite is a promising alternative to the conventional α -Al₂O₃ for the CO oxidative coupling to DMO.

Table 2 Content, property and activity of the Pd/ α -Al₂O₃/Al-fibers and Pd/ α -Al₂O₃ catalysts^a.

Sample	Pd (wt.%) ^b	d (nm) ^c	D ^c	Surface Pd (mol g _{cat.} ⁻¹) ^d	TOF (s ⁻¹) ^e
--------	------------------------	-----------------------	------------------	--	-------------------------------------

Pd/ α -Al ₂ O ₃ /Al-fibers	0.25	4.4	0.25	6.6×10^{-6}	0.7
Pd/ α -Al ₂ O ₃	0.26	2.0	0.56	1.4×10^{-5}	0.5

^aReaction conditions: 0.04 g catalyst, 120 °C, GHSV = 60000 mL g⁻¹ h⁻¹, CH₃ONO / CO / N₂ = 1 / 1.4 / 7.6 (mole), 1 bar.

^bPd content determined by ICP-AES analysis.

^cPd particle size (d) obtained from TEM images in Fig. 6C and Fig. S3, and Pd dispersion (D) calculated by the formula: $D = 1.12 / d$ [23].

^d Surface Pd atoms determined by Pd dispersion (D) and Pd content.

^e TOF based on the CO conversion and surface Pd atoms.

3.2.3. Heat transfer enhancement

As previously stated, our main efforts were focused on the development of a microfibrillar-structured catalyst with a combination of high catalytic performance and excellent thermal conductivity. To probe the heat-transfer ability of our catalyst, the R was conducted to obtain the temperature distribution in the microfibrillar-structured bed of Pd/ α -Al₂O₃/Al-fibers and randomly packed bed of Pd/ α -Al₂O₃ catalysts. As shown in Fig. 8A, the tubular reactor was divided into three parts: one isothermal section and two adiabatic sections. The detailed CFD model and calculation methods were described in the Supporting Information. Fig. 8B shows the steady-state temperature distribution on the microfibrillar-structured Pd/ α -Al₂O₃/Al-fibers and the Pd/ α -Al₂O₃ catalysts. The released reaction heat on the two catalysts was similar due to the comparable CO conversion (58 % vs. 50 % at 150 °C, Fig. 7A) under identical reaction conditions. However, the reactor' temperature distribution of the Pd/ α -Al₂O₃/Al-fibers was more homogeneous than of the Pd/ α -Al₂O₃ (Fig. 8B); the former showed a

hot spot with a temperature rise of 8 °C, which was much lower than the latter of 30 °C (the highest temperature of CFD simulation minus the reactor wall temperature of 150 °C). The low temperature rise for the Pd/ α -Al₂O₃/Al-fibers catalyst was unambiguously attributed to the high thermal conductivity of the microfibrrous-structured Al-fibers, which rapidly dissipated a large amount of reaction heat [44,45]. Notably, the trend of temperature rise by CFD simulation was consistent with the experimental observation using a thermocouple (5 vs. 8 °C on the Pd/ α -Al₂O₃/Al-fibers catalyst; 11 vs. 30 °C on the Pd/ α -Al₂O₃ reference catalyst).

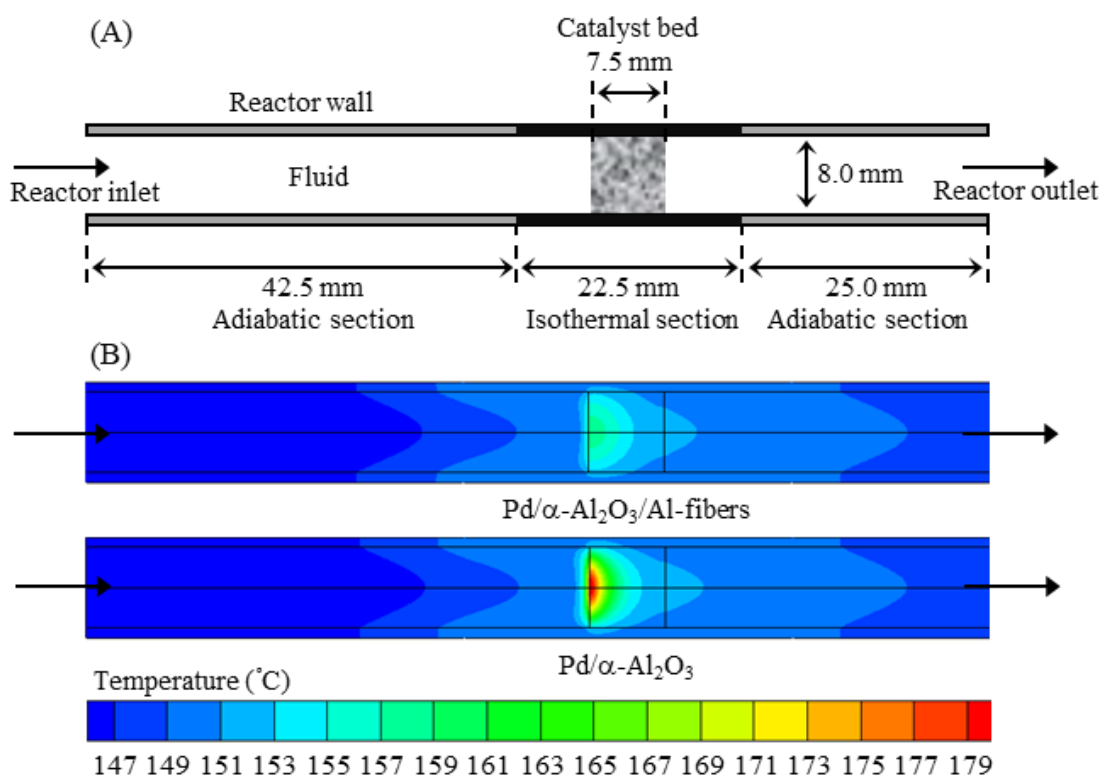

Fig. 8. (A) Schematic diagram of the system for CFD calculation, and (B) reactor temperature distribution obtained by the steady-state CFD simulation on the Pd/ α -Al₂O₃/Al-fibers catalyst and reference Pd/ α -Al₂O₃ catalyst.

3.2.4. Stability

To investigate the long-term stability of the catalyst, an experiment was run at 150 °C for 150 h on

the microfibrinous-structured Pd/ α -Al₂O₃/Al-fibers catalyst. The catalyst showed a good stability throughout the 150 h test, exhibiting a CO conversion of ~58% and DMO selectivity of ~95% (Fig. 9A). The diffraction peaks of PdO (JCPDS 88-2434) and Pd (JCPDS 01-1201) were still not detectable for the used catalyst after 150 h test (Fig. S5). The TEM image showed Pd nanoparticles with an average size of 4.5 ± 0.6 nm (Fig. S6), almost equal to that of the catalyst before the test (4.4 ± 0.9 nm, Fig. 6C). This suggested that the Pd/ α -Al₂O₃/Al-fibers catalyst was resistant to the sintering of Pd nanoparticles. A noteworthy feature of the used catalyst was that the nanosheet array of α -Al₂O₃ remained unaltered, confirmed by SEM (Fig. 9B,C) and XRD (Fig. S5) characterizations.

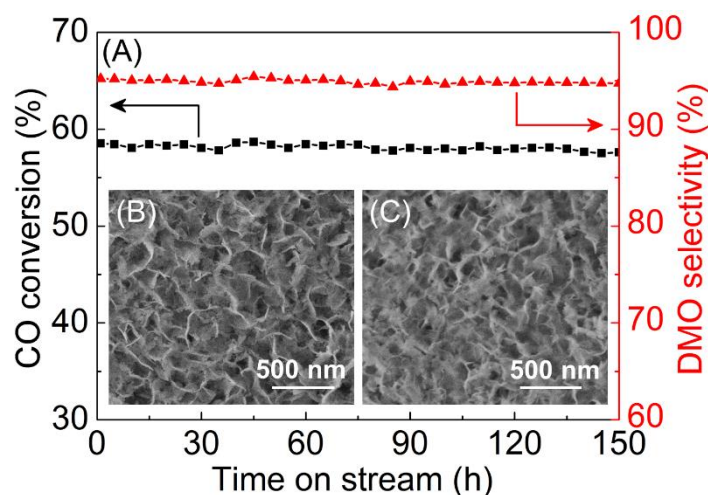

Fig. 9. (A) Durability performance of the Pd/ α -Al₂O₃/Al-fibers catalyst, and SEM images of (B) fresh and (C) used Pd/ α -Al₂O₃/Al-fibers catalyst after 150 h test. Reaction conditions: 0.12 g catalyst, CH₃ONO / CO / N₂ = 1 / 1.4 / 7.6 (mole), GHSV = 20000 mL g⁻¹ h⁻¹, 150 °C, 1 bar. Each point was an average of 5 measurements conducted.

4. Conclusions

The α -Al₂O₃ nanosheets on the microfibrinous-structured Al-fibers have been prepared through the phase transformation of boehmite nanosheets at temperature as low as 800 °C. The presence of Al metal

in the Al-fibers is responsible for the low-temperature phase transformation to α -Al₂O₃. Such α -Al₂O₃/Al-fibers, with enhanced heat transfer and low pressure drop, is a promising alternative to the conventional α -Al₂O₃ support in some industrial and environmental catalysis. As an example, the Pd/ α -Al₂O₃/Al-fibers catalyst is prepared via incipient-wetness impregnation, and tested in the strongly exothermic CO oxidative coupling to dimethyl oxalate (DMO). The catalyst with a low Pd loading of 0.25 wt.% exhibits a CO conversion of 58 % and DMO selectivity of 95 % with a feedgas of CH₃ONO / CO / N₂ (1 / 1.4 / 7.6, mole) at 150 °C with a large gas hourly space velocity of 20000 mL g⁻¹ h⁻¹. The Pd/ α -Al₂O₃/Al-fibers catalyst showed high stability during the continuous test of 150 h. The Pd/ α -Al₂O₃/Al-fibers catalyst effectively inhibited the side reaction and showed a higher activity compared to the conventional Pd/ α -Al₂O₃ catalyst, resulted from the decreased temperature of the catalyst bed. Furthermore, computational fluid dynamics calculations and experimental measurements demonstrated the large reduction of hot-spot temperature thanks to the enhanced thermal conductivity originated from the microfibrillar-structured Al-fibers.

Acknowledgements

This work was supported by the China Postdoctoral Science Foundation (2017M622311), Natural Science Foundation of China (21706285), Fundamental Research Funds for the Central Universities (18CX02148A, 18CX02013A), Postdoctoral Research Project of Qingdao (BY20170209) and the Sino-French International Laboratory (LIA) “Zeolites”.

References

- [1] J.E. van den Reijen, S. Kanungo, T.A.J. Welling, M. Versluijs-Helder, T.A. Nijhuis, K.P. de Jong, P.E. de Jongh, *J. Catal.* 356 (2017) 65–74.

- [2] E. Okon, H. Shehu, E. Gobina, *Catal. Today* 310 (2018) 146–156.
- [3] S. Gudyka, G. Grzybek, J. Gryboś, P. Indyka, B. Leszczyński, A. Kotarba, Z. Sojka, *Appl. Catal. B* 201 (2017) 339–347.
- [4] P. Pardo, J. Alarcón, *Ceram. Int.* 44 (2018) 11486–11496.
- [5] E. Rytter, A. Holmen, *Catal. Today* 275 (2016) 11–19.
- [6] T.P. Mokoena, E.C. Linganiso, H.C. Swart, V. Kumar, O.M. Ntwaeaborwa, *Ceram. Int.* 43 (2017) 174–181.
- [7] X. Liang, X. Wang, *Mater. Des.* 112 (2016) 519–529.
- [8] W.L. Suchanek, *J. Am. Ceram. Soc.* 93 (2010) 399–412.
- [9] W.L. Suchanek, J.M. Garcés, P.F. Fulvio, M. Jaroniec, *Chem. Mater.* 22 (2010) 6564–6574.
- [10] C. Wang, Y. Jia, Z. Zhang, G. Zhao, Y. Liu, Y. Lu, *Appl. Surf. Sci.* 478 (2019) 840–845.
- [11] S.S. Punde, B.J. Tatarchuk, *Appl. Catal. A* 441–442 (2012) 54–64.
- [12] J. Gascon, J.R. van Ommen, J.A. Moulijn, F. Kapteijn, *Catal. Sci. Technol.* 5 (2015) 807–817.
- [13] A. Montebelli, C.G. Visconti, G. Groppi, E. Tronconi, C. Cristiani, C. Ferreira, S. Kohler, *Catal. Sci. Technol.* 4 (2014) 2846–2870.
- [14] V. Paunovic, V. Ordonsky, M. Fernanda Neira D Angelo, J.C. Schouten, T.A. Nijhuis, *J. Catal.* 309 (2014) 325–332.
- [15] S. Wahid, D.R. Cahela, B.J. Tatarchuk, *AIChE J.* 60 (2014) 3814–3823.
- [16] A.V. Porsin, A.V. Kulikov, V.N. Rogozhnikov, A.N. Serkova, A.N. Salanov, K.I. Shefer, *Catal. Today* 273 (2016) 213–220.
- [17] V. Novák, P. Kočí, T. Gregor, J. Choi, F. Štěpánek, M. Marek, *Catal. Today* 216 (2013) 142–149.
- [18] J. Li, Y. He, L. Tan, P. Zhang, X. Peng, A. Oruganti, G. Yang, H. Abe, Y. Wang, N. Tsubaki, *Nat.*

Catal. 1 (2018) 787–793.

- [19] H. Yue, Y. Zhao, X. Ma, J. Gong, Chem. Soc. Rev. 41 (2012) 4218–4244.
- [20] S. Peng, Z. Xu, Q. Chen, Z. Wang, D. Lv, J. Sun, Y. Chen, G. Guo, ACS Catal. 5 (2015) 4410–4417.
- [21] X. Gao, Y. Zhao, S. Wang, Y. Yin, B. Wang, X. Ma, Chem. Eng. Sci. 66 (2011) 3513–3522.
- [22] S. Peng, Z. Xu, Q. Chen, Y. Chen, J. Sun, Z. Wang, M. Wang, G. Guo, Chem. Commun. 49 (2013) 5718–5720.
- [23] C. Wang, L. Han, P. Chen, G. Zhao, Y. Liu, Y. Lu, J. Catal. 337 (2016) 145–156.
- [24] C. Wang, L. Han, Q. Zhang, Y. Li, G. Zhao, Y. Liu, Y. Lu, Green Chem. 17 (2015) 3762–3765.
- [25] C. Wang, W. Xu, Z. Qin, S. Mintova, Catal. Commun. 119 (2019) 39–41.
- [26] M. Zhang, B. Xu, G. Ling, Appl. Surf. Sci. 331 (2015) 1–7.
- [27] V. Maurice, G. Despert, S. Zanna, M.P. Bacos, P. Marcus, Nat. Mater. 3 (2004) 687–691.
- [28] C. Kaplin, R. Ivanov, M. Paliwal, I. Jung, M. Brochu, Intermetallics 54 (2014) 209–217.
- [29] K.R. Nemade, S.A. Waghuley, Ceram. Int. 40 (2014) 6109–6113.
- [30] K. Laishram, R. Mann, N. Malhan, Ceram. Int. 38 (2012) 1703–1706.
- [31] A.K.N. Kumar, S. Prasanna, B. Subramanian, S. Jayakumar, G.M. Rao, J. Appl. Phys. 117 (2015) 125307–125317.
- [32] J.A. Rotole, P.M.A. Sherwood, Surf. Sci. Spectra 5 (1998) 4–10.
- [33] J.A. Rotole, P.M.A. Sherwood, Surf. Sci. Spectra 5 (1998) 53–59.
- [34] J. Sung Lee, H. Soo Kim, J. Su Lee, N. Park, T. Jin Lee, M. Kang, Ceram. Int. 38 (2012) 6685–6691.
- [35] J.T. Klopogge, L.V. Duong, B.J. Wood, R.L. Frost, J. Colloid Interface Sci. 296 (2006) 572–576.

- [36] Z. Shi, W. Jiao, L. Chen, P. Wu, Y. Wang, M. He, *Microporous Mesoporous Mater.* 224 (2016) 253–261.
- [37] X. Zhou, J. Ji, D. Wang, X. Duan, G. Qian, D. Chen, X. Zhou, *Chem. Commun.* 51 (2015) 8853–8856.
- [38] G. Busca, *Catal. Today* 226 (2014) 2–13.
- [39] P. Chang, F. Yen, K. Cheng, H. Wen, *Nano Lett.* 1 (2001) 253–261.
- [40] M.I.F. Macêdo, C.A. Bertran, C.C. Osawa, *J. Mater. Sci.* 42 (2007) 2830–2836.
- [41] H.J. Grabke, *Intermetallics* 7 (1999) 1153–1158.
- [42] Z. Li, W. Wang, D. Yin, J. Lv, X. Ma, *Front. Chem. Sci. Eng.* 6 (2012) 410–414.
- [43] C. Wang, P. Chen, Y. Li, G. Zhao, Y. Liu, Y. Lu, *J. Catal.* 344 (2016) 173–183.
- [44] M. Sheng, H. Yang, D.R. Cahela, B.J. Tatarchuk, *J. Catal.* 281 (2011) 254–262.
- [45] Y. Li, Q. Zhang, R. Chai, G. Zhao, Y. Liu, Y. Lu, F. Cao, *AIChE J.* 61 (2015) 4323–4331.