



**HAL**  
open science

## **ERSAT GGC. ERTMS on SATELLITE Galileo Game Changer**

Omar Garcia Crespillo, Daniel Gerbeth, Fabio Pognante, Salvatore Sabina, Susana Herranz, Ricardo Campo, Alessia Vennarini, Andrea Coluccia, Antonio Aguila, Antoine Barre, et al.

► **To cite this version:**

Omar Garcia Crespillo, Daniel Gerbeth, Fabio Pognante, Salvatore Sabina, Susana Herranz, et al.. ERSAT GGC. ERTMS on SATELLITE Galileo Game Changer. [Research Report] IFSTTAR - Institut Français des Sciences et Technologies des Transports, de l'Aménagement et des Réseaux. 2019, 81p. hal-02404569

**HAL Id: hal-02404569**

**<https://hal.science/hal-02404569v1>**

Submitted on 11 Dec 2019

**HAL** is a multi-disciplinary open access archive for the deposit and dissemination of scientific research documents, whether they are published or not. The documents may come from teaching and research institutions in France or abroad, or from public or private research centers.

L'archive ouverte pluridisciplinaire **HAL**, est destinée au dépôt et à la diffusion de documents scientifiques de niveau recherche, publiés ou non, émanant des établissements d'enseignement et de recherche français ou étrangers, des laboratoires publics ou privés.

# ERTMS on SATELLITE Galileo Game Changer

## D4.5 Process Execution Report

Due date of deliverable: 30/11/2019

Actual submission date: 29/11/2019

Leader/Responsible of this Deliverable: DLR

Reviewed: Y/N

Document status		
Revision	Date	Description
V1	29.11.2019	First version release
V2	03.12.2019	Second version release including modifications after the remarks provided by the reviewer

Project funded from the European Union's Horizon 2020 research and innovation programme		
Dissemination Level		
<b>PU</b>	Public	X
<b>CO</b>	Confidential, restricted under conditions set out in Model Grant Agreement	
<b>CI</b>	Classified, information as referred to in Commission Decision 2001/844/EC	

Start date of project: 01/12/2017

Duration: 24 months



## REPORT CONTRIBUTORS

Name	Company	Details of Contribution
Omar Garcia Crespillo	DLR	Author
Daniel Gerbeth	DLR	Author
Fabio Pognante	Hitachi Rail STS	Author
Salvatore Sabina	Hitachi Rail STS	Author
Susana Herranz	CEDEX	Author
Ricardo Campo	CEDEX	Author
Alessia Vennarini	Radiolabs	Author
Andrea Coluccia	Radiolabs	Author
Antonio Aguila	INECO	Author
Antoine Barre	SNCF	Author
Ramiro Valdés	ADIF	Author
Joaquín Peinado	ADIF	Author
Yann Cocheril	Ifsttar	Author
Cyril Meurie	Ifsttar	Author
Amaury Flancquart	Ifsttar	Author
Juliette Marais	Ifsttar	Author

## DOCUMENT APPROVAL

Document Code	Rev.	Approved	Authorised	Date
ERSAT- GGC_D4.5_Process_Execution_Report	V1	TMT	Massimiliano Ciaffi	2019/11/29
ERSAT- GGC_D4.5_Process_Execution_Report	V2	-	Massimiliano Ciaffi	2019/11/03



## EXECUTIVE SUMMARY

---

This is the deliverable “D4.5 Process Execution Report” of the ERSAT GGC project. This document reports the execution of the track area classification process developed during the work package “WP4 Track Survey and Track Classification” along with the main outcomes and results obtained during this process.

The goal of WP4 is to set up a standard measurement and classification system that is able to provide a prediction of the expected presence of GNSS hazard causes and degraded performance to be expected at a given track area, in order to enable the evaluation if the specific environment is suitable or not to place virtual balises or on the contrary should be discarded beforehand.

In this document, we detail the results of applying the classification standard process, by means of the developed software Toolset to the measurement data collected in the three measurements campaigns during ERSAT GGC project. This execution report addressed the main important aspects that need to be carried out for the correct application of the classification process and the results obtained with the data collected.



## TABLE OF CONTENTS

<b><u>ERTMS ON SATELLITE GALILEO GAME CHANGER .....</u></b>	<b><u>1</u></b>
<b><u>REPORT CONTRIBUTORS .....</u></b>	<b><u>2</u></b>
<b><u>DOCUMENT APPROVAL.....</u></b>	<b><u>2</u></b>
<b><u>EXECUTIVE SUMMARY.....</u></b>	<b><u>3</u></b>
<b><u>TABLE OF CONTENTS.....</u></b>	<b><u>4</u></b>
<b><u>LIST OF FIGURES.....</u></b>	<b><u>6</u></b>
<b><u>LIST OF TABLES .....</u></b>	<b><u>8</u></b>
<b><u>DEFINITION AND ABBREVIATIONS.....</u></b>	<b><u>9</u></b>
<b><u>1. INTRODUCTION.....</u></b>	<b><u>10</u></b>
<b><u>2. CLASSIFICATION PROCESS .....</u></b>	<b><u>11</u></b>
<b><u>2.1 HIGH LEVEL REQUIREMENTS.....</u></b>	<b><u>12</u></b>
<b><u>2.2 CLASSIFICATION PROCESS OVERVIEW.....</u></b>	<b><u>13</u></b>
<b><u>2.2.1 PREPARATION PHASE.....</u></b>	<b><u>13</u></b>
<b><u>2.2.2 DATA COLLECTION AND ACQUISITION PHASE.....</u></b>	<b><u>14</u></b>
<b><u>2.2.3 TOOLSET PROCESSING PHASE .....</u></b>	<b><u>15</u></b>
<b><u>2.2.4 EVALUATION AND MONITORING PHASE.....</u></b>	<b><u>16</u></b>
<b><u>3. TOOLSET SOFTWARE.....</u></b>	<b><u>17</u></b>
<b><u>3.1 TOOLSET STRUCTURE.....</u></b>	<b><u>17</u></b>
<b><u>3.1.1 MAIN TOOLSET PROCESS .....</u></b>	<b><u>17</u></b>
<b><u>3.1.2 DATA STORAGE .....</u></b>	<b><u>19</u></b>
<b><u>3.1.3 GRAPHICAL USER INTERFACE (GUI).....</u></b>	<b><u>20</u></b>
<b><u>3.2 OPERATION OF THE TOOLSET .....</u></b>	<b><u>21</u></b>
<b><u>4. MEASUREMENT CAMPAIGNS .....</u></b>	<b><u>24</u></b>
<b><u>4.1 MEASUREMENT CAMPAIGN IN ITALIAN LINE .....</u></b>	<b><u>24</u></b>
<b><u>4.2 MEASUREMENT CAMPAIGN IN SPANISH LINE .....</u></b>	<b><u>30</u></b>
<b><u>4.2.1 GNSS MEASUREMENT SYSTEM .....</u></b>	<b><u>34</u></b>
<b><u>4.2.2 IFSTTAR CAMERA SYSTEM .....</u></b>	<b><u>35</u></b>
<b><u>4.3 MEASUREMENT CAMPAIGN IN FRENCH LINE.....</u></b>	<b><u>36</u></b>
<b><u>4.4 DESCRIPTION OF THE MEASUREMENT CAMPAIGNS.....</u></b>	<b><u>36</u></b>
<b><u>5. PROCESS EXECUTION IN ITALIAN LINE.....</u></b>	<b><u>39</u></b>
<b><u>5.1 CALIBRATION MEASUREMENT AND PROCESS.....</u></b>	<b><u>39</u></b>
<b><u>5.2 CONFIGURATION OF THE TOOLSET .....</u></b>	<b><u>43</u></b>
<b><u>5.3 PRE-PROCESSING .....</u></b>	<b><u>47</u></b>
<b><u>5.4 DETECTION &amp; SIMULATIONS PROCESS.....</u></b>	<b><u>48</u></b>
<b><u>5.5 CLASSIFICATION PROCESS.....</u></b>	<b><u>49</u></b>
<b><u>5.6 EVALUATION OF RESULTS .....</u></b>	<b><u>52</u></b>
<b><u>6. PROCESS EXECUTION IN SPANISH LINE.....</u></b>	<b><u>59</u></b>
<b><u>6.1 CALIBRATION MEASUREMENT AND PROCESS.....</u></b>	<b><u>59</u></b>
<b><u>6.2 CONFIGURATION OF THE TOOLSET .....</u></b>	<b><u>61</u></b>
<b><u>6.3 PRE-PROCESSING .....</u></b>	<b><u>64</u></b>
<b><u>6.4 DETECTION &amp; SIMULATIONS PROCESS.....</u></b>	<b><u>65</u></b>



<b>6.5 CLASSIFICATION PROCESS.....</b>	<b>67</b>
<b>6.6 EVALUATION OF RESULTS.....</b>	<b>67</b>
<b>7. SUMMARY OF PROCESS EXECUTION.....</b>	<b>78</b>
<b>8. CONCLUSIONS.....</b>	<b>79</b>
<b>9. REFERENCES.....</b>	<b>81</b>



## LIST OF FIGURES

Figure 1: Example of track classification.....	11
Figure 2: Classification process.....	13
Figure 3: Toolset processing: A hazard driven process, Hazard causes assessment and general classification.....	15
Figure 4: Track domain mapping.....	16
Figure 5 Toolset Software Structure.....	17
Figure 6 Classification Processing.....	19
Figure 7 Toolset Processing Tab.....	20
Figure 8 Toolset Calibration Tab.....	20
Figure 9 Toolset Evaluation Tab.....	20
Figure 10: Operation of the Toolset – Step-by-Step example.....	21
Figure 11 Diesel railcar ALn668 – 3136.....	25
Figure 12 Train runs schedule in the Italian measurement campaign.....	26
Figure 13 Run table.....	26
Figure 14 reference track maps files.....	27
Figure 15 Measurement sub-system configuration.....	28
Figure 16 Measurement sub-system installation.....	29
Figure 17 Spanish line Almorchón-Alhondiguilla.....	30
Figure 18 BT train configuration.....	31
Figure 19 General scheme of equipment installation.....	32
Figure 20 View of installation on train roof of GNSS antenna and fish-eye camera.....	33
Figure 21 Lab-2 car with ADIF, INECO and CEDEX instrumentation.....	33
Figure 22 Driver’s desk.....	33
Figure 23 GNSS antenna.....	34
Figure 24 Javad Receiver.....	34
Figure 25 Final installation of GNSS antenna.....	34
Figure 26 Fish-eye camera on train roof and processing equipment.....	35
Figure 27 French line.....	37
Figure 28 SNCF Test Train.....	38
Figure 29 Selected area for the static measurements.....	39
Figure 30 Calibration input directory for AGC and PSD.....	40
Figure 31 Calibration processing for Interference AGC.....	40
Figure 32 Calibration processing for Interference PSD.....	41
Figure 33 Calibration processing for Multipath CMCD.....	41
Figure 34 Calibration processing for Multipath CN0.....	42
Figure 35 Calibration processing for Multipath/ NLOS Residuals.....	42
Figure 36 Toolset data directory selection.....	43
Figure 37 Create a campaign directory.....	43
Figure 38 Selection of the active campaign.....	44
Figure 39 Raw measurements in the GNSS directory.....	44
Figure 40 Run Table directory.....	45



Figure 41 Track maps files .....	45
Figure 42 Selection of the receiver .....	46
Figure 43 Launching the pre-processing phase .....	47
Figure 44 Launching threat detection process .....	48
Figure 45 Intermediate results .....	49
Figure 46 Classification processing chain.....	49
Figure 47 Single and multiple runs processing .....	51
Figure 48 Classification results.....	51
Figure 49 Single runs comparison for Septentrio data .....	52
Figure 50 Group of Northbound vs. Group of Southbound Runs for Septentrio data .....	53
Figure 51 Global classification on northbound and southbound tracks .....	53
Figure 52 Single runs comparison for Javad data.....	54
Figure 53 Group of Northbound vs. Group of Southbound Runs for Javad data .....	55
Figure 54 Comparative analysis among receivers for EMI.....	56
Figure 55 Comparative analysis among receivers for Multipath.....	57
Figure 56 Results without (left) / with (right) protection distance smoothing (20 meter).....	58
Figure 57 Train stationed on track 3 at Almorchón station and view of the train on the line .....	59
Figure 58 Calibration measurements site in the Spanish Campaign .....	60
Figure 59 Example of Run Table file.....	62
Figure 60 Track Layout.....	63
Figure 61 Node table file sample .....	63
Figure 62 Track Table file sample .....	63
Figure 63 Reference Position file sample .....	63
Figure 64 Track map representation and Track IDs.....	64
Figure 65 Pre-processing of calibration data and calibration execution for each technique .....	65
Figure 66 Pre-processing of dynamic tests data .....	65
Figure 67 Detection process.....	66
Figure 68 Classification process.....	67
Figure 69 Evaluation process .....	67
Figure 70 Example of Evaluation tab result in Toolset GUI.....	68
Figure 71 Example of results for single run.....	69
Figure 72 Example of results for five runs.....	70
Figure 73 Example of results for all the runs.....	70
Figure 74 Example of evaluation for each detection method .....	71
Figure 75 Example of evaluation for Metallic bridge .....	72
Figure 76 Example of evaluation for Road overpass .....	73
Figure 77 Example of evaluation for Tree canopy area.....	74
Figure 78 Summary of different areas classification .....	75
Figure 79 Results without (left) / with (right) protection distance smoothing (20 meter).....	76





---

## LIST OF TABLES

Table 1 Overall Classification Results after combination of different hazard causes.....	58
Table 2 Final Classification Results after 20m distance smoothing.....	58
Table 3 Schedule train runs in Spanish line.....	60
Table 4 Overall Spanish Classification Results after combination of different hazard causes .....	77
Table 5 Final Spanish Classification Results after 20m distance smoothing.....	77

---



## DEFINITION AND ABBREVIATIONS

---

COTS	Component-Off-The-Shelf
ERSAT GGC	ERTMS on Satellite Galileo Game Changer
ERTMS	European Rail Traffic Management System
GNSS	Global Navigation Satellite System
GPS	Global Position System
KML	Keyhole Markup Language
LDS	Local Determination System
LRS	Local Reference Station
MA	Movement Authority
MIS	Messa in Servizio
MOPS	Minimum Operational Performance Standards
OBU	On Board Unit
PC	Personal Computer
RBC	Radio Block Center
RTK	Real Time Kinematic
SDH	Synchronous Digital Hierarchy
SSB	On-board Subsystem
SSC	Sistema Supporto alla Condotta
SST	Trackside Subsystem
TLC	Telecommunication
VBTS	Virtual Balise Transmission System



## 1. INTRODUCTION

---

The main goal of WP4 of ERSAT GGC project is the definition of a track area classification process with respect to the presence of local GNSS hazard causes along the railway lines to be potentially equipped with Virtual Balises. The classification process requires the collection of measurement data with COTS hardware equipment as well as the processing of this data with a dedicated software toolset. The classification process was first defined in the deliverable D4.1 [1] and further in D4.2 [2]. The development and implementation of the software toolset is presented in D4.3 [3]. A summary of the outcome of this deliverables is provided in the first sections of this document in order to support the understanding of the rest of the document.

In order to verify the classification process with respect to the proposed measurement hardware and the related experimental setup for the data collection process and to support the validation and analysis of the data with the software toolset, within the context of ERSAT GGC, three measurement campaigns have been carried out in three different countries: Spain, Italy and France.

The relevant information about the data collection process in these three campaigns was provided in D4.4 [4]. This includes the procurement and installation of the measurement equipment on the train, the specific measurement equipment setup and operation for the different campaigns as well as the scheduling of the train runs in the selected lines. A summary of the campaigns important aspects is also provided in this document related to each of the countries.

In this document, we detail the results of applying the classification process, by means of the developed software Toolset to the measurement data collected in the two identified lines where the process execution was planned, i.e. Italian and Spanish Lines. This execution report addresses the main important aspects that need to be carried out for the correct application of the classification process and the results obtained with the data collected in Spain and Italy.



## 2. CLASSIFICATION PROCESS

In order to instantiate the Enhanced Functional ERTMS Architecture Capable of using GNSS and Public Radio telecommunication Technologies described in ERSAT GGC deliverable D2.1 [5], the railway line shall be designed in order to locate the virtual balises in areas where the GNSS local phenomena would always lead to bound VB position errors, in accordance the accepted residual integrity risks. The aim of the WP4 is to set up a standard measurement and classification process able to provide to the railway trackside designer and the railway operator an indication on the track areas where virtual balises can be potentially located to mitigate the potential risk that the VBR Error Model might not bound the VB detection error.

In order to bound a-priori the risk that the presence of local hazards might lead to unbounded VB location errors at the virtual balise level, the following approach is followed during the process:

- The expected presence of the different hazards along the line is studied by means of a generic classification process, where generic means independently of a specific implementation of a VBR
- The track areas are classified according to their suitability for placing virtual balises
- The classification results are made available to the signalling trackside engineers that have to take the results of the classification into account during the signalling trackside subsystem design phase

Note that the assumptions and models of the classification process are exported to any virtual balise reader to guarantee the coherence of the results of the classification process with the FDE capability and GNSS Positioning algorithms implemented in a VBR. An example of the expected results of the track area classification process is depicted in Figure 1.

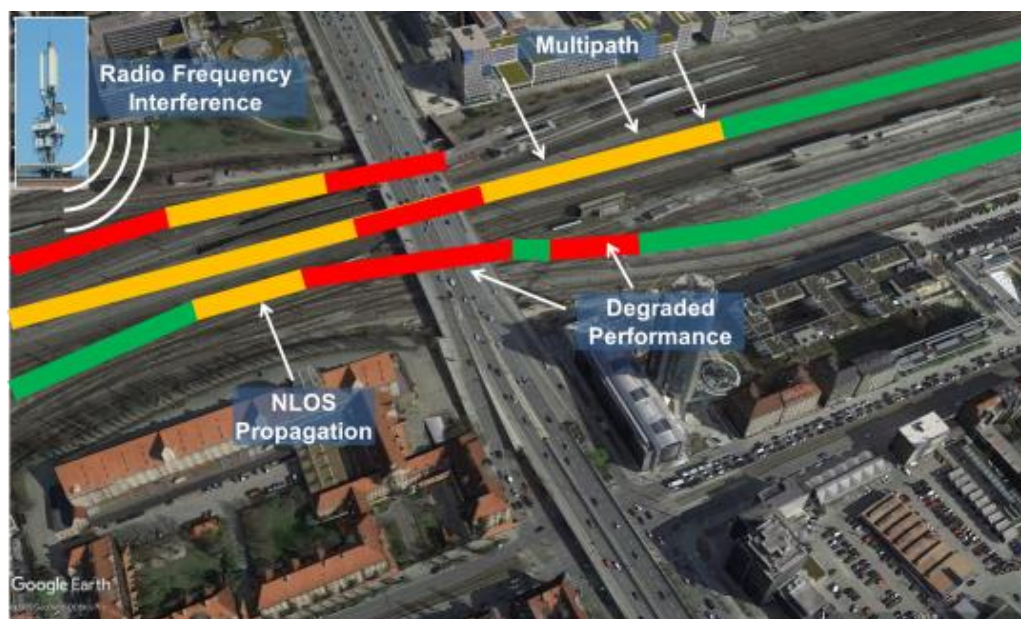

Figure 1: Example of track classification



## 2.1 HIGH LEVEL REQUIREMENTS

The classification process has been designed and developed with the expectation to become a standard and cost-effective process:

- The process instantiation shall foresee a modular and scalable measurement environment, and allow to use different and interchangeable hardware and detection methods
- The process instantiation shall be based on the use of COTS measurement components
- The process will only address the local hazard causes due to the permanent properties of the track area that could potentially lead to hazardous consequences and shall be compatible with any Virtual Balise Transmission System (VBTS)
- Since there is currently no Minimum Operational Performance Standards (MOPS) reference document for the railway GNSS applications, the process shall be configurable through run time parameters, which shall be exported to the virtual balise reader

The process shall classify each track area of the line based on virtual balise placement suitability status in terms of three colours:

- Green, meaning that the area is suitable for the virtual balise placement
- Red, meaning that the area is not suitable for the virtual balise placement
- Yellow, meaning that there is not enough information to classify the area as Green or Red, and the area shall not be used for placing virtual balises. However, if necessary, further measurements and analysis would be performed in order to obtain a classification of this specific area as Green or Red.

The process shall evaluate the potential local hazard causes, such as Multipath, Non-Line-Of-Sight, and Interference, and shall give an indication of the hazard cause leading to the classification of an area as not suitable.

The classification process shall guarantee the coverage of the track areas in terms of spatial and temporal dynamics, and take into consideration the augmentation information to discard unhealthy satellites so as to avoid wrong and pessimistic classification results. The process shall allow the use of different detection techniques applied offline to the data acquired on the field during the campaign, and the inclusion of the results from simulation methods based on external data, when available, such as 3D models of the environment.

The process shall be based on an incremental collection of data from multiple train runs, and allow a comparative analysis of different sub-sets of data and enable the subsequent monitoring of the surveyed line, to deal with potential modifications of the environment that would lead to a different classification of some areas.

## 2.2 CLASSIFICATION PROCESS OVERVIEW

The Track Survey and Track Classification is a comprehensive process which includes several phases, starting from the preparation of the track survey and leading to the evaluation of the results and, after the trackside commissioning phase, monitoring the validity of the classification results along the line during the time or periodically. A diagram with the overview of the different steps of the classification process is presented in Figure 2.

The Monitoring Process of the results of the Classification Process after the trackside-commissioning phase is out of the scope of the ERSAT-GGC project. D4.1 [1] provides high level requirements only of this process phase.

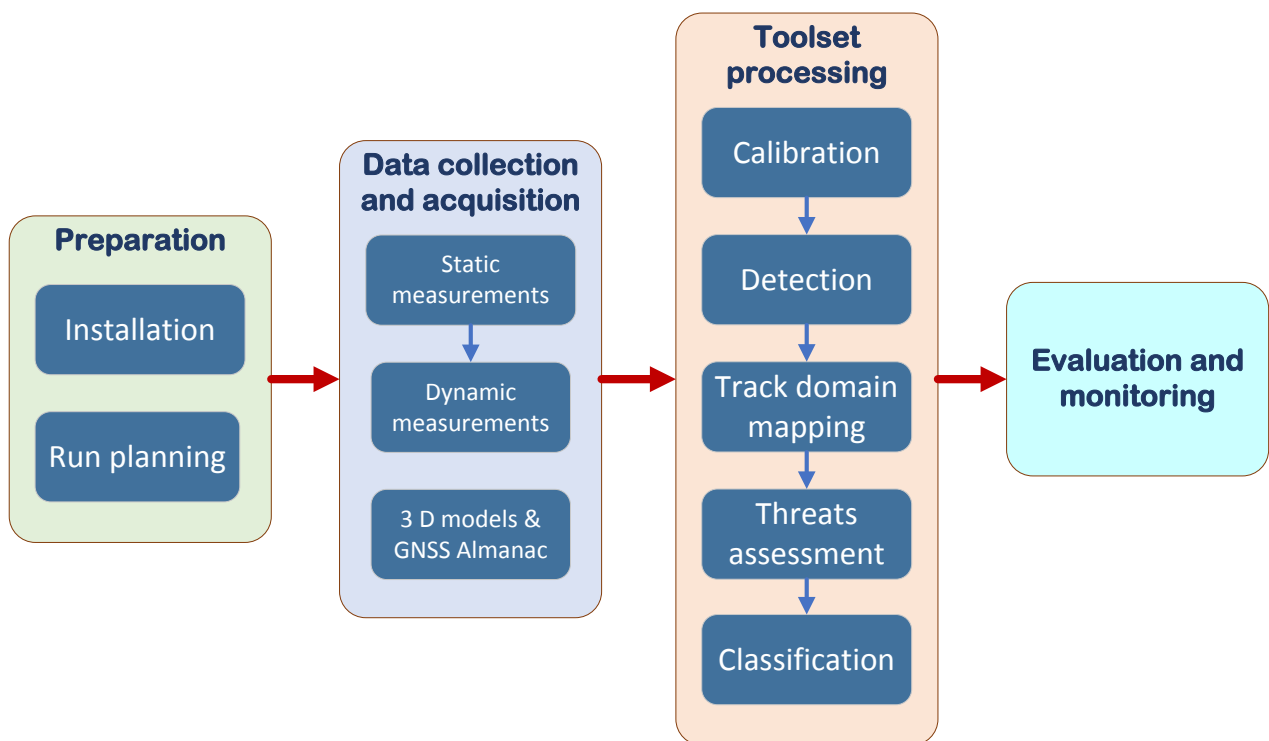

*Figure 2: Classification process*

### 2.2.1 PREPARATION PHASE

The preparation phase includes the activities needed to equip the train being used for performing the measurement campaign, prepare the measurement equipment and to plan the measurement campaign. The train can be a train dedicated to the execution of diagnostic activities or a commercial train where temporally the measurement equipment has to be installed. For example, a commercial train has been used for the application of the Classification Process to the Italian Lines and a dedicated Diagnostic Train for the Spanish and French Lines.



The activities of the preparation phase are:

- The **installation** consists in the identification / procurement of the measurement equipment compliant with the requirements / recommendations described in the Classification process specification, the design of the layout of the equipment on-board of the train, the fulfilment of the necessary authorization process and the installation of the measurement equipment on the train
- The **run planning** involves the evaluation of the schedule of the train runs and of the measurements in order to obtain the desired spatial and temporal coverage and the attainment of the authorizations from the operator and infrastructure manager to perform the runs. In order to reduce the cost of dedicated runs only for the purpose of the track area classification, the process can be combined with other surveying activities carried out by infrastructure managers.

## **2.2.2 DATA COLLECTION AND ACQUISITION PHASE**

The data collection and acquisition phase includes the field measurement campaign, the collection of the raw data from the measurement equipment on-board of the train and the acquisition of any additional data necessary to perform the degraded performance simulation based on 3D models:

- The **static measurements** consist in the collection of measurement data with the measurement on-board equipment while the train is standstill and stored in a location with nominal GNSS conditions (i.e. stored in a location with a good open sky visibility and no permanent sources of local phenomena), which will be used to determine the nominal error models or to derive the relevant detection thresholds. These thresholds are considered as calibration parameter values of the detection techniques.
- The **dynamic measurements** involve the collection of measurement data while the train is performing the runs as defined in the run planning phase, in order to gather the raw data necessary to cover the spatial and temporal dynamics of the GNSS signal behaviour along the line. The collected data will then be processed offline with the Software Toolset. During this process, relevant information about the times of the measurement runs and all the lines covered must be stored. Later on, this information is required to generate run tables that are required by the Toolset to identify relevant measurement data intervals and associate the subsequent detection results to the correct tracks.
- The **3D models & Other GNSS Navigation data:** GNSS navigation data includes the augmentation data information and the constellations almanac. On the other hand, when the optional use of the toolset simulator is foreseen for extending the classification also to the degraded performance analysis due to the morphology of the environment, data acquisition consists in the gathering of 3D terrain models of the areas around the train line from the available public sources.

## 2.2.3 TOOLSET PROCESSING PHASE

The Toolset processing phase consists in the offline processing of the data collected during the previous phase, and involves the execution of the detection techniques on the acquired data and the subsequent track classification.

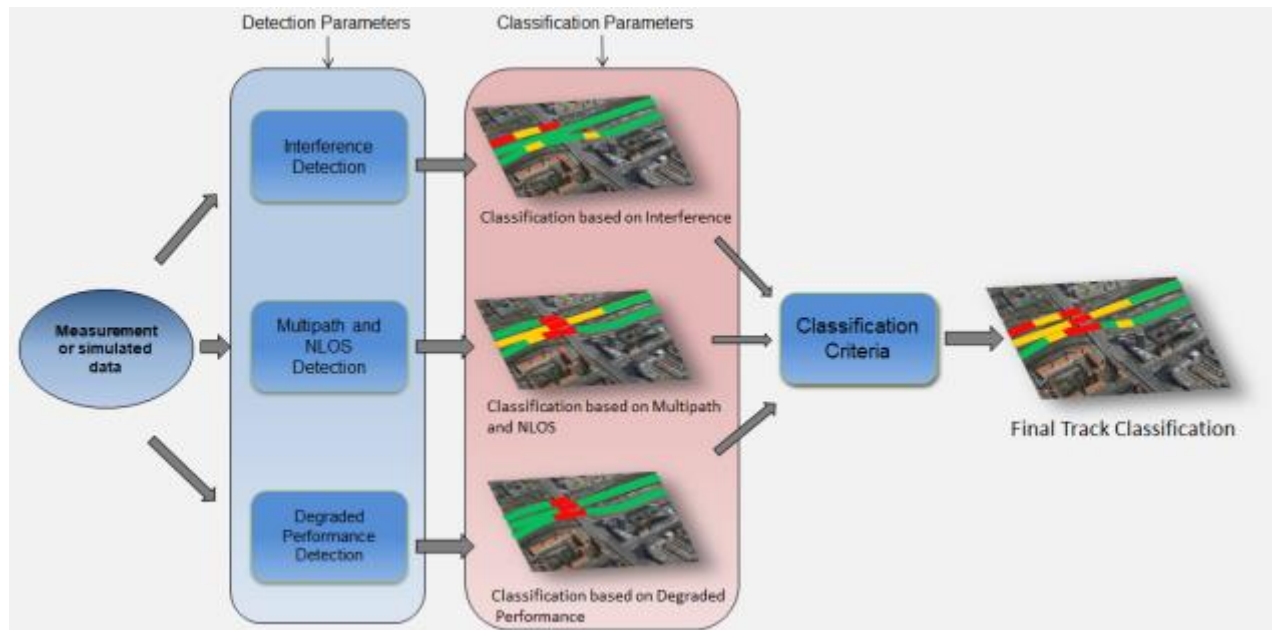

Figure 3: Toolset processing: A hazard driven process, Hazard causes assessment and general classification

- The **calibration** phase consists in the evaluation of the static measurement data in order to compute the calibration parameters for each detection technique, and allows to tailor the thresholds and the models used by the techniques to the specific train, antenna installation, cabling and measurement equipment configuration
- The **detection** phase consists in executing the detection techniques on the dynamic measurement data acquired during the train runs, and in performing the simulation of the GNSS constellations and their visibility accounting for the 3D terrain models of the line. It includes the analysis of the augmentation data in order to discard unhealthy satellites from the evaluation
- The **track domain mapping & multiple runs accumulation** consists in the translation of the detection techniques results from the time domain to the space domain, the projection of the detection results to the track domain (based on a given reference track database) and finally the accumulation of the results from multiple runs. A schematic of this process step is shown in Figure 4.





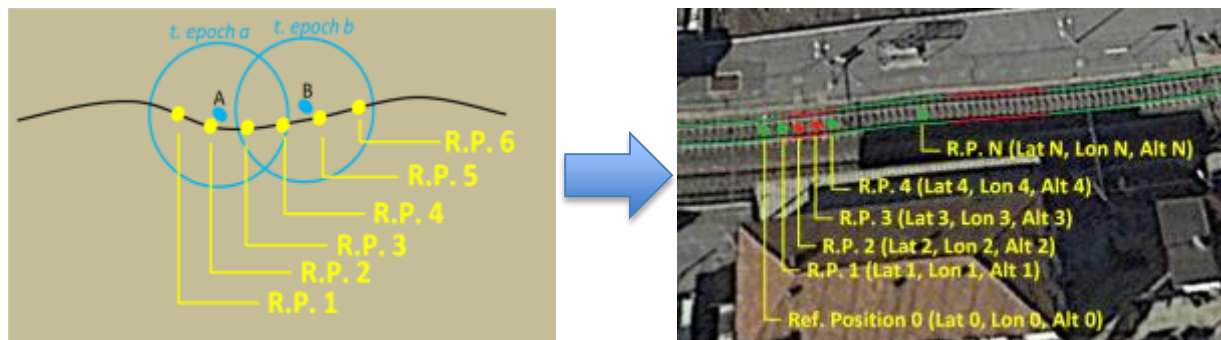

Figure 4: Track domain mapping

- The **Hazard causes assessment** consists in taking a decision about the presence of a certain local GNSS hazard cause in a certain point of the railway line. This decision is made by taking into account the information of different runs, and when applicable the different satellites detection results, to reach to a final classification per threat. This assessment builds upon statistical evaluations to provide a higher and higher confidence on the detected presence of hazard causes and to discard a pessimistic classification due to a non-permanent presence of threats. The level of confidence will increase with the size of the statistical sample.
- The **overall classification** consists in the logical combination of the presence of the different hazard causes along the line to reach to a final classification result. This process also introduces a space margin or confidence interval to the results in order to provide more coherent information in case of the possible intermittent presence of threats in a certain area.

## 2.2.4 EVALUATION AND MONITORING PHASE

The evaluation and monitoring phase consists of the evaluation of the final classification results, the judgement of the line from a rail signalling perspective, and the inclusion of the output data in the supporting material for the signalling trackside design phases also based on the use of virtual balises.

Once the trackside subsystem is commissioned, the validity in time of the classification would be monitored to detect degradation events with respect to the classification used for the last trackside commissioned. This monitoring phase is outside the scope of the ERSAT-GGC project.



### 3. TOOLSET SOFTWARE

#### 3.1 TOOLSET STRUCTURE

In Figure 5, a high level structural overview of the Toolset software developed within the project is presented.

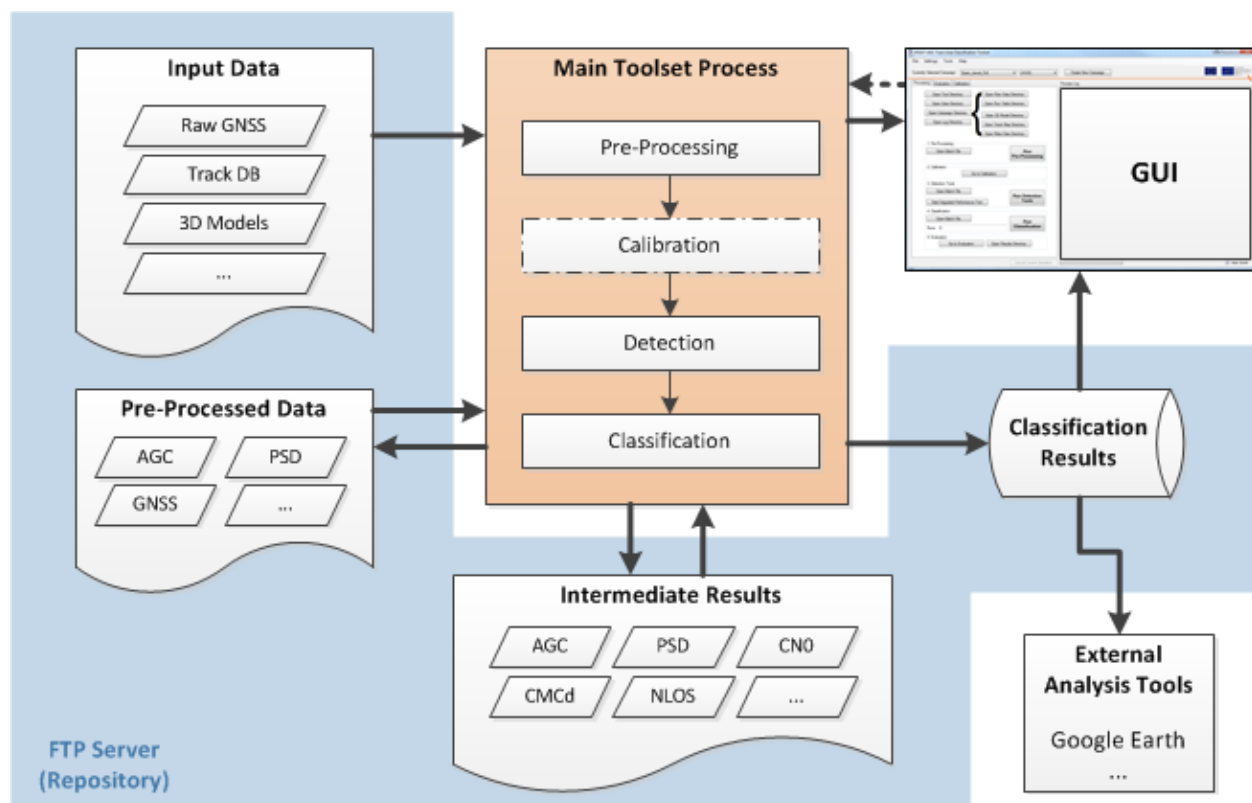

Figure 5 Toolset Software Structure

The three main components, namely a central processing chain, campaign data storage as well as a graphical user interface, are presented in the following.

#### 3.1.1 MAIN TOOLSET PROCESS

The main block of the software represented in Figure 5 is composed of the different processing algorithms developed according to the classification process. It consists of the following functionalities:

- **Pre-processing:**  
This step foresees the conversion of the raw measurement data, collected with the different measurement equipment specified by the classification process, into common input files with



specified formats. These fixed formats represent the input interfaces of all the different detection blocks. The pre-processing stage enables the use of different measurement hardware within the toolset because this phase acts as a front-end for the Toolset. As long as the measurement equipment can provide the required measurement information as requested by the classification process, the measured data can be converted to the defined input file formats making the native data format transparent to the further data analysis in the survey Toolset.

In addition to the conversion of raw data into specified input file formats, the generation of commonly used information like reference location and satellite azimuth and elevation is added in this step.

- **Calibration:**

Calibration has to be executed at least once per unique combination of antenna, installation, cabling and receiver. It is used for several detections techniques to account for the nominal noise and multipath levels of each installation in order to adjust the techniques to achieve the desired false alarm probabilities.
- **Detection:** It consists in the sequential processing of the different selected GNSS local threats detection techniques targeting the specific threats. In particular, the implemented detection techniques per threat are [6]:
  - **Interference:**
    - Automatic Gain Control (AGC): Detection based on changes in the AGC Levels given by the receiver.
    - Power Spectrum Density (PSD): Detection of the presence of interference by comparing the nominal and the current shape of the spectrum in the in-band and near band frequencies of GNSS signals.
  - **Multipath:**
    - Code-minus-Carrier Delta: based on the time difference of the code minus carrier observable.
    - Carrier to Noise (CNO): Detection based on multiple frequency information of the CNO provided by the receiver.
  - **NLOS:**
    - PVT Residual: Fault detection based on the least-squares position residual computation. This technique may detect also large multipath error.
    - Eye-fish Camera NLOS detection: based on the comparison between received satellites and visible satellites based on the information of the horizon provided by an eye-fish camera.
  - **Degraded Performance:** Detection based on the simulation of areas and the expected performance in terms of number of visible satellites and Dilution of Precision.
- **Classification:** The classification processing, as presented in Section 2.2.3, consists in the translation of the detection results into the track area domain, the combination of the information of different runs for the same point on the track and the final decision logic about each of the considered local hazard causes and the overall classification. The final classification results account for a space domain margin or confidence interval as a VBR



receiver may need some time to recover after the presence of corrupted or limited measurements. A graphical overview of the whole classification is depicted in Figure 6.

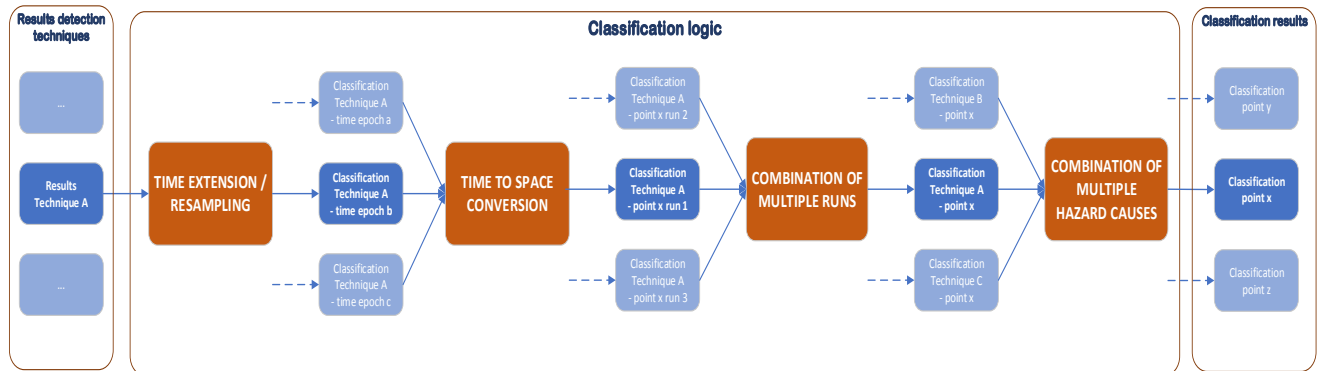

Figure 6 Classification Processing

### 3.1.2 DATA STORAGE

The second major part of the Toolset is the structured data repository that keeps all relevant measurements and information to perform the track area classification based on a measurement campaign. The storage of the different types of data that are input or are generated during the Toolset processing are stored in an FTP server repository to be easily accessed by each of the partners and/or users of the campaigns evaluation. Different type of information is generated during the processing, including:

- **Input Data:** Consist of the raw measurement data recorded during the measurement campaigns, the information about the track DB of the areas to be classified, 3D models data used for the proper simulation of the degraded performance and other information like augmentation GNSS data or almanac information.
- **Pre-processed Data:** The raw measurement data is converted into (partly standard) data formats utilized by the detections tools in the Toolset. This allows for the interfacing of different measurement devices running with different proprietary information. For example, raw GNSS data is converted into RINEX v3 format which enables many different GNSS receivers to be used to collect measurement data.
- **Intermediate Results:** This directory contains the results and flags provided by all the different detection techniques.
- **Classification Results:** In this directory, the Toolset stores the final classification results including .kml files for direct visualization as well as more detailed information on the presence of all the individual threats along the line. The GUI can be used to access this classification database and evaluate individual results.



### 3.1.3 GRAPHICAL USER INTERFACE (GUI)

The GUI is the primary connection between the user and the Toolset processing. The user is able to manage the different data from it as well as to launch the different steps of the processing. It contains three main tabs according to the main three functions the user needs to apply: Processing (Figure 7), Calibration (Figure 8) and Evaluation (Figure 9).

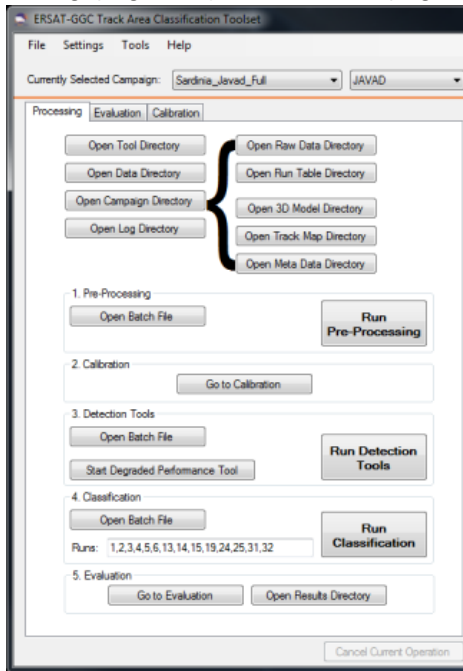

Figure 7 Toolset Processing Tab

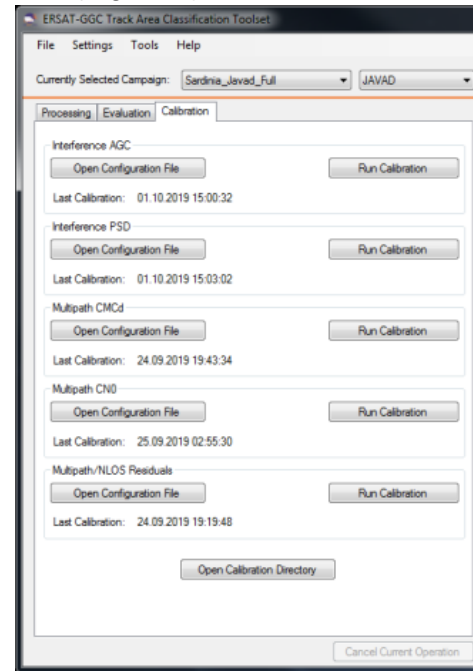

Figure 8 Toolset Calibration Tab

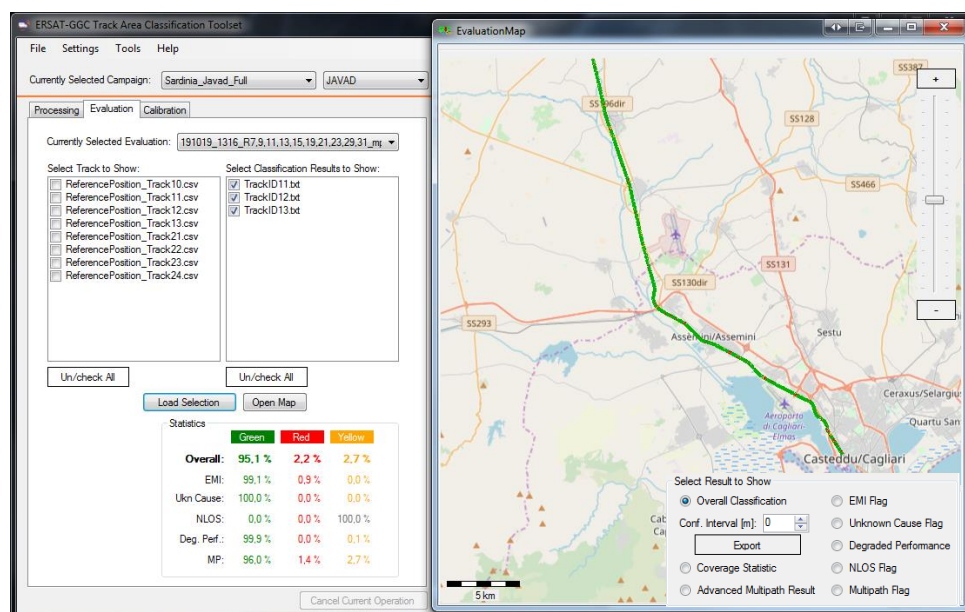

Figure 9 Toolset Evaluation Tab



## 3.2 OPERATION OF THE TOOLSET

The Toolset is structured with a modular approach, and during each phase of the operation detailed in Figure 10, a dedicated part of the GUI automatically launches the appropriate modules in sequence.

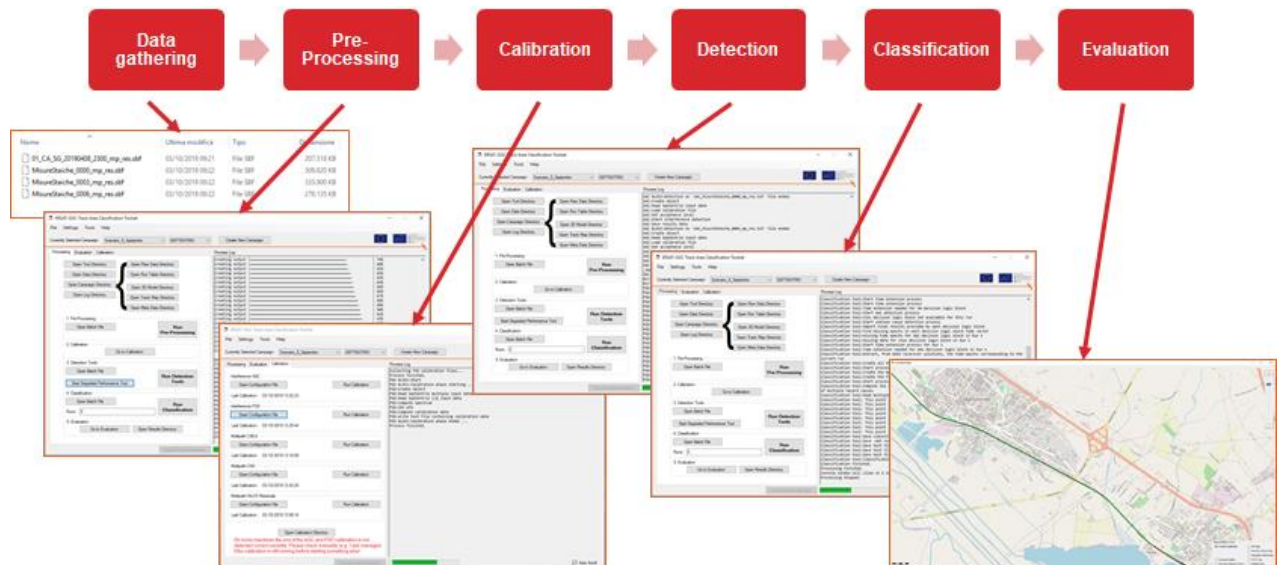

Figure 10: Operation of the Toolset – Step-by-Step example

The data is organized in structured folders for each campaign, with a sub-folder dedicated to each phase of the Toolset processing. The data from all the measurement campaigns is collected in a common repository, but the Toolset has to be run with a local copy of the campaign's data or direct access to a network drive containing the data.

Before the execution of the Toolset, the user has to setup the detection and classification parameters, depending on the results of the calibration phase.

### A. Data gathering

The first phase of the process consists in gathering the raw data from the receiver and, when the use of the Simulation is foreseen to predict degraded performance in the GNSS chain due to the trackside morphology, the 3D terrain models from the data providers. Once the relevant data is collected, the user has to create a new campaign in the Toolset and copy the data in the appropriate input folders of the Toolset. The input data also includes the track database, describing the structure of the line, and the run tables, describing the track sections covered by each run.



## **B. Pre-processing**

Once the data has been gathered and copied to the appropriate input folders, the pre-processing phase can be executed. This phase transforms the receiver-specific raw data in a common format, and allows the subsequent detection techniques to run seamlessly across the different receivers. The user has to launch the GUI and select the receiver that was used during the campaign from the list of the supported ones, then start the processing phase, which will elaborate in sequence on all the input files.

## **C. Calibration**

Once the input data has been pre-processed, the calibration phase can be run. A configuration file allows the user to select which input data has to be used for the calibration of each detection technique by specifying the start and end date/time of the static data acquisition. The calibration can be launched separately for each detection technique and can be fine-tuned by selecting the specific time frame that is representative for the definition of the nominal conditions. Since the calibration phase defines the thresholds and the parameters used for that specific technique, if additional calibration data is acquired, the process has to be run again and will overwrite the previous calibration data. Conversely, if the calibration parameters calculated previously are still valid (e.g. the same train and equipment is used to perform additional runs), it is not necessary to perform a new calibration.

## **D. Detection**

The detection phase consists in the execution of the detection techniques. Once launched from the correspondent command in the GUI, the process automatically executes in sequence the detection techniques on each pre-processed file, obtaining the results of the classification for each technique and each hazard cause for each time epoch.

## **E. Classification**

The classification phase consists in the combination of the classification results for each detection technique for each time epoch and their mapping in the track domain. This phase can be executed for the whole campaign or for a subset of train runs, and generates the final classification results along the line both combined and for specific hazard cause. The final results are provided in different formats, including a Matlab matrix file and KML files, which can be loaded by 3<sup>rd</sup> party tools (e.g. Google Earth).

## **F. Evaluation**

The evaluation phase consists in the assessment of the classification results and in the evaluation of the impact of each hazard cause along the line. The Toolset allows the selection of any subset of train runs that were classified, and inside it the selection of the track sections to be



evaluated. The results are then displayed both as statistics for each hazard cause, and as a graphical representation of the line on a map by means of Green, Red, and Yellow areas. It is possible to visualize graphically the classification for each hazard cause, and the user can select the extension of the smoothing window applied.

The results can be also evaluated through external tools by using the KML files, or integrated in an ERTMS design toolset by means of the txt files containing the classification flags.





## 4. MEASUREMENT CAMPAIGNS

---

During the WP4 of ERSAT GGC project, the first phase of the classification process corresponding to the measurement campaign has been carried out in different lines. The detail information about each of the campaigns can be found in [4]. In the following we provide also the relevant information about each of them.

### 4.1 MEASUREMENT CAMPAIGN IN ITALIAN LINE

---

This section describes how the track area classification process has been applied along an Italian line according to the technical specifications and Toolsets defined in ERSAT-GGC project.

The first part of the process foresees a preparation phase. In this phase the following steps have been carried out in the Italian measurement campaign:

- Selection of the measurement equipment in accordance the requirements / recommendations given in the process definition.
- Approval procedure for the installation of the measurement equipment. Based on the safety-related analysis edited by Hitachi STS, the non-intrusiveness of the novel on-board architecture has been evaluated and assessed in order to guarantee the safety of the planned in-field test. The authorization letters have been sent by the technical department of TRENITALIA and RFI.
- Measurement campaign schedule selection. A schedule in terms of number of train runs to be carried in the selected line has been sent and approved by TRENITALIA and RFI.
- Installation of the measurement sub-system.

The second part of the process foresees the measurement and data acquisition on a selected line. In the Italian measurement campaign, the Cagliari - San Gavino line (part of the Cagliari-Sassari line) has been selected as the reference site. It mostly presents open sky conditions and the total distance from Cagliari to San Gavino is 50 km.

Data collection has been performed on the diesel railcar ALn668–3136, considering two different train moving dynamics:

- Static measurement (train in standstill condition) to acquire calibration data
- Dynamic measurement (train moving from the departure station to the arrival station) to acquire the input data required for the classification process.



Figure 11 Diesel railcar ALn668 – 3136

In the Italian measurement campaign, thirty-two runs have been performed on Cagliari – San Gavino section as summarized in Figure 12. The train runs have been scheduled in different time of the day (morning, afternoon, night) to cover the reception of signals from various elevation angles and to detect the “permanent” aspect of the presence of local hazard causes. The number of train runs has been chosen to classify a higher number of points over the track in order to cover the entire line spatially.

Monday		Standstill train		
08/04/2019	<b>CAGLIARI</b>	standstill train		
	09:00 → 17:00	8h		
Monday		Extra runs during the night		
08/04/2019	<b>CAGLIARI → S.GAVINO (START → STOP)</b>	standstill train time in the station before next departure	<b>S.GAVINO → CAGLIARI (START → STOP)</b>	standstill train time in the station before next departure
	23:00 → 23:30	15min	23:45 → 00:16	15min
	00:31 → 01:01	15min	01:16 → 01:47	15min
	02:02 → 02:32	15min	02:47 → 03:18	-
Tuesday		Extra runs during the night		
09/04/2019	<b>CAGLIARI → S.GAVINO (START → STOP)</b>	standstill train time in the station before next departure	<b>S.GAVINO → CAGLIARI (START → STOP)</b>	standstill train time in the station before next departure
	23:00 → 23:30	15min	23:45 → 00:16	15min
	00:31 → 01:01	15min	01:16 → 01:47	15min
	02:02 → 02:32	15min	02:47 → 03:18	-
Wednesday		Extra runs during the day (afternoon)		
10/04/2019	<b>CAGLIARI → S.GAVINO (START → STOP)</b>	standstill train time in the station before next departure	<b>S.GAVINO → CAGLIARI (START → STOP)</b>	standstill train time in the station before next departure
	17:10 → 17:40	19min	17:59 → 18:30	40min
	19:10 → 19:40	19min	19:59 → 20:30	26min
	20:56 → 21:26	44min	22:10 → 22:41	-
Thursday		Extra runs during the day (morning)		



11/04/2019	CAGLIARI → S.GAVINO (START → STOP)	standstill train time in the station before next departure	S.GAVINO → CAGLIARI (START → STOP)	standstill train time in the station before next departure
	09:09 → 09:39	13min	09:52 → 10:23	37min
	11:00 → 11:30	20min	11:50 → 12:21	2h57min

Friday	Extra runs during the day (afternoon)			
12/04/2019	CAGLIARI → S.GAVINO (START → STOP)	standstill train time in the station before next departure	S.GAVINO → CAGLIARI (START → STOP)	standstill train time in the station before next departure
	17:10 → 17:40	19min	17:59 → 18:30	40min
	19:10 → 19:40	19min	19:59 → 20:30	26min
	20:56 → 21:26	44min	22:10 → 22:41	-

Saturday	runs in normal operation			
13/04/2019	CAGLIARI → S.GAVINO (START → STOP)	standstill train time in the station before next departure	S.GAVINO → CAGLIARI (START → STOP)	standstill train time in the station before next departure
	14:53 → 15:38	32min	16:10 → 16:55	1h10min
	18:05 → 18:50	30min	19:20 → 20:06	1h34min

Figure 12 Train runs schedule in the Italian measurement campaign

GNSS raw data acquired during the Italian measurement campaign from the selected measurement systems have been stored in the FTP server repository as described in Section 3.1.2. For each train run, run tables have been generated and stored in the ERSAT GGC FTP server. They contain the starting and ending time for the evaluation of each run specifying also the track segments covered in the run. Figure 13 shows an example of a run table generated for a specific run executed in the Italian campaign.

```

RunTable0001.txt
1 Run #0001
2 # Cagliari - San Gavino
3 Starting time: 08.04.2019 20:55:00
4 End time: 08.04.2019 21:30:00
5 Track List: 13,12,11
  
```

Figure 13 Run table

In addition, the reference track maps files containing the list of relevant Track IDs (Track Table file) with its connecting nodes (Node Table file) and the reference coordinates for each track ID (Reference Position file) have been generated and stored in the FTP server.

TrackID	Node1	Node2	MinLat	MaxLat	MinLon	MaxLon	MinAlt	MaxAlt	Lenght
10	1000	1001	39.55421829	39.55775833	8.800776482	8.805703163	111.3809407	112.7910431	594
11	1001	1002	39.50768661	39.55421448	8.805711746	8.887065887	107.3833666	120.2322848	9115
12	1002	1003	39.31193924	39.50767899	8.887071609	8.954851151	60.28076903	118.9904894	25703
13	1003	1004	39.21671127	39.31193161	8.954648972	9.106990684	51.72908023	61.53635745	18198
21	1001	1102	39.51714516	39.55422401	8.805712223	8.876874447	106.9835703	114.5046288	7922
22	1102	1103	39.35245514	39.51713943	8.876882553	8.944247246	71.9198336	119.345146	21850
23	1103	1104	39.26421356	39.35244751	8.944250107	9.045742512	51.7566524	72.96476751	15401
24	1104	1105	39.21642685	39.26420784	9.045751572	9.10751915	51.2151798	61.19627392	8243

Track table file



NodeID	TrackIDs
1000	10
1001	10,11,21
1002	11,12
1003	12,13
1004	13
1102	21,22
1103	22,23
1104	23,24
1105	24

**Node table file**

PosID	LeftDist	RightDist	Lat	Lon	Alt	ECEF-X	ECEF-Y	ECEF-Z
0	0	593	39.55421829	8.805703163	112.6015206	4866417.67	753857.2731	4040018.297
1	1	592	39.55422592	8.805697441	112.6002979	4866417.212	753856.7044	4040018.949
2	2	591	39.55422974	8.805687904	112.5990764	4866417.07	753855.853	4040019.275
3	3	590	39.55423737	8.805681229	112.5985358	4866416.624	753855.2033	4040019.927
4	4	589	39.554245	8.805672646	112.5987665	4866416.204	753854.3918	4040020.581
5	5	588	39.55424881	8.805663109	112.6008537	4866416.064	753853.5407	4040020.909
6	6	587	39.55425644	8.805657387	112.6012933	4866415.607	753852.9722	4040021.562
7	7	586	39.55426025	8.805648804	112.5997437	4866415.452	753852.2017	4040021.888
8	8	585	39.55426788	8.805642128	112.5975287	4866415.005	753851.5519	4040022.539
9	9	584	39.5542717	8.805633545	112.5949191	4866414.85	753850.7813	4040022.864

**Reference Position file**

*Figure 14 reference track maps files*

As a last part of the process, all the data acquired during the Italian campaign have been processed with the track area classification Toolset (specific information on how the Toolset process has been executed is provided in the next sub-section). Finally, track classification results have been computed and stored in the FTP server repository.

The measurement sub-system directly related to the track area classification process mainly consists of an antenna and a COTS GNSS receiver able to collect all the measurements required to perform the track assessment. Based on the requirements and recommendations provided by the classification process specification [2], the hardware of the measurement sub-system used in the Italian measurement campaign has been selected considering:

- Input parameters required for the classification process
- Flexibility in the configuration of some receiver parameters
- Possibility to configure the hardware of the measurement sub-system in order to deactivate multipath and interference mitigation options
- Availability of the received power level parameters.

Based on the above assumptions, the following set of equipment has been used to carry out the data collection in Sardinia:

- GNSS antenna: Antcom's G5 antenna
- Two GNSS receivers for carrying out the verification of the process and related measurement procedures; the use of the two receivers has allowed a comparative analysis to tune the process. One receiver only is required at regime for the application of the classification process. The two receivers are:
  - Septentrio AsteRx4 OEM
  - Javad Delta-3N
- Splitter: ZB4PD1-2000-S+
- DC block: BLK-18-S+
- Coaxial Cable
- Two laptops connected to the GNSS receivers

The selected GNSS receivers provide also PSD and AGC measurements allowing the evaluation of received power level without the use of extra hardware.



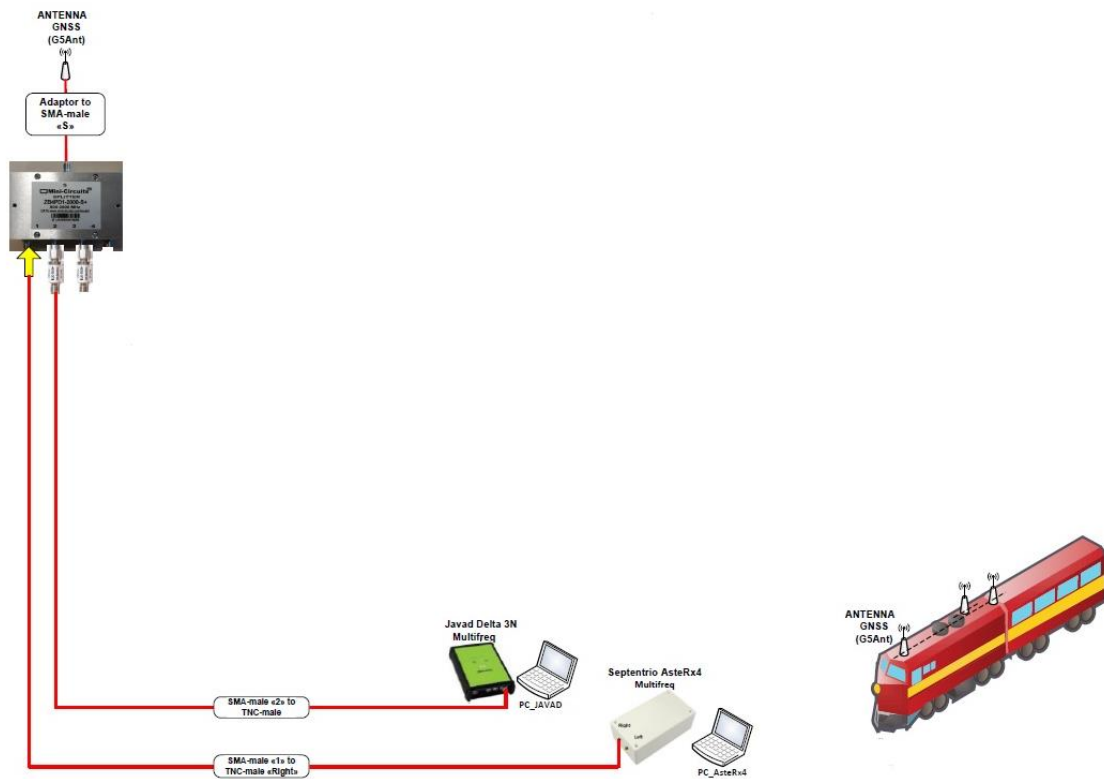

Figure 15 Measurement sub-system configuration

As depicted in Figure 15, all the equipment is connected to the Antcom's G5 antenna (installed on the train roof) through the splitter. One output of the splitter has been directly connected to the Septentrio AsteRx4 receiver and another one has been connected through the DC Block to the Javad receiver. The laptops, connected to the GNSS receivers, were in charge of launching the configuration/software tools and to store the data coming from the two receivers. Figure 16 depicts the antenna installation on the train roof and the on-board equipment installation.





**GNSS Antenna (G5Ant-3AT1)**

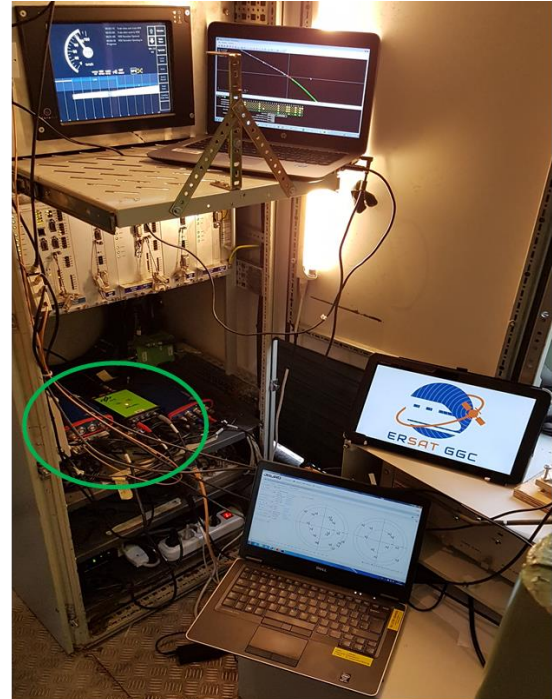

**Javad and Septentrio GNSS receivers**

*Figure 16 Measurement sub-system installation*

Two GNSS receivers have been used during the measurement campaign in Sardinia in order to allow a comparative analysis of the classification Toolset results; this comparative analysis has been done for the verification of the classification process. One receiver only is required for the application of the classification process. Both receivers have been configured to record the following data in the proprietary format, for multiple constellations and multiple frequencies:

1. Time tag in TOW (time of week expressed in ms) and WNc (week number counter)
2. Code phase measurements or pseudoranges
3. Carrier phase measurements
4. Doppler frequency in Hz
5. GPS/ Galileo Navigation message or ephemeris data
6. Position and velocity in 3D Cartesian coordinate system
7. Position and velocity in geodetic coordinates with WGS84 datum
8. SBAS decoded data
9. Carrier to noise ratio in dB-Hz
10. I and Q sample or spectrum data
11. AGC data.



## 4.2 MEASUREMENT CAMPAIGN IN SPANISH LINE

The present section collects the information of the classification process preparation (installation and runs organization) and the static and dynamic collection of data performed in Spain in the frame of WP4 of ERSAT-GGC project, whose objective was the verification of the classification process in some Spanish Lines.

The classification process was executed along a Spanish line according to the process and Toolset defined in ERSAT-GGC project (see references [1], [2] and [3]). The first part of the process consisted on the preparation and execution of the measurement campaign, and the second part was the analysis of the collected data with the Toolset developed within the project. In particular, the following activities were performed:

- **Selection of reference site:** ADIF selected the line nº528 Almorchón (Badajoz) - Mirabueno (Córdoba) which is of type E, with a total length of 130.1Km and not electrified. The measurement test campaign was limited to the section up to Almorchón (Station 37400 PK 130.1) - Alhondiguilla Villaviciosa (Station 00010 PK.40.8) that has a length of 89.3 km and a speed maximum of 60 km / h. It is a low traffic regional line, and the target reference site for the performance of the tests was selected with the aim of evaluating GNSS technology starting from low-traffic regional lines. This line section was dedicated to the survey execution during all the measurement campaign, so there was no impact on commercial trains.



Figure 17 Spanish line Almorchón-Alhondiguilla

- **Selection of the rolling stock:** a laboratory train from ADIF (named BT-02) was selected, and it was dedicated to ERSAT-GGC trial on site during all the survey.
- **Selection of the measurement equipment:** The specific GNSS measurement equipment to be provided by ADIF has been selected to be according to the technical



specifications for the survey process and Toolset recommended in the references [1] and [2].

- **Planning and preparation of the test campaign:** The integration and installation of the equipment was performed according to the equipment provider specifications. The Test campaign runs were organized to cover different times in 24h and 2 weeks to run under different epoch conditions. Tests were planned in order to have samples spaced 24h (repeatability of GPS constellation) and samples spaced 10 days (repeatability of Galileo constellation).
- **Execution of the test campaign:** The test campaign was executed during ten days (20<sup>th</sup> to 24<sup>th</sup> and 27<sup>th</sup> to 31<sup>st</sup> of May 2019). The line and the rolling stock were dedicated to this activity during all this period. Twenty runs were performed, and the train runs have been scheduled in different time of the day (morning, afternoon, night) to cover the reception of signals from various elevation angles.
- **Analysis of the test campaign results:** The raw data acquired were transferred to CEDEX lab for analysis with the Toolset to finally obtain the classification of this line.

The data collected during the measurement campaign located in the track section Almorchón – Alhondiguilla includes information to evaluate areas in the line in terms of multipath, satellite visibility and interferences, with the aim of classifying them as Green, Red or Yellow areas.

The **rolling stock** selected by ADIF for the measurement campaign was the unit BT-02, which is a laboratory train generally used for track and catenary auscultation tests. The unit is formed by a four-composition car with a diesel powered car, two intermediate cars and one end car with a driving cab, and has enough room inside to install all the measurement equipment.

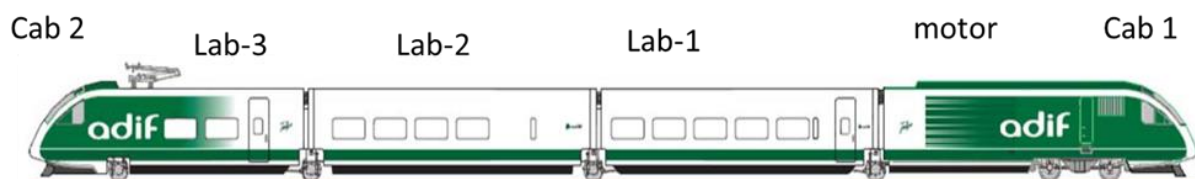

*Figure 18 BT train configuration*

The train was equipped with the following **measurement equipment** for the campaign execution to register the required data that will be analysed later with the Toolset developed within the project:

- **GNSS measurement system** comprised of GNSS antenna, GNSS splitter, GNSS receiver (Javad Delta3) and wiring provided by ADIF:
  - **GNSS antenna**
    - AntCom G8- PN: Ant743\_A4T1-A2
  - **GNSS receiver**





- Javad Delta3
- **GNSS splitter**
  - GPS Networking LDCBS1X4-N
- Optional measurement equipment for NLOS analysis with a **Fish-eye camera**, provided by IFSTTAR was installed for 5 days.

There was also available additional and auxiliary equipment:

- A second GNSS receiver was used (Septentrio AsteRx2eL) during the whole campaign for auxiliary purposes
- Laptop with external hard disks
- UPS: Salicru SPS 1000 SOHO (2 units)
- Coaxial cables RG-58 WITH BNC, TNC and Type N connectors and suitable adapters
- Cabin camera (GoPro Hero7), with GNSS data recorder provided by ADIF, used to identify locations.

Additionally the on-board odometry measurement system was powered on to be collecting and registering the train speed along each run, although it was no need to use these data for the posterior analysis.

The general scheme of the devices installation is shown in next scheme:

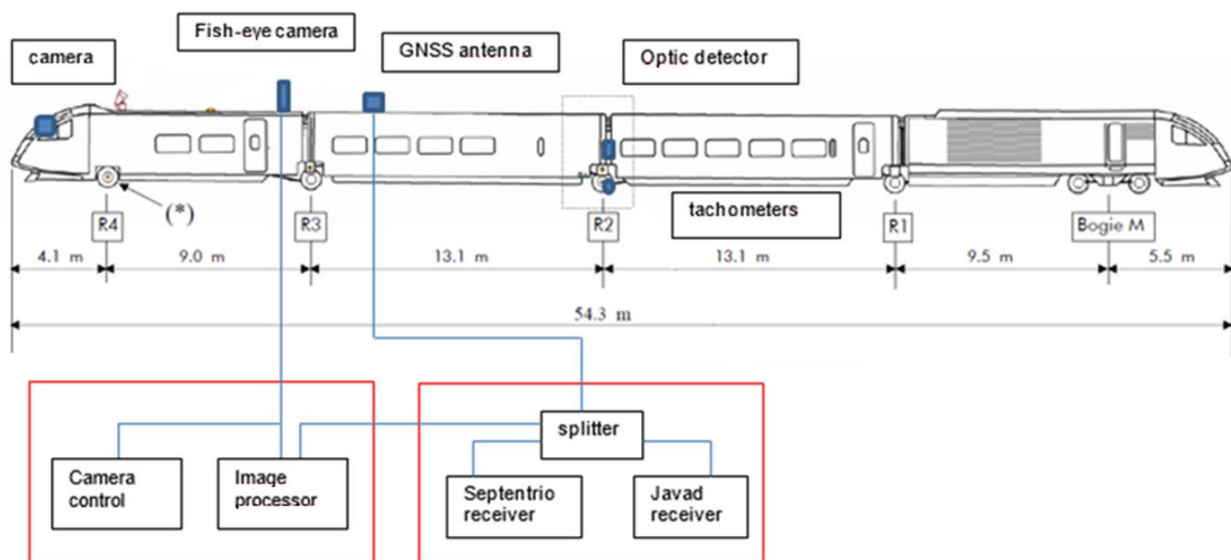

Figure 19 General scheme of equipment installation

The equipment integration, installation and preliminary tests in the train has been performed for the devices defined above with the consensus of rolling stock specialist, equipment provider and devices installation requirements. The installation, configuration and adjustment of ERSAT-GGC devices for the test execution with the BT laboratory train has been carried out in Talgo facilities



located in Las Matas and fulfilling all the procedures regarding occupational risks and industrial safety by qualified personnel.



Fish-eye camera in Lab-3 car

GNSS antenna in Lab-2 car

Figure 20 View of installation on train roof of GNSS antenna and fish-eye camera



Figure 21 Lab-2 car with ADIF, INECO and CEDEX instrumentation



Figure 22 Driver's desk



## 4.2.1 GNSS MEASUREMENT SYSTEM

The GNSS measurement system comprises the antenna and receiver. The next figure shows the GNSS antenna and JAVAD receiver installed in the BT laboratory test for the test campaign:



Figure 23 GNSS antenna



Figure 24 Javad and Septentrio Receivers

The GNSS antenna (ANTCOM model G8Ant-743A4T1-A2) installed on the train roof fulfils the requirements defined by the supplier. There was an obstacle-free area around the antenna.



Figure 25 Final installation of GNSS antenna

Once the GNSS antenna was installed on the roof of the train, a coaxial cable connected the antenna to the GNSS splitter (GPS Networking model LDCBS1X4-N) placed inside lab-3 car.

The GNSS (JAVAD Delta-3) receiver is connected to the GNSS Splitter via a dedicated cable to receive and process the GNSS signals.



The laptop, connected to GNSS receiver through Ethernet, was in charge to launch the configuration / measurement / recording software tools, specifically designed for ERSAT GGC project, which are required for the GNSS receiver JAVAD.

Special options for the Javad configuration are required for this project as “Galileo”, “Spectrum Data Output”, “Ethernet” and “Update Data Rate 10Hz” and these options are described in classification process specification

## 4.2.2 IFSTTAR CAMERA SYSTEM

IFSTTAR supplied a camera-based system to survey satellite constellation visibility. This measurement system had a fish-eye camera that was installed on the train roof while equipment for processing and recording data was located in Lab-3 car.

The installation requirements for the fish-eye camera system are summarized in the following points:

- The camera has to be fixed on the train roof following the adaptation indications defined by IFSTTAR to adapt the camera to the train roof to guarantee a correct installation.
- IFSTTAR equipment was connected to the GNSS splitter to receive the signal from the GNSS measurement antenna.
- Cables were fixed in the train roof from the camera to inside the train through the proper cable guiding available at the train. The wiring could be done through the gap between the two cars.

The following pictures show the final installation of IFSTTAR camera in Talgo premises located in Las Matas following Prevention of Occupational Risks and Safety procedures. Additional equipment for processing and recording satellite constellation visibility has been installed by IFSTTAR inside the laboratory train in coach Lab-3 as shown in the following pictures.

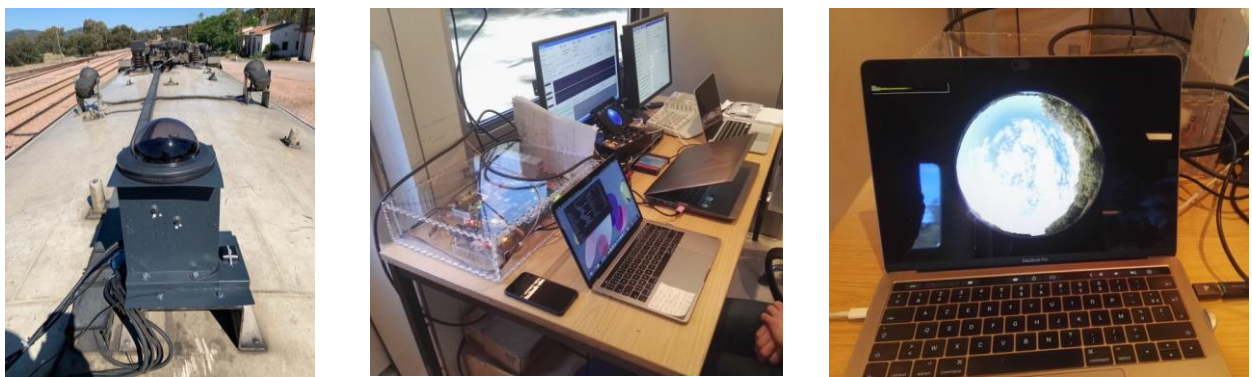

Figure 26 Fish-eye camera on train roof and processing equipment



## 4.3 MEASUREMENT CAMPAIGN IN FRENCH LINE

SNCF (Experimental department and Innovation and research department) organized three measurement campaigns in the Paris region. SNCF chose this area, since SNCF considers important to address the main lines of France with innovation to foster the ERTMS deployment and respond to the increased mobility needs of the maximum of European citizen. Moreover, the urban and dense areas are challenging and instructive about the GNSS uses.

## 4.4 DESCRIPTION OF THE MEASUREMENT CAMPAIGNS

For the measurement campaign, SNCF planned round trip along three lines:

<b>RER C</b>	<p>The RER C is one of the five lines in the RER system serving Paris, France. It is operated by SNCF.</p> <p>The line runs from the north-western termini Pontoise (C1), Versailles-Château-Rive-Gauche (C5) and Saint-Quentin-en-Yvelines (C7) to the south-eastern termini Massy-Palaiseau (C2), Dourdan-la-Forêt (C4), Saint-Martin d'Étampes (C6) and Versailles – Chantiers (C8).</p> <p>The RER C line is the second-longest in the network, with over 187 km (116 mi) of route. Each day, over 531 trains run on the RER C alone, and carries over 540,000 passengers daily. It is also the most popular RER line for tourists who represent 15% of its passengers, as the line serves many monuments and museums, including the Palace of Versailles.</p>
<b>RER D</b>	<p>The RER D is one of five RER lines serving Paris, France. It connects Orry-la-Ville and Creil in the north to Melun, Corbeil-Essonnes and Malesherbes in the south, passing through the heart of Paris.</p> <p>Opened in stages from 1987 to 1996, it is the longest RER line by distance, and the busiest SNCF line in France, carrying up to 615,000 passengers and operating 466 trains each working day. Almost all of the line is located in the Île-de-France region, that is, within the jurisdiction of the Île-de-France mobilités (STIF), but some of the branch line ends at the north and south are outside this region.</p>
<b>Paris Lyon Marseille</b>	<p>The railway from Paris to Marseille is an 862-kilometre long railway line that connects Paris to the southern port city of Marseille, France via Dijon and Lyon. The railway line was opened in several stages between 1847 and 1856, when the final section through Lyon was opened. The opening of the LGV Sud-Est high speed line from Paris to Lyon in 1981, the LGV Rhône-Alpes in 1992 and the LGV Méditerranée in 2001 has decreased its importance for passenger traffic.</p>



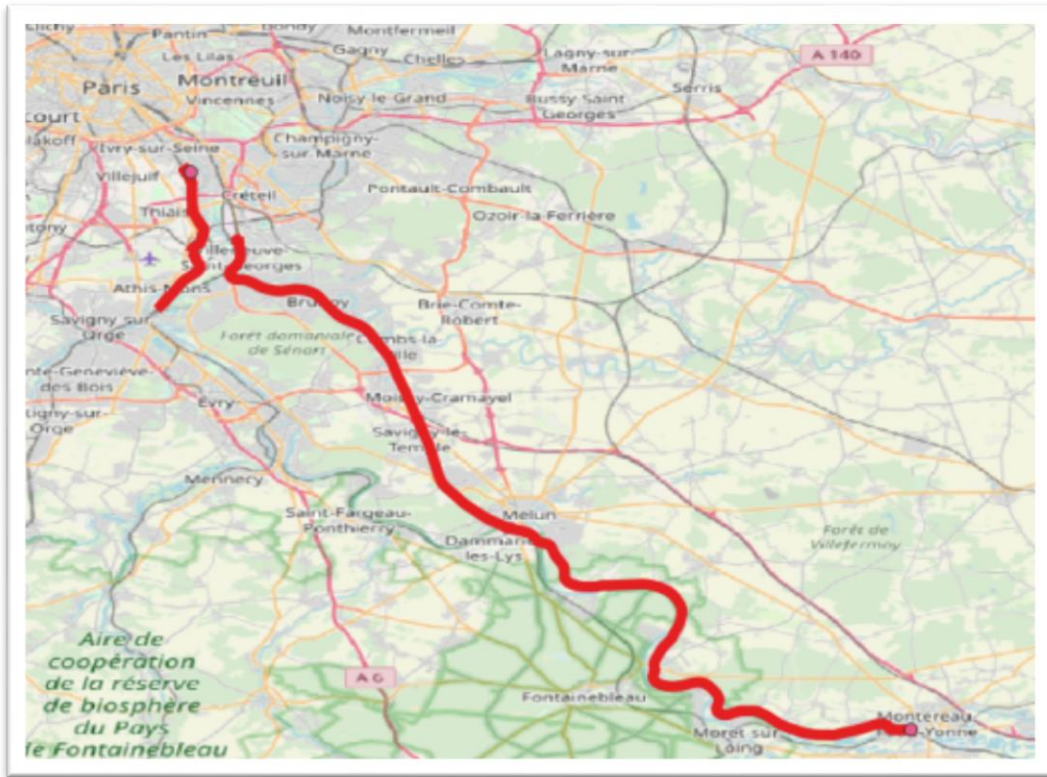

Figure 27 French line

For the measurement campaign, SNCF used a dedicated test train composed of:

- The SNCF class BB 60000 are a class of 4 axles heavy shunting and light freight diesel electric locomotives built at the Vossloh Espana works in Valencia. Since the class is primarily used as a freight locomotive the class is commonly referred to as SNCF BB460000;
- A former passenger refurbished in a laboratory platform for the SNCF ATO programs.

*Nota Bene: this train is also used for SNCF internal activities like ATO program especially for obstacle detection and advanced telecommunication system.*





*Figure 28 SNCF Test Train*



## 5. PROCESS EXECUTION IN ITALIAN LINE

We provide in the following the details of the execution of the classification process based on the measurement campaign carried out in the Italian line and described in Section 4.1.

### 5.1 CALIBRATION MEASUREMENT AND PROCESS

The calibration phase is required for setting up the decision threshold considering that each measurement equipment installation on the train has its own properties in terms of RFI and multipath with respect to the reception of the GNSS signals. Therefore, the detection sensitivity of the detection techniques implemented in the toolset has to be calibrated for every measurement setup. This calibration must be done after the first installation and the application of modifications to the installation.

In Sardinia, calibration measurements have been acquired with the train still in a location with nominal GNSS conditions, as depicted in Figure 29.



*Figure 29 Selected area for the static measurements*

In the Italian measurement campaign, eight hours of calibration data acquisition have been carried out covering different elevations of the satellites.

Calibration measurements have been used in the classification Toolset to generate the calibration files. In particular, calibration files are necessary for the following detection tools:

- Interference (AGC, PSD)
- Multipath (CMCD, CN0)
- NLOS (residuals based)

For AGC and PSD the files associated with the static calibration period have been manually inserted in the corresponding calibration input directory as depicted in Figure 30.





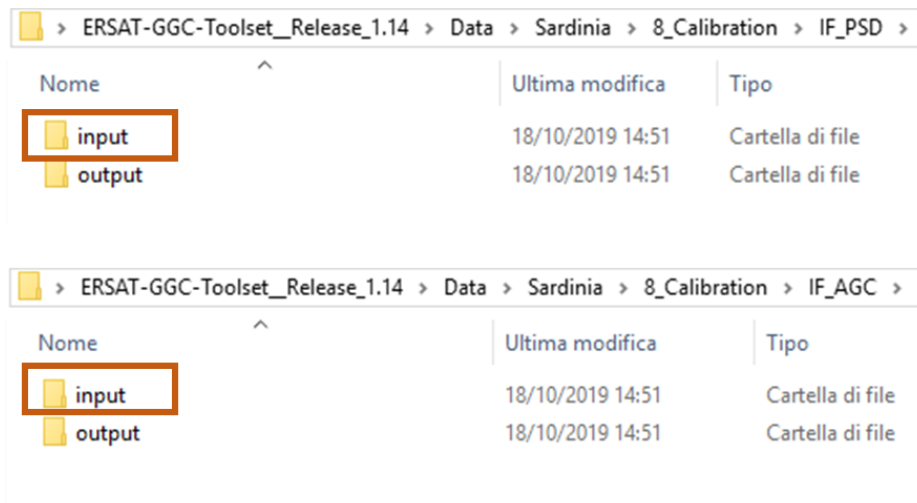

Figure 30 Calibration input directory for AGC and PSD

Then, using the Calibration tab in the GUI of the Toolset, the calibration files have been generated for AGC and PSD as depicted in Figure 31 and Figure 32.

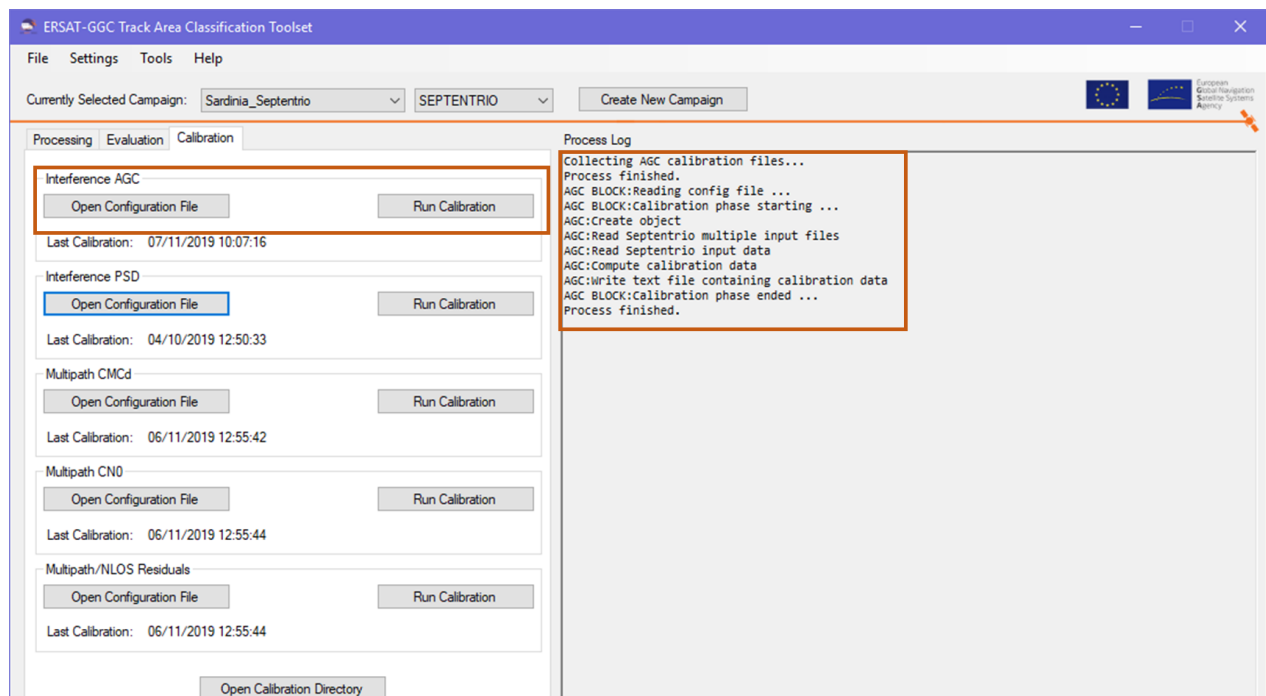

Figure 31 Calibration processing for Interference AGC



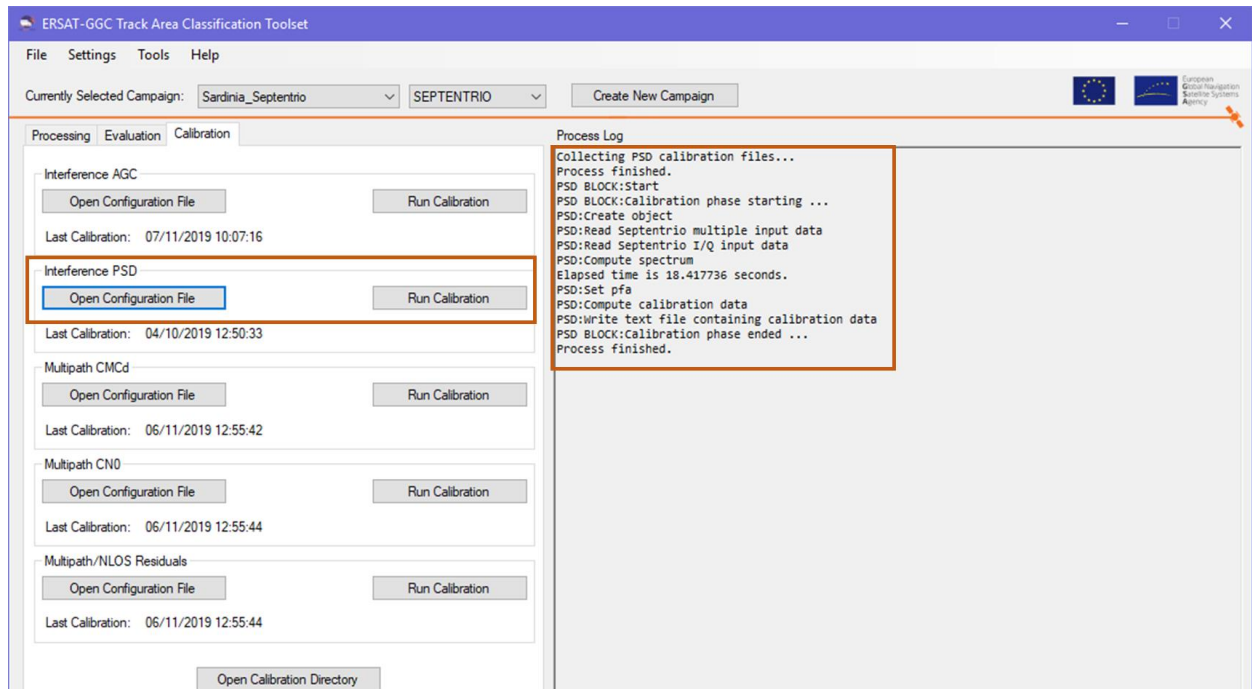

Figure 32 Calibration processing for Interference PSD

For CMCD, CN0 and Residuals threat detection tools, the correct dates and times corresponding to the static measurement data have been set in their individual configuration files. Then the calibration phase has been started for each tool as depicted in Figure 33, Figure 34 and Figure 35. The necessary input files have been automatically retrieved in the GNSS input directory.

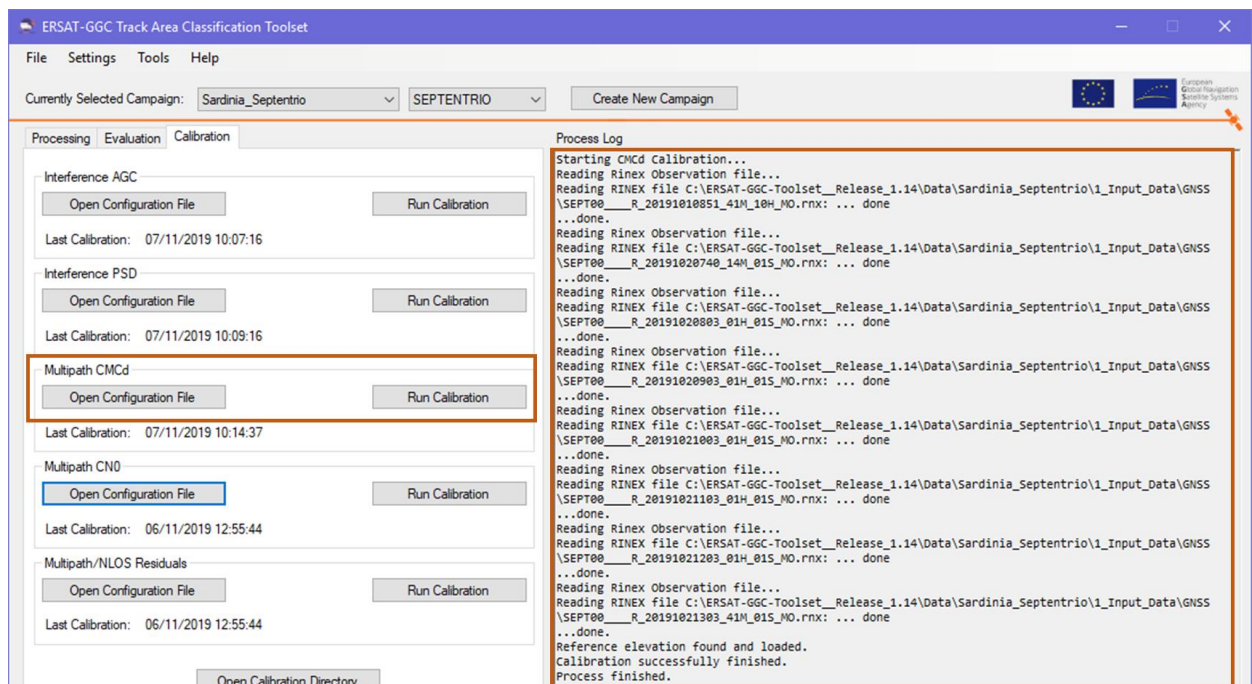

Figure 33 Calibration processing for Multipath CMCD

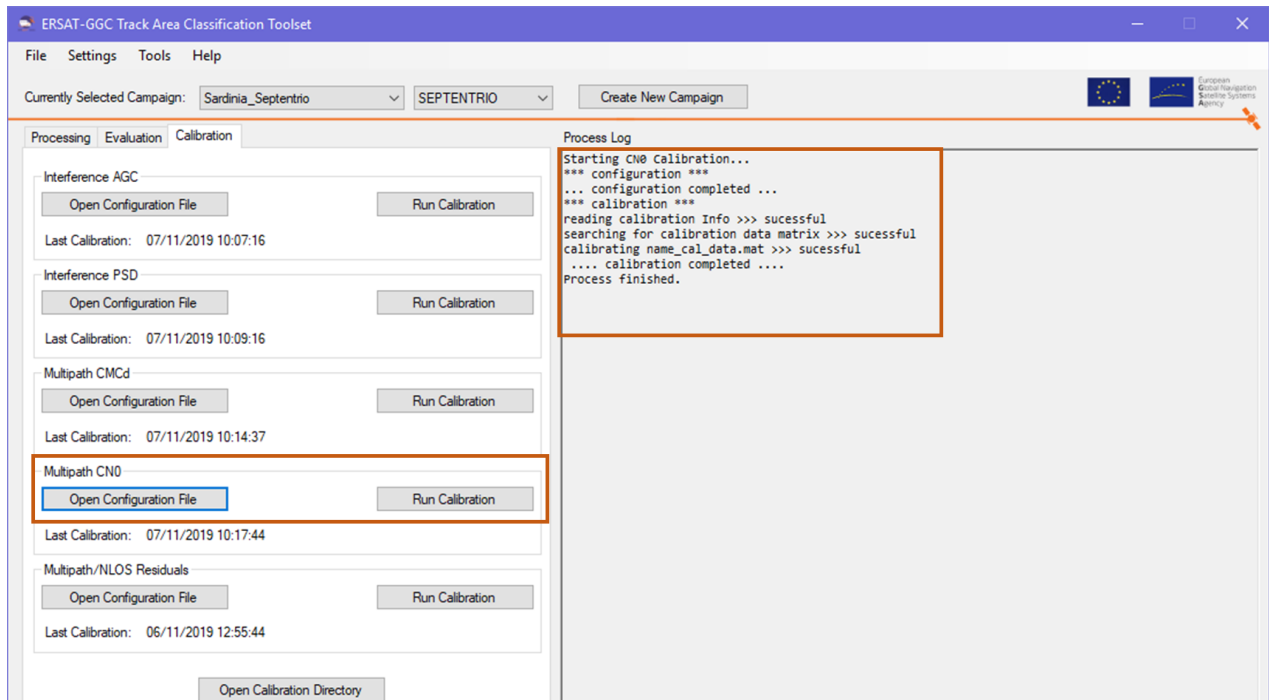

Figure 34 Calibration processing for Multipath CNO

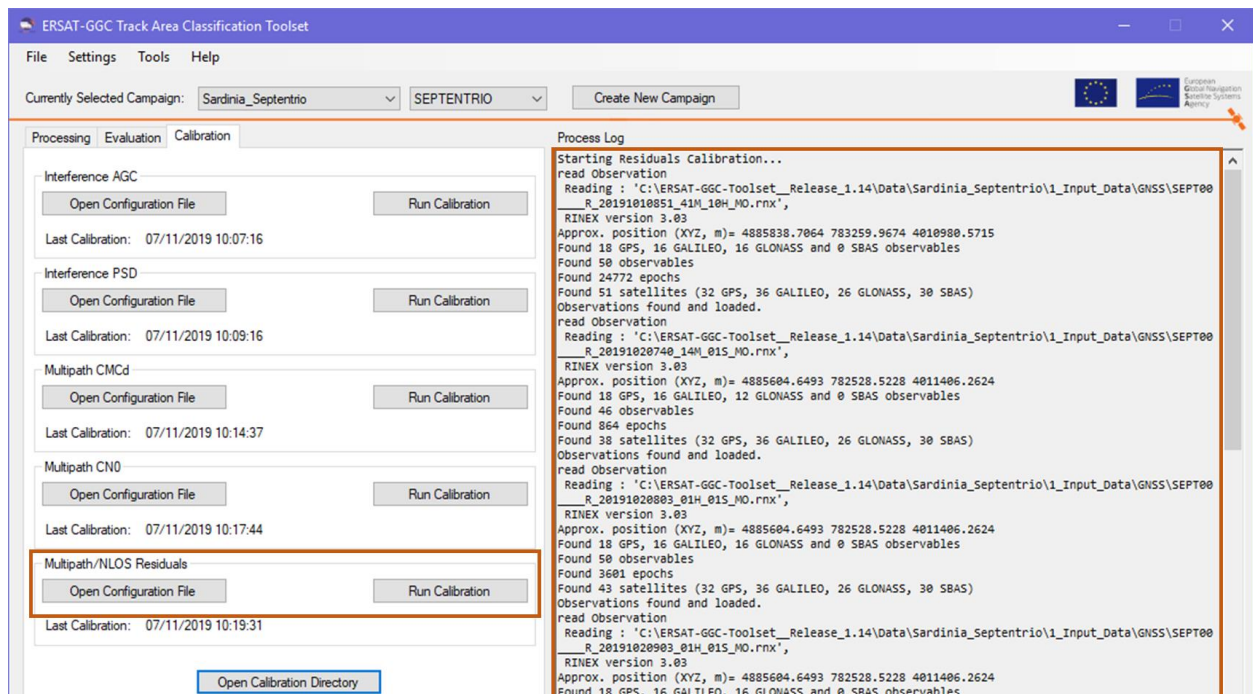

Figure 35 Calibration processing for Multipath/ NLOS Residuals

Calibration files have been generated for both Septentrio and Javad input data for each detection tool.



## 5.2 CONFIGURATION OF THE TOOLSET

All the data collected during the train runs in the Italian measurement campaign (Septentrio and Javad data) have been moved to the according directories in the Toolset. The following steps have been performed to run the classification Toolset:

- Select “Settings/General Settings” in the top menu of the GUI and specify the path of the data directory as depicted in Figure 36.

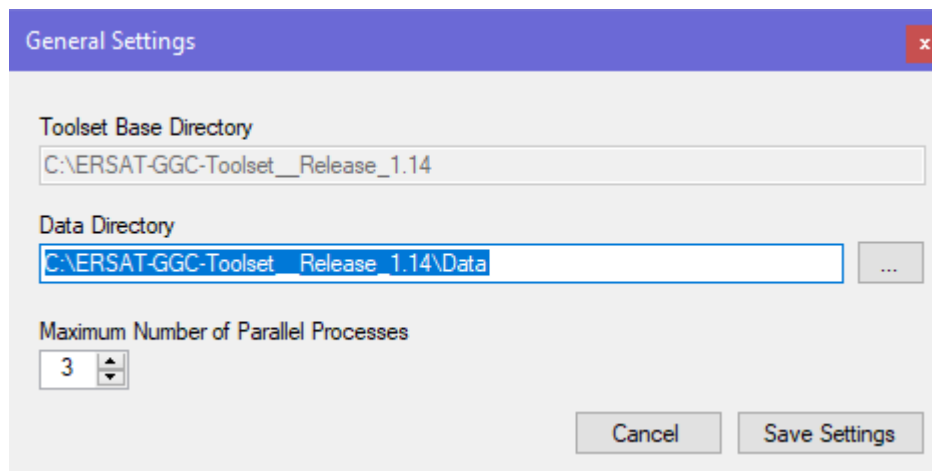

Figure 36 Toolset data directory selection

- Create a new campaign and select it as active campaign as depicted in Figure 37 and Figure 38.

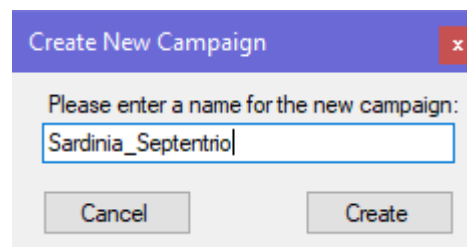

Figure 37 Create a campaign directory



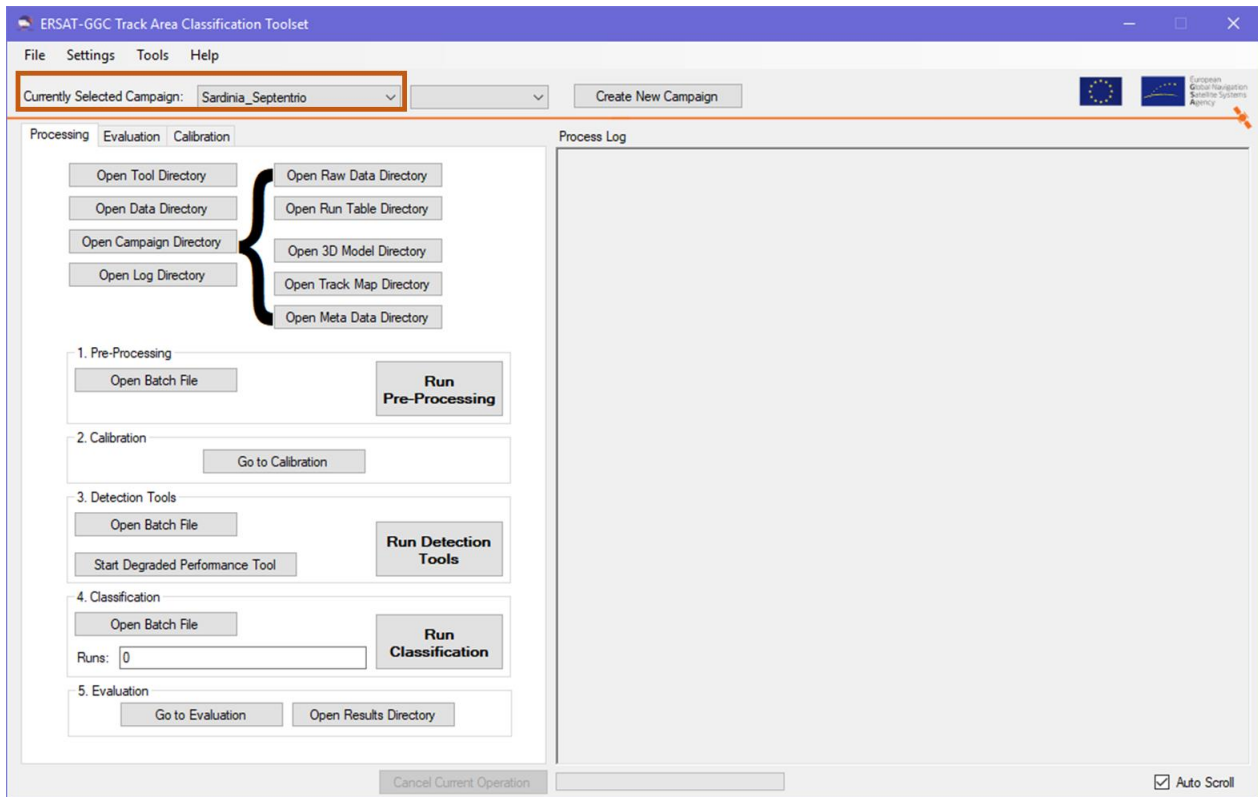

Figure 38 Selection of the active campaign

- Open the Raw Data Directory and copy the measurement data from the different GNSS receiver in the according subfolder.

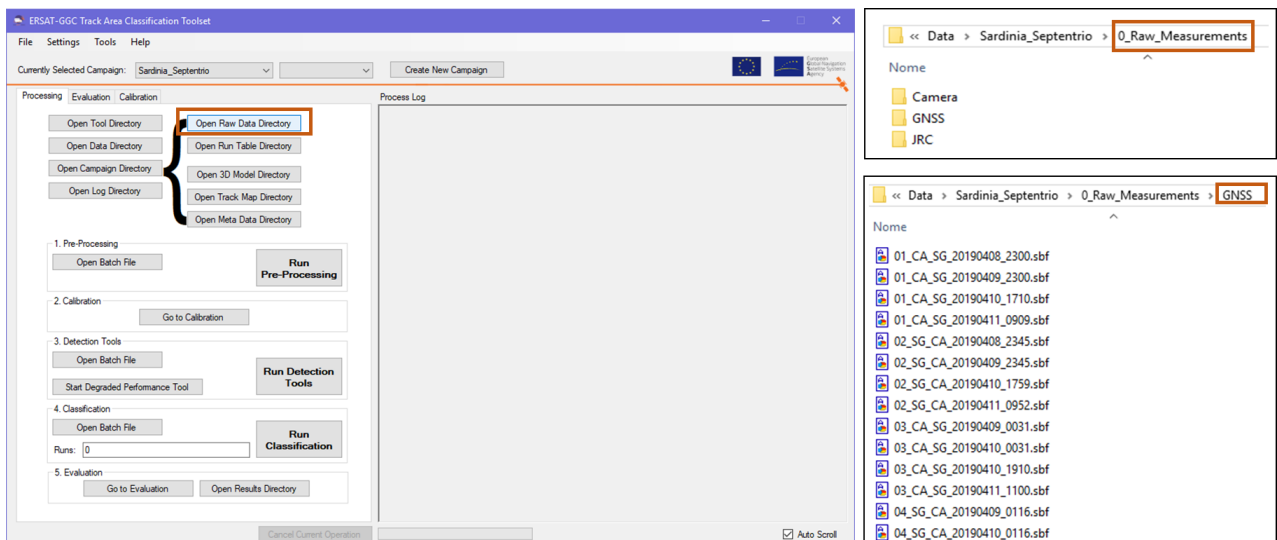

Figure 39 Raw measurements in the GNSS directory

- Insert in "Run Tables" directory the Run tables files.



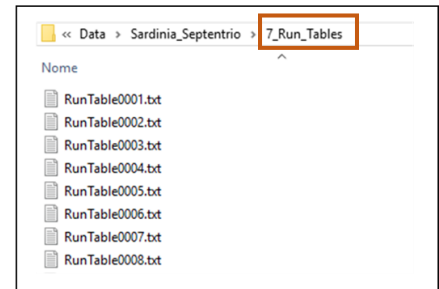
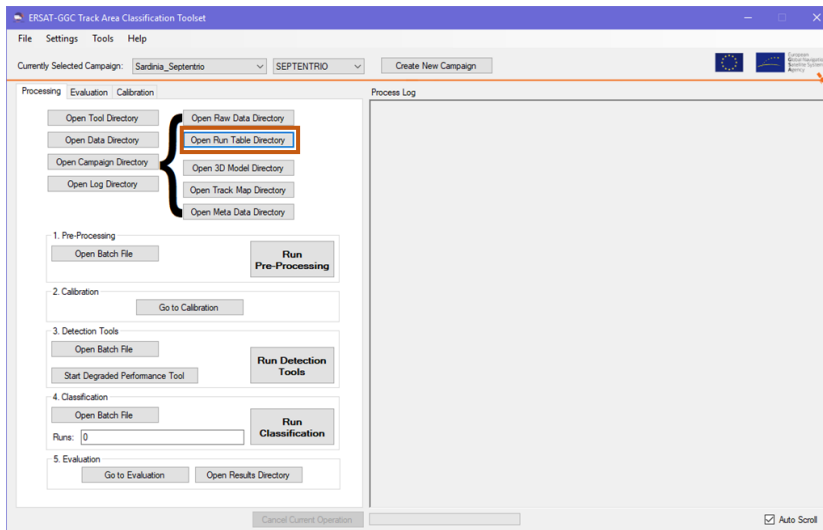

Figure 40 Run Table directory

- Insert in the “Track Maps” directory the reference track maps files.

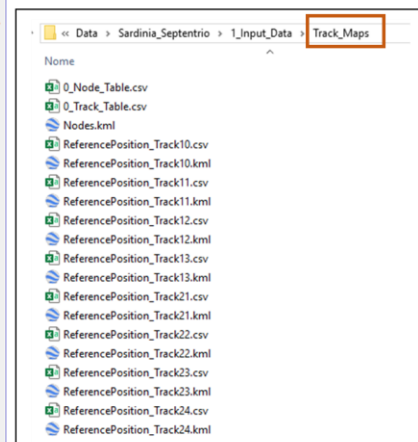
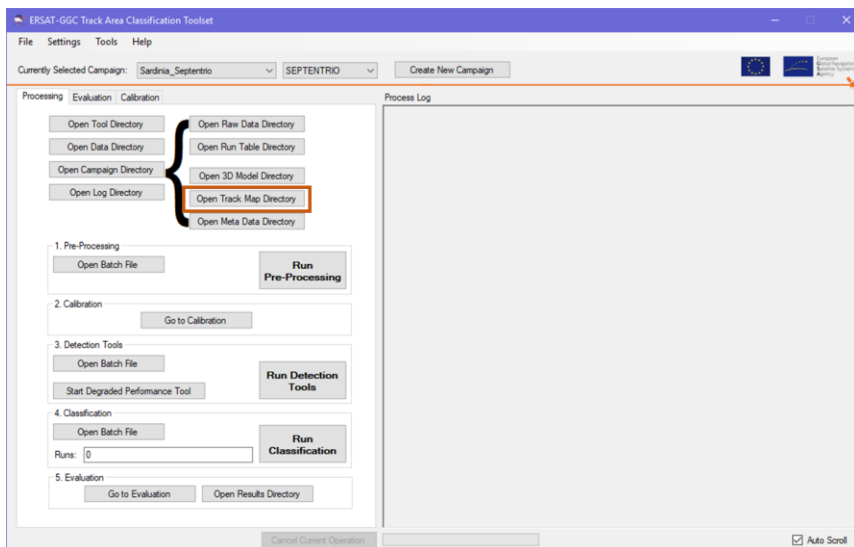

Figure 41 Track maps files

- Open the Settings/General Settings and make sure the receiver tab is correctly configured (e.g. SEPTENTRIO/JAVAD)



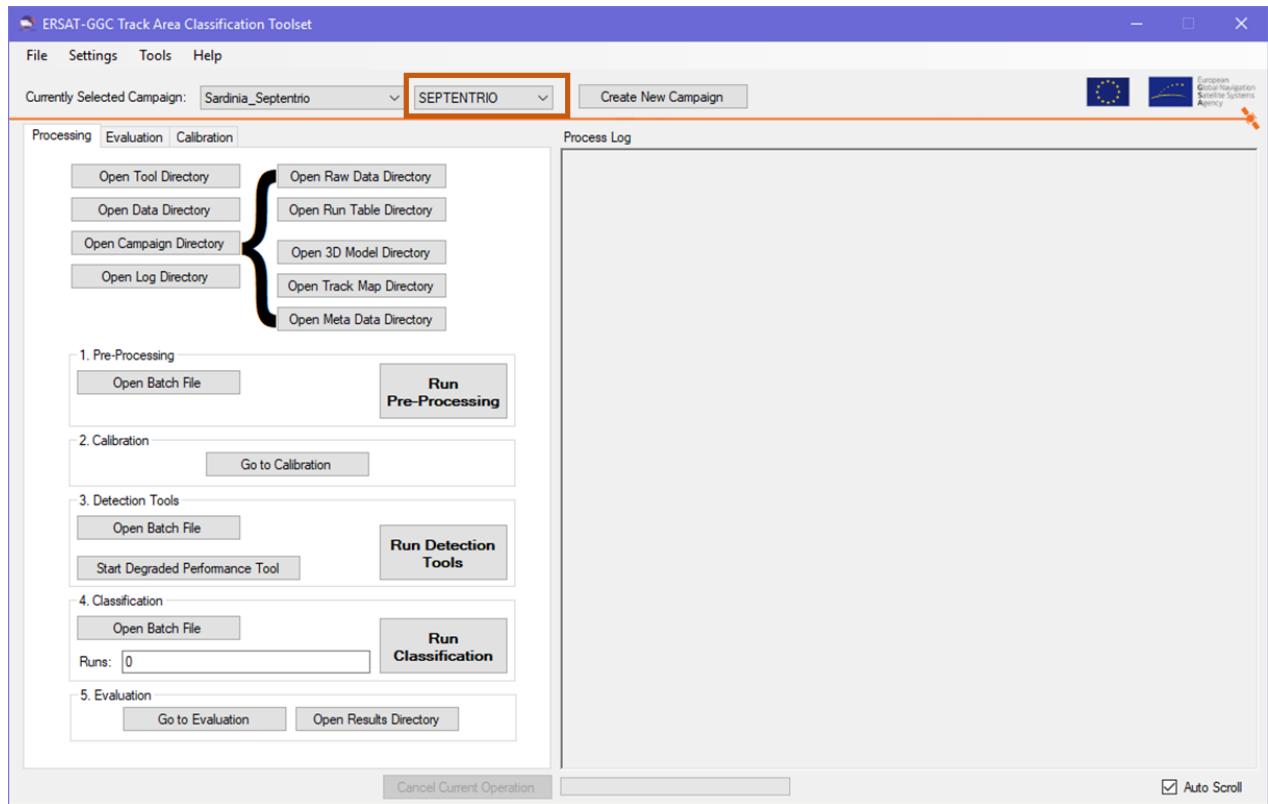

Figure 42 Selection of the receiver



## 5.3 PRE-PROCESSING

When all the steps described in Section 5.2 have been executed, the pre-processing phase has been launched using the “Run Pre-Processing” button in the GUI, as depicted in Figure 43.

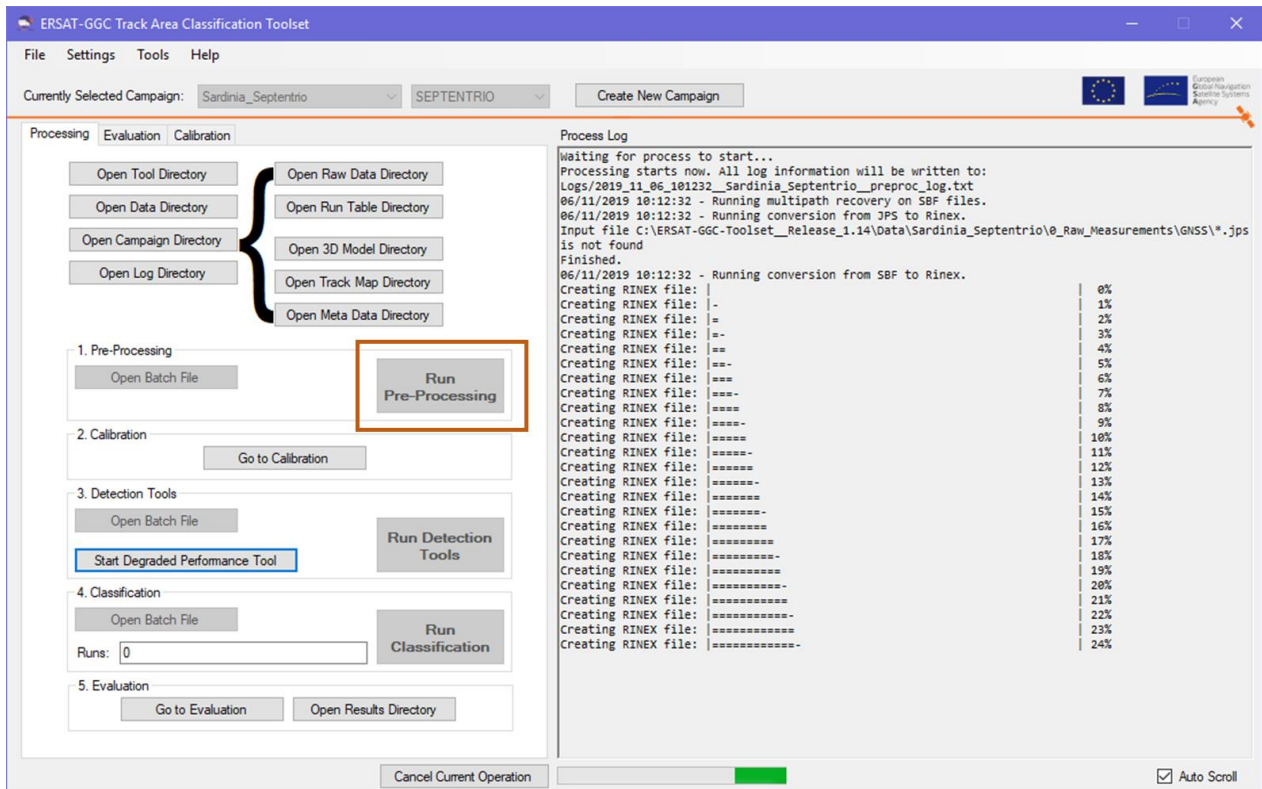

Figure 43 Launching the pre-processing phase

As soon as the pre-processing is finished, all the expected outputs have been created in the “Input\_Data” directory. Pre-processing phase has been performed for both Septentrio and Javad input data.





## 5.4 DETECTION & SIMULATIONS PROCESS

After the pre-processing and calibration phases have been finished, the detection process has been run using the “Run Detection Tools” button in the GUI as depicted in Figure 44. Detection process has been performed for both Septentrio and Javad input data.

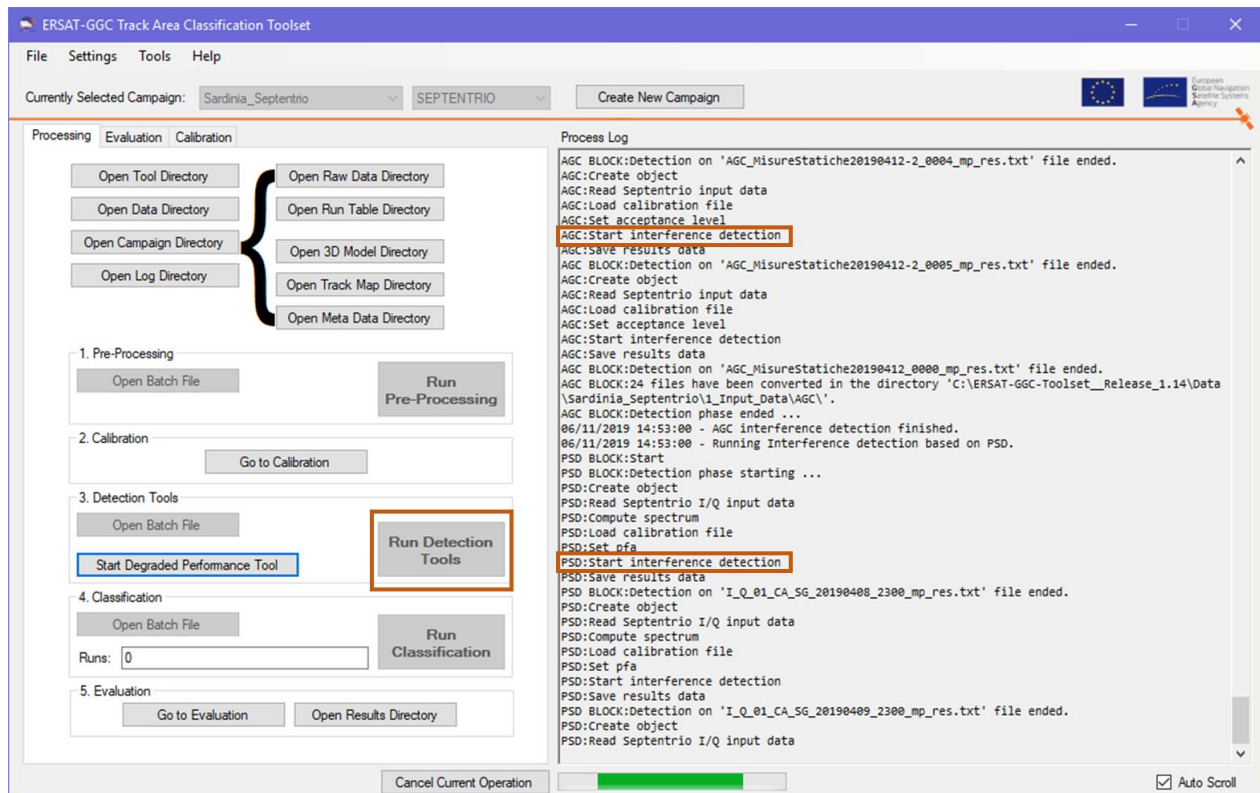

*Figure 44 Launching threat detection process*

Figure 44 shows also how each threat detection tool is run one after the other in the Track Area Classification Toolset. Once the detection process is finished, all the expected intermediate results from each threat detection tool are created in the “Intermediate\_results” directory as depicted in Figure 45 for AGC intermediate results.



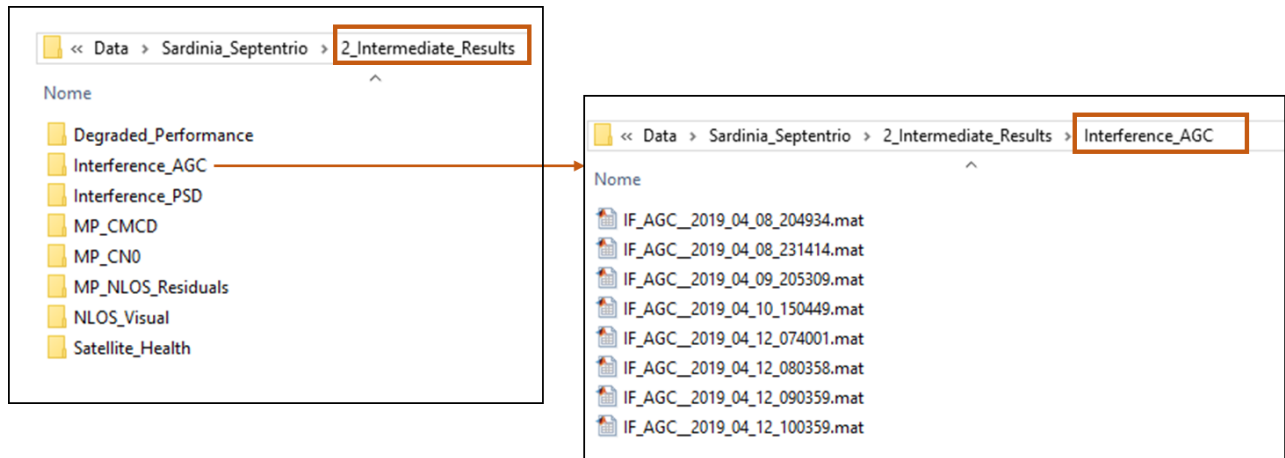

Figure 45 Intermediate results

Intermediate results have been generated for both Septentrio and Javad input data for each detection tool.

## 5.5 CLASSIFICATION PROCESS

Track area classification process has been performed on the Cagliari- San Gavino line using both Septentrio and Javad data acquired during the Italian measurement campaign. The entire processing chain (i.e. Pre-Processing, Calibration, Detection, Classification) has been executed and the final classification results have been computed.

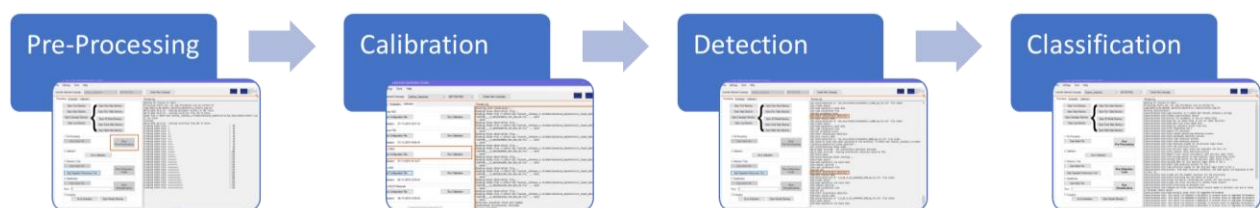
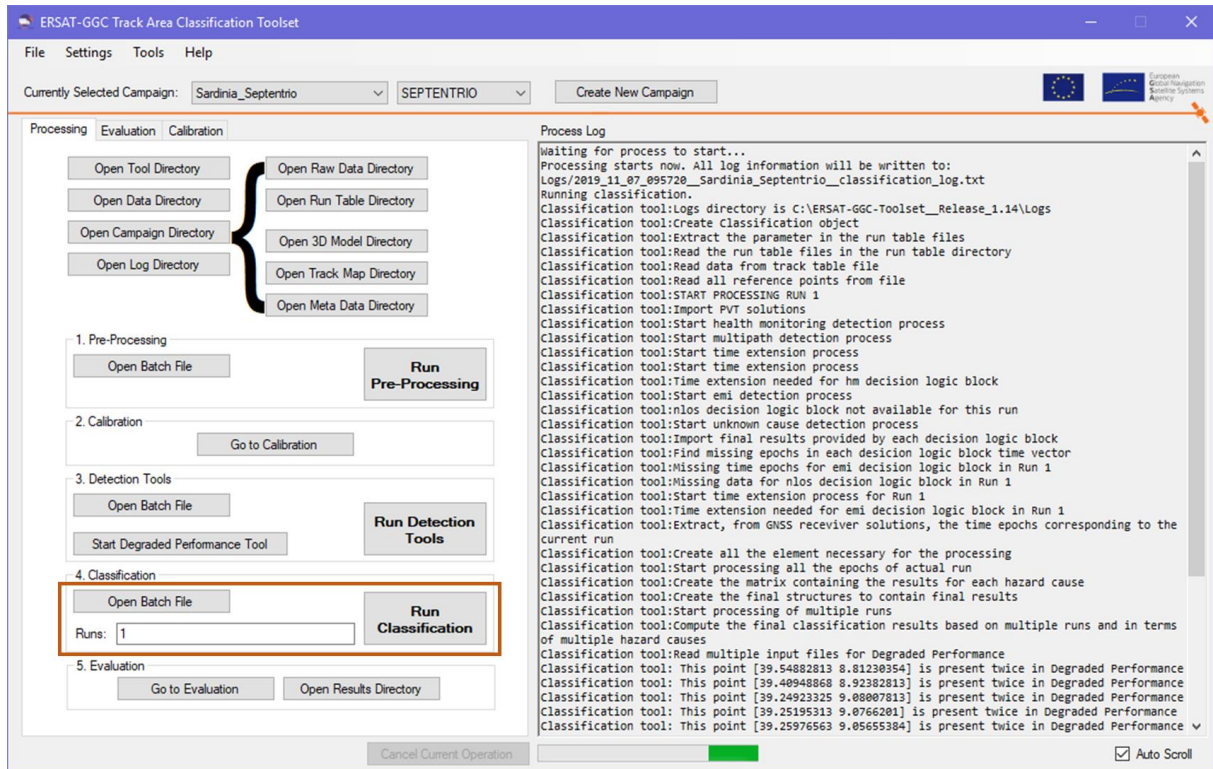

Figure 46 Classification processing chain

Firstly, GNSS raw data collected with both Septentrio and Javad receivers have been used in the Pre-Processing phase and input files with a specified format have been generated. Secondly, calibration files have been produced for some of the threat detection tools using the static measurement data acquired in the Italian campaign. After Pre-Processing and Calibration process have been finished, Detection process has been performed and Intermediate results have been produced. Finally, classification process has been performed on the Cagliari-San Gavino line combining results of all the threat detection tools on several runs. In particular, single run and combination of multiple runs have been considered in the classification process and final track area classification results have been generated for the Cagliari-San Gavino line. Using the



Run Selection option available in the GUI, single run and combination of multiple run have been processed with the track area classification Toolset as depicted in Figure 47.



Single run



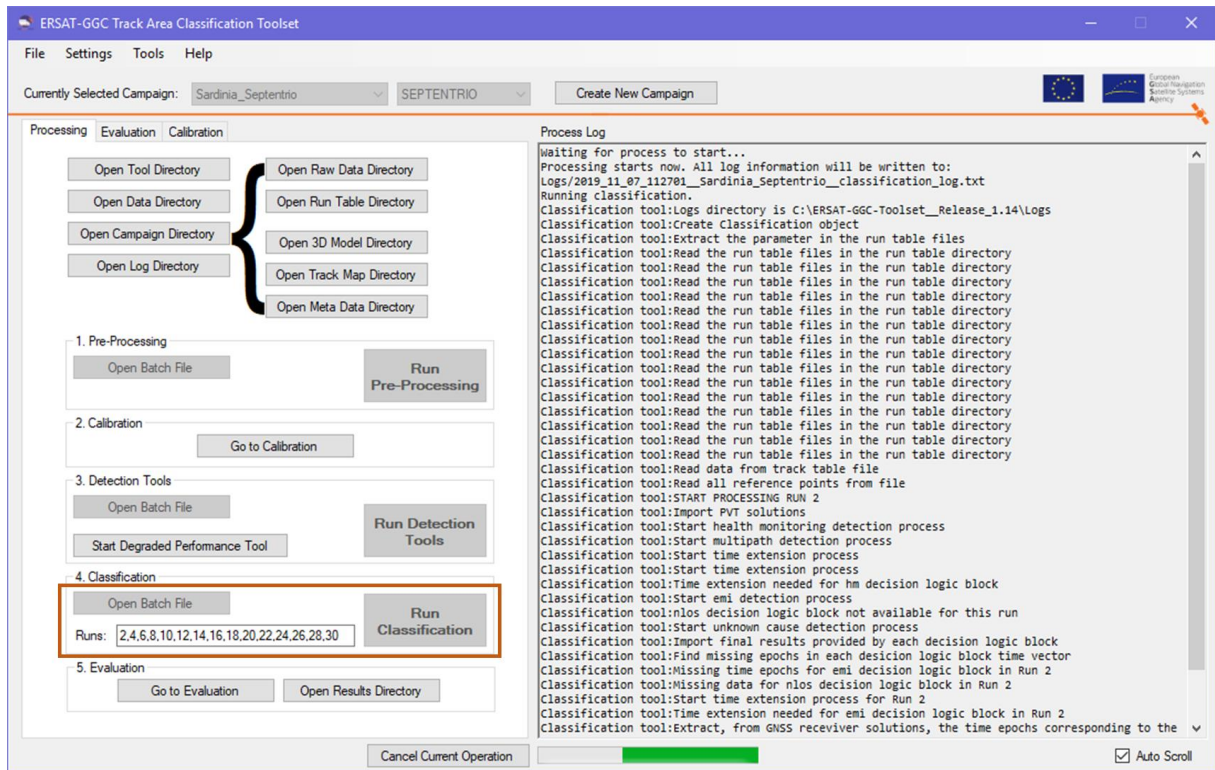

**Multiple runs**

*Figure 47 Single and multiple runs processing*

After the Classification phase has been finished, all results are available in the “Classification Results” directory as depicted in Figure 48.

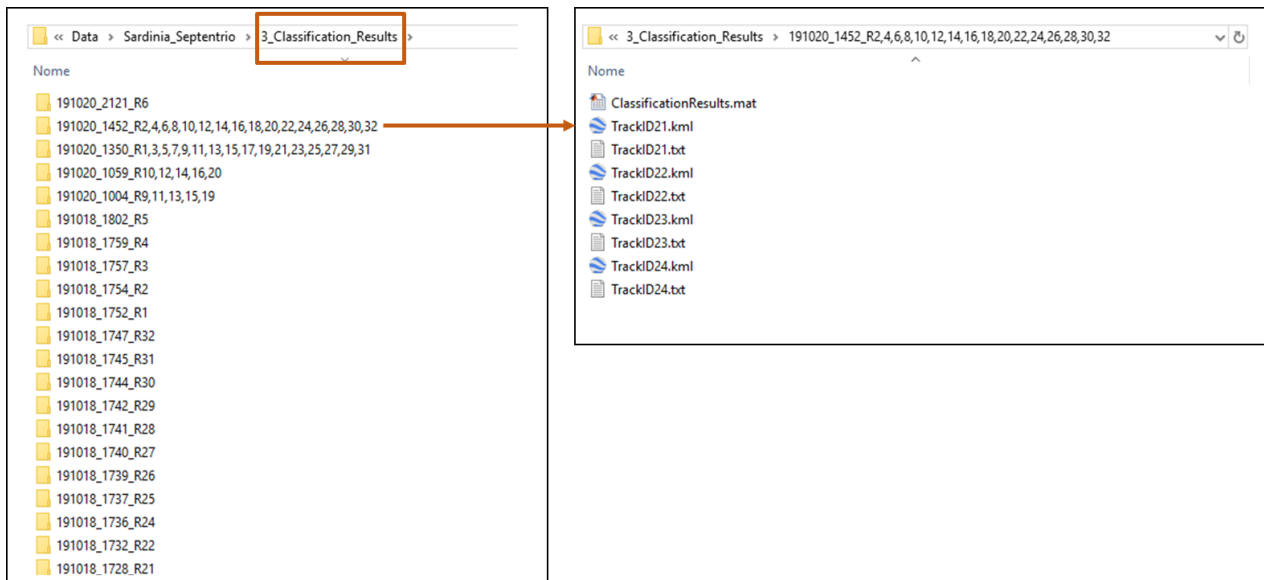

*Figure 48 Classification results*



## 5.6 EVALUATION OF RESULTS

After all classification results have been computed, the evaluation process has been performed for both classification results obtained using Septentrio and Javad data for different combination of runs:

- Single runs on Northbound
- Groups of Northbound runs
- Combination of all the Northbound runs
- Single run on Southbound
- Groups of Southbound runs
- Combination of all the Southbound Runs

Northbound and southbound are related to two different tracks. In particular, Northbound refers to all the runs from Cagliari to San Gavino while Southbound to all the runs from San Gavino to Cagliari.

Figure 49 shows a comparison of results obtained processing only single runs with Septentrio data. In particular are depicted classification results for run 13 (on the left) and for run 14 (on the right).



Figure 49 Single runs comparison for Septentrio data

As shown in Figure 49, evaluation on a single run shows that there is not enough information to classify the track areas and the results presents a high percentage of yellow areas.

Figure 50 shows a comparison of results obtained combining groups of Northbound and Southbound Runs.





Runs 9,11,13,15,19 merged – 10.9% yellow area



Runs 10,12,14,16,20 merged – 10.8% % yellow area

Figure 50 Group of Northbound vs. Group of Southbound Runs for Septentrio data

Results obtained on both groups of Northbound and Southbound Runs presents a high percentage of green areas and only ~11% of the line remains not classified (yellow percentage). Therefore, the combination of multiples merged runs allows improving the significance of the results and strongly reducing the percentage of yellow areas.

Figure 51 shows a comparison of results obtained combining all the Northbound Runs and all the Southbound Runs.

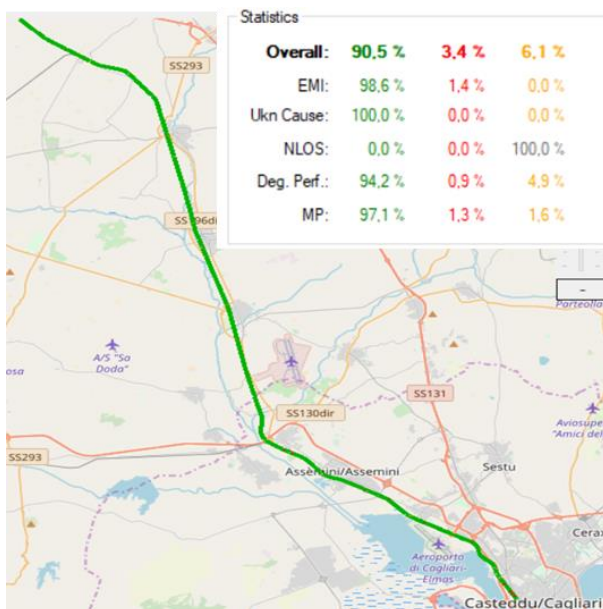

Runs 1,3,5,7,9,11,13,15,17, 19,21,23,25,27,29,31

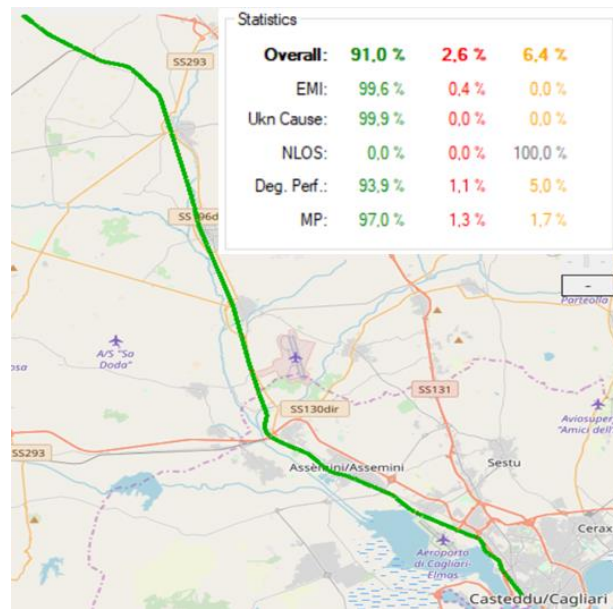

Runs 2,4,6,8,10,12,14,16, 18,20,22,24,26,28,30,32

Figure 51 Global classification on northbound and southbound tracks

As expected the percentage of classified areas (i.e. red plus green areas) is increased while yellow areas are strongly reduced compared to single runs. In addition, global classification on



northbound and southbound tracks seems consistent because identified obstacles (e.g. overpasses) are correctly classified as threats.

The same evaluation process performed on Septentrio data has been done also on Javad data. As shown in Figure 52, as previously, analysis of single runs does not provide enough information to perform a complete classification on the line.

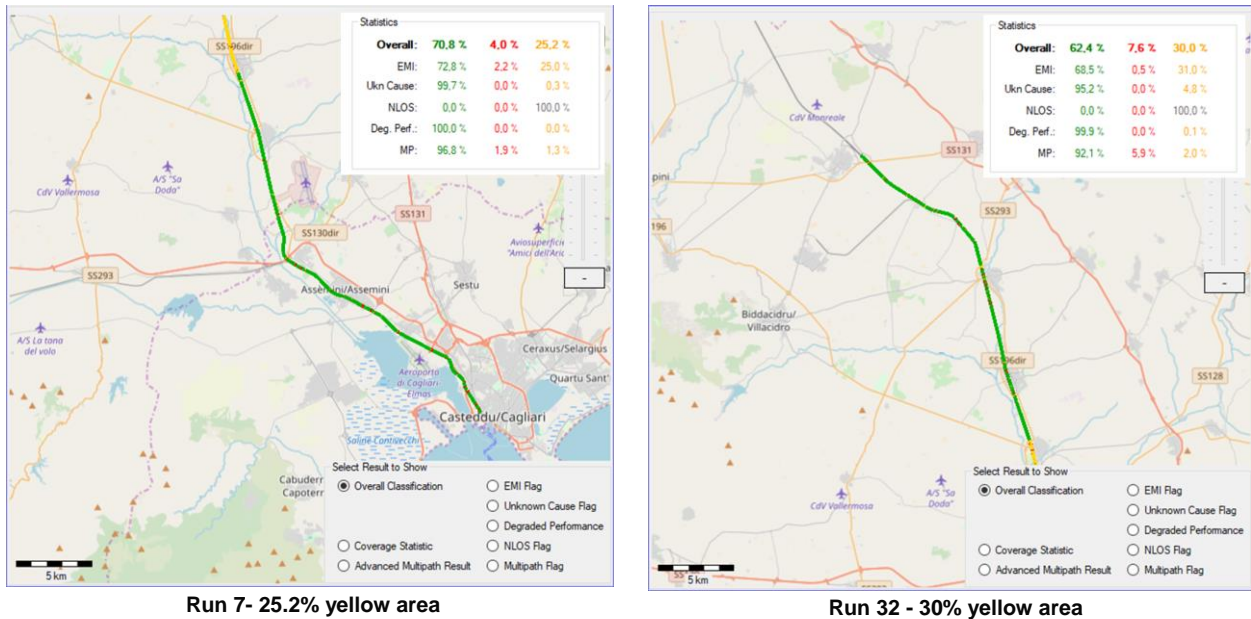
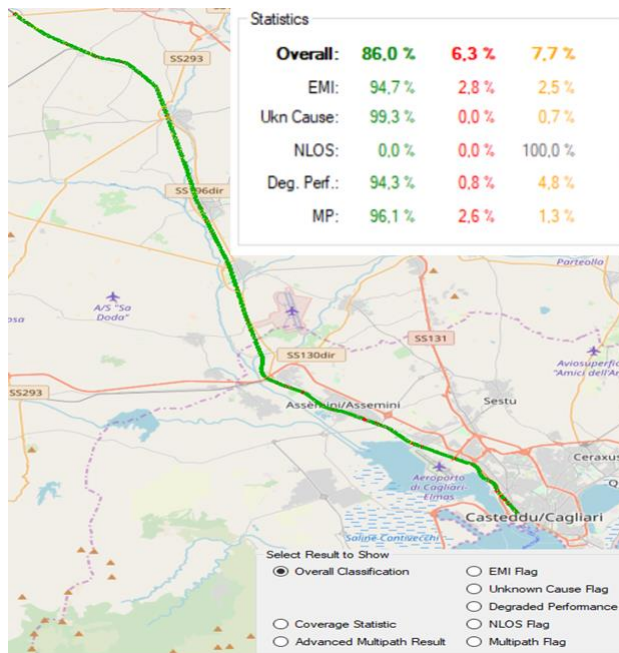

Figure 52 Single runs comparison for Javad data

Figure 53 shows a comparison of results obtained combining groups of Northbound and Southbound Runs.





Runs 7, 9, 11, 13, 15, 19, 21, 23, 29, 31

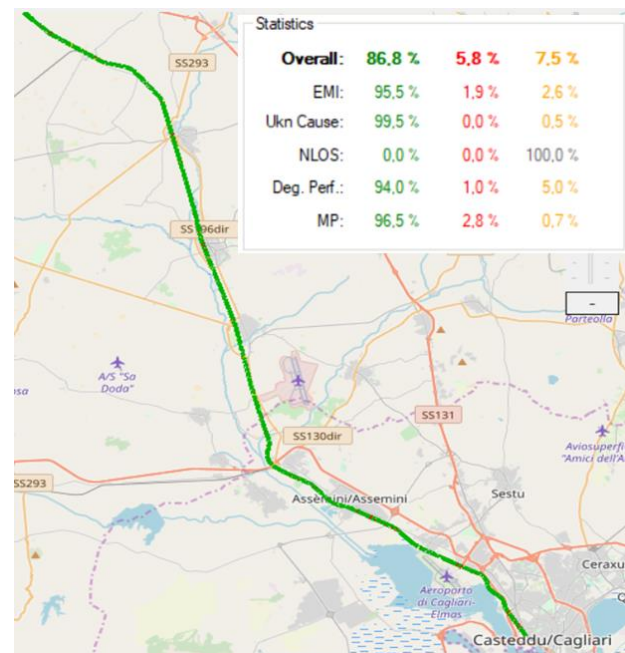

Runs 8, 12, 14, 16, 18, 20, 22, 30, 32

Figure 53 Group of Northbound vs. Group of Southbound Runs for Javad data

Also for Javad data, the combination of multiples merged runs allows to improve the significance of the results strongly reducing the percentage of yellow areas and increasing the percentage of classified areas (i.e. red plus green areas).

Finally, a comparative analysis among classification results obtained with the two receivers has been done for different detected threats. In particular, Figure 54 and Figure 55 show how the same EMI and Multipath occurrences have been detected on the line using both datasets acquired with Septentrio and Javad.

Let us clarify that only one receiver is necessary to carry out the classification process. The comparative analysis between receivers is here presented as verification evidence that the process produces similar results when using different receivers (i.e., classification results are receiver independent).





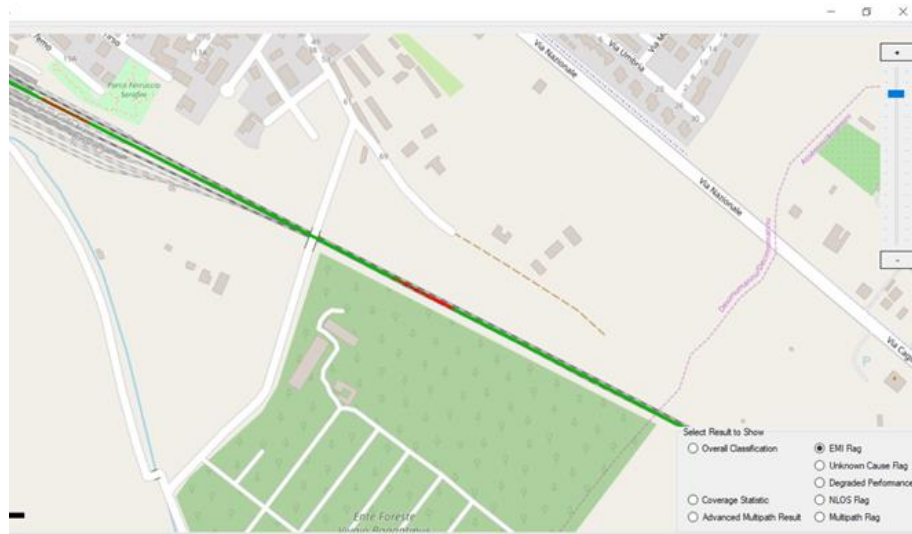

**EMI - Septentrio**

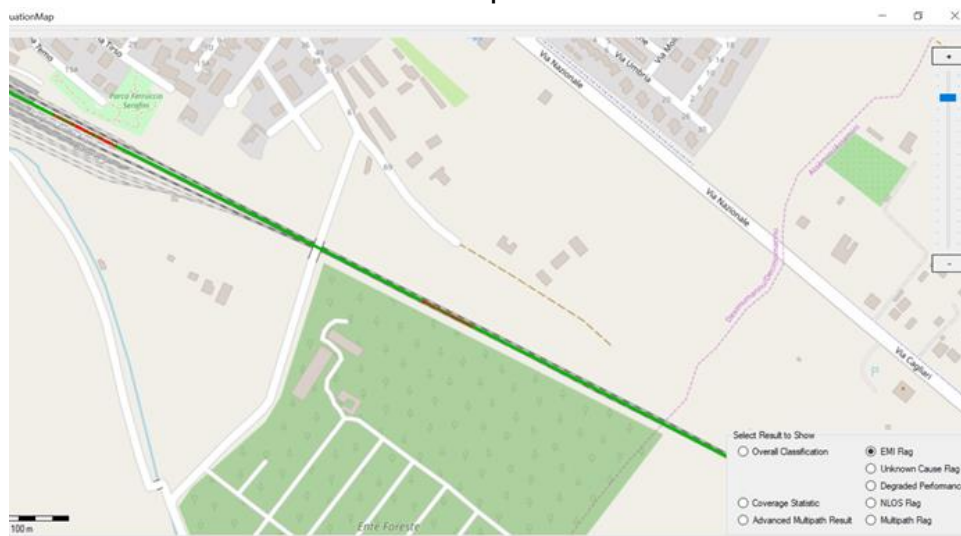

**EMI - Javad**

*Figure 54 Comparative analysis among receivers for EMI*



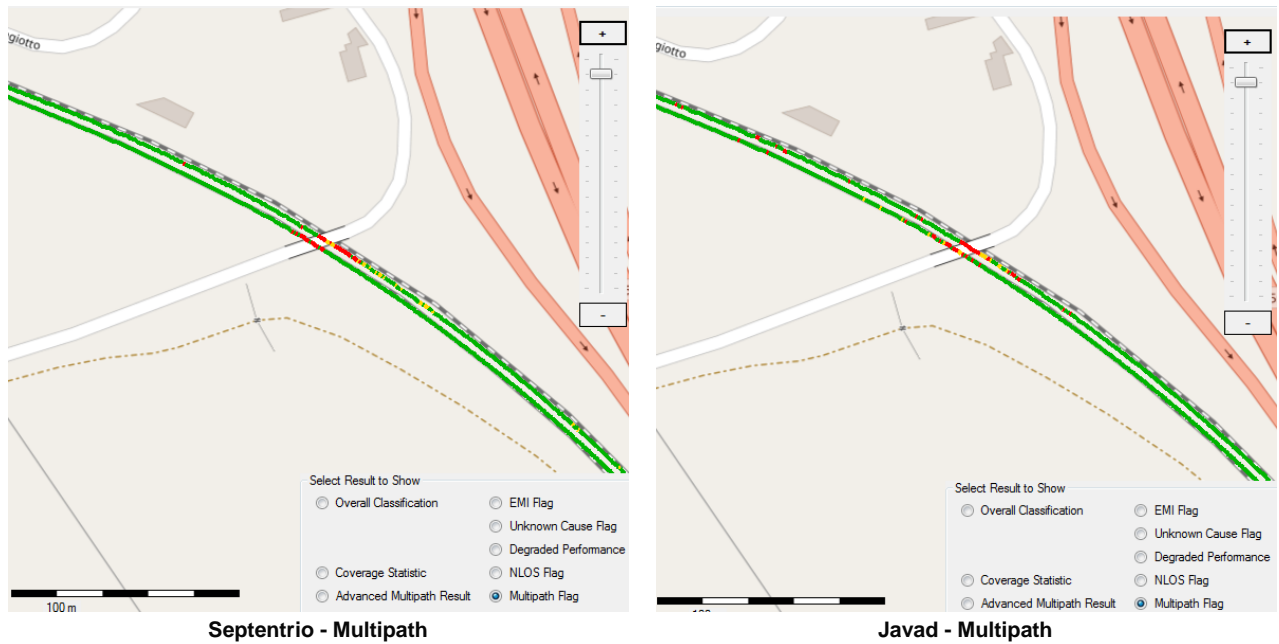

Figure 55 Comparative analysis among receivers for Multipath

In order to provide smooth classification results and to take into consideration the time a receiver may need to track properly the satellite signals after being under the influence of some hazard cause, we apply a protection distance smoothing to the classification results. An example of the effect of the application of this smoothing is provided in Figure 56 along the track areas, where we can see the overall results after the combination of the different hazard causes results without the application of the smoothing on the left side of the figure. Please note the intermittent presence of red results nearby the station and bridge area. On the same Figure 56 on the right, we can see the output with a 20m distance smoothing. The red and yellow areas are in this case easier identifiable and the green areas ensure the mentioned protection.





Figure 56 Results without (left) / with (right) protection distance smoothing (20 meter)

Adding the smoothing with this protection distance gives us a more realistic insight about the percentage of green areas where VEs could be safely placed. In Table 1 we can see the overall results after the combination of the different hazard causes classification results. In Table 2, we can see the final results after the application of 20 m protection distance smoothing.

Table 1 Overall Classification Results after combination of different hazard causes

Statistics	Green	Red	Yellow
<b>Overall:</b>	<b>96,1 %</b>	<b>2,2 %</b>	<b>1,8 %</b>
EMI:	99,1 %	0,9 %	0,0 %
Ukn Cause:	100,0 %	0,0 %	0,0 %
NLOS:	0,0 %	0,0 %	100,0 %
Deg. Perf.:	99,9 %	0,0 %	0,1 %
MP:	96,9 %	1,3 %	1,7 %

Table 2 Final Classification Results after 20m distance smoothing

Statistics	Green	Red	Yellow
<b>Overall:</b>	<b>83,1 %</b>	<b>8,5 %</b>	<b>8,4 %</b>
EMI:	99,1 %	0,9 %	0,0 %
Ukn Cause:	100,0 %	0,0 %	0,0 %
NLOS:	0,0 %	0,0 %	100,0 %
Deg. Perf.:	99,9 %	0,0 %	0,1 %
MP:	96,9 %	1,3 %	1,7 %



## 6. PROCESS EXECUTION IN SPANISH LINE

We provide in the following, the details of the execution of the classification process based on the measurement campaign carried out in the Spanish line and described in Section 4.2.

### 6.1 CALIBRATION MEASUREMENT AND PROCESS

The Spanish Test Campaign was executed from 20<sup>th</sup> to 31<sup>st</sup> of May 2019 with the aim of collecting GNSS data and information of the real environment in the frame of WP4 of the project.

The duration of 10 days was based on covering different locations of the satellites in the orbits and running under different epoch conditions.

The campaign consisted of the execution of dynamic round runs between Almorchón and Alhondiguilla stations (94Km), at a maximum speed of 40Km/h.



*Figure 57 Train stationed on track 3 at Almorchón station and view of the train on the line*

On May 21<sup>st</sup>, a collection of static test measurements **for the calibration of the GNSS devices** were performed with the train located in an open sky location, with the train in standstill condition. These calibration measurements are necessary to characterize properly the permanent effect of the specific installation of antenna and measurement system within the train.

The **calibration of the camera-based** system is performed off-line in laboratory before installation.





Figure 58 Calibration measurements site in the Spanish Campaign

The scheduled train runs for the data collection in Spanish line are shown below:

Table 3 Schedule train runs in Spanish line

Dynamic Tests		
Date	Circulation	Scheduled timetable
20/5/2019	Almorchón-Alhondiguilla-Almorchón	15:00-21:00h
21/5/2019	Almorchón-Alhondiguilla-Almorchón	08:00-14:00h
22/5/2019	Almorchón-Alhondiguilla-Almorchón	08:00-14:00h
23/5/2019	Almorchón-Alhondiguilla-Almorchón	12:00-18:00h
24/5/2019	Almorchón-Alhondiguilla-Almorchón	06:00-12:00h
27/5/2019	Almorchón-Alhondiguilla-Almorchón	18:00-00:00h
28/5/2019	Almorchón-Alhondiguilla-Almorchón	09:00-15:00h
29/5/2019	Almorchón-Alhondiguilla-Almorchón	00:00-06:00h
30/5/2019	Almorchón-Alhondiguilla-Almorchón	15:00-21:00h
31/5/2019	Almorchón-Alhondiguilla-Almorchón	08:00-14:00



The measurement campaign was executed during 10 days, with the participation of ADIF, CEDEX, INECO, DLR and IFSTTAR.

The raw data registers of different equipment were uploaded to ERSAT-GGC repository and transferred to the lab for analysis.

Images with the rooftop fish-eye camera have been between the 20/05 and the 24/05.

## 6.2 CONFIGURATION OF THE TOOLSET

For each test campaign analysis in the laboratories, a New Campaign has to be created, together with the suitable folder structure and data.

In particular, for the analysis of the Spanish measurement campaign, the results were stored following the agreed structure and the following folders were created during the Toolset analysis:

- **0\_Raw\_Measurements:**
  - Raw data coming from the Javad receiver and optional NLOS Visual data.
- **1\_Input\_Data:**
  - Results after executing the Pre-processing data from raw measurements of the Toolset
  - Track maps and 3D models.
- **2\_Intermediate\_Results**
  - Results after executing the Detection phase of the Toolset
  - Degraded Performance Tool output
  - Results of LOS detection based on images, when available, as optional data.
- **3\_Classification\_Results**
  - Results after executing the Classification phase of the Toolset
- **7\_Run\_Tables:**
  - Definition of date, starting and end time of the run
- **8\_Calibration:**
  - Results after executing the Calibration phase of the Toolset

According to the structure explained above and the objective of also evaluating the degraded GNSS performance by using the simulator tool, the following **data** have to be **available before starting the Toolset classification process**:

- **Raw data from calibration and dynamic runs:** data collected by the GNSS receivers during the measurement campaign,
- **3D model** of the line to be used in the Degraded Performance tool.
- **Run tables:** files created for each run, contain the information of the starting and end time of the run, and the itinerary for the run (track list). There is one of these files for each run to be analysed.

```

RunTable0001: Bloc de notas
Archivo Edición Formato Ver Ayuda
Run #0001
# Almorchon - Alhondiguilla
# Maybe some more human readable information about the run can go here...
# Everything after a '#' will be ignored by the tools
# This was the first run in this campaign.
# Time in GPS time
Starting time: 20.05.2019 14:19:00
End time: 20.05.2019 16:52:00
Track List: 24,45,56,67,78,89,100,112
  
```

Figure 59 Example of Run Table file

- **NLOS visual**, if available  
Images acquired with the fish-eye camera are processed separately. The different steps of the process are: image processing in order to classify regions between sky and non-sky areas; satellite positioning in the image for identification of the sky area class. The results file contains each satellite state of reception (LOS/NLOS) for each epoch.
- **Track maps**: set of files with the coordinates of the different sections of the track. To create the track maps, the track is divided in section and nodes, as shown in the diagram below:

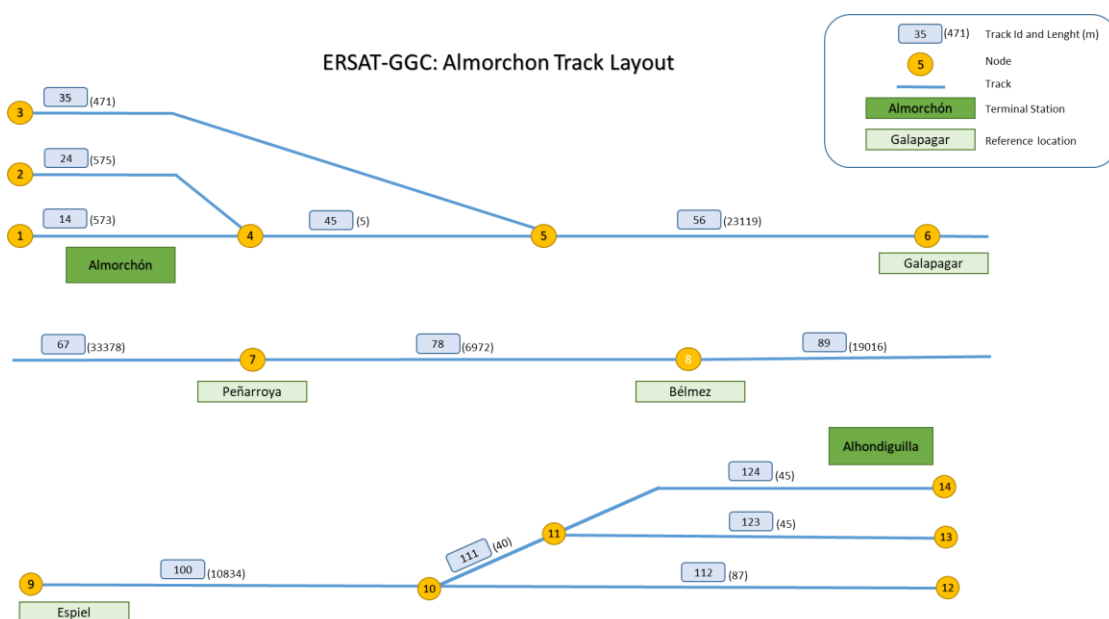

Figure 60 Track Layout

The files created to provide the Track Maps are:

- **Node table:** this is the list of nodes and track IDs that each one connects
- **Track Table:** it is the list of relevant Track IDs, with its connecting nodes
- **Reference Position file for each Track Section:** it contains the coordinates for each track ID

NodeID	TrackIDs
1	14
2	24
3	35
4	14,24,45
5	45,35,56
6	56,57
7	67,78
8	78,89
9	89,1
10	100,111,112
11	111,113,114
12	112
13	113
14	114

Figure 61 Node table file sample

TrackID	node1	node2	MinLat	MaxLat	MinLon	MaxLon	MinAlt	MaxAlt	Length
14	1	4	38,6957104	38,6964112	-5,29717172	-5,29062067	598,51703	599,190227	574
24	2	4	38,6957034	38,6962082	-5,29716198	-5,29184228	599,433809	599,694253	466
45	4	5	38,6956989	38,6957031	-5,29722345	-5,29716604	599,669761	599,696558	6
56	5	6	38,5266118	38,6956979	-5,34099853	-5,29723335	476,206901	599,979588	23092
67	6	7	38,291758	38,5266057	-5,35576834	-5,27368559	521,85755	648,15554	33359
78	7	8	38,2626231	38,2917535	-5,27367592	-5,20724461	549,900046	589,468309	6974
89	8	9	38,1765879	38,2626205	-5,20723752	-5,04698072	496,453734	552,776816	18969
100	9	10	38,1208994	38,1765872	-5,04698024	-4,9528207	504,423501	519,494063	10835
111	10	11	38,1207349	38,1209047	-4,95281356	-4,95240984	505,009129	505,205905	40
112	10	12	38,1204649	38,1208952	-4,95281262	-4,95199156	505,685031	505,907964	87
123	11	13	38,1205076	38,1207364	-4,95241027	-4,95197061	502,361002	502,364671	47
124	11	14	38,1205563	38,1207349	-4,95240984	-4,95198398	504,876108	505,009129	46

Figure 62 Track Table file sample

PosID	LeftDist	RightDist	Lat	Lon	Alt	ECEF-X	ECEF-Y	ECEF-Z
0	0	573	38,6964112	-5,29062067	599,190227	4963698,18	-459648,819	3966444,05
1	1	572	38,69641	-5,29063162	599,198319	4963698,18	-459649,754	3966443,96
2	2	571	38,6964089	-5,29064218	599,198034	4963698,17	-459650,673	3966443,86
3	3	570	38,6964077	-5,29065416	599,203066	4963698,16	-459651,719	3966443,76
4	4	569	38,6964064	-5,29066599	599,215769	4963698,17	-459652,753	3966443,66
5	5	568	38,6964052	-5,29067725	599,225691	4963698,16	-459653,735	3966443,56
6	6	567	38,696404	-5,29068872	599,224413	4963698,16	-459654,739	3966443,45
7	7	566	38,6964027	-5,29070038	599,241561	4963698,16	-459655,758	3966443,36
8	8	565	38,6964014	-5,29071219	599,241838	4963698,16	-459656,789	3966443,24
9	9	564	38,6964002	-5,29072385	599,242401	4963698,15	-459657,809	3966443,13
10	10	563	38,6963989	-5,29073556	599,249454	4963698,15	-459658,83	3966443,03
11	11	562	38,6963976	-5,29074704	599,256086	4963698,15	-459659,835	3966442,92
12	12	561	38,6963964	-5,29075862	599,245474	4963698,14	-459660,848	3966442,8
13	13	560	38,6963952	-5,29076988	599,236533	4963698,12	-459661,829	3966442,7
14	14	559	38,696394	-5,2907813	599,24233	4963698,11	-459662,825	3966442,6
15	15	558	38,6963928	-5,29079299	599,252207	4963698,11	-459663,847	3966442,5

Figure 63 Reference Position file sample





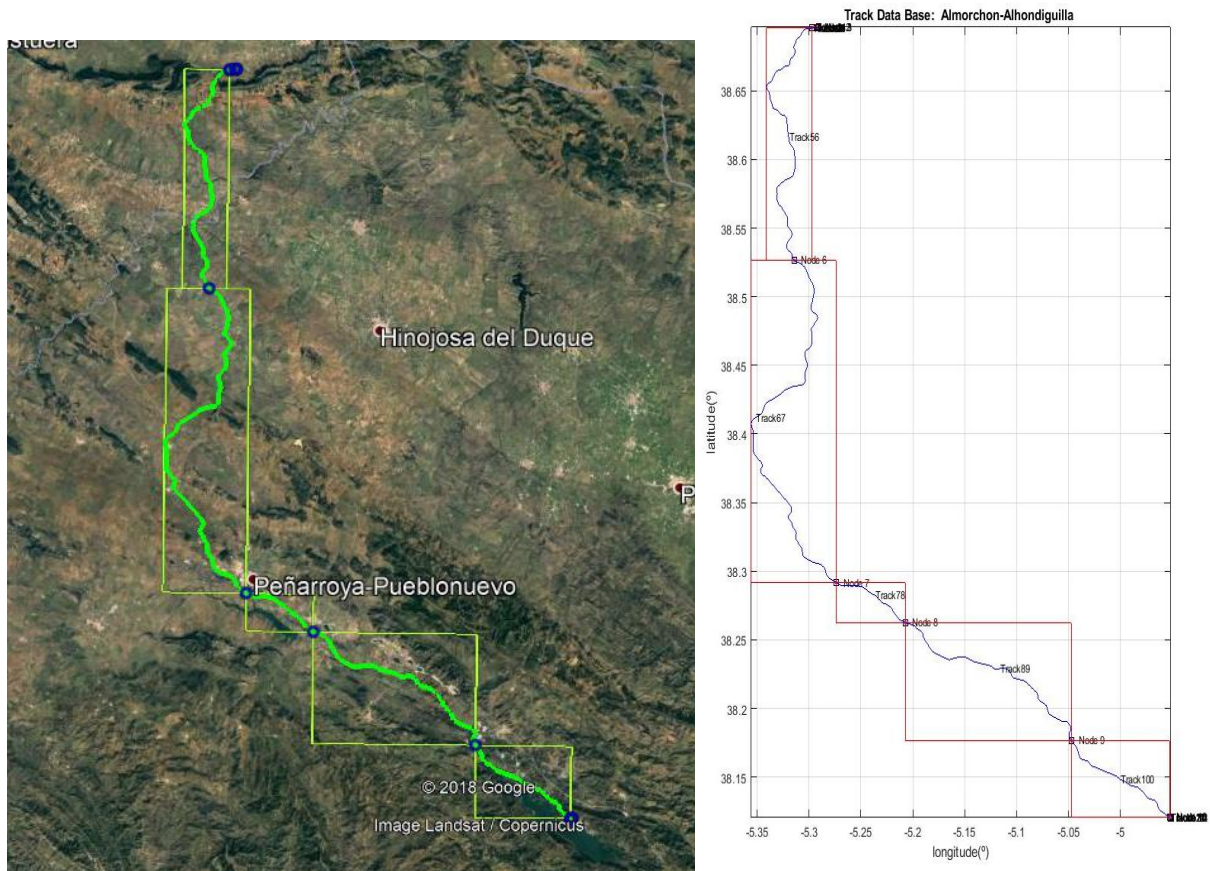

Figure 64 Track map representation and Track IDs

Once all the data necessary for the Toolset were stored and organized, the Toolset was run, in the following steps, to finally obtain the classification for the Spanish line.

## 6.3 PRE-PROCESSING

The data were processed in two sets:

- **Calibration Phase:** First, the Calibration Phase was performed: The static tests results from open-sky location were pre-processed and the calibration process was executed for each technique (Interference AGC, Interference PSD, Multipath CN0, Multipath CMCd and Multipath/NLOS Residuals) This calibration is performed once and stored for all the next analysis of the campaign.



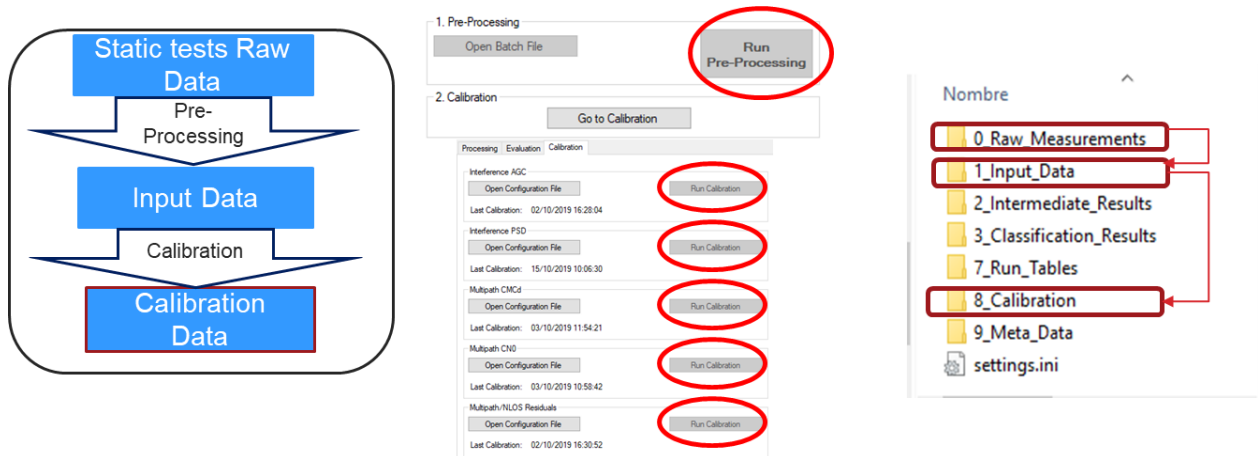

Figure 65 Pre-processing of calibration data and calibration execution for each technique

- **Pre-Processing of run files phase:** In this step, the Pre-processing of the raw data obtained during the **dynamic tests** performed during all the campaign is performed. The Input\_Data files are obtained, ready for performing the detection phase.

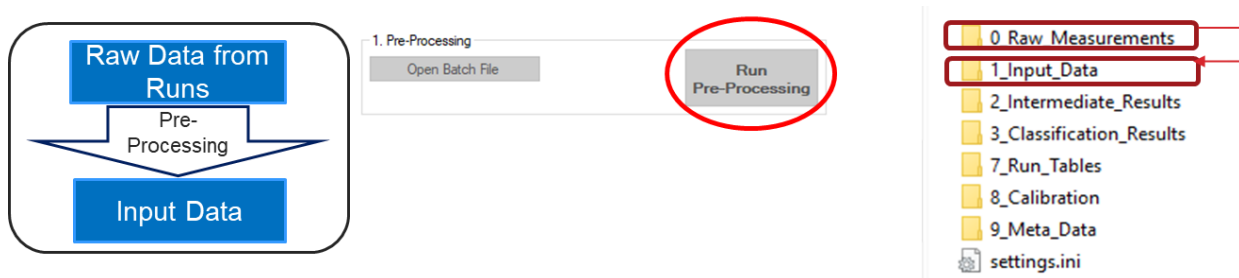

Figure 66 Pre-processing of dynamic tests data

## 6.4 DETECTION & SIMULATIONS PROCESS

After the pre-processing, the **Detection process** is executed. This step analyses the dynamic runs and the calibration results to obtain the Intermediate Results, with are the input for the next classification step.

At this stage, the simulations with the Degraded Performance Tool can be started and simulations can be done to obtain the degraded performance files which are also an input for the classification.



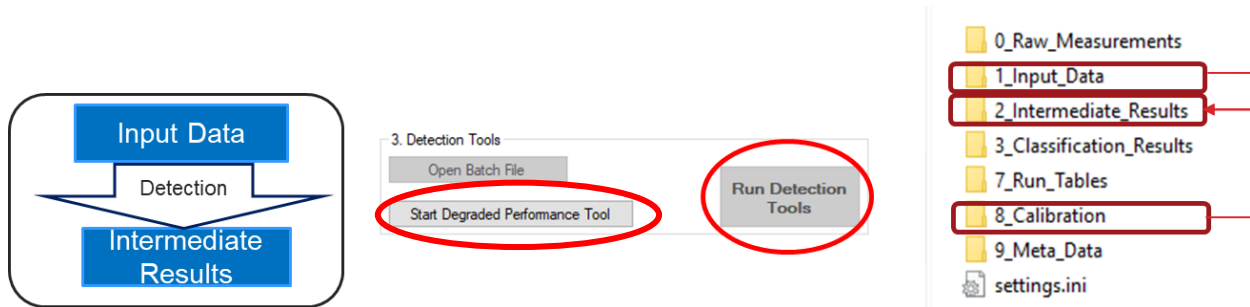

Figure 67 Detection process

The generation of the Degraded Performance file for this analysis was done by using the Degraded Performance Tool considering the following data:

Study Name: almorchonDayFinal  
 Study Type: Track Temporal Study  
 Date: 2019-05-31T09:00:00.254Z +1.0D  
 Time Interval: 900 s  
 GNSS Config: GALILEO/GPS  
 Almanac (GALILEO): \NAVTOOLS\CacheAlmanacs\galileo\2019-05-31.xml  
 NAGUs:  
 Almanac (GPS): \NAVTOOLS\CacheAlmanacs\gps\2019-05-31.txt  
 NANUs:  
 Val. Time Frame (%): 100.0  
 Val. SubInterval (%): 100.0  
 Min Satellites: 6  
 Max HDOP: 2.0  
 Mask angle (°): 5  
 Date: 2019-05-31T09:00:00.270Z  
 Study Type: Track Temporal Study  
 Railway: Almorchón  
 Antenna Height (m): 3.5  
 Elev. Crit.: Use railway elevations  
 OM (km): 1.1021049679772266  
 EM (km): 13.549806743756994  
 EL (km): 33.48192270165759

Then, the generated is exported to almorchonFinalReport\_c.csv to be used by the Toolset.



## 6.5 CLASSIFICATION PROCESS

Once all the data have been pre-processed, detection tool has been executed, and degraded performance file is available, the classification process can be accomplished.

**In the Classification** process, the user can choose the number of runs to be classified. Individual runs have been classified in first place, and grouped runs have been classified to obtain the final results for evaluation.

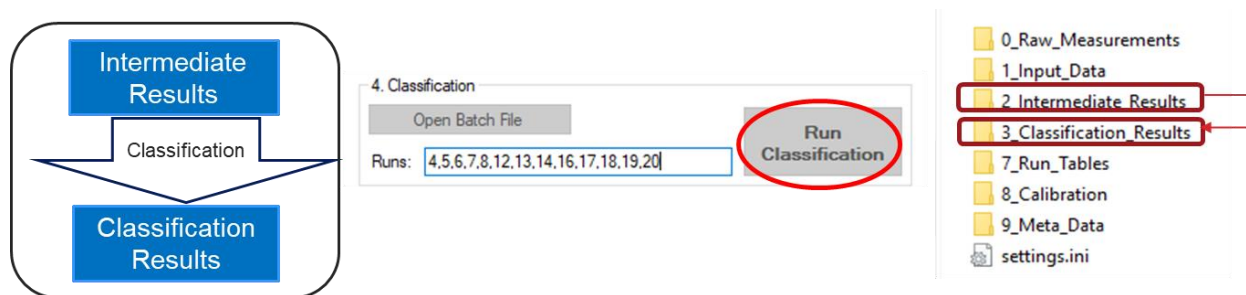

Figure 68 Classification process

## 6.6 EVALUATION OF RESULTS

After the classification process, the data were ready for evaluation.

The **Evaluation Process** gives the results for the selected run or group of runs for all the applicable track maps and for all the techniques.

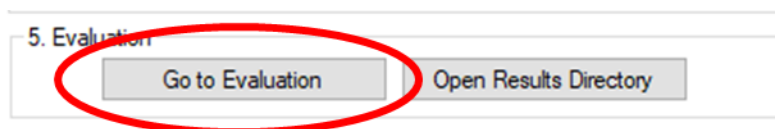

Figure 69 Evaluation process



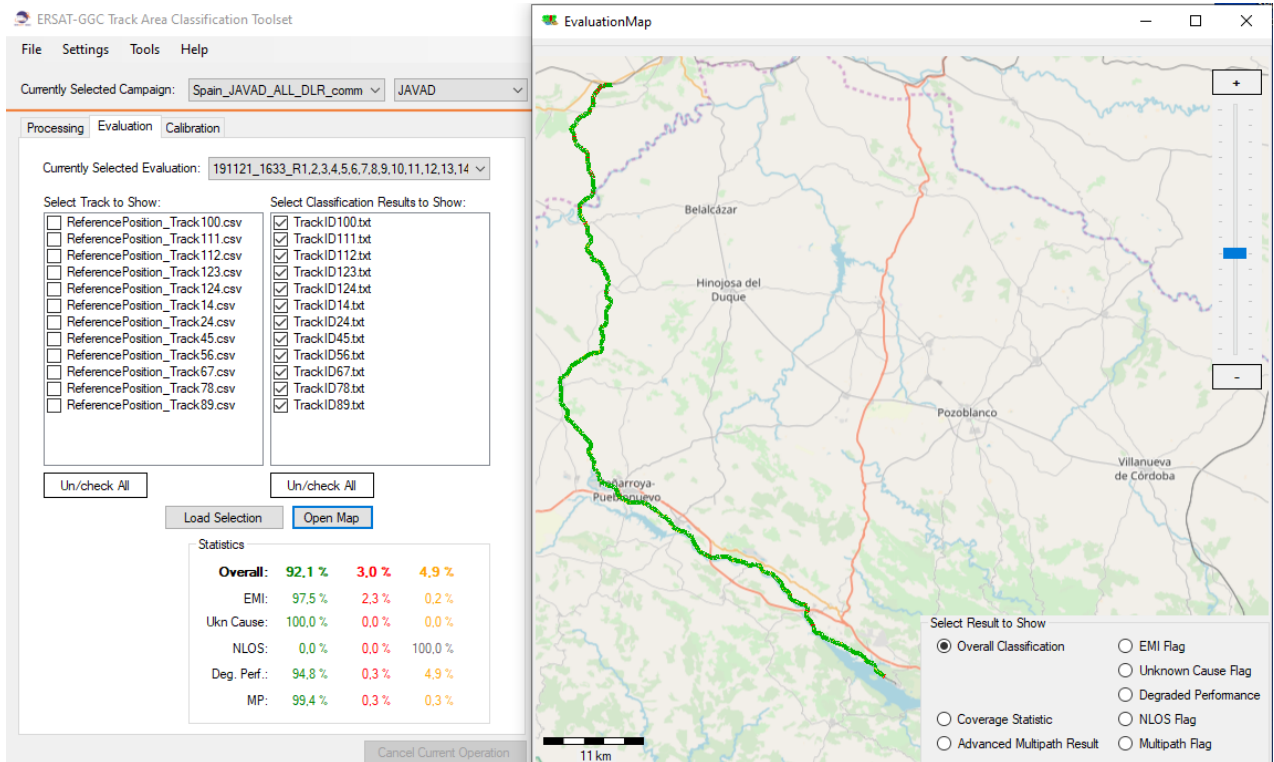

Figure 70 Example of Evaluation tab result in Toolset GUI

**For the Spanish Campaign result analysis, the following strategy has been followed:**

- 1- Analysis of **individual runs** has been done, to evaluate the quality of each run.
- 2- Analysis of **grouped runs** has been done, to evaluate the complete line. The runs were grouped in groups of five runs, and then, all the twenty runs were grouped together.

For the Spanish Test Campaign the grouped runs finally selected are Runs 1, 2, 3, 4, 5, 6, 7, 8, 9, 10, 11, 12, 13, 14, 15, 16, 17, 18, 19 and 20.

For individual runs the results showed that there is not enough information to classify the track areas, and the results are mainly 'yellow' areas.



For one run (Run1):

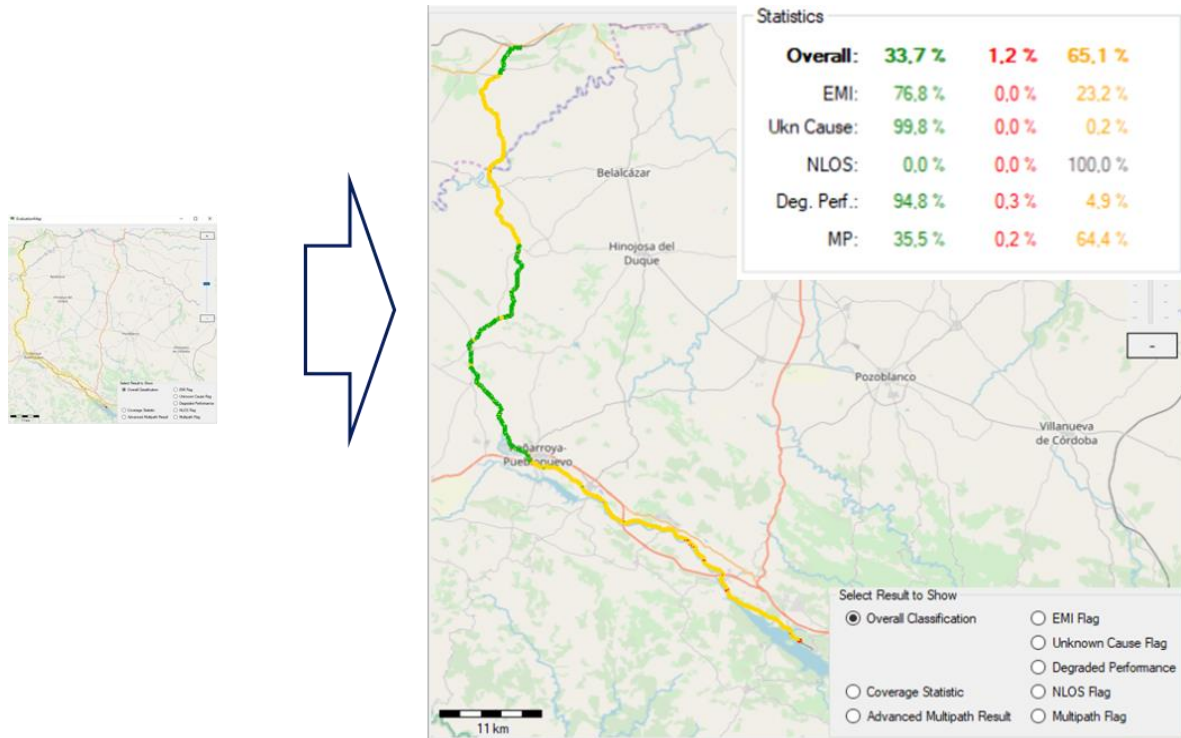

Figure 71 Example of results for single run

For grouped runs 1, 2, 3, 4, 5 as it can be observed in the following overall results, the results are mainly 'green' areas but 20% of the line is still not characterized (yellow).



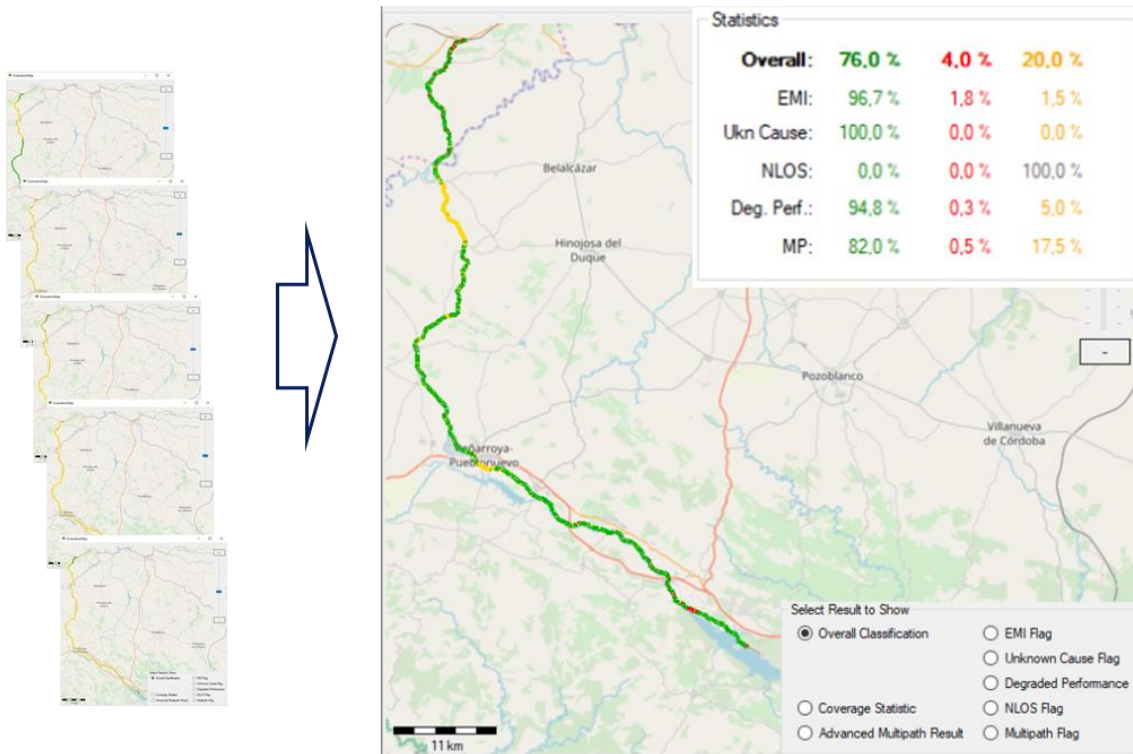

Figure 72 Example of results for five runs

For grouped runs 1, 2, 3, 4, 5, 6, 7, 8, 9, 10, 11, 12, 13, 14, 15, 16, 17, 18, 19, 20 the results are mainly 'green' areas and only 5% is not characterized (yellow).

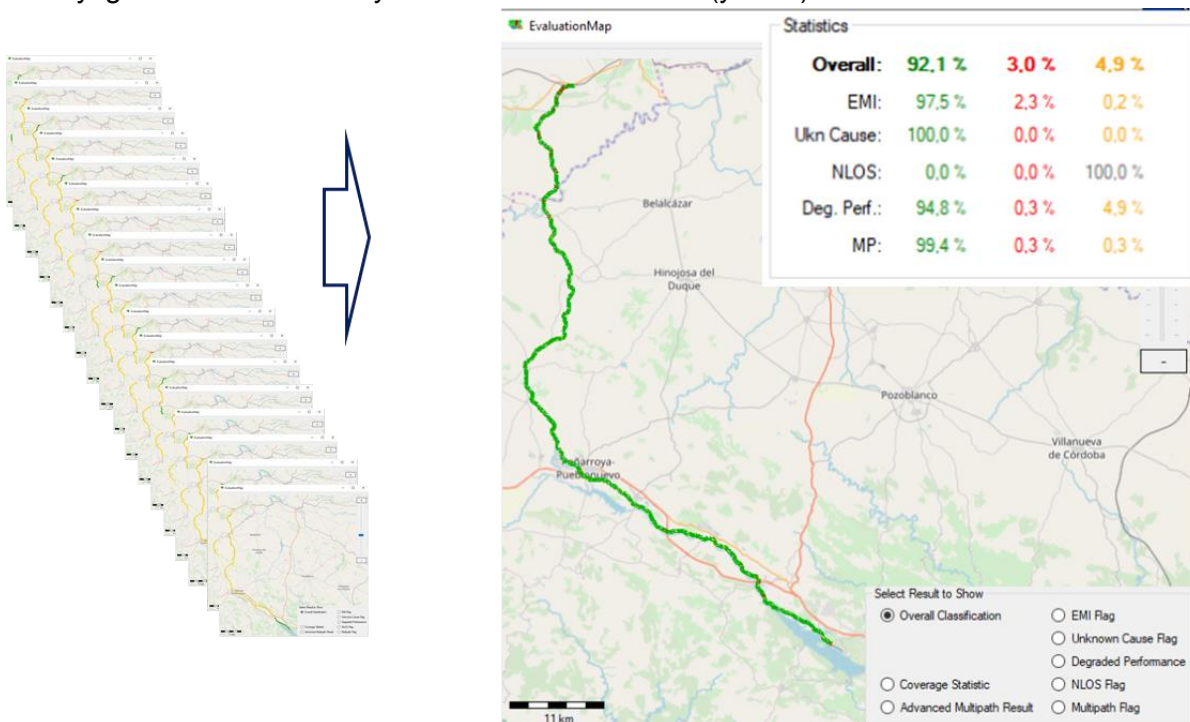

Figure 73 Example of results for all the runs



Additionally, a study of the different detection methods has been performed, to evaluate them separately:

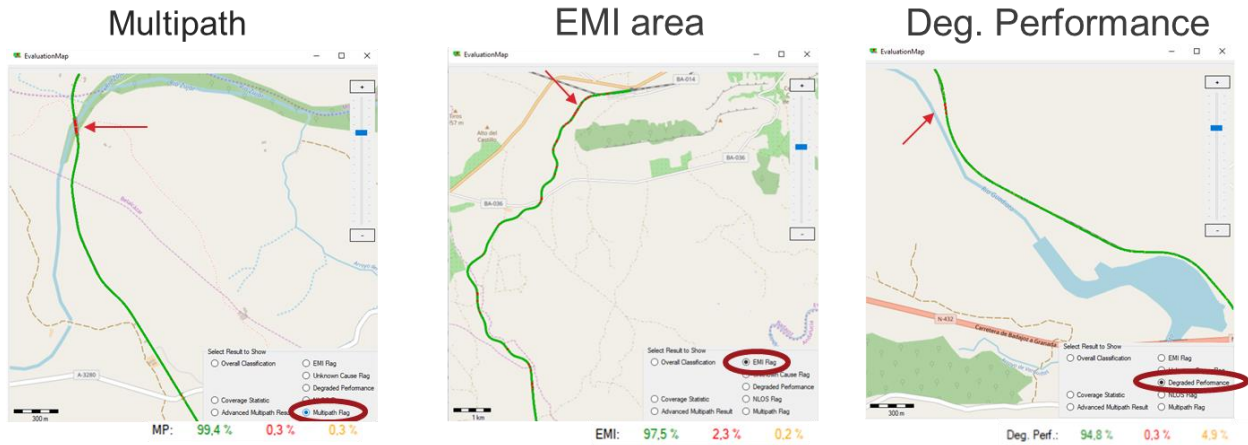

Figure 74 Example of evaluation for each detection method

As the line is mainly an open sky line, with barely few buildings along the line and no urban areas, it was expected that the track areas were classified mainly as 'Green', and that multipath could occur at few points of the line due to bridge structures, road overpasses, trenches and tree canopy. This was confirmed after applying the Toolset for the final evaluation. Some particular examples are shown below.





The area of the metallic bridge over Zújar River is classified as 'Red' area due to multipath, as expected:

Data	
Longitude	-5,330842626
Latitude	38,57645589
Direction	From North to South
	From South to North
Local Environment	Bridge (metallic structure)

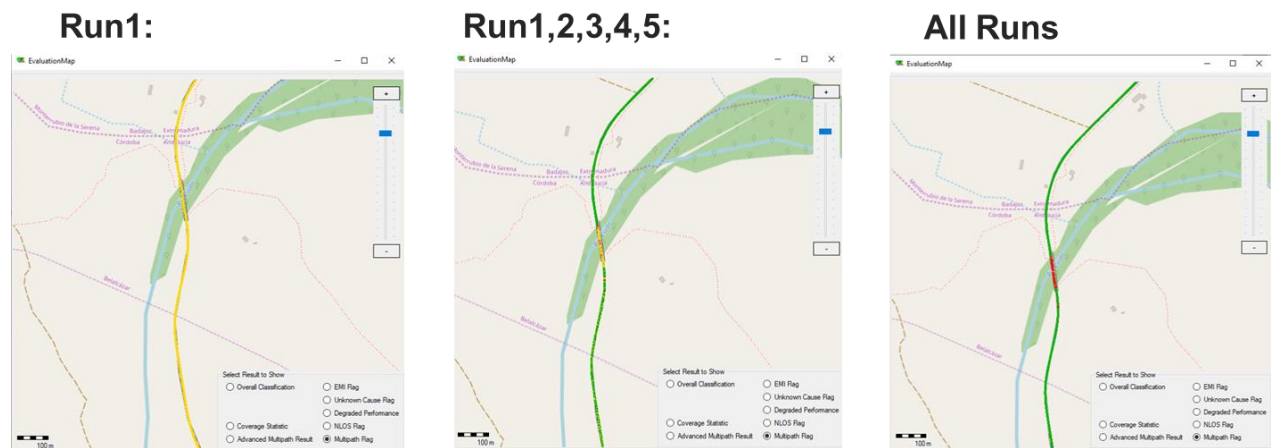

Figure 75 Example of evaluation for Metallic bridge



The area of the road over pass in the north part of the line is classified as 'Red' area due to multipath, as expected:

Data	
Longitude	-5,322681337
Latitude	38,56020817
Direction	From North to South
	From South to North
Local Environment	Road Overpass

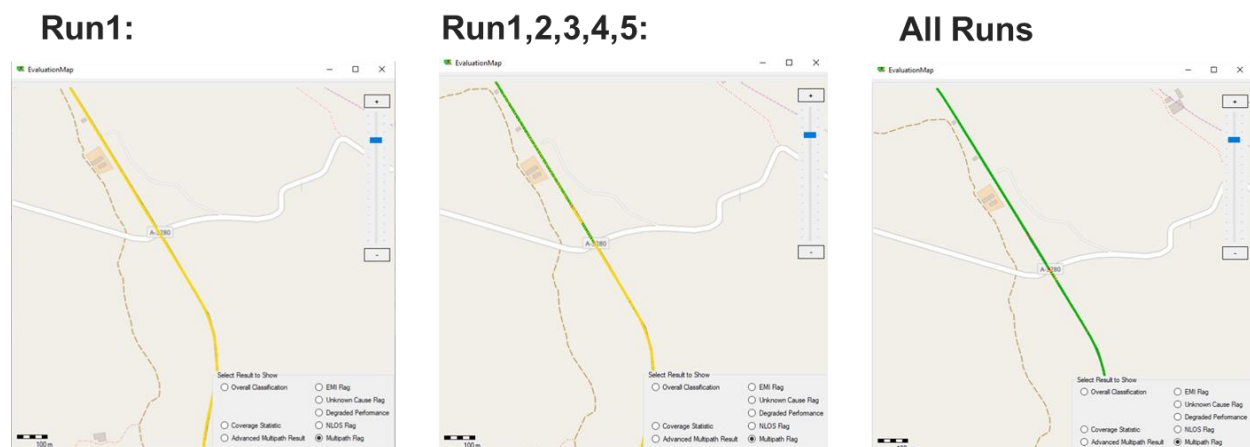

Figure 76 Example of evaluation for Road overpass



The area Forest, trench and tree canopy is classified as 'Red' area due to multipath:

Data	
Longitude	-5.06190923
Latitude	38.19293634
Direction	From North to South
	From South to North
Local Environment	Forest, trench and tree canopy



Figure 77 Example of evaluation for Tree canopy area



As a summary, the final classification is shown below:

## Overall for all Runs

Metallic Bridge

Road Overpass

Trench and tree canopy

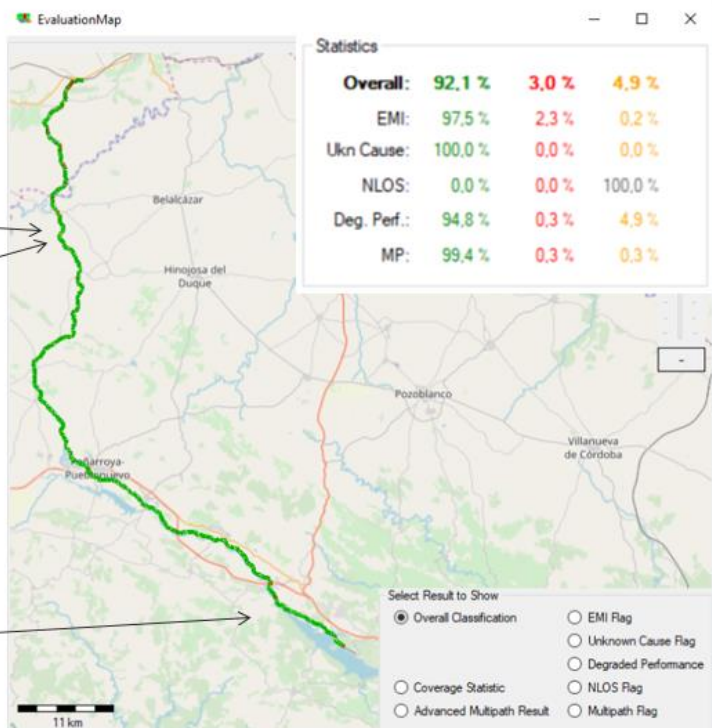

Metallic Bridge



Road Overpass



Trench and tree canopy



Figure 78a. Summary of different areas classification





Figure 79b. Summary of different areas classification

Finally, as presented for the Italian line, an example of the effect of the application of the smoothing of the results along the track areas is provided in Figure 80, where we can see the overall results after the combination of the different hazard causes results without the application of the smoothing on the left side of the figure.

Please note the intermittent presence of red results. On the same Figure 80 on the right, we can see the output with a 20m distance smoothing.



Figure 80 Results without (left) / with (right) protection distance smoothing (20 meter)

Adding the smoothing with this protection distance gives us a more realistic insight about the percentage of green areas where VBs could be safely placed. In Table 4 we can see the overall results after the combination of the different hazard causes classification results. In Table 5, we can see the final results after the application of 20 m protection distance smoothing.



Table 4 Overall Spanish Classification Results after combination of different hazard causes

Statistics	Green	Red	Yellow
<b>Overall:</b>	<b>96,9 %</b>	<b>3,0 %</b>	<b>0,2 %</b>
EMI:	97,5 %	2,3 %	0,2 %
Ukn Cause:	100,0 %	0,0 %	0,0 %
NLOS:	0,0 %	0,0 %	100,0 %
Deg. Perf.:	99,7 %	0,3 %	0,0 %
MP:	99,4 %	0,3 %	0,3 %

Table 5 Final Spanish Classification Results after 20m distance smoothing

Statistics	Green	Red	Yellow
<b>Overall:</b>	<b>93,6 %</b>	<b>5,6 %</b>	<b>0,8 %</b>
EMI:	97,5 %	2,3 %	0,2 %
Ukn Cause:	100,0 %	0,0 %	0,0 %
NLOS:	0,0 %	0,0 %	100,0 %
Deg. Perf.:	99,7 %	0,3 %	0,0 %
MP:	99,4 %	0,3 %	0,3 %

As conclusions for the Spanish Measurement Campaign, the process defined within the project has been followed, and the Toolset developed within the project has been used over different set of data from Spanish campaign. Processing both individual and multiple runs classifications allows further analysis and diagnosis of the data. It has been observed that the classification results improve as more runs are considered, so the classification was done with all the runs of the campaign, which recorded at different epochs.

It was observed that for the Spanish Test campaign, the final classification results were in general consistent with the characteristics of the surveyed line (large open sky areas).



## 7. SUMMARY OF PROCESS EXECUTION

---

The track area classification process is composed of two major steps: The activities related to the acquisition of measurement data and the processing of this data by a software toolset to obtain final classification results over a certain or multiple track lines.

With respect to the process related to the acquisition of the relevant data, the field measurement campaigns have been carried out in three countries and scenarios (i.e. Italy, Spain and France) with the necessary measurement equipment satisfying the main requirements. The main measurement equipment consisted in GNSS COTS receivers that were able to record GNSS raw data and RF signal information (AGC, PSD). The measurement campaigns were planned and carried out with enough temporal diversity to cover properly the GPS constellation revolution (24 hours as for the Italian campaign) or even the Galileo revolution (over 10 days in the Spanish campaign).

The recorded data in Italy and Spain were processed with the software Toolset developed during the project and described in Section 3. The execution of the data processing has been performed successfully by different partners of the consortium, not only the software developers but also the testing laboratories. This has confirmed the operability of the process by railway users. The results of the processing showed that the classification process and related Toolset is able to provide the required classification results satisfying the high level requirements.

The execution of the process showed how the results obtained with only one single set of data (i.e., run) is providing a high number of yellow areas. That is, there is not enough information to determine if some areas must be classified as red or green but the yellow provides a result that protects against the lack of statistical data. As more data from different runs are combined, the results converge to a classification of the considered lines improving the availability (i.e., less yellow areas) of the results.

As a qualitative validation of the process results, the Toolset successfully provided a classification of red over areas where it is expected the presence of some type of hazard causes (e.g. due to tunnels, near high buildings, partially covered stations, etc.).

## 8. CONCLUSIONS

In the last ten years, many R&D projects have investigated the use of the GNSS Positioning technology in safety of life applications. In particular, the GNSS Positioning has also been recognized as a key enabler technology for introducing the concept of virtual balise into the Control-Command and Signalling Class A ERTMS system. Many projects have been sponsored by GSA, ESA, and Member State R&D organizations to qualitatively and quantitatively identify the best architectures<sup>1</sup> and designs to enable the introduction of this technology and the virtual balise concept limiting the impact on the existing ERTMS Standard.

The ambitions of the recent initiatives such as the S2R TD2.4 Fail-Safe Train Positioning project (started with the S2R X2R2 project), the GSA ERSAT-GGC project, the ESA SBS RailS Phase 2.1 project, and the Rete Ferroviaria Italiana ERSAT program are to investigate possible proposals for new ERTMS specifications that (a) also foresee the use of the GNSS based Virtual Balises, (b) still provide the SIL 4 Train position function, and (c) guarantee the ERTMS backward compatibility and interoperability requirements.

Any ERTMS On-board Unit compliant with this new ERTMS specifications can safely run on an ERTMS trackside compliant with this new ERTMS specifications, with the minimum **performance** required for the interoperability, provided that the ERTMS trackside has been designed and developed to enable any “compliant” ERTMS On-board Unit to provide the protections against GNSS system and local hazard causes, i.e. events whose occurrences can lead to **hazardous consequences**. These protections work safely and properly only if the Virtual Balise Reader (VBR) error models and the GNSS monitoring techniques, implemented in the VBR to bound the virtual balise location determination errors, are valid along all the track areas where the train can run.

ERSAT-GGC is **the first project** that addresses the aspects of the classification of the track areas, where virtual balises can be (logically) placed, to **a priori prevent** the risk that **area environmental permanent properties** with respect to **sky visibility, multipath, NLOS, and in-band and near out-of-band interference** lead to **unbounded** virtual balise location determination errors.

To guarantee the classification of track area as suitable or not suitable for the placement of virtual balises, this classification must be done by using a **standard track area classification process**, where standard means that a trackside subsystem, designed with virtual balises located in track areas classified as suitable by the application of this process, guarantees a safe and dependable run, with the minimum **performance** required for the interoperability, of any ERTMS On-board Unit compliant with the new ERTMS specifications. In other words, the application of this standard process for classifying the track areas as suitable or not suitable for locating the virtual balises must not introduce technical barriers to access the railway infrastructure and, thus, to reach an interoperable solution. For example, track areas within tunnels or deep canyons (e.g. where the on-board GNSS antennas are located below the level of the side surface of canyons), with sources of radio frequency interferences higher than the allowed masks, with high buildings close to track rails must be **excluded a priori** for locating virtual balises.

However, the complexity around the definition and the validation of this standard process is exacerbated by **the lack of the Railway Minimum Operational Performance Standards** (Railway MOPS) that will describe both (a) the models of estimating pseudorange and position

---

<sup>1</sup> This is also the main objective of the ERSAT-GGC WP 2 and WP 3.



domain position errors and (b) the methods of calculating the railway protection level, based on pseudo range data, augmentation data, autonomous fault detection capability, etc. to bound local and system hazard causes as well as their residual errors.

The work of WP4 in ERSAT GGC has positively addressed the complex environment related to the standard classification process by providing:

- The high level requirements of the classification process;
- A description of the suitable approaches to assess the GNSS SIS along a railway track with respect to the local hazard causes;
- A complete methodology to classify the track areas according to the presence of individual local hazard causes.



## 9. REFERENCES

---

- [1] ERSAT-GGC, "D4.1 Procedure Specification Document," 2018.
- [2] ERSAT-GGC, "D.4.2 Technical Specification of Survey Toolset," 2018.
- [3] ERSAT-GGC, "D4.3 Prototype Implementation of the Survey Toolset," 2019.
- [4] ERSAT-GGC, "D4.4 Measurement Campaign Report," 2019.
- [5] ERSAT-GGC, "D2.1 - Enhanced Functional ERTMS Architecture Capable of using GNSS and Public Radio TLC Technologies," 2018.
- [6] O. Garcia Crespillo, A. Konovaltsev, J. Marais, S. Sabina, A. Vennarini, A. Coluccia, A. Neri, A. Aguila, E. Razzano, F. Ranauro and M. Ciaffi, "Local GNSS Threat Detection Methods for Virtual Balise Placement in Railway Applications," in *16th International Conference on Intelligent Transportation Systems Telecommunications (ITST)*, Lisbon, 2018.

