



HAL
open science

SLX4: multitasking to maintain genome stability

Jean-Hugues Guervilly, Pierre-Henri Léon Gaillard

► **To cite this version:**

Jean-Hugues Guervilly, Pierre-Henri Léon Gaillard. SLX4: multitasking to maintain genome stability. *Critical Reviews in Biochemistry and Molecular Biology*, 2018, 53 (5), pp.475-514. 10.1080/10409238.2018.1488803 . hal-02397875

HAL Id: hal-02397875

<https://hal.science/hal-02397875v1>

Submitted on 21 Dec 2020

HAL is a multi-disciplinary open access archive for the deposit and dissemination of scientific research documents, whether they are published or not. The documents may come from teaching and research institutions in France or abroad, or from public or private research centers.

L'archive ouverte pluridisciplinaire **HAL**, est destinée au dépôt et à la diffusion de documents scientifiques de niveau recherche, publiés ou non, émanant des établissements d'enseignement et de recherche français ou étrangers, des laboratoires publics ou privés.



SLX4: Multitasking to maintain genome stability

Journal:	<i>Critical Reviews In Biochemistry & Molecular Biology</i>
Manuscript ID	BBMG-2018-0025
Manuscript Type:	Review
Date Submitted by the Author:	24-Apr-2018
Complete List of Authors:	Gaillard, Pierre-Henri; Centre de Recherche en Cancerologie de Marseille Guervilly, Jean-Hugues; Centre de Recherche en Cancerologie de Marseille
Keywords:	genome stability, structure-specific endonuclease, Fanconi anemia, replication stress, telomere maintenance, interstrand crosslink repair, DNA damage response, DNA repair and recombination

SCHOLARONE™
Manuscripts

SLX4: Multitasking to maintain genome stability

Jean-Hugues Guervilly and Pierre-Henri L. Gaillard*

CRCM, CNRS, INSERM, Aix Marseille Univ, Institut Paoli-Calmettes, 27 boulevard Lei Roure, 13009 Marseille, France

*pierre-henri.gaillard@inserm.fr

Abstract:

The SLX4/FANCP tumor suppressor has emerged as a key player in the maintenance of genome stability, making pivotal contributions to the repair of interstrand crosslinks, homologous recombination and in response to replication stress genome wide as well as at specific loci such as common fragile sites and telomeres. SLX4 does so in part by acting as a scaffold that controls and coordinates the XPF-ERCC1, MUS81-EME1 and SLX1 structure-specific endonucleases in different DNA repair and recombination mechanisms. It also interacts with other important DNA repair and cell cycle control factors including MSH2, PLK1, TRF2 and TOPBP1 as well as with ubiquitin and SUMO. This review aims at providing an up to date and comprehensive view on the key functions that SLX4 fulfills to maintain genome stability as well as to highlight and discuss areas of uncertainty and emerging concepts.

Keywords: genome stability, DNA repair and recombination, structure-specific endonuclease, Fanconi anemia, replication stress, telomere maintenance, interstrand crosslink repair, DNA damage response

Introduction:

The SLX4 protein is a scaffold for a number of proteins that have diverse functions in genome maintenance mechanisms and cell cycle control. This confers SLX4 with a pivotal role in different aspects of genome protection ranging from homologous recombination (HR), repair

1
2
3 of interstrand DNA crosslinks (ICLs) to mechanisms that help the cell cope with challenged
4 replication at both genome wide and loci specific levels. In the latter case, this concerns loci
5 such as common fragile sites (CFS) and telomeres. Recently, functional ties between SLX4 and
6 the control of the innate immune response have also been identified. We will see how many of
7 these functions rely on the ability of SLX4 to interact with structure-specific endonucleases
8 (SSE) and control this important class of enzymes. This feature, which is conserved from
9 yeast to man has been the most investigated function of SLX4. It does so in several ways
10 including the timely delivery of SSEs to ongoing repair mechanisms, adjusting their substrate
11 specificity and directly modulating their catalytic activity.

12
13
14
15
16
17
18 The contribution made by SLX4 to the maintenance of genome stability does not only rely on
19 its ability to bind and control SSEs. SLX4 also binds other scaffolds and this is turning out to
20 be important for the coordination of multiple genome maintenance processes. In particular,
21 pioneering studies in yeast have unraveled new roles for Slx4, some of which are independent
22 of its nuclease scaffold functions and have to do with the control of checkpoints in the
23 response to replication stress and DNA damage.
24
25
26
27
28

29
30 The importance of SLX4 in the maintenance of genome stability is underscored by the fact
31 that bi-allelic mutations in *SLX4* can cause Fanconi anemia (FA)(Kim et al. 2011; Stoepker et
32 al. 2011). FA is a rare genetic disorder associated with bone marrow failure, developmental
33 defects and a strong predisposition to cancer(Nalepa & Clapp 2018). Proteins encoded by FA
34 genes fulfill diverse functions in DNA damage signaling and repair. There are currently 21 FA
35 complementation groups, with *SLX4* defining complementation group P (FANCP).
36 Consistently, an *SLX4* mouse model has been generated that phenocopies FA and is cancer
37 prone(Crossan et al. 2011; Hodskinson et al. 2014). It is noteworthy that the *XPF* gene, which
38 encodes one of *SLX4* direct partners, itself defines complementation group Q(Bogliolo et al.
39 2013) and that a cancer-associated *SLX4*^{Y546C} variant(de Garibay et al. 2013) is defective in
40 interacting with XPF(Hashimoto et al. 2015). Tumor suppressive functions of *SLX4* are
41 further supported by the fact that it is found amongst a set of DNA repair genes frequently
42 altered over a broad spectrum of cancer types(Sousa et al. 2015). Furthermore, there is an
43 increasing number of cancer-associated germline and somatic mutations identified in *SLX4*,
44 although it remains to be established to what extent these contribute to the emergence
45 and/or the evolution of the disease.
46
47
48
49
50
51
52
53
54
55
56

1
2
3
4 This review aims at providing a comprehensive view on the key functions that SLX4 fulfills to
5 help maintain genome stability and to highlight areas of uncertainty and/or discrepancies in
6 the currently available literature. After a brief overview on Slx4 from both a historical and
7 evolutionary stance, the principal functions of SLX4 in genome protection will then be
8 discussed in separate sections. Since the functions fulfilled by SLX4 in different areas of
9 genome maintenance often rely on the same principles, whenever possible, ties between
10 independent sections will be highlighted. These sections will cover the role of SLX4 in HR, ICL
11 repair, the response to global and loci specific replication stress and its role in telomere
12 maintenance. Recent findings made in yeast on the functional ties between Slx4 and other
13 scaffold proteins, which position Slx4 at the interface of DNA repair machineries and signal
14 transduction pathways that coordinate progression of the cell cycle with DNA damage
15 recognition and repair, will also be discussed.
16
17
18
19
20
21
22
23
24
25
26
27

28 **SLX4 from yeast to man: evolutionary and structural considerations**

30 ***Slx4 in yeast***

31 Slx4 (Synthetic lethal of unknown function) was initially identified in *Saccharomyces*
32 *cerevisiae* along with its binding partner Slx1 in a synthetic lethality screen aimed at
33 identifying proteins essential for cell viability in absence of the Sgs1 helicase (Mullen et al.
34 2001). Sgs1 is a member of the RecQ family of helicases and is related to the human BLM
35 helicase that is deficient in patients suffering from the highly cancer prone Bloom syndrome.
36 BLM-related helicases fulfill important functions in various aspects of genome maintenance
37 where they are needed to unfold secondary DNA structures (Chu & Hickson 2009).
38
39
40
41
42
43

44 The identification of a conserved GIY-YIG nuclease domain in Slx1 and a putative DNA binding
45 SAP domain in Slx4 (Aravind & Koonin 2001), suggested early on that it may be involved in
46 the endonucleolytic processing of secondary structures that had not been unfolded by the
47 Sgs1 helicase. Studies in both *S. cerevisiae* and *S. pombe* confirmed that Slx1 is a *bona fide*
48 structure-specific endonuclease that cuts DNA with the polarity of a 5'-flap
49 endonuclease (Fricke & Brill 2003; Coulon et al. 2004). They also showed that although Slx1
50 itself is a nuclease, Slx4 is a robust co-activator of Slx1 and is essential for Slx1 to fulfill its
51
52
53
54
55
56
57
58
59
60

1
2
3 functions *in vivo*(Fricke & Brill 2003; Coulon et al. 2004). Both the catalytic activity of Slx1
4 and its association with Slx4 are essential to survive the absence of Sgs1 and Rqh1 (the fission
5 yeast ortholog of BLM) in *S. cerevisiae* and *S. pombe*, respectively(Fricke & Brill 2003; Coulon
6 et al. 2004). One reason behind this genetic interaction has to do with maintaining the
7 integrity of the ribosomal DNA (rDNA), which is made of tandem rDNA repeats and is prone
8 to programmed replication fork stalling at defined replication fork barriers as well as
9 unscheduled replication challenges(Kaliraman & Brill 2002; Coulon et al. 2004; Coulon et al.
10 2006). The Slx1-Slx4 endonuclease has been proposed to initiate a DNA recombination
11 process at stalled or converging replication forks that modulates the copy number of rDNA
12 repeats(Kaliraman & Brill 2002; Coulon et al. 2004; Coulon et al. 2006). However, the precise
13 function of Slx1-Slx4 at the rDNA remains poorly understood and it is not known whether it is
14 also needed for the stability of rDNA in other organisms.

15
16 Importantly, hints that Slx4 has broader functions than its partner Slx1, came with the
17 realization that *Slx4*-deleted cells are more sensitive than *Slx1*-deleted cells to a variety of
18 DNA damaging agents(Chang et al. 2002; Fricke & Brill 2003), (Huang et al. 2005; Lee et al.
19 2005). Another important finding was that Slx4 can associate with the Rad1-Rad10 structure-
20 specific endonuclease(Ito et al. 2001) and that it does so in a mutually exclusive manner with
21 Slx1(Flott et al. 2007). Slx4 plays a role in the repair of DSBs by single-strand annealing (SSA)
22 where it promotes the removal of 3' single-strand overhangs by Rad1-Rad10 (Flott et al.
23 2007; Li et al. 2008; Toh et al. 2010). Slx4 also turned out to contribute, independently of Slx1
24 and Rad1-Rad10, to the recovery from replisome stalling induced by Methyl-Methane-
25 Sulfonate (MMS)(Flott et al. 2007). We will see how this latter function relies on the timely
26 interaction between Slx4 and the Rtt107 and Dpb11 scaffolds, and how this impacts on the
27 dynamics of DNA damage checkpoint responses and the nucleolytic processing of
28 recombination intermediates as well as DNA ends at DSBs(Ohouo et al. 2013; Gritenaite et al.
29 2014; Dibitetto et al. 2015).

26 27 28 ***Evolution and structural considerations***

29
30 It is remarkable, from an evolutionary standpoint, how much the structure of SLX4 has
31 evolved and acquired the ability to interact with a large set of functionally distinct partners
32 (Figure 1). The minimal architectural module, which is shared by all SLX4 family members, is
33 represented by the *S. pombe* protein in Figure 1 and consists of the SAP domain followed by
34
35
36
37
38
39
40
41
42
43
44
45
46
47
48
49
50
51
52
53
54
55
56
57
58
59
60

1
2
3 the so-called conserved C-terminal domain (CCD) that drives its interaction with Slx1 and is
4 one of the most conserved domains in the SLX4 family (Figure 1). Identification of orthologs
5 of Slx4 in metazoan was achieved in several independent ways including database searches
6 with sequences of the fungal CCD and proteomics (Fekairi et al. 2009; Munoz et al. 2009;
7 Svendsen et al. 2009; Saito et al. 2009) (Andersen et al. 2009). Structures of a partial CCD
8 domain of Slx4 in complex with either full Slx1 or the RING domain of Slx1 were recently
9 described for proteins from *Candida glabrata* and *S. pombe*, respectively (Gaur et al. 2015;
10 Lian et al. 2016). The CCDs from *C. glabrata* and *S. pombe* contain five or four helices,
11 respectively (Gaur et al. 2015; Lian et al. 2016). The CCD displays some resemblance with the
12 protein-protein interaction FF domains, although it lacks some key residues of the FF
13 domain (Gaur et al. 2015). In both structures, interaction between Slx4 and Slx1 strongly
14 relies on hydrophobic interactions as well as on hydrogen bonding (Gaur et al. 2015; Lian et
15 al. 2016). Residues involved in both types of contact appear to be conserved throughout
16 evolution suggesting that the structures obtained with the *C. glabrata* and *S. pombe* proteins
17 are likely to provide structural information pertinent to the Slx4-Slx1 interaction in higher
18 eukaryotes. In the *C. glabrata* structure, which contains full length Slx1, the CCD lies in a cleft
19 between the RING and the GIY-YIG nuclease domain of Slx1 and is located away from the
20 predicted DNA-binding interface of Slx1 and probably does not form contacts with the
21 substrate (Gaur et al. 2015). Remarkably, it was reported in that study that Slx1 forms a non-
22 active homodimer and that it gets activated upon heterodimerization with Slx4 (Gaur et al.
23 2015). An important finding was that some aromatic residues of Slx1 are involved in both
24 homo and heterodimerization explaining why these two states of Slx1 were found to be
25 mutually exclusive (Gaur et al. 2015). Control of the balance between homo and
26 heterodimerization was proposed to contribute to the regulation of Slx1 (Gaur et al. 2015).
27 Although this is an appealing concept, it is difficult to reconcile with the fact that in yeast and
28 in mammals Slx1 appears to be unstable in absence of Slx4. Further work is needed to
29 determine whether homodimerization of Slx1 occurs *in vivo* in *C. glabrata* and whether it
30 might do so in other species.
31
32
33
34
35
36
37
38
39
40
41
42
43
44
45
46
47
48
49

50
51 The interaction between SLX4 and MUS81 in metazoan is mediated by the SAP domain of
52 SLX4. This came as a surprise given the fact that the yeast Slx4 proteins, which also contain a
53 SAP, do not directly interact with Mus81. It suggests that MUS81-binding properties of the
54
55
56
57
58
59
60

1
2
3 SAP of SLX4 were acquired through evolution. Moreover, this interaction appears to be
4 modulated by phosphorylation of SLX4 by CDK1 in or around the SAP domain (Duda et al.
5 2016). Importantly, a recent study uncovered the structure of an N-terminal DNA binding
6 domain of MUS81(Wyatt et al. 2017), revealing that some amino-acids critical for DNA
7 binding(Wyatt et al. 2017) overlap with residues required for interaction with SLX4(Nair et
8 al. 2014) . Thus, SLX4 is proposed to prevent or modulate MUS81 DNA binding and broaden
9 the substrate specificity and increase the catalytic activity of MUS81-EME1, possibly through
10 the relief of an auto-inhibition of the nuclease by this N-terminal domain of MUS81(Wyatt et
11 al. 2017).

12
13
14
15
16
17
18
19
20
21 In addition, there are three remarkable features that SLX4 has acquired through evolution.
22 The first feature is an N-terminal extension upstream of the SAP domain that contains an
23 increasing number of protein-protein interaction domains as we move up the tree of
24 evolution. As depicted in Figure 1, this has considerably expanded the repertoire of SLX4
25 binding partners.

26
27
28
29 A second feature is the acquisition within this N-terminal extension of a BTB oligomerization
30 domain. This confers the capacity of human SLX4 to homodimerize(Guervilly et al. 2015; Yin
31 et al. 2016). The interaction is mediated by a hydrophobic interface which involves a set of
32 highly conserved hydrophobic residues suggesting that BTB-mediated homodimerization
33 likely occurs with all SLX4 family members that have a BTB domain(Yin et al. 2016).

34
35
36
37 Dimerization of SLX4 is critical for a number of SLX4 functions. It is necessary for SLX4 foci
38 formation, suggesting that it contributes to the intra-nuclear dynamics of the protein. For
39 instance, a functional BTB domain is important for telomeric localization of SLX4 and its
40 associated SSE partners and mutations that prevent dimerization of SLX4 cause telomeric
41 instability(Yin et al. 2016). The BTB domain of SLX4 is also necessary for optimal ICL
42 repair(Kim et al. 2013; Guervilly et al. 2015; Yin et al. 2016), possibly through a role in
43 optimal binding to XPF(Andersen et al. 2009; Guervilly et al. 2015). It is noteworthy that a
44 rare breast cancer associated missense mutation converts the highly conserved glycine at
45 position 700 in the BTB to an arginine(Landwehr et al. 2011). Further work is required to
46 determine to what extent mutations in the BTB domain of SLX4 may contribute to tumor
47 emergence and/or unfavorable evolution of the disease.

1
2
3 The third important feature of SLX4 in higher eukaryotes is its ability to bind ubiquitin and
4 SUMO. Interestingly, current experimental evidence suggests that recognition of these closely
5 related modifications channels SLX4 and its partners down different routes. As discussed
6 later, ubiquitin binding mediated by the UBZ4 domain(s) is essential for the repair of ICLs and
7 has also been shown to contribute to the processing of HR-mediated DNA
8 intermediates(Lachaud et al. 2014). While the SIMs (SUMO-Interacting Motifs) of SLX4 may
9 also contribute to some extent to its ICL repair function, they are most important in the
10 replication stress response as well as for an efficient targeting of SLX4 to telomeres and DNA
11 damage (Guervilly et al. 2015; Ouyang et al. 2015; González-Prieto et al. 2015; Guervilly &
12 Gaillard 2016). The nature of the ubiquitylated and SUMOylated partners of SLX4 remains
13 elusive. Remarkably, the SIMs of SLX4 also mediate its specific interaction with the active
14 SUMO-charged form of the SUMO E2 conjugating enzyme UBC9, but not its unmodified or
15 SUMOylated forms. Furthermore, the SLX4 complex is tightly associated with SUMO E3 ligase
16 activity and SLX4 is capable *in vivo* of driving SUMOylation of its XPF partner and itself. Both
17 the SIMs and the BTB of SLX4 are needed for this activity(Guervilly et al. 2015). It currently is
18 unclear whether SLX4 itself can act as a SUMO E3 ligase or whether it acts as a cofactor of a
19 SUMO E3 ligase and further investigations are currently underway to better understand how
20 SLX4 promotes SUMOylation *in vivo*((Guervilly et al. 2015; Guervilly & Gaillard 2016) and our
21 unpublished data). It is worth highlighting the fact that whereas Slx4 in yeast does not appear
22 to interact itself with ubiquitin and SUMO, the *S. pombe* protein Slx1 was shown to interact
23 with SUMO via a conserved SIM(Lian et al. 2016) but the functional importance of this SIM
24 remains to be characterized. In *S. cerevisiae*, Slx1 also binds SUMO(Sarangi et al. 2014).
25 Interestingly, SUMOylation of the Saw1 scaffold protein, a direct partner of Slx4 in *S.*
26 *cerevisiae* reinforces its association with the Slx4-Slx1 complex although it is unclear whether
27 this relies on the Slx1-SUMO interaction.
28
29
30
31
32
33
34
35
36
37
38
39
40
41
42
43
44
45
46
47

48 **Homologous recombination**

49
50
51 The functions fulfilled by SLX4 during HR in vegetative cells and during meiosis mainly
52 rely on its capacity to drive the endonucleolytic processing of various secondary DNA
53 structures by its SSE partners. As discussed below, these structures are primarily single-
54
55
56

1
2
3 stranded 3' flaps and more complex branched structures such as D-loops and Holliday
4 junctions (Figure 2). It is noteworthy that a new role in HR is currently emerging for Slx4,
5 which can promote 5' to 3' resection at DSBs in yeast(Dibitetto et al. 2015; Liu et al. 2017).
6 This new function of Slx4, which for now has only been described in *S. cerevisiae* and
7 which does not seem to rely on its SSE partners, will be discussed in a later section of this
8 review.
9
10
11
12
13

14 ***SSA and removal of single-stranded 3' tails***

15
16 Early studies in *S. cerevisiae* showed that Slx4 is important for the removal by Rad1-Rad10
17 of 3' non-homologous flaps generated during the repair by single-strand annealing (SSA)
18 of DSBs between repeated sequences(Flott et al. 2007)(Figure 2A). A similar role is
19 necessary for efficient repair during gene conversion events involving a single 3' non-
20 homologous tail(Lyndaker et al. 2008).
21
22
23

24 The underlying mechanisms are still poorly understood. During SSA, formation by Rad52
25 of the DNA intermediate that results from the annealing of the homologous sequences and
26 formation of the 3'-non homologous tails is a critical step for the recruitment of Slx4(Toh
27 et al. 2010; Li et al. 2013). Slx4 is not essential for the recruitment of Rad1-Rad10 during
28 SSA in *S. cerevisiae*(Li et al. 2013), which is surprising given its established role in the
29 recruitment of SSEs in mammalian cells. This is instead primarily achieved by the
30 structure-specific DNA binding scaffold Saw1 that forms a stable complex with Rad1-
31 Rad10(Li et al. 2008; Li et al. 2013). It is unclear whether Slx4 recognizes and binds to a
32 specific DNA secondary structure or whether it is recruited via direct interaction with
33 Rad1 and/or with Saw1 to which it can also bind directly(Saranghi et al. 2014).
34 Furthermore, although Slx4 is important for the efficient cleavage of the 3' flaps *in vivo* it
35 remains to be determined whether it directly stimulates Rad1-Rad10, especially given the
36 fact that Saw1 itself efficiently stimulates the processing of model DNA substrates by
37 Rad1-Rad10 suggesting that it might play a similar role *in vivo*(Li et al. 2013). Early on,
38 the pivotal contribution of Slx4 to SSA was shown to rely on its phosphorylation by Mec1
39 and Tel1(Flott et al. 2007). Accordingly, 3' non-homologous tail removal is severely
40 impaired in cells lacking Mec1 and Tel1 or in cells producing non-phosphorylatable Slx4
41 mutants, despite unaltered recruitment of Slx4(Toh et al. 2010). Furthermore,
42 dephosphorylation of Slx4 appears to coincide with repair of the DSB. More work is
43
44
45
46
47
48
49
50
51
52
53
54
55
56
57
58
59
60

1
2
3 needed to better understand how Slx4 contributes to efficient SSA. It also remains to be
4 determined whether SLX4 plays a similar role in metazoan. In that regard it is worth
5 highlighting the fact that the Msh2-Msh3 mismatch repair complex, which is a binding
6 partner of human SLX4, is recruited very early on during SSA in *S. cerevisiae*(Li et al.
7 2013). Msh2-Msh3 is believed to stabilize the annealed DNA intermediate structures
8 during SSA and is important for SSA between short repeats(Sugawara et al. 1997). To our
9 knowledge, no clear ortholog of Saw1 has yet been identified in higher eukaryotes.
10 Considering the central role played by Saw1 in orchestrating SSA in *S. cerevisiae*,
11 establishing direct contacts with Msh2, Rad1 and Slx4, and recruiting and stimulating
12 Rad1-Rad10, maybe in coordination with Slx4, it is tempting to speculate that in human
13 cells all of these functions might be fulfilled by SLX4 itself.

21 22 ***HJ resolution during HR***

23 In metazoans, one of SLX4's prevalent roles in HR is to promote the resolution of HJs and
24 probably other kinds of secondary DNA structures that are formed after the strand-
25 invasion step.

26 The timely processing of HJs before anaphase is essential to ensure proper chromosome
27 segregation. In vegetative cells, processing of double-HJs (dHJs), which form when both
28 ends of the DSBs engage in strand exchange during repair of DSBs(Kowalczykowski
29 2015)(Figure 2B), is thought to occur primarily by the so-called dissolution pathway
30 carried out by a complex made of a RecQ-like helicase, a type I topoisomerase and
31 accessory factors, such as the mammalian BTR complex (BLM-TOPOIII β -RMI1-RMI2). This
32 dissolution mechanism releases the two sister chromatids or homologous chromosomes
33 with no crossover (NCO) of large DNA segments(Kowalczykowski 2015)(Figure 2B). The
34 removal of dHJs can be achieved by an alternative pathway that relies on the dual incision
35 of exchanging strands by specialized SSEs named HJ resolvases. In contrast to the NCO
36 dissolution pathway, HJ resolution can generate NCO or cross-over (CO) products
37 depending on which pair of strands is processed on each HJ (Figure 2B). Accordingly, cells
38 lacking a functional BLM helicase, such as cells from Bloom syndrome (BS) patients, rely
39 on HJ resolvases for viability and present unusually elevated rates of sister chromatid
40 exchanges(Wechsler et al. 2011; Garner et al. 2013; Wyatt et al. 2013; Castor et al. 2013).
41 Thus, while HJ resolution is essential to remove isolated single HJs and is key to promoting

1
2
3 genetic diversity during meiosis, in vegetative cells, HJ resolving enzymes are kept under
4 tight control so that double HJs preferentially get dissolved by BLM-related
5 helicases((Matos et al. 2011; Gallo-Fernandez et al. 2012; Szakal & Branzei 2013; Dehé et
6 al. 2013), for review (Dehé & Gaillard 2017)).
7
8
9

10
11 In mammals, there are two main HJ resolution pathways that rely on the FEN1/XPG-
12 related GEN1 SSE or on SLX4 and its associated SSEs MUS81-EME1 and SLX1. GEN1
13 resolves HJs by a mechanism similar to what has been described for bacterial and phage
14 resolvases with the introduction of symmetrical cuts on opposing strands and the
15 production of nicked duplex products(Rass et al. 2010). In contrast, based on *in vitro* and
16 *in vivo* studies briefly overviewed below, SLX4-mediated HJ resolution appears to rely on a
17 more complex mechanism where SLX4 in association with SLX1 and MUS81-EME1 drives
18 the resolution of a HJ by coordinating a first cut by SLX1 with a second cut on the opposite
19 strand by MUS81-EME1(Svendsen et al. 2009; Wyatt et al. 2013; Castor et al. 2013). It is
20 noteworthy that SLX4 works with different sets of SSE partners to promote HJ resolution
21 in different organisms. In *D. melanogaster*, the SLX4 ortholog MUS312 interacts with the
22 XPF ortholog Mei9 to generate meiotic COs(Yildiz et al. 2002; Andersen et al. 2009) in a
23 way that does not rely on Mus81(Trowbridge et al. 2007). Similarly, the *C. elegans* SLX4
24 ortholog, named Him-18, drives the processing of recombination intermediates in meiosis
25 by XPF-1, SLX1-1 or MUS81-1(Saito et al. 2009; Agostinho et al. 2013; Saito et al. 2013).
26 Interestingly, while this essentially contributes to meiotic CO, an enigmatic anti-CO role of
27 SLX-1 has been described at the center of chromosomes(for review(Saito & Colaiácovo
28 2014)). In *S. cerevisiae*, Slx1-Slx4 has been reported to play a minor role in wild type
29 meiotic recombination(De Muyt et al. 2012; Zakharyevich et al. 2012).
30
31
32
33
34
35
36
37
38
39
40
41
42
43

44 ***The SLX1-SLX4-MUS81-EME1(SLX-MUS) HJ resolvase complex***

45 Evidence that SLX4-SLX1 and MUS81-EME1 work in the same HJ processing pathway
46 initially came from the analysis of their relative contribution to meiotic CO in *C. elegans*
47 and to the elevated rates of SCEs and chromosome instability in cells defective for BLM or
48 exposed to exogenous genotoxic stress that impede replication(Wechsler et al. 2011;
49 Agostinho et al. 2013; Saito et al. 2013; Garner et al. 2013; Wyatt et al. 2013; Castor et al.
50 2013). Those *in vivo* studies also provided the first hints for the need of an integral SLX-
51
52
53
54
55
56
57
58
59
60

1
2
3 MUS complex, by showing that loosing SLX1 or MUS81 or their ability to interact with
4 SLX4 reduces SCE rates to the same extent as loosing both nucleases or SLX4(Wyatt et al.
5 2013; Castor et al. 2013). However, this epistatic relationship in terms of SCE formation
6 shared by SLX1-SLX4 and MUS81-EME1 does not necessarily mean that *in vivo* they act on
7 the same HJ. Each could act on a different DNA structure within the same pathway and the
8 lack of one of the enzymes would be sufficient to prevent the pathway to be taken to
9 completion. The strongest support for an SLX-MUS HJ resolvase is provided with the
10 biochemical and functional analysis of a recombinant SLX-MUS holoenzyme produced in
11 insect cells. HJ resolution by this recombinant SLX-MUS complex relies on a nick and
12 counter nick mechanism where the first nick is made by SLX1 and the counter nick by
13 MUS81-EME1(Wyatt et al. 2013). Follow up studies focused on a so-called recombinant
14 SMX holoenzyme where SLX4 is now in complex with XPF-ERCC1 in addition to MUS81-
15 EME1 and SLX1. Interestingly, XPF was found to play a non-catalytic structural role that
16 stimulates MUS81-EME1 on various secondary structures including HJs, thus leading to
17 the suggestion that it contributes to HJ resolution by SLX4 in complex with SLX1 and
18 MUS81-EME1(Wyatt et al. 2017). However, the interaction between XPF and SLX4 is
19 dispensable for the viability of BLM-deficient cells and does not contribute to their high
20 SCE rate, suggesting that *in vivo* the interaction between SLX4 and XPF is in fact
21 dispensable for HJ resolution(Garner et al. 2013).
22
23
24
25
26
27
28
29
30
31
32
33
34
35

36 Formation of the SLX-MUS complex is cell-cycle regulated bringing further support to the
37 importance of such a complex *in vivo*. It requires both CDK1 and PLK1 activities and peaks
38 in G2/M before anaphase(Wyatt et al. 2013; Duda et al. 2016; Wyatt et al. 2017). Increased
39 phosphorylation of EME1 at the G2/M transition correlates with an enhanced association
40 of MUS81-EME1 with SLX4 and HJ resolving activity of SLX4 and MUS81
41 immunoprecipitates(Matoss et al. 2011; Wyatt et al. 2013; Laguette et al. 2014). Hyper-
42 activation of HJ resolution at the G2/M transition by Mus81-Mms4 and Mus81-Eme1 has
43 been shown to rely on the dual phosphorylation of Mms4 by Cdc28^{CDK1} and Cdc5^{PLK1} in *S.*
44 *cerevisiae* and of Eme1 by Cdc2^{CDK1} and Chk1 in *S. pombe*(Matoss et al. 2011; Gallo-
45 Fernandez et al. 2012; Szakal & Branzei 2013; Dehé et al. 2013; Matoss et al. 2013), for
46 review see(Dehé & Gaillard 2017)). However, it is currently unknown whether
47 phosphorylation of human EME1 at the G2/M transition contributes to increased HJ
48
49
50
51
52
53
54
55
56
57
58
59
60

1
2
3 resolution capabilities of MUS81-EME1. A main determinant is CDK1-mediated
4 phosphorylation of the SAP domain of SLX4 that promotes association with MUS81.
5
6 Mutating the CDK1-phosphorylation sites within and near the SAP domain of SLX4
7 abolishes interaction with MUS81(Duda et al. 2016). This is somewhat unexpected given
8 the fact that phosphorylation is not mandatory for the SLX4-MUS81 interaction, which can
9 be recapitulated with non-phosphorylated recombinant SLX4 and MUS81 co-expressed in
10 insect cells or in Y2H experiments. This suggests that the interaction between MUS81 and
11 SLX4 may be weakened *in vivo* when SLX4 is in complex with other binding partners and
12 that phosphorylation enhances the strength of the SLX4/MUS81 association. An
13 alternative scenario could be that phosphorylation of SLX4 displaces an inhibitory binding
14 partner or PTM.
15
16
17
18
19
20
21

22 ***Alternative mechanisms for SLX4-mediated HJ resolution***

23
24 Although HJ resolution by the coordinated action of SLX1 and MUS81-EME1 in complex
25 with SLX4 is backed up by compelling experimental evidence, we would like to advocate
26 here that alternative, yet not exclusive, mechanisms for HJ resolution by SLX1 or MUS81-
27 EME1 independently from one another should be considered.
28
29

30
31 From an evolutionary standpoint, the fact that in higher eukaryotes MUS81-EME1 would
32 exclusively rely on SLX1 to introduce the first cut to resolve a HJ raises some questions.
33 Indeed, Mus81-mediated HJ resolution in yeast is a regulated process that occurs
34 independently of Slx1. In *S. pombe* where there is no Yen1, Mus81-Eme1 is the only HJ
35 resolvase(Boddy et al. 2001; Smith et al. 2003), while in *S. cerevisiae* HJ resolution is
36 independently carried out by Yen1 and Mus81-Mms4(Tay & Wu 2010; Ho et al. 2010;
37 Matos et al. 2011). Recent findings, discussed in a later section of the review, suggest that
38 Slx4 contributes to the efficient processing of joint molecules by Mus81-Mms4(Pfander &
39 Matos 2017) but all currently available genetic data suggest that this does not involve
40 Slx1.
41
42
43
44
45
46
47
48

49 The possibility that in some circumstances SLX1 may itself resolve a HJ without MUS81-
50 EME1 remains worthy of further consideration. Indeed, a bacterially produced
51 recombinant SLX1-SLX4^{CCD} complex made of SLX1 associated with just the CCD SLX1-
52 binding domain of SLX4 is a potent HJ resolvase *in vitro* that cuts both strands with a
53
54
55
56
57
58
59
60

1
2
3 remarkable efficiency(Fekairi et al. 2009; Svendsen et al. 2009). That such propensity to
4 cut both strands would always be counteracted *in vivo* is puzzling. Furthermore up to 50%
5 of the resolution products generated by SLX1-SLX4^{CCD} contain religatable nicks(Fekairi et
6 al. 2009; Svendsen et al. 2009)(and our unpublished data), indicating that like “canonical
7 HJ resolvases”, it can, albeit less efficiently, introduce symmetrical cuts on opposite
8 strands across the junction. It is noteworthy that even non-symmetrical cleavage during
9 HJ resolution achieves the essential by untethering recombined chromosomes and that the
10 SLX-MUS complex itself appears to promote asymmetric cleavage during HJ
11 resolution(Wyatt et al. 2013). The relevance of the SLX1-SLX4^{CCD} complex has been
12 challenged on the basis that it does not contain a full length SLX4 protein and that a
13 recombinant full length SLX1-SLX4 complex produced in insect cells turns out to be a
14 more promiscuous nuclease that processes HJs less specifically, clipping off in some cases
15 one arm of the HJ(Wyatt et al. 2013). A likely explanation is that the CCD domain is a small
16 C-terminal domain in SLX4 that is preceded by a large N-terminal extension that contains
17 numerous protein-protein interaction motifs and sites of PTMs. Unless associated with the
18 right binding partners and/or specific PTMs, this large N-terminal part of the protein may
19 be misfolded and prevent optimal structuration and loading on a model HJ *in vitro*.
20 Therefore, paradoxically, the apparently better-behaved SLX1-SLX4^{CCD} complex may be a
21 more relevant model to study the activity of SLX1 until we know more about the exact
22 composition of the different complexes that SLX4 can form *in vivo* and reconstitute these
23 *in vitro*. In that regard, recent work on the SMX complex is an important step towards the
24 characterization of such complexes and future studies might show that other SLX4 binding
25 partners can, like XPF, act as structural co-activators of MUS81-EME1 and/or SLX1(Wyatt
26 et al. 2017).

27
28
29
30
31
32
33
34
35
36 Finally, several *in vivo* observations suggest that in some circumstances SLX1-SLX4 and
37 SLX4-MUS81-EME1 independently contribute to HJ processing and chromosome stability.
38 In light of this, depleting SLX1 or MUS81 in BS cells negatively impacts cell viability much
39 less than co-depleting both proteins or depleting SLX4(Wyatt et al. 2013). Furthermore,
40 expression of SLX4^{ASAP} or SLX4^{ACCD} allows a partial restoration of SCE frequency in BLM-
41 depleted FA-P cells (SLX4-deficient)(Garner et al. 2013), suggesting that SLX4-associated
42 MUS81 and SLX1 can also act independently. Depletion of BLM or GEN1 in SLX4-null FA-P
43
44
45
46
47
48
49
50
51
52
53
54
55
56
57
58
59
60

1
2
3 cells causes chromosome abnormalities, dysfunctional mitosis and defects in nuclear
4 morphology(Garner et al. 2013). Remarkably, expressing in those cells the bacterial RusA
5 HJ resolvase rescues some of the chromosome abnormalities, demonstrating that they
6 result from the accumulation of unresolved HJs(Garner et al. 2013). Importantly,
7 chromosome abnormalities can also be partially rescued by SLX4^{ΔSAP} or SLX4^{ΔCCD}
8 mutants(Garner et al. 2013). These observations yet again strongly suggest that in some
9 circumstances, SLX1-SLX4 and SLX4-MUS81-EME1 can independently contribute to HJ
10 resolution *in vivo* and that the overall picture of how HJs are endonucleolytically
11 processed in mammalian cells may have more nuances to it than a two-tone image where
12 this would solely rely on the whole SLX1-SLX4-MUS81-EME1 complex and GEN1.
13
14
15
16
17
18
19
20

21 ***Is SLX4 an essential HR component in specific cellular contexts?***

22 While SLX4 deficiency is compatible with viability in mice (Crossan et al. 2011; Holloway
23 et al. 2011; Castor et al. 2013; Hodskinson et al. 2014) and humans (Kim et al. 2011;
24 Schuster et al. 2013; Kim et al. 2013), disruption of *Slx4* in chicken DT40 cells is
25 lethal(Yamamoto et al. 2011). SLX4-deficient cells accumulate in G2 and display a high
26 level of chromosomal instability and these phenotypes are reminiscent of the ones
27 observed with the deletion of essential HR genes such as Rad51(Sonoda et al. 1998). In
28 addition, ionizing radiation (IR) in G2 further exacerbates chromosomal instability in
29 SLX4-deficient cells with a high proportion of isochromatid gaps and breaks, which affect
30 sister chromatids at the same locus and may represent unfruitful attempts to process
31 recombination intermediates(Yamamoto et al. 2011). Surprisingly, the DT40 cell line lacks
32 MUS81, excluding that the essential role of SLX4 relies on formation of an SLX-MUS
33 complex. A tempting alternative is that it relies instead on its association with XPF, which
34 is also essential in DT40 cells(Kikuchi et al. 2013). It will be interesting to test this
35 hypothesis and to figure out whether interaction of SLX4 with other partners is required
36 for viability. DT40 cells are hyper-recombinogenic, which may explain the need of a strong
37 resolvase activity in this B lymphoma derived cell line. Interestingly, full knock-out of *SLX4*
38 by CRISPR-Cas9 gene editing in some cancer cell lines seems impossible to achieve (Rouse
39 and Lachaud, personal communications), suggesting that SLX4 may be essential in
40 tumoral cells. Understanding the nature of this essential function of SLX4 in DT40 cells
41
42
43
44
45
46
47
48
49
50
51
52
53
54
55
56
57
58
59
60

1
2
3 may eventually help designing new therapeutic strategies to selectively target cancer cells
4 over normal cells.
5
6
7
8
9

10 11 **SLX4 in ICL repair**

12
13
14 Interstrand crosslinks (ICLs) are highly toxic lesions that covalently link both DNA strands
15 and stall processes that depend on helix unwinding such as DNA replication and
16 transcription. Although ICLs can be potentially repaired at different stages of the cell-
17 cycle, replication-coupled repair has emerged as the most prominent mechanism(Zhang &
18 Walter 2014). As discussed below, stalling of a single or two converging forks at the ICL
19 seems to be the initiating event of ICL repair where SLX4 fulfills essential functions based
20 on two main features: ubiquitin binding through its UBZ4 motifs as well as interaction
21 with XPF and stimulation of the XPF-ERCC1 SSE.,
22
23
24
25
26
27
28

29 ***Recruitment of SLX4 to ICL and/or ICL-induced DNA damage.***

30
31 The identification of putative tandem UBZ4 motifs in SLX4 led to the early
32 hypothesis(Fekairi et al. 2009) that they could contribute to its ICL repair function by
33 coordinating the action of its associated nucleases with mono-ubiquitination of FANCD2,
34 which is essential for replication-coupled ICL repair(Knipscheer et al. 2009) (Figure 3A).
35
36 The key role of the SLX4 UBZ4 motifs in ICL repair was established when in-frame
37 deletions encompassing the end of the first UBZ4 (UBZ4-1) and the entire second UBZ4
38 (UBZ4-2) of SLX4, were found in patients with Fanconi anemia and shown to cause ICL
39 hypersensitivity associated with chromosomal aberrations(Kim et al. 2011; Stoepker et al.
40 2011). In addition, deletion of the tandem UBZ4 domain of SLX4 in chicken DT40 cells
41 precludes its recruitment to ICL-induced DNA damage foci and causes hypersensitivity to
42 several crosslinking agents(Yamamoto et al. 2011). Supporting an ICL-induced interaction
43 between SLX4 and mono-ubiquitinated FANCD2, deletion of the tandem UBZ4 domain also
44 prevents co-immunoprecipitation of SLX4 with mono-ubiquitinated FANCD2 and its
45 recruitment to DNA damage foci in DT40 mutant cells deficient for FANCD2
46 monoubiquitination(Yamamoto et al. 2011). Furthermore, experiments monitoring
47
48
49
50
51
52
53
54
55
56

1
2
3 replication-coupled ICL repair in *Xenopus* egg extracts revealed that mono-ubiquitination
4 of FANCD2 is a prerequisite for the efficient recruitment of SLX4 and XPF-ERCC1 to the
5 ICL(Douwel et al. 2014). However, despite these observations, the possibility that SLX4 is
6 recruited by a direct interaction between its tandem UBZ4 domain and mono-
7 ubiquitinated FANCD2 has been challenged in several ways. First of all, *in vitro* ubiquitin
8 binding assays show that the tandem UBZ4 domain of SLX4 does not bind to a single
9 ubiquitin molecule but instead to poly-ubiquitin chains with a strong preference for K63-
10 linked chains over K48-linked chains(Kim et al. 2011; Lachaud et al. 2014)(our
11 unpublished results). Also, Lachaud et al. went on to show that binding to ubiquitin is
12 mediated by UBZ4-1 only and that this UBZ is necessary and sufficient for the recruitment
13 of SLX4 to laser-induced ICL damage in human cells(Lachaud et al. 2014). Furthermore,
14 the recruitment of SLX4 is not affected in FANCD2-deficient cells(Lachaud et al. 2014).
15 These observations combined with the fact that there currently is no experimental
16 evidence for SLX4 interacting with FANCD2 in mammalian cells might suggest a FANCD2-
17 independent targeting of SLX4 to ICLs. This would also seem more consistent with the
18 non-epistatic relationship between $\Delta UBZ-SLX4$ and $\Delta FANCC$ (deficient for FANCD2
19 monoubiquitination) in DT40 cells(Yamamoto et al. 2011). Nevertheless, in light of these
20 contradictory data, it is important to keep in mind that *FANCD2*-mutated FA patient cell
21 lines (including the one used by Lachaud et al.) are hypomorphic and present some
22 residual FANCD2 protein and FANCD2 monoubiquitination(Kalb et al. 2007) that might
23 still contribute to the recruitment of SLX4. Moreover, the recruitment of SLX4 following
24 laser-induced ICL damage occurs in every cell and along the entire stripe, suggesting that
25 the SLX4 signal also represents some replication-independent recruitment of
26 SLX4(Lachaud et al. 2014). Finally, this SLX4 recruitment does not seem to require the
27 ubiquitin E3 ligases RNF8, RAD18, BRCA1 that catalyse DNA damage-dependent mono-
28 and/or polyubiquitination(Lachaud et al. 2014).

29 Hence, while the UBZ4-1 is clearly required for SLX4 relocalization and function in ICL
30 repair, the identity of the ubiquitinated protein(s?) directly bound by its UBZ4-1 motif
31 during replication-coupled ICL repair is still unclear (Figure 3A).

32 ***Stimulation of XPF activity***

1
2
3 More conclusive is the fact that the role of SLX4 in ICL repair mainly depends on its
4 interaction with XPF-ERCC1, a key SSE in ICL repair(for review(Zhang & Walter 2014;
5 Dehé & Gaillard 2017)). Large truncation or deletion of murine and human SLX4
6 suggested that the interaction between SLX4 and XPF mediated by the so-called MLR
7 domain is critical for resistance to crosslinking agents(Crossan et al. 2011; Kim et al.
8 2013). This was further confirmed by the identification of point mutations that abolish the
9 interaction between XPF and SLX4 and which are located within its minimal XPF-binding
10 region spanning residues 500 to 558 (Guervilly et al. 2015; Hashimoto et al. 2015).
11 Notably the FLW⁵³¹ and FY⁵⁴⁶ residues are crucial for binding to XPF (Guervilly et al. 2015;
12 Hashimoto et al. 2015) (and our unpublished data). In return, the function of XPF-ERCC1
13 in ICL repair seems to fully rely on SLX4 given that depletion of XPF in SLX4-deficient FA
14 cells does not exacerbate their sensitivity to the crosslinking agent mitomycin C
15 (MMC)(Kim et al. 2013). Intriguingly though, complementation of *Slx4*^{-/-} MEFs with SLX4
16 point mutants deficient in XPF interaction does exacerbate their chromosomal instability
17 in response to MMC(Hashimoto et al. 2015). Thus, the absence of SLX4 is less harmful than
18 the presence of an SLX4 mutant unable to interact with XPF-ERCC1. A possible
19 explanation is that the cell is lured by this mutant SLX4 protein and led to engage in non-
20 productive SLX4-XPF-ERCC1-dependent pathway instead of using an alternative route. In
21 this regard, the UHRF1 scaffold protein (ubiquitin-like PHD and RING finger domain-
22 containing protein 1) was recently reported to act as an ICL sensor that is needed for the
23 targeting of XPF-ERCC1 and MUS81-EME1 to ICLs(Tian et al. 2015), independently of
24 SLX4.

25
26 Mechanistically, SLX4 not only recruits XPF-ERCC1 to a single replication fork or two
27 convergent forks stalled by an ICL(Douwel et al. 2014; Klein Douwel et al. 2017), it also
28 promotes XPF-ERCC1-dependent incision(s) and the unhooking of the ICL(Douwel et al.
29 2014; Hodskinson et al. 2014)(Figure 3B). Indeed, SLX4 stimulates the activity of XPF-
30 ERCC1 *in vitro* towards replication fork-like structures and this is strengthened by the
31 presence of an ICL at the junction(Hodskinson et al. 2014). There are some discrepancies
32 regarding the position of the major incision by XPF-ERCC1, with studies showing that it
33 primarily cuts the leading strand template 3' to the ICL(Kuraoka et al. 2000; Hodskinson
34 et al. 2014) while others describe a major incision site 5' to the ICL(Fisher et al. 2008;
35 Abdullah et al. 2017) (Figure 3B), with the possibility that another endonuclease makes

1
2
3 the complementary incision. The use of different types of interstrand-crosslinked DNA
4 structures may explain some of these differences. Importantly, XPF-ERCC1 has the ability
5 to cleave DNA on both sides of an ICL suggesting that it could unhook the ICL by
6 itself(Kuraoka et al. 2000; Fisher et al. 2008) (Figure 3B,C). SLX4 strongly stimulates this
7 dual incision by XPF-ERCC1 *in vitro*(Hodskinson et al. 2014). Furthermore, experiments
8 monitoring ICL repair in *Xenopus* egg extracts show that depletion of SLX4 inhibits both
9 unhooking incisions and prevents the replication-coupled ICL repair. They also suggest
10 that transient interaction between the BTB domain of SLX4 and XPF is necessary to
11 optimally position XPF-ERCC1 at the ICL (Douwel et al. 2014; Klein Douwel et al. 2017).

12
13 It still remains to be determined whether in the dual-fork model both incisions are made
14 *in vivo* by XPF-ERCC1 or whether, as in NER(see for review (Dehé & Gaillard 2017)), the
15 second cut is introduced by another SSE such as SLX1 or FAN1 but only after XPF-ERCC1
16 has made the first cut (Figure 3C)(Zhang & Walter 2014)

17
18 It is noteworthy that an incision made by XPF-ERCC1 5' to an ICL in a replication fork-like
19 structure is also strongly stimulated by RPA and can serve as an entry point for the
20 SNM1A 5' to 3' exonuclease, which can digest past the crosslink(Wang et al. 2011;
21 Abdullah et al. 2017)(Figure 3B). The SNM1B/Apollo exonuclease is also able to digest an
22 ICL-containing substrate *in vitro*, although less efficiently than its paralog
23 SNM1A(Sengerová et al. 2012). SNM1B and SLX4 were found to co-immunoprecipitate
24 and suggested to function epistatically in response to MMC(Salewsky et al. 2012). These
25 findings support an alternative way to unhook the crosslink and it will be interesting to
26 see how SLX4-XPF-ERCC1 may cooperate with RPA and SNM1B and A exonucleases in this
27 process.
28
29
30
31
32
33
34
35
36
37
38
39
40
41

42 **Regulation of MUS81 and SLX1 in ICL repair**

43
44 The importance of the SLX4-MUS81 interaction in ICL repair is currently uncertain. Initial
45 studies showed that MUS81-EME1 promotes ICL-dependent DSBs during replication and
46 murine *Mus81*^{-/-} and *Eme1*^{-/-} ES cells are hypersensitive to DNA crosslinking
47 agents(Abraham et al. 2003; McPherson et al. 2004; Dendouga et al. 2005; Hiyama et al.
48 2006; Hanada et al. 2006), albeit to a lesser extent than *Ercc1*^{-/-} cells(Hanada et al. 2006).
49 This contribution of MUS81 to the cellular survival to crosslinking agents in murine cells
50 was later shown to be independent of its interaction with SLX4(Castor et al. 2013; Nair et
51
52
53
54
55
56
57
58
59
60

1
2
3 al. 2014). In line with this, the major role of SLX4 in ICL repair in human cells barely relies
4 on its MUS81-binding SAP domain(Kim et al. 2013) and MUS81 does not contribute to the
5 SLX4-mediated replication-coupled ICL repair in the *Xenopus* system(Douwel et al. 2014).
6 While all of the above strongly suggests that the prominent role of SLX4 in ICL repair is
7 largely MUS81-independent, a study by Nair and colleagues aimed at identifying point
8 mutations in MUS81 that abrogate its ability to interact with SLX4 challenges this
9 conclusion(Nair et al. 2014). Indeed, such SLX4-binding mutants turn out to be incapable
10 of rescuing the hypersensitivity to MMC of HCT116 *MUS81*^{-/-} cells and HEK293 cells
11 depleted for MUS81, suggesting instead that the SLX4-MUS81 interaction is important.
12 Furthermore, human MUS81-EME1 was found to be required for the repair of DSBs
13 induced by MMC and this also relied on its interaction with SLX4(Nair et al. 2014). It
14 currently is unclear what underlies these discrepancies and more work will be needed to
15 understand whether SLX4-MUS81 complex formation may become important later in ICL
16 repair for the processing of possible HR intermediates, as well as to decipher what are the
17 SLX4-independent contributions made by MUS81 in response to DNA crosslinking agents.
18 In light of this, DSBs occurring in both MMC-treated XPF-ERCC1- and SLX4-deficient cells
19 are dependent on MUS81 and were proposed to represent an alternative backup pathway
20 enabling ICL unhooking(Wang et al. 2011)(Figure 3D).
21
22
23
24
25
26
27
28
29
30
31
32
33

34 Although probably not a front line player in ICL repair(Kim et al. 2013), SLX1 does
35 contribute to full resistance to DNA crosslinking agents through its interaction with
36 SLX4(Castor et al. 2013). Related to the above, the HJ resolvase activity of SLX4-SLX1 and
37 MUS81-EME1 may be required at later steps in ICL repair for the resolution of
38 recombination intermediates. In line with this, MMC treatment induces SCEs in human
39 cells and this requires the interaction of SLX4 with MUS81-EME1 and SLX1 but not with
40 XPF(Garner et al. 2013). In fact, depletion of XPF was proposed to rather further increase,
41 in an SLX4-dependent manner, the level of SCEs induced by cisplatin(Wyatt et al. 2013).
42 Intriguingly, these data once again suggest that the XPF-dependent ICL repair pathway
43 may be distinct from the one involving MUS81-EME1 and SLX1. The situation is somehow
44 different in murine cells as neither SLX1 nor MUS81 contribute to the formation of SCE in
45 response to MMC(Castor et al. 2013). Interestingly, the archeal HJ resolvase Hje fused to
46 catalytic dead SLX1 is unable to restore ICL resistance in SLX1-deficient murine cells while
47
48
49
50
51
52
53
54
55
56
57
58
59
60

1
2
3 it efficiently promotes SCE formation upon BLM depletion, suggesting that SLX1 also
4 cleaves DNA structures distinct from HJs during ICL repair(Castor et al. 2013). These
5 structures may arise from DSBs introduced by a pool of free MUS81-EME1 (not bound to
6 SLX4) at stalled forks, potentially explaining the epistatic relationship between SLX1 and
7 MUS81-EME1 in mice(Castor et al. 2013). As previously mentioned, in the “two-fork
8 model”, SLX1 has also been proposed to be responsible for the incision 5' to the ICL and to
9 act redundantly with the FAN1 nuclease(Zhang & Walter 2014). Accordingly, MEFs from
10 *Slx1*^{-/-} mice producing nuclease dead (nd) FAN1 were more sensitive to MMC than the
11 single *Fan1*^{nd/nd} MEFs(Lachaud et al. 2016).

12 Before closing this section, we would like to underscore the fact that the structure of the
13 ICL and the distortion that it imposes on the DNA helix can considerably vary from one
14 agent to another(Noll et al. 2006). Thus, removal of different kinds of ICLs has been shown
15 to rely on different sets of DNA repair enzymes(Smeaton et al. 2008; Wang et al. 2011; Roy
16 et al. 2016). This may also pertain to SLX4-associated SSEs. Furthermore, DNA
17 crosslinking agents also form mono and di-adducts on just one strand, usually at higher
18 rates than ICLs, that do not impede DNA unwinding. Therefore, it is conceivable that some
19 nucleases involved in the response to DNA crosslinking agents, such as MUS81-EME1 or
20 SLX1, may in fact act primarily at replication forks stalled by adducts on one strand rather
21 than in the repair of ICLs *per se*. In addition, DNA crosslinking agents can induce fork
22 reversal(Zellweger et al. 2015) and there remains the possibility that MUS81-EME1 and
23 SLX4-SLX1 could act on ICL-stalled forks that have escaped processing by SLX4-XPF-
24 ERCC1 and reversed into a HJ-like structure.

25 Finally, it will be interesting to figure out how the cell differentially engages either SLX4-
26 dependent nucleolytic processing of forks stalled at the ICL or instead the so called “ICL
27 traverse” mechanism that relies on the FANCM translocase, which allows replication to
28 proceed through an ICL without DNA repair(Huang et al. 2013).

29 **SLX4 in the replication stress response from S-phase to mitosis**

30 ***SLX4 promotes MUS81-dependent cleavage of replication forks***

31 In addition to its major contribution to ICL repair, SLX4 also participates to cellular
32 survival in response to camptothecin (CPT)(Munoz et al. 2009; Svendsen et al. 2009), a

1
2
3 Topoisomerase I(TopI) poison that traps the TopI-DNA cleavage complex (TopIcc) and
4 generates replication-associated DSBs(Pommier 2006). The role of SLX4 in mediating CPT
5 resistance relies on its interaction essentially with MUS81 and partially with SLX1(Kim et
6 al. 2013). Mechanistically, SLX4 probably assists MUS81 in promoting the cleavage of
7 replication intermediates formed as a result of topological constraints that accumulate
8 ahead of the fork after TopI inhibition(Koster et al. 2007; Regairaz et al. 2011). SLX4-
9 associated MUS81 and SLX1 may subsequently collaborate in the processing of
10 recombination intermediates such as single HJs formed during restoration of a functional
11 replication fork by HR. Remarkably, the SIMs of SLX4 were also shown to contribute to the
12 cleavage of CPT-induced replication intermediates(Ouyang et al. 2015).
13
14
15
16
17
18
19
20

21 A role for SLX4 in the processing of replication intermediates has also been described
22 when replication stress is not caused by DNA adducts or protein-DNA complexes but
23 rather results from perturbations due to nucleotide pool imbalance induced by
24 hydroxyurea (HU) or direct DNA polymerase(s) inhibition by aphidicolin (APH). This
25 results in uncoupling the replicative helicase from the DNA polymerases, resulting in the
26 formation of large stretches of ssDNA protected by RPA, which initiates the activation of
27 ATR, the master checkpoint kinase in response to replication stress. Despite the protective
28 function of ATR during replication stress, a prolonged HU or APH treatment in mammalian
29 cells will eventually result in DSBs at stalled replication forks(Zeman & Cimprich 2014). In
30 line with this, SLX4 promotes DSBs after a prolonged HU treatment as visualized by PFGE,
31 Comet assay and γ H2AX appearance(Fugger et al. 2013; Guervilly et al. 2015; Malacaria et
32 al. 2017) (Figure 4). These observations come after numerous studies on MUS81-
33 mediated DSBs at stalled replication forks in a way that is thought to contribute to
34 replication fork restart(Hanada et al. 2007; Lemaçon et al. 2017),(Pepe & West 2014)
35 (and(Dehé & Gaillard 2017) for review). It remains to be determined to which extent
36 MUS81 relies on SLX4 to introduce those breaks. Moreover, it often is unclear which of
37 MUS81-EME1 or MUS81-EME2 is involved (Figure 5). For simplicity, in such cases we will
38 refer to MUS81-mediated cleavage with the understanding, however, that MUS81 cannot
39 cleave DNA without being in complex with one of its EME1 and EME2 partners.
40 Accumulating evidence points towards a role of MUS81-EME2 in processing HU-stalled
41 forks (Pepe & West 2014; Lemaçon et al. 2017). While it is tempting to speculate that SLX4
42
43
44
45
46
47
48
49
50
51
52
53
54
55
56

1
2
3 contributes to MUS81-EME2 mediated DSBs, formation of an SLX4-MUS81-EME2 complex
4 has not yet been described, even less so stimulation of MUS81-EME2 by SLX4.
5
6

7
8 Interestingly, a recent study shows that SLX4- and MUS81-dependent DSB formation in
9 HU-treated HCT116 cells is promoted through the formation of a BRCA1/SLX4-MUS81
10 complex(Xu et al. 2017). More work is needed to figure out how SLX4 and BRCA1
11 associate and whether this represents a direct interaction but BRCA1 seems to promote
12 SLX4 recruitment onto chromatin after replicative stress(Xu et al. 2017). PLK1 is also part
13 of the BRCA1/SLX-MUS complex and its kinase activity is required for SLX4 interaction
14 with MUS81(Xu et al. 2017), in agreement with previous studies(Wyatt et al. 2013; Duda
15 et al. 2016). Overall, these data suggest that this PLK1-regulated BRCA1-SLX-MUS complex
16 has a common function in promoting DSB formation and replication fork restart(Xu et al.
17 2017) (Figure 4 and 5). Intriguingly, this pathway is needed for a relatively late replication
18 fork restart and is antagonized by an earlier 53BP1-dependent mechanism that does not
19 rely on fork cleavage(Xu et al. 2017). Accordingly, loss of this earlier fork restart
20 mechanism in HU-treated cells results in higher levels of DSBs, which are mediated
21 through the BRCA1/SLX4-MUS81 pathway(Xu et al. 2017).
22
23
24
25
26
27
28
29
30
31

32 Counter-intuitively, although SLX4-dependent cleavage of replication forks is turning out
33 to be a finely regulated physiological process, which is beneficial in response to CPT and
34 ICL-inducing agents, it does not always account for improved cell viability. Indeed, siRNA-
35 mediated transient depletion of SLX4 confers resistance to HU in transformed cell lines
36 such as HeLa cells(Guervilly et al. 2015). The same holds true for the knockdown of
37 MUS81 and FBH1, a DNA helicase thought to promote MUS81-dependent DSBs in
38 response to HU(Fugger et al. 2013; Jeong et al. 2013). This suggests that cleavage of stalled
39 replication forks can be detrimental for cell survival in HU. It also implies that, in absence
40 of SLX4, cells cope with HU-induced replicative stress by relying on alternative ways that
41 efficiently promote survival.
42
43
44
45
46
47
48
49
50

51 ***SLX4 in response to acute replication stress following inhibition of checkpoints***

52 The combination of HU- or APH-induced inhibition of DNA replication with ATR inhibition
53 is highly toxic and results in rapid formation of DSBs at replication forks(Couch et al.
54
55
56
57
58
59
60

1
2
3 2013; Ragland et al. 2013; Toledo et al. 2013). An important role of ATR in the S-phase
4 checkpoint is to repress the firing of new origins following replication stress(Toledo et al.
5 2013). It also “stabilizes” forks and avoids replication problems in some other ways but
6 the underlying molecular mechanisms are still poorly understood. One way involves the
7 phosphorylation by ATR of the SMARCAL1 helicase, which restrains its ability to remodel
8 replication forks(Couch et al. 2013). Inhibition of ATR (ATRi) combined with HU
9 treatment not only leads to DSBs but also to the formation of single-stranded nascent
10 DNA. Remarkably, this depends on SLX4 but not on its SSE partners, not even MUS81.
11 While this points to a MUS81-independent role for SLX4 in promoting replication fork
12 collapse (Couch et al. 2013) (Figure 5), a possible redundancy between nucleases cannot
13 be excluded given that SLX1, XPF, or MUS81 were singly depleted(Couch et al. 2013). As
14 SMARCAL1 also contributes to nascent ssDNA generation following HU+ATRi, its
15 remodeling activity on stalled forks has been proposed to promote SLX4-dependent fork
16 cleavage(Couch et al. 2013).
17
18
19
20
21
22
23
24
25
26

27 Similarly, SLX4 contributes to the generation of DSBs induced by APH in ATR-deficient
28 cells(Ragland et al. 2013). This seems to come as a consequence of replication fork
29 breakdown mediated by the SUMO-targeted Ubiquitin ligase (STUbL) RNF4 and PLK1 in
30 the absence of ATR(Ragland et al. 2013). Interestingly, replication fork restart in ATR-
31 deficient murine cells following removal of APH is enhanced by depleting RNF4 or
32 inhibiting PLK1, but this is a transient effect and DNA replication is soon aborted(Ragland
33 et al. 2013). How SLX4 influences replication fork restart in this context has not been
34 tested. As discussed above, PLK1 could promote the association of MUS81 with SLX4 and
35 enhance fork cleavage(Wyatt et al. 2013; Duda et al. 2016; Xu et al. 2017). Alternatively,
36 PLK1 and/or RNF4 may contribute to fork remodeling, creating a substrate for SLX4-
37 dependent nucleolytic incisions. RNF4 may do so by ubiquitylating SUMOylated
38 components of the replisome and targeting them for degradation by the
39 proteasome(Ragland et al. 2013). This raises the possibility of a functional link between
40 potential SLX4-driven SUMOylation at replication forks(Guervilly et al. 2015) and
41 subsequent RNF4-mediated degradation of SUMOylated replisome components. Should
42 this hypothesis be confirmed by future studies, it would provide an explanation for a
43
44
45
46
47
48
49
50
51
52
53
54
55
56
57
58
59
60

1
2
3 putative nuclease-independent contribution made by SLX4 in promoting replication fork
4 collapse under specific circumstances.
5
6

7
8 Inhibition of the checkpoint kinase CHK1 *per se* leads to extensive replication stress,
9 notably due to deregulated origin firing and defects in fork
10 stabilization/elongation(Syljuåsen et al. 2005)(reviewed in (González Besteiro &
11 Gottifredi 2015) and (Técher et al. 2017). Unexpected findings came from investigating
12 how cells respond to acute replicative stress induced by HU and the CHK1 inhibitor
13 (CHK1i) UCN-01(Murfuni et al. 2013; Malacaria et al. 2017). In contrast to the HU+ATRi
14 treatment, where formation of DSBs needs SLX4 but not MUS81(Couch et al. 2013), DSBs
15 induced by the HU+CHK1i cocktail depend on SLX4-bound MUS81(Malacaria et al. 2017).
16 Intriguingly, SLX4 also prevents the accumulation of GEN1-mediated DSBs in S-phase
17 following HU+CHK1i (Figure 5). This also comes as a surprise given that the action of
18 GEN1 was proposed to be restricted to mitosis by nuclear exclusion(Chan & West 2014).
19 Interestingly, this function of SLX4, which does not rely on its interaction with MUS81 and
20 SLX1, apparently prevents the accumulation of HJ-related structures or shields such
21 structures from GEN1 processing (Malacaria et al. 2017).
22
23
24
25
26
27
28
29
30
31

32 **Targeting Slx4 to replication forks**

33
34 Consistent with its role in processing replication forks, SLX4 has been detected in close
35 association with nascent DNA by iPOND (isolation of proteins on nascent
36 DNA)(Dungrawala et al. 2015). How SLX4 is recruited in the vicinity of the replisome
37 remains unknown but one possibility lies in a SUMO-regulated recruitment. Indeed, SLX4
38 may interact through its SIMs with SUMOylated proteins that are found enriched at the
39 replisome(Lopez-Contreras et al. 2013), which may explain the SIM^{SLX4}-dependent DSB
40 formation in HU(Guervilly et al. 2015). Known partners of SLX4 such as MSH2(Svendsen
41 et al. 2009) and TOPBP1(Gritenaite et al. 2014) are *bona fide* components of the
42 replication fork machinery and might also provide a way to recruit SLX4. In addition to
43 protein-protein interactions, SLX4 might also directly bind to DNA secondary structures
44 that form after remodelling of stalled replication forks. Interestingly, SLX4 and MUS81 are
45 enriched at HU-stalled forks in the absence of RAD51C, which is one of the paralogs of
46 RAD51(Somyajit et al. 2015). Strikingly, depletion of FANCM in RAD51C-deficient cells
47
48
49
50
51
52
53
54
55
56

1
2
3 strongly reduces the levels of SLX4 and MUS81 found at HU-stalled forks suggesting that
4 fork remodeling by the FANCM helicase activity is required to promote the recruitment of
5 the SLX4 complex in that context(Somyajit et al. 2015).
6
7

8 9 ***Interplay between helicases and SLX4 at the replication fork***

10
11 As alluded to on several occasions, accumulating evidence indicates an interplay between
12 fork remodeling by DNA helicases and the action of SLX4 and its associated nucleases.
13 Indeed, several helicases (FBH1, SMARCAL1, FANCM) seem to promote remodeling of the
14 replication fork and thereby SLX4-dependent conversion of replication intermediates into
15 DSBs(Fugger et al. 2013; Couch et al. 2013). One possible outcome of this remodeling is
16 the reversal of the fork with nascent strands annealing to one another (Figure 4). In line
17 with this, SMARCAL1, FANCM and FBH1 helicases can drive fork reversal *in vitro*(Gari et
18 al. 2008; Bétous et al. 2012; Fugger et al. 2015). In addition, recent evidence strongly
19 suggests that FBH1 and SMARCAL1, as well as the SNF2 family helicases ZRANB3 and
20 HLTF, also promote fork reversal *in vivo*(Fugger et al. 2015; Kolinjivadi et al. 2017;
21 Vujanovic et al. 2017; Taglialatela et al. 2017).
22
23

24
25 The significance of fork reversal in eukaryotes has been under debate over more than a
26 decade with, initially, the prevailing idea that it occurs only under pathological conditions
27 (Sogo et al. 2002). However, accumulating evidence indicates that fork reversal is more of
28 a global and regulated process than anticipated and that it can contribute to the
29 maintenance of replication fork stability(Ray Chaudhuri et al. 2012; Berti et al. 2013;
30 Neelsen et al. 2013; Zellweger et al. 2015; Vujanovic et al. 2017)(For review(Neelsen &
31 Lopes 2015)).
32
33

34
35 Reversed forks are four-way DNA junctions similar to HJs and can therefore be processed
36 by HJ resolvases. Thus, although fork reversal may contribute to replication fork stability,
37 uncontrolled fork reversal and the risk of unscheduled endonucleolytic processing of
38 reversed forks can constitute a serious threat to genome stability(Couch & Cortez 2014).
39 MUS81 cleaves reversed forks *in vivo* after oncogene-induced replicative stress (Neelsen
40 et al. 2013) or in HU-treated BRCA2-deficient cells(Lemaçon et al. 2017), although formal
41 demonstration that SLX4 is driving the action of MUS81 in this process has not yet been
42 made (Figure 4 and 6). Reminiscent of the coordination of MUS81-EME1 and SLX1 in the
43 resolution of HJs(Wyatt et al. 2013; Wyatt et al. 2017), replication-associated DSBs in
44
45
46
47
48
49
50
51
52
53
54
55

1
2
3 response to HU+CHK1i apparently relies on SLX1-SLX4-MUS81 complex formation
4 suggesting that the SLX-MUS complex may process reversed replication forks(Malacaria et
5 al. 2017) (Figure 5).

6
7
8 An alternative to the processing of “intact” reversed forks with four duplex branches has
9 recently emerged with the suggestion that MUS81-EME2 acts on reversed forks that have
10 first been processed by an MRE11/EXO1-dependent exonucleolytic step, which converts
11 the duplex branch made of annealed nascent strand into a single-stranded tail(Lemaçon et
12 al. 2017) (Figure 4 and 6). This would be in agreement with earlier data suggesting that
13 MRE11 converts stalled forks into a substrate for MUS81-dependent nucleases(Thompson
14 et al. 2012).

15
16 Furthermore, a number of recent reports suggests that in cells defective for BRCA1 or
17 BRCA2, reversed forks constitute an entry point for degradation of neo-synthetized DNA
18 by MRE11(Kolinjivadi et al. 2017; Lemaçon et al. 2017; Mijic et al. 2017; Tagliatela et al.
19 2017) (Figure 6). Importantly, this defect can be suppressed by depleting helicases that
20 promote fork reversal(Kolinjivadi et al. 2017; Lemaçon et al. 2017; Mijic et al. 2017;
21 Tagliatela et al. 2017). These findings come after earlier reports that described the so-
22 called “fork protection pathway” and the importance for fork stability of the BRCA2-
23 dependent stabilization of RAD51 nucleofilaments at stalled forks(Schlacher et al. 2011;
24 Schlacher et al. 2012), which were recently found to inhibit MUS81 cleavage(Di Marco et
25 al. 2017). It will be important to determine to what extent SLX4 may influence fork
26 protection.
27
28
29
30
31
32
33
34
35
36
37
38

39 ***Selected examples of possible outcomes of SLX4-dependent fork processing***

40
41 The control of SSEs at stalled replication forks is undoubtedly an important function of
42 SLX4 in maintaining genome stability(Dehé & Gaillard 2017). However, there might be a
43 threshold of replication stress beyond which SLX4 may add insult to injury by promoting
44 levels of DSBs that exceed the DNA repair machinery capacities. Hereafter, we discuss how
45 recent discoveries using specific genetic contexts (BRCA2 deficiency, oncogene activation)
46 or chemically-induced premature mitosis (WEE1 inhibition) shed new light on the action
47 of SLX4 and MUS81 during replicative stress.
48
49
50
51
52
53

54 *Do SLX4 and MUS81 fulfill back-up or toxic functions in BRCA2-deficient cells?*

1
2
3 Based on recent findings SLX4 and MUS81 turn out to be important for the proliferation of
4 BRCA2-defective cancer cells(Lai et al. 2017) (Figure 6). This suggests that in some DNA
5 repair-deficient cells SLX4 could perform pro-survival “back-up functions” that may fuel
6 tumor progression. Such pro-oncogenic contribution of SLX4 would be in stark contrast to
7 its recognized tumor-suppressor role. We speculate that SLX4 may do so through the
8 control of MUS81, which is required in BRCA2-depleted cells for maintaining replication
9 fork progression, promoting mitotic DNA synthesis (MiDAS - cf next section) and
10 minimizing mitotic defects(Lai et al. 2017) (Figure 6). The same applies to the fact that
11 MUS81 apparently promotes early and transient DSBs in BRCA2-depleted cells treated
12 with HU, possibly at reversed forks resected by MRE11/EXO1 (Lemaçon et al. 2017).

13
14 Interestingly, Rondinelli and colleagues find that EZH2, the catalytic subunit of the
15 Polycomb Repressive Complex 2 (PRC2), promotes recruitment of MUS81 at stalled
16 replication forks through its Histone-Methyl Transferase (HMT) activity. This suggests a
17 new layer in the control of MUS81 recruitment to chromatin(Rondinelli et al. 2017). It will
18 be important to figure out whether and how this may be linked to the control of MUS81 by
19 SLX4. Intriguingly though, in stark contrast with the pro-survival functions of SLX4 and
20 MUS81 in BRCA2-deficient cells(Lai et al. 2017) discussed above, in this study the
21 EZH2/MUS81 axis seems to impair the proliferation and fitness of BRCA2-deficient cancer
22 cells(Rondinelli et al. 2017) (Figure 6). For example, low levels of MUS81 in BRCA2-
23 mutated ovarian carcinoma correlate with a poor patient survival and EZH2 inhibition
24 promotes earlier tumor relapse and decreases overall survival after PARP inhibition in a
25 BRCA2-deficient mouse model(Rondinelli et al. 2017). Such discrepancies urgently call for
26 new investigations to decipher whether SLX4 and MUS81 should be considered or actually
27 excluded as potential chemotherapeutic targets in BRCA2-deficient tumors.
28
29
30
31
32
33
34
35
36
37
38
39
40
41
42
43

44 *SLX4 promotes mitotic entry and genome instability upon WEE1 inhibition*

45 Inhibition of the WEE1 kinase (WEE1i), a negative regulator of CDK1 and CDK2, results in
46 replication stress characterized by unscheduled origin firing and DNA damage, as well as
47 premature mitotic entry(Beck et al. 2010; Aarts et al. 2012; Beck et al. 2012). Importantly,
48 the induction of DNA damage and DSBs after prolonged inhibition of WEE1i, initially
49 shown to depend on MUS81-EME1(Domínguez-Kelly et al. 2011), also depends on SLX4
50
51
52
53
54
55
56
57
58
59
60

1
2
3 and MUS81-EME2 and correlate with the recruitment of MUS81 at replication forks(Beck
4 et al. 2012; Duda et al. 2016).
5
6

7
8 Importantly, SLX4 and MUS81-EME2 were also shown to be responsible for the
9 pulverization of chromosomes that results from inhibition of WEE1 and premature entry
10 of the cell into mitosis with an under-replicated genome(Duda et al. 2016). Remarkably,
11 depletion of SLX4, MUS81 or EME2 is sufficient to delay premature entry into mitosis
12 despite inhibition of WEE1 and to prevent chromosome pulverization(Duda et al. 2016).
13 Chromosome pulverization is believed to result from compaction of under-replicated
14 chromosomes rather than from the direct shredding of the genome by SSEs exclusively.
15 Duda and colleagues propose that replication intermediates signal to the cell, by an as yet
16 undetermined mechanism, that it is not fit to enter mitosis. Upon completion of
17 replication, this signaling disappears and the cell moves on to mitosis. According to their
18 model, inhibition of WEE1 results in the premature increase of CDK1 activity, which
19 promotes untimely SLX4-MUS81 complex formation in S-phase and presumably results in
20 the processing of replication intermediates leading to mitosis with a partially replicated
21 genome(Duda et al. 2016). PLK1 was also shown to contribute to SLX4-MUS81 complex
22 formation in WEE1-treated cells and to promote DSB formation and chromosome
23 pulverization due to prematurely high levels of CDK1 activity(Duda et al. 2016).
24
25

26
27
28
29
30
31
32
33
34 Once again, despite the fact that these findings strongly suggest that SLX4 may control
35 MUS81-EME2, formal demonstration that this is the case has yet to be provided.
36
37
38

39
40 It is noteworthy that WEE1 inhibitors such as MK-1775 display strong anti-tumour
41 activity, either as a single agent therapy or in combination with DNA damaging agents and
42 have entered clinical trials(Matheson et al. 2016). Given the fact that deficiency in SLX4,
43 MUS81 or EME2 suppresses DNA damage and reduces the toxicity of MK-1775(Duda et al.
44 2016), elevated levels of these proteins might be used as a predictive biomarker to
45 identify favorable clinical situations for a therapeutic strategy based on WEE1 inhibition.
46 Along those lines, higher expression levels of *EZH2* correlate with an increased toxicity of
47 MK-1775 combined with gemcitabine, a nucleoside analog used in chemotherapy that
48 induces replication stress(Aarts et al. 2012). As *EZH2* drives MUS81 recruitment to stalled
49 replication forks(Rondinelli et al. 2017), therefore, high levels of *EZH2* probably
50
51
52
53
54
55
56

1
2
3 potentiate the effect of WEE1 inhibition by further promoting MUS81-mediated
4 processing of replication intermediates and premature mitotic entry. In agreement,
5 depletion of EZH2 restrains premature mitotic entry of Cal120 breast cancer cells treated
6 with MK1775+Gemcitabine(Aarts et al. 2012). As previously mentioned, it will be
7 important to better understand what may be the functional links between EZH2- and
8 SLX4-dependent control of MUS81.
9
10
11
12
13

14 *SLX4 and oncogene-induced replicative stress (OI-RS)*

15
16 Several oncogenes induce a replicative stress, characterized by a reduced fork speed
17 and/or a deregulated origin firing(Macheret & Halazonetis 2015). As SLX4 promotes DSB
18 formation and cell death in response to HU, we suggested that such toxicity of SLX4 in
19 response to replication stress may contribute to its role as a tumor-suppressor by clearing
20 cells that have suffered high levels of oncogene-induced replicative stress(Guervilly et al.
21 2015; Guervilly & Gaillard 2016). A similar hypothesis had previously been proposed for
22 the toxic function of FBH1 and MUS81 in response to replicative stress, which could
23 potentially limit transformation of cells facing oncogene activation(Fugger et al. 2013;
24 Jeong et al. 2013).
25
26
27
28
29
30

31 In line with this, MUS81 has been suggested to cleave reversed forks and promote DNA
32 damage following oncogene (CDC25A)-induced replicative stress(Neelsen et al. 2013).
33 Premature SLX4-MUS81 complex formation may be involved here again. Indeed,
34 reminiscent of what is seen following inhibition of WEE1, over-expression of CDC25A also
35 promotes premature mitotic entry and CDK1-dependent DNA damage(Neelsen et al.
36 2013). By antagonizing WEE1 and driving CDK1 activation, CDC25A overexpression may
37 thus lead to premature SLX4-MUS81 complex formation in S-phase and unscheduled
38 processing of replication intermediates. According to the hypothesis proposed by Duda
39 and colleagues, this would contribute to DSB formation and premature entry into mitosis
40 in cells over-expressing CDC25A.
41
42
43
44
45
46

47 In contrast, over-expression of the Cyclin E (CycE) oncogene causes replication stress and
48 fork reversal without early processing of replication intermediates and premature entry
49 into mitosis(Neelsen et al. 2013). This reflects the fact that, unlike CDC25A, CycE OE does
50 not result in increased CDK1 activity and therefore probably does not cause untimely
51 SLX4-MUS81 complex formation. After several generations though, it will ultimately result
52
53
54
55
56
57
58
59
60

1
2
3 in SLX4-dependent DSBs(Neelsen et al. 2013; Malacaria et al. 2017). Of note, while
4 promoting MUS81-dependent DSBs, SLX4 also appears to prevent the accumulation of
5 GEN1-mediated DSBs in S-phase following CycE OE(Malacaria et al. 2017) (Figure 5). This
6 suggests that SLX4 protects against opportunistic GEN1 activity, which may fuel genome
7 instability in response to CycE-induced replication stress.
8
9

10
11 In addition to the above, SLX4 was also found to promote the G1/S transition in the
12 osteosarcoma U2OS cell line, especially when Cyclin E is over-expressed(Sotiriou et al.
13 2016), suggesting that it may be pro-oncogenic in some circumstances by promoting the
14 proliferation of cells with activated oncogenes.
15
16
17
18

19 Overall, these observations suggest that SLX4 may modulate the response to OI-RS at
20 several levels although how SLX4 influences the outcome of OI-RS remains rather blurry.
21 Future studies will be required to better understand the role(s) of SLX4 in the response to
22 OI-RS, which constitutes an early step in tumorigenesis, but also a barrier when it comes
23 to driving senescence of pre-cancerous cells.
24
25
26
27
28

29 ***Maintenance of Common Fragile Sites and Mitotic DNA synthesis (MiDas)***

30 Another beneficial function of SLX4 in maintaining genome stability relies on the accurate
31 replication and/or maintenance of specific genomic regions such as telomeres (cf next
32 part) or common fragile sites (CFS). CFS can be defined as genomic loci that have a high
33 tendency to display chromosome gaps and breaks in mitosis, especially under replication
34 stress induced by low levels of APH(Le Tallec et al. 2014; Glover et al. 2017). Several
35 tumour-suppressor genes map at CFS regions and are often deleted in cancer, suggesting
36 that CFS expression, *i.e* their apparent “breakage” in metaphase, could represent a driver
37 of tumorigenesis(Glover et al. 2017). The replication of CFS is thought to be particularly
38 problematic for several reasons, including late replication and an intrinsic low density of
39 active replication origins at CFS(Letessier et al. 2011). Thus, CFS replication relies on long-
40 travelling forks that may encounter additional obstacles such as DNA secondary
41 structures or collide with the transcription machinery at very large genes nested within
42 CFS regions(Helmrich et al. 2011; Le Tallec et al. 2013; Le Tallec et al. 2014; Wilson et al.
43 2015; Glover et al. 2017). Hence, especially when replication is further challenged by low
44
45
46
47
48
49
50
51
52
53
54
55
56
57
58
59
60

1
2
3 doses of APH, many CFS are probably not completely replicated before cells enter mitosis
4 (Figure 7).

5
6 Incomplete replication at CFS will hinder the faithful segregation of sister chromatids in
7 mitosis and constitutes a major threat for genome stability. Nucleolytic incisions at late
8 replication intermediates by SSEs such as MUS81-EME1 and XPF-ERCC1 has been
9 proposed as a strategy to allow the subsequent segregation of sister chromatids(Naim et
10 al. 2013; Ying et al. 2013). MUS81-EME1 localizes to CFS in early mitosis and actively
11 promotes their expression while impaired “CFS breakage” in the absence of MUS81-EME1
12 is associated with chromosome segregation defects, micronuclei formation and markers of
13 DNA damage in the next G1 phase, as visualized by 53BP1 nuclear bodies(Naim et al.
14 2013; Ying et al. 2013). In contrast to previous models, these data suggest that CFS
15 expression is a highly regulated process that contributes to the stability of these loci.

16
17 We and others have shown that SLX4 localizes to mitotic foci(Guervilly et al. 2015;
18 Pedersen et al. 2015; Minocherhomji et al. 2015; Duda et al. 2016) and that its deficiency
19 induces anaphase bridges, micronuclei formation and 53BP1 bodies in G1 in APH-treated
20 cells(Guervilly et al. 2015; Ouyang et al. 2015; Minocherhomji et al. 2015). Further
21 suggesting a role of SLX4 in maintaining CFS stability, some SLX4 foci can be associated
22 with a chromatid discontinuity visible on chromosomes in metaphase and localize at APH-
23 induced FANCD2 mitotic twinned foci(Guervilly et al. 2015), which mark CFS in
24 mitosis(Chan et al. 2009; Naim & Rosselli 2009). Moreover, SLX4 recruits XPF-ERCC1 and
25 MUS81-EME1 at CFS(Guervilly et al. 2015; Minocherhomji et al. 2015) and thus likely
26 promotes nucleolytic incisions at late replication intermediates in early mitosis (Figure 7).
27 Although dispensable for nucleases recruitment at mitotic foci(Guervilly et al. 2015), SLX4
28 SIMs are needed for maintenance of CFS and accurate chromosome segregation(Guervilly
29 et al. 2015; Ouyang et al. 2015).

30
31 While cleavage of replication intermediates at incompletely replicated CFS regions would
32 be sufficient for chromatids to segregate, these would remain under-replicated. Answers
33 to this conundrum were provided with the demonstration that SLX4-MUS81-EME1-
34 dependent cleavage in early mitosis promotes mitotic DNA synthesis (MiDAS) at CFS,
35 which is required for CFS expression(Minocherhomji et al. 2015) (Figure 7). This also
36 implies that CFS expression results from chromatin decondensation at sites of mitotic
37 DNA synthesis rather than DNA breakage. MiDAS constitutes a specialized form of DNA
38
39
40
41
42
43
44
45
46
47
48
49
50
51
52
53
54
55

1
2
3 replication detectable by EdU foci on metaphase chromosomes after a short pulse of EdU
4 incorporation(Bergoglio et al. 2013; Naim et al. 2013; Minocherhomji et al. 2015) and
5 likely represents a break-induced replication (BIR)-like mechanism requiring the HR
6 protein RAD52(Bhowmick et al. 2016) and POLD3, a regulatory subunit of DNA
7 polymerase(Minocherhomji et al. 2015). Importantly, MiDAS can also occur at telomeres
8 (Min et al. 2017; Özer et al. 2018).

9
10
11
12 The abrogation of MiDAS in SLX4-deficient cells(Minocherhomji et al. 2015) probably
13 stems from the defective recruitment of nucleases at CFS but SLX4 seems to additionally
14 promote the chromatin recruitment of RAD52 in early mitosis, which constitutes itself
15 another pre-requisite for MUS81 recruitment(Bhowmick et al. 2016) (Figure 7). These
16 data suggest that SLX4 plays an early and broad role during MiDAS and initially localizes
17 at CFS independently of MUS81. The later recruitment of MUS81 requires not only SLX4
18 but also RAD52 and PLK1(Minocherhomji et al. 2015; Bhowmick et al. 2016). More work
19 is needed to figure out how all three proteins may coordinate for the recruitment of
20 MUS81. How is SLX4 recruited itself to CFS? Earlier studies in chicken DT40 cells revealed
21 that TopBP1 promotes mitotic DNA synthesis and the recruitment of SLX4 in mitotic
22 foci(Pedersen et al. 2015). This potential TopBP1-dependent recruitment of SLX4 at CFS
23 still needs to be investigated in human cells. One possibility is that SLX4 might be
24 preloaded on chromatin at stalled replication forks before mitosis through its direct
25 interaction with TopBP1(Gritenaite et al. 2014) (Figure 7). SLX4 would then recruit its
26 associated nucleases for the processing of secondary DNA structures, the nature of which
27 is currently unknown, and initiates MiDAS to ensure proper chromosome segregation at
28 anaphase.
29
30
31
32
33
34
35
36
37
38
39
40
41
42
43

44 **Slx4 and Dpb11^{TopBP1}: lessons from yeast studies**

45
46
47 In this section, we discuss how the analysis of the interplay between budding yeast Slx4
48 and the BRCT-containing scaffold proteins Rt107 and Dpb11 uncovered new roles for Slx4
49 that are highly regulated by phosphorylation and protein-protein interactions. Briefly,
50 these interactions allow Slx4 to restrain Rad53 activation in response to replication stress
51 while locally promoting Mec1 activity. They also promote the function of Mus81-Mms4 in
52
53
54
55
56
57
58
59
60

1
2
3 the resolution of joint molecules (JM) and have recently turned out to contribute to DNA
4 end resection. As human SLX4 also interacts with TopBP1^{Dpb11} in a manner requiring the
5 CDK-dependent phosphorylation of threonine 1260 of SLX4(Gritenaite et al. 2014), these
6 yeast studies may eventually shed new light on our very limited understanding of the
7 relevance of this interaction in higher eukaryotes.
8
9
10

11 12 13 14 ***The Slx4/Rtt107 association with Dpb11^{TopBP1} dampens Rad53 activation***

15 In response to MMS-induced DNA damage, Slx4 forms a ternary complex with the multi-
16 BRCT domain scaffolds Dpb11 and Rtt107(Ohouo et al. 2010; Ohouo et al. 2013). Complex
17 formation depends on both Mec1^{ATR}, the sensor kinase of the DNA damage checkpoint and
18 CDK(Ohouo et al. 2010; Ohouo et al. 2013). In this complex where SLX4 bridges both
19 proteins, Rtt107 contributes to the stable association between Slx4 and Dpb11(Ohouo et
20 al. 2010). Formation of the Rtt107-Slx4-Dpb11 complex counteracts the Rad9^{53BP1}-
21 mediated activation of Rad53 in response to MMS (Figure 8)(Ohouo et al. 2013).
22 Accordingly, *slx4Δ* cells display hyper-phosphorylated Rad53 combined with enhanced
23 phosphorylation of Rad53 targets. Furthermore their hypersensitivity to MMS is
24 suppressed by a defect in Rad9-Rad53 signaling, suggesting that sustained activation of
25 Rad53 in the absence of Slx4 is toxic(Ohouo et al. 2013; Gritenaite et al. 2014; Cussiol et al.
26 2015; Balint et al. 2015; Jablonowski et al. 2015). This anti-checkpoint function of Slx4,
27 which is independent of Slx1 and Rad1^{XPF}, relies on the competition between Slx4-Rtt107
28 and the checkpoint adaptor Rad9 for binding to Dpb11(Ohouo et al. 2013).
29
30
31
32
33
34
35
36
37
38

39 The molecular bases of this mechanism named DAMP (Dampens checkpoint Adaptor
40 Mediated Phospho-signaling) have been investigated in detail by Smolka and colleagues
41 and are represented in Figure 8. DAMP relies on the simultaneous interaction of Rtt107
42 with SLX4 and H2A phosphorylated by Mec1 ((γ H2A), via its N-terminus (BRCT1-4) and
43 its last two BRCT domains 5 and 6, respectively(Zappulla et al. 2006; Roberts et al. 2006;
44 Li et al. 2012; Ohouo et al. 2013). It also relies on the binding by Dpb11 to SLX4
45 phosphorylated by CDK at serine S486 and by Mec1 at SQ/TQ sites (Downey et al. 2010;
46 Ohouo et al. 2010; Gritenaite et al. 2014). This Dpb11-Slx4 interaction relies on the BRCT
47 domains 1 and 2 of Dpb11 which also mediate interaction with phosphorylated
48 Rad9(Pfander & Diffley 2011). This and the fact that Rad9 can also directly interact with
49 γ H2A via its own BRCT domain(Hammet et al. 2007) strongly supports a competition-
50
51
52
53
54
55
56
57
58
59
60

1
2
3 based mechanism between the Slx4-Rtt107 complex and Rad9 for mutually exclusive
4 binding to Dpb11 (Figure 8)(Ohouo et al. 2013; Cussiol et al. 2015).

5
6 Intriguingly, mutations in BRCT domains 3 and 4 of Dpb11 were found to reduce
7 interaction with Slx4(Gritenaite et al. 2014; Cussiol et al. 2015). The DAMP model would
8 predict that this is the indirect consequence of the loss of interaction between BRCT3/4 of
9 Dpb11 and the Mec1-targeted Ddc1 subunit of the PCNA-like 9-1-1 checkpoint complex
10 (Figure 8) (Puddu et al. 2008; Cussiol et al. 2015). Accordingly, phosphorylation of Ddc1
11 on T602 contributes, together with γ H2A, to the formation and/or stabilization of the
12 whole Rtt107-Slx4-Dpb11 complex on chromatin(Cussiol et al. 2015), but Pfander and
13 colleagues did present evidence for a possible direct interaction between Slx4 and Dpb11
14 BRCT3/4 that is reduced by an S486A phospho-mutation in Slx4(Gritenaite et al.
15 2014)(Figure 8)

16
17 This discrepancy is of importance as it impacts on the possible architectures of the protein
18 complexes involving Dpb11 and Slx4. It is unclear how Slx4 would compete with Rad9 for
19 binding to Dpb11(Ohouo et al. 2013) if they interact with two different pairs of BRCT
20 domains of Dpb11(Gritenaite et al. 2014). Furthermore, it is unclear how Slx4 and Ddc1
21 could co-immunoprecipitate(Cussiol et al. 2015) if they share the same binding interface
22 on Dpb11. Thus, we favor and will discuss in more detail the model of Slx4 binding to
23 BRCT1/2, at least in response to MMS, with the understanding that both pairs of BRCT
24 may contribute to Slx4 interaction based on the currently available data. A direct
25 interaction between Slx4 and BRCT3/4 of Dpb11 could be specifically relevant in G2/M
26 and may allow the formation of distinct Slx4-Dpb11 complexes with different biological
27 properties (Figure 8).

28
29 To further support their proposed architecture of the Rtt107-Slx4-Dpb11-Ddc1 complex,
30 Cussiol and colleagues provided the elegant demonstration that the need for Slx4 in this
31 edifice could be artificially replaced by a minimal multi-BRCT domain module (MBD)
32 consisting of the fusion between Dpb11 BRCT3/4 (binding to pT602 Ddc1) and Rtt107
33 BRCT5/6 (binding to γ H2A)(Figure 8). Remarkably, expression of the MBD module was
34 sufficient to suppress both the hyper-activation of Rad53 and the hypersensitivity to MMS
35 of *slx4* Δ cells(Cussiol et al. 2015).

36
37 Altogether, these studies revealed that the DNA damage-dependent induction of
38 checkpoint signaling by Mec1 and the phosphorylation of at least three of its targets, Slx4,
39

1
2
3 H2A and Ddc1, initiates a negative feedback loop that specifically restrains the Rad9-
4 dependent Rad53 activation, through the formation of the Rtt107-Slx4-Dpb11
5 complex(Ohouo et al. 2010; Ohouo et al. 2013; Cussiol et al. 2015).
6
7
8
9

10 ***Slx4/Rtt107 promotes local Mec1 signalling behind stressed forks***

11
12 Unexpectedly, while Slx4 counteracts Rad53 signaling it locally increases Mec1 activity
13 towards specific targets behind stressed forks(Balint et al. 2015). Indeed, unbiased
14 proteomics analysis revealed a moderate but significant decrease in a subset of Mec1-
15 dependent SQ/TQ phosphorylation sites in *slx4*Δ cells(Balint et al. 2015). Notably, H2A,
16 Rtt107 and Dpb11 phosphorylation partially or strongly depends on Slx4 and the
17 formation of the Rtt107-Slx4-Dpb11-Ddc1 module(Balint et al. 2015), suggesting that this
18 macromolecular complex simultaneously promotes the phosphorylation of its own
19 components by the Mec1 kinase while dampening Rad9-dependent Rad53 activation
20 (Figure 9). This model also provides an explanation to earlier observations on the
21 interdependency between Slx4 and Rtt107 for their phosphorylation in response to DNA
22 damage(Roberts et al. 2006; Lévesque et al. 2010).
23
24
25
26
27
28
29
30

31 How can Slx4 positively control Mec1? Clues to this question came from investigating
32 where and how the assembly of the Rtt107-Slx4-Dpb11 complex occurs relative to the
33 replication fork in response to MMS. Using ChIP-seq experiments Balint and coworkers
34 provide evidence that the Slx4 complex assembles behind replication forks(Balint et al.
35 2015). The recognition of γ H2A by Rtt107 recruits Slx4, which itself triggers the
36 recruitment of Dpb11 at loci that are distal from the replication fork, in association with
37 the 9-1-1 complex(Balint et al. 2015). Hence, Slx4 promotes the formation of Dpb11-
38 containing signalling complexes behind the fork, thereby locally driving further activation
39 of Mec1 (Figure 9).
40
41
42
43
44
45

46 Overall, Slx4 uncouples Mec1 signalling from its downstream effector kinase Rad53
47 behind stressed replication forks and may promote post-replication repair mechanisms by
48 facilitating Mec1-regulated DNA repair and limiting Rad53-mediated cell cycle arrest.
49 Furthermore, Slx4 may alleviate the inhibition by Rad53 of DNA repair enzymes such as
50 Exo1(Segurado & Diffley 2008; Morin et al. 2008). As discussed below, one major outcome
51
52
53
54
55
56
57
58
59
60

1
2
3 of the Slx4-dependent repression of Rad53 activity seems to be the timely activation of the
4 Mus81-Mms4 nuclease(Szakal & Branzei 2013; Gritenaite et al. 2014; Cussiol et al. 2015).
5
6

7
8 ***The Rtt107 and Dpb11 scaffolds both connect Slx4 to the Mms4 subunit and promote***
9 ***Mus81-Mms4 activation***
10

11 A critical function of the Rtt107-Slx4-Dpb11 complex relies on the regulation of the
12 Mus81-Mms4^{EME1} endonuclease in mitotic cells as well as in the recovery from DNA
13 damage(Gritenaite et al. 2014; Cussiol et al. 2015; Jablonowski et al. 2015). MMS induces
14 the formation of joint molecules (JM) between sister chromatids, presumably representing
15 template-switch (TS) events at replication forks, which need to be processed by Sgs1 or
16 nuclease-dependent pathways(Liberi et al. 2005; Szakal & Branzei 2013). Interestingly,
17 the *slx4-S486A* mutation that strongly affects Slx4/Dpb11 interaction causes a delay in
18 replication completion after MMS and a defect in the resolution of JM that accumulate in
19 MMS-treated *sgs1Δ* cells(Gritenaite et al. 2014). However, it does not further increase the
20 strong MMS hypersensitivity and JM resolution defects of *mms4Δ* cells, suggesting that the
21 Slx4-Dpb11 complex promotes the processing of JM by Mus81-Mms4. Moreover,
22 suppression of the MMS hypersensitivity of *slx4Δ* cells by a partial inactivation of the DNA
23 damage checkpoint or expression of the MBD module strictly requires Mus81-
24 Mms4(Gritenaite et al. 2014; Cussiol et al. 2015; Jablonowski et al. 2015). This implies that
25 a crucial function of Slx4 in dampening Rad53 signalling is the timely activation of Mus81-
26 Mms4 (Figure 8 and 9). As further discussed below, this would be consistent with
27 previous suggestions that the replication checkpoint negatively controls Mus81-Mms4
28 (Kai et al. 2005; Szakal & Branzei 2013; Gritenaite et al. 2014) (and see below).
29
30

31 A role for Slx4 in the resolution of JM is consistent with earlier findings showing that *Slx4*
32 genetically interacts in response to MMS with genes involved in error-free DNA damage
33 bypass such as *Mms2*, *Rad6*, *Rad18*(Flott et al. 2007), which promote the formation of JM
34 by template-switch (TS) events through a PCNA polyubiquitination-dependent
35 pathway(Branzei et al. 2008). Precluding the formation of JM in MMS-treated specific TS
36 mutants (*e.g. mms2Δ*) would exclude the subsequent need for Slx4 in promoting JM
37 resolution (as no substrate of Mus81-Mms4 would be formed), explaining the epistatic
38 relationship between *Slx4* and the error-free DNA damage avoidance pathway.
39 Surprisingly, this genetic interaction was not reproduced in the *slx4-S486A* background,
40
41
42
43
44
45
46
47
48
49
50
51
52
53
54
55

1
2
3 which further exacerbates the MMS hypersensitivity of *rad5* and *mms2* mutants(Gritenaite
4 et al. 2014).

5
6 Based on previous studies Slx4 does not directly interact with Mus81(Schwartz et al.
7 2012), so how could it promote the resolution of late HR intermediates by Mus81-Mms4?
8 Dpb11 actually bridges Slx4 and Mms4 within the same complex during recovery from
9 MMS-induced DNA damage and in nocodazole-arrested cells (G2/M)(Gritenaite et al.
10 2014). This cell cycle-regulated interaction between Mms4 and Dpb11 is likely
11 direct(Gritenaite et al. 2014) and involves Dpb11 BRCT3/4 domains(Cussiol et al. 2015)
12 (Figure 8). Importantly, Slx4-Dpb11-Mms4 complex formation in mitosis was found to
13 require Cdc28^{CDK} and Cdc5^{PLK1} activities(Gritenaite et al. 2014), reminiscent of the
14 phosphorylation-regulated formation of the SLX-MUS complex in human cells. As
15 previously discussed, both Cdc28^{CDK} and Cdc5^{PLK1} phosphorylate Mms4, which stimulates
16 Mus81-Mms4 enzymatic activity in G2/M(Matos et al. 2011; Gallo-Fernandez et al. 2012;
17 Szakal & Branzei 2013; Matos et al. 2013; Dehé & Gaillard 2017). The possibility that
18 phosphorylation of Mms4 in G2/M drives a direct interaction with Dpb11 was recently
19 investigated(Princz et al. 2017). Supporting this hypothesis, mutating a single CDK site
20 (S201A) in Mms4 strongly impedes its interaction with Dpb11(Princz et al. 2017).
21 However, it has no obvious impact on the *in vitro* HJ resolvase activity of Mus81-
22 Mms4(Princz et al. 2017), which is also impervious to the reduced Slx4-Dpb11 interaction
23 in *slx4-S486A* cells(Gritenaite et al. 2014; Princz et al. 2017). This suggests that Slx4-
24 Dpb11 supports Mus81-Mms4 function *in vivo* without affecting its nuclease activity,
25 perhaps through the spatio-temporal recruitment of Mus81-Mms4.
26
27

28
29 Adding to the complexity of the picture, it appears that Cdc7-Dbf4 (or DDK: Dbf4-
30 dependent kinase), mostly known for its role in initiating replication, is an additional
31 kinase that contributes to the up-regulation of Mus81-Mms4 in G2/M(Princz et al. 2017).
32 DDK acts in concert with Cdc5 and Rtt107 to promote full Mms4 hyper-phosphorylation
33 and increased HJ resolvase activity of Mus81-Mms4 *in vitro*(Princz et al. 2017). Cdc5 and
34 DDK are linked to the Rtt107-Slx4-Dpb11 complex by a direct interaction between Cdc7
35 and Rtt107(Princz et al. 2017) (Figure 8 and 9). Importantly, Princz et al. provide strong
36 evidence that Rtt107 and Slx4 may actually associate with Mms4 independently of Dpb11,
37 perhaps through a yet to be demonstrated direct interaction between Rtt107 and Mus81-
38
39
40
41
42
43
44
45
46
47
48
49
50
51
52
53
54
55
56
57
58
59
60

1
2
3 Mms4. This suggests that Mus81-Mms4 can be connected to Slx4 by either one of the
4 Rtt107 and Dpb11 scaffolds(Princz et al. 2017).
5

6 In addition, the currently available data suggests that there are differences in the way
7 Mms4 interacts with Rtt107-Slx4-Dpb11 depending on whether the cell is recovering from
8 an MMS-challenged replication or transitioning from G2 to M without having been
9 exposed to DNA damage. For instance, Slx4 is not required for the mitotic interaction
10 between Dpb11 and Mms4 while the Slx4-S486A mutation strongly disrupts the MMS-
11 induced interaction between Dpb11 and Mms4(Gritenaite et al. 2014). In line with this,
12 *slx4-S486A* cells present a reduced level of Mms4 phosphorylation in response to MMS
13 (but not in G2/M), which may contribute to their defect in JM resolution and
14 hypersensitivity to MMS(Gritenaite et al. 2014).
15
16

17 The differences between mitotic and DNA damage-inducible complexes involving both
18 Slx4 and Mms4 could also stem from the status of Rad53 activation, as the replication
19 checkpoint has been suggested to negatively regulate Mus81-Mms4 function(Szakal &
20 Branzei 2013; Gritenaite et al. 2014). Speculatively, the proposed inhibition of Cdc5 by
21 Rad53(Sanchez et al. 1999; Zhang et al. 2009) could represent a way to restrain the
22 formation of the Rtt107-Slx4-Dpb11-Mms4 complexes in S phase. In agreement with this
23 possibility, *slx4-S486A* cells display Rad53 over-activation combined with a less
24 pronounced increase in Cdc5 protein levels after MMS. This may account for the defective
25 interaction between Dpb11 and Mms4, as well as reduced phosphorylation levels of
26 Mms4(Gritenaite et al. 2014) and explain how the DAMP mechanism could promote
27 Mus81-Mms4 activation by limiting Rad53 activation (Figure 9).
28
29
30
31
32
33
34
35
36
37
38
39
40

41 ***Slx4/Rtt107 inhibits the Rad9 block to DNA resection***

42 Recently, budding yeast Slx4 was shown to stimulate long-range DNA end
43 resection(Dibitetto et al. 2015; Liu et al. 2017). This is mediated by a mechanism similar to
44 DAMP in which Slx4 is recruited in the vicinity of an irreparable DSB in a Rtt107- and
45 Dpb11-Ddc1-dependent manner, where it antagonizes Rad9^{53BP1} chromatin
46 localization(Dibitetto et al. 2015). Since Rad9^{53BP1} represents a molecular barrier that
47 limits 5' to 3' resection(Granata et al. 2013), its SLX4-driven displacement promotes long-
48 range resection (>10kb)(Dibitetto et al. 2015; Liu et al. 2017). In *slx4Δ* cells, persistent
49 Rad9^{53BP1} at DSBs is coupled to increased levels of Rad53 phosphorylation due to the
50
51
52
53
54
55
56
57
58
59
60

1
2
3 simultaneous loss of DAMP and compromises checkpoint adaptation in cells facing an
4 irreparable DSB as well as in cells with uncapped telomeres(Dibitto et al. 2015).
5 Remarkably, the physiological competition between Slx4-Rtt107 and Rad9 for binding to
6 Dpb11 can be mimicked using a BRCT3/4^{Dpb11}-Rad9 fusion protein that represents a
7 strong block to resection and which is antagonized by the co-expression of the MBD
8 (BRCT3/4^{Dpb11}-BRCT5/6^{Rtt107})(Liu et al. 2017). Moreover, deletion of *slx4* further
9 exacerbates the resection defect in the absence of Sae2^{CtIP}, an important endonuclease
10 involved in DNA end-resection, in coordination with the MRX^{MRN} complex(Dibitto et al.
11 2015).

12
13 However, it is noteworthy that Slx4 *per se* is not required for short-range resection and
14 the mild long-range resection defect of *slx4Δ* cells cannot account for their strong defect in
15 SSA(Flott et al. 2007; Li et al. 2008). Instead, as discussed earlier in this review, the main
16 function of Slx4 in SSA is to stimulate the removal by the Rad1^{XPF}-Rad10^{ERCC1} of non-
17 homologous 3' single-strand tails formed after resection at both ends of the DSB(Flott et
18 al. 2007; Li et al. 2008; Toh et al. 2010). This function of Slx4 also relies on its Mec1/Tel1-
19 dependent phosphorylation, but this targets different SQ/TQ sites than the ones involved
20 in Dpb11 interaction(Flott et al. 2007; Toh et al. 2010).

21
22 Interestingly, *slx4Δ sae2Δ* double mutants are more sensitive to MMS and CPT than each
23 single mutant, but this hypersensitivity is almost fully suppressed by *rad9*
24 deletion(Dibitto et al. 2015), suggesting that Slx4 may also promote resection at stalled
25 replication forks by antagonizing Rad9, in addition to dampening Rad53 activation and
26 promoting Mus81-Mms4 function. As previously mentioned, Rad53 inhibits
27 Exo1(Segurado & Diffley 2008; Morin et al. 2008), so Slx4 may also promote resection by
28 indirectly activating Exo1. Moreover, expression of a BRCT3/4^{Dpb11}-Rad9 fusion protein
29 suppresses RPA and Rad52 foci formation induced by MMS, but this is counteracted by co-
30 expressing the MBD module(Liu et al. 2017). This points to a possible role for Slx4 in
31 promoting resection of nascent strand DNA, especially on the lagging strand (Figure 9).
32 This would locally generate ssDNA that triggers the activation of Mec1, possibly
33 contributing to the role of Slx4 in potentiating Mec1 activity behind stressed forks(Balint
34 et al. 2015).
35
36
37
38
39
40
41
42
43
44
45
46
47
48
49
50
51
52
53
54
55
56
57
58
59
60

Telomeric functions of SLX4

Telomeres are repetitive DNA sequences at the end of chromosomes that allow the formation of the so-called shelterin complex, a specialized nucleo-protein structure that protects chromosome ends from degradation, illegitimate repair and checkpoint activation. The length of telomeres gradually decreases with each cell division, eventually leading to replicative senescence (Maestroni et al. 2017). However, re-activation of telomerase, a specialized reverse-transcriptase usually not expressed in somatic cells, counteracts telomere attrition and allows the vast majority of cancer cells to escape senescence, while a subset of tumors (10-15%) maintain their telomeres through the alternative lengthening of telomeres (ALT) pathway, a recombination-based mechanism.

The first hint that SLX4 may play a role at telomeres came with the identification of TRF2, which is an essential shelterin complex, as one of its binding partners in human cells (Fekairi et al. 2009; Munoz et al. 2009; Svendsen et al. 2009). In vertebrates, telomeric DNA is made of hundreds of short tandem 5' TTAGGG 3' repeats, which are bound by TRF2, and ends in a single-stranded G-rich 3' overhang. Due to the repetitive nature of telomeric DNA the 3' overhang can fold back and invade upstream homologous duplex DNA forming a lariat structure called the T-loop with a three-way branched D-loop at its base (Figure 10). Formation of the T-loop, which requires TRF2 (Doksani et al. 2013), is believed to play an important part in protecting telomeres from the activation of ATM and NHEJ and the processing of an otherwise exposed single-stranded 3' overhang (for review see (Palm & de Lange 2008)).

All current evidence points towards SLX4 acting with its SSE partners as a negative regulator of telomere length (Vannier et al. 2012; Wan et al. 2013; Wilson et al. 2013; Saint-Léger et al. 2014; Sarkar et al. 2015; Rai et al. 2016; Yin et al. 2016; Sobinoff et al. 2017). Possibly related to this, SLX4 is also important to prevent fragility of telomeres (Wilson et al. 2013; Saint-Léger et al. 2014; Sarkar et al. 2015), which are prone to replication problems and share some features with CFS (Sfeir et al. 2009) for review (Maestroni et al. 2017)). However, given the variety of secondary DNA structures that can form at telomeres, they can metaphorically be viewed as a playground for SLX4-bound SSEs, which could potentially wreck havoc unless properly controlled. As discussed below, the interplay

1
2
3 between SLX4 and TRF2 has emerged as a critical module to prevent the unscheduled
4 processing of secondary DNA structures at telomeres.

5
6 Indeed, long before the discovery of human SLX4, TRF2 was suggested to prevent XPF-
7 ERCC1 from clipping off the single-stranded G-rich 3' overhang and promoting the fusion
8 of the blunt ended telomeres by NHEJ(Zhu et al. 2003). This was the first evidence that
9 TRF2 is essential to prevent unscheduled processing of telomeres by SSEs. Further
10 evidence that TRF2 restrains endonucleolytic activities at telomeres came with the
11 demonstration that it can bind to branched DNA structures including HJs and D-loops, via
12 its N-terminal basic B domain and inhibits their processing by various SSEs, including
13 SLX4-SLX1 and MUS81-EME1(Poulet et al. 2009; Saint-Léger et al. 2014; Sarkar et al.
14 2015). *In vivo* this translates into preventing abrupt telomere shortening and excision of
15 telomeric circles (T-circles) that would result from the endonucleolytic processing of the
16 HR intermediates formed at the base of the T-loop (Figure 10).
17
18
19
20
21
22
23
24
25

26 Interestingly, recent findings suggest that another contribution of the positioning of TRF2
27 on the D-loop is to prevent the recruitment of PARP1(Rai et al. 2016; Schmutz et al. 2017),
28 which itself can promote the recruitment and stabilization of SLX4 at sites of DNA
29 damage(González-Prieto et al. 2015; Rai et al. 2016). It thus appears that TRF2 is
30 endowed with key functions to both directly and indirectly protect telomeres from SLX4-
31 mediated endonucleolytic processing.
32
33
34
35

36 Nevertheless, as further discussed below, SLX4 is important for telomere homeostasis in
37 murine and human cells, which in the latter relies on SLX4-TRF2 complex formation
38 suggesting that elaborate regulatory mechanisms are needed to finely control the
39 interplay between TRF2 and SLX4.
40
41
42
43

44 ***Control of SLX4 at telomeres***

45 46 47 *Mediated by TRF2-SLX4 complex formation in human cells*

48
49 Although some SLX4 can be detected at telomeres in primary human fibroblasts and in
50 telomerase positive cancerous cells with moderately sized telomeres, telomeric SLX4 is
51 more readily detected in cells with unusually long telomeres(Svendsen et al. 2009; Wan et
52 al. 2013; Wilson et al. 2013; Sarkar et al. 2015; Garcia-Exposito et al. 2016). These also
53
54
55
56
57
58
59
60

1
2
3 include telomerase negative cancerous cells that rely on HR to maintain their telomeres
4 by the ALT mechanism (for review see(Lazzerini-Denchi & Sfeir 2016)). Accordingly, the
5 amount of SLX4 at telomeres assessed both by immunofluorescence and ChIP techniques
6 appears to be directly correlated to the length of telomeres(Wan et al. 2013; Wilson et al.
7 2013) and in ALT cells the majority of SLX4 foci colocalize with telomeric DNA in ALT
8 associated PML Bodies (APBs)(Wan et al. 2013). Although SLX4 can be found at telomeres
9 throughout the cell cycle(Wilson et al. 2013; Sarkar et al. 2015), there is a peak in the
10 amount of telomeric SLX4 in late S-phase(Sarkar et al. 2015).
11
12
13
14
15
16

17
18 Importantly, localization of human SLX4 at telomeres strongly relies on its interaction
19 with TRF2 as well as on its ability to homodimerize via its BTB domain(Wan et al. 2013;
20 Wilson et al. 2013; Yin et al. 2016). Interaction with TRF2 is mediated by hydrophobic
21 contacts between a unique TRF2 binding motif (TBM) HxLxP in human SLX4
22 (₁₀₂₀HR_{LAP1024}) and the TRF Homology (TRFH) domain of TRF2(Wan et al. 2013; Wilson
23 et al. 2013), which was previously shown to mediate interaction between TRF2 and the
24 YxLxP TBM motif of the Apollo exonuclease(Chen et al. 2008). In line with this,
25 crystallography analyses of the SLX4^{TBM}-TRF2^{TRFH} complex indicate that the overall fold of
26 the SLX4^{TBM} is identical to that of Apollo. Accordingly, an SLX4^{L1022A} mutant that cannot
27 bind to TRF2 no longer localizes at telomeres and conversely no WT SLX4 is found at
28 telomeres in cells producing a TRF2^{F120A} mutant that cannot bind to SLX4(Wan et al.
29 2013; Wilson et al. 2013).
30
31
32
33
34
35
36
37
38

39 *The TRF2-SLX4 interaction promotes telomere shortening and HR at telomeres*

40
41 The interaction between SLX4 and TRF2 appears to promote HR at telomeres and to
42 negatively control telomere length in ALT cells(Wan et al. 2013). Depleting SLX4 results
43 in rapid telomere elongation and reduced rates of telomeric sister chromatid exchange
44 (T-SCE) and T-Circle formation, which are commonly used readers of homologous
45 recombination at telomeres(Wan et al. 2013). This can be rescued with WT SLX4 but not
46 with an SLX4 mutant that cannot bind to TRF2 (SLX4^{L1022A}) or that cannot dimerize
47 (SLX4^{F681R,F708R}) (Wan et al. 2013; Yin et al. 2016). Importantly, the TRF2-mediated
48 recruitment of SLX4 is essential for the telomeric accumulation of all of its SSE
49 partners(Wan et al. 2013; Wilson et al. 2013). In U2OS ALT cells 80% of endogenous SLX4
50
51
52
53
54
55
56
57
58
59
60

1
2
3 foci are estimated to localize at telomeres(Wilson et al. 2013), with most of XPF-ERCC1
4 and SLX1 foci co-localizing with SLX4 at telomeres. This is not the case for MUS81, which
5 colocalizes with SLX4 at telomeres only in a subset of cells(Wilson et al. 2013).
6 Nevertheless, association of SLX4 with XPF-ERCC1, MUS81-EME1 and SLX1 is important
7 for T-SCEs in ALT cells(Wan et al. 2013), but only SLX4-SLX1 is needed to prevent
8 telomere elongation and generates T-Circles(Wan et al. 2013; Sarkar et al. 2015). Of note,
9 an earlier study showed that MUS81 is important for HR in ALT cells and that it can be
10 detected by CHIP in association with telomeric DNA(Zeng & Yang 2009). Intriguingly
11 though, association between MUS81 and telomeric DNA was found to increase in the
12 absence of TRF2(Zeng et al. 2009). This may suggest that MUS81 can also contribute to
13 telomere maintenance in ALT cells in a way that is independent of either SLX4-TRF2 or
14 SLX4-MUS81 complex formation.
15
16
17
18
19
20
21
22
23

24 *The TRF2-SLX4 interaction promotes telomere stability*

25
26 A correlation can be made between increased telomere length in cells lacking SLX4 and
27 increased rates of DNA damage and telomere fragility in ALT cells as well as in telomerase
28 positive cells with unusually long telomeres(Wilson et al. 2013; Saint-Léger et al. 2014;
29 Sarkar et al. 2015; Yin et al. 2016). Indeed, as discussed previously SLX4 helps in coping
30 with replication stress at specific genomic loci such as CFS, and its absence may add insult
31 to injury by leading to longer telomeres that are more difficult to replicate. Accordingly,
32 markers of telomere fragility (typically Multi-Telomeric Signals visualized by FISH) due to
33 replication problems appear in absence of SLX4 in U2OS cells(Sarkar et al. 2015; Yin et al.
34 2016), telomerase positive cells with long telomeres(Saint-Léger et al. 2014) and in *Slx4*^{-/-}
35 MEFs(Wilson et al. 2013). Telomere fragility that results from depletion of endogenous
36 SLX4 in U2OS cells cannot be rescued by an SLX4 mutant that cannot bind to TRF2 or to
37 SLX1, while it is rescued by mutants that cannot bind to XPF or MUS81(Sarkar et al.
38 2015). This suggests that SLX4-SLX1 is necessary to facilitate replication of telomeres in
39 U2OS ALT cells, not MUS81-EME1 and XPF-ERCC1. A contribution of SLX1 to preventing
40 telomere fragility in telomerase positive cells with extra long telomeres has not been
41 investigated, but both MUS81 and GEN1 have been shown to be important to prevent
42 telomere fragility in those cells(Saint-Léger et al. 2014). It remains to be determined
43 whether this reflects an SLX4-dependent or independent role of MUS81.
44
45
46
47
48
49
50
51
52
53
54
55
56
57
58
59
60

1
2
3 In addition, in both U2OS ALT cells and MEFs(Wilson et al. 2013), SLX4 prevents
4 telomeric DNA damage visualized as TIFs (Telomere Dysfunction Induced Foci where a
5 shelterin protein colocalizes with a DNA damage response marker such as 53BP1 or
6 γ H2AX). TIFs usually reflect a defect in chromosome end protection triggering checkpoint
7 signaling at telomeres. Interestingly, overexpression of SLX4^{L1022A} in U2OS is sufficient to
8 induce TIFs, presumably because SLX4-associated nucleases are sequestered away from
9 telomeres(Wilson et al. 2013). It remains to be determined which nuclease or set of
10 nucleases, if any, is needed to prevent a telomeric DNA damage response. Intriguingly, the
11 TBM of human SLX4 is only found in primates(Wilson et al. 2013). It is currently unclear
12 why a tight interaction between SLX4 and TRF2 has been acquired late during evolution.
13 Accordingly, endogenous SLX4 does not accumulate at telomeres in mouse cells(Wan et
14 al. 2013; Wilson et al. 2013). Nevertheless, it is required for telomere maintenance as
15 *Slx4*^{-/-} MEFs show increased telomere length, TIF formation and telomere fragility(Wilson
16 et al. 2013).

17
18 So how is SLX4 recruited at telomeres in mice? Clues may come from recent findings
19 showing that under certain circumstances, PARP1 can promote recruitment of SLX4 at
20 telomeres in mouse cells(Rai et al. 2016).

21 22 *TRF2 prevents abnormal/excessive SLX4-mediated telomere attrition*

23
24 A recent report suggests that a key feature of TRF2 might be to prevent via its B-domain
25 the formation of telomeric HJs by binding and locking into place the three-way branched
26 D-loop thereby preventing the action of HJ resolvases and excision of a T-circle(Schmutz
27 et al. 2017). However, as shown in Figure 10, T-circle excision and abrupt telomere
28 shortening can just as well occur by processing of a D-loop. Therefore, the role played by
29 the B-domain of TRF2 in preventing the excision of T-circles probably stands primarily in
30 its ability to shield secondary DNA structures at the base of the T-loop from
31 endonucleolytic processing rather than preventing the formation of dHJs(Poulet et al.
32 2009; Saint-Léger et al. 2014; Sarkar et al. 2015). We would like to suggest that
33 preventing the formation of dHJs might instead be critical to prevent the re-appearance of
34 a free telomeric end and the associated risks should it remain unprotected (Figure 10).
35 Another relevant role of the B-domain of TRF2 might relate to its ability to prevent the
36
37
38
39
40
41
42
43
44
45
46
47
48
49
50
51
52
53
54
55
56
57
58
59
60

1
2
3 recruitment of PARP1 at telomeres in mice(Rai et al. 2016; Schmutz et al. 2017). RAP1,
4 another shelterin subunit that binds to TRF2, also appears to be involved(Rai et al. 2016).
5
6 The importance of preventing PARP1 and SLX4 recruitment at telomeres in mouse cells is
7
8 underscored by the rapid and catastrophic telomere attrition that is observed in *Rap1*^{-/-}
9 MEFs where endogenous TRF2 has been replaced by a TRF2^{ΔB} mutant lacking its B-
10 domain(Rai et al. 2016). The same phenotype is observed in WT MEFs where endogenous
11 TRF2 is replaced by TRF2^{ΔB,L286R}, which cannot interact with RAP1. The underlying
12 mechanism is not quite clear at this stage but it ultimately results in fusions between
13 chromosome ends with no detectable telomeric DNA. Importantly, this does not rely on
14 classical or alternative NHEJ. Instead, it involves extensive resection of telomeres by MRN
15 and EXO1, which likely results in highly recombinogenic long G-rich 3' overhangs(Rai et
16 al. 2016). These may promote an increased rate of intra-chromatid HR and T-loop
17 formation. The unrestrained resolution by SLX4 and its associated SSEs of the secondary
18 DNA structures formed at the base of the T-loop may drive the excision of large T-circles
19 allowing the process to start over again and again, after formation of a new T-loop(Rai et
20 al. 2016; Schmutz et al. 2017).

21
22 Consistently with this model, expression of a TRF2^{ΔB} mutant in *Rap1*^{-/-} MEFs induces the
23 aberrant telomeric relocalization of PARP1, whose activity drives SLX4 recruitment and
24 telomere-free fusions(Rai et al. 2016). Although, not formally established in murine cells,
25 SLX4 and SLX1 were found to contribute to telomere free fusions in human fibroblasts
26 where TRF2 lacks its B domain and cannot bind RAP1(Rai et al. 2016). It remains to be
27 determined whether PARP1 promotes the cleavage of unprotected T-loops by SLX1-SLX4.
28

29
30 From a mechanistic stand-point, the formation of long G-rich 3' overhangs could facilitate
31 the invasion of more internal telomeric sequences further away from the chromosome
32 end. This would result in a larger T-loop than usual, the excision of which would lead to
33 loss of larger portions of telomeric DNA and accelerated telomere attrition. It may also
34 promote inter-chromosomal recombination, which may explain the high rate of end-to-
35 end fusions between chromosomes in a process that involves HR instead of cNHEJ or
36 aNHEJ(Rai et al. 2016).
37

38
39 As previously mentioned, in *S. cerevisiae* Slx4 promotes long-range resection at
40 irreparable DSBs, and possibly telomeres, by competing with Rad9 for binding to
41
42
43
44
45
46
47
48
49
50
51

1
2
3 Dpb11(Dibitetto et al. 2015). It would be interesting to investigate whether a similar
4 mechanism is at stake at dysfunctional telomeres in mammalian cells where TRF2 cannot
5 properly prevent PARP1 recruitment. This would be yet another situation where SLX4
6 makes things worse by instigating a vicious circle in which it promotes extensive
7 telomere resection and T-loop formation followed by the unrestrained processing of HJs
8 and/or D-loops at the base of the T-loop.
9
10
11
12

13
14 Although the PARP1-dependent recruitment of SLX4 occurs at dysfunctional
15 telomeres(Rai et al. 2016), it could provide a way to fine-tune the activity of SLX4 at
16 telomeres in normal conditions. Indeed, these findings may provide new clues to solve the
17 conundrum of how human TRF2 promotes recruitment of SLX4 and its associated SSEs
18 for negative regulation of telomere length, and telomeric HR in ALT cells, while inhibiting
19 DNA processing by these enzymes. A tempting hypothesis is that post-translational
20 modification of the B-domain of TRF2 could negatively control its interaction with the
21 base of the T-loop. This would subsequently allow for recruitment of PARP and promote
22 timely processing of secondary DNA structures by the SLX4-associated SSEs.
23 Interestingly, the SIMs of SLX4 were recently shown to stabilize SLX4 at telomeres
24 suggesting that other PTMs, including protein SUMOylation, contribute to the regulation
25 of the telomeric functions of SLX4(Ouyang et al. 2015).
26
27
28
29
30
31
32
33
34
35

36 ***Interplay between SLX4 and helicases at telomeres***

37
38

39 As discussed in the previous section of the role of SLX4 during replication, functional
40 interplays between SLX4, its associated SSEs and DNA helicases are critical for
41 chromosome stability. As briefly discussed below, telomeres are no exception to this.
42
43
44

45 *RTEL1*

46 In mice, RTEL1 is recruited by TRF2 to dismantle/unfold the T-loop in S-phase(Sarek et
47 al. 2015) and facilitate telomere replication(Vannier et al. 2013)(Figure 10). This
48 prevents telomere loss occurring through the excision of telomeric circles that results
49 from SLX4-mediated endonucleolytic resolution of the T-loop by SLX1 and, to some
50 extent, XPF-ERCC1(Vannier et al. 2012). Surprisingly, SLX4 makes neither positive nor
51
52
53
54
55
56

1
2
3 negative contribution to telomere fragility resulting from *Rtel1* deletion(Vannier et al.
4 2012). Unexpectedly, a recent report now shows that telomerase is what causes the
5 trouble in absence of RTEL1. The model by Boulton and colleagues proposes that
6 telomerase loads on the single-ended duplex branch that forms at a reversed replication
7 fork and which mimics a telomere(Margalef et al. 2018). Moreover, telomerase
8 recruitment, but not its activity, drives telomere loss and telomere fragility in the absence
9 of RTEL1 but is also required for the strong accumulation of SLX4 at telomeres in RTEL1-
10 deficient cells(Margalef et al. 2018). It will be important to investigate what mediates the
11 recruitment of SLX4 and whether it accumulates at reversed forks and/or at T-loops that
12 have not been unfolded by RTEL1.
13
14
15
16
17
18
19
20

21 *BLM*

22 Sarkar and colleagues detected a strong increase of T-circles and T-SCEs after depletion of
23 BLM in U2OS cells(Sarkar et al. 2015). Importantly, getting rid of both BLM and SLX4 was
24 like getting rid of SLX4 alone, resulting in low levels of T-SCE and T-circles. This suggests
25 that BLM, which can unfold a telomeric T-loop *in vitro*, counteracts SLX4-dependent
26 endonucleolytic processing of the T-loop(Sarkar et al. 2015).
27
28
29
30

31 It appears that BLM and SLX4 define two competing pathways that are important for the
32 maintenance of ALT telomeres(Sobinoff et al. 2017). One relies on the BLM helicase and
33 promotes telomeric extension by an ALT-mediated telomere synthesis mechanism related
34 to BIR. The other instead relies on SLX4, SLX1 and XPF and involves the processing of
35 secondary DNA structures in a way that aborts BLM-mediated DNA synthesis while
36 promoting T-SCEs(Sobinoff et al. 2017). SLX4 overexpression reduces various hallmarks
37 of ALT, including inter-telomeric tag copying , APBs and C-circles(Sobinoff et al. 2017). C-
38 circles are distinct from double-stranded T-circles generated by T-loop excision. They
39 consist of a single-stranded closed circular C-strand, a portion of which is paired to some
40 G-strand(Henson et al. 2009). They are primarily found, but not only (see SMARCAL1
41 section), in ALT cells where they are formed by an unknown mechanism that involves the
42 BLM helicase and is counteracted by SLX4(Sobinoff et al. 2017). Further work is needed
43 to understand how exactly the balance between the BLM “pro-lengthening” and SLX4
44 “anti-lengthening” pathways is controlled to ensure telomere length homeostasis in ALT
45 cells.
46
47
48
49
50
51
52
53
54
55
56

SMARCAL1

SMARCAL1 fulfills important functions in both HeLa cells with long telomeres and in hESCs cells, by preventing telomeric DNA damage and the accumulation of C-circles (Poole et al. 2015; Rivera et al. 2017). Intriguingly, accumulation of C-circles in HeLa cells with long telomeres partially relies on SLX4 (Poole et al. 2015). This is at odds with the aforementioned role of SLX4 in suppressing C-circles formation in ALT cells (Sobinoff et al. 2017) and suggests a distinct pathway to generate C-circles in SMARCAL1-deficient telomerase-positive cells. It also provides the first example of C-circle formation in non-ALT cells without the accumulation of other ALT markers.

SMARCAL1 also relieves replication stress at ALT telomeres and prevents RAD51-dependent clustering of damaged telomeres in large foci that is thought to occur following SLX4-promoted cleavage of stalled replication forks (Cox et al. 2016).

Less explored functions of SLX4

SLX4, HIV infection and innate immune response

In a seminal study, Laguette and colleagues uncovered a physical and functional interaction between the HIV-1 (human immunodeficiency virus type 1) accessory viral protein Vpr and several members of the SLX4 complex including MUS81-EME1 and XPF-ERCC1 (Laguette et al. 2014). In contrast, SLX1 was not detected by MS in Vpr immunoprecipitates but this might reflect a possible exclusive binding to SLX4 between Vpr and SLX1 as both directly interact with the CCD of SLX4 (Fekairi et al. 2009; Laguette et al. 2014). Intriguingly though, SLX4, MUS81-EME1 but also SLX1 are required for Vpr-induced G2/M arrest (Laguette et al. 2014). This is thought to occur through a premature activation of the SLX4 complex by Vpr as well as its cellular binding partner VPRBP/DCAF1, a substrate adaptor of the CUL4A-RBX1-DDB1 complex, previously involved in Vpr-dependent G2/M arrest (Laguette et al. 2014). Vpr and VPRBP seem to remodel the SLX4 complex, inducing a precocious recruitment to SLX4 of MUS81, phosphorylated EME1 and active PLK1, which may target replication intermediates leading in fine to a G2/M arrest. While the importance of the interaction between Vpr and SLX4 in mediating Vpr-induced G2/M arrest was further confirmed using various SIV

1
2
3 (simian immunodeficiency virus) Vpr proteins(Berger et al. 2014), it recently has been
4 challenged with the finding that Vpr still induces a G2/M arrest in cells where the CCD of
5 SLX4 has been deleted by CRISPR/Cas9(Fregoso & Emerman 2016). It will be important to
6 clarify this discrepancy.
7

8
9 Overall, the available data suggest that SLX4 is hijacked by the Vpr protein to promote a
10 DNA damage response and a G2/M arrest, resulting in a high viral infectivity of HIV-
11 1(Laguette et al. 2014; Iijima et al. 2018). Another important aspect of the work by
12 Laguette et al. was the finding that Vpr also uses SLX4 and MUS81 to escape the innate
13 immune response, limiting for instance interferon (IFN) production(Laguette et al. 2014).
14 As SLX4 binds viral DNA in a Vpr-dependent manner and viral DNA accumulates in SLX4-
15 depleted HeLa cells upon HIV-1 infection(Laguette et al. 2014), it is possible that SLX4
16 somehow promotes the nucleolytic degradation of viral DNA to restrain innate immune
17 sensing. However, SLX4 also counteracts spontaneous innate immunity as IFN production
18 or phosphorylated IRF3 (Interferon Regulated Factor 3) are elevated in untreated SLX4-
19 deficient cells and in cells lacking the MUS81-interacting SAP domain of SLX4(Laguette et
20 al. 2014; Brégnard et al. 2016). The spontaneous innate immune response in these cells
21 appeared to likely be the consequence of the cytosolic accumulation of nucleic acids
22 sensed by the cGAS-STING pathway(Brégnard et al. 2016). LINE-1 DNA can be detected in
23 the cytoplasmic fraction of SLX4-deficient cells, suggestive of an enhanced LINE-1
24 retrotransposition activity. In line with this, using a reporter assay, SLX4 and MUS81 were
25 shown to restrain LINE-1 retrotransposition, which may involve the interaction of SLX4-
26 bound MUS81 with the LINE-1-encoded ORF1p RNA binding protein and the LINE-1
27 reverse-transcribed DNA(Brégnard et al. 2016). In agreement with their model, the
28 authors went on to show that inhibition of the reverse-transcriptase (RT) with Tenofovir
29 reduces the production of pro-inflammatory cytokines in SLX4-deficient cells(Brégnard et
30 al. 2016). As chronic inflammation can generate a favourable environment for cancer
31 development, this strengthens the notion that RT inhibition may be beneficial in cancer
32 therapeutics (reviewed in (Sciamanna et al. 2016)). However, more work is needed to
33 precisely understand how SLX4 and MUS81 limit retrotransposition and innate immune
34 signalling as in prostate cancer cells MUS81 has been reported to instead promote the
35 accumulation of cytosolic DNA and the STING-dependent IFN response(Ho et al. 2016).
36
37
38
39
40
41
42
43
44
45
46
47
48
49
50
51
52
53
54
55
56
57
58
59
60

SLX4, PARPi sensitivity and PARP1 interaction

One of the most promising breakthroughs in the area of personalized cancer medicine came through the discovery that PARP inhibition selectively sensitizes HR-deficient cells such as BRCA1/2-deficient breast and ovarian cancer cells (Bryant et al. 2005; Farmer et al. 2005). While the underlying molecular mechanism was initially proposed to be the accumulation of replication-associated DSBs arising from unrepaired single-strand breaks in the absence of PARP activity, the trapping of PARP1 onto DNA or the loss of its function in promoting replication fork restart may also account for the hypersensitivity of HR-deficient cells to PARP inhibitors (PARPi) such as olaparib (reviewed in (Helleday 2011)). Consistently with the function(s) of the SLX4 complex in HR, SLX4-deficient FA-P patient cells are also hypersensitive to olaparib (Kim et al. 2013). The MUS81-interacting SAP domain is mandatory for PARPi resistance while the SLX1-interacting CCD is partially needed (Kim et al. 2013). These functional requirements are reminiscent of the response to CPT treatment, suggesting that PARP1 or TOP1 trapping on DNA similarly engage the activity of SLX4-bound MUS81 and SLX1.

In the meantime, MS studies identified PARP1 as an SLX4 partner (Munoz et al. 2009; Ghosal et al. 2012; González-Prieto et al. 2015) but this interaction and its functional relevance remains so far under-investigated. However, efficient SLX4 recruitment to laser-induced DNA damage as well as its localisation to dysfunctional telomeres are dependent on PARP activity (González-Prieto et al. 2015; Rai et al. 2016), suggesting that SLX4 or one of its partner could recognize a PARylated substrate of PARP1 (or PARylated PARP1 itself) on chromatin. Hence, PARylation adds to the list of PTM (Ubiquitination, SUMOylation) that can recruit the SLX4 complex, allowing its spatial regulation.

TopBP1-SLX4

As previously discussed, the Dpb11-Slx4 interaction in budding yeast plays multiple roles in response to replication stress and human SLX4 also interacts with TopBP1^{Dpb11} in a manner requiring the CDK-dependent phosphorylation of the threonine 1260 of SLX4 (Gritenaite et al. 2014). However, the only proposed role so far for the TopBP1-SLX4 interaction in higher eukaryotes is the recruitment of SLX4 to mitotic foci revealed in DT40 cells (Pedersen et al. 2015). Future studies will undoubtedly reveal whether the interaction of SLX4 with TopBP1 is also multi-functional in human cells. Similarly to the

1
2
3 Slx4-Dpb11 complex in yeast, can it locally promote full ATR activation? Contribute to
4 checkpoint dampening by restraining CHK1 activation? Regulate MUS81-EME1 activity or
5 DNA end resection?
6
7
8
9

10 **Concluding remarks**

11
12 This review illustrates how SLX4 has emerged as an important player in diverse aspects of
13 genome maintenance. Many functions of this fascinating protein rely on its interaction
14 with structure-specific nucleases (SSEs) but more work is needed to precisely understand
15 how SLX4 can control and stimulate their activity. In addition to SSEs, SLX4 has a number
16 of other partners that also contribute to the maintenance of genome stability but it still is
17 largely unclear how the molecular architecture of the SLX4 complex is dynamically
18 regulated *in vivo* and which, if any, distinct SLX4 subcomplexes can coexist. While there
19 has been a plethora of reports on the functions that SLX4 fulfills via its interaction with its
20 SSE partners, much less is known about the functional ties between SLX4 and some of its
21 other partners. This applies to the direct interaction of SLX4 with the MSH2 subunit of the
22 MutS beta (MSH2-MSH3)(Svendsen et al. 2009) and MutS alpha (MSH2-MSH6)(Ghosal et
23 al. 2012) mismatch repair complexes, the functional importance of which remains so far
24 undocumented. It also applies to its association with C20orf94/SLX4IP(Svendsen et al.
25 2009), a protein of currently unknown function. Considering that deletion of *SLX4IP* is one
26 of the most common alterations in childhood acute lymphoblastic leukemia (Meissner et
27 al. 2014), it will be important to understand how it may eventually contribute to the
28 tumor suppressive functions of SLX4. These certainly involve its requirement for genome
29 stability but the spontaneous overproduction of pro-inflammatory cytokines upon SLX4
30 deficiency(Brégnard et al. 2016) may also create a favorable environment for
31 tumorigenesis. Furthermore, SLX4 has been proposed to play a role in concert with
32 monoubiquitinated FANCD2 in activating the transcription of TAp63 (an isoform of p63),
33 which may constitute another tumour suppressive function of SLX4 in promoting
34 senescence{Park:2013ez}. Thus, it is not surprising that *SLX4* mutations seem relatively
35 frequent in various cancer types(Sousa et al. 2015). Considerably more work is needed to
36 better understand the functional impact of the vast majority of these mutations and how
37 they may contribute to the emergence and/or evolution of cancer. Importantly, given the
38 variety of functions SLX4 fulfills, mutations that impair some of these functions will likely
39
40
41
42
43
44
45
46
47
48
49
50
51
52
53
54
55
56

1
2
3 turn out to be associated with other human diseases that are not necessarily related to
4 cancer.
5
6
7
8
9
10
11
12
13
14
15
16
17
18
19
20
21
22
23
24
25
26
27
28
29
30
31
32
33
34
35
36
37
38
39
40
41
42
43
44
45
46
47
48
49
50
51
52
53
54
55
56
57
58
59
60

For Peer Review Only

Figure Legends

Figure 1

A- Schematic representation of SLX4 proteins and their partners from *Homo sapiens* (H.s.), *Mus musculus* (M.m.), *Galus galus* (G.g.), *Xenopus laevis* (X.l.), *Drosophila melanogaster* (D.m.), *Caenorhabditis elegans* (C.e.), *Saccharomyces cerevisiae* (S.c.) and *Schizosaccharomyces pombe* (S.p.). Only direct binding partners are shown. In the case of the human SLX4 protein, a list of selected proteins that have been shown to co-IP with SLX4 is also indicated. Proteins with dimmed colors and clear lettering represent likely direct partners for which formal demonstration of direct interaction with SLX4 has not yet been established. Although potential SIMs are found in other species, only SIMs in vertebrate SLX4 are represented because of their homology with the experimentally-verified SIMs of human SLX4. Rad1-Rad10, RTT107, Saw1 are direct partners of Slx4 in S.c. but their interaction domains on Slx4 have not yet been mapped.

Figure 2 SLX4 and the processing of secondary DNA structures during homologous recombination

A Repair of a double-strand break (DSB) flanked by two regions of homology (yellow) by single-strand annealing (SSA) in *S. cerevisiae*. See text for details.

B Schematic representation of the repair of a DSB by various homologous recombination pathways (HR). The grey arrow heads represent the action of the BLM-TOPOIII-RMI1-RMI2 complex during the so-called dissolution process of double Holliday junctions. The green and red arrow heads represent the action of structure-specific endonucleases on the various secondary DNA structures that can form during the repair of DSBs by HR. These range from single-strand 3' flaps that can form after strand recapture of the 3'-invading strand, such as during synthesis dependent strand annealing (SDSA), to the more complex Holliday junctions (HJs) or the recombination intermediates that precede the formation of mature HJs. The endonucleolytic resolution of the double HJs (dHJs) by HJ resolvases can yield both non-crossover and crossover products depending on which pair of exchanging strands will be cleaved in each HJ. The processing of intermediates that precede the formation of matured dHJs will yield only crossovers. See main text for more details.

Figure 3 SLX4 in ICL repair

A SLX4 is recruited in a UBZ-dependent manner to the ICL. While monoubiquitinated FANCD2 has been proposed to mediate this recruitment, another ubiquitinated chromatin component (X) may drive this targeting.

B Possibilities for incisions or ICL unhooking by the XPF-ERCC1 endonuclease. Bottom panel: incision 5' to the ICL can serve as an entry point for the SNM1A translesion exonuclease activity.

C Possibilities for ICL unhooking in the dual fork model.

D XPF or SLX4 deficiency may increase the use of an alternative, MUS81-dependent pathway for DSB generation.

Figure 4 Possibilities for SLX4-MUS81(-SLX1?)-dependent fork cleavage

A stalled replication fork (for instance following hydroxyurea treatment) can be cleaved by SLX4-associated MUS81-dependent nuclease generating a substrate for Homologous Recombination (HR)-dependent replication fork restart. Alternatively, stalled replication forks can undergo helicases-dependent fork reversal, creating a four-way junction that can be cleaved by MUS81, possibly in association with SLX4. Whether the SLX1 nuclease also cleaves stalled/reversed forks remains unknown. MUS81-dependent cleavage can also occur following resection of reversed forks. See main text for details.

Figure 5 SLX4-regulated fork collapse in different RS conditions

Top panel, left: in response to HU, PLK1 drives the formation of a BRCA1-MUS81-SLX4 complex that promotes the cleavage of stalled forks. However, it is still uncertain which of the EME1 or EME2 subunit is part of this complex. There is more and more evidence that EME2 is required for the cleavage of stalled forks but it remains to be formally determined whether or not it associates with SLX4. The same question applies in the presence of a reversed fork that could additionally be a substrate for SLX4-SLX1.

Top panel, right: in response to HU+ATRi, SLX4 may promote nuclease-independent fork collapse, although a functional redundancy between the nucleases associated to SLX4

1
2
3 cannot be excluded.
4

5 Lower panel: Both in response to HU+CHK1i and following Cyclin E overexpression, SLX4
6 can promote MUS81-dependent DSBs while preventing GEN1 to act on stalled/reversed
7 replication forks. This leads in SLX4-deficient cells to GEN1-dependent DSBs. However
8 cells expressing a SLX4 mutant unable to interact with MUS81 (DSAP) precludes both
9 MUS81- and GEN1-dependent DSB formation.
10
11
12
13
14
15
16

17 **Figure 6 Back-up or toxic function of SLX4 and MUS81 in BRCA2-deficient cells?**

18
19
20 Top panel, left. In the absence of BRCA2, reversed forks constitute an entry point for
21 nucleolytic degradation of nascent DNA.
22

23
24 Lower panel, left. SLX4 and MUS81 are needed for the proliferation of BRCA2-depleted
25 cells. MUS81 was notably shown to promote BIR-mediated fork restart, possibly through
26 the cleavage of partially resected reversed forks.
27
28

29
30 Left panel: Rondinelli et al. showed that EZH2 promotes the recruitment of MUS81 to
31 stalled replication forks and that this EZH2/MUS81 pathway contributes to the defect in
32 fork protection in BRCA2-deficient cells. Thus, in contrast to Lai et al and Lemaçon et al.
33 this study proposes that MUS81 activity at stalled forks is deleterious in BRCA2-deficient
34 cells.
35
36
37
38
39
40
41

42 **Figure 7 Maintenance of Common Fragile Sites and Mitotic DNA synthesis (MiDAS)**

43
44 Mild replication stress induced by APH leads to under-replicated DNA at CFS. SLX4
45 localizes to CFS in mitosis, possibly through a TopBP1-dependent recruitment. SLX4
46 promotes the targeting of its associated nucleases but also the one of RAD52, itself
47 required for MUS81 recruitment. After nucleolytic cleavage of replication intermediates,
48 RAD52 and POLD3 then promote MiDAS, which seems to account for the « expression » of
49 the fragile sites, i.e their apparent breakage on mitotic chromosomes. See main text for
50 details.
51
52
53
54
55
56
57
58
59
60

1
2
3
4
5
6
7
8
9

Figure 8 Complex formation with Rtt107 and Dpb11 and checkpoint dampening by Slx4

10 upper panel: schematic representation of the DAMP mechanism. See main text for details.
11 P represents a phosphorylation site (CDK-directed S486 of Slx4 or Mec1-directed S129 in
12 H2A and T602 in the Ddc1 subunit of the 9-1-1 complex: Ddc1-Rad17- Mec3). Slx4 is also
13 phosphorylated by Mec1 (pS/TQ) which promotes its interaction with Dpb11.
14 Mechanistically, Slx4-Rtt107 competes with Rad9 for Dpb11 binding at sites of DNA
15 damage, which restrains the Mec1-dependent Rad53 phosphorylation. At the right, the
16 MBD competes with endogenous Dpb11 and Rad9 recruitment to damaged chromatin.
17 The DAMP mechanism relies on the interaction between Slx4 and Dpb11 BRCT1/2 (Ohouo
18 2013, Cussiol 2015).
19
20
21
22
23
24

25 Lower panel: Several possibilities for Slx4 and Mus81-Mms4-containing complexes. Both
26 Rtt107 and Dpb11 can mediate indirect interactions between Slx4 and Mus81-Mms4.
27 While the interaction of Slx4 with Dpb11 BRCT1/2 is a likely mechanism to explain
28 checkpoint dampening, Slx4 has also been shown to interact with Dpb11 BRCT3/4,
29 although it is currently unclear whether this would be compatible with a concomitant
30 interaction of Mms4 with the same pair of BRCT.
31
32
33
34
35

36 Rtt107 can also bridge Slx4 and Mms4, in a way that seems independent of Dpb11 and
37 possibly through a yet to be demonstrated direct interaction between Rtt107 and Mms4.
38
39
40
41
42

Figure 9 Model representing the possible functions of Slx4 at a stalled replication fork in response to MMS

43
44
45
46
47 - Attenuating Rad53 signaling - Stimulating local Mec1 activity towards specific targets,
48 located within the grey circle - Stimulating JM resolution by the Mus81-Mms4
49 endonuclease - Promoting DNA resection, possibly at the lagging strand. See main text for
50 further detail. Note: for simplicity, the direct interaction of Dpb11 with Mms4 is not
51 depicted here but it could represent another way to recruit Mus81-Mms4 behind stalled
52
53
54
55
56

1
2
3 fork for JM resolution
4
5
6
7

8 **Figure 10 Dynamics of T-loop formation, unfolding and endonucleolytic processing**
9

10 Schematic summarizing some of the secondary DNA structures that can form at telomeres
11 and be processed by SLX4-associated SSEs (Green and orange arrow heads). The balance
12 between formation and dismantlement of a T-loop must be finely tuned to ensure telomere
13 length homeostasis. While a T-loop prevents DDR activation and protects the telomere
14 against illegitimate repair and removal of the 3'-overhang, it hinders replication to the
15 end of the telomere. TRF2 plays a key role in promoting T-loop formation, protecting
16 secondary DNA structures at the base of the T-loop from unscheduled processing by SSEs
17 and preventing branch migration and formation of dHJs, which necessarily comes with the
18 re-appearance of a telomeric end. Therefore, T-loops must be dismantled during S-phase.
19 They can be unfolded by helicases, which will have no impact on telomere length. In mice,
20 this is believed to constitute a favored pathway that is initiated by the timely recruitment
21 by TRF2 of the RTEL1 helicase in S-phase (Sarek et al. 2015). Alternatively, they can be
22 endonucleolytically processed, primarily by SLX4 associated SSEs, to generate a shortened
23 telomere and a T-circle. An important function of TRF2 is to shield secondary DNA
24 structures from the action of SSEs. Importantly, in human cells TRF2 also contributes to
25 the recruitment of SLX4 and its associated nucleases suggesting that it contributes to the
26 endonucleolytic processing of the T-loop and T-circle formation to help control telomere
27 length homeostasis (blue dotted arrow). See the main text for more details and discussion.
28
29
30
31
32
33
34
35
36
37
38
39
40
41
42
43
44
45
46
47
48
49
50
51
52
53
54
55
56
57
58
59
60

References

- Aarts M, Sharpe R, Garcia-Murillas I, Gevensleben H, Hurd MS, Shumway SD, Toniatti C, Ashworth A, Turner NC. 2012. Forced mitotic entry of S-phase cells as a therapeutic strategy induced by inhibition of WEE1. *Cancer Discov.* 2:524–539.
- Abdullah UB, McGouran JF, Brolih S, Ptchelkine D, El-Sagheer AH, Brown T, McHugh PJ. 2017. RPA activates the XPF-ERCC1 endonuclease to initiate processing of DNA interstrand crosslinks. *EMBO J.*:e201796664.
- Abraham J, Lemmers B, Hande MP, Moynahan ME, Chahwan C, Ciccio A, Essers J, Hanada K, Chahwan R, Khaw AK, et al. 2003. Eme1 is involved in DNA damage processing and maintenance of genomic stability in mammalian cells. *EMBO J.* 22:6137–6147.
- Agostinho A, Meier B, Sonnevile R, Jagut M, Woglar A, Blow J, Jantsch V, Gartner A. 2013. Combinatorial Regulation of Meiotic Holliday Junction Resolution in *C. elegans* by HIM-6 (BLM) Helicase, SLX-4, and the SLX-1, MUS-81 and XPF-1 Nucleases. Lichten M, editor. *PLoS Genet.* 9:e1003591.
- Andersen SL, Bergstralh DT, Kohl KP, LaRocque JR, Moore CB, Sekelsky J. 2009. *Drosophila* MUS312 and the vertebrate ortholog BTBD12 interact with DNA structure-specific endonucleases in DNA repair and recombination. 35:128–135.
- Aravind L, Koonin EV. 2001. Prokaryotic homologs of the eukaryotic DNA-end-binding protein Ku, novel domains in the Ku protein and prediction of a prokaryotic double-strand break repair system. *Genome Res.* 11:1365–1374.
- Balint A, Kim T, Gallo D, Cussiol JR, Bastos de Oliveira FM, Yimit A, Ou J, Nakato R, Gurevich A, Shirahige K, et al. 2015. Assembly of Slx4 signaling complexes behind DNA replication forks. *EMBO J.* 34:2182–2197.
- Beck H, Nähse V, Larsen MSY, Groth P, Clancy T, Lees M, Jørgensen M, Helleday T, Syljuåsen RG, Sørensen CS. 2010. Regulators of cyclin-dependent kinases are crucial for maintaining genome integrity in S phase. *J Cell Biol.* 188:629–638.
- Beck H, Nähse-Kumpf V, Larsen MSY, O'Hanlon KA, Patzke S, Holmberg C, Mejlvang J, Groth A, Nielsen O, Syljuåsen RG, Sørensen CS. 2012. Cyclin-dependent kinase suppression by WEE1 kinase protects the genome through control of replication initiation and nucleotide consumption. *Mol Cell Biol.* 32:4226–4236.
- Berger G, Lawrence M, Hué S, Neil SJD. 2014. G2/M cell cycle arrest correlates with primate lentiviral Vpr interaction with the SLX4 complex. Kirchhoff F, editor. *J Virol.* 89:230–240.
- Bergoglio V, Boyer A-S, Walsh E, Naim V, Legube G, Lee MYWT, Rey L, Rosselli F, Cazaux C, Eckert KA, Hoffmann J-S. 2013. DNA synthesis by Pol η promotes fragile site stability by preventing under-replicated DNA in mitosis. *J Cell Biol.* 201:395–408.

1
2
3 Berti M, Ray Chaudhuri A, Thangavel S, Gomathinayagam S, Kenig S, Vujanovic M,
4 Odreman F, Glatter T, Graziano S, Mendoza-Maldonado R, et al. 2013. Human RECQ1
5 promotes restart of replication forks reversed by DNA topoisomerase I inhibition.
6 *Nat Struct Mol Biol.* 20:347–354.
7

8 Bétous R, Betous R, Mason AC, Mason AC, Rambo RP, Rambo RP, Bansbach CE,
9 Bansbach CE, Badu-Nkansah A, Badu-Nkansah A, et al. 2012. SMARCAL1 catalyzes
10 fork regression and Holliday junction migration to maintain genome stability during
11 DNA replication. *Genes Dev.* 26:151–162.
12

13 Bhowmick R, Minocherhomji S, Hickson ID. 2016. RAD52 Facilitates Mitotic DNA
14 Synthesis Following Replication Stress. *Mol Cell.* 64:1117–1126.
15

16 Boddy MN, Gaillard PH, McDonald WH, Shanahan P, Yates JR, Russell P. 2001. Mus81-
17 Eme1 are essential components of a Holliday junction resolvase. 107:537–548.
18

19 Bogliolo M, Schuster B, Stoepker C, Derkunt B, Su Y, Raams A, Trujillo JP, Minguillón
20 J, Ramírez MJ, Pujol R, et al. 2013. Mutations in ERCC4, encoding the DNA-repair
21 endonuclease XPF, cause Fanconi anemia. *Am J Hum Genet.* 92:800–806.
22
23

24 Branzei D, Vanoli F, Foiani M. 2008. SUMOylation regulates Rad18-mediated
25 template switch. *Nature.* 456:915–920.
26

27 Brégnard C, Guerra J, Déjardin S, Passalacqua F, Benkirane M, Laguette N. 2016.
28 Upregulated LINE-1 Activity in the Fanconi Anemia Cancer Susceptibility Syndrome
29 Leads to Spontaneous Pro-inflammatory Cytokine Production. *EBioMedicine.* 8:184–
30 194.
31

32 Bryant HE, Schultz N, Thomas HD, Parker KM, Flower D, Lopez E, Kyle S, Meuth M,
33 Curtin NJ, Helleday T. 2005. Specific killing of BRCA2-deficient tumours with
34 inhibitors of poly(ADP-ribose) polymerase. *Nature.* 434:913–917.
35
36

37 Castor D, Nair N, Déclais A-C, Lachaud C, Toth R, Macartney TJ, Lilley DMJ, Arthur JSC,
38 Rouse J. 2013. Cooperative Control of Holliday Junction Resolution and DNA Repair
39 by the SLX1 and MUS81-EME1 Nucleases. 52:1–13.
40

41 Chan KL, Palmai-Pallag T, Ying S, Hickson ID. 2009. Replication stress induces sister-
42 chromatid bridging at fragile site loci in mitosis. *Nat Cell Biol.* 11:753–760.
43

44 Chan YW, West SC. 2014. Spatial control of the GEN1 Holliday junction resolvase
45 ensures genome stability. *Nat Commun.* 5:4844–11.
46

47 Chang M, Bellaoui M, Boone C, Brown GW. 2002. A genome-wide screen for methyl
48 methanesulfonate-sensitive mutants reveals genes required for S phase progression
49 in the presence of DNA damage. *Proc Natl Acad Sci USA.* 99:16934–16939.
50

51 Chen Y, Yang Y, van Overbeek M, Donigian JR, Baciú P, de Lange T, Lei M. 2008. A
52 shared docking motif in TRF1 and TRF2 used for differential recruitment of
53 telomeric proteins. *Science.* 319:1092–1096.
54
55

- 1
2
3 Chu WK, Hickson ID. 2009. RecQ helicases: multifunctional genome caretakers. *Nat Rev Cancer*. 9:644–654.
4
5
6 Couch FB, Cortez D. 2014. Fork reversal, too much of a good thing. *cc*. 13:1049–1050.
7
8 Couch FB, Couch FB, Bansbach CE, Bansbach CE, Driscoll R, Driscoll R, Luzwick JW,
9 Luzwick JW, Glick GG, Glick GG, et al. 2013. ATR phosphorylates SMARCAL1 to
10 prevent replication fork collapse. *Genes Dev*. 27:1610–1623.
11
12 Coulon S, Gaillard P-HL, Chahwan C, McDonald WH, Yates JR, Russell P. 2004. Slx1-
13 Slx4 are subunits of a structure-specific endonuclease that maintains ribosomal DNA
14 in fission yeast. *Mol Biol Cell*. 15:71–80.
15
16 Coulon S, Noguchi E, Noguchi C, Du L-L, Nakamura TM, Russell P. 2006.
17 Rad22Rad52-dependent repair of ribosomal DNA repeats cleaved by Slx1-Slx4
18 endonuclease. *Mol Biol Cell*. 17:2081–2090.
19
20 Cox KE, Maréchal A, Flynn RL. 2016. SMARCAL1 Resolves Replication Stress at ALT
21 Telomeres. *Cell Rep*. 14:1032–1040.
22
23 Crossan GP, van der Weyden L, Rosado IV, Langevin F, Gaillard P-HL, McIntyre RE,
24 Sanger Mouse Genetics Project, Gallagher F, Kettunen MI, Lewis DY, et al. 2011.
25 Disruption of mouse Slx4, a regulator of structure-specific nucleases, phenocopies
26 Fanconi anemia. *Nat Genet*. 43:147–152.
27
28 Cussiol JR, Jablonowski CM, Yimit A, Brown GW, Smolka MB. 2015. Dampening DNA
29 damage checkpoint signalling via coordinated BRCT domain interactions. *EMBO J*.
30 34:1704–1717.
31
32 de Garibay GR, Díaz A, Gaviña B, Romero A, Garre P, Vega A, Blanco A, Tosar A, Díez
33 O, Pérez-Segura P, et al. 2013. Low prevalence of SLX4 loss-of-function mutations in
34 non-BRCA1/2 breast and/or ovarian cancer families. *Eur J Hum Genet*. 21:883–886.
35
36 De Muyt A, Jessop L, Kolar E, Sourirajan A, Chen J, Dayani Y, Lichten M. 2012. BLM
37 helicase ortholog Sgs1 is a central regulator of meiotic recombination intermediate
38 metabolism. 46:43–53.
39
40 Dehé P-M, Coulon S, Scaglione S, Shanahan P, Takedachi A, Wohlschlegel JA, Yates JR,
41 Llorente B, Russell P, Gaillard P-HL. 2013. Regulation of Mus81-Eme1 Holliday
42 junction resolvase in response to DNA damage. *Nat Struct Mol Biol*. 20:598–603.
43
44 Dehé P-M, Gaillard P-HL. 2017. Control of structure-specific endonucleases to
45 maintain genome stability. *Nat Rev Mol Cell Biol*. 18:315–330.
46
47 Dendouga N, Gao H, Moechars D, Janicot M, Vialard J, McGowan CH. 2005. Disruption
48 of murine Mus81 increases genomic instability and DNA damage sensitivity but does
49 not promote tumorigenesis. *Mol Cell Biol*. 25:7569–7579.
50
51 Di Marco S, Hasanova Z, Kanagaraj R, Chappidi N, Altmannova V, Menon S,
52 Sedlackova H, Langhoff J, Surendranath K, Hühn D, et al. 2017. RECQ5 Helicase
53
54
55
56
57
58
59
60

- 1
2
3 Cooperates with MUS81 Endonuclease in Processing Stalled Replication Forks at
4 Common Fragile Sites during Mitosis. *Mol Cell*. 66:658–671.e8.
5
6 Dibitetto D, Ferrari M, Rawal CC, Balint A, Kim T, Zhang Z, Smolka MB, Brown GW,
7 Marini F, Pelliccioli A. 2015. Slx4 and Rtt107 control checkpoint signalling and DNA
8 resection at double-strand breaks. *Nucleic Acids Res*. 44:gkv1080–682.
9
10 Doksani Y, Wu JY, de Lange T, Zhuang X. 2013. Super-resolution fluorescence
11 imaging of telomeres reveals TRF2-dependent T-loop formation. *Cell*. 155:345–356.
12
13 Domínguez-Kelly R, Martín Y, Koundrioukoff S, Tanenbaum ME, Smits VAJ, Medema
14 RH, Debatisse M, Freire R. 2011. Wee1 controls genomic stability during replication
15 by regulating the Mus81-Eme1 endonuclease. *J Cell Biol*. 194:567–579.
16
17 Douwel DK, Boonen RACM, Long DT, Szypowska AA, Räschle M, Walter JC,
18 Knipscheer P. 2014. XPF-ERCC1 Acts in Unhooking DNA Interstrand Crosslinks in
19 Cooperation with FANCD2 and FANCP/SLX4. 54:1–12.
20
21 Downey M, Edenberg ER, Toczyski DP. 2010. Repair scaffolding reaches new heights
22 at blocked replication forks. 39:162–164.
23
24 Duda H, Arter M, Gloggnitzer J, Teloni F, Wild P, Blanco MG, Altmeyer M, Matos J.
25 2016. A Mechanism for Controlled Breakage of Under-replicated Chromosomes
26 during Mitosis. *Dev Cell*. 39:740–755.
27
28
29
30
31
32
33
34
35
36
37
38
39
40
41
42
43
44
45
46
47
48
49
50
51
52
53
54
55
56
57
58
59
60
- Dungrawala H, Rose KL, Bhat KP, Mohni KN, Glick GG, Couch FB, Cortez D. 2015. The
Replication Checkpoint Prevents Two Types of Fork Collapse without Regulating
Replisome Stability. 59:1–14.
- Farmer H, McCabe N, Lord CJ, Tutt ANJ, Johnson DA, Richardson TB, Santarosa M,
Dillon KJ, Hickson I, Knights C, et al. 2005. Targeting the DNA repair defect in BRCA
mutant cells as a therapeutic strategy. *Nature*. 434:917–921.
- Fekairi S, Scaglione S, Chahwan C, Taylor ER, Tissier A, Coulon S, Dong M-Q, Ruse C,
Yates JR, Russell P, et al. 2009. Human SLX4 is a Holliday junction resolvase subunit
that binds multiple DNA repair/recombination endonucleases. 138:78–89.
- Fisher LA, Bessho M, Bessho T. 2008. Processing of a psoralen DNA interstrand
cross-link by XPF-ERCC1 complex in vitro. *J Biol Chem*. 283:1275–1281.
- Flott S, Alabert C, Toh GW, Toth R, Sugawara N, Campbell DG, Haber JE, Pasero P,
Rouse J. 2007. Phosphorylation of Slx4 by Mec1 and Tel1 regulates the single-strand
annealing mode of DNA repair in budding yeast. *Mol Cell Biol*. 27:6433–6445.
- Fregoso OI, Emerman M. 2016. Activation of the DNA Damage Response Is a
Conserved Function of HIV-1 and HIV-2 Vpr That Is Independent of SLX4
Recruitment. *MBio*. 7:e01433–16.
- Fricke WM, Brill SJ. 2003. Slx1-Slx4 is a second structure-specific endonuclease
functionally redundant with Sgs1-Top3. *Genes Dev*. 17:1768–1778.

1
2
3 Fugger K, Chu WK, Haahr P, Nedergaard Kousholt A, Beck H, Payne MJ, Hanada K,
4 Hickson ID, Storgaard Sørensen C. 2013. FBH1 co-operates with MUS81 in inducing
5 DNA double-strand breaks and cell death following replication stress. *Nat Commun.*
6 4:1423.
7

8 Fugger K, Mistrik M, Neelsen KJ, Yao Q, Zellweger R, Kousholt AN, Haahr P, Chu WK,
9 Bartek J, Lopes M, et al. 2015. FBH1 Catalyzes Regression of Stalled Replication
10 Forks. *Cell Rep.* 10:1–10.
11

12 Gallo-Fernandez M, Gallo-Fernández M, Saugar I, Saugar I, Ortiz-Bazan MA, Ortiz-
13 Bazán MÁ, Vázquez MV, Vazquez MV, Tercero JA, Tercero JA. 2012. Cell cycle-
14 dependent regulation of the nuclease activity of Mus81-Eme1/Mms4. *Nucleic Acids*
15 *Res.* 40:8325–8335.
16

17 Garcia-Exposito L, Bournique E, Bergoglio V, Bose A, Barroso-Gonzalez J, Zhang S,
18 Roncaioli JL, Lee M, Wallace CT, Watkins SC, et al. 2016. Proteomic Profiling Reveals
19 a Specific Role for Translesion DNA Polymerase η in the Alternative Lengthening of
20 Telomeres. *Cell Rep.* 17:1858–1871.
21
22

23 Gari K, Décaillet C, Delannoy M, Wu L, Constantinou A. 2008. Remodeling of DNA
24 replication structures by the branch point translocase FANCM. *Proceedings of the*
25 *National Academy of Sciences.* 105:16107–16112.
26

27 Garner E, Kim Y, Lach FP, Kottemann MC, Smogorzewska A. 2013. Human GEN1 and
28 the SLX4-Associated Nucleases MUS81 and SLX1 Are Essential for the Resolution of
29 Replication-Induced Holliday Junctions. *Cell Rep.* 5:1–16.
30

31 Gaur V, Wyatt HDM, Komorowska W, Szczepanowski RH, de Sanctis D, Górecka KM,
32 West SC, Nowotny M. 2015. Structural and Mechanistic Analysis of the Slx1-Slx4
33 Endonuclease. *Cell Rep.* 10:1467–1476.
34

35 Ghosal G, Leung JW-C, Nair BC, Fong K-W, Chen J. 2012. PCNA-binding protein
36 C1orf124 is a regulator of translesion synthesis. *Journal of Biological Chemistry.*
37 287:34225–34233.
38

39 Glover TW, Wilson TE, Arlt MF. 2017. Fragile sites in cancer: more than meets the
40 eye. *Nat Rev Cancer.* 17:489–501.
41
42

43 González Besteiro MA, Gottifredi V. 2015. The fork and the kinase: a DNA replication
44 tale from a CHK1 perspective. *Mutat Res Rev Mutat Res.* 763:168–180.
45

46 González-Prieto R, Cuijpers SA, Luijsterburg MS, van Attikum H, Vertegaal AC. 2015.
47 SUMOylation and PARYlation cooperate to recruit and stabilize SLX4 at DNA damage
48 sites. *EMBO Rep.* 16:512–519.
49

50 Granata M, Panigada D, Galati E, Lazzaro F, Pelliccioli A, Plevani P, Muzi-Falconi M.
51 2013. To trim or not to trim: progression and control of DSB end resection. *cc.*
52 12:1848–1860.
53

54 Gritenaite D, Gritenaite D, Princz LN, Princz LN, Szakal B, Szakal B, Bantele SCS,
55
56

- 1
2
3 Bantele SCS, Wendeler L, Wendeler L, et al. 2014. A cell cycle-regulated Slx4-Dpb11
4 complex promotes the resolution of DNA repair intermediates linked to stalled
5 replication. *Genes Dev.* 28:1604–1619.
6
- 7 Guervilly J-H, Gaillard P-HL. 2016. SLX4 gains weight with SUMO in genome
8 maintenance. *Molecular & Cellular Oncology.* 3:e1008297–3.
9
- 10 Guervilly J-H, Takedachi A, Naim V, Scaglione S, Chawhan C, Lovera Y, Despras E,
11 Kuraoka I, Kannouche P, Rosselli F, Gaillard P-HL. 2015. The SLX4 complex is a SUMO
12 E3 ligase that impacts on replication stress outcome and genome stability. 57:123–
13 137.
14
- 15 Hammet A, Magill C, Heierhorst J, Jackson SP. 2007. Rad9 BRCT domain interaction
16 with phosphorylated H2AX regulates the G1 checkpoint in budding yeast. *EMBO Rep.*
17 8:851–857.
18
- 19 Hanada K, Budzowska M, Davies SL, van Drunen E, Onizawa H, Beverloo HB, Maas A,
20 Essers J, Hickson ID, Kanaar R. 2007. The structure-specific endonuclease Mus81
21 contributes to replication restart by generating double-strand DNA breaks. *Nat*
22 *Struct Mol Biol.* 14:1096–1104.
23
- 24 Hanada K, Budzowska M, Modesti M, Maas A, Wyman C, Essers J, Kanaar R. 2006. The
25 structure-specific endonuclease Mus81-Eme1 promotes conversion of interstrand
26 DNA crosslinks into double-strands breaks. *EMBO J.* 25:4921–4932.
27
- 28 Hashimoto K, Wada K, Matsumoto K, Moriya M. 2015. Physical interaction between
29 SLX4 (FANCP) and XPF (FANCI) proteins and biological consequences of
30 interaction-defective missense mutations. *DNA Repair (Amst).* 35:48–54.
31
- 32 Helleday T. 2011. The underlying mechanism for the PARP and BRCA synthetic
33 lethality: clearing up the misunderstandings. *Mol Oncol.* 5:387–393.
34
- 35 Helmrich A, Ballarino M, Tora L. 2011. Collisions between replication and
36 transcription complexes cause common fragile site instability at the longest human
37 genes. *Mol Cell.* 44:966–977.
38
- 39 Henson JD, Cao Y, Huschtscha LI, Chang AC, Au AYM, Pickett HA, Reddel RR. 2009.
40 DNA C-circles are specific and quantifiable markers of alternative-lengthening-of-
41 telomeres activity. *Nat Biotechnol.* 27:1181–1185.
42
- 43 Hiyama T, Katsura M, Yoshihara T, Ishida M, Kinomura A, Tonda T, Asahara T,
44 Miyagawa K. 2006. Haploinsufficiency of the Mus81-Eme1 endonuclease activates
45 the intra-S-phase and G2/M checkpoints and promotes rereplication in human cells.
46 *Nucleic Acids Res.* 34:880–892.
47
- 48 Ho CK, Mazón G, Lam AF, Symington LS. 2010. Mus81 and Yen1 promote reciprocal
49 exchange during mitotic recombination to maintain genome integrity in budding
50 yeast. 40:988–1000.
51
- 52 Ho SSW, Zhang WYL, Tan NYJ, Khatoor M, Suter MA, Tripathi S, Cheung FSG, Lim WK,
53
54
55
56

- 1
2
3 Tan PH, Ngeow J, Gasser S. 2016. The DNA Structure-Specific Endonuclease MUS81
4 Mediates DNA Sensor STING-Dependent Host Rejection of Prostate Cancer Cells.
5 *Immunity*. 44:1177–1189.
6
- 7 Hodskinson MRG, Silhan J, Crossan GP, Garaycochea JI, Mukherjee S, Johnson CM,
8 Schärer OD, Patel KJ. 2014. Mouse SLX4 is a tumor suppressor that stimulates the
9 activity of the nuclease XPF-ERCC1 in DNA crosslink repair. 54:472–484.
10
- 11 Holloway JK, Mohan S, Balmus G, Sun X, Modzelewski A, Borst PL, Freire R, Weiss RS,
12 Cohen PE. 2011. Mammalian BTBD12 (SLX4) protects against genomic instability
13 during mammalian spermatogenesis. Hawley RS, editor. *PLoS Genet*. 7:e1002094.
14
- 15 Huang J, Liu S, Bellani MA, Thazhathveetil AK, Ling C, de Winter JP, Wang Y, Wang W,
16 Seidman MM. 2013. The DNA translocase FANCM/MHF promotes replication
17 traverse of DNA interstrand crosslinks. *Mol Cell*. 52:434–446.
18
- 19 Huang R-Y, Eddy M, Vujcic M, Kowalski D. 2005. Genome-wide screen identifies
20 genes whose inactivation confer resistance to cisplatin in *Saccharomyces cerevisiae*.
21 *Cancer Res*. 65:5890–5897.
22
- 23 Iijima K, Kobayashi J, Ishizaka Y. 2018. Structural alteration of DNA induced by viral
24 protein R of HIV-1 triggers the DNA damage response. *Retrovirology*. 15:8.
25
- 26 Ito T, Chiba T, Ozawa R, Yoshida M, Hattori M, Sakaki Y. 2001. A comprehensive two-
27 hybrid analysis to explore the yeast protein interactome. *Proc Natl Acad Sci USA*.
28 98:4569–4574.
29
- 30 Jablonowski CM, Cussiol JR, Oberly S, Yimit A, Balint A, Kim T, Zhang Z, Brown GW,
31 Smolka MB. 2015. Termination of Replication Stress Signaling via Concerted Action
32 of the Slx4 Scaffold and the PP4 Phosphatase. 201:937–949.
33
- 34 Jeong YT, Rossi M, Cermak L, Saraf A, Florens L, Washburn MP, Sung P, Schildkraut
35 CL, Pagano M. 2013. FBH1 promotes DNA double-strand breakage and apoptosis in
36 response to DNA replication stress. *J Cell Biol*. 200:141–149.
37
- 38 Kai M, Boddy MN, Russell P, Wang TS-F. 2005. Replication checkpoint kinase Cds1
39 regulates Mus81 to preserve genome integrity during replication stress. *Genes Dev*.
40 19:919–932.
41
- 42 Kalb R, Neveling K, Hoehn H, Schneider H, Linka Y, Batish SD, Hunt C, Berwick M,
43 Callén E, Surrallés J, et al. 2007. Hypomorphic mutations in the gene encoding a key
44 Fanconi anemia protein, FANCD2, sustain a significant group of FA-D2 patients with
45 severe phenotype. *The American Journal of Human Genetics*. 80:895–910.
46
- 47 Kaliraman V, Brill SJ. 2002. Role of SGS1 and SLX4 in maintaining rDNA structure in
48 *Saccharomyces cerevisiae*. *Curr Genet*. 41:389–400.
49
- 50 Kikuchi K, Narita T, Pham VT, Iijima J, Hirota K, Keka IS, Mohiuddin, Okawa K, Hori T,
51 Fukagawa T, et al. 2013. Structure-specific endonucleases xpf and mus81 play
52 overlapping but essential roles in DNA repair by homologous recombination. *Cancer*
53
54
55
56

1
2
3 Res. 73:4362–4371.

4
5 Kim Y, Lach FP, Desetty R, Hanenberg H, Auerbach AD, Smogorzewska A. 2011.
6 Mutations of the SLX4 gene in Fanconi anemia. *Nat Genet.* 43:142–146.

7
8 Kim Y, Spitz GS, Veturi U, Lach FP, Auerbach AD, Smogorzewska A. 2013. Regulation
9 of multiple DNA repair pathways by the Fanconi anemia protein SLX4. *Blood.*
10 121:54–63.

11
12 Klein Douwel D, Hoogenboom WS, Boonen RA, Knipscheer P. 2017. Recruitment and
13 positioning determine the specific role of the XPF-ERCC1 endonuclease in
14 interstrand crosslink repair. *EMBO J.*:e201695223.

15
16 Knipscheer P, Räschle M, Smogorzewska A, Enoiu M, Ho TV, Schärer OD, Elledge SJ,
17 Walter JC. 2009. The Fanconi anemia pathway promotes replication-dependent DNA
18 interstrand cross-link repair. *Science.* 326:1698–1701.

19
20 Kolinjivadi AM, Sannino V, De Antoni A, Zadorozhny K, Kilkenny M, Técher H, Baldi G,
21 Shen R, Ciccia A, Pellegrini L, et al. 2017. Smarcal1-Mediated Fork Reversal Triggers
22 Mre11- Dependent Degradation of Nascent DNA in the Absence of Brca2 and Stable
23 Rad51 Nucleofilaments. *Mol Cell.* 67:867–881.e7.

24
25 Koster DA, Palle K, Bot ESM, Bjornsti M-A, Dekker NH. 2007. Antitumour drugs
26 impede DNA uncoiling by topoisomerase I. *Nature.* 448:213–217.

27
28 Kowalczykowski SC. 2015. An Overview of the Molecular Mechanisms of
29 Recombinational DNA Repair. *Cold Spring Harb Perspect Biol.* 7:a016410.

30
31 Kuraoka I, Kobertz WR, Ariza RR, Biggerstaff M, Essigmann JM, Wood RD. 2000.
32 Repair of an interstrand DNA cross-link initiated by ERCC1-XPF
33 repair/recombination nuclease. *J Biol Chem.* 275:26632–26636.

34
35 Lachaud C, Castor D, Hain K, Muñoz I, Wilson J, Macartney TJ, Schindler D, Rouse J.
36 2014. Distinct functional roles for the two SLX4 ubiquitin-binding UBZ domains
37 mutated in Fanconi anemia. *J Cell Sci.* 127:2811–2817.

38
39 Lachaud C, Slean M, Marchesi F, Lock C, Odell E, Castor D, Toth R, Rouse J. 2016.
40 Karyomegalic interstitial nephritis and DNA damage-induced polyploidy in Fan1
41 nuclease-defective knock-in mice. *Genes Dev.* 30:639–644.

42
43 Laguette N, Brégnard C, Hue P, Basbous J, Yatim A, Larroque M, Kirchhoff F,
44 Constantinou A, Sobhian B, Benkirane M. 2014. Premature activation of the SLX4
45 complex by Vpr promotes G2/M arrest and escape from innate immune sensing.
46 156:134–145.

47
48 Lai X, Broderick R, Bergoglio V, Zimmer J, Badie S, Niedzwiedz W, Hoffmann J-S,
49 Tarsounas M. 2017. MUS81 nuclease activity is essential for replication stress
50 tolerance and chromosome segregation in BRCA2-deficient cells. *Nat Commun.*
51 8:15983.

- 1
2
3 Landwehr R, Bogdanova NV, Antonenkova N, Meyer A, Bremer M, Park-Simon T-W,
4 Hillemanns P, Karstens JH, Schindler D, Dörk T. 2011. Mutation analysis of the
5 SLX4/FANCP gene in hereditary breast cancer. *Breast Cancer Res Treat.* 130:1021–
6 1028.
7
- 8 Lazzerini-Denchi E, Sfeir A. 2016. Stop pulling my strings - what telomeres taught us
9 about the DNA damage response. *Nat Rev Mol Cell Biol.* 17:364–378.
10
- 11 Le Tallec B, Koundrioukoff S, Wilhelm T, Letessier A, Brison O, Debatisse M. 2014.
12 Updating the mechanisms of common fragile site instability: how to reconcile the
13 different views? *Cell Mol Life Sci.* 71:4489–4494.
14
- 15 Le Tallec B, Millot GA, Blin ME, Brison O, Dutrillaux B, Debatisse M. 2013. Common
16 Fragile Site Profiling in Epithelial and Erythroid Cells Reveals that Most Recurrent
17 Cancer Deletions Lie in Fragile Sites Hosting Large Genes. *Cell Rep.* 4:420–428.
18
- 19 Lee W, St Onge RP, Proctor M, Flaherty P, Jordan MI, Arkin AP, Davis RW, Nislow C,
20 Giaever G. 2005. Genome-wide requirements for resistance to functionally distinct
21 DNA-damaging agents. *PLoS Genet.* 1:e24.
22
- 23 Lemaçon D, Jackson J, Quinet A, Brickner JR, Li S, Yazinski S, You Z, Ira G, Zou L,
24 Mosammamarast N, Vindigni A. 2017. MRE11 and EXO1 nucleases degrade reversed
25 forks and elicit MUS81-dependent fork rescue in BRCA2- deficient cells. *Nat*
26 *Commun.* 8:1–12.
27
- 28 Letessier A, Millot GA, Koundrioukoff S, Lachagès A-M, Vogt N, Hansen RS, Malfoy B,
29 Brison O, Debatisse M. 2011. Cell-type-specific replication initiation programs set
30 fragility of the FRA3B fragile site. *Nature.* 470:120–123.
31
- 32 Lévesque N, Leung GP, Fok AK, Schmidt TI, Kobor MS. 2010. Loss of H3 K79
33 trimethylation leads to suppression of Rtt107-dependent DNA damage sensitivity
34 through the translesion synthesis pathway. *Journal of Biological Chemistry.*
35 285:35113–35122.
36
- 37 Li F, Dong J, Eichmiller R, Holland C, Minca E, Prakash R, Sung P, Yong Shim E,
38 Surtees JA, Eun Lee S. 2013. Role of Saw1 in Rad1/Rad10 complex assembly at
39 recombination intermediates in budding yeast. *EMBO J.* 32:461–472.
40
- 41 Li F, Dong J, Pan X, Oum J-H, Boeke JD, Lee SE. 2008. Microarray-based genetic screen
42 defines SAW1, a gene required for Rad1/Rad10-dependent processing of
43 recombination intermediates. *30:325–335.*
44
- 45 Li X, Liu K, Li F, Wang J, Huang H, Wu J, Shi Y. 2012. Structure of the C-terminal
46 tandem BRCT repeats of Rtt107 reveals a critical role in the interaction with γ H2A
47 during DNA damage repair. *Journal of Biological Chemistry.* 287:9137–9146.
48
- 49 Lian F-M, Xie S, Qian C. 2016. Crystal structure and SUMO binding of Slx1-Slx4
50 complex. *Sci Rep.* 6:19331.
51
- 52 Liberi G, Maffioletti G, Lucca C, Chiolo I, Baryshnikova A, Cotta-Ramusino C, Lopes M,
53
54
55
56

1
2
3 Pellicioli A, Haber JE, Foiani M. 2005. Rad51-dependent DNA structures accumulate
4 at damaged replication forks in *sgs1* mutants defective in the yeast ortholog of BLM
5 RecQ helicase. *Genes Dev.* 19:339–350.

6
7 Liu Y, Cussiol JR, Dibitetto D, Sims JR, Twayana S, Weiss RS, Freire R, Marini F,
8 Pellicioli A, Smolka MB. 2017. TOPBP1(Dpb11) plays a conserved role in
9 homologous recombination DNA repair through the coordinated recruitment of
10 53BP1(Rad9). *J Cell Biol.* 216:623–639.

11
12 Lopez-Contreras AJ, Ruppen I, Nieto-Soler M, Murga M, Rodriguez-Acebes S,
13 Remeseiro S, Rodrigo-Perez S, Rojas AM, Méndez J, Muñoz J, Fernandez-Capetillo O.
14 2013. A proteomic characterization of factors enriched at nascent DNA molecules.
15 *Cell Rep.* 3:1105–1116.

16
17 Lyndaker AM, Goldfarb T, Alani E. 2008. Mutants defective in Rad1-Rad10-Slx4
18 exhibit a unique pattern of viability during mating-type switching in *Saccharomyces*
19 *cerevisiae*. 179:1807–1821.

20
21 Macheret M, Halazonetis TD. 2015. DNA replication stress as a hallmark of cancer.
22 *Annu Rev Pathol.* 10:425–448.

23
24 Maestroni L, Matmati S, Coulon S. 2017. Solving the Telomere Replication Problem.
25 *Genes (Basel).* 8:55.

26
27 Malacaria E, Franchitto A, Pichierri P. 2017. SLX4 Prevents GEN1-Dependent DSBs
28 During DNA Replication Arrest Under Pathological Conditions in Human Cells. *Sci*
29 *Rep.* 7:44464.

30
31 Margalef P, Kotsantis P, Borel V, Bellelli R, Panier S, Boulton SJ. 2018. Stabilization of
32 Reversed Replication Forks by Telomerase Drives Telomere Catastrophe. *Cell.*
33 172:439–453.e14.

34
35 Matheson CJ, Backos DS, Reigan P. 2016. Targeting WEE1 Kinase in Cancer. *Trends*
36 *Pharmacol Sci.* 37:872–881.

37
38 Matos J, Blanco MG, Maslen S, Skehel JM, West SC. 2011. Regulatory control of the
39 resolution of DNA recombination intermediates during meiosis and mitosis.
40 147:158–172.

41
42 Matos J, Blanco MG, West SC. 2013. Cell-cycle kinases coordinate the resolution of
43 recombination intermediates with chromosome segregation. *Cell Rep.* 4:76–86.

44
45 McPherson JP, Lemmers B, Chahwan R, Pamidi A, Migon E, Matysiak-Zablocki E,
46 Moynahan ME, Essers J, Hanada K, Poonepalli A, et al. 2004. Involvement of
47 mammalian Mus81 in genome integrity and tumor suppression. *Science.* 304:1822–
48 1826.

49
50 Meissner B, Bartram T, Eckert C, Trka J, Panzer-Grümayer R, Hermanova I,
51 Ellinghaus E, Franke A, Mörlicke A, Schrauder A, et al. 2014. Frequent and sex-biased
52 deletion of SLX4IP by illegitimate V(D)J-mediated recombination in childhood acute
53

- 1
2
3 lymphoblastic leukemia. *Hum Mol Genet.* 23:590–601.
4
5 Mijic S, Zellweger R, Chappidi N, Berti M, Jacobs K, Mutreja K, Ursich S, Chaudhuri AR,
6 Nussenzweig A, Janscak P, Lopes M. 2017. Replication fork reversal triggers fork
7 degradation in BRCA2-defective cells. *Nat Commun.* 8:1–10.
8
9 Min J, Wright WE, Shay JW. 2017. Alternative Lengthening of Telomeres Mediated by
10 Mitotic DNA Synthesis Engages Break-Induced Replication Processes. *Mol Cell Biol.*
11 37:e00226–17–16.
12
13 Minocherhomji S, Ying S, Bjerregaard VA, Bursomanno S, Aleliunaite A, Wu W,
14 Mankouri HW, Shen H, Liu Y, Hickson ID. 2015. Replication stress activates DNA
15 repair synthesis in mitosis. *Nature.* 528:286–290.
16
17 Morin I, Ngo H-P, Greenall A, Zubko MK, Morrice N, Lydall D. 2008. Checkpoint-
18 dependent phosphorylation of Exo1 modulates the DNA damage response. *EMBO J.*
19 27:2400–2410.
20
21 Mullen J, Kaliraman V, Ibrahim S, Brill S. 2001. Requirement for Three Novel Protein
22 Complexes in the Absence of the Sgs1 DNA Helicase in
23
24 Munoz IM, Hain K, Déclais A-C, Gardiner M, Toh GW, Sanchez-Pulido L, Heuckmann
25 JM, Toth R, Macartney T, Eppink B, et al. 2009. Coordination of structure-specific
26 nucleases by human SLX4/BTBD12 is required for DNA repair. 35:116–127.
27
28 Murfuni I, Basile G, Subramanyam S, Malacaria E, Bignami M, Spies M, Franchitto A,
29 Pichierri P. 2013. Survival of the replication checkpoint deficient cells requires
30 MUS81-RAD52 function. Maizels N, editor. *PLoS Genet.* 9:e1003910.
31
32 Naim V, Rosselli F. 2009. The FANCD1 pathway and BLM collaborate during mitosis to
33 prevent micro-nucleation and chromosome abnormalities. *Nat Cell Biol.* 11:761–768.
34
35 Naim V, Wilhelm T, Debatisse M, Rosselli F. 2013. ERCC1 and MUS81-EME1 promote
36 sister chromatid separation by processing late replication intermediates at common
37 fragile sites during mitosis. *Nat Cell Biol.* 15:1008–1015.
38
39 Nair N, Castor D, Macartney T, Rouse J. 2014. Identification and characterization of
40 MUS81 point mutations that abolish interaction with the SLX4 scaffold protein. *DNA
41 Repair (Amst).* 24:131–137.
42
43 Nalepa G, Clapp DW. 2018. Fanconi anaemia and cancer: an intricate relationship.
44 *Nat Rev Cancer.* 18:168–185.
45
46 Neelsen KJ, Lopes M. 2015. Replication fork reversal in eukaryotes: from dead end to
47 dynamic response. *Nat Rev Mol Cell Biol.* 16:207–220.
48
49 Neelsen KJ, Zanini IMY, Herrador R, Lopes M. 2013. Oncogenes induce genotoxic
50 stress by mitotic processing of unusual replication intermediates. *J Cell Biol.*
51 200:699–708.
52
53
54
55
56
57
58
59
60

1
2
3 Noll DM, Mason TM, Miller PS. 2006. Formation and repair of interstrand cross-links
4 in DNA. *Chem Rev.* 106:277–301.

5
6 Ohouo PY, Bastos de Oliveira FM, Almeida BS, Smolka MB. 2010. DNA damage
7 signaling recruits the Rtt107-Slx4 scaffolds via Dpb11 to mediate replication stress
8 response. *39:300–306.*

9
10 Ohouo PY, Bastos de Oliveira FM, Liu Y, Ma CJ, Smolka MB. 2013. DNA-repair
11 scaffolds dampen checkpoint signalling by counteracting the adaptor Rad9. *Nature.*
12 *493:120–124.*

13
14 Ouyang J, Garner E, Hallet A, Nguyen HD, Rickman KA, Gill G, Smogorzewska A, Zou L.
15 2015. Noncovalent interactions with SUMO and ubiquitin orchestrate distinct
16 functions of the SLX4 complex in genome maintenance. *57:108–122.*

17
18 Özer Ö, Bhowmick R, Liu Y, Hickson ID. 2018. Human cancer cells utilize mitotic DNA
19 synthesis to resist replication stress at telomeres regardless of their telomere
20 maintenance mechanism. *Oncotarget.* 9:15836–15846.

21
22 Palm W, de Lange T. 2008. How shelterin protects mammalian telomeres. *Annu Rev*
23 *Genet.* 42:301–334.

24
25 Pedersen RT, Pedersen RT, Kruse T, Kruse T, Nilsson J, Nilsson J, Oestergaard VH,
26 Oestergaard VH, Lisby M, Lisby M. 2015. TopBP1 is required at mitosis to reduce
27 transmission of DNA damage to G1 daughter cells. *J Cell Biol.* 210:565–582.

28
29 Pepe A, West SC. 2014. MUS81-EME2 Promotes Replication Fork Restart. *Cell Rep.*
30 *7:1048–1055.*

31
32 Pfander B, Diffley JFX. 2011. Dpb11 coordinates Mec1 kinase activation with cell
33 cycle-regulated Rad9 recruitment. *EMBO J.* 30:4897–4907.

34
35 Pfander B, Matos J. 2017. Control of Mus81 nuclease during the cell cycle. *FEBS Lett.*

36
37 Pommier Y. 2006. Topoisomerase I inhibitors: camptothecins and beyond. *Nat Rev*
38 *Cancer.* 6:789–802.

39
40 Poole LA, Zhao R, Glick GG, Lovejoy CA, Eischen CM, Cortez D. 2015. SMARCAL1
41 maintains telomere integrity during DNA replication. *Proceedings of the National*
42 *Academy of Sciences.* 112:14864–14869.

43
44 Poulet A, Buisson R, Faivre-Moskalenko C, Koelblen M, Amiard S, Montel F, Cuesta-
45 Lopez S, Bornet O, Guerlesquin F, Godet T, et al. 2009. TRF2 promotes, remodels and
46 protects telomeric Holliday junctions. *EMBO J.* 28:641–651.

47
48 Princz LN, Wild P, Bittmann J, Aguado FJ, Blanco MG, Matos J, Pfander B. 2017. Dbf4-
49 dependent kinase and the Rtt107 scaffold promote Mus81-Mms4 resolvase
50 activation during mitosis. *EMBO J.:*e201694831.

51
52 Puddu F, Granata M, Di Nola L, Balestrini A, Piergiovanni G, Lazzaro F, Giannattasio

1
2
3 M, Plevani P, Muzi-Falconi M. 2008. Phosphorylation of the budding yeast 9-1-1
4 complex is required for Dpb11 function in the full activation of the UV-induced DNA
5 damage checkpoint. *Mol Cell Biol.* 28:4782–4793.

6
7 Ragland RL, Ragland RL, Patel S, Patel S, Rivard RS, Rivard RS, Smith K, Smith K,
8 Peters AA, Peters AA, et al. 2013. RNF4 and PLK1 are required for replication fork
9 collapse in ATR-deficient cells. *Genes Dev.* 27:2259–2273.

10
11 Rai R, Chen Y, Lei M, Chang S. 2016. TRF2-RAP1 is required to protect telomeres
12 from engaging in homologous recombination-mediated deletions and fusions. *Nat*
13 *Commun.* 7:10881.

14
15 Rass U, Compton SA, Matos J, Singleton MR, Ip SCY, Blanco MG, Griffith JD, West SC.
16 2010. Mechanism of Holliday junction resolution by the human GEN1 protein. *Genes*
17 *Dev.* 24:1559–1569.

18
19 Ray Chaudhuri A, Hashimoto Y, Herrador R, Neelsen KJ, Fachinetti D, Bermejo R,
20 Cocito A, Costanzo V, Lopes M. 2012. Topoisomerase I poisoning results in PARP-
21 mediated replication fork reversal. *Nat Struct Mol Biol.* 19:417–423.

22
23 Regairaz M, Regairaz M, Zhang Y-W, Zhang YW, Fu H, Fu H, Agama KK, Agama KK,
24 Tata N, Tata N, et al. 2011. Mus81-mediated DNA cleavage resolves replication forks
25 stalled by topoisomerase I-DNA complexes. *J Cell Biol.* 195:739–749.

26
27 Rivera T, Haggblom C, Cosconati S, Karlseder J. 2017. A balance between elongation
28 and trimming regulates telomere stability in stem cells. *Nat Struct Mol Biol.* 24:30–
29 39.

30
31 Roberts TM, Kobor MS, Bastin-Shanower SA, Li M, Horte SA, Gin JW, Emili A, Rine J,
32 Brill SJ, Brown GW. 2006. Slx4 regulates DNA damage checkpoint-dependent
33 phosphorylation of the BRCT domain protein Rtt107/Esc4. *Mol Biol Cell.* 17:539–
34 548.

35
36 Rondinelli B, Gogola E, Yücel H, Duarte AA, van de Ven M, van der Sluijs R,
37 Konstantinopoulos PA, Jonkers J, Ceccaldi R, Rottenberg S, D'andrea AD. 2017. EZH2
38 promotes degradation of stalled replication forks by recruiting MUS81 through
39 histone H3 trimethylation. *Nat Cell Biol.* 19:1371–1378.

40
41 Roy U, Mukherjee S, Sharma A, Frank EG, Schärer OD. 2016. The structure and
42 duplex context of DNA interstrand crosslinks affects the activity of DNA polymerase
43 η . *Nucleic Acids Res.* 44:7281–7291.

44
45 Saint-Léger A, Koelblen M, Civitelli L, Bah A, Djerbi N, Giraud-Panis M-J, Londoño-
46 Vallejo A, Ascenzioni F, Gilson E. 2014. The basic N-terminal domain of TRF2 limits
47 recombination endonuclease action at human telomeres. *cc.* 13.

48
49 Saito TT, Colaiácovo MP. 2014. Crossover recombination mediated by HIM-18/SLX4-
50 associated nucleases. *Worm.* 3:e28233.

51
52 Saito TT, Lui DY, Kim H-M, Meyer K, Colaiácovo MP. 2013. Interplay between
53
54

- 1
2
3 Structure-Specific Endonucleases for Crossover Control during *Caenorhabditis*
4 *elegans* Meiosis. Lichten M, editor. *PLoS Genet.* 9:e1003586.
5
- 6 Saito TT, Youds JL, Boulton SJ, Colaiácovo MP. 2009. *Caenorhabditis elegans* HIM-
7 18/SLX-4 interacts with SLX-1 and XPF-1 and maintains genomic integrity in the
8 germline by processing recombination intermediates. Lichten M, editor. *PLoS Genet.*
9 5:e1000735.
10
- 11 Salewsky B, Schmiester M, Schindler D, Digweed M, Demuth I. 2012. The nuclease
12 hSNM1B/Apollo is linked to the Fanconi anemia pathway via its interaction with
13 FANCP/SLX4. *Hum Mol Genet.* 21:4948–4956.
14
- 15 Sanchez Y, Bachant J, Wang H, Hu F, Liu D, Tetzlaff M, Elledge SJ. 1999. Control of the
16 DNA damage checkpoint by chk1 and rad53 protein kinases through distinct
17 mechanisms. *Science.* 286:1166–1171.
18
- 19 Sarangi P, Altmannova V, Holland C, Bartosova Z, Hao F, Anrather D, Ammerer G, Lee
20 SE, Krejci L, Zhao X. 2014. A Versatile Scaffold Contributes to Damage Survival via
21 Sumoylation and Nuclease Interactions. *Cell Rep.* 9:1–11.
22
- 23 Sarek G, Vannier J-B, Panier S, Petrini JHJ, Boulton SJ. 2015. TRF2 recruits RTEL1 to
24 telomeres in S phase to promote t-loop unwinding. 57:622–635.
25
- 26 Sarkar J, Wan B, Yin J, Vallabhaneni H, Horvath K, Kulikowicz T, Bohr VA, Zhang Y, Lei
27 M, Liu Y. 2015. SLX4 contributes to telomere preservation and regulated processing
28 of telomeric joint molecule intermediates. *Nucleic Acids Res.* 43:5912–5923.
29
- 30 Schlacher K, Christ N, Siaud N, Egashira A, Wu H, Jasin M. 2011. Double-strand break
31 repair-independent role for BRCA2 in blocking stalled replication fork degradation
32 by MRE11. *Cell.* 145:529–542.
33
- 34 Schlacher K, Wu H, Jasin M. 2012. A distinct replication fork protection pathway
35 connects Fanconi anemia tumor suppressors to RAD51-BRCA1/2. *Cancer Cell.*
36 22:106–116.
37
- 38 Schmutz I, Timashev L, Xie W, Patel DJ, de Lange T. 2017. TRF2 binds branched DNA
39 to safeguard telomere integrity. *Nat Struct Mol Biol.*
40
- 41 Schuster B, Knies K, Stoepker C, Velleuer E, Friedl R, Gottwald-Mühlhauser B, de
42 Winter JP, Schindler D. 2013. Whole Exome Sequencing Reveals Uncommon
43 Mutations in the Recently Identified Fanconi Anemia Gene SLX4/FANCP. *Hum Mutat.*
44 34:93–96.
45
- 46 Schwartz EK, Wright WD, Ehmsen KT, Evans JE, Stahlberg H, Heyer W-D. 2012.
47 Mus81-Mms4 function as a single heterodimer to cleave nicked intermediates in
48 recombinational DNA repair. *Mol Cell Biol.* 32:3065–3080.
49
- 50 Sciamanna I, De Luca C, Spadafora C. 2016. The Reverse Transcriptase Encoded by
51 LINE-1 Retrotransposons in the Genesis, Progression, and Therapy of Cancer. *Front*
52 *Chem.* 4:6.
53
54
55
56
57
58
59
60

- 1
2
3 Segurado M, Diffley JFX. 2008. Separate roles for the DNA damage checkpoint
4 protein kinases in stabilizing DNA replication forks. *Genes Dev.* 22:1816–1827.
5
- 6 Sengerová B, Allerston CK, Abu M, Lee SY, Hartley J, Kiakos K, Schofield CJ, Hartley JA,
7 Gileadi O, McHugh PJ. 2012. Characterization of the human SNM1A and
8 SNM1B/Apollo DNA repair exonucleases. *Journal of Biological Chemistry.*
9 287:26254–26267.
10
- 11 Sfeir A, Kosiyatrakul ST, Hockemeyer D, Macrae SL, Karlseder J, de Lange T. 2009.
12 Mammalian telomeres resemble fragile sites and require TRF1 for efficient
13 replication. 138:90–103.
14
- 15 Smeaton MB, Hlavin EM, McGregor Mason T, Noronha AM, Wilds CJ, Miller PS. 2008.
16 Distortion-dependent unhooking of interstrand cross-links in mammalian cell
17 extracts. *Biochemistry.* 47:9920–9930.
18
- 19 Smith GR, Boddy MN, Shanahan P, Russell P. 2003. Fission yeast Mus81/Eme1
20 Holliday junction resolvase is required for meiotic crossing over but not for gene
21 conversion. 165:2289–2293.
22
- 23 Sobinoff AP, Allen JA, Neumann AA, Yang SF, Walsh ME, Henson JD, Reddel RR,
24 Pickett HA. 2017. BLM and SLX4 play opposing roles in recombination-dependent
25 replication at human telomeres. *EMBO J.* 36:2907–2919.
26
- 27 Sogo JM, Lopes M, Foiani M. 2002. Fork reversal and ssDNA accumulation at stalled
28 replication forks owing to checkpoint defects. *Science.* 297:599–602.
29
- 30 Somyajit K, Saxena S, Babu S, Mishra A, Nagaraju G. 2015. Mammalian RAD51
31 paralogs protect nascent DNA at stalled forks and mediate replication restart.
32 *Nucleic Acids Res.* 43:9835–9855.
33
- 34 Sonoda E, Sasaki MS, Buerstedde JM, Bezzubova O, Shinohara A, Ogawa H, Takata M,
35 Yamaguchi-Iwai Y, Takeda S. 1998. Rad51-deficient vertebrate cells accumulate
36 chromosomal breaks prior to cell death. *EMBO J.* 17:598–608.
37
- 38 Sotiriou SK, Kamileri I, Lugli N, Evangelou K, Da-Ré C, Huber F, Padayachy L, Tardy S,
39 Nicati NL, Barriot S, et al. 2016. Mammalian RAD52 Functions in Break-Induced
40 Replication Repair of Collapsed DNA Replication Forks. *Mol Cell.* 64:1127–1134.
41
- 42 Sousa FG, Matuo R, Tang S-W, Rajapakse VN, Luna A, Sander C, Varma S, Simon PHG,
43 Doroshov JH, Reinhold WC, Pommier Y. 2015. Alterations of DNA repair genes in the
44 NCI-60 cell lines and their predictive value for anticancer drug activity. *DNA Repair*
45 (Amst). 28:1–9.
46
- 47 Stoepler C, Hain K, Schuster B, Hilhorst-Hofstee Y, Rooimans MA, Steltenpool J,
48 Oostra AB, Eirich K, Korthof ET, Nieuwint AWM, et al. 2011. SLX4, a coordinator of
49 structure-specific endonucleases, is mutated in a new Fanconi anemia subtype. *Nat*
50 *Genet.* 43:138–141.
51
- 52 Sugawara N, Pâques F, Colaiácovo M, Haber JE. 1997. Role of *Saccharomyces*
53
54
55
56
57
58
59
60

- 1
2
3 cerevisiae Msh2 and Msh3 repair proteins in double-strand break-induced
4 recombination. *Proc Natl Acad Sci USA*. 94:9214–9219.
5
- 6 Svendsen JM, Smogorzewska A, Sowa ME, O'Connell BC, Gygi SP, Elledge SJ, Harper
7 JW. 2009. Mammalian BTBD12/SLX4 assembles a Holliday junction resolvase and is
8 required for DNA repair. *138:63–77*.
9
- 10 Syljuåsen RG, Sørensen CS, Hansen LT, Fugger K, Lundin C, Johansson F, Helleday T,
11 Sehested M, Lukas J, Bartek J. 2005. Inhibition of human Chk1 causes increased
12 initiation of DNA replication, phosphorylation of ATR targets, and DNA breakage.
13 *Mol Cell Biol*. 25:3553–3562.
14
- 15 Szakal B, Branzei D. 2013. Premature Cdk1/Cdc5/Mus81 pathway activation induces
16 aberrant replication and deleterious crossover. *EMBO J*. 32:1155–1167.
17
- 18 Taglialatela A, Alvarez S, Leuzzi G, Sannino V, Ranjha L, Huang J-W, Madubata C,
19 Anand R, Levy B, Rabadan R, et al. 2017. Restoration of Replication Fork Stability in
20 BRCA1- and BRCA2-Deficient Cells by Inactivation of SNF2-Family Fork Remodelers.
21 *Mol Cell*. 68:414–430.e8.
22
- 23 Tay YD, Wu L. 2010. Overlapping roles for Yen1 and Mus81 in cellular Holliday
24 junction processing. *Journal of Biological Chemistry*. 285:11427–11432.
25
- 26 Técher H, Koundrioukoff S, Nicolas A, Debatisse M. 2017. The impact of replication
27 stress on replication dynamics and DNA damage in vertebrate cells. *Nat Rev Genet*.
28 18:535–550.
29
- 30 Thompson R, Montano R, Eastman A. 2012. The Mre11 nuclease is critical for the
31 sensitivity of cells to Chk1 inhibition. *PLoS ONE*. 7:e44021.
32
- 33 Tian Y, Paramasivam M, Ghosal G, Chen D, Shen X, Huang Y, Akhter S, Legerski R,
34 Chen J, Seidman MM, et al. 2015. UHRF1 Contributes to DNA Damage Repair as a
35 Lesion Recognition Factor and Nuclease Scaffold. *Cell Rep*. 10:1957–1966.
36
- 37 Toh GW-L, Sugawara N, Dong J, Toth R, Lee SE, Haber JE, Rouse J. 2010. Mec1/Tel1-
38 dependent phosphorylation of Slx4 stimulates Rad1-Rad10-dependent cleavage of
39 non-homologous DNA tails. *DNA Repair (Amst)*. 9:718–726.
40
- 41 Toledo LI, Altmeyer M, Rask M-B, Lukas C, Larsen DH, Povlsen LK, Bekker-Jensen S,
42 Mailand N, Bartek J, Lukas J. 2013. ATR prohibits replication catastrophe by
43 preventing global exhaustion of RPA. *Cell*. 155:1088–1103.
44
- 45 Trowbridge K, McKim K, Brill SJ, Sekelsky J. 2007. Synthetic lethality of *Drosophila* in
46 the absence of the MUS81 endonuclease and the DmBlm helicase is associated with
47 elevated apoptosis. *176:1993–2001*.
48
- 49 Vannier J-B, Pavicic-Kaltenbrunner V, Petalcorin MIR, Ding H, Boulton SJ. 2012.
50 RTEL1 dismantles T loops and counteracts telomeric G4-DNA to maintain telomere
51 integrity. *149:795–806*.
52
53
54
55
56
57
58
59
60

1
2
3 Vannier J-B, Sandhu S, Petalcorin MIR, Wu X, Nabi Z, Ding H, Boulton SJ. 2013. RTEL1
4 is a replisome-associated helicase that promotes telomere and genome-wide
5 replication. *Science*. 342:239–242.
6

7 Vujanovic M, Krietsch J, Raso MC, Terraneo N, Zellweger R, Schmid JA, Taglialatela A,
8 Huang J-W, Holland CL, Zwicky K, et al. 2017. Replication Fork Slowing and Reversal
9 upon DNA Damage Require PCNA Polyubiquitination and ZRANB3 DNA Translocase
10 Activity. *Mol Cell*. 67:882–890.e5.
11

12 Wan B, Yin J, Horvath K, Sarkar J, Chen Y, Wu J, Wan K, Lu J, Gu P, Yu EY, et al. 2013.
13 SLX4 Assembles a Telomere Maintenance Toolkit by Bridging Multiple
14 Endonucleases with Telomeres. *Cell Rep*. 4:861–869.
15

16 Wang AT, Wang AT, Sengerová B, Sengerova B, Cattell E, Cattell E, Inagawa T,
17 Inagawa T, Hartley JM, Hartley JM, et al. 2011. Human SNM1A and XPF-ERCC1
18 collaborate to initiate DNA interstrand cross-link repair. *Genes Dev*. 25:1859–1870.
19

20 Wechsler T, Newman S, West SC. 2011. Aberrant chromosome morphology in human
21 cells defective for Holliday junction resolution. *Nature*. 471:642–646.
22

23 Wilson JSJ, Tejera AM, Castor D, Toth R, Blasco MA, Rouse J. 2013. Localization-
24 Dependent and -Independent Roles of SLX4 in Regulating Telomeres. *Cell Rep*.
25 4:853–860.
26

27 Wilson TE, Arlt MF, Park SH, Rajendran S, Paulsen M, Ljungman M, Glover TW. 2015.
28 Large transcription units unify copy number variants and common fragile sites
29 arising under replication stress. *Genome Res*. 25:189–200.
30

31 Wyatt HDM, Laister RC, Martin SR, Arrowsmith CH, West SC. 2017. The SMX DNA
32 Repair Tri-nuclease. *Mol Cell*. 65:848–860.e11.
33

34 Wyatt HDM, Sarbajna S, Matos J, West SC. 2013. Coordinated Actions of SLX1-SLX4
35 and MUS81-EME1 for Holliday Junction Resolution in Human Cells. 52:1–14.
36

37 Xu Y, Ning S, Wei Z, Xu R, Xu X, Xing M, Guo R, Xu D. 2017. 53BP1 and BRCA1 control
38 pathway choice for stalled replication restart. *Elife*. 6:e30523.
39

40 Yamamoto KN, Kobayashi S, Tsuda M, Kurumizaka H, Takata M, Kono K, Jiricny J,
41 Takeda S, Hirota K. 2011. Involvement of SLX4 in interstrand cross-link repair is
42 regulated by the Fanconi anemia pathway. *Proceedings of the National Academy of
43 Sciences*. 108:6492–6496.
44

45 Yildiz O, Majumder S, Kramer B, Sekelsky JJ. 2002. *Drosophila* MUS312 interacts with
46 the nucleotide excision repair endonuclease MEI-9 to generate meiotic crossovers.
47 10:1503–1509.
48

49 Yin J, Wan B, Sarkar J, Horvath K, Wu J, Chen Y, Cheng G, Wan K, Chin P, Lei M, Liu Y.
50 2016. Dimerization of SLX4 contributes to functioning of the SLX4-nuclease complex.
51 *Nucleic Acids Res*. 44:gkw354–4880.
52

1
2
3 Ying S, Minocherhomji S, Chan KL, Palmal-Pallag T, Chu WK, Wass T, Mankouri HW,
4 Liu Y, Hickson ID. 2013. MUS81 promotes common fragile site expression. *Nat Cell*
5 *Biol.* 15:1001–1007.

6
7 Zakharyevich K, Tang S, Ma Y, Hunter N. 2012. Delineation of joint molecule
8 resolution pathways in meiosis identifies a crossover-specific resolvase. 149:334–
9 347.

10
11 Zappulla DC, Maharaj ASR, Connelly JJ, Jockusch RA, Sternglanz R. 2006. Rtt107/Esc4
12 binds silent chromatin and DNA repair proteins using different BRCT motifs. *BMC*
13 *Mol Biol.* 7:40.

14
15 Zellweger R, Dalcher D, Mutreja K, Berti M, Schmid JA, Herrador R, Vindigni A, Lopes
16 M. 2015. Rad51-mediated replication fork reversal is a global response to genotoxic
17 treatments in human cells. *J Cell Biol.* 208:563–579.

18
19 Zeman MK, Cimprich KA. 2014. Causes and consequences of replication stress. *Nat*
20 *Cell Biol.* 16:2–9.

21
22 Zeng S, Xiang T, Pandita TK, Gonzalez-Suarez I, Gonzalo S, Harris CC, Yang Q. 2009.
23 Telomere recombination requires the MUS81 endonuclease. *Nat Cell Biol.* 11:616–
24 623.

25
26 Zeng S, Yang Q. 2009. The MUS81 endonuclease is essential for telomerase negative
27 cell proliferation. *cc.* 8:2157–2160.

28
29 Zhang J, Walter JC. 2014. Mechanism and regulation of incisions during DNA
30 interstrand cross-link repair. *DNA Repair (Amst).* 19:135–142.

31
32 Zhang T, Nirantar S, Lim HH, Sinha I, Surana U. 2009. DNA damage checkpoint
33 maintains CDH1 in an active state to inhibit anaphase progression. *Dev Cell.* 17:541–
34 551.

35
36 Zhu X-D, Niedernhofer L, Kuster B, Mann M, Hoeijmakers JHJ, de Lange T. 2003.
37 ERCC1/XPF removes the 3' overhang from uncapped telomeres and represses
38 formation of telomeric DNA-containing double minute chromosomes. 12:1489–
39 1498.

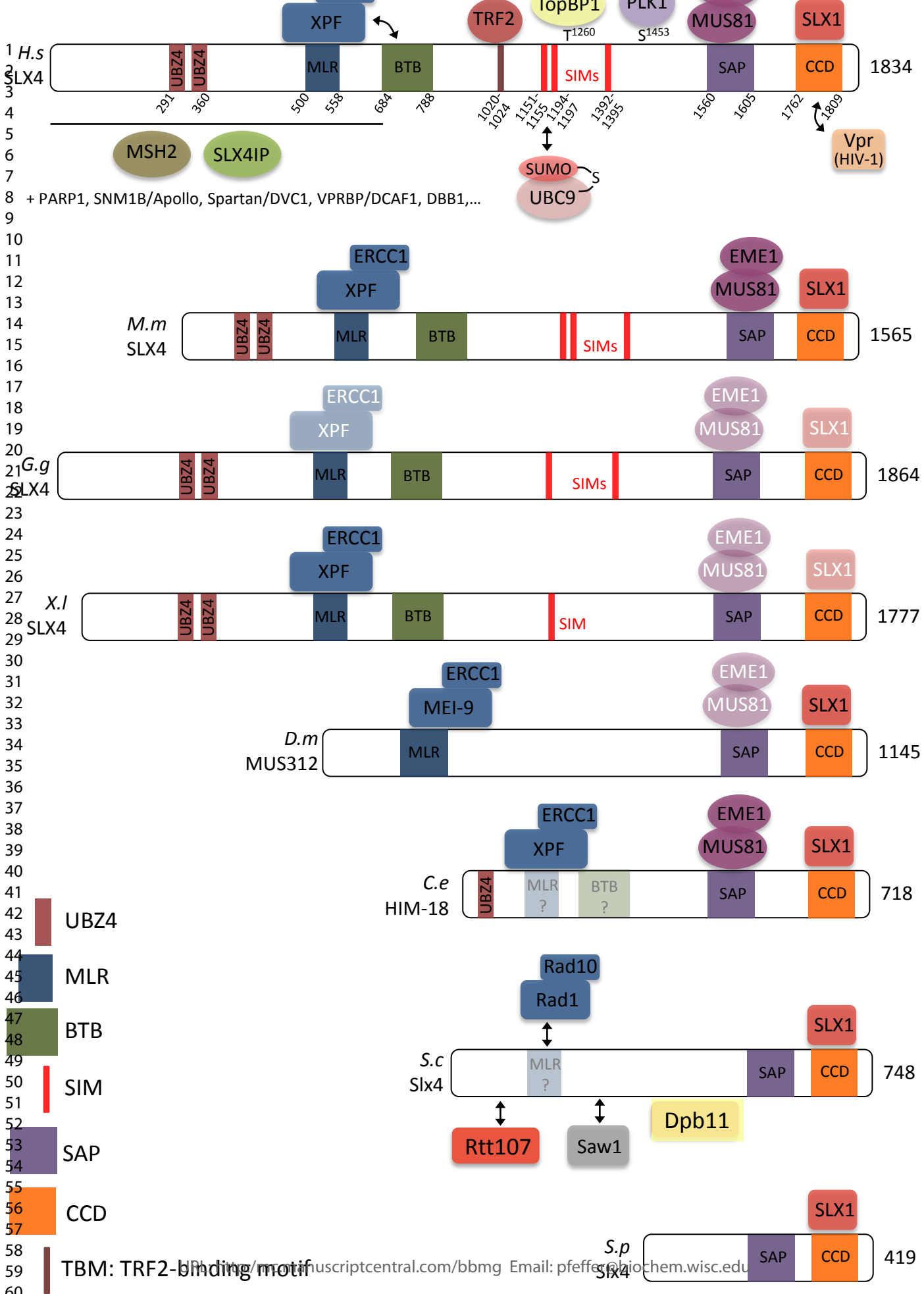

A

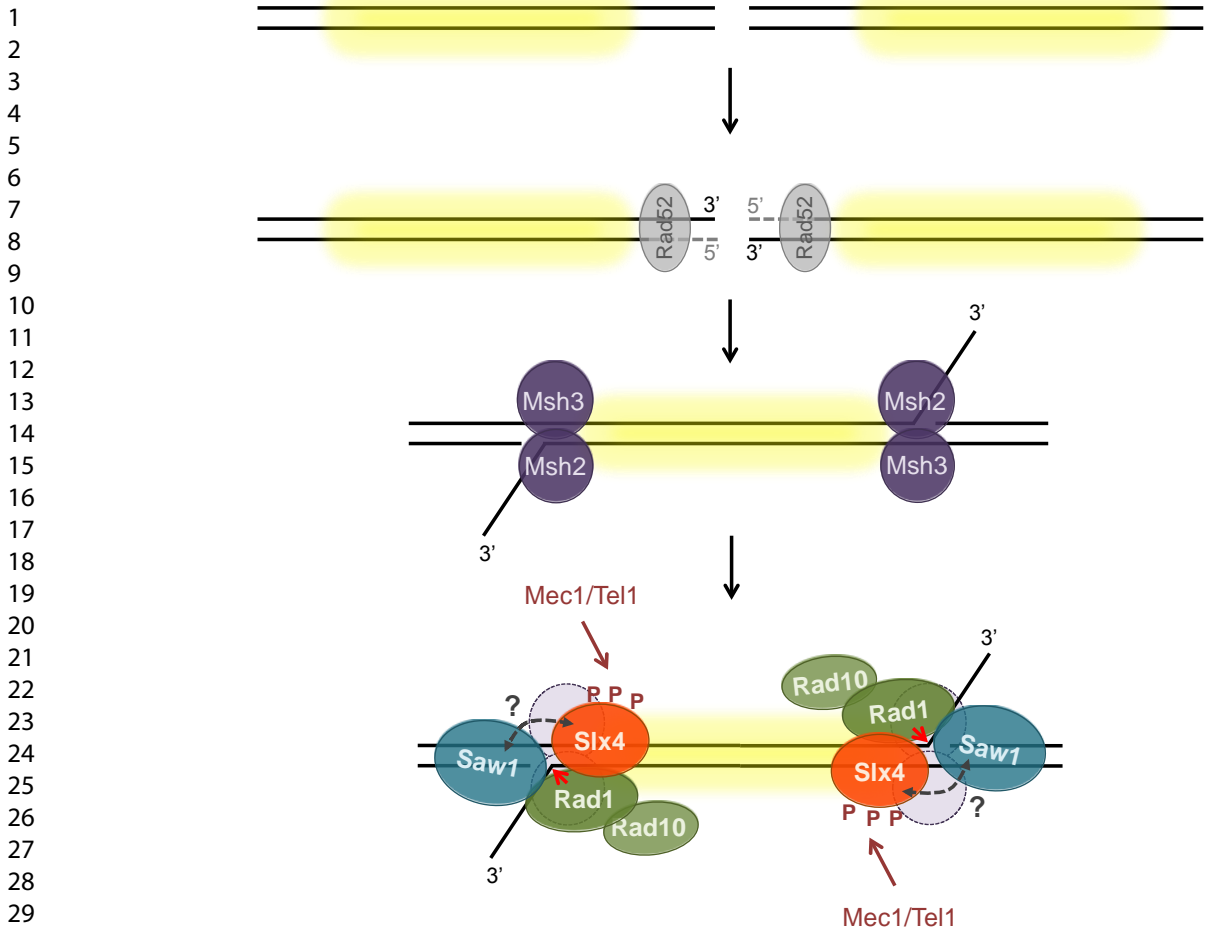

B

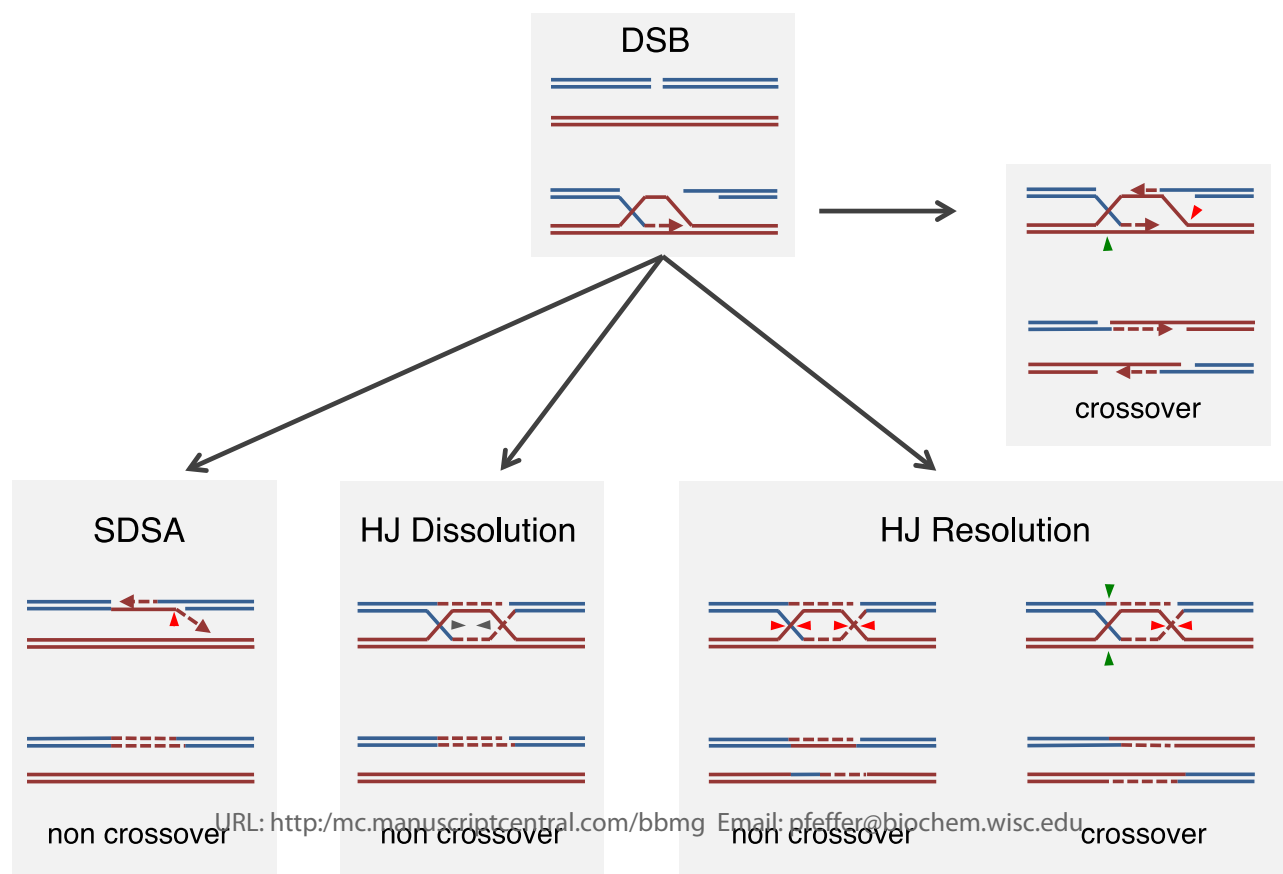

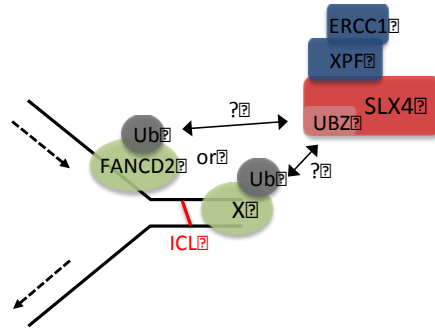

B Possibilities for SLX4-XPF-dependent ICL incisions

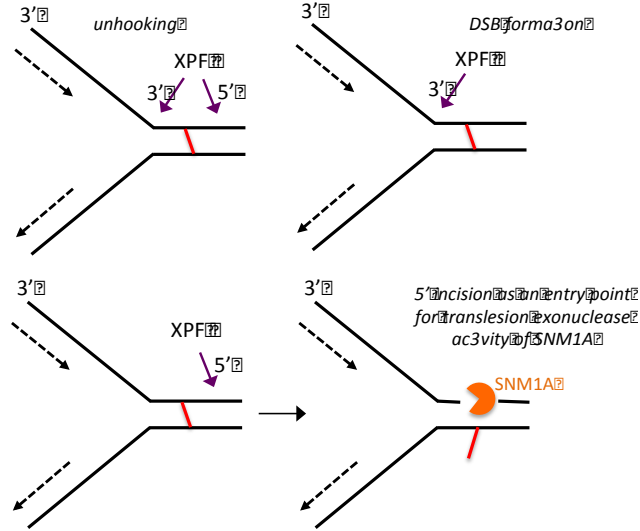

C Dual fork model

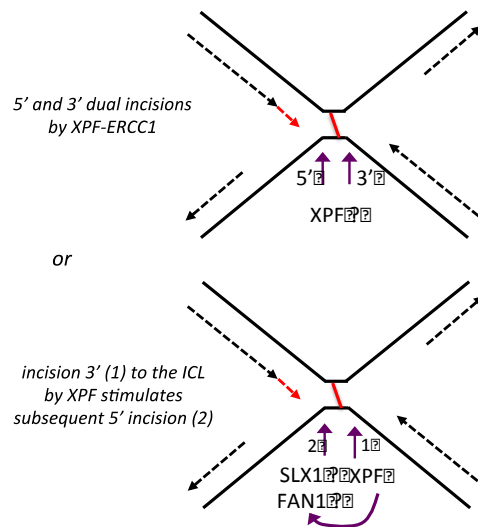

D XPF or SLX4 deficiency

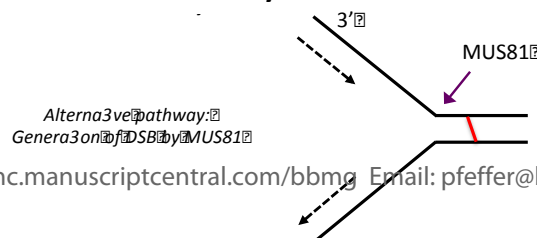

1
2
3
4
5
6
7
8
9
10
11
12
13
14
15
16
17
18
19
20
21
22
23
24
25
26
27
28
29
30
31
32
33
34
35
36
37
38
39
40
41
42
43
44
45
46
47
48
49
50
51
52
53
54
55
56
57
58
59
60

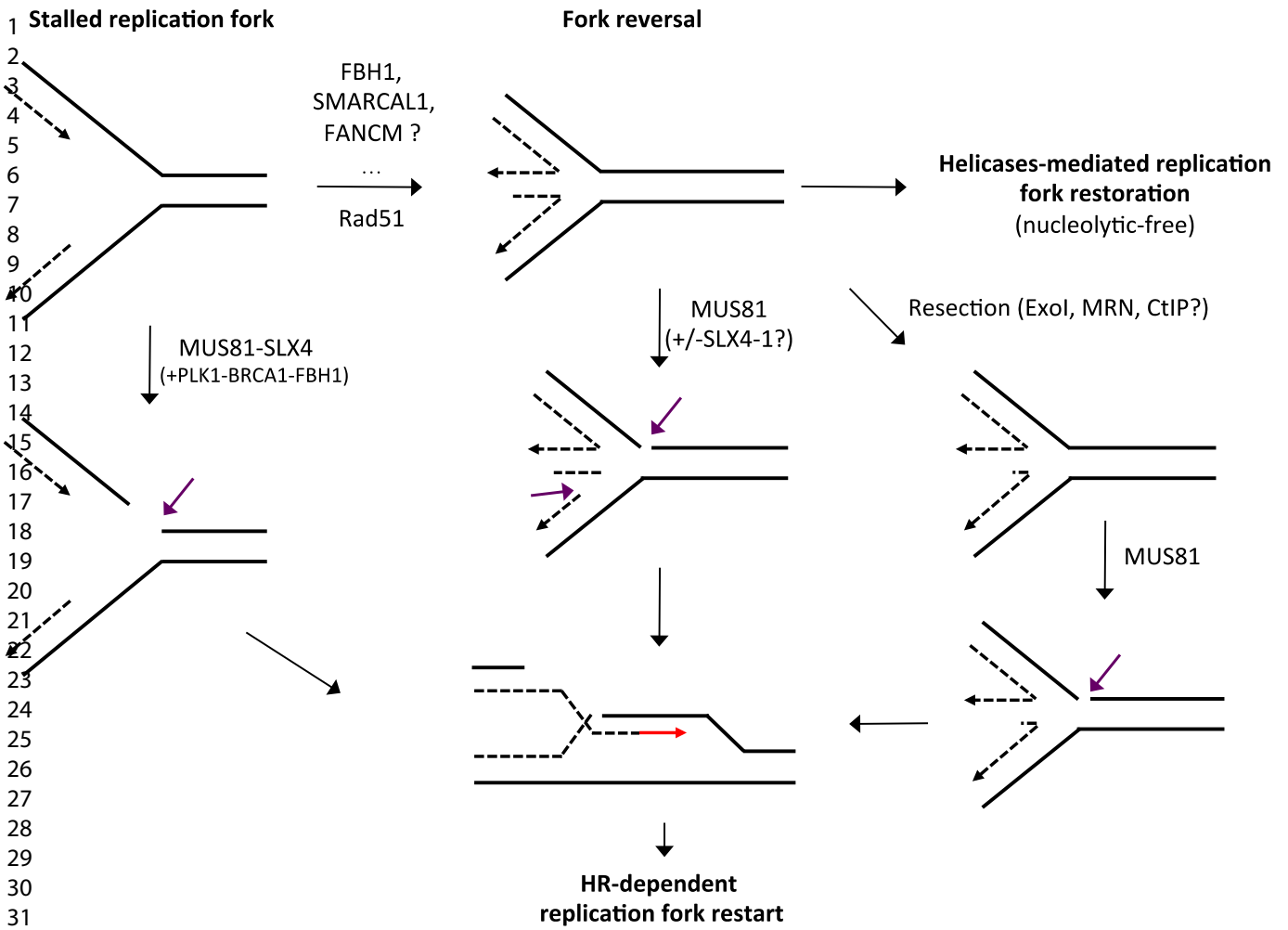

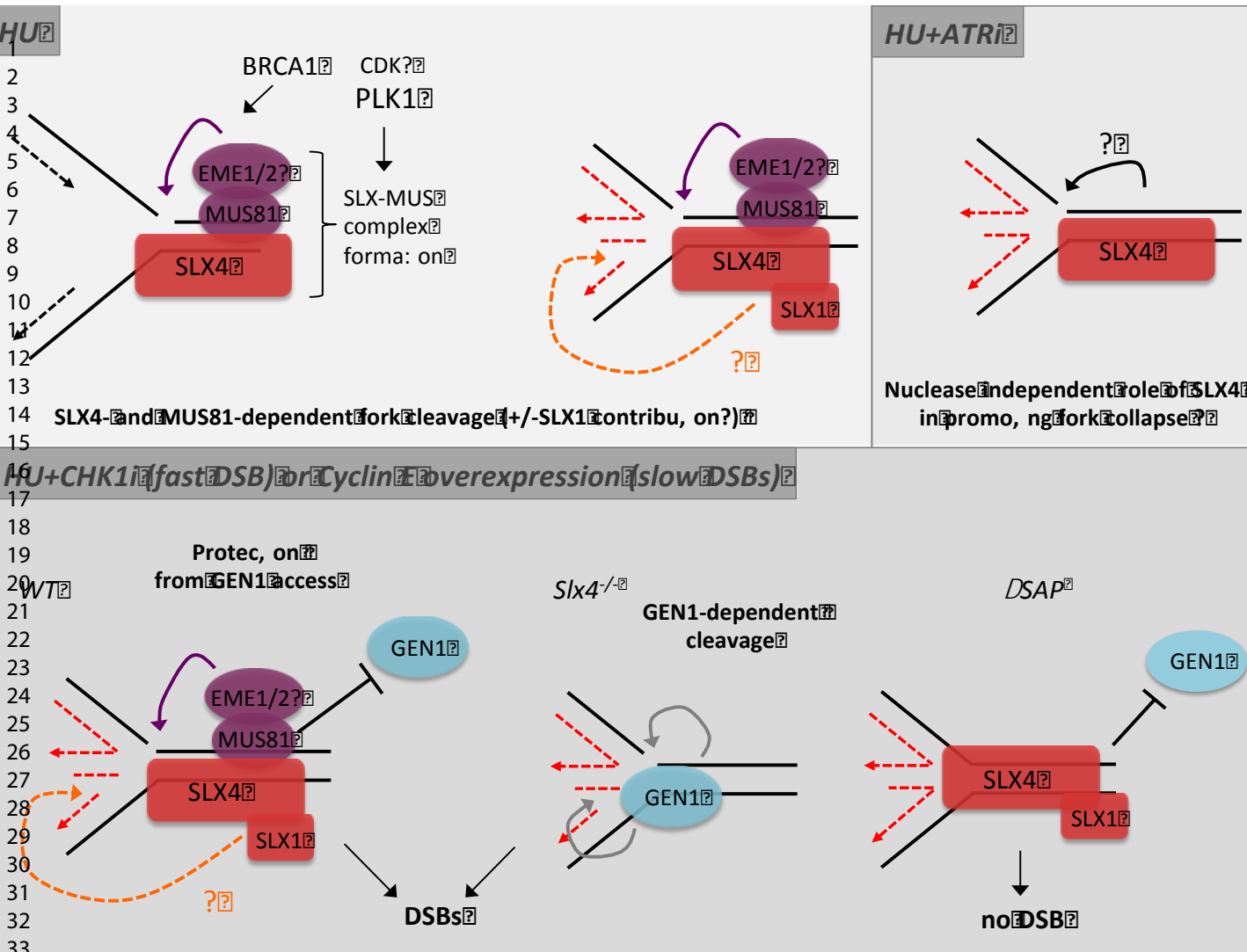

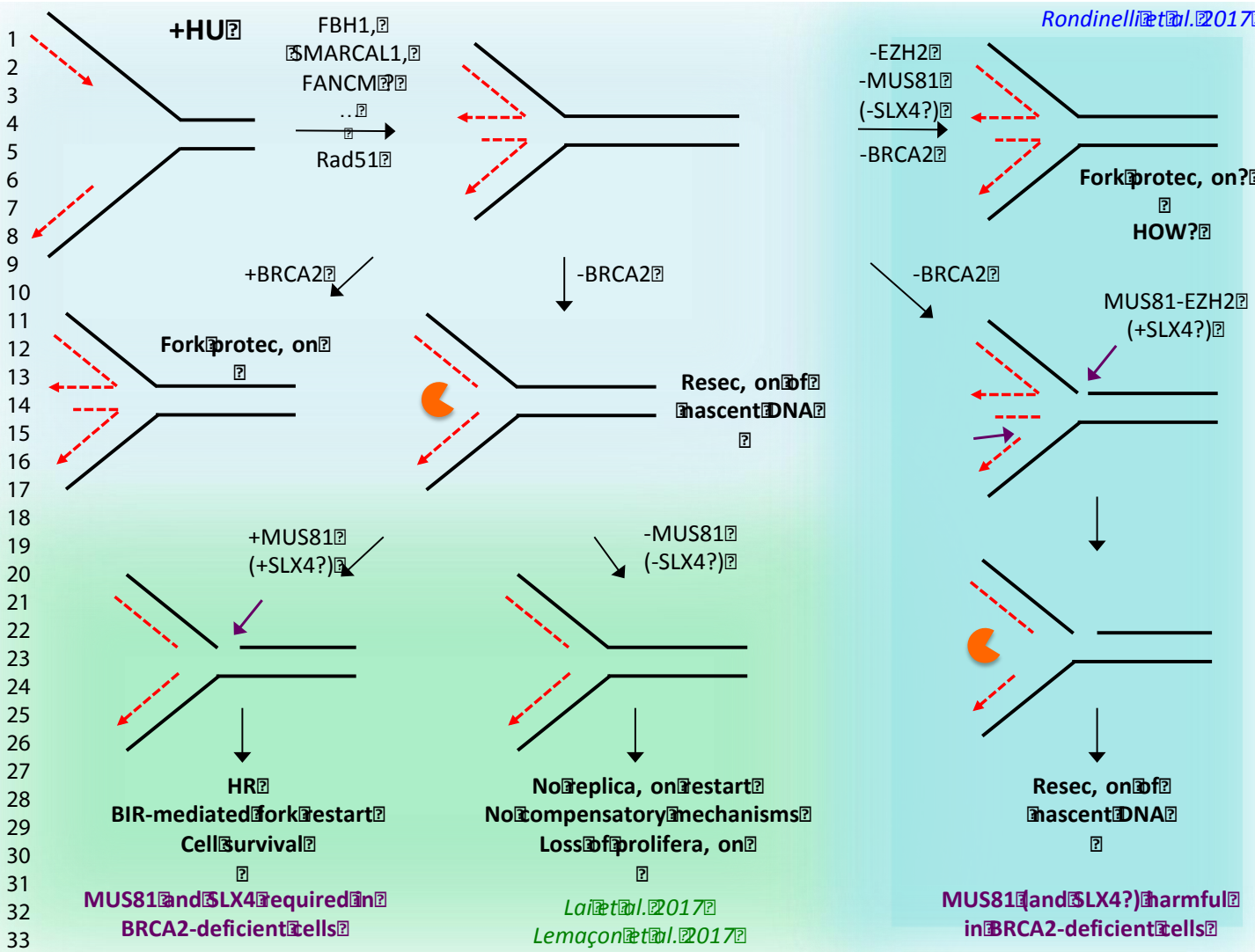

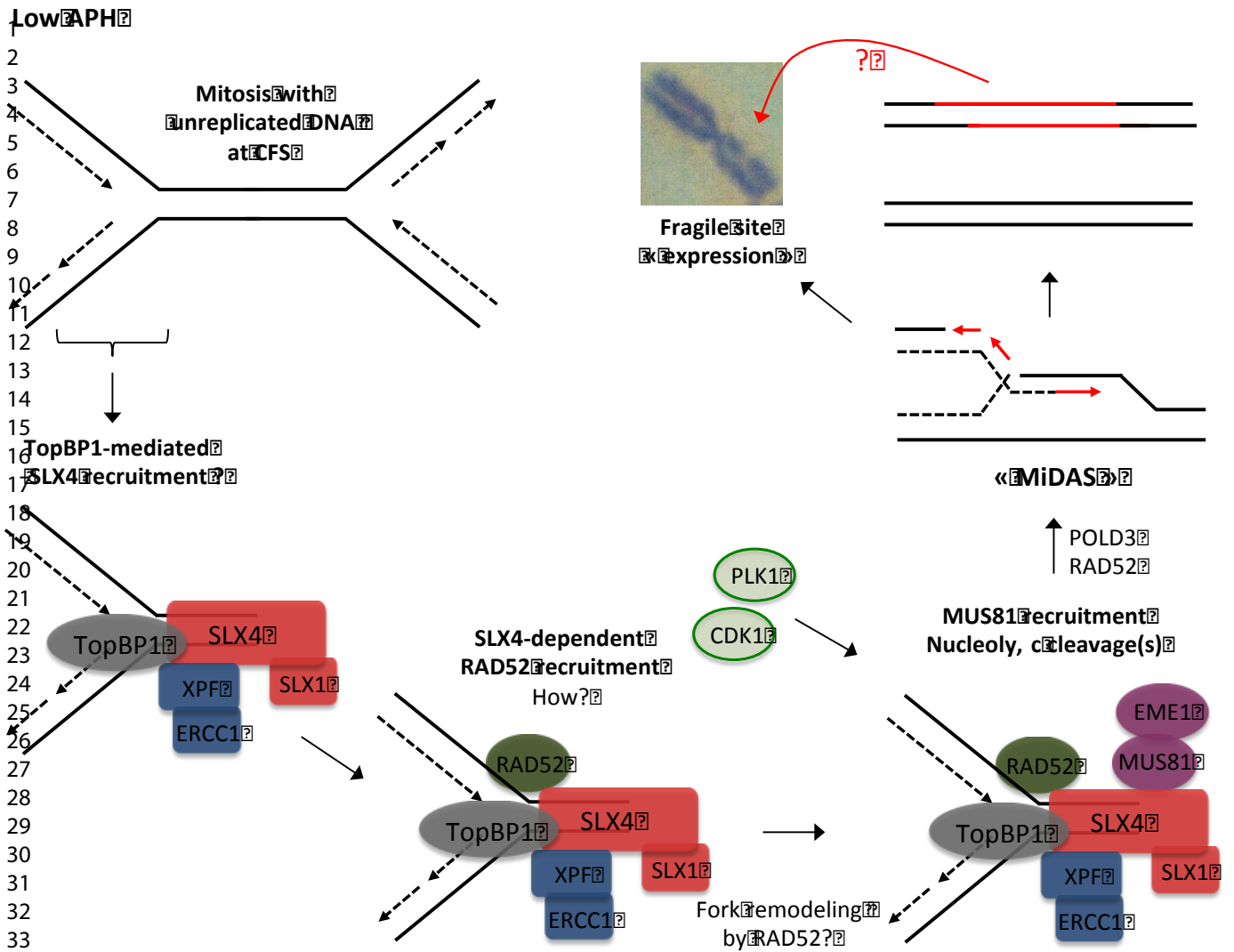

1
2
3
4
5
6
7
8
9
10
11
12
13
14
15
16
17
18
19
20
21
22
23
24
25
26
27
28
29
30
31
32
33
34
35
36
37
38
39
40
41
42
43
44
45
46
47
48
49
50
51
52
53
54
55
56
57
58
59
60

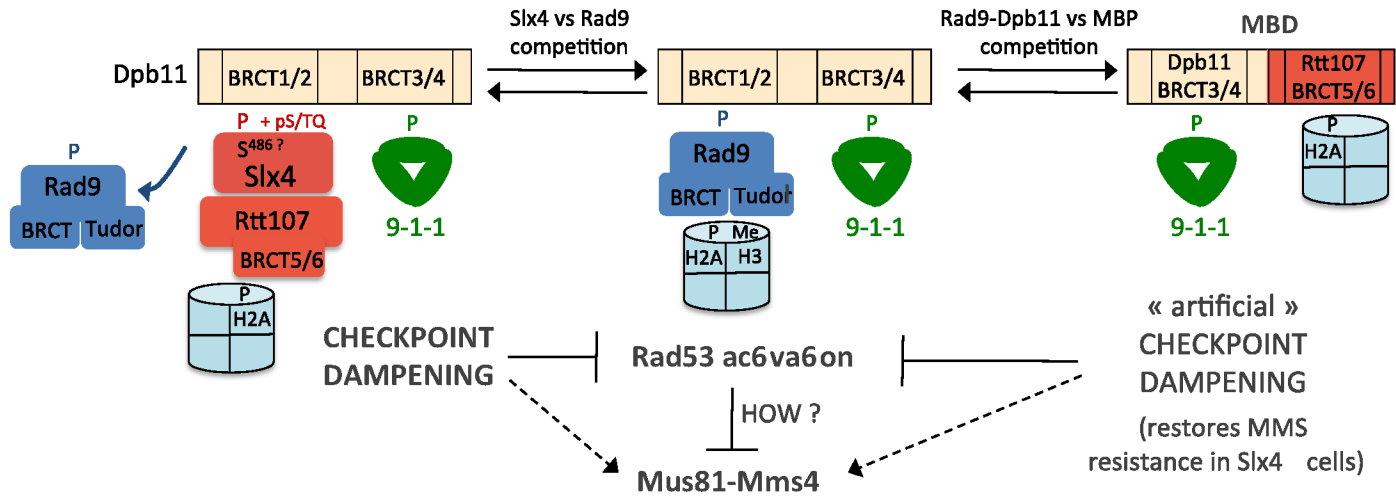

Several possibilities for Slx4 and Mus81-Mms4-containing complexes

