



HAL
open science

Wavenumber identification technique for axial-symmetric structures

G Tufano, C Droz, O. Bareille, A.-M Zine, B Pluymers, W Desmet, Mohamed
Ichchou

► **To cite this version:**

G Tufano, C Droz, O. Bareille, A.-M Zine, B Pluymers, et al.. Wavenumber identification technique for axial-symmetric structures. International Conference on Noise and Vibration Engineering and USD 2018, KU Leuven, Sep 2018, Leuven, Belgium. hal-02393153

HAL Id: hal-02393153

<https://hal.science/hal-02393153>

Submitted on 4 Dec 2019

HAL is a multi-disciplinary open access archive for the deposit and dissemination of scientific research documents, whether they are published or not. The documents may come from teaching and research institutions in France or abroad, or from public or private research centers.

L'archive ouverte pluridisciplinaire **HAL**, est destinée au dépôt et à la diffusion de documents scientifiques de niveau recherche, publiés ou non, émanant des établissements d'enseignement et de recherche français ou étrangers, des laboratoires publics ou privés.

Wavenumber identification technique for axial-symmetric structures

G. Tufano^{1,2}, C. Droz^{1,2}, O. Bareille¹, A.-M. Zine³, B. Pluymers^{2,4}, W. Desmet^{2,4}, M. Ichchou¹

¹ Vibroacoustic and Complex Media Research Group, LTDS, École Centrale de Lyon

36 Avenue Guy de Collongue, 69134, Écully, France

e-mail: giovanni.tufano@ec-lyon.fr

² Noise and Vibration Research Group, PMA, KU Leuven

Celestijnenlaan 300 B, B-3001, Heverlee, Belgium

³ Institut Camille Jordan, Département de Maths-Info, École Centrale de Lyon

36 Avenue Guy de Collongue, 69134, Écully, France

⁴ DMMS core lab, Flanders Make, Belgium

Abstract

This paper investigates the broadband vibro-acoustic and dynamic behavior of different structures, such as flat and curved panels and cylindrical shells. The aim of this work is to investigate propagation and dispersion features through the analysis of the wavenumber domain. The technique used to investigate the vibro-acoustic behavior is a wave propagation based technique, implemented to obtain the propagative and evanescent waves using a harmonic force excitation. The employed techniques are used to obtain the harmonic displacement field, given as primary input for the wavenumber domain analysis. To deeply investigate the dispersion features, a Discrete Fast Fourier Transform (DFFT) technique is used. The whole displacement field could be obtained by experimental tests or by numerical simulations; in our case, it is calculated using a classical Finite Element Analysis (FEA), by a commercial Finite Element package, or by an in-home algorithm, developed in a commercial numerical computing software.

1 Introduction

Flat and curved panels are widely used in the field of transportation engineering. In the aerospace engineering, the shape of the most employed structures for the aircrafts and for the space launchers can be considered to be axial-symmetric (the fuselage of the aircrafts, the first, the upper stages and the fairings of the launchers, for example).

The dynamic behavior and the vibro-acoustic response of these structures are a fundamental challenge for the industry. Indeed, the most important aspect is the understanding of the waves dispersion characteristics under different loading conditions. The identification of the propagation parameters is a fundamental issue in vibro-acoustics. In the last years, some analytical formulations were developed for flat and/or homogeneous structures and they can be found in [1], [2] and [3]. These analytical formulations are limited to the low-frequency domain, in which the mode are well defined; in the mid-high-frequency range classic analytical approach do not give a good estimation of the waves dispersion characteristics. In this bandwidth some statistical and energetic approaches were developed in [4], [5] and [6].

The identification of the wave propagation parameters is one of the most important challenges in vibro-acoustics. In literature several technique are available, especially for one-dimensional structures, mainly based on the loss factor identification, by the research of the complex wavenumber [7]. In their work, McDaniel et al. developed a strategy to estimate the frequency-dependent loss-factor in one-dimensional

structures, identifying the complex wavenumber of flexural and evanescent waves at each frequency.

In the last decades, some applications to two-dimensional structures have been proposed in literature. For example, Ferguson et al. [8] proposed a technique to identify the dominant wavenumber in a considered area, using a windowed field of the displacement of the structure, computing the correlation between the normal velocity measurement and an harmonic wave-field. Another method for the identification of the wavenumber was developed by Grosh et al. [9], based on Prony series.

An interesting algorithm for the identification of the complex wavenumber and of the damping loss factor was developed by Berthaut et al. [10]; the proposed method is called Inhomogeneous Wave Correlation (IWC) method and it allows to identify the complex flexural wavenumber in the broadband frequency range. An application of this method to one- and two-dimensional sandwich structures can be found in [11] and an application on ribbed plates was proposed by Ichchou et al. [12] and [13]; Cherif et al. [14] proposed the damping loss factor identification for flat plates; the identification of the material characteristics of the sandwich panels was proposed by Droz et al. [15]; Van Belle et al. [16] proposed the estimation of the flexural dispersion curve for a plate with local resonators; Van Damme et al. [17] applied this method to identify the mechanical properties of a classical timber plate.

This paper shows the comparison between the classical Discrete Fast Fourier Transform (DFFT) approach and the Inhomogeneous Wave Correlation (IWC) method in the k -space analysis. Both methods are applied on different structures: flat and curved panels and cylindrical structures. The wave field is obtained using either a full Finite Element Analysis (FEA) or a Wave Finite Element Method (WFEM) (this method is widely used in waves propagation investigations and it is well-described in [18], [19], [20], [21] and [22]).

2 Methodology

In this section, two different wavenumber identification techniques are presented. The classical approach in the wavenumber domain analysis is the Continuous Fourier Transform (CFT) and its equivalent in the discrete domain, the Discrete Fourier Transform (DFT). The second method adopted in this work is the Inhomogeneous Wave Correlation method (IWC). Both methods use the harmonic displacement field as primary input, usually defined in the (x, y) plane (see Eq. (1), in which the symbol \hat{w} indicates that the displacement field is frequency-dependent), either from a harmonic excitation or from a temporal Fourier transform.

$$w(x, y, t) = \int_0^{+\infty} \hat{w}(x, y) e^{i\omega t} d\omega \quad (1)$$

The two methods are explained in the next sections; DFT and CFT are briefly described for the sake of clarity.

2.1 Spatial Fourier Transform

The DFT assumes two hypotheses:

1. the displacement field \hat{w} is given in a uniform grid $(x_i = idx, y_j = jdy)_{(1 \leq i \leq N_1-1, 1 \leq j \leq N_2-1)}$, in which N_1 and N_2 are the number of the acquisition points along the axes x and y , respectively, dx and dy are the space increments along the axes x and y , respectively;
2. the field is assumed to be $2D$ -periodic, i.e.:

$$\forall i, j \in \mathbb{N}^2, \hat{w}(idx, jdy) = \hat{w}((i/N_1)dx, (j/N_2)dy) \quad (2)$$

The spatial mesh has to be small enough to satisfy the Nyquist criterion, at the least half of the smallest wavelength of interest; on the other hand, the span of the measurement has to be large enough to have an acceptable resolution in the wavenumber domain.

In the discrete domain, we can assume $\Delta k_x = \frac{2\pi}{N_1 dx}$ and $\Delta k_y = \frac{2\pi}{N_2 dy}$ as a basis for the complex functions space; the family of exponential functions with discrete wavenumbers can be written: $(k_{xp} = p\Delta k_x, k_{yq} = q\Delta k_y)_{(1 \leq p \leq N_1-1, 1 \leq q \leq N_2-1)}$. Consequently, the displacement field can be written as:

$$\hat{w}(x_i, y_j) = \sum_{p=0}^{N_1-1} \sum_{q=0}^{N_2-1} \hat{w}(k_{xp}, k_{yq}) e^{i(k_{xp}x_i + k_{yq}y_j)} \quad (3)$$

The DFT $\hat{w} \rightarrow \hat{\hat{w}}$ assumes the following expression:

$$\hat{\hat{w}}(k_{xp}, k_{yq}) = \frac{1}{N_1 N_2} \sum_{i=0}^{N_1-1} \sum_{j=0}^{N_2-1} \hat{w}(x_i, y_j) e^{-i(k_{xp}x_i + k_{yq}y_j)} \quad (4)$$

The periodicity condition, expressed in Eq. (2), imposes that also the DFT is periodic:

$$\hat{\hat{w}}(k_x, k_y) = \hat{\hat{w}}\left(k_x + \frac{2\pi}{dx}, k_y\right) = \hat{\hat{w}}\left(k_x, k_y + \frac{2\pi}{dy}\right) \quad (5)$$

In this work, the DFT is performed in MATLAB and no additional windowing or signal processing was applied.

2.2 Inhomogeneous Wave Correlation method

Using the same displacement field as for the DFT, the dispersion relation can be found using a different approach: the Inhomogeneous Wave Correlation method. For a fixed frequency f_0 , the spatial response is correlated with an inhomogeneous running wave (Eq. (6)), in which the terms $\theta, \gamma, \frac{2\pi}{k}$ are the heading angle, the attenuation factor and the apparent wavelength, respectively. The wave attenuation is strictly connected to the damping by this relationship: $\gamma = \frac{\eta c_\varphi}{2c_g}$, with η, c_φ, c_g being the damping loss factor, the phase velocity and the group velocity, respectively. This wave is defined as follows:

$$\hat{\sigma}_{k,\gamma,\theta}(x, y) = e^{-ik(\theta)(1+i\gamma(\theta))(x \cos \theta + y \sin \theta)} \quad (6)$$

The unknown wavenumber $k = k_{\Re} + ik_{\Im}$ can be found by the correlation between the inhomogeneous wave and the complete wave field, as the location of the maximum of the normalized correlation function:

$$IWC(k, \gamma, \theta) = \frac{|\iint_S \hat{w} \cdot \hat{\sigma}_{k,\gamma,\theta}^* dx dy|}{\sqrt{\iint_S |\hat{w}|^2 dx dy \cdot \iint_S |\hat{\sigma}_{k,\gamma,\theta}|^2 dx dy}} \quad (7)$$

where * denotes the complex conjugate. The identification of a complex wavenumber for a given direction θ leads to the maximization of the function $(k, \gamma) \rightarrow IWC(k, \gamma, \theta)$; typically, the IWC has a well-defined maximum, denoting the point where the measured signal correlates best with the inhomogeneous wave $\hat{\sigma}_{k,\gamma,\theta}(x, y)$.

In practical applications, the wave field is measurable in discrete points, so the integration over the entire surface S in Eq. (7) is replaced by a finite weighted sum:

$$\iint_S dx dy \implies \sum_{i=1}^N \rho_i S_i \quad (8)$$

where ρ_i is the coherence of the measured data at each point ($\rho_i = 1$ if the coherence is not available) and S_i is an estimation of the surface around the point i .

$$IWC(k, \gamma, \theta) = \frac{|\sum_{i=1}^N \hat{w}(x_i, y_i) \cdot \hat{\sigma}_{k, \gamma, \theta}^*(x_i, y_i) S_i|}{\sqrt{\sum_{i=1}^N |\hat{w}(x_i, y_i)|^2 S_i \cdot \sum_{i=1}^N |\hat{\sigma}_{k, \gamma, \theta}(x_i, y_i)|^2 S_i}} \quad (9)$$

Considering the well-known relationships between arcs and angles, and the transformation from the Cartesian coordinates reference system to the cylindrical one, the IWC method can be applied also on curved structure. Moving from the couple of coordinates (x, y) to the couple of coordinates (x, φ) and taking in account the circumferential wavenumber (Eq. (10)) instead of the one along the y axis, the new formulation of the IWC method can be easily developed.

$$k_\theta = k_x R = k_x \frac{\Delta x}{\Delta \theta} \quad (10)$$

where $\Delta \theta$ is the angular distance.

In this work, the IWC method is implemented in MATLAB, for both reference systems.

3 Numerical applications and results

In this section, the methods previously explained are applied to a flat (Fig. 1) and a curved (Fig. 2) panels and to a cylindrical shell (Fig. 3). The numerical models are built using a commercial Finite Element (FE) package. The numerical simulations of the two panels are obtained by a full FE analysis while the cylindrical shell is analyzed with a WFEM approach.

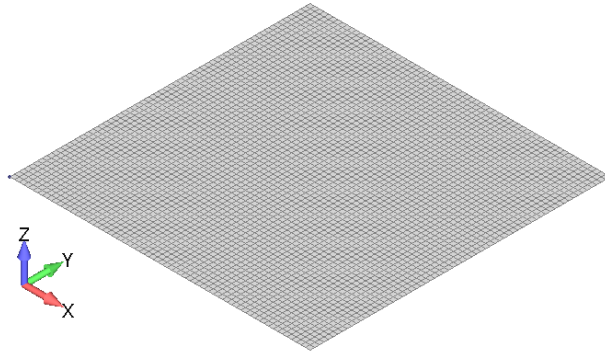

Figure 1: Flat panel: Finite Element Model

3.1 Flat panel

The first application is made on an isotropic flat panel. The employed material is a common alloy ($E = 70.0 \times 10^9$ Pa, $\nu = 0.33$ and $\rho = 2700.0$ kg/m³) and the geometric properties are: $L_x = L_y = 1.0$ m and $t = 0.001$ m. The FE model of the panel is shown in Fig. 1.

The harmonic displacement field is obtained by numerical simulations using an *in-home* algorithm developed in MATLAB. The displacement field is calculated for different locations of the harmonic punctual excitation; in the specific case hereby shown, the force is located in the middle of the plate, on the bottom surface. The normal displacements are then extracted and used as primary input for the FFT and IWC calculations. All the simulations were performed considering with free-free boundary conditions. A constant structural damping is assumed and fixed at 1%; the dynamic matrix has the following expression: $D = K(1 + i\eta) - \omega^2 M$. The

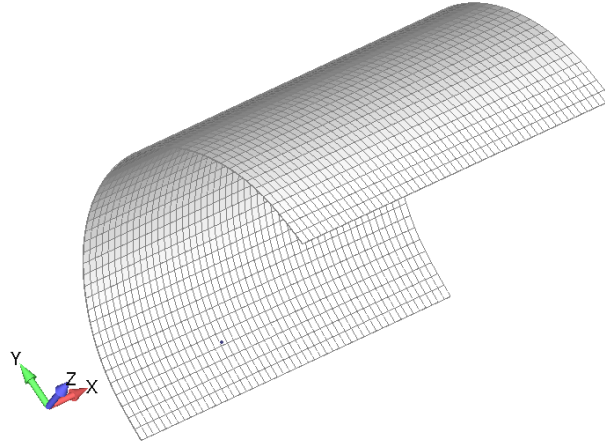

Figure 2: Curved panel: Finite Element Model

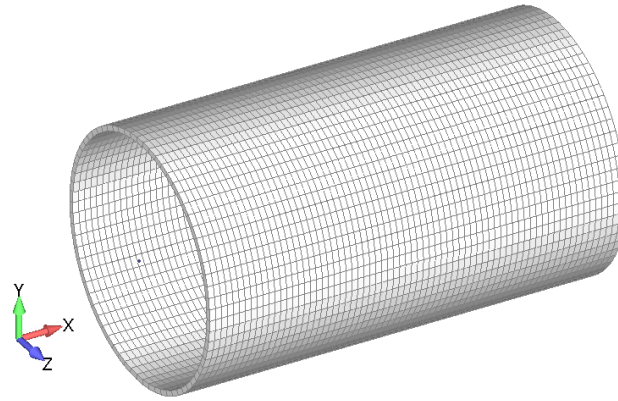

Figure 3: Cylinder: Finite Element Model

excitation covered a relatively large frequency broadband: from 50 Hz to 1200 Hz.

Two different frequencies are shown in Fig. 4; in Fig. 4a and 4b the normal displacement fields are shown. These displacements are used both in the FFT and IWC method, in order to obtain the wavenumber domain; the k -space plots at these two different frequencies are shown in Fig. 4c and 4d, respectively. In these two figures, a perfect agreement in the peaks estimation is obtained between the two methods. At each heading angle of the inhomogeneous wave, the IWC method estimated the same value of (k_x, k_y) obtained with the FFT, predicting the classical ring shape expected for the isotropic panel.

3.2 Curved panel

In this section, the previous methods are applied on a curved panel. The employed material is a common alloy ($E = 70.0 \times 10^9$ Pa, $\nu = 0.33$ and $\rho = 2700.0$ kg/m³) and the geometric properties are: $L_x = 1.0$ m, $R = 0.5$ m and $t = 0.002$ m. The FE model of the curved panel is shown in Fig. 2. The FE model of the structure is assembled in a commercial FE software and the dynamic analysis is computed using an *in-home* algorithm developed in MATLAB. The excitation is punctual and located in the middle of the structure, normal to the inner surface; this location has been selected in order to excite many natural modes as possible. The forced responses and the wavenumber domain at two different frequencies are shown in Fig. 6. The transversal displacement field is obtained by projecting the displacement at each point from the global reference system of the structure into the local one; the *out-of-plane* displacements are shown in Fig. 6a and 6b, for the two considered frequencies.

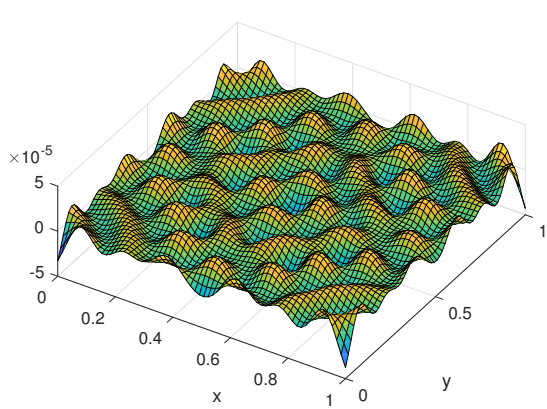

(a) 3D displacement field at 500.0 Hz.

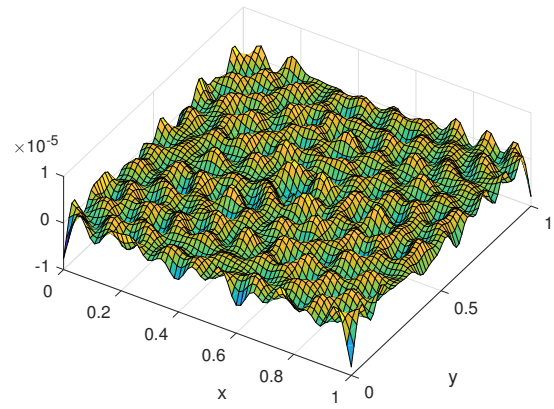

(b) 3D displacement field at 1100.0 Hz.

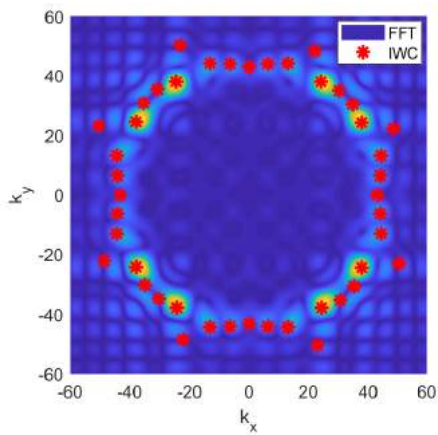

(c) Comparison FFT-IWC at 500.0 Hz.

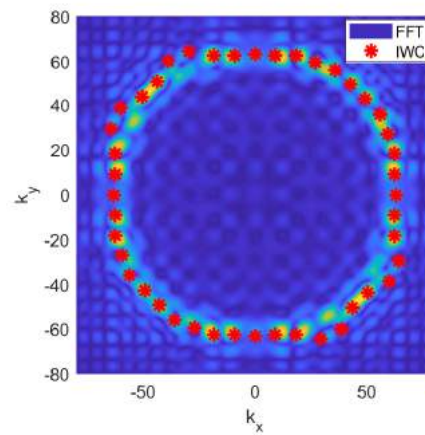

(d) Comparison FFT-IWC at 1100.0 Hz.

Figure 4: Flat panel: displacement field and wavenumber estimation at two different frequencies

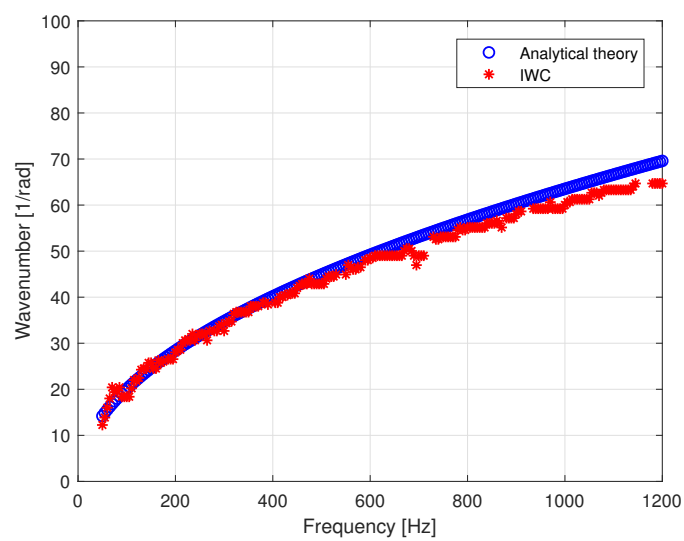
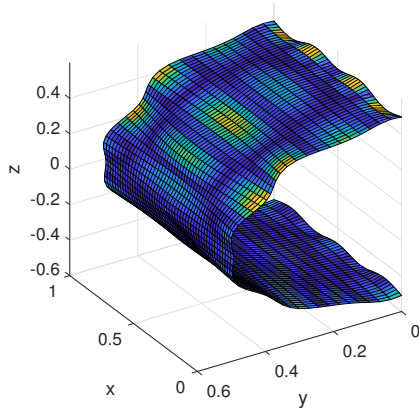
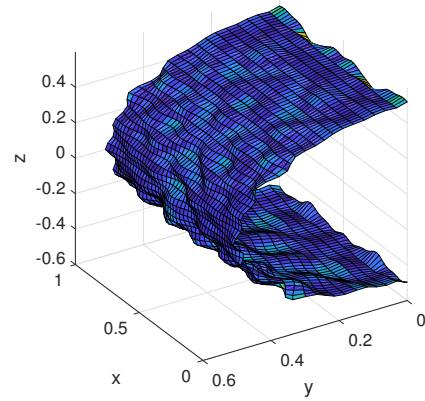

Figure 5: Flat panel: bending dispersion curve



(a) 3D displacement field at 250.0 Hz.



(b) 3D displacement field at 1350.0 Hz.

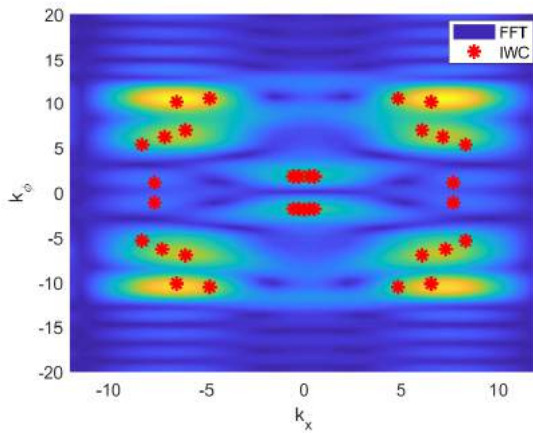

(c) Comparison FFT-IWC at 250.0 Hz.

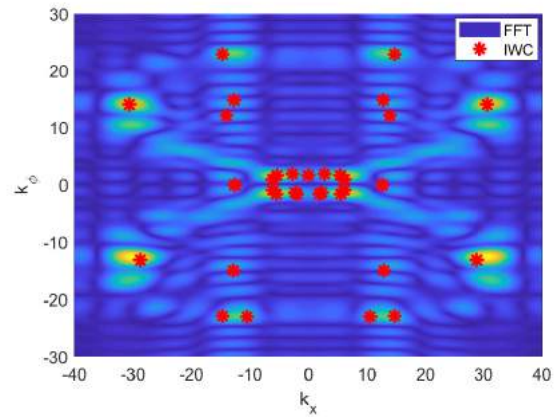

(d) Comparison FFT-IWC at 1350.0 Hz.

Figure 6: Curved panel: displacement field and wavenumber estimation at two different frequencies

3.3 Cylindrical shell

The last structure that has been investigated is a cylindrical shell. The cylinder is made of a classical isotropic alloy ($E = 70.0 \times 10^9$ Pa, $\nu = 0.33$ and $\rho = 2700.0$ kg/m³) and the geometric properties are: $L_x = 1.2$ m, $R = 0.35$ m and $t = 0.0147$ m. The FE model of the cylinder is shown in Fig. 3. The FE model of the cylinder is built same as in the previous sections. The full displacement field is obtained implementing the WFEM. The harmonic excitation is located on the inner surface of the cylinder, locally normal to the surface and oriented along the radial direction. The normal displacement field and the wavenumber domain at two different frequencies are shown in Fig. 7. The normal displacement field is obtained by projecting the displacement of each node in the local reference system.

4 Conclusions

This paper compares two wavenumber identification techniques mainly devoted to the measurement of the dispersion of the bending waves in different structures. The IWC method shows a good agreement with the classical FFT approach and with the Kirchoff-Love theory in the estimation of the k -space and of the flexural dispersion curve.

The IWC method is also applied to curved and axial-symmetric structures, showing a good agreement with

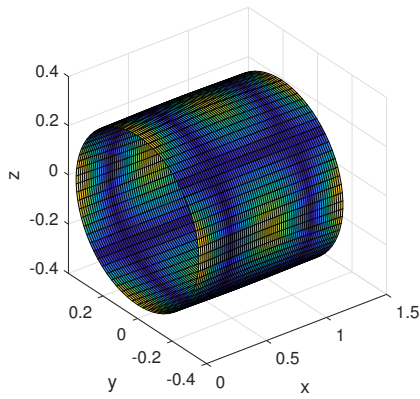

(a) 3D displacement field at 735.0 Hz.

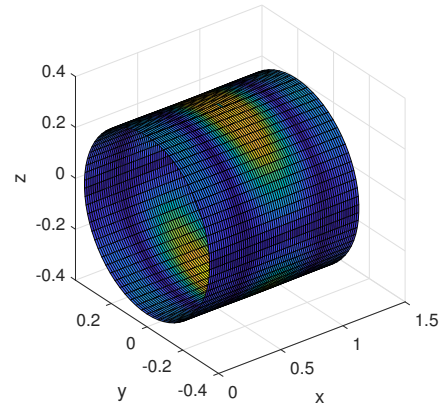

(b) 3D displacement field at 4100.0 Hz.

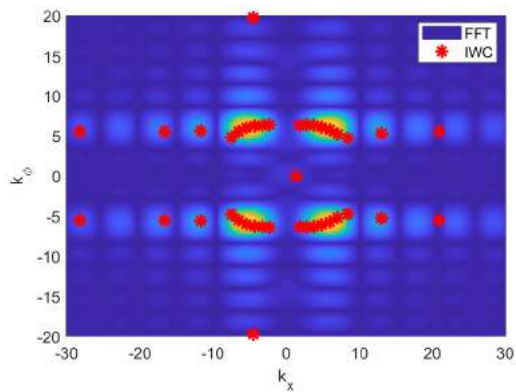

(c) Comparison FFT-IWC at 735.0 Hz.

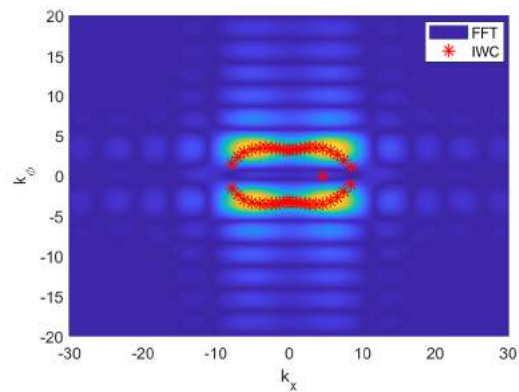

(d) Comparison FFT-IWC at 4100.0 Hz.

Figure 7: Cylinder: displacement field and wavenumber estimation at two different frequencies

the classical FFT approach, predicting the complex wavenumber at a fixed frequency and identifying the complete θ -dependent dispersion curve; the classical δ -shape is also well identified, with a good estimation of the maxima in the wavenumber domain at different heading angles of the inhomogeneous wave. In the IWC algorithm, the introduction of the attenuation coefficient γ (with the associated damping loss factor coefficient) offers the possibility to separate near-field from far-field, reducing the effect of the finite size of the structures; the algorithm allows to identify and remove the wavenumbers with the imaginary part greater than the real part, which are associated to the near-field propagation and exhibiting a high apparent loss factor.

Acknowledgments

This project has received funding from the European Union Horizon 2020 research and innovation programme under the Marie Skłodowska-Curie grant agreement No. 675441.

References

- [1] F.J. Fahy, E. Lindqvist, *Wave propagation in damped, stiffened structures characteristic of ship construction*, Journal of Sound and Vibration, Vol. 45, No. 1, (1976), pp. 115-138.

- [2] A.W. Leissa, *Vibration of Shells*, Scientific and Technical Information Office, National Aeronautics and Space Administration, Ohio (1973).
- [3] M. Qatu, *Vibration of Laminated Shells and Plates*, Academic Press, Oakland University, MI, USA (2004).
- [4] R.H. Lyon, *Statistical Energy Analysis of Dynamical Systems: Theory and Applications*, MIT Press, Cambridge (1975).
- [5] V. Cotoni, R.S. Langley, P.J. Shorter, *A statistical energy analysis subsystem formulation using finite element and periodic structure theory*, Journal of Sound and Vibration, Vol. 318, No. 4-5, (2008), pp. 1077-1108.
- [6] D. Chronopoulos, M. Ichchou, B. Troclet, O. Bareille, *Predicting the broadband response of a layered cone-cylinder-cone shell*, Composite Structures, Vol. 107, (2014), pp. 149-159.
- [7] J. McDaniel, P. Dupont, L. Savino, *A wave approach to estimating frequency-dependent damping under transient loading*, Journal of Sound and Vibration, Vol. 231, No. 2, (2000), pp. 433-449.
- [8] N. Ferguson, B. Mace, C.R. Halkyard, K. Henon, *The estimation of wavenumbers in two dimensional structures*, Proceedings of ISMA, International Conference on Noise and Vibration Engineering, Leuven, Belgium, 2002 September 16-18, Leuven (2002), Vol. II, pp. 799-806.
- [9] K. Grosh, E.G. Williams, *Complex wave-number decomposition of structural vibrations*, The Journal of the Acoustical Society of America, Vol. 93, No. 2, (1993), p. 836-848.
- [10] J. Berthaut, M. Ichchou, L. Jezequel, *K-space identification of apparent structural behavior*, Journal of Sound and Vibration, Vol. 280, (2005), p. 1125-1131.
- [11] M. Ichchou, J. Berthaut, M. Collet, *Multi-mode wave propagation in ribbed plates: Part I, wavenumber-space characteristics*, International Journal of Solids and Structures, Vol. 45, No. 5, (2008), p. 1179-1195.
- [12] M. Ichchou, J. Berthaut, M. Collet, *Multi-mode wave propagation in ribbed plates. Part II: predictions and comparisons*, International Journal of Solids and Structures, Vol. 45, No. 5, (2008), p. 1196-1216.
- [13] M. Ichchou, O. Bareille, J. Berthaut, *Identification of effective sandwich structural properties via an inverse wave approach*, Engineering Structures, Vol. 30, (2008), p. 2591-2604.
- [14] R. Cherif, J.-D. Chazot, N. Atalla, *Damping loss factor estimation of two-dimensional orthotropic structures from a displacement field measurement*, Journal of Sound and Vibration, Vol. 356, (2015), p. 61-71.
- [15] C. Droz, O. Bareille, M. Ichchou, *A new procedure for the determination of structural characteristics of sandwich plates in medium frequencies*, Composites Part B: Engineering, Vol. 112, (2017), p. 103-111.
- [16] L. Van Belle, C. Claeys, E. Deckers, W. Desmet, *On the impact of damping on the dispersion curves of a locally resonant metamaterial: Modelling and experimental*, Journal of Sound and Vibration, Vol. 409, (2017), p. 1-23.
- [17] B. Van Damme, A. Zemp, *Measuring dispersion curves for bending waves in beams: A comparison of Spatial Fourier Transform and Inhomogeneous Wave Correlation*, Acta Acustica united with Acustica, Vol. 104, No. 2, (2018), p. 228-234.
- [18] D.J. Mead, *Wave propagation in continuous periodic structures: research contributions from Southampton*, Journal of Sound and Vibration, Vol. 190, No. 3, (1996), p. 495-524.

- [19] E. Manconi, B.R. Mace, *Modelling wave propagation in two dimensional structures using finite element analysis*, Journal of Sound and Vibration, Vol. 318, No. 45, (2008), p. 884-902.
- [20] J.M. Renno, B.R. Mace, *Calculating the forced response of cylinders using the wave and finite element method*, Journal of Sound and Vibration, Vol. 333, No. 21, (2014), p. 5340-5355.
- [21] C. Droz, J.P. Lainé, M. Ichchou, G. Inquiété, *A reduced formulation for the free-wave propagation analysis in composite structures*, Composite Structures, Vol. 113, (2017), p. 134-144.
- [22] F. Errico, M. Ichchou, S. De Rosa, O. Bareille, F. Franco, *The modelling of the flow-induced vibrations of periodic flat and axial-symmetric structures with a wave-based method*, Journal of Sound and Vibration, Vol. 424, (2018), p. 32-47.