

Walls in notched ferromagnetic nanowires

Gilles Carbou

Université de Pau et des Pays de l'Adour
Laboratoire de Mathématiques et de leurs Applications,
UMR CNRS 5142

Joint works with David Sanchez (INSA-Toulouse)

**Onzième Rencontre d'Analyse Mathématique et Applications RAMA11
21-24 novembre 2019 — Sidi Bel Abbès**

- 1 Physical Context
- 2 1d Model for ferromagnetic nanowires
- 3 Walls in constant-section wire
- 4 Wall configurations for infinite nanowire with one notch
- 5 Wire with several notches
- 6 Applied Magnetic Field and Electric Current Effects

Ferromagnetic materials

Properties

- Spontaneous magnetization
- Magnetic field generated by the magnetization
- Formation of domains and domain walls

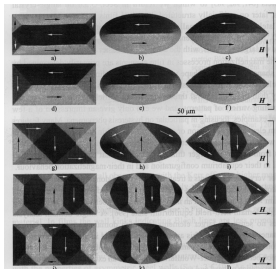
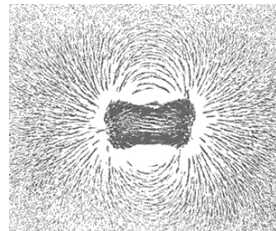

A. Aharoni, Introduction to the Theory of Ferromagnetism, Oxford University Press, 1996

Industrial Applications

- Electromagnets
- Transformers
- Radar absorbing paints
- Mobile phones
- Modern Recording Devices

Data storage in ferromagnetic nanowires

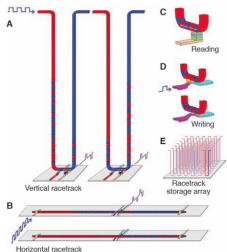

S. Parkin, M. Hayashi, L. Thomas, *Magnetic Domain-Wall Racetrack Memory*, *Science* **320** (2008)

- Bits encoded by the direction of the magnetization
- Stabilization of walls positions by notches

Stuart S. P. Parkin, Masamitsu Hayashi, Luc Thomas, *Magnetic Domain-Wall Racetrack Memory*, *Science* **320** (2008)

- 3d devices for the storage of numerical data
- Fast access

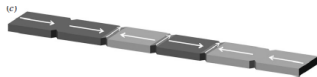

G. Hrkac, J. Dean and D. A. Allwood, *Nanowire spintronics for storage class memories and logic*, *Phil. Trans. R. Soc. A* (2011) **369**

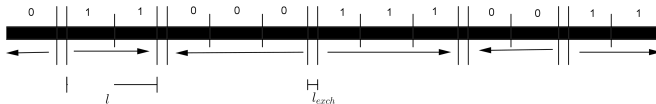

For data storage :

- DW seems to be pinned in the notches (reliability of the storage)
- DW depinning by magnetic field : data recording
- DW depinning by application of an electric current : data reading

Goals

- Obtention and justification of equivalent simpler 1d-models for nanowires
- Description of walls configurations and walls dynamics
- Effects of notches on walls stability
- DW depinning

For data storage :

- DW seems to be pinned in the notches (reliability of the storage)
- DW depinning by magnetic field : data recording
- DW depinning by application of an electric current : data reading

Goals

- Obtention and justification of equivalent simpler 1d-models for nanowires
- Description of walls configurations and walls dynamics
- Effects of notches on walls stability
- DW depinning

- 1 Physical Context
- 2 1d Model for ferromagnetic nanowires**
- 3 Walls in constant-section wire
- 4 Wall configurations for infinite nanowire with one notch
- 5 Wire with several notches
- 6 Applied Magnetic Field and Electric Current Effects

Magnetic Moment

- Magnetic domain : $\Omega \subset \mathbb{R}^3$
- Magnetization described by the magnetic moment $m : \mathbb{R}_t^+ \times \Omega_x \rightarrow \mathbb{R}^3$

$$|m(t, x)| = 1 \text{ p. p.}$$

- Constitutive Relation : $B = H + m$

Landau-Lifschitz Equation

$$\frac{\partial m}{\partial t} = -m \times \mathcal{H} - m \times (m \times \mathcal{H})$$

$$\mathcal{H} = -\partial_m \mathcal{E}(m) = A \Delta m + h_d(m) + \psi(m) + H_a$$

$$\mathcal{E}(m) = \frac{A}{2} \int_{\Omega} |\nabla m|^2 + \frac{1}{2} \int_{\mathbb{R}^3} |h_d(m)|^2 + \int_{\Omega} \Psi(m) - \int_{\Omega} m \cdot H_a$$

$$\text{curl } h_d(m) = 0, \quad \text{div } (h_d(m) + \bar{m}) = 0$$

Magnetic Moment

- Magnetic domain : $\Omega \subset \mathbb{R}^3$
- Magnetization described by the magnetic moment $m : \mathbb{R}_t^+ \times \Omega_x \rightarrow \mathbb{R}^3$

$$|m(t, x)| = 1 \text{ p. p.}$$

- Constitutive Relation : $B = H + m$

Landau-Lifschitz Equation

$$\frac{\partial m}{\partial t} = -m \times \mathcal{H} - m \times (m \times \mathcal{H})$$

$$\mathcal{H} = -\partial_m \mathcal{E}(m) = A \Delta m + h_d(m) + \psi(m) + H_a$$

$$\mathcal{E}(m) = \frac{A}{2} \int_{\Omega} |\nabla m|^2 + \frac{1}{2} \int_{\mathbb{R}^3} |h_d(m)|^2 + \int_{\Omega} \Psi(m) - \int_{\Omega} m \cdot H_a$$

$$\text{curl } h_d(m) = 0, \quad \text{div } (h_d(m) + \bar{m}) = 0$$

Magnetic Moment

- Magnetic domain : $\Omega \subset \mathbb{R}^3$
- Magnetization described by the magnetic moment $m : \mathbb{R}_t^+ \times \Omega_x \rightarrow \mathbb{R}^3$

$$|m(t, x)| = 1 \text{ p. p.}$$

- Constitutive Relation : $B = H + m$

Landau-Lifschitz Equation

$$\frac{\partial m}{\partial t} = -m \times \mathcal{H} - m \times (m \times \mathcal{H})$$

$$\mathcal{H} = -\partial_m \mathcal{E}(m) = A \Delta m + h_d(m) + \psi(m) + H_a$$

$$\mathcal{E}(m) = \frac{A}{2} \int_{\Omega} |\nabla m|^2 + \frac{1}{2} \int_{\mathbb{R}^3} |h_d(m)|^2 + \int_{\Omega} \Psi(m) - \int_{\Omega} m \cdot H_a$$

$$\text{curl } h_d(m) = 0, \quad \text{div } (h_d(m) + \bar{m}) = 0$$

Magnetic Moment

- Magnetic domain : $\Omega \subset \mathbb{R}^3$
- Magnetization described by the magnetic moment $m : \mathbb{R}_t^+ \times \Omega_x \rightarrow \mathbb{R}^3$

$$|m(t, x)| = 1 \text{ p. p.}$$

- Constitutive Relation : $B = H + m$

Landau-Lifschitz Equation

$$\frac{\partial m}{\partial t} = -m \times \mathcal{H} - m \times (m \times \mathcal{H})$$

$$\mathcal{H} = -\partial_m \mathcal{E}(m) = A \Delta m + h_d(m) + \psi(m) + H_a$$

$$\mathcal{E}(m) = \frac{A}{2} \int_{\Omega} |\nabla m|^2 + \frac{1}{2} \int_{\mathbb{R}^3} |h_d(m)|^2 + \int_{\Omega} \Psi(m) - \int_{\Omega} m \cdot H_a$$

$$\text{Uniaxial Anisotropy : } \Psi(m) = -\frac{1}{2} (m \cdot \xi)^2 \text{ and } \psi(m) = -\partial_m \Psi = (m \cdot \xi) \xi$$

Magnetic Moment

- Magnetic domain : $\Omega \subset \mathbb{R}^3$
- Magnetization described by the magnetic moment $m : \mathbb{R}_t^+ \times \Omega_x \rightarrow \mathbb{R}^3$

$$|m(t, x)| = 1 \text{ p. p.}$$

- Constitutive Relation : $B = H + m$

Landau-Lifschitz Equation

$$\frac{\partial m}{\partial t} = -m \times \mathcal{H} - m \times (m \times \mathcal{H})$$

$$\mathcal{H} = -\partial_m \mathcal{E}(m) = A \Delta m + h_d(m) + \psi(m) + H_a$$

$$\mathcal{E}(m) = \frac{A}{2} \int_{\Omega} |\nabla m|^2 + \frac{1}{2} \int_{\mathbb{R}^3} |h_d(m)|^2 + \int_{\Omega} \Psi(m) - \int_{\Omega} m \cdot H_a$$

Applied magnetic field : H_a

Magnetic Moment

- Magnetic domain : $\Omega \subset \mathbb{R}^3$
- Magnetization described by the magnetic moment $m : \mathbb{R}_t^+ \times \Omega_x \rightarrow \mathbb{R}^3$

$$|m(t, x)| = 1 \text{ p. p.}$$

- Constitutive Relation : $B = H + m$

Landau-Lifschitz-Gilberg Equation

$$\frac{\partial m}{\partial t} - m \times \frac{\partial m}{\partial t} = -2m \times \mathcal{H}$$

$$\mathcal{H} = -\partial_m \mathcal{E}(m) = A\Delta m + h_d(m) + \psi(m) + H_a$$

$$\mathcal{E}(m) = \frac{A}{2} \int_{\Omega} |\nabla m|^2 + \frac{1}{2} \int_{\mathbb{R}^3} |h_d(m)|^2 + \int_{\Omega} \Psi(m) - \int_{\Omega} m \cdot H_a$$

1d model of wire with non constant cross section



$$\Omega_\eta = \{(x_1, x_2, x_3), x_1 \in \mathbf{I}, (x_2)^2 + (x_3)^2 < \eta^2(\rho(x_1))^2\}$$

Weak Formulation :

$$\int_{[0, T] \times \Omega_\eta} \left(\frac{\partial m}{\partial t} - m \times \frac{\partial m}{\partial t} \right) \cdot \Psi = 2 \int_{[0, T] \times \Omega_\eta} \sum_{i=1}^3 m \times A \frac{\partial m}{\partial x_i} \cdot \frac{\partial \Psi}{\partial x_i} - 2 \int_{[0, T] \times \Omega_\eta} m \times H_d(m) \cdot \Psi.$$

- rescaling : fix domaine $\Omega_1 = \{(x_1, \tilde{x}_2, \tilde{x}_3), x \in \mathbf{I}, (\tilde{x}_2)^2 + (\tilde{x}_3)^2 < (\rho(x_1))^2\}$
- $\eta \rightarrow 0$ in the weak formulation with $\Psi(t, x_1, \tilde{x}_2, \tilde{x}_3) = \varphi(t, x_1)$

Radius of the cross section : ρ

- $\rho : \mathbf{I} \rightarrow \mathbb{R}^{*+}, \mathcal{C}^\infty,$
- $0 < \rho_{min} \leq \rho(x_1) \leq 1$
- $\mathbf{s}(x_1) = \pi(\rho(x_1))^2$

1d model of wire with non constant cross section

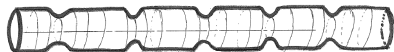

$$\Omega_\eta = \{(x_1, x_2, x_3), x_1 \in \mathbf{I}, (x_2)^2 + (x_3)^2 < \eta^2(\rho(x_1))^2\}$$

Weak Formulation :

$$\int_{[0, T] \times \Omega_\eta} \left(\frac{\partial m}{\partial t} - m \times \frac{\partial m}{\partial t} \right) \cdot \Psi = 2 \int_{[0, T] \times \Omega_\eta} \sum_{i=1}^3 m \times A \frac{\partial m}{\partial x_i} \cdot \frac{\partial \Psi}{\partial x_i} - 2 \int_{[0, T] \times \Omega_\eta} m \times H_d(m) \cdot \Psi.$$

- rescaling : fix domaine $\Omega_1 = \{(x_1, \tilde{x}_2, \tilde{x}_3), x \in \mathbf{I}, (\tilde{x}_2)^2 + (\tilde{x}_3)^2 < (\rho(x_1))^2\}$
- $\eta \rightarrow 0$ in the weak formulation with $\Psi(t, x_1, \tilde{x}_2, \tilde{x}_3) = \varphi(t, x_1)$

Radius of the cross section : ρ

- $\rho : \mathbf{I} \rightarrow \mathbb{R}^{*+}, \mathcal{C}^\infty,$
- $0 < \rho_{min} \leq \rho(x_1) \leq 1$
- $\mathbf{s}(x_1) = \pi(\rho(x_1))^2$

1d model of wire with non constant cross section

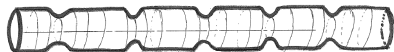

$$\Omega_\eta = \{(x_1, x_2, x_3), x_1 \in \mathbf{I}, (x_2)^2 + (x_3)^2 < \eta^2(\rho(x_1))^2\}$$

$$m : \mathbb{R}_t^+ \times \mathbf{I}_x \rightarrow \mathbb{S}^2,$$

m is constant in the cross-section

$$\int_{[0, T] \times \mathbf{I}} \mathbf{s}(x) \left(\frac{\partial m}{\partial t} - m \times \frac{\partial m}{\partial t} \right) \varphi = 2 \int_{[0, T] \times \mathbf{I}} \mathbf{s}(x) m \times A \frac{\partial m}{\partial x} \cdot \frac{\partial \varphi}{\partial x} - 2 \int_{[0, T] \times \Omega_\eta} \mathbf{s}(x) m \times \frac{1}{2} (m_2 \mathbf{e}_2 + m_3 \mathbf{e}_3) \cdot \varphi.$$

$$\mathbf{s}(x) \frac{\partial m}{\partial t} = -m \times H_{\text{eff}} - m \times (m \times H_{\text{eff}})$$

$$H_{\text{eff}} = A \partial_x (\mathbf{s}(x) \partial_x m) - \frac{\mathbf{s}(x)}{2} (m_2 \vec{\mathbf{e}}_2 + m_3 \vec{\mathbf{e}}_3)$$

Radius of the cross section : ρ

- $\rho : \mathbf{I} \rightarrow \mathbb{R}^{*+}, \mathcal{C}^\infty,$
- $0 < \rho_{\min} \leq \rho(x_1) \leq 1$
- $\mathbf{s}(x_1) = \pi(\rho(x_1))^2$

1d model of wire with non constant cross section

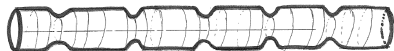

$$\Omega_\eta = \{(x_1, x_2, x_3), x_1 \in \mathbf{I}, (x_2)^2 + (x_3)^2 < \eta^2(\rho(x_1))^2\}$$

Radius of the cross section : ρ

- $\rho : \mathbf{I} \rightarrow \mathbb{R}^{*+}, \mathcal{C}^\infty,$
- $0 < \rho_{min} \leq \rho(x_1) \leq 1$
- $\mathbf{s}(x_1) = \pi(\rho(x_1))^2$

Model of pinched wire

$$\frac{\partial m}{\partial t} = -m \times \mathcal{H}_{eff} - m \times (m \times \mathcal{H}_{eff})$$
$$\mathcal{H}_{eff} = A \partial_{xx} m + A \frac{\mathbf{s}'}{\mathbf{s}} \partial_x m - \frac{1}{2} (m_2 \vec{e}_2 + m_3 \vec{e}_3)$$

1d Ferromagnetism Energy

$$E(m) = \frac{A}{2} \int_{\mathbf{I}} \mathbf{s}(x) |\partial_x m|^2 dx + \frac{1}{4} \int_{\mathbf{I}} \mathbf{s}(x) (|m_2|^2 + |m_3|^2) dx$$

- 1 Physical Context
- 2 1d Model for ferromagnetic nanowires
- 3 Walls in constant-section wire**
- 4 Wall configurations for infinite nanowire with one notch
- 5 Wire with several notches
- 6 Applied Magnetic Field and Electric Current Effects

Model of Nanowire

$$m : \mathbb{R}_t^+ \times I_x \rightarrow \mathcal{S}^2, I = \mathbb{R} \text{ or } I = [-L, L]$$

$$\frac{\partial m}{\partial t} = -m \times H_{\text{eff}} - m \times (m \times H_{\text{eff}})$$

$$H_{\text{eff}} = m_{xx} - (m_2 \vec{e}_2 + m_3 \vec{e}_3)$$

$$m_x(-L) = m_x(L) = 0$$

- φ is constant
- $\theta'' + \cos \theta \sin \theta = 0$
- $\theta \rightarrow \pm\pi/2$ when $x \rightarrow \pm\infty$ or $\theta'(-L) = \theta'(L) = 0$

Static Solutions : Walls

$$\bullet M(x) = R_{\varphi(x)} \begin{pmatrix} \sin \theta(x) \\ \cos \theta(x) \\ 0 \end{pmatrix}$$

$$R_{\varphi} = \begin{pmatrix} 1 & 0 & 0 \\ 0 & \cos \varphi & -\sin \varphi \\ 0 & \sin \varphi & \cos \varphi \end{pmatrix}$$

- BC : $\theta \rightarrow \pm\pi/2$ when $x \rightarrow \pm\infty$
 $\theta'(-L) = \theta'(L) = 0$

Model of Nanowire

$$m : \mathbb{R}_t^+ \times I_x \rightarrow \mathcal{S}^2, I = \mathbb{R} \text{ or } I = [-L, L]$$

$$\frac{\partial m}{\partial t} = -m \times H_{\text{eff}} - m \times (m \times H_{\text{eff}})$$

$$H_{\text{eff}} = m_{xx} - (m_2 \vec{e}_2 + m_3 \vec{e}_3)$$

$$m_x(-L) = m_x(L) = 0$$

- φ is constant
- $\theta'' + \cos \theta \sin \theta = 0$
- $\theta \rightarrow \pm\pi/2$ when $x \rightarrow \pm\infty$ or $\theta'(-L) = \theta'(L) = 0$

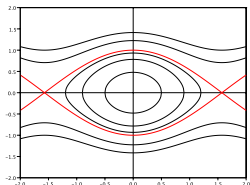

Static Solutions : Walls

$$M(x) = R_{\varphi(x)} \begin{pmatrix} \sin \theta(x) \\ \cos \theta(x) \\ 0 \end{pmatrix}$$

$$R_{\varphi} = \begin{pmatrix} 1 & 0 & 0 \\ 0 & \cos \varphi & -\sin \varphi \\ 0 & \sin \varphi & \cos \varphi \end{pmatrix}$$

- BC : $\theta \rightarrow \pm\pi/2$ when $x \rightarrow \pm\infty$
- $\theta'(-L) = \theta'(L) = 0$

Model of Nanowire

$$m : \mathbb{R}_t^+ \times \mathbb{R}_x \rightarrow \mathcal{S}^2,$$

$$\frac{\partial m}{\partial t} = m \times H_{\text{eff}} - m \times (m \times H_{\text{eff}})$$

$$H_{\text{eff}} = m_{xx} - (m_2 \vec{e}_2 + m_3 \vec{e}_3)$$

Static Solution

$$M_0(x) = \begin{pmatrix} \tanh x \\ \frac{1}{\cosh x} \\ 0 \end{pmatrix}$$

G. Carbou, S. Labbé, *Stability for Static wall in a ferromagnetic Nanowire*, Discrete Contin. Dyn. Syst. Ser. B 6 (2006)

Stability of the constant profiles but not asymptotic stability

$$m(t, x) \rightarrow R_{\varphi_\infty} M_0(x - \sigma_\infty) \text{ when } t \rightarrow \infty$$

G. Carbou, S. Labbé, E. Trélat, *Control of travelling walls in a ferromagnetic nanowire*, Discrete Contin. Dyn. Syst. Ser. S 1 (2008), no. 1, 51–59

Controlability of the wall position by the mean of the applied field

Model of Nanowire

$$m : \mathbb{R}_t^+ \times \mathbb{R}_x \rightarrow \mathcal{S}^2,$$

$$\frac{\partial m}{\partial t} = m \times H_{\text{eff}} - m \times (m \times H_{\text{eff}})$$

$$H_{\text{eff}} = m_{xx} - (m_2 \vec{e}_2 + m_3 \vec{e}_3)$$

Static Solution

$$M_0(x) = \begin{pmatrix} \tanh x \\ \frac{1}{\cosh x} \\ 0 \end{pmatrix}$$

G. Carbou, S. Labbé, *Stability for Static wall in a ferromagnetic Nanowire*, Discrete Contin. Dyn. Syst. Ser. B 6 (2006)

Stability of the constant profiles but not asymptotic stability

$$m(t, x) \rightarrow R_{\varphi_\infty} M_0(x - \sigma_\infty) \text{ when } t \rightarrow \infty$$

G. Carbou, S. Labbé, E. Trélat, *Control of travelling walls in a ferromagnetic nanowire*, Discrete Contin. Dyn. Syst. Ser. S 1 (2008), no. 1, 51–59

Controlability of the wall position by the mean of the applied field

Model of Nanowire

$$m : \mathbb{R}_t^+ \times [-L, L]_x \rightarrow S^2$$

$$\frac{\partial m}{\partial t} = m \times H_{\text{eff}} - m \times (m \times H_{\text{eff}})$$

$$H_{\text{eff}} = m_{xx} - (m_2 \vec{e}_2 + m_3 \vec{e}_3)$$

$$m'(-L) = m'(L) = 0$$

Static Solution

$$M_0(x) = \begin{pmatrix} \sin \theta(x) \\ \cos \theta(x) \\ 0 \end{pmatrix}, \quad \begin{aligned} \theta'' + \cos \theta \sin \theta &= 0, \\ \theta'(-L) &= \theta'(L) = 0 \end{aligned}$$

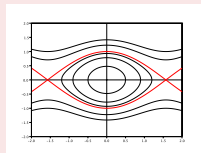

G. Carbou, S. Labbé, *Stabilization of walls for nano-wires of finite length*, ESAIM Control Optim. Calc. Var. 18 (2012)

- One wall in a finite wire : centered in the middle of the wire
- This solution is unstable

Model of Nanowire

$$m : \mathbb{R}_t^+ \times [-L, L]_x \rightarrow S^2$$

$$\frac{\partial m}{\partial t} = m \times H_{\text{eff}} - m \times (m \times H_{\text{eff}})$$

$$H_{\text{eff}} = m_{xx} - (m_2 \vec{e}_2 + m_3 \vec{e}_3)$$

$$m'(-L) = m'(L) = 0$$

Static Solution

$$M_0(x) = \begin{pmatrix} \sin \theta(x) \\ \cos \theta(x) \\ 0 \end{pmatrix}, \quad \begin{aligned} \theta'' + \cos \theta \sin \theta &= 0, \\ \theta'(-L) &= \theta'(L) = 0 \end{aligned}$$

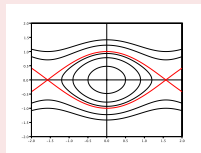

G. Carbou, S. Labbé, *Stabilization of walls for nano-wires of finite length*, ESAIM Control Optim. Calc. Var. 18 (2012)

- One wall in a finite wire : centered in the middle of the wire
- This solution is unstable

The position of walls is unstable or non asymptotically stable



The data storage is not reliable

Stabilization by Notches

The position of walls is unstable or non asymptotically stable



The data storage is not reliable

Stabilization by Notches

The position of walls is unstable or non asymptotically stable



The data storage is not reliable

Stabilization by Notches

- 1 Physical Context
- 2 1d Model for ferromagnetic nanowires
- 3 Walls in constant-section wire
- 4 Wall configurations for infinite nanowire with one notch**
- 5 Wire with several notches
- 6 Applied Magnetic Field and Electric Current Effects

Model of infinite wire with one notch

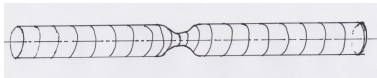

$$\Omega_\eta = \{(x, y, z), x \in \mathbb{R}, y^2 + z^2 < \eta^2(\rho(x))^2\}$$

Radius of the section : ρ

- $\rho : \mathbb{R} \rightarrow \mathbb{R}^+, C^\infty$,
- $\rho = 1$ outside $[-a, a]$,
- $\rho(-x) = \rho(x)$,
- ρ non decreasing on $[0, a]$
- $\mathbf{s}(x) = \pi(\rho(x))^2$

Model of infinite wire with notch

$$m : \mathbb{R}_t^+ \times \mathbb{R}_x \rightarrow \mathcal{S}^2$$

$$\frac{\partial m}{\partial t} = -m \times \mathcal{H}_{\text{eff}} - m \times (m \times \mathcal{H}_{\text{eff}})$$

$$\mathcal{H}_{\text{eff}} = A \partial_{xx} m + A \frac{\mathbf{s}'}{\mathbf{s}} \partial_x m - \frac{1}{2} (m_2 \vec{e}_2 + m_3 \vec{e}_3)$$

$$E(m) = \frac{A}{2} \int_I \mathbf{s}(x) |\partial_x m|^2 dx + \frac{1}{4} \int_I \mathbf{s}(x) (|m_2|^2 + |m_3|^2) dx$$

Model of infinite wire with notch

$$m : \mathbb{R}_t^+ \times \mathbb{R}_x \rightarrow \mathcal{S}^2,$$

$$\frac{\partial m}{\partial t} = -m \times \mathcal{H}_{\text{eff}} - m \times (m \times \mathcal{H}_{\text{eff}})$$

$$\mathcal{H}_{\text{eff}} = \partial_{xx} m + \frac{\mathbf{s}'}{\mathbf{s}} \partial_x m - (m_2 \vec{e}_2 + m_3 \vec{e}_3)$$

Theorem (with D. Sanchez)

- Existence of a profile for one wall
- **Asymptotically stable for the position**

Existence of profiles

- $M(x) = R_{\varphi(x)} \begin{pmatrix} \sin \bar{\theta}(x) \\ \cos \bar{\theta}(x) \\ 0 \end{pmatrix}$
- $R_{\varphi} = \begin{pmatrix} 1 & 0 & 0 \\ 0 & \cos \varphi & -\sin \varphi \\ 0 & \sin \varphi & \cos \varphi \end{pmatrix}$
- $\bar{\theta} \rightarrow \pm\pi/2$ when $x \rightarrow \pm\infty$

- φ is constant
- $\bar{\theta}'' + \frac{\mathbf{s}'}{\mathbf{s}} \partial_x \bar{\theta} + \cos \bar{\theta} \sin \bar{\theta} = 0$
- $\left((\bar{\theta}')^2 - \cos^2 \bar{\theta} \right)' = -2 \frac{\mathbf{s}'}{\mathbf{s}} (\bar{\theta}')^2$

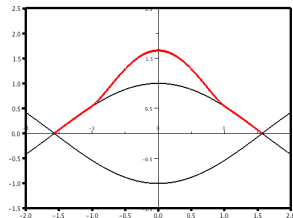
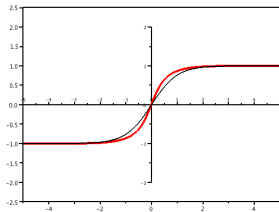

Shooting method to reach the separatrix after the notch

Existence of profiles

- $M(x) = R_{\varphi(x)} \begin{pmatrix} \sin \bar{\theta}(x) \\ \cos \bar{\theta}(x) \\ 0 \end{pmatrix}$
- $R_{\varphi} = \begin{pmatrix} 1 & 0 & 0 \\ 0 & \cos \varphi & -\sin \varphi \\ 0 & \sin \varphi & \cos \varphi \end{pmatrix}$
- $\bar{\theta} \rightarrow \pm\pi/2$ when $x \rightarrow \pm\infty$

- φ is constant
- $\bar{\theta}'' + \frac{\mathbf{s}'}{\mathbf{s}} \partial_x \bar{\theta} + \cos \bar{\theta} \sin \bar{\theta} = 0$
- $((\bar{\theta}')^2 - \cos^2 \bar{\theta})' = -2 \frac{\mathbf{s}'}{\mathbf{s}} (\bar{\theta}')^2$

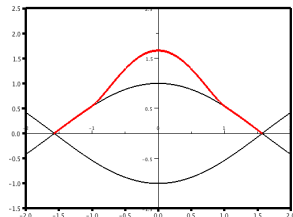
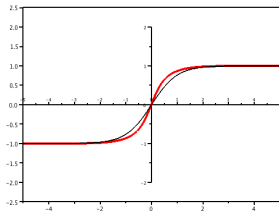

Shooting method to reach the separatrix after the notch

Infinite Nanowire with one notch

$$m : \mathbb{R}_t^+ \times \mathbb{R}_x \rightarrow \mathcal{S}^2$$

$$\frac{\partial m}{\partial t} = -m \times H_{\text{eff}} - m \times (m \times H_{\text{eff}})$$

$$\mathcal{H}_{\text{eff}} = m_{xx} + \frac{\mathbf{s}'}{\mathbf{s}} m_x - m_2 \vec{e}_2 - m_3 \vec{e}_3$$

$$m \rightarrow \pm \mathbf{e}_1 \text{ when } x \rightarrow \pm \infty$$

Wall Profile

$$M_0(x) = \begin{pmatrix} \sin \bar{\theta}(x) \\ \cos \bar{\theta}(x) \\ 0 \end{pmatrix}$$

$$\bar{\theta}'' + \frac{\mathbf{s}'}{\mathbf{s}} \bar{\theta}' + \cos \bar{\theta} \sin \bar{\theta} = 0$$

$$\text{BC} : \bar{\theta} \rightarrow \pm \pi/2 \text{ when } x \rightarrow \pm \infty$$

Stability of M_0 , asymptotic stability for the position of the wall ?

If $\|m(t=0) - M_0\|_{H^1(\mathbb{R})}$ is small, then

- for all time, $\|m(t) - M_0\|_{H^1(\mathbb{R})}$ remains small,
- $m(t)$ tends to $R_{\theta_\infty}(M_0)$ when t tends to $+\infty$.

Mobile frame

Geometrical constraint $|m| = 1$

We describe the perturbations in the mobile frame

$$m(t, x) = \sqrt{1 - |r(t, x)|^2} M_0(x) + r_1(t, x) M_1(x) + r_2(t, x) M_2$$

$$M_0(x) = \begin{pmatrix} \sin \bar{\theta}(x) \\ \cos \bar{\theta}(x) \\ 0 \end{pmatrix} \quad M_1(x) = \begin{pmatrix} -\cos \bar{\theta}(x) \\ \sin \bar{\theta}(x) \\ 0 \end{pmatrix} \quad M_2 = \begin{pmatrix} 0 \\ 0 \\ 1 \end{pmatrix}$$

New Equations for r

$$r : \mathbb{R}_t^+ \times \mathbb{R}_x \rightarrow \mathbb{R}^2$$

$$\partial_t r_1 = -L_1(r_1) - L_2(r_2) + \text{non linear}$$

$$\partial_t r_2 = L_1(r_1) - L_2(r_2) + \text{non linear}$$

$$L_1(r) = -\partial_{xx} r - \frac{s'}{s} \partial_x r + (\sin^2 \bar{\theta} - \cos^2 \bar{\theta}) r$$

$$L_2(r) = -\partial_{xx} r - \frac{s'}{s} \partial_x r + (\sin^2 \bar{\theta} - (\bar{\theta}')^2) r$$

Exact Solution

M_0 for LL ~ 0 for the new system

Stability of 0?

Geometrical constraint $|m| = 1$

We describe the perturbations in the mobile frame

$$m(t, x) = \sqrt{1 - |r(t, x)|^2} M_0(x) + r_1(t, x) M_1(x) + r_2(t, x) M_2$$

$$M_0(x) = \begin{pmatrix} \sin \bar{\theta}(x) \\ \cos \bar{\theta}(x) \\ 0 \end{pmatrix} \quad M_1(x) = \begin{pmatrix} -\cos \bar{\theta}(x) \\ \sin \bar{\theta}(x) \\ 0 \end{pmatrix} \quad M_2 = \begin{pmatrix} 0 \\ 0 \\ 1 \end{pmatrix}$$

New Equations for r

$$r : \mathbb{R}_t^+ \times \mathbb{R}_x \rightarrow \mathbb{R}^2$$

$$\partial_t r_1 = -L_1(r_1) - L_2(r_2) + \text{non linear}$$

$$\partial_t r_2 = L_1(r_1) - L_2(r_2) + \text{non linear}$$

$$L_1(r) = -\partial_{xx} r - \frac{s'}{s} \partial_x r + (\sin^2 \bar{\theta} - \cos^2 \bar{\theta}) r$$

$$L_2(r) = -\partial_{xx} r - \frac{s'}{s} \partial_x r + (\sin^2 \bar{\theta} - (\bar{\theta}')^2) r$$

Exact Solution

M_0 for LL ~ 0 for the new system

Stability of 0?

On $L^2(\mathbb{R})$, weighted scalar product :

$$\langle u | v \rangle = \int_{\mathbb{R}} \mathbf{s}(x) u(x) v(x) dx,$$

$$L_2 = -\frac{1}{\mathbf{s}} \partial_x (\mathbf{s} \partial_x) + (\sin^2 \bar{\theta} - (\bar{\theta}')^2) \implies L_2 \text{ is self-adjoint for } \langle | \rangle.$$

$$\langle L_2 u | v \rangle = \langle \ell u | \ell v \rangle, \quad \text{with } \ell = \partial_x + \bar{\theta}' \tan \bar{\theta}$$

$$L_2 \geq 0, \quad \text{Ker } L_2 = \mathbb{R}(\cos \bar{\theta})$$

- Valid whatever the configurations of the wire (several pinched zones)
- for one wall, on $(\cos \bar{\theta})^\perp$, $L_2 \geq \alpha_2 > 0$
- **Invariance by rotation** $\implies 0$ is an eigenvalue of the linearized

$$L_1 = L_2 + (\bar{\theta}')^2 - \cos^2 \bar{\theta}$$

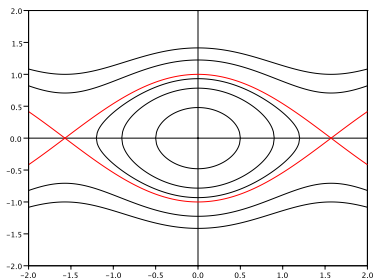

Key point : $L_1 \geq 0$?

- Infinite nanowire without pinching : $L_1 = L_2$, $L_1 \geq 0$. **Stability**
- Finite nanowire without pinching : $L_1 = L_2 - c$. **Bad sign, unstability for the position**

$$L_1 = L_2 + (\bar{\theta}')^2 - \cos^2 \bar{\theta}$$

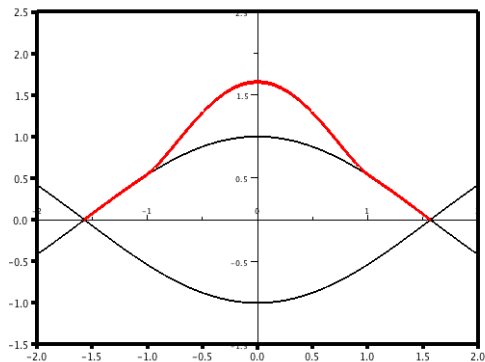

$$(\bar{\theta}')^2 - \cos^2 \bar{\theta} > 0 \text{ on Ker } L_2 \implies L_1 > 0$$

- 1 Physical Context
- 2 1d Model for ferromagnetic nanowires
- 3 Walls in constant-section wire
- 4 Wall configurations for infinite nanowire with one notch
- 5 Wire with several notches**
- 6 Applied Magnetic Field and Electric Current Effects

Elementary cell of length L

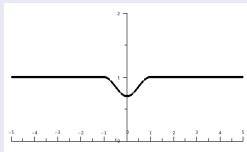

radius of the cross section : $\bar{\rho}$

- $\bar{\rho} = 1$ outside $[-a, a]$,
- $\bar{\rho}(-x) = \bar{\rho}(x)$,
- $\bar{\rho}$ non decreasing on $[0, a]$
- $\bar{\mathbf{s}}(x) = \pi(\bar{\rho}(x))^2$

Wire with $N - 1$ notches, L : distance between 2 consecutive notches

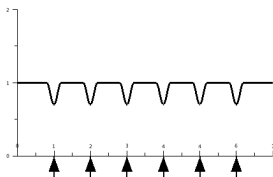

Model of wire

$$\frac{\partial m}{\partial t} = -m \times \mathcal{H}_{eff} - m \times (m \times \mathcal{H}_{eff})$$

$$\mathcal{H}_{eff} = \partial_{xx} m + \frac{\mathbf{s}'}{\mathbf{s}} \partial_x m - (m_2 \vec{e}_2 + m_3 \vec{e}_3)$$

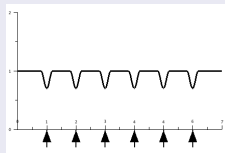

$$\mathbf{s}(x) = \begin{cases} \pi & \text{if } 0 \leq x \leq \frac{L}{2} \\ \bar{\mathbf{s}}(x - kL) & \text{if } kL - \frac{L}{2} \leq x \leq kL + \frac{L}{2} \\ \pi & \text{if } (N-1)L + \frac{L}{2} \leq x \leq NL \end{cases}$$

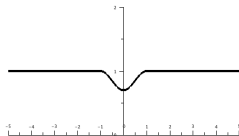

$$\mathbf{D} \in \{0, 1\}^N$$

Example 00111010

bit 0 : domain where $m \sim -e_1$

bit 1 : domain where $m \sim e_1$

Stationary solution in notched wire

$$\mathcal{F}_L(\theta) = -\partial_{xx}\theta - \frac{s'}{s}\partial_x\theta - \cos\theta \sin\theta$$

$$\mathcal{F}_L(\theta) = 0$$

$$\theta'(0) = \theta'(NL) = 0$$

$$M = \begin{pmatrix} \sin\theta \\ \cos\theta \\ 0 \end{pmatrix}$$

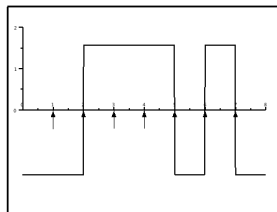

$$\mathbf{D} \in \{0, 1\}^N$$

Example 00111010

bit 0 : domain where $m \sim -e_1$

bit 1 : domain where $m \sim e_1$

Stationary solution in notched wire

$$\mathcal{F}_L(\theta) = -\partial_{xx}\theta - \frac{\mathbf{s}'}{\mathbf{s}}\partial_x\theta - \cos\theta \sin\theta$$

$$\mathcal{F}_L(\theta) = 0$$

$$\theta'(0) = \theta'(NL) = 0$$

$$M = \begin{pmatrix} \sin\theta \\ \cos\theta \\ 0 \end{pmatrix}$$

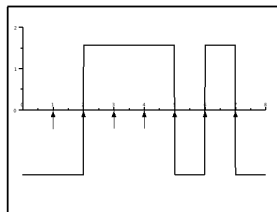

Theorem (with D. Sanchez)

For all N , for L large enough, for all data in $\{0, 1\}^N$,

- there exists a static solution encoding this data,
- this solution is asymptotically stable modulo rotation

Example 00111010

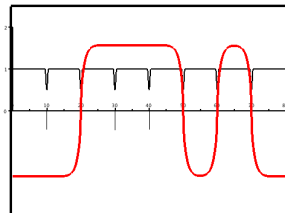
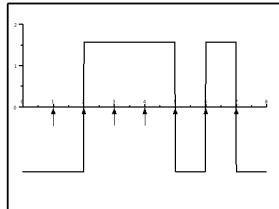

Construction of an approximate solution Θ_a^L

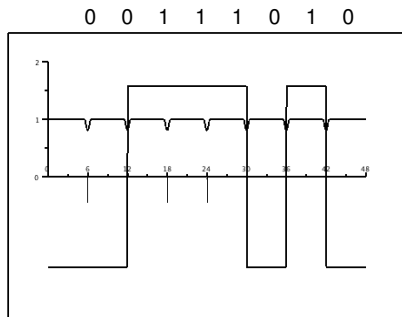

At the ends

On $[0, L/2]$, $\Theta_a^L = -\frac{\pi}{2}$

On $[NL - L/2, NL]$, $\Theta_a^L = -\frac{\pi}{2}$

Cells without magnetization switching

On $[kL - L/2, kL + L/2]$,
 $\Theta_a^L = \pm \frac{\pi}{2}$

Construction of an approximate solution Θ_a^L

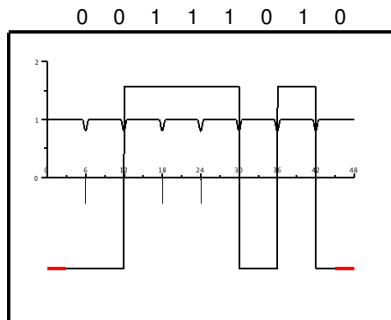

At the ends

$$\text{On } [0, L/2], \Theta_a^L = -\frac{\pi}{2}$$

$$\text{On } [NL - L/2, NL], \Theta_a^L = -\frac{\pi}{2}$$

Cells without magnetization switching

$$\text{On } [kL - L/2, kL + L/2],$$
$$\Theta_a^L = \pm \frac{\pi}{2}$$

Construction of an approximate solution Θ_a^L

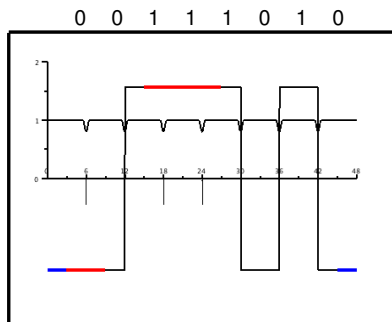

At the ends

$$\text{On } [0, L/2], \Theta_a^L = -\frac{\pi}{2}$$

$$\text{On } [NL - L/2, NL], \Theta_a^L = -\frac{\pi}{2}$$

Cells without magnetization switching

$$\text{On } [kL - L/2, kL + L/2], \\ \Theta_a^L = \pm \frac{\pi}{2}$$

Construction of an approximate solution Θ_a^L

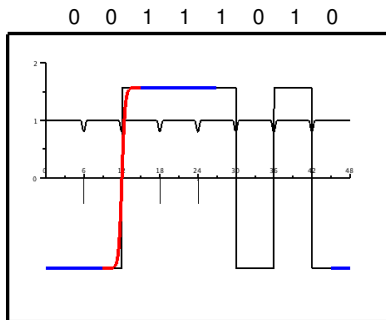

Cells with DW

$$\Theta_a^L(x) = J_L(\pm(x - kL)),$$

- $J_L(x) = \bar{\theta}(x)$ for $x \in [-L/3, L/3]$
- $J_L(x) = \pi/2$ for $x \geq L/2$
- $J_L(x) \sim \pi/2$ for $x \in [L/3, L/2]$

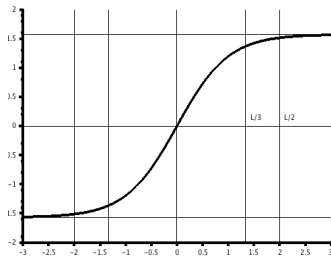

Construction of an approximate solution Θ_a^L

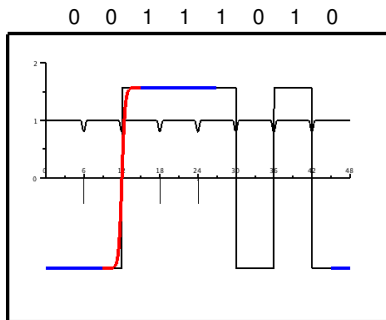

Cells with DW

$$\Theta_a^L(x) = J_L(\pm(x - kL)),$$

- $J_L(x) = \bar{\theta}(x)$ for $x \in [-L/3, L/3]$
- $J_L(x) = \pi/2$ for $x \geq L/2$
- $J_L(x) \sim \pi/2$ for $x \in [L/3, L/2]$

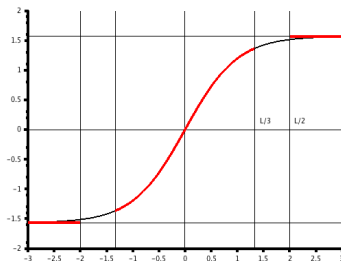

Construction of an approximate solution Θ_a^L

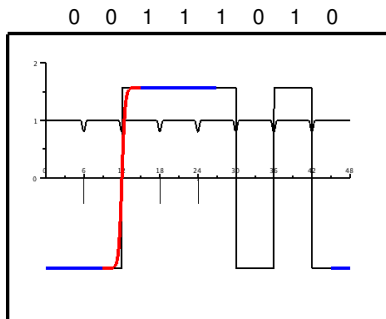

Cells with DW

$$\Theta_a^L(x) = J_L(\pm(x - kL)),$$

- $J_L(x) = \bar{\theta}(x)$ for $x \in [-L/3, L/3]$
- $J_L(x) = \pi/2$ for $x \geq L/2$
- $J_L(x) \sim \pi/2$ for $x \in [L/3, L/2]$

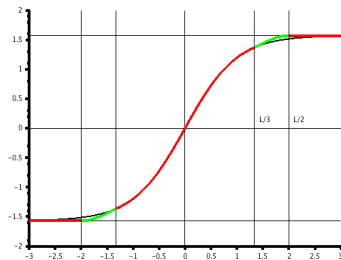

Construction of an approximate solution Θ_a^L

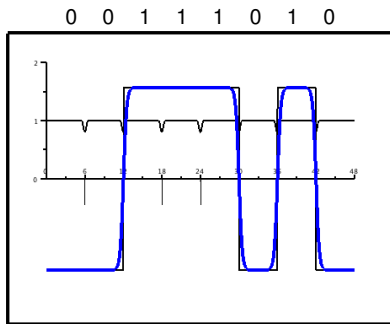

Cells with DW

$$\Theta_a^L(x) = J_L(\pm(x - kL)),$$

- $J_L(x) = \bar{\theta}(x)$ for $x \in [-L/3, L/3]$
- $J_L(x) = \pi/2$ for $x \geq L/2$
- $J_L(x) \sim \pi/2$ for $x \in [L/3, L/2]$

Approximate Stationary

$$\mathcal{F}_L(\theta) = -\partial_{xx}\theta - \frac{s'}{s}\partial_x\theta - \cos\theta \sin\theta$$

$$\partial_x\Theta_a^L(0) = \partial_x\Theta_a^L(NL) = 0$$

$$\|\mathcal{F}(\Theta_a^L)\| \sim e^{-cL} \ll 1.$$

Stationary solution for notched wire

$$\mathcal{F}(\theta) := -\partial_{xx}\theta - \frac{\mathbf{s}'}{\mathbf{s}}\partial_x\theta - \cos\theta\sin\theta$$

$$\left\{ \begin{array}{l} \mathcal{F}(\theta^L) = 0, \\ \partial_x\theta^L(0) = \partial_x\theta^L(NL) = 0, \\ \theta^L \text{ encodes the data.} \end{array} \right.$$

- $\theta^L = \Theta_a^L + v^L$
- $\mathcal{F}(\Theta_a^L)$ is small
- $\Lambda_a^L := \partial_\theta\mathcal{F}(\Theta_a^L)$

$$\Lambda_a^L(v) = -\partial_{xx}v - \frac{\mathbf{s}'}{\mathbf{s}}\partial_xv + (\sin^2\Theta_a^L - \cos^2\Theta_a^L)v$$

$$0 = \mathcal{F}(\Theta_a^L + v^L) = \mathcal{F}(\Theta_a^L) + \Lambda_a^L(v^L) + C(\Theta_a^L, v^L)(v^L, v^L), \quad \text{i.e. } v^L = \Phi_L(v^L)$$

$$\Phi_L(v) := -(\Lambda_a^L)^{-1} \left(\mathcal{F}(\Theta_a^L) + C(\Theta_a^L, v)(v, v) \right).$$

- Λ_a^L is coercive on $\mathbf{V} = \{v, v \in H^2, v'(0) = v'(NL) = 0\}$,
- $\|\Phi_L(v)\| \leq C(e^{-\alpha L} + \|v\|^2)$
- $\|\Phi_L(v) - \Phi_L(w)\| \leq K(\|v\| + \|w\|)\|v - w\|$

Stationary solution for notched wire

$$\mathcal{F}(\theta) := -\partial_{xx}\theta - \frac{\mathbf{s}'}{\mathbf{s}}\partial_x\theta - \cos\theta\sin\theta$$

$$\left\{ \begin{array}{l} \mathcal{F}(\theta^L) = 0, \\ \partial_x\theta^L(0) = \partial_x\theta^L(NL) = 0, \\ \theta^L \text{ encodes the data.} \end{array} \right.$$

- $\theta^L = \Theta_a^L + v^L$
- $\mathcal{F}(\Theta_a^L)$ is small
- $\Lambda_a^L := \partial_\theta\mathcal{F}(\Theta_a^L)$

$$\Lambda_a^L(v) = -\partial_{xx}v - \frac{\mathbf{s}'}{\mathbf{s}}\partial_xv + (\sin^2\Theta_a^L - \cos^2\Theta_a^L)v$$

$$0 = \mathcal{F}(\Theta_a^L + v^L) = \mathcal{F}(\Theta_a^L) + \Lambda_a^L(v^L) + C(\Theta_a^L, v^L)(v^L, v^L), \quad \text{i.e. } v^L = \Phi_L(v^L)$$

$$\Phi_L(v) := -(\Lambda_a^L)^{-1} \left(\mathcal{F}(\Theta_a^L) + C(\Theta_a^L, v)(v, v) \right).$$

- Λ_a^L is coercive on $\mathbf{V} = \{v, v \in H^2, v'(0) = v'(NL) = 0\}$,
- $\|\Phi_L(v)\| \leq C(e^{-\alpha L} + \|v\|^2)$
- $\|\Phi_L(v) - \Phi_L(w)\| \leq K(\|v\| + \|w\|)\|v - w\|$

Stationary solution for notched wire

$$\mathcal{F}(\theta) := -\partial_{xx}\theta - \frac{\mathbf{s}'}{\mathbf{s}}\partial_x\theta - \cos\theta\sin\theta$$

$$\left\{ \begin{array}{l} \mathcal{F}(\theta^L) = 0, \\ \partial_x\theta^L(0) = \partial_x\theta^L(NL) = 0, \\ \theta^L \text{ encodes the data.} \end{array} \right.$$

- $\theta^L = \Theta_a^L + v^L$
- $\mathcal{F}(\Theta_a^L)$ is small
- $\Lambda_a^L := \partial_\theta\mathcal{F}(\Theta_a^L)$

$$\Lambda_a^L(v) = -\partial_{xx}v - \frac{\mathbf{s}'}{\mathbf{s}}\partial_xv + (\sin^2\Theta_a^L - \cos^2\Theta_a^L)v$$

$$0 = \mathcal{F}(\Theta_a^L + v^L) = \mathcal{F}(\Theta_a^L) + \Lambda_a^L(v^L) + C(\Theta_a^L, v^L)(v^L, v^L), \quad \text{i.e.} \quad v^L = \Phi_L(v^L)$$

$$\Phi_L(v) := -(\Lambda_a^L)^{-1} \left(\mathcal{F}(\Theta_a^L) + C(\Theta_a^L, v)(v, v) \right).$$

- Λ_a^L is coercive on $\mathbf{V} = \{v, v \in H^2, v'(0) = v'(NL) = 0\}$,
- $\|\Phi_L(v)\| \leq C(e^{-\alpha L} + \|v\|^2)$
- $\|\Phi_L(v) - \Phi_L(w)\| \leq K(\|v\| + \|w\|)\|v - w\|$

Stationary solution for notched wire

$$\mathcal{F}(\theta) := -\partial_{xx}\theta - \frac{\mathbf{s}'}{\mathbf{s}}\partial_x\theta - \cos\theta\sin\theta$$

$$\left\{ \begin{array}{l} \mathcal{F}(\theta^L) = 0, \\ \partial_x\theta^L(0) = \partial_x\theta^L(NL) = 0, \\ \theta^L \text{ encodes the data.} \end{array} \right.$$

- $\theta^L = \Theta_a^L + v^L$
- $\mathcal{F}(\Theta_a^L)$ is small
- $\Lambda_a^L := \partial_\theta\mathcal{F}(\Theta_a^L)$

$$\Lambda_a^L(v) = -\partial_{xx}v - \frac{\mathbf{s}'}{\mathbf{s}}\partial_xv + (\sin^2\Theta_a^L - \cos^2\Theta_a^L)v$$

$$0 = \mathcal{F}(\Theta_a^L + v^L) = \mathcal{F}(\Theta_a^L) + \Lambda_a^L(v^L) + C(\Theta_a^L, v^L)(v^L, v^L), \quad \text{i.e. } v^L = \Phi_L(v^L)$$

$$\Phi_L(v) := -(\Lambda_a^L)^{-1} \left(\mathcal{F}(\Theta_a^L) + C(\Theta_a^L, v)(v, v) \right).$$

Existence for v^L by fixed point method

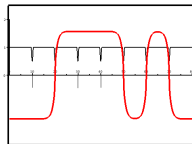

Key point : coercivity of the linearization

$$\Lambda_a^L(v) = -\partial_{xx}v - \frac{\mathbf{s}'}{\mathbf{s}}\partial_x + f_a^L(x)v, \quad f_a^L(x) = \sin^2 \Theta_a^L - \cos^2 \Theta_a^L.$$

For L large enough, Λ_a^L is invertible

$$\exists c > 0, \exists L_0, \forall L \geq L_0, \forall v \in \mathbf{V}, \quad \langle \Lambda_a^L v | v \rangle \geq c \|v\|_{L^2_{\mathbf{s}}}^2, \quad \text{where} \quad \langle u | v \rangle = \int_{\mathbb{R}} \mathbf{s}(x)u(x)v(x) dx$$

Key point : coercivity of the linearization

$$\Lambda_a^L(v) = -\partial_{xx}v - \frac{\mathbf{s}'}{\mathbf{s}}\partial_x + f_a^L(x)v, \quad f_a^L(x) = \sin^2 \Theta_a^L - \cos^2 \Theta_a^L.$$

For L large enough, Λ_a^L is invertible

$$\exists c > 0, \exists L_0, \forall L \geq L_0, \forall v \in \mathbf{V}, \quad \langle \Lambda_a^L v | v \rangle \geq c \|v\|_{L^2_{\mathbf{s}}}^2, \quad \text{where} \quad \langle u | v \rangle = \int_{\mathbb{R}} \mathbf{s}(x)u(x)v(x) dx$$

- if $\text{supp } v$ is in a domain : $\Lambda_a^L(v) = -\partial_{xx}v - \frac{\mathbf{s}'}{\mathbf{s}}\partial_x + v$

$$\langle \Lambda_a^L v | v \rangle = \|\partial_x v\|_{L^2_{\mathbf{s}}}^2 + \|v\|_{L^2_{\mathbf{s}}}^2$$

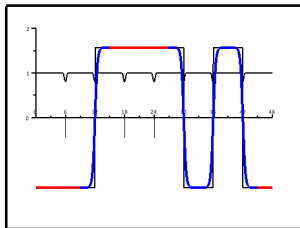

Key point : coercivity of the linearization

$$\Lambda_a^L(v) = -\partial_{xx}v - \frac{s'}{s}\partial_x v + f_a^L(x)v, \quad f_a^L(x) = \sin^2 \Theta_a^L - \cos^2 \Theta_a^L.$$

For L large enough, Λ_a^L is invertible

$$\exists c > 0, \exists L_0, \forall L \geq L_0, \forall v \in \mathbf{V}, \quad \langle \Lambda_a^L v | v \rangle \geq c \|v\|_{L^2_s}^2, \quad \text{where} \quad \langle u | v \rangle = \int_{\mathbb{R}} \mathbf{s}(x)u(x)v(x) dx$$

- if $\text{supp } v$ is around a DW, $\Lambda_a^L(v) = -\partial_{xx}v - \frac{s'}{s}\partial_x v + (\sin^2 \bar{\theta} - \cos^2 \bar{\theta})v = L_1 v$

Infinite-wire case : OK

- Transitional zone : $\Lambda_a^L(v) = -\partial_{xx}v - \frac{s'}{s}\partial_x v + f_a^L v$ et $f_a^L \sim 1$

If L is large enough, \sim domain

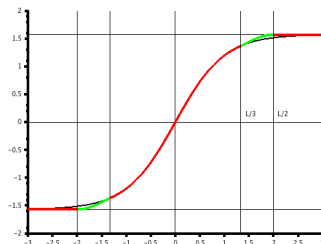
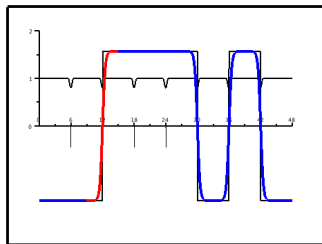

Key point : coercivity of the linearization

$$\Lambda_a^L(v) = -\partial_{xx}v - \frac{\mathbf{s}'}{\mathbf{s}}\partial_x v + f_a^L(x)v, \quad f_a^L(x) = \sin^2 \Theta_a^L - \cos^2 \Theta_a^L.$$

For L large enough, Λ_a^L is invertible

$\exists c > 0, \exists L_0, \forall L \geq L_0, \forall v \in \mathbf{V}, \langle \Lambda_a^L v | v \rangle \geq c \|v\|_{L^2_{\mathbf{s}}}^2$, where $\langle u | v \rangle = \int_{\mathbb{R}} \mathbf{s}(x)u(x)v(x) dx$

- if $\text{supp } v$ is around a DW, $\Lambda_a^L(v) = -\partial_{xx}v - \frac{\mathbf{s}'}{\mathbf{s}}\partial_x v + (\sin^2 \bar{\theta} - \cos^2 \bar{\theta})v = L_1 v$

Infinite-wire case : OK

- Transitional zone : $\Lambda_a^L(v) = -\partial_{xx}v - \frac{\mathbf{s}'}{\mathbf{s}}\partial_x v + f_a^L v$ et $f_a^L \sim 1$

If L is large enough, \sim domain

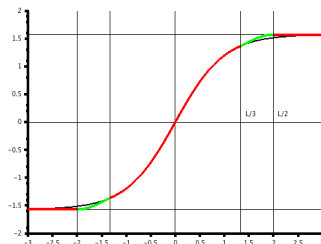
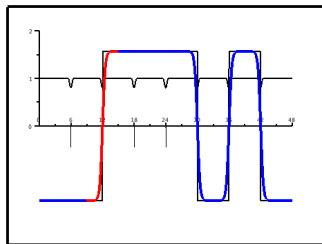

Key point : coercivity of the linearization

$$\Lambda_a^L(v) = -\partial_{xx}v - \frac{\mathbf{s}'}{\mathbf{s}}\partial_xv + f_a^L(x)v, \quad f_a^L(x) = \sin^2 \Theta_a^L - \cos^2 \Theta_a^L.$$

IMS Formula

- $\chi_i \in C^\infty$
- around the j^{th} wall centered in x_j :

$$\chi_j(x) = \psi\left(\frac{x - x_j}{L}\right)$$

- $\text{supp } \chi_0$ in the quasi-domains
-

$$\sum_{i=0}^k (\chi_i)^2 = 1$$

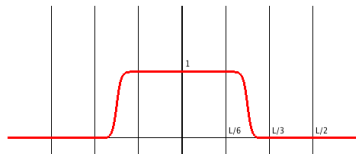

$$\langle \Lambda_a^L(v) | v \rangle = \sum_{j=0}^k \langle \Lambda_a^L(\chi_j v) | \chi_j v \rangle + \mathcal{O}\left(\frac{1}{L}\right) \|v\|_{L^2_s}^2$$

for L large enough, Λ_a^L is coercive

Key point : coercivity of the linearization

$$\Lambda_a^L(v) = -\partial_{xx}v - \frac{\mathbf{s}'}{\mathbf{s}}\partial_xv + f_a^L(x)v, \quad f_a^L(x) = \sin^2 \Theta_a^L - \cos^2 \Theta_a^L.$$

IMS Formula

- $\chi_i \in C^\infty$
- around the j^{th} wall centered in x_j :

$$\chi_j(x) = \psi\left(\frac{x - x_j}{L}\right)$$

- $\text{supp } \chi_0$ in the quasi-domains
-

$$\sum_{i=0}^k (\chi_i)^2 = 1$$

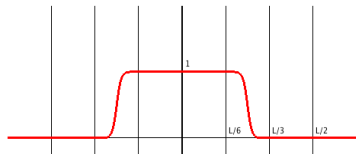

$$\langle \Lambda_a^L(v) | v \rangle = \sum_{j=0}^k \langle \Lambda_a^L(\chi_j v) | \chi_j v \rangle + \mathcal{O}\left(\frac{1}{L}\right) \|v\|_{L_s^2}^2$$

for L large enough, Λ_a^L is coercive

Key point : coercivity of the linearization

$$\Lambda_a^L(v) = -\partial_{xx}v - \frac{\mathbf{s}'}{s}\partial_xv + f_a^L(x)v, \quad f_a^L(x) = \sin^2 \Theta_a^L - \cos^2 \Theta_a^L.$$

IMS Formula

- $\chi_i \in C^\infty$
- around the j^{th} wall centered in x_j :

$$\chi_j(x) = \psi\left(\frac{x - x_j}{L}\right)$$

- $\text{supp } \chi_0$ in the quasi-domains
-

$$\sum_{i=0}^k (\chi_i)^2 = 1$$

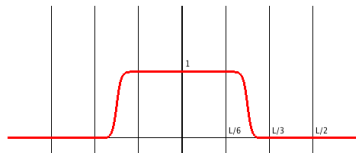

$$\langle \Lambda_a^L(v) | v \rangle = \sum_{j=0}^k \langle \Lambda_a^L(\chi_j v) | \chi_j v \rangle + \mathcal{O}\left(\frac{1}{L}\right) \|v\|_{L_s^2}^2$$

for L large enough, Λ_a^L is coercive

Conclusion

There exists a solution close to Θ_a^L

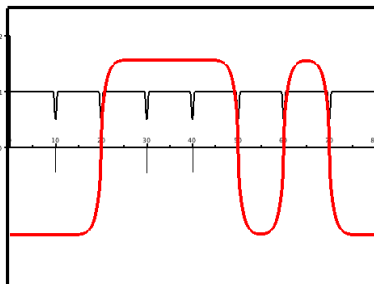
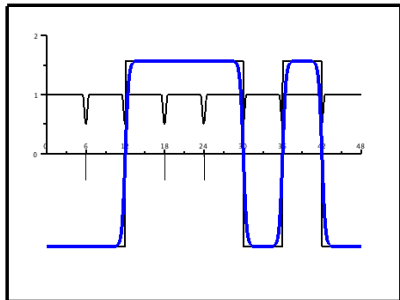

This solution is asymptotically stable modulo rotation around the wire axis

DW are pinned by the notches

- 1 Physical Context
- 2 1d Model for ferromagnetic nanowires
- 3 Walls in constant-section wire
- 4 Wall configurations for infinite nanowire with one notch
- 5 Wire with several notches
- 6 Applied Magnetic Field and Electric Current Effects**

Notched Nanowire

$$m : \mathbb{R}_t^+ \times I_x \rightarrow \mathcal{S}^2$$

$$\frac{\partial m}{\partial t} = -m \times H_{\text{eff}} - m \times (m \times H_{\text{eff}})$$

$$\mathcal{H}_{\text{eff}} = m_{xx} + \frac{\mathbf{s}'}{\mathbf{s}} m_x - m_2 \vec{e}_2 - m_3 \vec{e}_3 + h_a \vec{e}_1$$

Boundary Conditions

Constant-cross-section wire : precessional regime

$$m(t, x) = R_{h_a t} M_0(x + h_a t)$$

Notched wire :

For small h_a : the wall does not move, remains in the notch (static solution), its profile is planar.

Construction of the solution by implicit function theorem

Notched Nanowire

$$m : \mathbb{R}_t^+ \times I_x \rightarrow \mathcal{S}^2$$

$$\frac{\partial m}{\partial t} = -m \times H_{\text{eff}} - m \times (m \times H_{\text{eff}})$$

$$\mathcal{H}_{\text{eff}} = m_{xx} + \frac{\mathbf{s}'}{\mathbf{s}} m_x - m_2 \vec{e}_2 - m_3 \vec{e}_3 + h_a \vec{e}_1$$

Boundary Conditions

Constant-cross-section wire : precessional regime

$$m(t, x) = R_{h_a t} M_0(x + h_a t)$$

Notched wire :

For small h_a : the wall does not move, remains in the notch (static solution), its profile is planar.

Construction of the solution by implicit function theorem

Notched Nanowire

$$m : \mathbb{R}_t^+ \times I_x \rightarrow S^2$$

$$\frac{\partial m}{\partial t} = -m \times H_{\text{eff}} - m \times (m \times H_{\text{eff}})$$

$$\mathcal{H}_{\text{eff}} = m_{xx} + \frac{\mathbf{s}'}{\mathbf{s}} m_x - m_2 \vec{e}_2 - m_3 \vec{e}_3 + h_a \vec{e}_1$$

Boundary Conditions

Constant-cross-section wire : precessional regime

$$m(t, x) = R_{h_a t} M_0(x + h_a t)$$

Notched wire :

For small h_a : the wall does not move, remains in the notch (static solution), its profile is planar.

Construction of the solution by implicit function theorem

Infinite Notched Nanowire

$$m : \mathbb{R}_t^+ \times \mathbb{R}_x \rightarrow \mathcal{S}^2$$

$$\frac{\partial m}{\partial t} = -m \times H_{\text{eff}} - m \times (m \times H_{\text{eff}})$$

$$\mathcal{H}_{\text{eff}} = m_{xx} + \frac{\mathbf{s}'}{\mathbf{s}} m_x - m_2 \vec{e}_2 - m_3 \vec{e}_3 + h_a \vec{e}_1$$

For $h_a \geq \frac{\pi - \mathbf{s}(0)}{\pi + \mathbf{s}(0)}$, there is no static solution with one DW

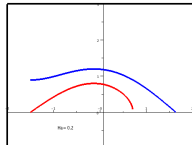
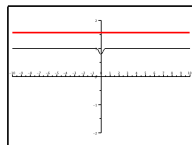
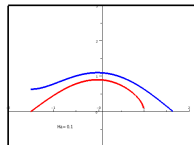
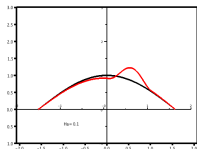
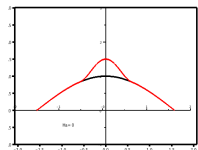

Notched Nanowire

$$m : \mathbb{R}_t^+ \times I_x \rightarrow S^2$$

$$\frac{\partial m}{\partial t} = -m \times H_{\text{eff}} - m \times (m \times H_{\text{eff}}) - \frac{\mathbf{v}}{\mathbf{s}} \partial_x m - \frac{\mathbf{v}}{\mathbf{s}} m \times \partial_x m$$

$$\mathcal{H}_{\text{eff}} = m_{xx} + \frac{\mathbf{s}'}{\mathbf{s}} m_x - m_2 \vec{e}_2 - m_3 \vec{e}_3$$

Boundary Conditions

Notched wire :

- the wall remains in the notch
- non planar configuration
- the profile turns around the wire
- Depinning by electric current ???

Notched Nanowire

$$m : \mathbb{R}_t^+ \times I_x \rightarrow \mathcal{S}^2$$

$$\frac{\partial m}{\partial t} = -m \times H_{\text{eff}} - m \times (m \times H_{\text{eff}}) - \frac{\mathbf{v}}{\mathbf{s}} \partial_x m - \frac{\mathbf{v}}{\mathbf{s}} m \times \partial_x m$$

$$\mathcal{H}_{\text{eff}} = m_{xx} + \frac{\mathbf{s}'}{\mathbf{s}} m_x - m_2 \vec{e}_2 - m_3 \vec{e}_3$$

Boundary Conditions

Notched wire :

- the wall remains in the notch
- non planar configuration
- the profile turns around the wire
- Depinning by electric current ???

We proved the reliability of this kind of storage devices if L is large enough

- Stability threshold for L ?
- Dynamics of the walls in notched wires ?
- Recording (Creation of walls) ?

Thank you for your attention

We proved the reliability of this kind of storage devices if L is large enough

- Stability threshold for L ?
- Dynamics of the walls in notched wires ?
- Recording (Creation of walls) ?

Thank you for your attention

We proved the reliability of this kind of storage devices if L is large enough

- Stability threshold for L ?
- Dynamics of the walls in notched wires ?
- Recording (Creation of walls) ?

Thank you for your attention