



**HAL**  
open science

# Optimal nonlinear control of an industrial emulsion polymerization reactor

I D Gil, J C Vargas, Jean Pierre Corriou

► **To cite this version:**

I D Gil, J C Vargas, Jean Pierre Corriou. Optimal nonlinear control of an industrial emulsion polymerization reactor. *Chemical Engineering Research and Design*, 2016, 10.1016/j.cherd.2016.04.016 . hal-02383501

**HAL Id: hal-02383501**

**<https://hal.science/hal-02383501>**

Submitted on 27 Nov 2019

**HAL** is a multi-disciplinary open access archive for the deposit and dissemination of scientific research documents, whether they are published or not. The documents may come from teaching and research institutions in France or abroad, or from public or private research centers.

L'archive ouverte pluridisciplinaire **HAL**, est destinée au dépôt et à la diffusion de documents scientifiques de niveau recherche, publiés ou non, émanant des établissements d'enseignement et de recherche français ou étrangers, des laboratoires publics ou privés.

# Optimal nonlinear control of an industrial emulsion polymerization reactor

I.D. Gil<sup>a,b</sup>, J.C. Vargas<sup>a</sup>, J.P. Corriou<sup>b</sup>

<sup>a</sup>*Departamento de Ingeniería Química y Ambiental, Universidad Nacional de Colombia Ciudad Universitaria, Bogotá - Colombia (e-mail: idgilc@unal.edu.co)*

<sup>b</sup>*Laboratoire Réactions et Génie des Procédés, CNRS, Université de Lorraine, ENSIC 1, Rue Grandville, B.P. 20451, 54001, Nancy Cedex, France (e-mail: jean-pierre.corriou@univ-lorraine.fr)*

---

## Abstract

In this paper, the modelling, dynamic optimization and nonlinear control of an industrial emulsion polymerization reactor producing poly-vinyl acetate (PVAc) are proposed. The reaction is modeled as a two-phase system composed of an aqueous phase and a particle phase according to the model described in our previous work (Gil et al., 2014). The case study corresponds to an industrial reactor operated at a chemical company in Bogotá (Colombia). An industrial scale reactor (11 m<sup>3</sup> of capacity) is simulated. Three different dynamic optimization problems are solved from the more simplistic (only one control variable: reactor temperature) to the more complex (three control variables: reactor temperature, initiator flow rate and monomer flow rate) in order to minimize the reaction time. The results show that it is possible to minimize the reaction time while some polymer desired qualities (conversion, molecular weight and solids content) satisfy defined constraints. The optimal temperature profile and optimal feed policies of the monomer and initiator, obtained in a dynamic optimization step, are used as optimal set points for reactor control. A nonlinear geometric controller based on input/output linearization is implemented for temperature control.

*Keywords:* Dynamic optimization, Nonlinear geometric control, Optimal temperature profile, Optimal feed policies, Polymerization, Vinyl acetate.

---

## 1. Introduction

The purpose of dynamic optimization studies is to determine a set of variables of a dynamic system, such as flow rates, temperatures, pressures, heat duties, . . . , that optimize a given cost function or criterion (costs, productivity, time, energy, selectivity) subject to specific constraints (dynamic model, operating conditions, safety and environmental restrictions). Some of the common problems of chemical engineering addressed by means of dynamic simulation and optimization include startup, upset, shutdown and transient analysis, safety studies, control and scheduling of batch and semi-batch processes, and the validation of control schemes (Biegler, 2007; Cervantes and Biegler, 2008). In all cases, it is important to possess a dynamic model sufficiently representative of the real process by means of mass and energy balances, and algebraic equations for physical and thermodynamic relations, but with a moderate complexity in order to get a mathematical and numerical solution without difficulty (Corriou, 2004, 2012).

Some of the most important objectives in resins and polymer production plants are related to the improvement of safety, quality and productivity, minimum operating costs and respect of environmental constraints (Gentric et al., 1999). These make the optimization and control of polymerization reactors of great interest. In most cases, an optimization problem for a polymerization system requires the definition of an objective function and constraints which are defined by the reaction time and/or polymer molecular characteristics, together with operating conditions. In terms of polymerization reactors, the main contributions concern homogeneous reactions and some multiphase considerations trying to minimize the batch period, improve quality control and minimize the molecular weight distribution. In these cases, nonlinear models are essential to accurately describe the dynamics of the process. The solution of this kind of optimal control problems can be obtained by means of various optimization methods such as variational calculus, Hamilton-Jacobi equations, Pontryagin's maximum principle for continuous time systems and Bellman dynamic programming for discrete time systems, among others (Corriou, 2004, 2012; Kameswaran and Biegler, 2006; Biegler, 2007).

In the case of emulsion polymerization, several studies deal with dynamic optimization. For example, (Jang and Yang, 1989) report the dynamic minimization of the final time of a batch emulsion polymerization of vinyl acetate using initiator flow rate as control variable, and the maximum allowable reac-

38 tion rate together with the total amount of initiator as constraints. (Gentric  
39 et al., 1999) calculate the optimal temperature profile that minimizes the  
40 batch time of a copolymerization reactor of styrene and  $\alpha$ -methylstyrene  
41 using orthogonal collocation coupled with a sequential quadratic program-  
42 ming method. As constraints, they used the final conversion and the final  
43 number average molecular weight. (Sayer et al., 2001) and (Vicente et al.,  
44 2002) calculated the optimal monomer and chain-transfer agent feed pro-  
45 files for the semi-batch methylmethacrylate (MMA)/*n*-butylacrylate (*n*-BA)  
46 emulsion copolymerization, using iterative dynamic programming with an  
47 objective function that included a term for the copolymer composition and  
48 also a term for the molecular weight distribution, in a way close to multiob-  
49 jective optimization. (Araújo and Giudici, 2003) used variable time intervals  
50 with an iterative dynamic programming procedure to minimize the reaction  
51 time while composition and molecular weight are controlled at specific values.  
52 (Paulen et al., 2010) worked on the dynamic optimization of the emulsion  
53 copolymerization of styrene and  $\alpha$ -methylstyrene applying control vector pa-  
54 rameterization (CVP) method in order to minimize the total reaction time.  
55 Recently, batch and semibatch operation of copolymerization of styrene and  
56 MMA (Ibrahim et al., 2011) were studied in order to maximize the monomer  
57 conversion in one case and the average molecular weight in a second case by  
58 means of CVP techniques solved by successive quadratic programming. Multi-  
59 objective optimization refers to simultaneous optimization of more than one  
60 objective function, which is typical in most real-life optimization problems  
61 encountered in industry (Benyahia et al., 2011). Multiobjective dynamic  
62 optimization has been also studied for a semibatch styrene polymerization  
63 process in order to establish optimal operating temperature and feeding poli-  
64 cies, which maximize monomer conversion and minimize the residual initiator  
65 in the final product (Silva and Biscaia Jr., 2004).

66 In the present work, the dynamic optimization of the industrial emulsion  
67 polymerization of vinyl acetate is performed with respect to three different  
68 optimization scenarios. In the three cases, the objective is to minimize the  
69 reaction time by varying separately or simultaneously the reactor tempera-  
70 ture, initiator flow rate and monomer flow rate. After optimization, some  
71 open loop optimal results obtained are used for comparison with closed loop  
72 simulations. The nonlinear geometric controller coupled with state estima-  
73 tion is used for tracking the optimal reaction temperature profile found by  
74 dynamic optimization. The results show the potential of dynamic optimiza-  
75 tion in finding optimal feed policies and operating temperature to improve

76 the productivity. Also, it is demonstrated that the optimal temperature  
77 trajectory is well followed by means of a nonlinear controller.

## 78 2. Dynamic optimization of vinyl acetate emulsion polymerization

### 79 2.1. Experimental validation of the model

The dynamic state space model of the process has been described in a previous work (Gil et al., 2014). Nine states are used  $[I, M_t, M_M, V_{pol}, \mu_0, \mu_1, \mu_2, T, T_j]$  standing respectively for the initiator concentration  $I$ , total added monomer  $M_t$ , remaining monomer  $M_M$ , total volume of polymer  $V_{pol}$ , three first moments of polymerization  $\mu_i$ , reactor temperature  $T$  and jacket temperature  $T_j$ . The first seven equations correspond to the reaction kinetics and the two following equations to the energy balances for the reactor and jacket.

Kinetic model:

$$\frac{dI}{dt} = q_I - k_I I \quad (1)$$

$$\frac{dM_t}{dt} = q_M \quad (2)$$

$$\frac{dM_M}{dt} = q_M - \mathcal{R}_{pol} \quad (3)$$

$$\frac{dV_{pol}^p}{dt} = \mathcal{R}_{pol} \frac{MW_M}{\rho_{pol}} \quad (4)$$

$$\begin{aligned} \frac{d\mu_0}{dt} = & (k_{fm} [M]^p + k_{fp}\mu_0 + k_t\lambda_0) \alpha \lambda_0 - \\ & k_{fp}\lambda_0 \left( \mu_0 - (1 - \alpha)^2 \alpha \lambda_0 \right) + 0.5k_t\lambda_0^2 \end{aligned} \quad (5)$$

$$\begin{aligned} \frac{d\mu_1}{dt} = & \frac{\lambda_0}{1 - \alpha} \left( (k_{fm} [M]^p + k_{fp}\mu_0 + k_t\lambda_0) \alpha (2 - \alpha) + k_t\lambda_0 \right) - \\ & k_{fp}\lambda_0^2 \left( 1 - \alpha (1 - \alpha)^2 \right) \end{aligned} \quad (6)$$

$$\begin{aligned} \frac{d\mu_2}{dt} = & \frac{\lambda_0}{(1 - \alpha)^2} \left( 2\alpha (k_{fm} [M]^p + k_{fp}\mu_0 + k_t\lambda_0) + k_t\lambda_0 (2\alpha + 1) \right) \\ & - 2k_{fp}\lambda_0^2 \left( \frac{1 - \alpha (1 - \alpha)^3}{1 - \alpha} \right) + \frac{d\mu_1}{dt} \end{aligned} \quad (7)$$

Reactor dynamics:

$$\frac{dT}{dt} = \frac{\sum q_i C_{p,i} (T_i - T) - \Delta H_r \mathcal{R}_{pol} + UA(T_j - T) - Q_{cond}}{\sum m_i C_{p,i}} \quad (8)$$

$$\frac{dT_j}{dt} = \frac{F_j (T_{j_{in}} - T_j)}{m_w} - \frac{UA}{m_w C_{p,w}} (T_j - T) \quad (9)$$

80 The major part of the model has been validated previously (Araújo and  
 81 Giudici, 2003; Arora et al., 2007) based on the experimental data obtained  
 82 by (Penlidis et al., 1985; Penlidis, 1986). The main modifications to the  
 83 model are related to the energy balances for the reactor and the jacket. In  
 84 this section, a simulation of a pilot plant reactor from a Colombian chem-  
 85 ical company is reported, in order to reproduce its industrial operation, to  
 86 compare the results with some measurements of the solids content and to  
 87 have an idea of the reaction conversion. Some tests in a pilot scale reactor  
 88 were carried out and the results were compared with a simulation of the  
 89 same system using Matlab. A semi-batch emulsion polymerization reaction  
 90 of vinyl acetate was performed. The used recipe is given in Table 1. The  
 91 reactor temperature was fixed taking into account the preheating step. The  
 92 monomer and initiator flow rates were adjusted manually by the operator  
 93 during the whole operation. The goal is to maintain a nearly constant value  
 94 of the temperature in the reactor. In the current operation of the industrial  
 95 reactor, a jacket is used but only for the initial preheating step. During the  
 96 reaction, temperature is maintained almost constant by manipulating only  
 97 initiator and monomer flow rates. Consequently, the temperature cannot  
 98 accurately follow a given set point and this limits the feed flow rate of the  
 99 reactants in view of a more efficient process. For that reason, a different  
 100 control is desirable with efficient use of the jacket. To that intent, energy  
 101 balances of the reactor will be used to take into account the behavior of the  
 102 jacket and reactor contents. This will be useful in the next stages of the work  
 103 to propose a control strategy associated also to a dynamic optimization of  
 the system.

Table 1: Recipe used in the pilot emulsion polymerization reactor

Component	Load (kg)
Water	36
Vinyl acetate	35
Potassium persulfate	0.12
Polyvinyl alcohol	3.5

104 In order to follow the reaction, solids content and viscosity were measured  
 105 by withdrawing samples at specific reaction times. The procedure established  
 106

107 for the determination of solids content in adhesives in the Colombian Tech-  
 108 nical Standards NTC-5003 (In Spanish, Norma Técnica Colombiana NTC-  
 109 5003) was used. Viscosity was determined by following the Colombian Tech-  
 110 nical Standards NTC-5063 (In Spanish, Norma Técnica Colombiana NTC-  
 111 5063).

The solids content  $\phi_S$  is calculated theoretically by summing the weight of polymer formed and the weight of the polyvinyl alcohol and dividing it by the total weight of the latex

$$\phi_S = \frac{(M_t - M_M)MW_M + M_{PVOH}}{M_tMW_M + M_{PVOH} + \rho_w V_w} \quad (10)$$

The viscosity of the reactor contents  $\eta$  is calculated from the expression (11) proposed by (Chylla and Haase, 1993) that depends on the solids content and the reactor temperature. Some of the parameters of (11) were proposed by other authors (Graichen et al., 2006; Hvala et al., 2011) or fitted using experimental information from this test

$$\eta = c_0 e^{(c_1 \phi_S)} 10^{c_2 \left( \frac{a_0}{T} - c_3 \right)} \quad (11)$$

112 where  $a_0$ ,  $c_0$ ,  $c_1$ ,  $c_2$  and  $c_3$  are model parameters, and  $T$  is the reactor tem-  
 113 perature.

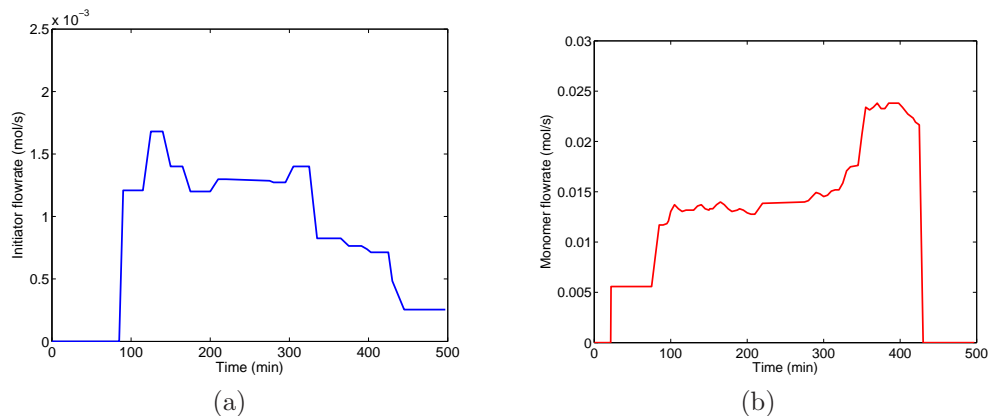

Figure 1: Flow rates for the pilot reactor test. (a) Initiator, (b) Monomer

113 Figure 1 shows monomer and initiator flow rates used during all the reac-  
 114 tion. As it was mentioned previously, these flow rates are imposed manually  
 115

116 by the operator to guarantee a nearly constant temperature in the reactor.  
117 In the same way, Figure 2a and Figure 2b show the corresponding quantities  
of initiator and monomer respectively remaining in the reactor.

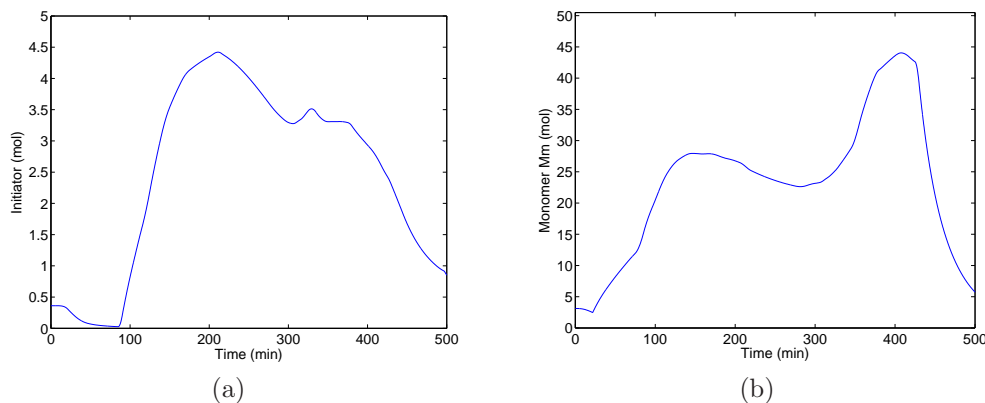

Figure 2: Number of moles in the pilot reactor test. a) Initiator, b) Monomer

118

119

120

121

122

123

124

125

126

127

128

129

130

131

132

133

134

135

136

137

138

139

It can be seen that the quantity of remaining monomer in the reactor changes accordingly to variations of the monomer flow rate, and also it is influenced by additional injections of initiator that increase the polymerization rate. The initiator reacts in the first part of the batch rapidly as a result of the high increase of the temperature and then, when the initiator feed starts, there is an accumulation of initiator (Figure 2a). It is also evident that almost all the monomer is consumed in the polymerization reaction (Figure 2b) verifying the large conversions typical of emulsion polymerization processes.

Reactor temperature during the total batch time is shown in Figure 3. The average temperature in the reactor is close to 343 K. From Figures 2 and 3, it can be noted that, when reactor temperature increases, reaction rate also increases thus decreasing the number of moles of monomer remaining in the reactor. Average molecular weight, dispersity and conversion are presented in Figure 4. The average molecular weight and, in consequence, the dispersity are varying in function of the initiator and monomer injections during all the batch while the conversion increases up to 350 min (approx.), then decreases slowly, and finally increases until the end of the run where the conversion is higher than 98%. This is due to the effect of temperature on the reaction rate and also it can be explained by the constant initiator flow rate at the end of the batch.

Finally, in order to do a validation, simulation results of solids content



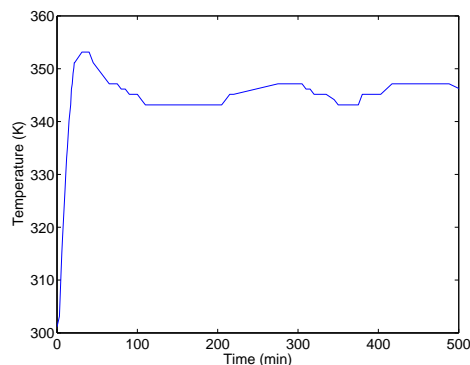

Figure 3: Temperature profile for the pilot reactor test

140 and viscosity were plotted with those data of experimental pilot test (Figure  
 141 5). As can be verified, there is a good representation of the solids content  
 142 along the run. This is an indication of the adequacy of the model and its pa-  
 143 rameters, taking into account that the solids content is directly related to the  
 144 reaction and the formation of polymer particles. On the other way, it should  
 145 be noted also that, apart from a single point which is erroneous, viscosity is  
 146 well represented by the model. The comparison made with the experimental  
 147 data obtained shows that a good approximation with respect to typical val-  
 148 ues of viscosity of this kind of emulsions is achieved. In addition, viscosity  
 149 measurement is spoiled by an experimental error that was not quantified here,  
 150 but depends on the measurement technique and the operator. Of course, the  
 151 experimental error has an effect on the fitting of the viscosity model to the  
 152 experimental values determined in the pilot reactor.

### 153 *2.2. Industrial case study*

154 In the following, the dynamic optimization of an industrial emulsion poly-  
 155 merization reactor to produce poly-vinyl acetate will be presented. The case  
 156 study corresponds to the industrial reactor operated in a chemical company  
 157 in Colombia. An industrial scale reactor (11 m<sup>3</sup> of capacity) is simulated in  
 158 the case where a semi-batch emulsion polymerization reaction of vinyl ac-  
 159 etate is performed. A schematic of the reactor is shown in Figure 6. The  
 160 used industrial recipe is shown in Table 2.

161 Three different dynamic optimization problems are solved with a piece-  
 162 wise constant control using different discretization scenarios. In the three  
 163 problems, three different variables were considered as control variables  $u(t)$ :

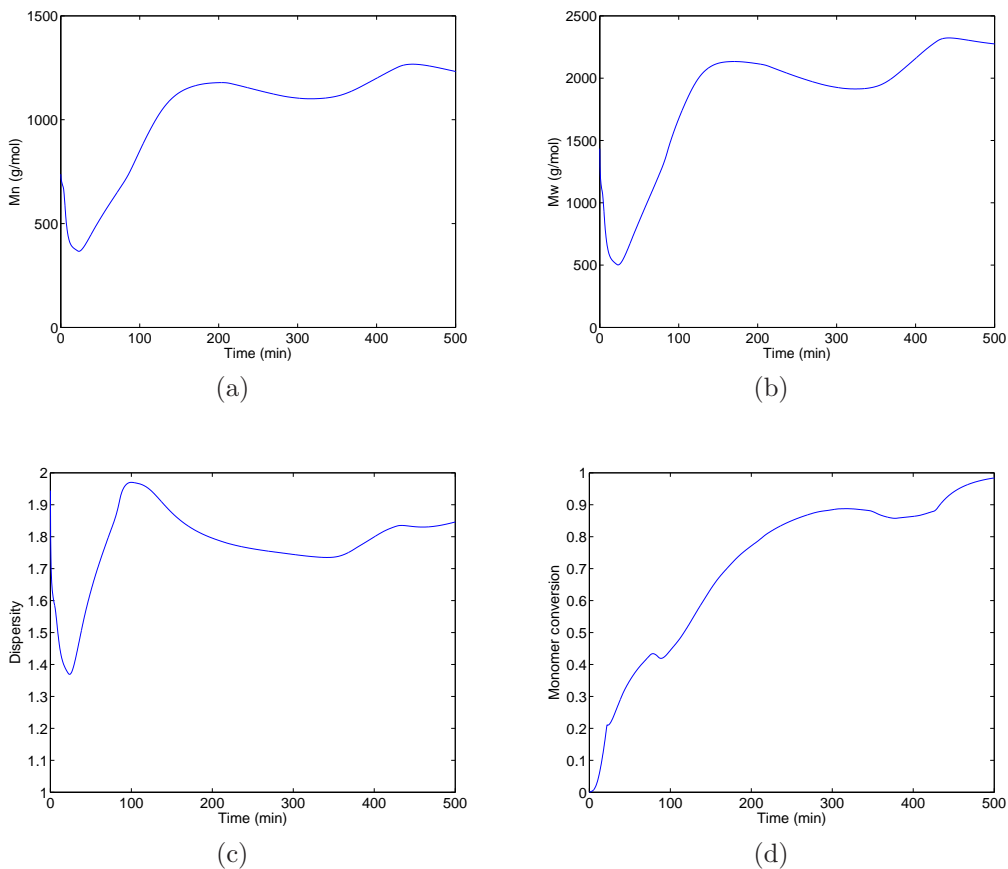

Figure 4: Quality results for the pilot reactor test. a) Number average molecular weight, b) Weight average molecular weight, c) Dispersity, d) Conversion

164 reactor temperature, initiator flow rate and monomer flow rate. Quality  
 165 constraints are set in all the cases according to the requirements of the  
 166 product and to the information provided by the company. The dynamic  
 167 optimization problem is solved by means of direct optimization using the  
 168 NonLinear Programming (NLP) solver *fmincon* function in Matlab which  
 169 solves constrained NLP problems. The mathematical model for the emul-  
 170 sion polymerization was reported in a previous work (Gil et al., 2014) and  
 171 was summarized in section 2.1. In the dynamic optimization problem, the  
 172 energy balances representing the reactor temperature dynamics are not con-  
 173 sidered because the reactor temperature  $T$  will be assumed as a control vari-  
 174 able. This corresponds to an open loop control study. The model used

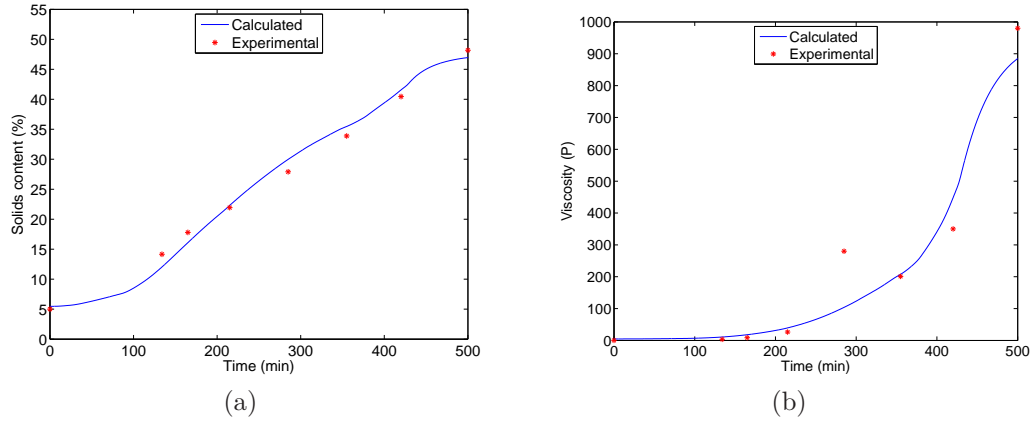

Figure 5: Quality results of the experimental pilot reactor test. a) Solids content, b) Viscosity

175 for dynamic optimization then corresponds to the following seven states  
 176  $[I, M_t, M_M, V_{pol}, \mu_0, \mu_1, \mu_2]$ . Here, the goal is to calculate an optimal reactor  
 177 temperature profile based on the knowledge of the polymerization kinetics.  
 178 In the second part of this study, devoted to closed loop control, the dynamics  
 179 of the reactor as energy balances will be considered.

### 180 2.3. Process operation

181 An emulsion polymerization process displays different behaviors accord-  
 182 ing to the relative rates of initiation, propagation and termination, which at  
 183 the same time depend on the monomer flow rate, initiator flow rate and reac-  
 184 tion conditions. Typically, semi-batch emulsion polymerizations are divided  
 185 in two steps: batch and fed-batch (Figure 7). At initial time  $t = 0$ , specific  
 186 quantities of monomer, initiator, water and protective colloid, representing a  
 187 fraction of the recipe, are charged to the reactor. In the process studied here,  
 188 according to the procedure followed by the chemical company, monomer, ini-

Table 2: Recipe used for the simulation of the industrial reactor

Component	Load (kg)
Water	5400
Vinyl acetate	4651
Potassium persulfate	12.8
Polyvinyl alcohol	701

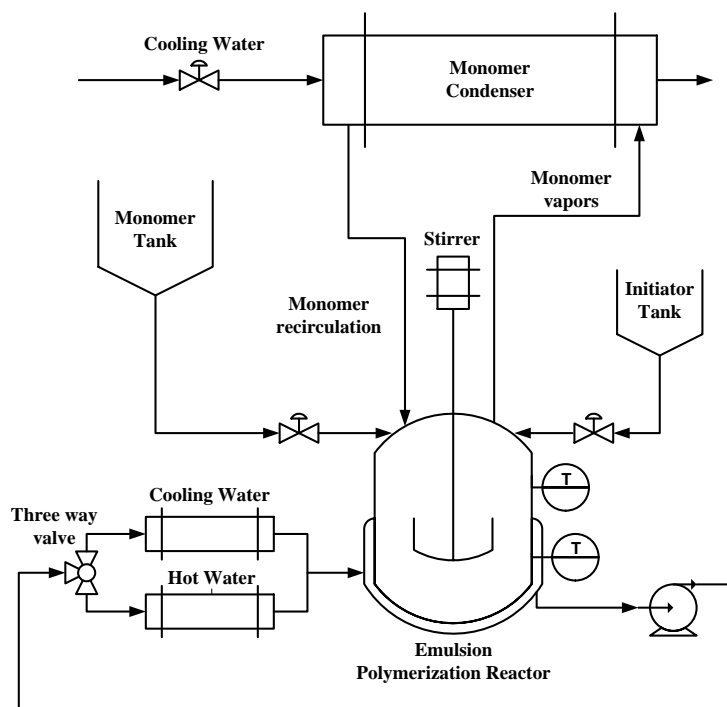

Figure 6: Schematic of the industrial emulsion polymerization reactor

189 tiator and protective colloid are respectively vinyl acetate, potassium persulfate  
 190 and polyvinyl alcohol. A pre-heating step of the reactor is carried out  
 191 by injecting steam or hot water into the reactor jacket in order to reach a  
 192 temperature of 351 K. The reactor must be maintained at this temperature  
 193 to ensure complete dissolution of the polyvinyl alcohol. The reaction starts  
 194 when the activation temperature of the initiator is reached (approximately  
 195 340 K). This stage of the process is operated in batch mode and, during  
 196 that period, primary nucleation takes place, generating most of the particles.  
 197 In this stage, the total number of particles is defined and remains almost  
 198 constant during the rest of the reaction, including the following fed-batch  
 199 operation. The remaining monomer, according to the recipe, is fed con-  
 200 tinuously during the major part of the reactor operation (strictly speaking,  
 201 during the fed-batch mode operation) and its flow rate can be adjusted to  
 202 approximately regulate the reactor temperature and, in this way, partially  
 203 reduce the rate of heat generation by means of its sensible heat. The initiator  
 204 can be fed continuously to the reactor at a variable flow rate or, according

205 to the industrial procedure, by finite impulses at a constant flow rate at two  
 206 or three different times during the batch. The agitation speed is constant.  
 207 Because of the exothermicity of the reaction, high quantities of heat are re-  
 208 leased and the temperature inside the reactor is controlled around a specified  
 209 value by adjusting the inlet jacket temperature. Three main input variables  
 210 to the process can be identified, monomer flow rate, initiator flow rate and  
 211 inlet jacket temperature, this latter being adjusted by means of a three way  
 212 valve. The temperature is considered as a measured output. Figure 6 shows  
 213 the schematic industrial reactor configuration and the main steps of a typical  
 emulsion polymerization are summarized in Figure 7.

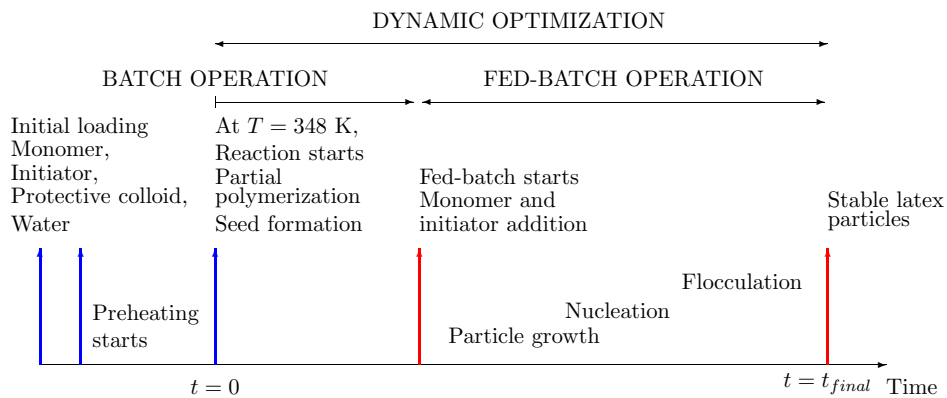

Figure 7: Sequential steps of a typical semi-batch emulsion polymerization

214  
 215 In this study, the pre-heating step is not taken into account for the dy-  
 216 namic optimization calculations. At the end of the pre-heating stage, when  
 217 the reactor temperature reaches 340 K, the reaction is assumed to start and  
 218 it corresponds to the initial reaction time  $t = 0$  which is thus difficult to  
 219 determine exactly. Later, the reactor temperature will take a value between  
 220 348 and 355 K, as it will be explained in next section.

221 *2.4. Minimization of batch time with  $T$  as control variable*

In the first case, in order to maximize the productivity of the industrial  
 polymerization reactor, i.e. to minimize the final batch time, the optimal  
 temperature profile is calculated. Temperature is chosen because of its large  
 influence on the polymerization reaction and polymer properties. The opti-

mization problem can be formulated as

$$\begin{aligned}
& \min_{T(t)} \int_{t_0}^{t_f} dt = t_f - t_0 \\
& \text{s.t.} \quad \dot{x}_i = f_i(x(t), T(t), t), \quad i = 1, \dots, 7 \text{ and } \forall t \in [t_0, t_f], \quad \text{state model} \\
& \quad x_1(t_0) = 5, \quad \text{initiator moles} \\
& \quad x_2(t_0) = 4000, \quad \text{total monomer moles} \\
& \quad x_3(t_0) = 4000, \quad \text{residual monomer moles} \\
& \quad x_i(t_0) = 0, \quad i = 4, \dots, 7, \quad \text{initial conditions} \\
& \quad x_f \geq 0.95, \quad \text{final conversion} \\
& \quad M_{n,f} \geq 1.8 \times 10^5, \quad \text{final number average molecular weight} \\
& \quad \phi_S \geq 46\%, \quad \text{final solids content} \\
& \quad 348\text{K} \leq T(t) \leq 355\text{K}, \quad \text{temperature interval}
\end{aligned} \tag{12}$$

Table 3: Dynamic optimization case using  $T$  as control variable: Influence of the number of time increments on the optimization results

$N_u$	$t_f$ (s)	$x_f$	$M_{n,f} \times 10^{-5}$	$M_{w,f} \times 10^{-5}$	$D$
3	26463	0.9625	2.6217	5.7279	2.18
5	26458	0.9655	2.6341	5.7907	2.19
10	26347	0.9678	2.6161	5.7509	2.19
20	26214	0,9706	2.6586	5.8062	2.18

222 The monomer and initiator flow rates are constant according to the recipe  
223 of Table 2. The value of monomer flow rate corresponds approximately to the  
224 ratio of the monomer quantity of the industrial recipe over the duration of  
225 the fed-batch time, similarly for the initiator flow rate. Indeed, as the final  
226 time is not known before dynamic optimization, the monomer is fed from  
227  $t = 70$  min with a flow rate of 2.1 mol/s, whereas the maximum authorized  
228 flow rate in the industrial operation is 2.3 mol/s. The initiator flow rate is  
229  $1 \times 10^{-3}$  mol/s also from  $t = 70$  min (Figures 9a and 9b). Then, the operation  
230 is performed in two stages, the first one in batch mode (without addition of  
231 reactants) and the rest of the operation in fed-batch mode where monomer  
232 and initiator are fed to the reactor. Consequently, two different models are  
233 used, one for the batch operation, followed by another one for the fed-batch.  
234 Dynamic optimization is applied to the entire operation, i.e. including the  
235 batch mode and fed-batch mode stages (Figure 8).

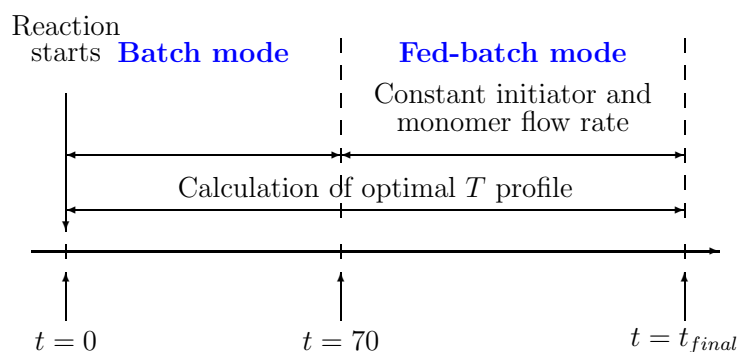

Figure 8: Dynamic optimization case using  $T$  as control variable: Scheduling of operations

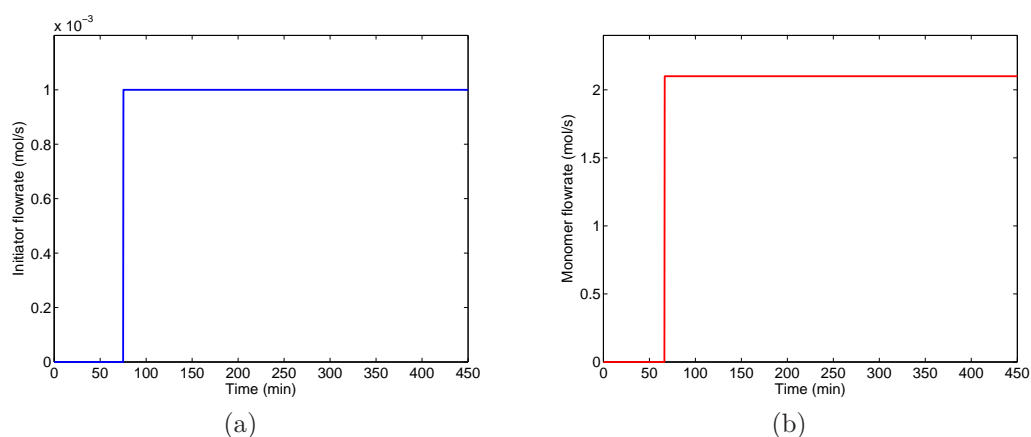

Figure 9: Dynamic optimization case using  $T$  as control variable: Feed policies, Initiator flow rate (a), Monomer flow rate (b)

236 The influence of the number  $N_u$  of discrete time segments used during  
 237 the total reaction time has been studied. Thus, four different discretization  
 238 scenarios were calculated considering  $N_u$  equal to 3, 5, 10 and 20, the tem-  
 239 perature taken as the control variable being piecewise constant on each time  
 240 interval. Table 3 shows the influence of the number of discrete time incre-  
 241 ments on the most important quality indicators of the final polymer. As it  
 242 can be observed, the total batch time decreases little with the increase of  
 243 the number of piecewise controls. At the same time, the overall quality of  
 244 the polymer such as the conversion and the average molecular weight is very  
 245 little influenced by the increase of the number of time increments.

246 Figures 10 and 11 show the influence of the number of time increments

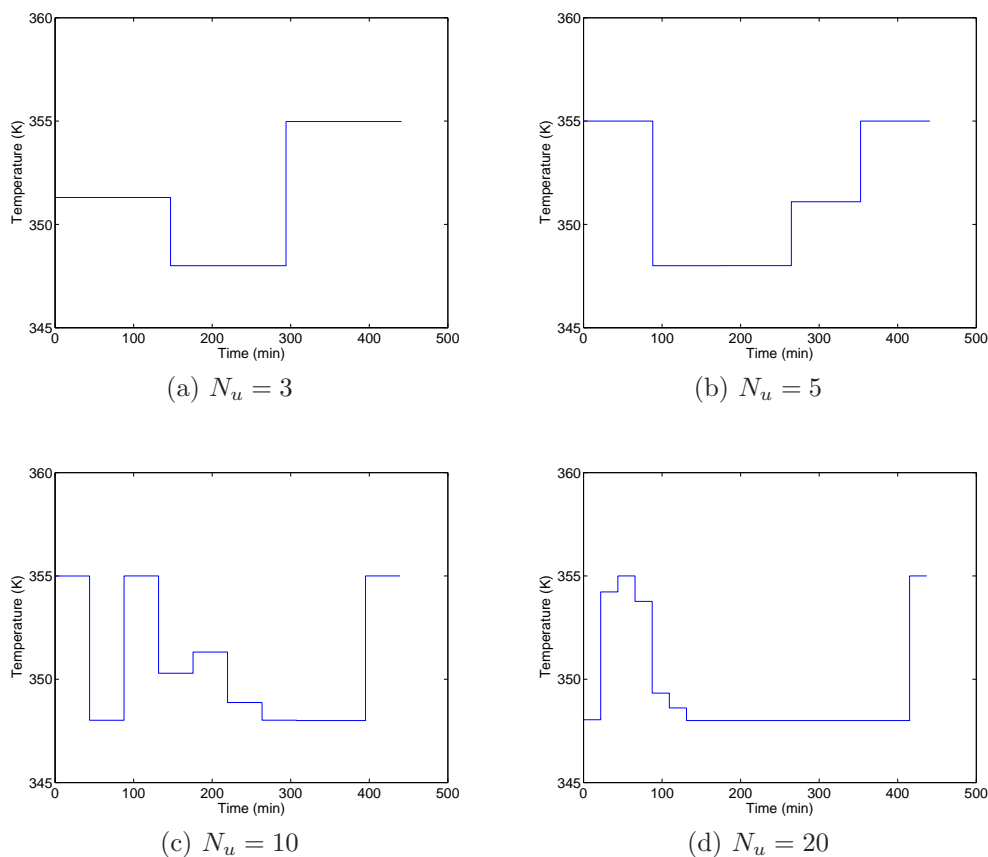

Figure 10: Dynamic optimization case using  $T$  as control variable: Influence of the number of time increments on the optimal temperature profile

247 respectively on the optimal temperature profiles and on the corresponding  
 248 quality results for values of  $N_u$  of 5, 10 and 20. In spite of important vari-  
 249 ations of the temperature profile, it has little influence on the final charac-  
 250 teristics of polymerization. In all the optimization runs, at the end of the  
 251 process, the temperature increases to reduce the variation of the molecular  
 252 weight  $M_n$  and reach the final value close to the corresponding constraint.  
 253 The chain length decreases when temperature increases due to the transfer  
 254 reactions, which induces the entry of radicals to the particles. This results  
 255 finally in instantaneous termination reaction of these radicals inside the par-  
 256 ticles. It must be noted that the same strategy of temperature increase, at  
 257 the end of the operation, is currently used by the operators of the reactor  
 258 at the company. In the same way, Figures 11a, 11c and 11e show that the



259 rate of change of conversion in time is directly proportional to the temper-  
 260 ature. Figures 10a and 10c show that the temperature often switches from  
 261 the lower bound to the upper bound and viceversa, in particular at the start  
 262 and close to the end of the total reaction time. This behaviour is typical  
 263 from minimum time problems and is known as *bang- bang* control (Corriou,  
 264 2004, 2012; Chachuat, 2007). Many systems in chemical engineering and in  
 265 other domains are controlled in on-off mode, in a way similar to *bang-bang*  
 266 control.

267 *2.5. Minimization of batch time with reactor  $T$  and  $q_I$  as control variables*

In the second optimization problem, one additional optimization variable is considered. Here, the initiator flow rate is also used as a control variable due to its large effect on the monomer conversion and molecular properties of the final product. Again, the objective is to minimize the final reaction time, and in consequence the optimal temperature and initiator flow rate profiles are calculated. In this case, the optimization problem is formulated as

$$\begin{aligned}
 \min_{T(t), q_I(t)} \quad & \int_{t_0}^{t_f} dt = t_f - t_0 \\
 \text{s.t.} \quad & \dot{x}_i = f_i(x(t), T(t), q_I(t), t), \quad i = 1, \dots, 7 \\
 & \text{and } \forall t \in [t_0, t_f] \quad \text{state model} \\
 & x_1(t_0) = 5, \quad \text{initiator moles} \\
 & x_2(t_0) = 4000, \quad \text{total monomer moles} \\
 & x_3(t_0) = 4000, \quad \text{residual monomer moles} \\
 & x_i(t_0) = 0, \quad i = 4, \dots, 7 \quad \text{initial conditions} \\
 & x_f \geq 0.99, \quad \text{final conversion} \\
 & M_{n_f} \geq 2.1 \times 10^5, \quad \text{final number average molecular weight} \\
 & \phi_S \geq 49\%, \quad \text{final solids content} \\
 & 348K \leq T(t) \leq 355K, \quad \text{temperature interval} \\
 & q_I(t) \leq 0.8 \times 10^{-3} \text{mol/s}, \quad \text{initiator flow rate interval}
 \end{aligned} \tag{13}$$

268 The constant monomer flow rate injected during the fed-batch stage start-  
 269 ing at  $t = 70$  min takes the same value as in section 2.4. Initiator flow rate  
 270 and temperature are used as control variables according to the optimization  
 271 problem formulated in equation (13). In the first part of the reaction, the  
 272 process is operated in batch mode, with respect to the monomer input. A  
 273 scheme of the operation is shown in Figure 12. As in the first problem, a

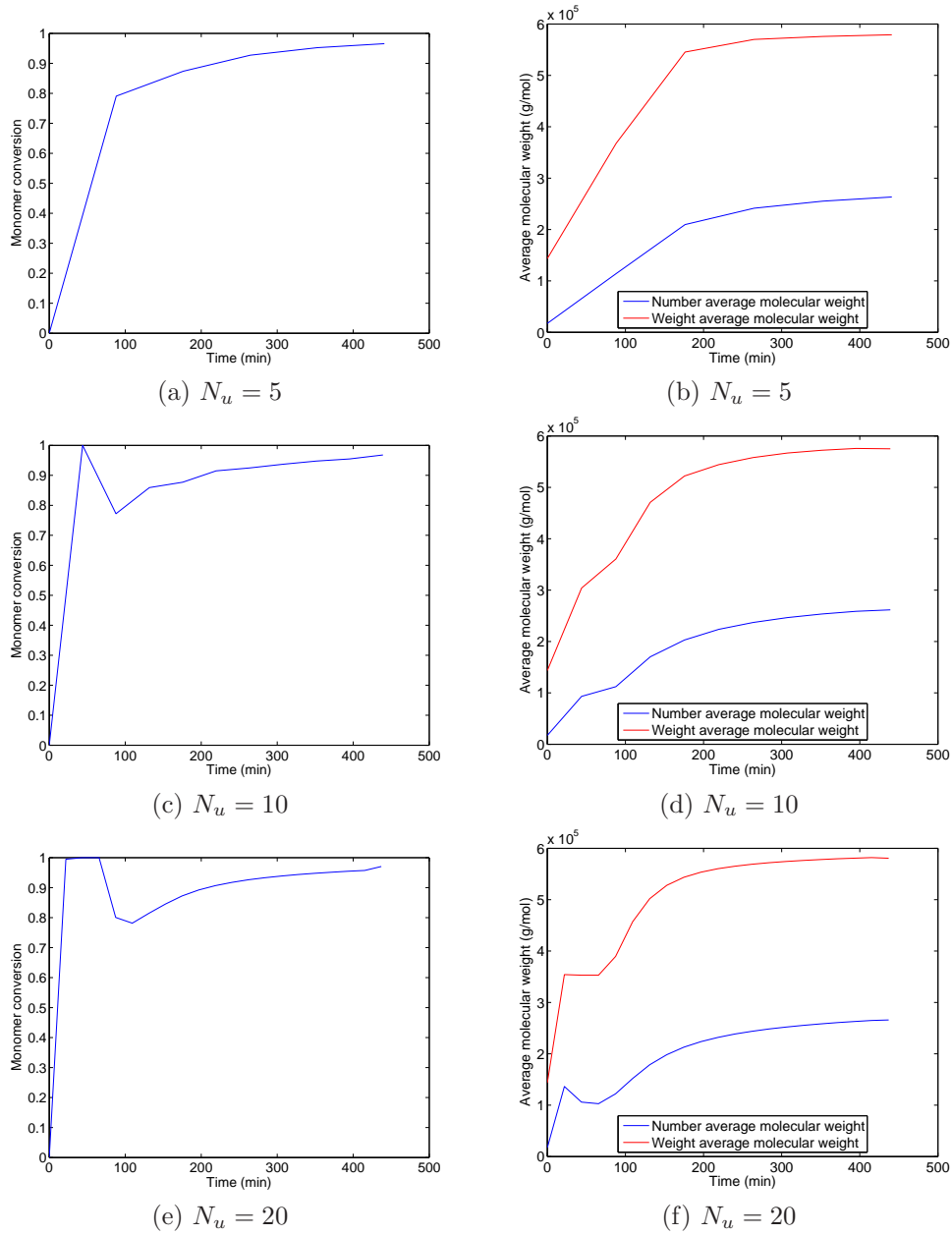

Figure 11: Dynamic optimization case using  $T$  as control variable: Quality results. Left column: monomer conversion. Right column: average molecular weight.

274 piecewise discretization using 3, 5, 10 and 20 control segments was studied.

Table 4: Dynamic optimization case using  $T$  and  $q_I$  as control variables: Optimization results

$N_u$	$t_f$ (s)	$x_f$	$M_{n,f} \times 10^{-5}$	$M_{w,f} \times 10^{-5}$	$D$
3	29510	0.9900	2.1654	4.9164	2.27
5	29527	0.9901	2.2398	5.1804	2.31
10	28872	0.9900	2.1155	4.8532	2.29
20	27118	0.9900	2.2825	5.2814	2.31

275 Table 4 shows the results for the four optimization runs. For this second dy-  
 276 namic optimization problem, the constraint of the minimum conversion was  
 277 increased from 95% to 99%. For this reason, the final times are slightly larger  
 278 than those obtained previously. However, the conversion has been increased  
 279 importantly which is beneficial for the process efficiency. The reaction times  
 280 calculated here are approximately 9% lower than the typical reaction time  
 in the plant, thus improving the productivity of the process.

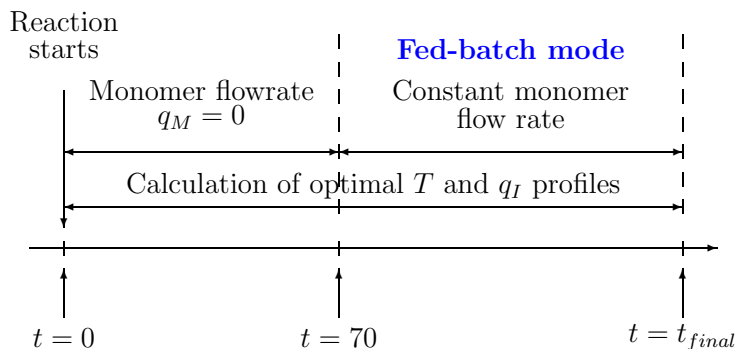

Figure 12: Dynamic optimization case using  $T$  and  $q_I$  as control variables: Scheduling of operations

281 Again, it can be noted that the total reaction time decreases with the  
 282 increase of  $N_u$ , but the final values of the average molecular weight and the  
 283 dispersity of the polymer do not vary significantly.

285 Figures 13 and 14 show the optimal temperature profile and optimal ini-  
 286 tiator flow rate profile, respectively. Again, the *bang-bang* control tendency  
 287 is observed for the temperature and a similar behaviour is observed for the  
 288 initiator when  $N_u = 20$  (Figure 14d). Also, the multivariable nature of the  
 289 system is observed. The initiator flow rate and the reaction temperature  
 290 appear to be correlated. In the first half of the operation, the tendency is

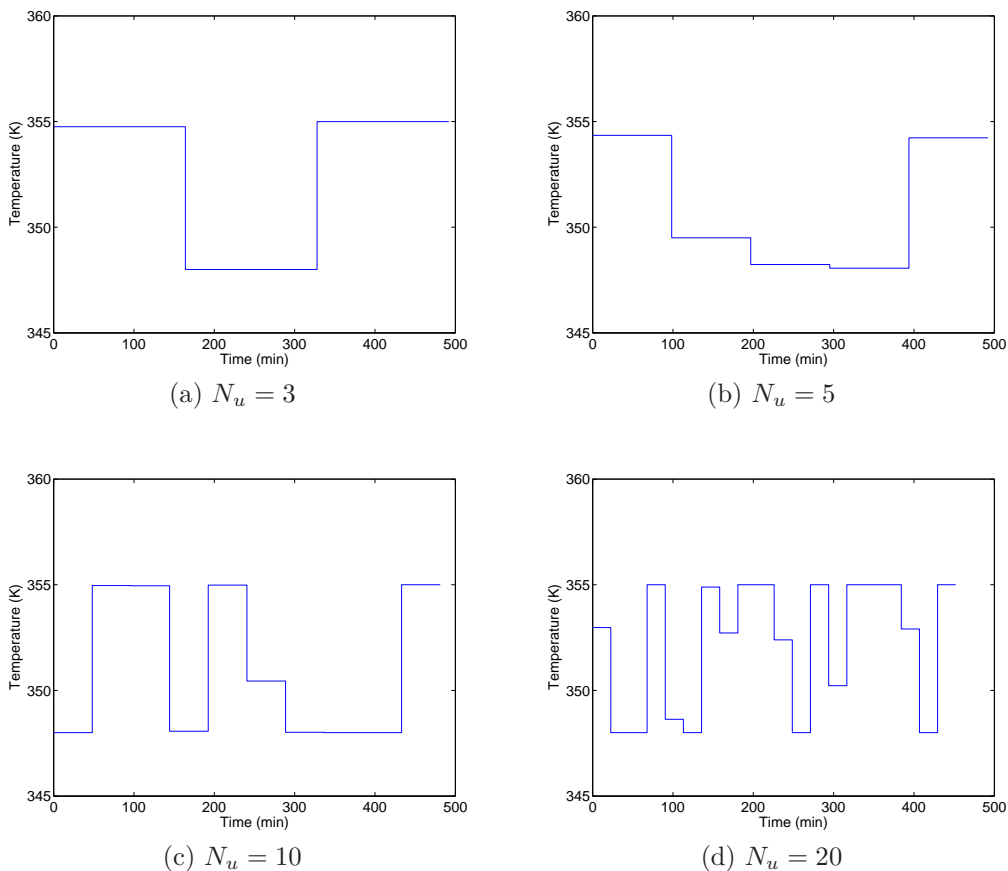

Figure 13: Dynamic optimization case using  $T$  and  $q_I$  as control variables: Optimal temperature profile

291 marked by low values of initiator flow rate and intermediate values of the  
 292 temperature. In the second half, additional injections of initiator are cal-  
 293 culated and often compensated by temperature decreases. However, it is  
 294 difficult to observe only one specific response, taking into account that dif-  
 295 ferent discretization scenarios exist and interactions occur at the same time.  
 296 When the initiator flow rate is increased, the chain growth rate decreases be-  
 297 cause more monomer can react with the additional initiator to promote more  
 298 initiation reactions instead of propagation of the polymer chain. Finally, in  
 299 order to control the last part of the reaction, temperature and initiator flow  
 300 rate increase so that the final average molecular weight and conversion sat-  
 301 isfy the final constraints. The increases of temperature and initiator in the

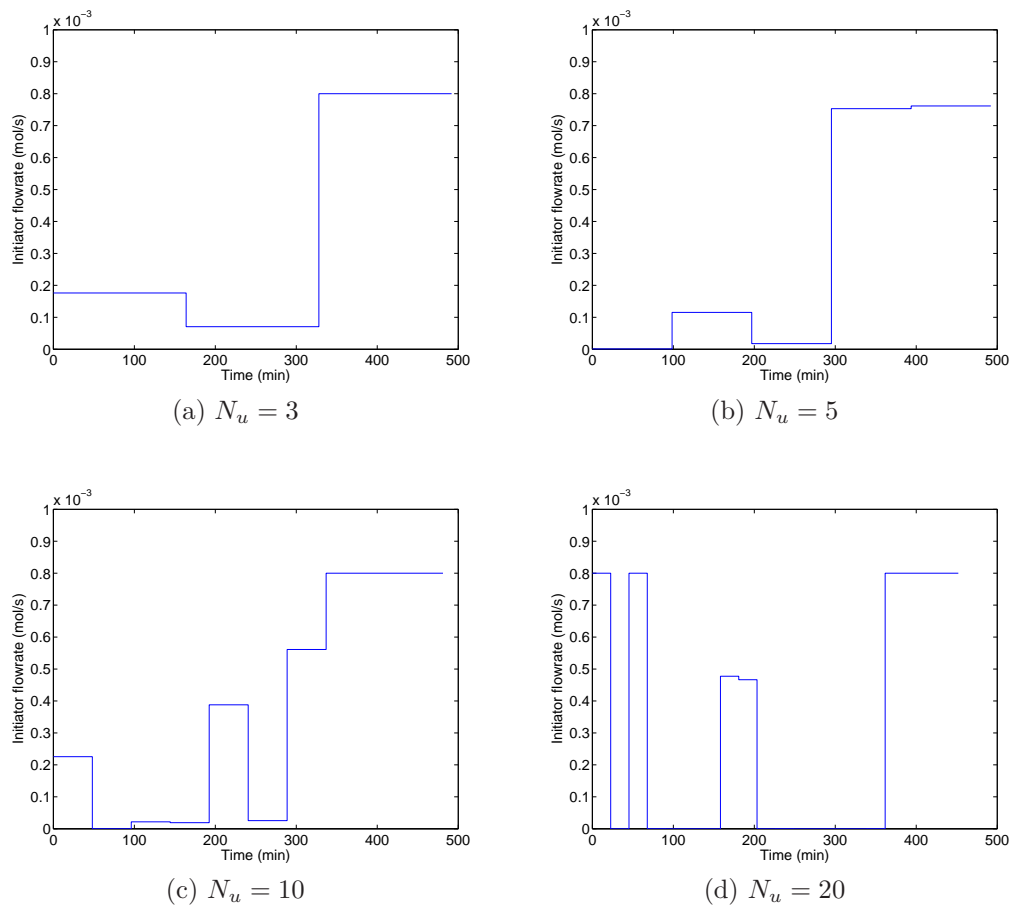

Figure 14: Dynamic optimization case using  $T$  and  $q_I$  as control variables: Optimal initiator flow rate profile

302 reactor increase the polymerization rate and the conversion, and reduce the  
 303 final molecular weight (Figure 15).

304 *2.6. Minimization of batch time with  $T$ ,  $q_I$  and  $q_M$  as control variables*

The third optimization problem involves three control variables: temperature, initiator flow rate and monomer flow rate. These three variables are easily controlled in the industrial reactor and therefore are susceptible to be changed at the same time to achieve a desired performance of the reactor. Taking into account that vinyl acetate has a high rate of radical transfer to polymer, the monomer feed flow rate has an important effect on the molecular weight. For that reason, it is also considered in this optimization case

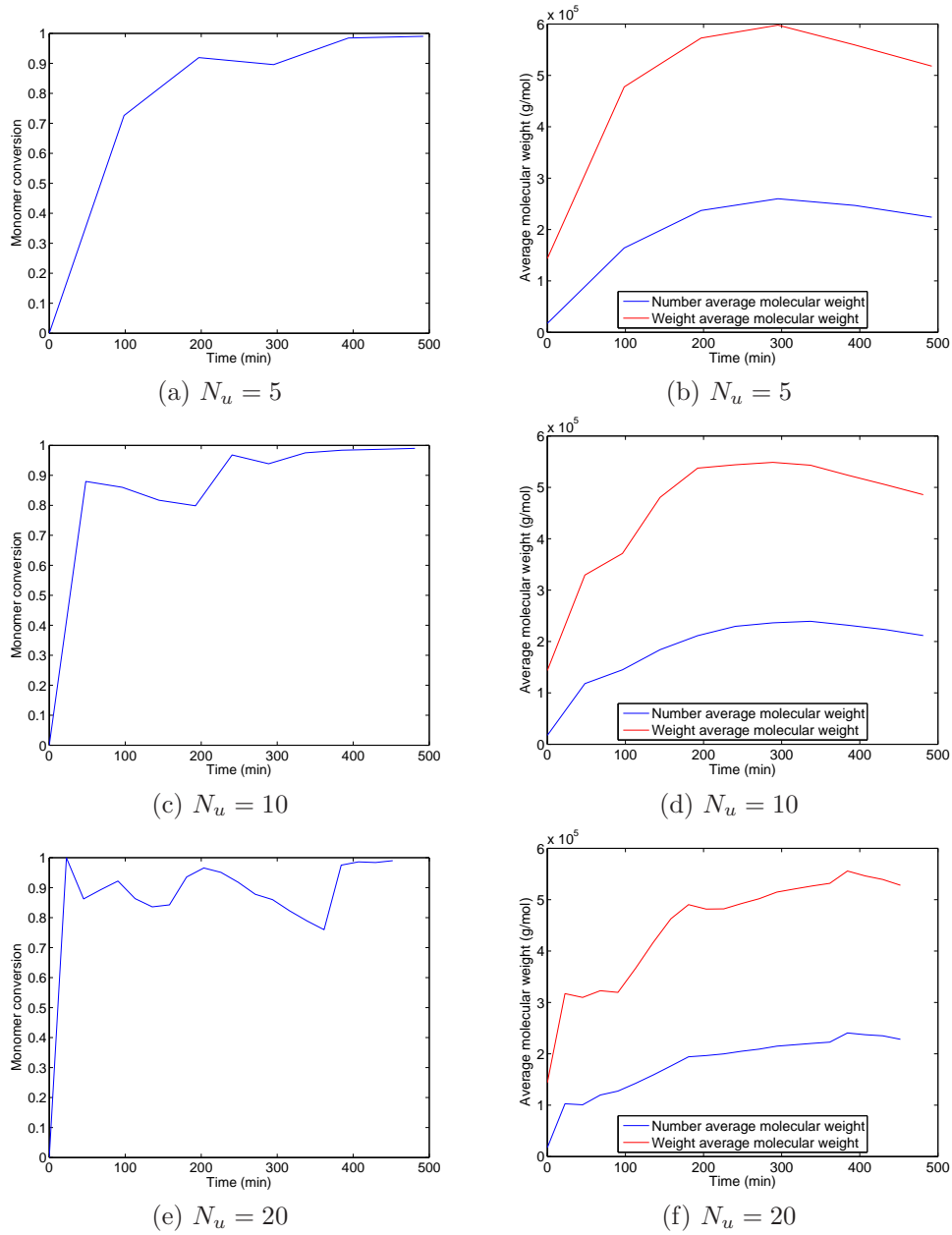

Figure 15: Dynamic optimization case using  $T$  and  $q_I$  as control variables: Quality results. Left column: monomer conversion. Right column: average molecular weight.

as a control variable. The optimization problem is formulated as

$$\begin{aligned}
 & \min_{T(t), q_I(t), q_M(t)} \int_{t_0}^{t_f} dt = t_f - t_0 \\
 & \text{s.t.} \quad \dot{x}_i = f_i(x(t), T(t), q_I(t), q_M(t), t) \quad i = 1, \dots, 7 \\
 & \quad \text{and } \forall t \in [t_0, t_f] \quad \text{21 st. model} \\
 & \quad x_1(t_0) = 5, \quad \text{initiator moles} \\
 & \quad x_2(t_0) = 4000, \quad \text{total monomer moles} \\
 & \quad x_3(t_0) = 4000, \quad \text{residual monomer moles} \\
 & \quad x_i(t_0) = 0, \quad i = 4, \dots, 7 \quad \text{initial conditions} \\
 & \quad x_f \geq 0.992, \quad \text{final conversion} \\
 & \quad \bar{M}_{n_f} \geq 2.2 \times 10^5, \quad \text{final number average molecular weight} \\
 & \quad \phi_S \geq 50\%, \quad \text{final solids content} \\
 & \quad 348K \leq T(t) \leq 355K, \quad \text{temperature interval} \\
 & \quad q_I(t) \leq 0.8 \times 10^{-3} \text{mol/s}, \quad \text{initiator flow rate interval}
 \end{aligned}$$

305 The monomer flow rate, initiator flow rate and temperature profiles were  
 306 determined according to the dynamic optimization problem formulated in  
 307 equation (14). In this case, fed-batch operation mode is used as the unique  
 308 operation mode for the dynamic optimization calculations (Figure 16). As  
 309 in the two last cases, a piecewise discretization using 3, 5, 10 and 20 control  
 310 segments was studied. Table 5 shows the results for the four optimization  
 311 runs. The final conversion constraint here is slightly higher than the con-  
 312 version constraint used in the dynamic optimization based on temperature  
 313 and initiator flow rate as control variables. This is mentioned because the  
 314 final time obtained here is lower than the minimum time calculated in the  
 315 two previous cases where the conversion constraint was lower as well as the  
 316 constraints of molecular weight and solids content. The most interesting re-  
 317 sult of this optimization case is the final time obtained when using 10 and  
 20 piecewise controls.

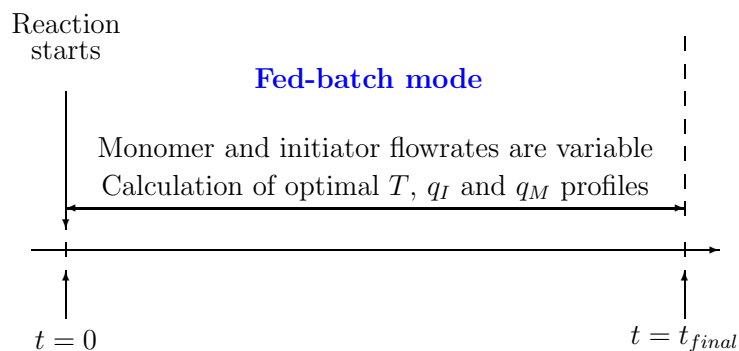

Figure 16: Dynamic optimization case using  $T$ ,  $q_I$  and  $q_M$  as control variables: Scheduling of operations

318  
 319 In this case, the influence of the number of time intervals or piecewise  
 320 controls used is more evident because more degrees of freedom exist that  
 321 promote interactions during the reaction. This multivariable problem with  
 322 three control variables allows the optimization solver to more easily find  
 323 optimal operating values of the process variables which minimize the total  
 324 reaction time. Specifically, in the case of 20 piecewise controls, a total time  
 325 of 23762 seconds is obtained (Figure 17). This optimal final time is at least  
 326 20% lower than the current batch time used in the plant to perform this  
 327 polymerization.

328 Optimal profiles are shown in Figures 17, 18 and 19 for temperature,  
 329 initiator flow rate and monomer flow rate, respectively. The influence of

Table 5: Dynamic optimization case using  $T$ ,  $q_I$  and  $q_M$  as control variables: Optimization results

$N_u$	$t_f$ (s)	$x_f$	$M_{n,f} \times 10^{-5}$	$M_{w,f} \times 10^{-5}$	$D$
3	29338	0.9920	2.4041	5.6376	2.34
5	28426	0.9920	2.6186	6.0685	2.32
10	26678	0.9920	2.1999	5.1265	2.33
20	23762	0.9920	2.2000	5.1171	2.32

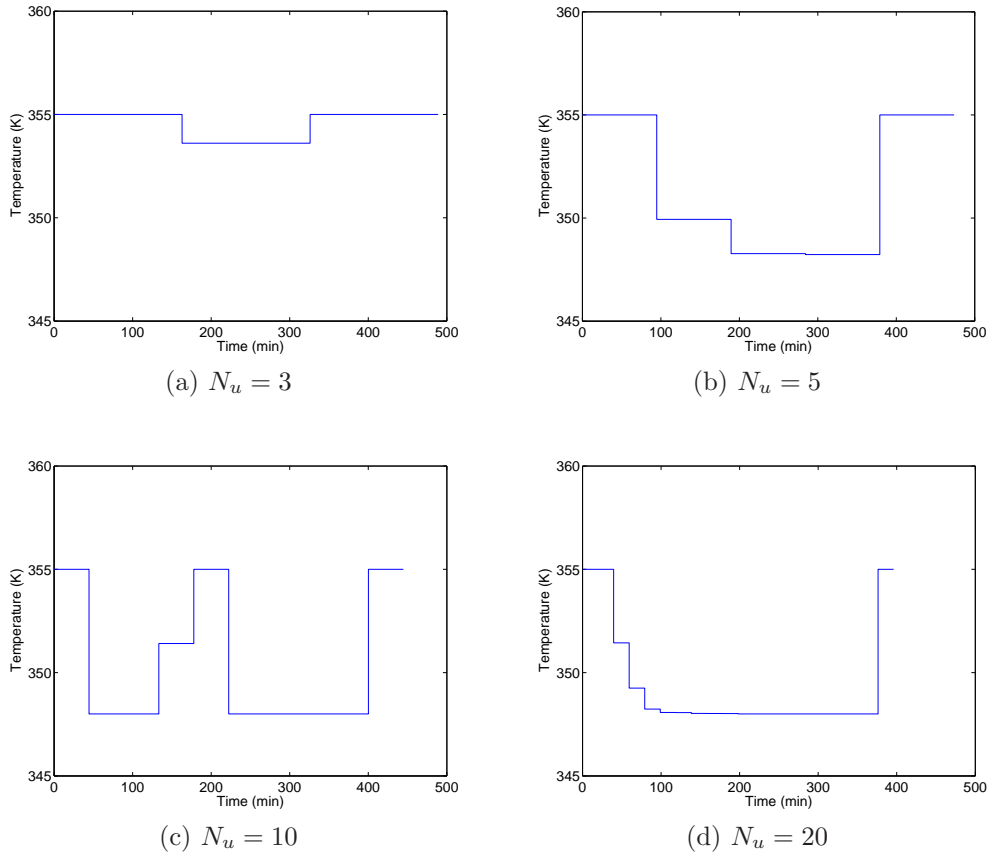

Figure 17: Dynamic optimization case using  $T$ ,  $q_I$  and  $q_M$  as control variables: Optimal temperature profile

330 increasing the initiator flow rate on the polymerization rate can be noticed  
 331 in Figures 18b, 18c and 18d, and Figures 20a, 20c and 20e. In these two  
 332 cases, the initiator flow rate is augmented at a reaction time of 200 min, and



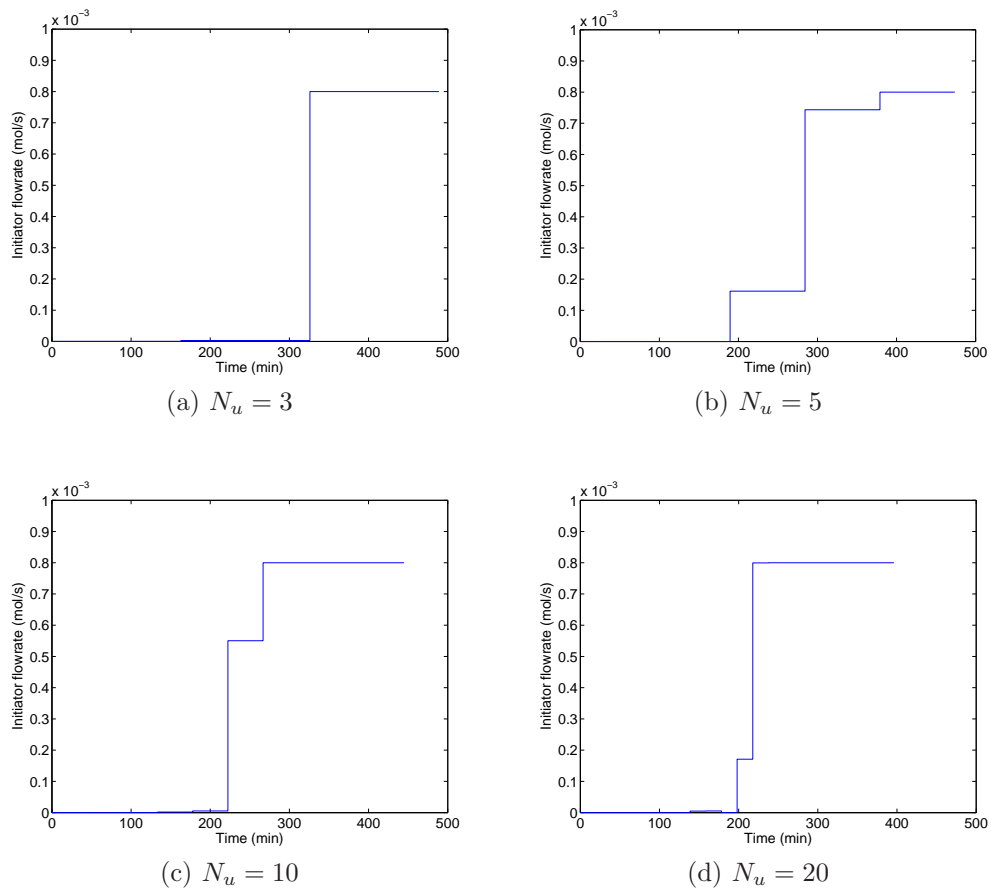

Figure 18: Dynamic optimization case using  $T$ ,  $q_I$  and  $q_M$  as control variables: Optimal initiator flow rate profile

333 immediatly the conversion increases. The initiator flow rate is maintained  
 334 at low values (close to zero) during the first part of the operation in which  
 335 monomer is being fed, and only in the last part of the operation, the initiator  
 336 flow rate is increased in order to accelerate the polymerization and reduce  
 337 the final content of monomer (Figure 18). At the same time, the monomer  
 338 flow rate is maintained at high values, close or equal to the upper bound,  
 339 during the major part of the reaction, and finally is decreased when the  
 340 polymerization is ending (Figure 19). In the real plant operation, the initiator  
 341 is fed almost continuously and this differs largely from the optimal policy  
 342 obtained by dynamic optimization where some initiator is fed at the end  
 343 of the reaction. Also, in the real plant, reactor temperature is maintained

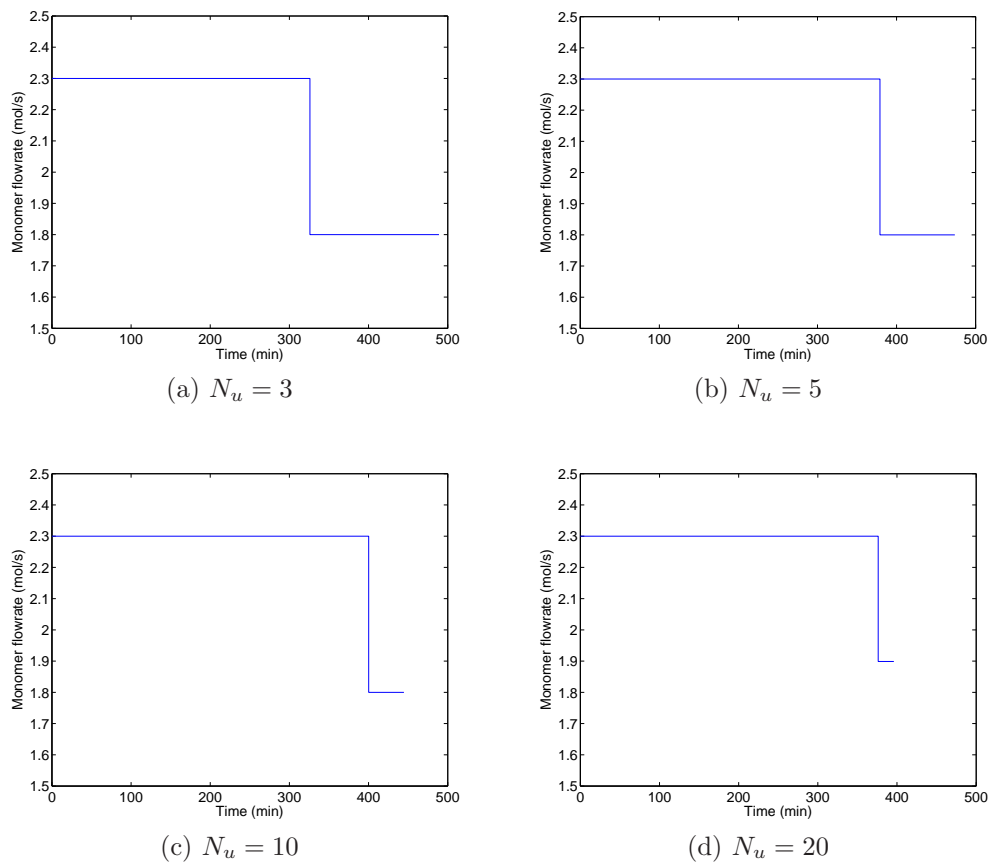

Figure 19: Dynamic optimization case using  $T$ ,  $q_I$  and  $q_M$  as control variables: Optimal monomer flow rate profile

344 approximately constant by manual operation during the reaction without  
 345 using the jacket, but only by means of the sensible heat of the monomer  
 346 and initiator fed to the reactor. In the present study, the proposition will  
 347 be to use the jacket for heat exchange, but to feed the reactor in monomer  
 348 and initiator according to the optimal policy and control the temperature  
 349 by means of a nonlinear controller. In the same way as the initiator takes  
 350 a maximum value just before the final time, it can also be noticed that the  
 351 temperature increases to its upper bound during the final control segment  
 352 also trying to reduce the residual monomer of the polymer (Figure 17).

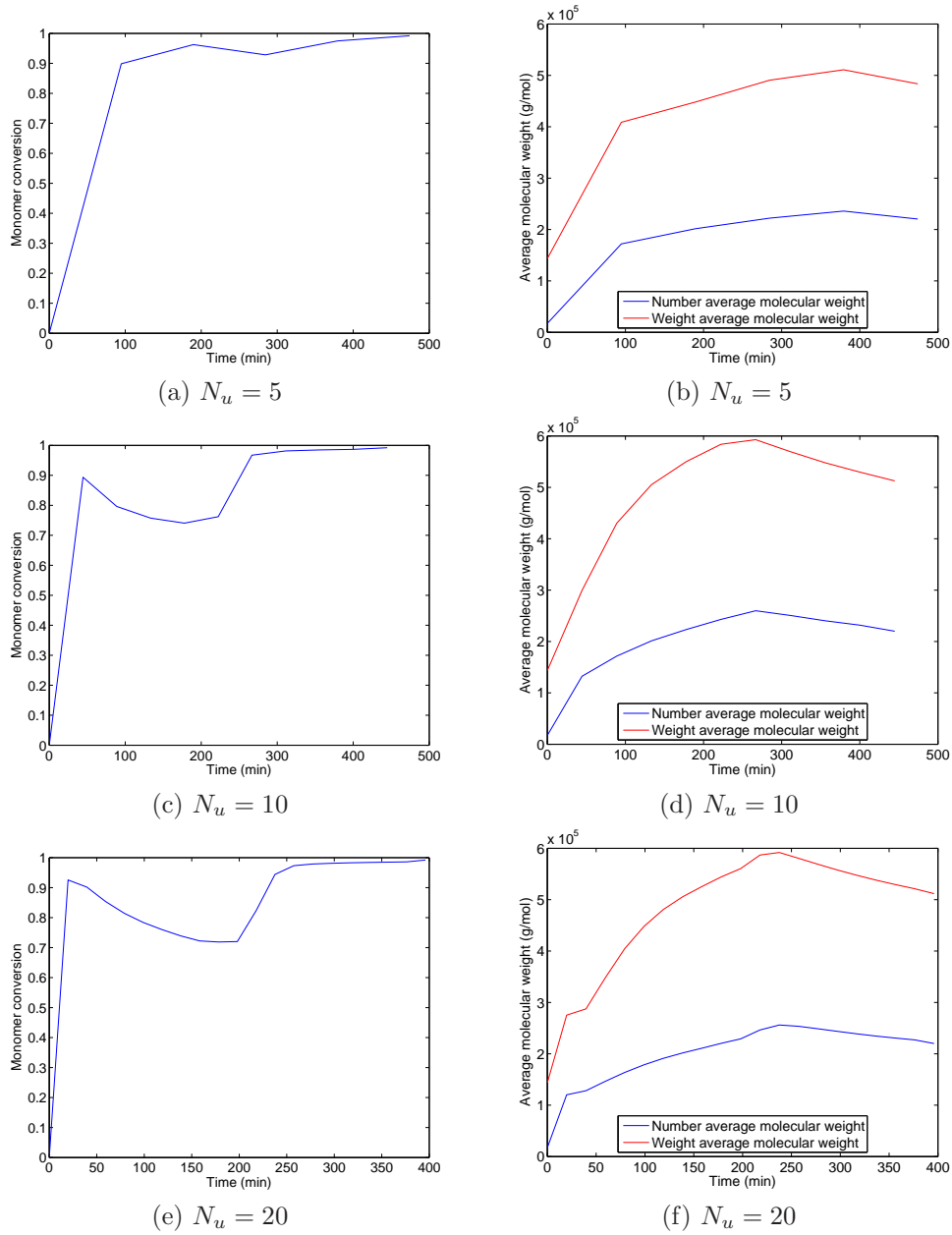

Figure 20: Dynamic optimization case using  $T$ ,  $q_I$  and  $q_M$  as control variables: Quality results. Left column: monomer conversion. Right column: average molecular weight

### 353 3. Nonlinear geometric control and state estimation

354 In this section, a nonlinear geometric temperature controller is applied to  
 355 the industrial emulsion polymerization reactor. Temperature is controlled by

356 a nonlinear controller designed in our previous work (Gil et al., 2014). The  
 357 optimal temperature profile calculated in the last section is used here as the  
 358 set point of the temperature control loop. The optimal feed policies of ini-  
 359 tiator and monomer are also used here as set points supposing an automatic  
 360 regulatory control for these two flow rates. Figure 21 shows a schematic rep-  
 361 resentation of the control loops and the use of dynamic optimization results.  
 362 Conversion and polymer quality results obtained are compared with those  
 corresponding to the current operation data.

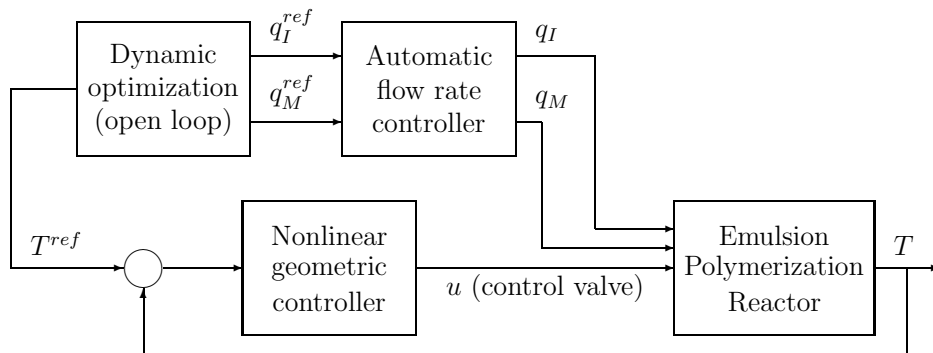

Figure 21: Schematic representation of the control of the emulsion polymerization reactor

363

364

365

366

367

368

369

The controlled output is the temperature of the reactor contents  $T$ . The position  $u$  of a three-way valve is used as a manipulated input that imposes the respective flow rates through the cold and hot heat exchangers so that the inlet coolant temperature  $T_{jin}$  could also be considered as the manipulated variable. Thus, the controlled system is reduced to Single Input Single Output.

Two models are used, on one side a complete detailed model considered as the plant describing the dynamic reactor behavior and the polymerization reaction, including the moments of the polymer chains described in eqs (5-7). On the other side, in order to simplify the nonlinear geometric control law and the state estimation, a reduced model is built with the following reduced state vector for control and estimation

$$\mathbf{x} = (I, M_t, M_M, V_{pol}, T, T_j) \quad (15)$$

370

371

372

where the three moments of the polymer chains are not taken into account (Gil et al., 2014). Among these states,  $I$ ,  $M_t$  and  $V_{pol}$  are not observable and they are only predicted, i.e. they are obtained by simple integration of the

373 differential equations without correction. The continuous-discrete extended  
374 Kalman filter is implemented to estimate the three states  $M_M, T, T_j$  which  
375 are used in the nonlinear control law. The controller and the observer share  
376 the same input and output. It must be noted that the state estimations or  
377 predictions which are provided are useful also for monitoring of the reactor.  
378 The details of the extended Kalman filter as well as the nonlinear control law  
379 are presented in Gil et al. (2014).

### 380 *3.1. Control under optimal conditions*

381 Now, it is important to show that a nonlinear geometric controller is ca-  
382 pable of tracking the optimal temperature trajectories with the combined use  
383 of the optimal feed policies calculated for the initiator and the monomer. It  
384 must be noted that the dynamic optimization was performed in open loop  
385 using only the kinetic model without the energy balances of the reactor. The  
386 nonlinear controller of course makes use of the same kinetic model but with  
387 the energy balances. Thus, apart from the study of temperature tracking, it  
388 will be interesting to compare the various characteristics of the polymer ob-  
389 tained in open loop and in closed loop, such as viscosity, conversion, number  
390 average molecular weight.

### 391 *3.2. Optimal temperature control with optimal feed policies ( $q_I$ and $q_M$ )*

392 The most interesting result of the dynamic optimization study is the  
393 minimization of the reaction time (maximization of productivity). Now, it  
394 will be supposed that the reactor is operated under the operating conditions  
395 found in section 2.6 and following the recipe defined for the industrial op-  
396 erating conditions in Table 2. The case of the dynamic optimization using  
397 also the three control variables and  $N_u$  equal to 20 is discussed here. The  
398 nonlinear geometric controller presents a good performance for tracking the  
399 temperature trajectory calculated by means of dynamic optimization (Figure  
400 22a). At the end of the operation, the temperature increases up to the upper  
401 limit (355 K) and also the initiator flow rate is increased in order to end the  
402 reaction and satisfy the final constraints (Figure 22a).

403 The controller works well to remove the reaction heat (Figure 22e) and  
404 maintain the temperature close to the optimal set point previously estab-  
405 lished (Figure 22a). After preheating stage (the first 80 min) where the seed  
406 is formed, the monomer conversion increases up to 99.2% as in the dynamic  
407 optimization problem. It is interesting to note that, according to the dy-  
408 namic optimization results, the temperature is maintained at the minimum

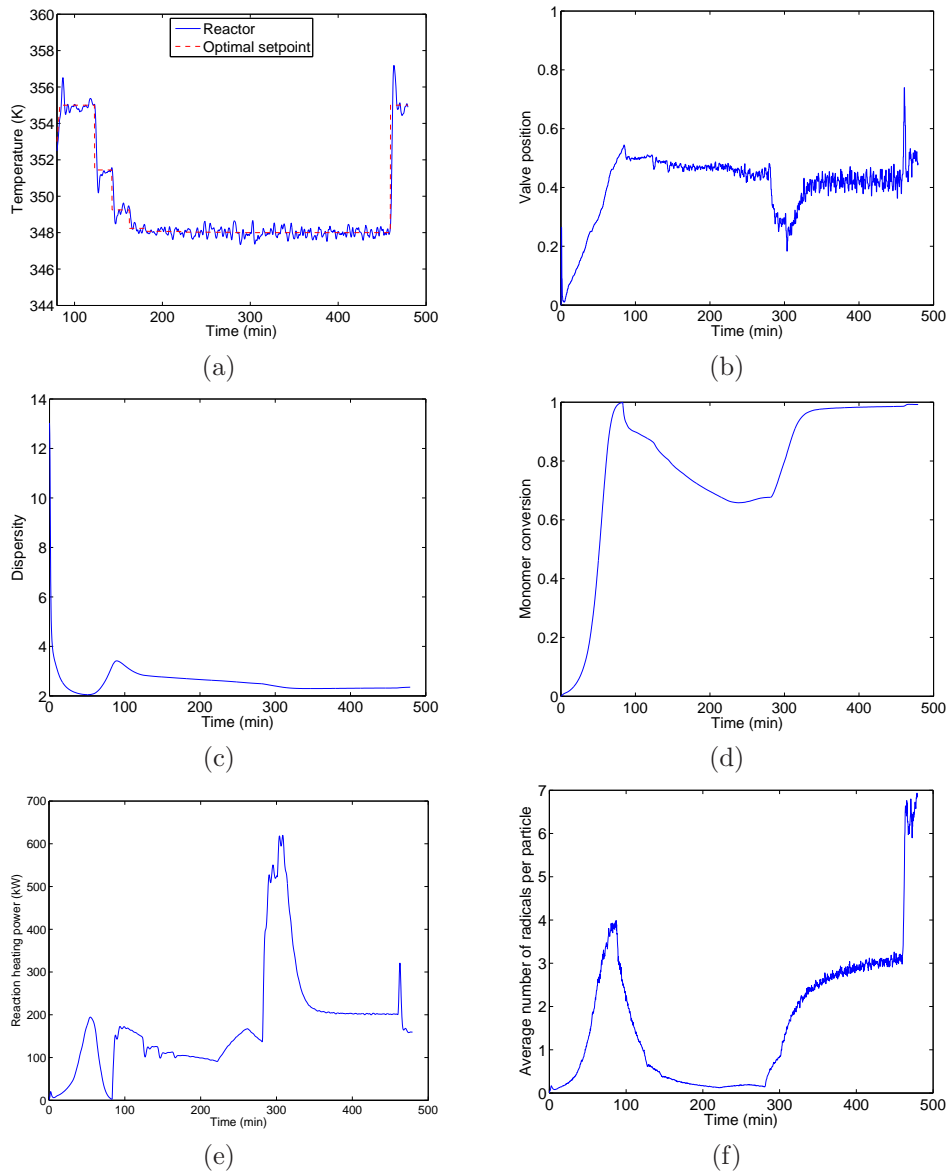

Figure 22: Nonlinear geometric control of the emulsion polymerization reactor with time minimization using  $q_I$ ,  $q_M$  and  $T$  as optimization variables and  $N_u = 20$ . a) Optimal temperature profile b) Valve position; c) Dispersity d) Monomer conversion; e) Reaction power f) Average number of radicals per particle

409 constraint during a large part of the operation. Only in the last part, the  
 410 temperature is increased rapidly in order to end the reaction. The initia-

411 tor flow rate also increases at the end of the reaction to satisfy the final  
 412 constraints related with the final molecular weight. This demands an addi-  
 413 tional effort from the controller which is compensated, in principle, by the  
 414 control valve (Figure 22b) but also it compensates the release of an impor-  
 415 tant additional quantity of heat (Figure 22e). However, it is clear that the  
 416 controller is capable of following the temperature setpoint. Consequently,  
 417 the desired conversion and quality results are obtained. Another interesting  
 418 observation from Figure 22f is that the average number of radicals per par-  
 419 ticle  $\bar{n}$  increases importantly at the end of the operation, due to the final  
 420 large injection of initiator calculated by the optimization. The low radical  
 421 desorption rate with respect to radical entry rate produces a large increase  
 422 of the heat released by the reaction and, simultaneously, the viscosity at the  
 423 end of the operation increases up to 1200 P, limiting the mobility of radicals  
 424 and favoring the increase of the temperature. All these observations could  
 425 indicate a gel effect phenomenon which also accompanies final conversions  
 426 as high as 99.2%. However, again, this is satisfactorily managed by the con-  
 427 troller as it can be observed in the last 20 minutes in Figure 22a. Table 6  
 428 summarizes the constraints established in two of the dynamic optimization  
 429 cases studied and the results obtained with the application of the nonlinear  
 430 control to these optimal scenarios. It can be noted that, in all the cases, the  
 431 constraints previously defined in dynamic optimization calculations are also  
 satisfied when applying the nonlinear control to the simulated plant.

Table 6: Results for the constraints established in the dynamic optimization. CDO: Con-  
 straint in Dynamic Optimization, CS: Control simulation

$N_u$	Number average molecular weight		Final conversion		Solids content (%)	
	CDO	CS	CDO	CS	CDO	CS
5	$2.2 \times 10^5$	$2.259 \times 10^5$	0.992	0.9921	50	53.1
20	$2.2 \times 10^5$	$2.269 \times 10^5$	0.992	0.992	50	50

432

### 433 3.3. Robustness tests

434 The robustness of the nonlinear controller coupled with state estimation  
 435 is studied with respect to typical modeling errors or real situations found  
 436 in the normal plant operation. For that purpose, the rigorous model of the  
 437 plant, representing the process, remains the same as it was defined in section  
 438 2.1 while the simplified model used in control calculations is modified by  
 439 introducing modeling errors. Four different scenarios were supposed: errors

440 about the propagation reaction constant, heat of reaction and heat transfer  
441 coefficient values, and a change in the temperature of the coolant used in  
442 the reactor cooling. In the first robustness test, it was assumed that the  
443 propagation constant is reduced by 50% with respect to its real value. Thus,  
444 the reaction rate calculated in the reduced model of the state estimator is  
445 lower than the real rate of the process, and therefore also the estimation of the  
446 reaction heat produced. The second test consisted in increasing by 50% the  
447 value of the heat of the reaction reducing the exothermicity of the reaction.  
448 In the third robustness test, it was assumed that the heat transfer coefficient  
449  $U$  is decreased by 40% with respect to its real value. This is representative  
450 of changes due to equipment fouling and variations in the viscosity and the  
451 solids content of the reacting mixture that also affect the value of  $U$ . Finally,  
452 in the last test, the coolant temperature was increased from 293 to 300 K  
453 simulating a failure in the cooling tower of the plant. Thus, the value of the  
454 inlet jacket temperature considered in the reduced model is erroneous and  
455 this influences the energy balances.

456 The main effect of these robustness tests is observed about the estimated  
457 monomer conversion (Figure 23). In the first 300 minutes, the difference  
458 between the estimated monomer conversion and the real value is slight for  
459 the cases where errors about heat transfer coefficient (Figure 23a) and heat  
460 of reaction (Figure 23b) were introduced. In spite of important differences  
461 with respect to the real values, the controller works well and the monomer  
462 conversion is well estimated. On the other way, the errors due to the change  
463 in the coolant temperature and propagation rate constant are more important  
464 with differences around 10% at maximum compared with the actual monomer  
465 conversion. Globally, the same tendency is maintained up to 300 minutes,  
466 but, in the last part of the operation (between 300 and 500 minutes), the  
467 deviation between the estimated and calculated values is large in three of  
468 the four cases. This deviation is caused by the addition of an important  
469 quantity of initiator at time  $t = 300$  min. The initiator accelerates the  
470 reaction, an additional quantity of heat is released and the average number  
471 of particles also increases promoting a gel effect in the system. Also, it should  
472 be mentioned that, in the last part of the operation, the solids content and  
473 viscosity increase importantly modifying heat and mass transfer coefficients.  
474 However, a good temperature control is achieved in all cases (Figure 24)  
475 demonstrating the efficiency of nonlinear control and its robustness.



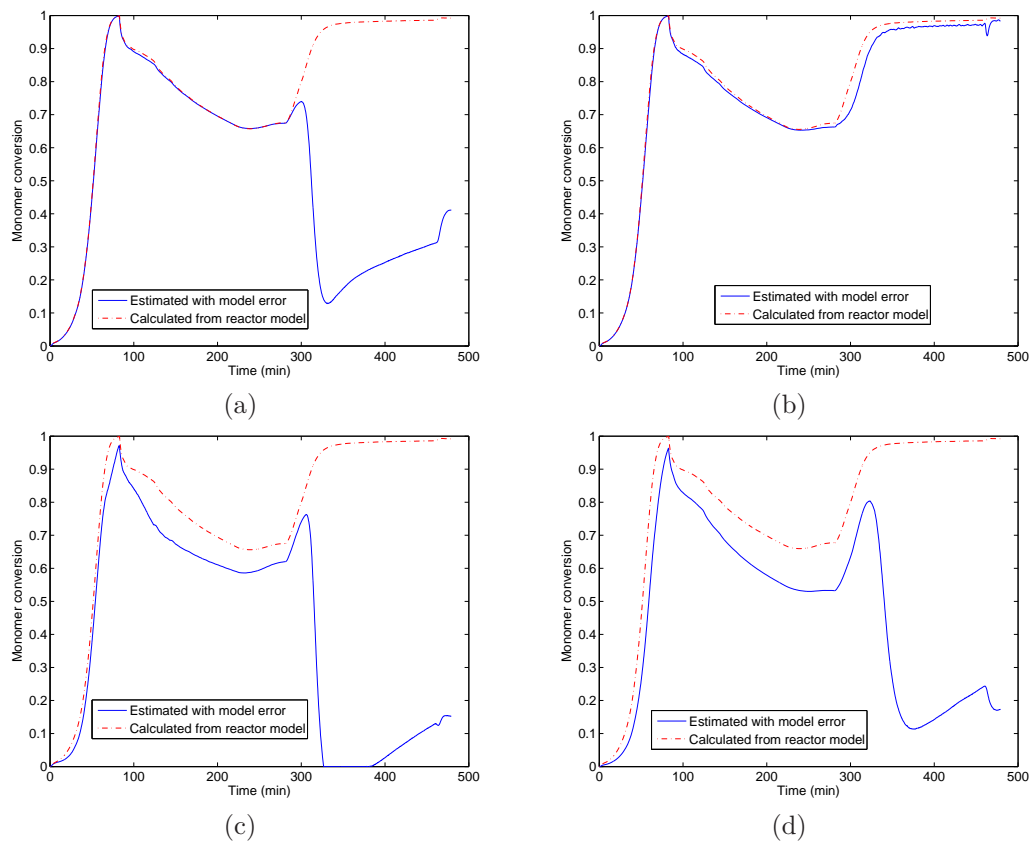

Figure 23: Influence of the robustness tests on the monomer conversion. a) Heat transfer coefficient error; b) Reaction heat error; c) Coolant temperature error; d) Propagation constant error

476 **4. Conclusion**

477 The dynamic optimization of the emulsion polymerization of vinyl acetate  
 478 was studied. Three different optimization scenarios were established from  
 479 the more simplistic (only one control variable) to the more complex (three  
 480 control variables) in order to minimize the reaction time. Constraints are  
 481 imposed with respect to some polymer desired qualities (conversion, molec-  
 482 ular weight and solids content) as well as allowed flow rates and reactor  
 483 temperature. Piecewise constant profiles were assumed and the influence of  
 484 time discretization was studied. The influences of initiator, temperature and  
 485 monomer were identified. In all the cases, the control variables often change  
 486 during the batch according to the well-known *bang-bang* effect, typical of

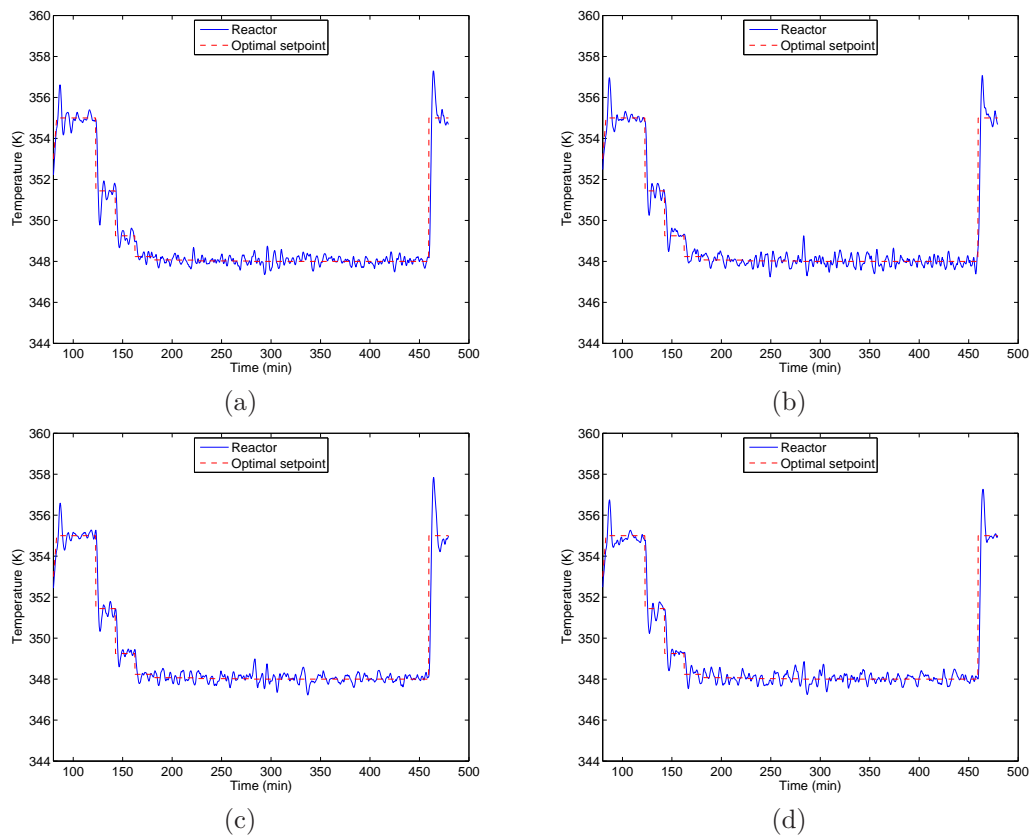

Figure 24: Influence of the robustness tests on the reactor temperature control. a) Heat transfer coefficient error; b) Reaction heat error; c) Coolant temperature error; d) Propagation constant error

487 minimum time dynamic optimization problems. It can be noticed that the  
 488 most efficient results are obtained when three variables, i.e.  $T$ ,  $q_I$  and  $q_M$  are  
 489 simultaneously used as control variables. A reduction of 20% of the batch  
 490 time was achieved with respect to the normal operating conditions applied  
 491 at the chemical company.

492 A nonlinear controller was used to track the temperature in the polymer-  
 493 ization reactor in spite of typical disturbances such as initiator and monomer  
 494 injections. The optimal temperature profile, obtained by a dynamic opti-  
 495 mization study, was used as the set point for the nonlinear control. In the  
 496 same time, the optimal feed policies of monomer and initiator were followed  
 497 by means of a regulatory control of their flow rates. The results show that

498 the nonlinear controller is appropriate to track the optimal temperature tra-  
 499 jectories calculated previously. Also, the final temperature increase due to  
 500 the initiator injection is rapidly corrected by the controller action making  
 501 the operation of the reactor safer while, at the same time, the productivity  
 502 is improved satisfactorily.

### 503 **Acknowledgement**

504 The financial support of the Embassy of France, Colfuturo and Universi-  
 505 dad Nacional de Colombia is greatly acknowledged.

### **Nomenclature**

$C_{pj}$	Specific heat of component $j$ [ $\text{J.K}^{-1}.\text{kg}^{-1}$ ]
$I$	Moles of initiator in the reactor [mol]
$k_{fm}$	Rate constant for chain transfer to monomer [ $\text{m}^3.\text{mol}^{-1}.\text{s}^{-1}$ ]
$k_{fp}$	Rate constant for chain transfer to polymer [ $\text{m}^3.\text{mol}^{-1}.\text{s}^{-1}$ ]
$k_t$	Termination rate constant [ $\text{m}^3.\text{mol}^{-1}.\text{s}^{-1}$ ]
$k_I$	Overall initiation rate constant [ $\text{s}^{-1}$ ]
$M_M$	Moles of monomer in the reactor [mol]
$\bar{M}_n$	Number average molecular weight [ $\text{g.mol}^{-1}$ ]
$\bar{M}_w$	Weight average molecular weight [ $\text{g.mol}^{-1}$ ]
$M_t$	Total moles of monomer fed to the reactor [mol]
$MW_M$	Monomer molecular weight [ $\text{kg.mol}^{-1}$ ]
$m_w$	Mass of water in the reactor jacket [kg]
$\bar{n}$	Average number of radicals per particle [-]
$q_I$	Flow rate of initiator fed to the reactor [ $\text{mol.s}^{-1}$ ]
$q_M$	Flow rate of monomer fed to the reactor [ $\text{mol.s}^{-1}$ ]
$\mathcal{R}_{pol}$	Overall reaction rate [ $\text{mol.s}^{-1}$ ]
$T$	Reactor temperature [K]
$T_j$	Jacket temperature [K]
$U$	Overall heat transfer coefficient [ $\text{W.m}^{-2}.\text{K}^{-1}$ ]
$V_{pol}$	Total volume of polymer generated in the reaction [ $\text{m}^3$ ]
$V_w$	Total volume of aqueous phase [ $\text{m}^3$ ]
$\alpha$	Probability of propagation [-]
$\Delta H_r$	Heat of reaction [ $\text{J.kg}^{-1}$ ]
$\lambda_0$	Total concentration of zeroth moment for growing chains [-]
$\mu_0$	Concentration of zeroth moment for dead chains [-]
$\mu_1$	Concentration of first moment for dead chains [-]

$\mu_2$	Concentration of second moment for dead chains [-]
$\phi_S$	Solids content [-]
$\rho_{pol}$	Polymer density [kg.m <sup>-3</sup> ]

506 **References**

- 507 Araújo, P., Giudici, R., 2003. Optimization of semicontinuous emulsion poly-  
508 merization reactions by IDP procedure with variable time intervals. *Comp.*  
509 *Chem. Engng* 27, 1345–1360.
- 510 Arora, S., Gesthuisen, R., Engell, S., 2007. Model based operation of emul-  
511 sion polymerization reactors with evaporative cooling: Application to vinyl  
512 acetate homopolymerization. *Comp. Chem. Engng* 31, 552–564.
- 513 Benyahia, B., Latifi, M. A., Fonteix, C., Pla, F., 2011. Multicriteria dynamic  
514 optimization of an emulsion copolymerization reactor. *Comp. Chem. En-*  
515 *gng* 35, 2886–2895.
- 516 Biegler, L., 2007. An overview of simultaneous strategies for dynamic opti-  
517 mization. *Chemical Engineering and Processing* 46, 1043–1053.
- 518 Cervantes, A., Biegler, L. T., October 2008. Optimization strategies for dy-  
519 namic systems, *Encyclopedia of Optimization*, Second Edition. Springer,  
520 pp. 216–227.
- 521 Chachuat, B., 2007. *Nonlinear and Dynamic Optimization: From Theory to*  
522 *Practice*.
- 523 Chylla, R. W., Haase, D. R., 1993. Temperature control of semibatch poly-  
524 merization reactors. *Comp. Chem. Engng* 17, 257–264.
- 525 Corriou, J. P., 2004. *Process Control - Theory and Applications*. Springer  
526 Verlag, London, England.
- 527 Corriou, J. P., 2012. *Commande des Procédés*, 3rd Edition. Lavoisier, Tec.  
528 & Doc., Paris, France.
- 529 Gentric, C., Pla, F., Latifi, M. A., Corriou, J., 1999. Optimization and non-  
530 linear control of a batch emulsion polymerization reactor. *Chemical Engi-*  
531 *neering Journal* 75, 31–46.

- 532 Gil, I. D., Vargas, J. C., Corriou, J. P., 2014. Nonlinear geometric tempera-  
533 ture control of a vinyl acetate emulsion polymerization reactor. *Ind. Eng.*  
534 *Chem. Res.* 53, 7397–7408.
- 535 Graichen, K., Hagenmeyer, V., Zeitz, M., 2006. Feedforward control with on-  
536 line parameter estimation applied to the Chylla-Haase reactor benchmark.  
537 *Journal of Process Control* 16, 733–745.
- 538 Hvala, N., Aller, F., Miteva, T., Kukanja, D., 2011. Modelling, simulation  
539 and control of an industrial, semi-batch, emulsion-polymerization reactor.  
540 *Comp. Chem. Engng* 35, 2066–2080.
- 541 Ibrahim, W. H. B. W., Mujtaba, I. M., Alhamad, B. M., 2011. Optimisation  
542 of emulsion copolymerization of styrene and MMA in batch and semi-batch  
543 reactors. *Chemical Product and Process Modeling* 6, 1–18.
- 544 Jang, S. S., Yang, W. L., 1989. Dynamic optimization of batch emulsion  
545 polymerization of vinyl acetate - an orthogonal polynomial initiator policy.  
546 *Chemical Engineering Science* 44, 515–528.
- 547 Kameswaran, S., Biegler, L. T., 2006. Simultaneous dynamic optimization  
548 strategies: recent advances and challenges. *Comp. Chem. Engng.* 30, 1560–  
549 1575.
- 550 Paulen, R., Fikar, M., Latifi, M. A., 2010. Dynamic optimization of a hy-  
551 brid system: emulsion polymerization reaction. *Journal of Cybernetics and*  
552 *Informatics* 9, 31–40.
- 553 Penlidis, A., 1986. Polymer reactor design, optimization and control in la-  
554 tex production technology. PhD thesis, McMaster University, Hamilton,  
555 Ontario.
- 556 Penlidis, A., MacGregor, J. F., Hamielec, A. E., 1985. Dynamic modeling of  
557 emulsion polymerization reactors. *AIChE Journal* 31, 881–889.
- 558 Sayer, C., Arzamendi, G., Asua, J. M., Lima, E. L., Pinto, J. C., 2001.  
559 Dynamic optimization of semicontinuous emulsion copolymerization reac-  
560 tions: composition and molecular weight distribution. *Comp. Chem. Eng.*  
561 25, 839–849.

- 562 Silva, C. M., Biscaia Jr., E. C., 2004. Multi-objective dynamic optimization  
563 of semi-batch polymerization processes. *Macromol. Symp.* 206, 291–306.
- 564 Vicente, M., Sayer, C., Leiza, J. R., Arzamendi, G., Lima, E. L., Pinto,  
565 J. C., Asua, J. M., 2002. Dynamic optimization of non-linear emulsion  
566 copolymerization systems. Open-loop control of composition and molecular  
567 weight distribution. *Chemical Engineering Journal* 85, 339–349.