



HAL
open science

Diagnostic & health management of fuel cell systems: Issues and solutions

Daniel Hissel, Marie Péra

► **To cite this version:**

Daniel Hissel, Marie Péra. Diagnostic & health management of fuel cell systems: Issues and solutions. Annual Review in Control, 2016, 42, pp.201 - 211. hal-02380293

HAL Id: hal-02380293

<https://hal.science/hal-02380293>

Submitted on 26 Nov 2019

HAL is a multi-disciplinary open access archive for the deposit and dissemination of scientific research documents, whether they are published or not. The documents may come from teaching and research institutions in France or abroad, or from public or private research centers.

L'archive ouverte pluridisciplinaire **HAL**, est destinée au dépôt et à la diffusion de documents scientifiques de niveau recherche, publiés ou non, émanant des établissements d'enseignement et de recherche français ou étrangers, des laboratoires publics ou privés.

Diagnostic & health management of fuel cell systems: issues and solutions

Daniel HISSEL, Marie-Cécile PERA

FEMTO-ST Institute (UMR CNRS 6174), University of Franche-Comte, UBFC, Av. des Montboucons, 25000 Besançon, France

FCLAB Research Federation (FR CNRS 3539), rue Thierry Mieg, 90010 Belfort Cedex, France

Abstract

Continuous depletion of the crude oil and gradual increase in the oil price have emphasized the need of a suitable alternative to our century-old oil-based economy. A clean and efficient power supply device based on a renewable energy source has to be available to face this issue. Among the different technological alternatives, fuel cell power generation becomes a more and more interesting and promising solution for both automotive industry and stationary power plants. However, many technological hurdles have still to be overcome before seeing the development of industrial and competitive products in these fields.

Among them, one of the major issues to be solved is their insufficient reliability and durability for stationary and transport applications. To reach this aim, efficient diagnostic and state-of-health estimation methodologies should be available, able also to operate real-time and with limited number of additional physical sensors. This paper describes the state-of-the-art and the motivations regarding these research issues. It presents also selected recent developments and experimentations in this area.

Introduction

In the last years, environmental concerns for sustainable development have reached increased attention from the world political, technical and scientific communities. In the general trend towards increasing renewable energies use, hydrogen-energy based technologies and fuel cell systems are more and more seen as key players in the forthcoming next energy mix [1]. Indeed, they are gaining performances and reducing manufacturing costs; moreover, they can be considered both for transportation applications and for stationary power supply infrastructure [2], thanks to the existing duality between two energy vectors: electricity and hydrogen-energy. Regarding transportation applications, fuel cell vehicles present the interests of a high efficiency versus classical internal combustion engine vehicles and a zero (*in situ*) pollutant emission level. Moreover, their autonomy and refilling time are quite similar to those of classical thermal vehicles. Regarding stationary applications, there is an increasing interest of using hydrogen for the long-term storage of electricity, especially when coupled to intermittent and seasonal power production coming from renewables (windmills, photovoltaic panels).

Nevertheless, they are still technical and scientific issues to be solved, before seeing on the market competitive and efficient fuel cell systems, for a broad range of application areas. Among them, the most sensitive subjects are dealing with the global efficiency of the fuel cell system and the limited lifespan of the existing fuel cell systems, especially when considering hard operating constraints. As an example, and according to recent publications from the US department of energy, the maximal durability of a fuel cell systems under transportation operating conditions is today over 2500 hours, where 5000 hours are requested to reach the existing "standard" lifetime of internal combustion engines [3]. Considering global electrical efficiency of a fuel cell system, even if it can already reach about 40% versus lower heating value of the hydrogen fuel, there is still room for an increase of this efficiency [4].

To reach this aim, research on catalytic layers, electrolytic membranes, materials and design of bipolar plates must be pursued, but extending the lifespan and increasing the efficiency must also be seen from the systemic point of view. As a matter of fact, it is possible acting on this lifetime by reducing / mitigating

the constraints imposed to the fuel cell stack itself, when still responding to the power demand in a very efficient way. For this purpose, diagnostic and state-of-health management tools have to be developed [5].

Regarding these diagnostic tools, that can relate both on algorithms and also hardware developments, four major research objectives can thus be expressed. First, the durability of the fuel cell stack and of the fuel cell system must obviously be increased. Second, still obvious, the global system efficiency must be increased. Third, the reliability of the fuel cell system should also be increased, or at least not lowered by the possible introduction of additional sensors or actuators. Fourth, in order to respond to varying power cycle profile without soliciting too hardly the fuel cell stack, an electrical hybridization of the fuel cell stack with electrochemical or electrostatic electricity storage devices must be considered. This will also lead to an increase of the dynamic performances of the fuel cell system. Besides these research objectives, as fuel cell systems should be able to enter the market at competitive prices, a constraint can also be added for this research activity: the use of a minimal number of actual sensors. Indeed, this constraint will reduce complexity within the system and costs induced by the new state-of-health diagnostic functionality proposed on the fuel cell system. Moreover, this is also quite conservative regarding reliability level.

This paper is organized as follow. Section one will provide some recalls about fuel cell technology and fuel cell systems. Then, a second part will be devoted to the electrical behaviour description of a PEMFC (Polymer Electrolyte Membrane Fuel Cell), classically considered for both transportation and also stationary applications. The description of the different losses reducing the efficiency of the fuel cell system will also be given. Finally, this part will also provide some guidelines regarding the behaviour of a PEM fuel cell stack under faulty (or at least non nominal) operating conditions. The last part of the paper will then provide a flavour on ongoing works relating to diagnostic and health management of fuel cell systems.

1. Fuel cell technology and PEMFC systems

A fuel cell is an electrochemical converter which continuously converts the chemical energy from a fuel and an oxidant into electrical energy, heat and other reaction products. The fuel and the oxidant are stored outside of the cell, and are transferred as the reactants are consumed.

A cell is a stack of different layers:

- A porous anode: the gaseous fuel diffuses through the pores of the anode to reach the interface with the electrolyte able to conduct ions, where it is oxidized, electrons are conveyed from the anode to the cathode by an external circuit,
- A porous cathode: the gaseous oxidant (dioxxygen) diffuses through the pores of the cathode to reach the interface with the electrolyte, and is reduced,
- An electrolyte which conducts the ions from one electrode to the other,
- The bipolar plates which convey the reactants to the electrodes, evacuates the reactants in excess, the product of the reaction (mostly water), the heat produced by the cell,
- Silicon seals to avoid gas and cooling fluid leakages.

Different phenomena (electrical, electrochemical, fluidic, thermal) occurs that make a fuel cell a highly multi-physics object. Furthermore, these phenomena have very different characteristic time responses. The fastest concerns the double layer capacity effects: at the interface between the electrodes which conducts electrons and the electrolyte which conducts ions, charged particles are not displayed geometrically in a uniform manner. Then comes the transfer of charges due to the electrochemical reactions (oxidation and reduction), the gas diffusion through the electrodes, the water transport, the poisoning of electrodes due to contaminants in the reactants, the thermal changes, and then the degradation and ageing effects. Figure 1 illustrates that for a PEMFC, covering the range from microseconds to years, from 10^{-6} s to 10^8 s. Furthermore, the electrochemical reactions occur at the surface

of the catalytic nanoparticles whereas gas are supplied through centimetric pipes. A fuel cell isn't only a multi physics but also a time- and space- multiscale and coupled object. To sum up in one word, a fuel cell is a complex system [6].

The thermodynamical maximum cell voltage is 1.23V. It means that in real life applications, the cells are associated in series in a stack to increase the voltage at a practical value.

Different technologies of fuel cells exist. One very commonly used classification is based on the operating temperature. Three classes of fuel cells can thus be defined, operating at low, medium and high temperatures. This classification criterion is interesting because it has a significant impact on the structure of the cell, the balance of plant to operate it and its domain of application. The operating temperature conditions the quality of the heat produced which accompanies the electricity production. The higher the temperature at which the heat flux is produced, the better it can be exploited so as to enhance the overall yield of the system. Also, the higher the operating temperature, the less sensitive the system is to the presence of carbon monoxide in the reactants, which simplifies the processes of conditioning of the gases. Finally, medium and high temperatures enable us to forego the use of noble metals to catalyse the redox reactions, thereby greatly reducing the cost of the electrodes.

Table 1 gives few characteristics of the fuel cell technologies, PEMFC: Proton Exchange Membrane Fuel Cell, AFC: Alkaline Fuel Cell, PAFC: Phosphoric Acid Fuel Cell, MCFC: Molten Carbonate Fuel Cell, SOFC: Solid Oxide Fuel Cell. The applications of fuel cell can be divided in three domains that can overlap: portable applications (supply of mobile phone, laptop ..., auxiliary power unit), stationary application (uninterrupted power supply, supply of domestic electricity, domestic CHP, high power CHP ...), transportation (supply of the propulsion or supply of the electric net board, in space, air, sea, terrestrial vehicles). Then, fuel cells can cover a wide range of power and heat generation, from mW to MW [7].

PEMFC and SOFC are currently the more investigated technologies. In this paper, PEMFC technology is focused.

Table 1: Classification of fuel cell technologies

	Type of fuel cell	Operating temperature range (°C)	Electrolyte	Type of ions exchanged	Main application area
Low temperature	PEMFC	[50°C-80°C]	Polymer Membrane	H^+	Low power portable applications Low power stationary applications Automobile/transport
	AFC	[65°C-200°C]	KOH	OH^-	Spaceships
Medium temperature	PAFC	[180°C-250°C]	H_3PO_4	H^+	Domestic heat and electricity co-generation (CHP)
High temperature	MCFC	[600°C-700°C]	Carbonate ion salt	CO_3^-	High power units for CHP, maritime applications
	SOFC	[750°C-1000°C]	Oxide-based ceramic	O^{2-}	High power units for CHP

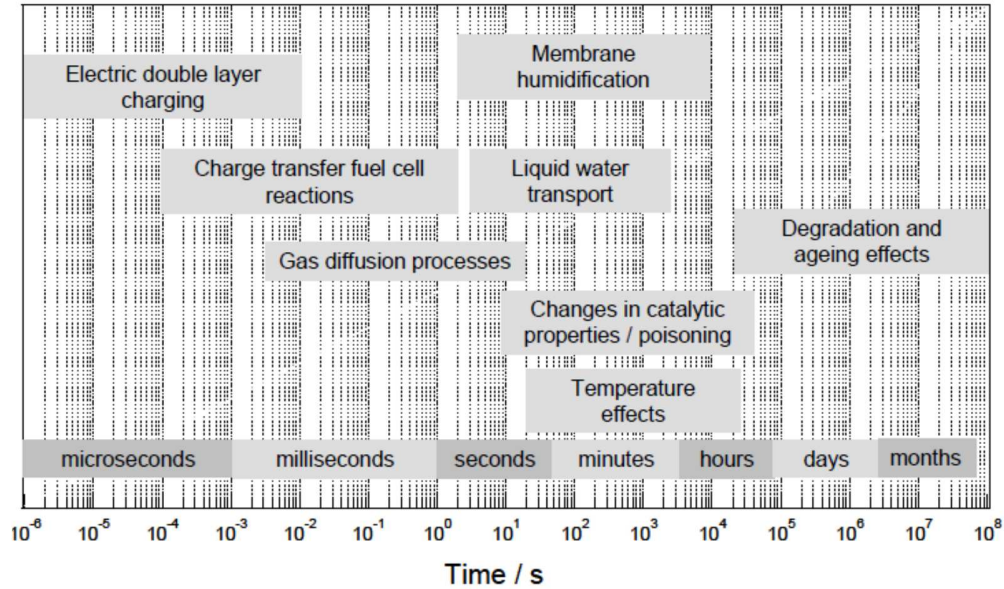

Fig. 1: Illustration of the multiscale nature of a PEMFC [8].

2. Behavior and losses of PEMFC

2.1. Characterization and modeling

A PEMFC is currently fed by pure hydrogen at the anode and oxygen at the cathode, either pure or coming from ambient air. Hydrogen is oxidized at the anode and then proton H^+ flows from the anode to the cathode, through the polymer membrane, whereas electrons are collected by the bipolar plates and feed the cathode. At the cathode, oxygen, electrons and protons meet to produce water (Figure 2). This process leads to the production of electric power, thermal power and water. The electrolyte is a polymer which conducts protons only if it is well hydrated.

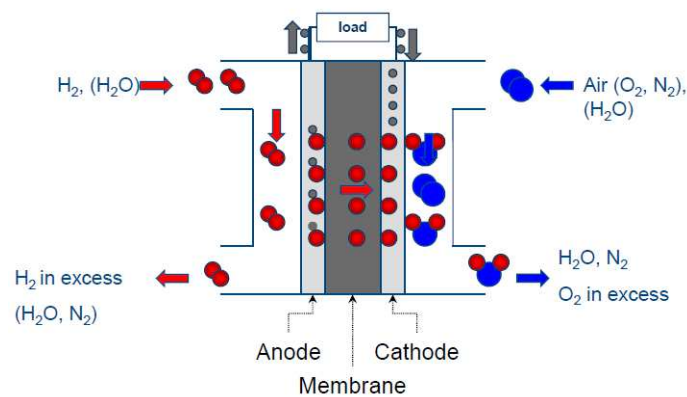

Fig. 2: Schematic representation of a PEMFC operation.

Reactions occurring at the electrodes are then :



From reactions (1), it can be demonstrated that, without leaks through the membrane, the molar flow of hydrogen q_{H_2} and oxygen q_{O_2} consumed to produce the current I , from a N-cell stack follow the Faraday laws (2), F is the Faraday constant (i.e. the electric charge of one mole of electrons):

$$q_{H_2} = \frac{NI}{2F} \quad q_{O_2} = \frac{NI}{4F} \quad (2)$$

If the cell is considered as loss free, the reversible Nernst potential E_N across the cell is depicted by equations (2-3), with E^0 the reversible potential at standard operating conditions, Δg_f^0 the variation of the Gibbs free energy when a mole of vapor water is formed, R the perfect gas constant, T the temperature (K), P_{H_2} and P_{O_2} the partial pressure of respectively hydrogen and oxygen, P_0 the atmospheric pressure.

$$E^0 = -\frac{\Delta g_f^0}{2F} \quad (3)$$

$$E_N = E^0 + \frac{RT}{2F} \ln\left(\frac{P_{H_2}}{P_0}\right) + \frac{RT}{2F} \ln\left(\frac{P_{O_2}}{P_0}\right) \quad (4)$$

The reaction of formation of one mole of water is exothermic, the heat Q_f is released, according to equation (5), with ΔS , the entropy variation at the operating temperature and pressure:

$$Q_f = T\Delta S \quad (5)$$

In a real cell, in operation, the different phenomena occurring lead to losses that decrease the cell voltage, meaning that the measured voltage, even in open circuit, is always below the reversed value E_N , i.e.:

- the activation of the redox reactions, which is dominant at low current,
- the ohmic resistance to the ions transport through the membrane et to the electrons through the electrodes and the bipolar plates, the latter being most of the time negligible, which is dominant at mean current,
- the concentration voltage drop due to the transport of matter through the porous electrodes and more specifically through the gas diffusion layer, which is dominant at high current.

These phenomena depend on the current I which is often normalized according to the electrode surface area S by using the current density j :

$$j = \frac{I}{S} \quad (6)$$

The static electric performances of a cell are usually expressed through the polarization curve, cell voltage versus the current density, η_{acti} being the voltage drop due to the activation at the electrode i (a : anode, c : cathode), η_{ohm} the voltage drop due to ohmic resistance, η_{conci} the voltage drop due to matter transport:

$$V_{cell} = E^N - \eta_{acta} - \eta_{actc} - \eta_{ohm} - \eta_{conca} - \eta_{concc} \quad (7)$$

As the cells are in series, the voltage at a N-cell stack terminals is the sum of the N cell voltages (8). To compare different stacks, the stack voltage can be normalized considering the voltage of an equivalent mean cell (8).

$$V_{stack} = \sum_1^N V_{celli} \quad (8)$$

$$V_{mean\ cell} = \frac{\sum_1^N V_{celli}}{N} \quad (9)$$

The nominal current density of the stack is typically between 0.5 and 1 A/cm² and the corresponding mean cell voltage around 0.7 V.

Figure 3 gives an example of the normalized polarization curve of a 20-cell stack.

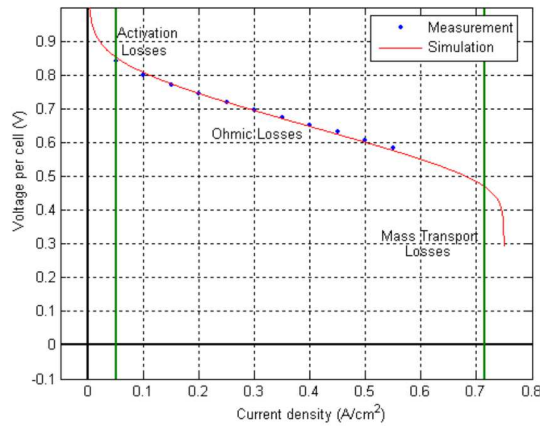

Fig. 3: Example of a PEMFC polarization curve.

The polarization curve reflects only the quasi-static behavior of the PEMFC. In most of the applications, it is submitted to a variable current profile, which can be highly dynamic as in an urban vehicle for instance. One of the most used characterization of the dynamic behavior of a fuel cell is the electrochemical impedance spectroscopy (EIS). In the galvanic mode, it consists of superimposing a sinusoidal component to a constant DC component of the current and to measure the voltage response. The sinusoidal perturbation must be small enough to stay in the linear range and get a sinusoidal voltage in return. The frequency of the perturbation is changed to cover a wide range, typically between 1kHz and 0.05Hz (Figure 4) [9].

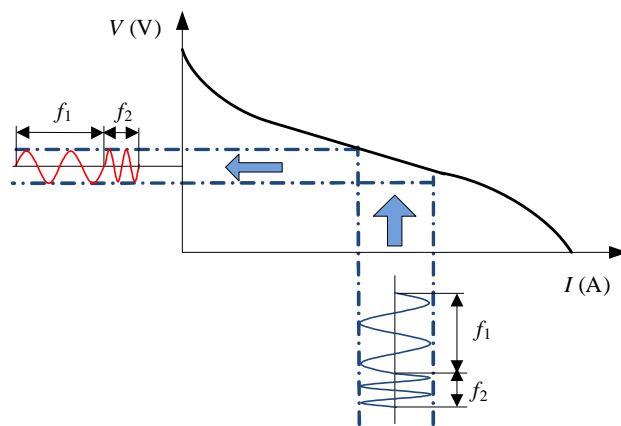

Fig. 4: Principle of the electrochemical impedance spectroscopy.

At each frequency, the AC components of the current $\delta\bar{I}$ and the voltage $\delta\bar{V}$ are measured and the complex impedance \bar{Z}_{FC} is computed.

$$\bar{Z}_{FC} = \frac{\delta\bar{V}}{\delta\bar{I}} \quad (10)$$

The electrochemical impedance is plotted in the Nyquist plan. As the physical phenomena occurring in the PEMFC have different characteristic frequency ranges, it enables to extract features related to these

phenomena. Figure 5 gives an example of a Nyquist plot which exhibits clearly three arcs. Unfortunately, they are not always as decoupled and can overlap.

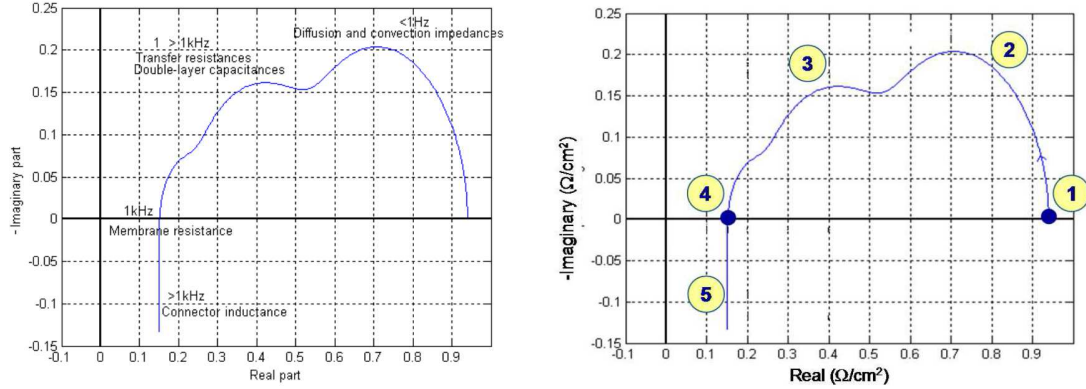

Fig. 5: Example of an electrochemical impedance spectrum in the Nyquist plan and the phenomena activated by the spectroscopy in different frequency range.

Figure 6 proposes an equivalent circuit of the electrochemical impedance [10]:

- R_m is the membrane resistance, it is the intersect between spectrum and the real axis in high frequency (point #4),
- C_{dca} , C_{dcc} are the double layer capacities and R_{ta} , R_{tc} , the resistance to the charge transfer, resp. at the anode and the cathode, arc 3 in Figure 5,
- W_{Oc} is a diffusion convection impedance, based on a Warburg impedance, related to the arc 2. As the diffusion of hydrogen at the anode is much easier than the oxygen diffusion at the cathode, the corresponding impedance is neglected here.

$$W_{Oc} = R_{Oc} \frac{\tan(\sqrt{\tau_{Oc} \cdot p})}{\sqrt{\tau_{Oc} \cdot p}} \quad (11)$$

- L_{con} is the inductance of the connectors, zone 5.

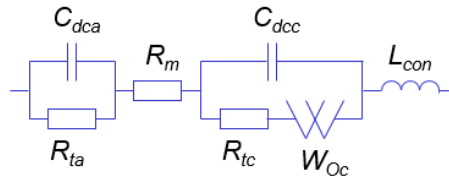

Fig. 6: An equivalent circuit of a PEMFC impedance.

Due to the highly non-linear behavior of the Warburg impedance which takes into account the fluidic mass transfer inside the PEMFC, the estimation of these parameters is far from being straightforward. Furthermore, this approach is not sufficient to describe all the faulty operation, particularly in case of non-stationary conditions.

Other modeling approaches have been developed, the main problem is still the representation of the fluidic domain. Some models are based on an analogy between the electric and fluidic domains [11], [12] : the pressure is represented by a potential, the gas flow by a current, the pressure drop by a resistance, the accumulation of fluid by a capacity and vapor saturation by diodes. Some approaches develop state space model, where variables are gas partial pressures and volumetric flows [13] or apply energetic graphical formalisms to represent the FC as a multiphysics objects [14, 15]. Neural networks model avoid

the problem of the description of the physical phenomena and are able to address different dynamics [16].

The understanding and the forecast of the behavior of a PEMFC under normal running conditions is a difficult task because of its multiphysics and multiscale nature. Furthermore, the stack is operated thanks to the auxiliaries that form the fuel cell system. Then the interactions between the stack and the other components of the system and the malfunctions of the auxiliaries can lead to suboptimal and even faulty conditions.

2.2. Behavior of PEMFC under faulty or non-nominal operating conditions

The core of a PEMFC system is of course the fuel cell stack. However, the fuel cell system has to be considered to be able to evaluate the net performances and the system lifetime. Figure 7 describes the architecture of a fuel cell system:

- The fuel circuit that feeds the anode. Depending on the water management, the reducing gas can be either or neither humidified,
- The oxidant circuit which feeds the cathode, by a compressor if oxygen comes from the air and possibly through a humidifier,
- The cooling circuit that controls or limits the stack temperature (air cooling for low power stack, water cooling for high power stack),
- The water management to humidify the cathode and/or the anode and to recover the water produced by the stack,
- The power conditioning to adapt the output power to the requirement of the application, through a DC/DC or a DC/AC converter,
- The energy storage to manage the energy during the starting and shut-down phases and transient phases as a fuel cell is not reversible in practice and is limited from the dynamic point of view by the dynamics of the auxiliaries,
- The control and supervision to operate the system.

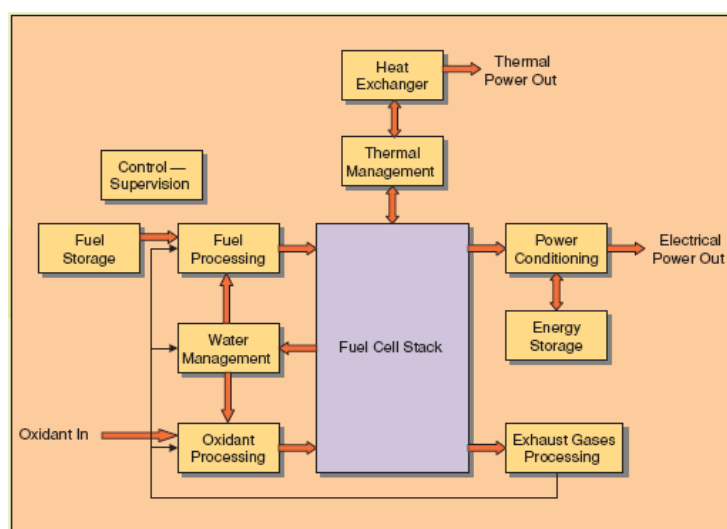

Figure 7: Generic architecture of a PEMFC system [17].

Monitoring the system is mandatory to assess its state of health. However, it has to be done with a minimal number of sensors to avoid to increase further the cost, to reduce the reliability in case of fault or failure of the sensors, to reduce the time response by adding the time response of the sensor itself. Then potential measurements can be classified as technically or economically possible, unlikely or impossible (Table 2).

Table 2: Classification of measurements from the economic and technical point of view

Possible	Unlikely	Impossible
Stack current	Single cell voltages	Flows in the channels of the bipolar plates
Stack Voltage	Gas pressure (inlet/outlet)	Local current density
Stack impedance*	Gas flow	Gas hygrometry
Cooling water temperature	Stack internal temperature	Electrolyte membrane water content
Gas temperature		Stack impedance*
Air compressor speed		Gas composition (inlet and outlet)

* the stack impedance measurement is possible if it is done through the output DC/DC converter with a modified control [18], too cumbersome and expensive through a lab spectrometer.

When a stack is operated under stationary conditions of temperature, pressure, flow, current, the voltage decays with time. The degradation of the stack is then characterized by the voltage decay rate in mV/h. When the stack is operated under variable current, this criterion is much more difficult to follow as, even if the load profile includes a chosen reference current value, the transient voltage response can modify the result. Then defining the ageing of a stack is a tricky matter and is not the focus of this article. However, it is necessary to give few highlights on failure mechanisms of the stack itself in order to better understand how to define a faulty operation and its impact on the stack performances.

Degradations of the stack can be divided in three types [19]:

- Mechanical degradation : it is mainly due to initial improper manufacturing processes leading to cracks and in most of the case lead to an early failure,
- Thermal degradation : the stack is used outside of its optimal temperature range and it leads to structural changes at the micro and nano scale,
- Chemical and electrochemical degradation: the presence of contaminants or the operation at high potential affect the catalytic activity, the diffusion and hydrophobic properties.

They can touch one or several components of the cell: the membrane, the electrodes (catalytic layer or diffusion layer), and the bipolar plates.

The main parameters that reduce the FC lifetime are:

- Fuel purity : ppm of contaminants like CO , H_2S or particles,
- Oxidant purity : ppm of oil from the compressor, from particles coming from the environment,
- Fuel and oxidant starvation: the minimal amount of reactants on the catalytic layer is defined by the Faraday laws (2) and is strictly proportional to the current. The difference of electric dynamics which determines the instantaneous current value and the fluidic dynamics (linked to the

auxiliaries upstream the stack and the diffusion inside the stack) which determines the instantaneous concentration at the electrodes can cause a lack of reactants in a transient phase. A malfunction of one of the actuators in the system (a solenoid valve for instance) can provoke a longer starvation situation.

- Temperature supervision,
- Hydration supervision,
- Pressure variation (the electrolytic membrane is thin, less than 100 μm , and cannot bear a too high pressure drop between anode and cathode),
- Peak power demand (directly linked to the reactant starvation) and current ripples (due to the output power converter),
- Open circuit voltage operation (high potential favors corrosion reactions at the electrodes).

As can be seen from the list above, the fault and failure mechanisms due to the stack and the auxiliaries are strongly coupled and covers a wide range of dimensions from the nanoscale structure of the electrodes to the actuators of the auxiliaries and from the rapid charge transfer to the time response of the controllers and system supervision.

Three examples are given to illustrate the influence of auxiliaries. All the experiments reported here are carried out on a laboratory test bench that reproduces a system fault.

The first illustration concern the influence of a low stoichiometry factor at the cathode. To avoid starvation and improve the diffusion of oxygen and the draining of water, the air flow that enters the stack is higher than the one required by the current demand. The ratio F_{SC} between the input air flow q_{O_2in} and the air flow calculated from the Faraday law is called cathodic stoichiometry factor:

$$F_{SC} = \frac{q_{O_2in}}{NI/4F} \quad (12)$$

Figure 8 exhibits the oscillation of the cell voltages of a stack, submitted to a constant current and stationary conditions. The lower F_{SC} is the higher the voltage oscillations are [20]. Post mortem analysis of the cells has shown non uniform degradations at the surface of the cell: metallic bipolar plate corrosion, marks on the seals due to hot spot, migration of platinum particles from the electrode to the membrane and local dramatic change in the catalyst layer structure.

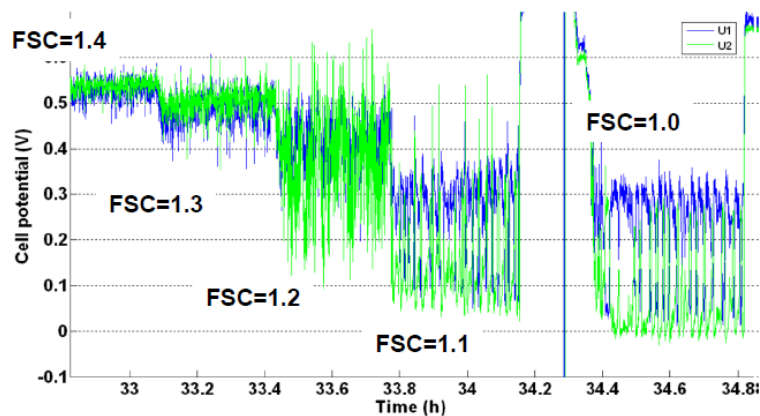

Figure 8: Oscillations of the cell voltages of a stack under stationary conditions but submitted to different cathodic stoichiometry factors [20].

Figure 9 shows the influence of the current ripple as imposed by the DC/DC power converter. Two short stacks have been aged in similar operating conditions except that one stack has been exposed to a constant current and the other one has been exposed to the same DC component in addition to a current ripple, as it would have been the case with a real DC/DC converter at the output of the stack. The current ripple has led to higher reversible degradation which can be recovered during a characterization phase (a polarization curve measurement) whereas the irreversible degradation trend is the same [21].

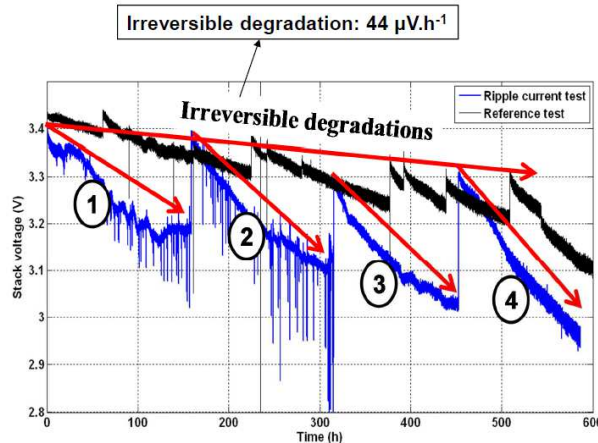

Figure 9: Influence of the current ripple on the stack voltage. (zone 1 : $264 \mu\text{V}\cdot\text{h}^{-1}$, zone 2 : $387 \mu\text{V}\cdot\text{h}^{-1}$, zone 3 : $382 \mu\text{V}\cdot\text{h}^{-1}$, zone 4 : $507 \mu\text{V}\cdot\text{h}^{-1}$) [21].

Figure 10 shows the influence of the shutdown of the water cooling pump that causes a null water flow in the primary cooling circuit in a 40 cell stack during few minutes. The cell voltages have been monitored and it can be seen that this fault affects dramatically certain cells [22].

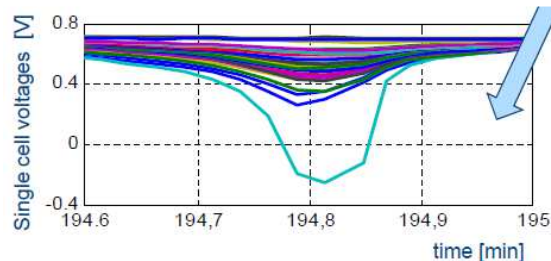

Figure 10: Influence of the shutdown of the water cooling pump on the cell voltages.

3. A flavor about diagnostic and health management strategies for PEM fuel cells

Around the world, activities around diagnostic methodologies for fuel cell systems have started in the early 2000's [23], [24], [25]. When considering PEMFC stack or system diagnostic, various methodologies have been developed in recent years and each has its advantages and limitations. According to whether or not a model is necessary, those diagnostic methods can be classified into two general types: model-based one [6] and non-model based one [26].

For the former one, an analytical model based on a deeper understanding of the internal process of the fuel cell system or a black-box model should be built first. Since fault diagnostic in this case is usually based

on the (so-called) residuals generated between the experimental results and the model outputs, this kind of method is also called residual-based method. The main difficulties regarding this approach are linked to the physical behavior of the fuel cell stack by itself. Indeed, a fuel cell stack is a highly multi-physics and multi-scale system, where the estimation or measure of internal parameters is difficult, if not impossible, and where the use of physical sensors to assess the internal states of the fuel cell stack could lead to a dramatic cost increase and reliability decrease.

Non-model based methods could be either knowledge-based or signal-based. The objective of this kind of methods is to obtain fault information based on heuristic knowledge or signal processing or a combination of both. Compared with model-based methods, non-model based ones are a relatively new trend in diagnostic of PEMFC systems, but its application in other fields has already been widely and extensively studied. Here, the need of large data sets that are preliminary acquired on a system in day-to-day use or on a dedicated laboratory test bench, is mandatory. Moreover, these data sets must be acquired under both normal and targeted faulty conditions.

3.1. Model-based fault detection and isolation

In [13], authors proposed an electrical-equivalent model of a PEMFC stack. Then, based on experiments performed in-lab and under nominal operating conditions, they identified the parameters involved in the proposed model. The model validation has been done on a 20-cell stack that can delivered up to 500W of electrical power. In this paper, three main types of failures have been considered: a flooding of the cathode compartment of the fuel cell stack, a drying-out of the electrolyte membrane, and a membrane deterioration over time. The two first failures are reversible and can be mitigated by appropriated actions at the system level (shifting of the operating points, increase of air flow in the case of flooding, increase of requested current and decrease of the operating temperature in case of drying-out of the membrane). Such operation incidents linked to water management (cells flooding and membrane drying out) are of particular interest because they may occur frequently during fuel cell operation and they cause rapid power decay. They can even lead to irreversible chemical and mechanical degradation [27]. The last failure is irreversible and linked to the ageing of the electrolyte membrane.

The electrical-equivalent based representation of the fuel cell model [12] (fig. 11) enables characteristics that facilitate its diagnostic. Indeed, the model can be easily linearized around an operating point, making possible observer utilization for residual generation. This approach can be very useful regarding fuel cells, since internal and real-time measurements inside the stack cannot be considered from an industrial point of view; moreover internal parameter values are often not available, as considered as the core know-how of stack manufacturers. Then, state reconstruction from sparse available data is valuable. A second interesting point regarding this electrical-equivalent model is the fact that failures occurring on the fuel cell stack can be directly associated with circuit parameters variations. The causality is thus explicit, and a parametric approach to diagnostic such as Kalman filtering is then feasible.

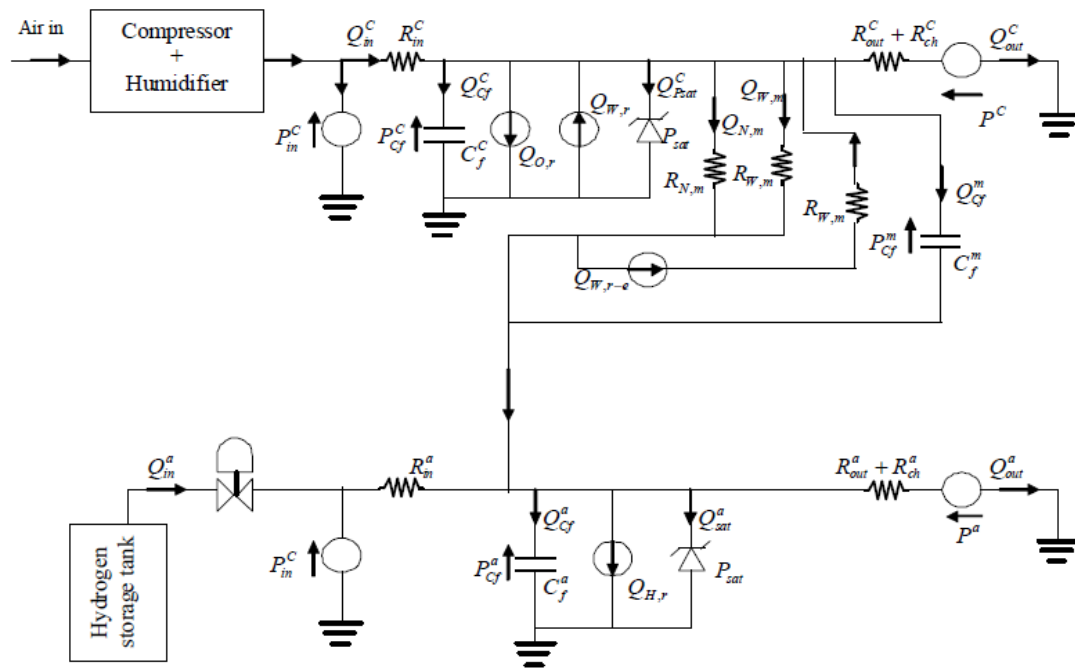

Fig. 11: PEMFC complete equivalent circuit: anode, cathode, electrolyte membrane [12].

As obtaining efficient models for highly multiphysic systems such as fuel cells is far from obvious, another model-based diagnostic approach can be considered by using black-box models. In this case, a part of the stack or even the whole fuel cell stack can be modeled in this way. For instance, in [28], neural networks are used to estimate the pressure drop in the cathode compartment of the fuel cell stack, in order to identify a possible flooding. In fact and roughly speaking, all “fault” incidents in a PEM fuel cell have a common consequence, which is a voltage drop. This could be considered as the main and first indicator of a degraded state. After performing a fault-tree analysis regarding flooding, the authors identify the pressure drop in cathode compartment as a good indicator for diagnostic. They build a Neural Network (NN) model (fig. 12) trained to fit the strongly non-linear relation between a set of input variables (namely current, temperatures, and air flow) and the cathode pressure drop, as output variable. Experiments were performed on a 20-cell stack, able to deliver up to 500W of electrical power. Firstly, experiments under non-faulty operating conditions are considered, and used for the training of the NN. Then, the experiment is performed in operating conditions where the fuel cell is deliberately flooded by setting a gas dew point temperature lower than cell temperature. The flooding is detected in all the considered experimental cases and only in a few minutes.

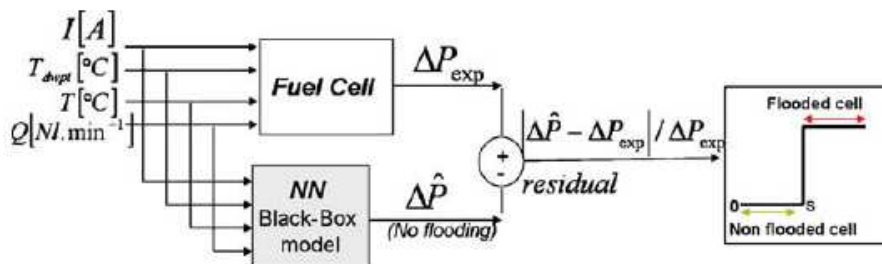

Fig. 12: Flooding diagnostic using artificial neural network [28]

Among the different PEMFC model-based approaches, and as for other electrochemical devices, EIS-based (Electrochemical Impedance Spectroscopy) approaches have already been deeply studied [6]. The EIS is a widespread experimental technique able to characterize the behavior of an electrochemical system, and therefore allows analyzing several phenomena inside the cell and evaluating the system losses. The idea behind the EIS is to analyze the response of the electrochemical device after a sinusoidal perturbation imposed on the system terminals. The perturbation input is a signal of small amplitude, superimposed on the nominal value of the operating current (galvanostatic mode) or voltage (potentiostatic mode). Per each operating condition, the perturbation frequency changes within a based range of values, usually for PEMFC the interval is [0.1 Hz-1 kHz]. The galvanostatic mode is usually preferred for fuel cells.

Fouquet et al. [29] study the flooding/drying phenomena during PEMFC operation. Several tests were made observing the system behavior versus time. They focus on the development of a suitable on-line monitoring technique based on impedance spectroscopy. Indeed, the general shape of the obtained EIS under nominal or non-nominal operating conditions is strongly different (fig. 13). Experimental results were then analyzed and an equivalent circuit model was developed to reproduce the impedance spectra. The authors propose a robust fault detection and isolation diagnosis for PEMFC hydration monitoring.

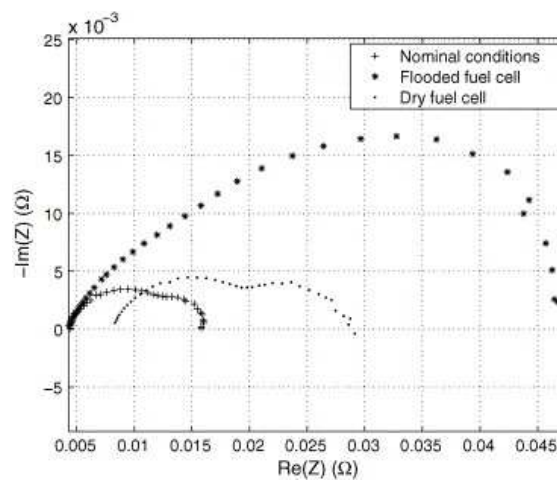

Fig. 13: Nyquist plot of the fuel cell impedance spectra of a PEM fuel cell stack in different operating conditions [29].

Also Asghari et al. [30] study the PEMFC performance via the EIS technique. Different experiments were conducted to study the performance variations by increasing and decreasing the bipolar plate clamping torque and the temperature and flooding effects were also analyzed. An equivalent circuit model has been developed in order to simulate the impedance arcs in Nyquist plot. The authors estimate each process by observing the variation of the parameter values.

Another paper on PEMFC monitoring based on EIS technique is proposed by Narjiss et al. [31]. The authors developed an innovative method for PEMFC on-line fault detection. The small sinusoidal signal is superimposed on the system directly through the existing output DC/DC converter and the control system allows the on-line EIS without any disturbance in the electrical load (fig. 14). A fault on the cooling circuit and the hygrometry variation effects were analyzed. Another time, electrical equivalent models are considered to extract from the obtained EIS spectra the evolution of different characteristic parameters.

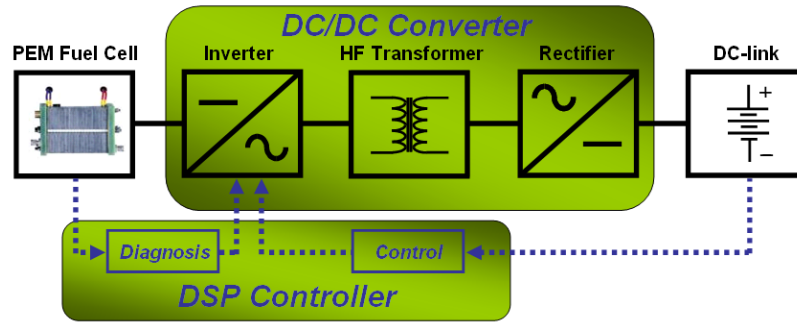

Fig. 14: General scheme of the on-line EIS monitoring through the power converter.

3.2 Signal-based fault detection and isolation

Many signals obtained from the PEMFC system processes show level modifications that are due either to harmonic or to stochastic nature, or both. If changes of these signals are related to faults in the process, signal processing approaches can be applied for fault diagnosis [32]. When performing a signal processing based diagnostic method, there are two things to consider: determining which signals to apply for monitoring, and choosing an efficient signal analysis approach for interpreting [33].

In this part, signal-based diagnostic strategies for PEMFC will be introduced. The first step should be to make a correlation between measured signals and related faults on the fuel cell stack. This analysis is proposed in table 3, where some interesting signals related to faults in the PEM fuel cell system are summarized according to the literature.

Table 3: Signals related to faults in PEMFC

Signals	Related faults on PEMFC	References
Cathode pressure drop	Cathode flooding	[34]
Anode pressure drop	Water present at anode side	
Individual cell voltages variance	Cathode flooding	[36]
Mean cell voltages		
Voltage oscillations	Air starvation	[37]
Cathode pressure drop	Flooding	[38]
Cell resistance	Drying	
Stack open circuit voltage	Anode/cathode crossovers	[39]
Stack voltage (high frequency)	Flooding	[35]
EIS measurement	All	[40]

3.2.1 Signal-based fault detection using EIS

Based on the EIS measurement of the fuel cell stack in real time, and in direct link with the last part, Pahon et al [41] propose to perform fault detection and isolation on PEM fuel cell stacks, by using direct classification of specific features extracted from the EIS measurement. On this EIS, only five values (imaginary or real parts of points, over the complete frequency range) are selected. Then, a supervised classification method (k-nearest neighbor) is considered for labeling the raw data. The data labels are divided into different groups: healthy behavior, faulty behavior (in this last case, with reference to the fault that is currently occurring on the fuel cell system). Three faults, relating to the fuel cell system, have been considered: a fault on the air supply line leading to oxygen starvation in the stack, a fault on the cooling circuit leading to overheating of the stack, and a fault on the power electronics leading to an electrical short circuit on the stack. On different fuel cell stacks; coming from different suppliers, a minimal good classification rate of over 92% is obtained on these faults, which is a pretty impressive result. However, this approach requires a large experimental database to provide good results and is unable to manage new fault modes, not seen before.

Using the same approach, Hissel et al. [42] propose a condition monitoring algorithm for a PEM fuel cell stack. Starting from EIS measured directly on the fuel cell stack under operation, from time to time (typically each 100 hours of operation), the proposed algorithm is able to estimate the preliminary operating conditions supported by the stack. A discrimination can be done between a brand new stack, a stack operated in stationary conditions and a stack operated under an automotive dynamical power profile (fig. 15). Two major sensitive features are extracted from the EIS and a fuzzy clustering algorithm is used for labelling the data. The obtained results are very good with only 11% non-assigned points, corresponding to transient operating conditions from a state to another one.

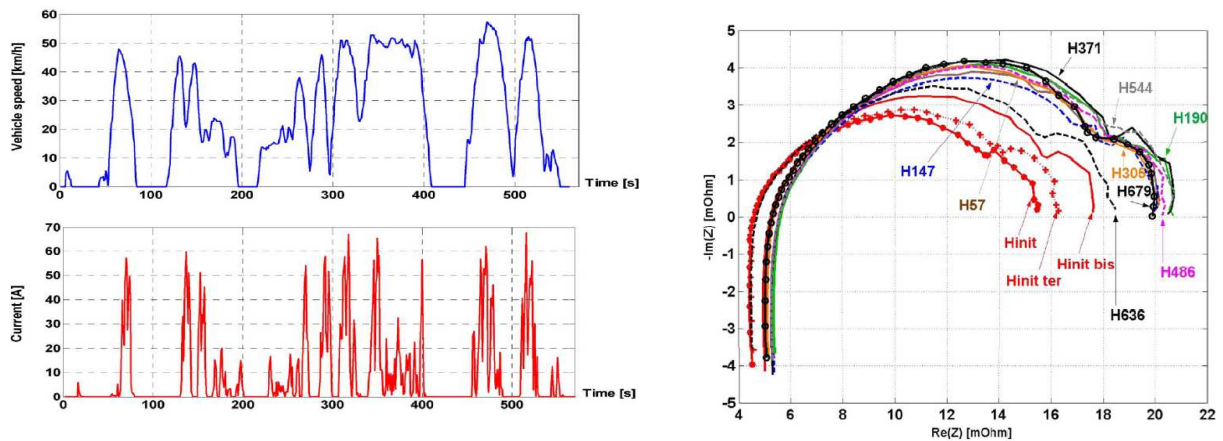

Fig. 15: Power profile extracted from real car solicitation and obtained EIS over 1000 hours of operation.

Zheng et al. [43] combine the EIS online monitoring through the power converter with a double fuzzy clustering algorithm performed on selected features from the EIS plot to propose a complete diagnostic tool for commercial fuel cell systems (fig. 16). The obtained results, in case of a fault on the air inlet circuit, leading to non-nominal oxygen stoichiometric factors in the stack, present an accuracy rate of 100% on the testing base.

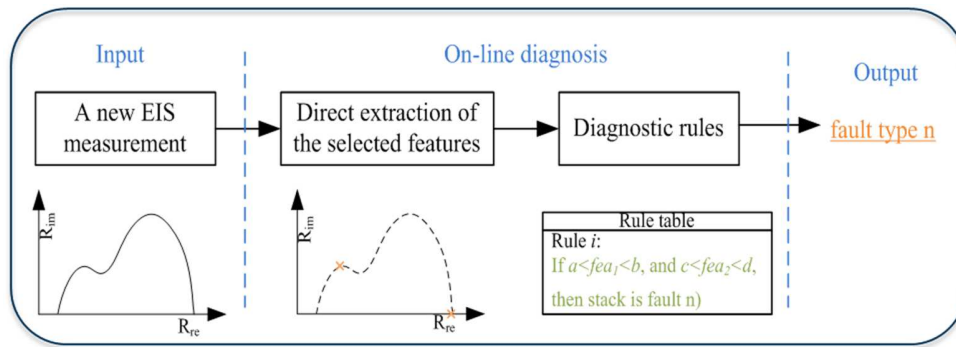

Fig. 16: General principle of the online diagnostic algorithm [43].

3.2.2 Signal-based fault detection using only the measured fuel cell voltage

Another interesting option, especially from the industrial point of view, is to use only the voltage (stack voltage or even single-cell voltages) to perform real-time health assessment of the fuel cell. In this case, despite the fact that Fast Fourier Transform (FFT) has already been considered for fuel cell application [44], it is not adapted to non-stationary signals which are typically extracted from the FC during its actual operation. For the analysis of varying signals, wavelet analysis is another option that mitigates the dilemma between time resolution and frequency resolution.

Recent application of wavelet analysis in PEMFC diagnostic is shown in [35]. Wavelet analysis is performed based on stack voltage measurements for discriminating whether the stack is flooded or not. Complete wavelet packet decomposition is applied, consisting in decomposing the approximation signal and also the detailed signal, resulting in richer information. In the analysis, all the voltage measurements obtained during each experiment (flooding and non-flooding) were transformed into wavelet packet domain using Daubechies wavelets at level 3. A preliminary analysis of data used in each class is thus performed in order to check whether the data collected within the same class exhibit a similar behavior. Finally, two features were extracted, thanks to Principal Components Analysis (PCA) and sequential forward selection, to build a two-dimensional space for classifying the state-of-health of the stack (fig. 17). The experimental results presented in this study are obtained on a 500W PEM fuel cell stack. Seven levels are considered for the wavelet packet analysis, leading to 254 packets per measured signal. The results obtained for discriminating the state-of-health of the stack between flooding and non-flooding states (fig. 18) proved the feasibility and reliability of wavelet analysis method for health assessment of fuel cells. As said, this method uses only the stack voltage and can be adapted to a large set of fuel cell configurations and applications.



Fig. 17: General principle of wavelet analysis of the stack voltage [35].

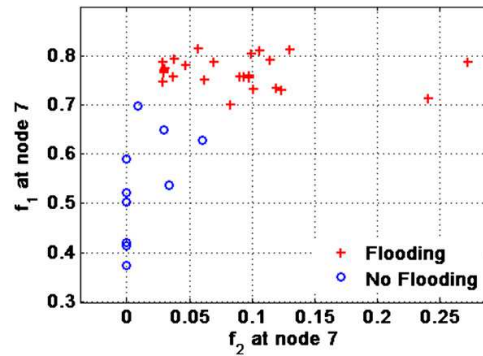

Fig. 18: Classification results obtained in the 2D-feature space [35].

Still considering only the measured voltages on the stack, fuel cell stack health assessment can also be obtained by tracking the temporal evolution of single-cell voltages. Indeed, individual cell voltages can support more information than the whole stack voltage (fig. 19). For this purpose, Li et al. [45] considered data-driven fault detection and isolation by analyzing the cell voltage generated space. An 8-cell PEM fuel cell stack and a 40-cell PEM fuel cell stack were considered for the experimental tests, including the ones under faulty operating conditions. Besides nominal operating state, 5 faulty operating conditions were considered (high current, high/low air stoichiometry, CO poisoning, stop of cooling water). The proposed diagnostic approach combines FDA (Fisher Discriminant Analysis) and DAGSVM (Directed Acyclic Graph Support Vector Machine) to perform respectively feature extraction from the single-cell voltages space, and classification of the extracted features into a given class according to the state-of-health of the stack. Those methods were chosen for their outstanding performances regarding diagnostic accuracy (about 95% of right fault detection) and computational cost (less than 5kb required to save the FDA and SVM models) [46].

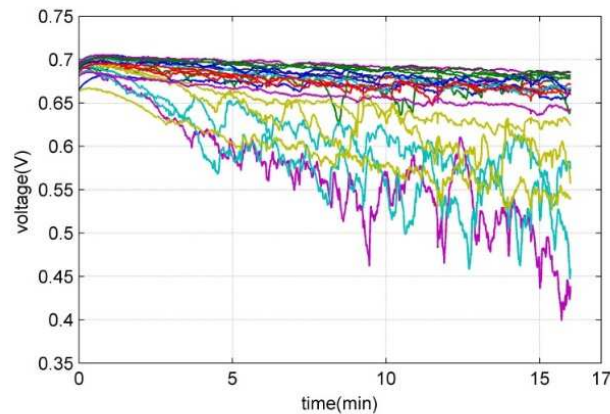

Fig. 19: Typical temporal evolution of single cell voltages on a 20-cell PEMFC operated in faulty mode.

Conclusion & perspectives

Fuel cells are now established as promising energy converters, for both stationary and transport applications. They will thus have to play a major role in the next energy mix, as key devices for closing the loop between two dual energy vectors: electricity and hydrogen. However, at the system-level, there are

still scientific and technical issues to be solved, among them the increase of their durability under varying operating conditions, and the increase of their electrical efficiency (seen at system level). Therefore, and for both issues, research work is required on efficient and real-time-ready fuel cell health assessment strategies. A flavor of some existing fault detection and isolation approaches, currently developed for fuel cell stacks and systems, has been provided in this paper. It is not exhaustive, but should provide the interested reader with some guidelines and ideas for tackling these issues.

When talking about perspectives, another correlated research topic is the idea of going from diagnostic to prognostic of fuel cells. In this case, the final aim is to estimate the remaining useful lifetime (RUL) of fuel cell stacks and/or systems under actual operating conditions. The major issues are here relating to accelerated stress test procedures at the stack level, the variability of fuel cell stack performances due to industrial process, the prognostic methodology by itself and the definition of thresholds for the RUL, when considering real varying operating conditions [47].

References

- [1] A. Sgobbi, W. Nijs, R. De Miglio, A. Chiodi, M. Gargiulo, C. Thiel, "How far away is hydrogen? Its role in the medium and long-term decarbonisation of the European energy system", *International Journal of Hydrogen Energy*, vol. 41, n°1, pp. 19–35, 2016.
- [2] M. Bressel, M. Hilairet, D. Hissel, B. Ould Bouamama, "Extended Kalman Filter for prognostic of Proton Exchange Membrane Fuel Cell", *Applied Energy*, vol. 164, pp. 220-227, 2016.
- [3] J. Spendelow, D. Papageorgopoulos, J. Garbak, "Fuel Cell Technologies Program Record - Fuel Cell Stack Durability", US Department of Energy, report #11003, 2012.
- [4] I.S. Han, S.K. Park, C.B. Chung, "Modeling and operation optimization of a proton exchange membrane fuel cell system for maximum efficiency", *Energy Conversion and Management*, vol. 113, pp. 5265, 2016.
- [5] D. Hissel, "Diagnostic & health management of fuel cell systems – a state of the art", IFAC SAFEPROCESS'15 Conference, Paris, France, 2015.
- [6] R. Petrone, Z. Zheng, D. Hissel, M.C. Péra, C. Pianese, M. Sorrentino, M. Becherif, N. Yousfi-Steiner, "A review on model-based diagnosis methodologies for PEMFCs", *International Journal of Hydrogen Energy*, vol. 38, n°17, pp. 7077-7091, 2013.
- [7] M.C. Péra, D. Hissel, H. Gualous, C. Turpin, "Electrochemical Components", Chapters 1, 3, ISTE, The International Society for Technology in Education, Lavoisier, Electrical Engineering Series, London, pp. 1-355, 2013.
- [8] Z. Zheng, "On-line fault diagnosis of PEMFC stacks via non-model based methods and EIS measurements", PhD, University of Franche-Comte, Belfort, France, 2014.
- [9] X.Z. Yuan, C. Song, H. Wang, J. Zhang, "Electrochemical Impedance Spectroscopy in PEM Fuel Cells", Springer, London, UK, pp. 1-420, 2010.
- [10] E. Lechartier, E. Laffly, M.C. Péra, R. Gouriveau, D. Hissel, N. Zerhouni, "Proton exchange membrane fuel cell behavioral model suitable for prognostics", *International Journal of Hydrogen Energy*, vol. 40, n°26, pp. 8384-8397, 2015.
- [11] D. Chrenko, M.C. Péra, D. Hissel, M. Geweke, "Macroscopic modeling of a PEFC system based on equivalent circuits of fuel and oxidant supplying", *ASME Journal of Fuel Cell Science and Technology*, vol.5, n°1, pp. 011015-1/011015-8, 2008.
- [12] M. Becherif, D. Hissel, S. Gaagat, M. Wack, "Three order state space modeling of proton exchange membrane fuel cell with energy function definition", *Journal of Power Sources*, vol. 195, pp. 6645-6651, 2010.
- [13] A. Hernandez, D. Hissel, R. Outbib, "Modeling and fault diagnosis of a Polymer Electrolyte Fuel Cell using electrical equivalent analysis", *IEEE Transactions on Energy Conversion*, vol. 25, n°1, pp. 148-160, 2010.

- [14] D. Chrenko, M.C. Péra, A. Bouscayrol, D. Hissel, "Inversion-based control of a PEM Fuel Cell system using Energetic Macroscopic Representation", *ASME Journal of Fuel Cell Science and Technology*, vol. 6, pp. 024501-1/5, 2009.
- [15] B. Ould Bouamama, G. Biswas, R. Loureiro, R. Merzouki, "Graphical methods for diagnosis of dynamic systems: Review", *Annual Reviews in Control*, vol. 38, n°2, pp. 199-219, 2014.
- [16] S. Jemeï, D. Hissel, M.C. Péra, J.M. Kauffmann, "A new modeling approach of embedded fuel-cell power generators based on artificial neural network", *IEEE Transactions on Industrial Electronics*, vol. 55, n°1, pp. 437-447, 2008.
- [17] M.C. Péra, D. Hissel, J.M. Kauffmann, "Fuel cell systems for electrical vehicles: an overview", *IEEE Vehicular Technology Society News*, vol. 49, n°1, pp. 9-14, 2002.
- [18] D. Depernet, A. Narjiss, F. Gustin, D. Hissel, M.C. Péra, "Integration of Electrochemical Impedance Spectroscopy Functionality in Proton Exchange Membrane Fuel Cell Power Converter", *Journal of Power Sources*, to be published, 2016.
- [19] N. Steiner, P. Moçoteguy, D. Candusso, D. Hissel, "A review on polymer electrolyte membrane fuel cell catalyst degradation and starvation issues: causes, consequences and diagnostic for mitigation", *Journal of Power Sources*, vol. 194, n°1, pp. 130-145, 2009.
- [20] M. Gérard, J.P. Poirot-Crouvezier, D. Hissel, M.C. Péra, "Distribution Study of Species and Current Density During Oxygen Starvation", *ASME Journal of Fuel Cell Science and Technology*, vol. 7, pp. 051010-1/051010-6, 2010.
- [21] M. Gérard, J.P. Poirot-Crouvezier, D. Hissel, M.C. Péra, "Ripple Current Effects on PEMFC Ageing Test by Experimental and Modeling", *ASME Journal of Fuel Cell Science and Technology*, vol. 8, pp. 021004-1/5, 2011.
- [22] E. Pahon, S. Jemei, F. Harel, R.E. Silva Sanchez, L. Oukhellou, D. Hissel, "k-Nearest Neighbours Fault Diagnosis of Proton Exchange Membrane Fuel Cell", *International Discussion on Hydrogen Energy and Applications (IDHEA)*, Nantes, France, 9 p., 2014.
- [23] D. Hissel, S. Jemeï, V. Hubert, X. François, M.C. Péra, J.M. Kauffmann, "A diagnosis-oriented model of a fuel cell power generator dedicated to automotive applications", *ISNGVT'01 4th International Symposium on Next Generation Vehicle Technology*, pp. 49-54, Gwangju, South Korea, 2001.
- [24] W. He, T.V. Nguyen, "A New Diagnostic Tool for Liquid Water Management in PEM Fuel Cells Using Interdigitated Flow Fields" *Electrochemical Society Meeting*, Philadelphia, USA, 2002.
- [25] D. Hissel, M.C. Péra, J.M. Kauffmann, "Automotive fuel cell power generators diagnosis", *Journal of Power Sources*, vol. 128, n°2, pp. 239-246, 2004.
- [26] Z. Zheng, R. Petrone, M.C. Péra, D. Hissel, M. Becherif, C. Pianese, N. Yousfi-Steiner, M. Sorrentino, "A review on non-model based diagnosis methodologies for PEM fuel cell stacks and systems", *International Journal of Hydrogen Energy*, vol. 38, n°21, pp. 8914-8926, 2013.
- [27] D.P. Wilkinson, J. St-Pierre, "Durability", *Handbook of Fuel Cells—Fundamentals, Technology, Applications*, John Wiley, Wiley, England, 2003, pp. 611–626 (Chapter 47).
- [28] N. Steiner, D. Candusso, D. Hissel, Ph. Moçoteguy, "Model-based diagnosis for proton exchange membrane fuel cells", *Mathematics and Computer in Simulation*, vol. 81, n°2, pp. 158-170, 2010.
- [29] N. Fouquet, C. Doulet, C. Nouillant, G. Dauphin-Tanguy, B. Ould-Bouamama, "Model based PEM fuel cell state-of-health monitoring via ac impedance measurements", *Journal of Power Sources*, vol. 159, n°2, pp. 905–913, 2006.
- [30] S. Asghari, A. Mokmeli, M. Samavati, "Study of PEM fuel cell performance by electrochemical impedance spectroscopy", *International Journal of Hydrogen Energy*, vol. 35, n°17, pp.9283-9290, 2010.
- [31] A. Narjiss, D. Depernet, D. Candusso, F. Gustin, D. Hissel, "Online diagnosis of PEM fuel Cell", *IEEE 13th Power Electronics and Motion Control Conference (EPE-PEMC)*, pp. 734-739, 2008.
- [32] R. Isermann, "Fault-diagnosis systems an introduction from fault detection to fault tolerance", Berlin - New York, Springer, 2006.
- [33] V. Giurgiutiu, L. Yu, "Comparison of short-time Fourier transform and wavelet transform of transient and tone burst wave propagation signals for structural health monitoring", *Stanford University*, 2003.

- [34] J. Chen, B. Zhou, "Diagnosis of PEM fuel cell stack dynamic behaviors", *Journal of Power Sources*, vol. 177, n°1, pp. 83-95, 2008.
- [35] N. Steiner, D. Hissel, Ph. Moçoteguy, D. Candusso, "Non-intrusive diagnosis of polymer electrolyte fuel cells by wavelet packet transform", *International Journal of Hydrogen Energy*, vol. 36, n°1, pp.740-746, 2011.
- [36] A. Hernandez, D. Hissel, R. Outbib, "Fuel cell fault diagnosis: a stochastic approach", *IEEE international symposium on industrial electronics*, pp. 1984-1989, 2006.
- [37] Q. Shen, M. Hou, X. Yan, D. Liang, Z. Zang, L. Hao L et al, "The voltage characteristics of proton exchange membrane fuel cell (PEMFC) under steady and transient states", *Journal of Power Sources*, vol.179, n°1, pp.292-296, 2008.
- [38] F. Barbir, H. Gorgun, X. Wang, "Relationship between pressure drop and cell resistance as a diagnostic tool for PEM fuel cells", *Journal of Power Sources*, vol. 141, n°1, pp. 96-101, 2005.
- [39] G. Tian, S. Wasterlain, I. Endichi, D. Candusso, F. Harel, X. François et al., "Diagnosis methods dedicated to the localisation of failed cells within PEMFC stacks", *Journal of Power Sources*, vol. 182, n°2, pp.449-461, 2008.
- [40] J. Wu, X.Z. Yuan, H. Wang, M. Blanco, J.J. Martin, J. Zhang, "Diagnostic tools in PEM fuel cell research: Part I Electrochemical techniques", *International Journal of Hydrogen Energy*, vol. 33, pp. 1735-1746, 2008.
- [41] E. Pahon, L. Oukhellou, F. Harel, S. Jemeï, D. Hissel, "Fault Diagnosis and Identification of Proton Exchange Membrane Fuel Cell Using Electrochemical Impedance Spectroscopy Classification", *Electrimacs'2014 conference*, 6 p., Valencia, Spain, 2014.
- [42] D. Hissel, D. Candusso, F. Harel, "Fuzzy clustering durability diagnosis of embedded polymer electrolyte fuel cells", *IEEE Transactions on Vehicular Technology*, vol. 56, n°5, pp. 2414-2420, 2007.
- [43] Z. Zheng, M.C. Péra, D. Hissel, M. Becherif, K.S. Agbli, Y. Li, "A double-fuzzy diagnostic methodology dedicated to on-line fault diagnosis of proton exchange membrane fuel cell stacks", *Journal of Power Sources*, vol. 271, pp. 570-581, 2014.
- [44] J. Chen, B. Zhou, "Diagnosis of PEM fuel cell stack dynamic behaviors", *Journal of Power Sources*, vol. 177, n°1, pp. 83-95, 2008.
- [45] Z. Li, R. Outbib, S. Giurgea, D. Hissel, Y. Li, Li, Z., "Fault detection and isolation for PEMFC system by analyzing cell voltage generated space", *Applied Energy*, vol. 148, pp. 260-272, 2015.
- [46] Z. Li, R. Outbib, D. Hissel, S. Giurgea, "Control engineering practice data-driven diagnosis of PEM fuel cell: a comparative study", *Control Engineering Practice*, vol. 28, pp. 1-12, 2014.
- [47] R. Gouriveau, D. Hissel, "PHM of fuel cell systems", *IEEE International Conference on PHM*, Denver, USA, 2012.