



**HAL**  
open science

# Thermoelectricity Engineering (modules, performance, applications)

Daniel Champier

► **To cite this version:**

Daniel Champier. Thermoelectricity Engineering (modules, performance, applications). Doctoral. France. 2019. hal-02367539

**HAL Id: hal-02367539**

**<https://hal.science/hal-02367539>**

Submitted on 18 Nov 2019

**HAL** is a multi-disciplinary open access archive for the deposit and dissemination of scientific research documents, whether they are published or not. The documents may come from teaching and research institutions in France or abroad, or from public or private research centers.

L'archive ouverte pluridisciplinaire **HAL**, est destinée au dépôt et à la diffusion de documents scientifiques de niveau recherche, publiés ou non, émanant des établissements d'enseignement et de recherche français ou étrangers, des laboratoires publics ou privés.



Ecole thématique du CNRS  
Organisée par le GIS «Thermoélectricité»

6 au 11 octobre 2019

La Bresse

***Approches pluridisciplinaires de la thermoélectricité : bases,  
théorie, matériaux et applications***



# Thermoelectricity Engineering (modules, performance, applications)

**Daniel CHAMPIER**

*Laboratoire des Sciences de l'Ingénieur Appliquées à la Mécanique  
et au Génie Electrique (SIAME)*

**Université de Pau et des Pays de l'Adour France**

[Daniel.champier@univ-pau.fr](mailto:Daniel.champier@univ-pau.fr)

# Presentation

## Applications of Thermoelectricity

### •1. Introduction

Description of the elements of a thermoelectric generator.

Concept of thermal

Power and Efficiency of thermoelectric generators.

Modules marketed or in the process of being marketed.

### •2. Design of thermoelectric generators

Modeling of thermoelectric modules

Complete generator model (from heat sources to electrical storage including electrical converters)

Design and optimization

Study of an example and practical aspects

### •3. Applications

Production in extreme environments

Waste Heat Recovery (WHR)

Domestic production

Microgeneration: sensors, connected objects (IOT)

Thermoelectric solar power

Cooling

Metrology

## Thermoelectricity

# Market from market research companies

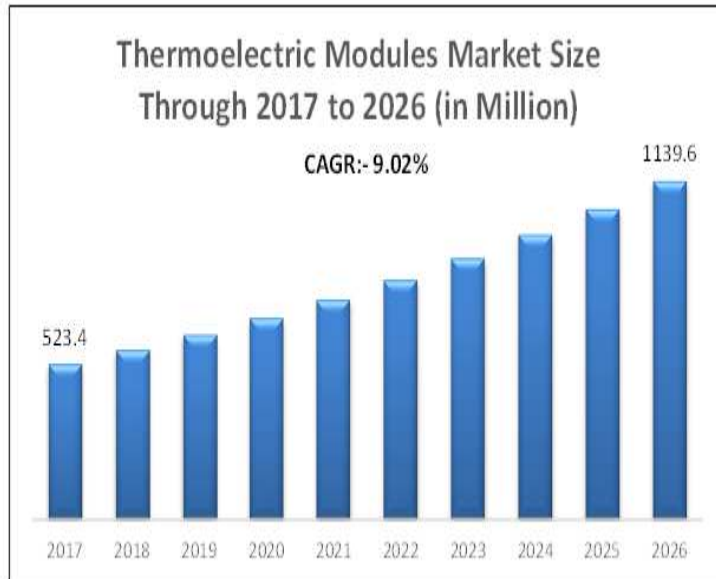

Source: Maximize Market Research

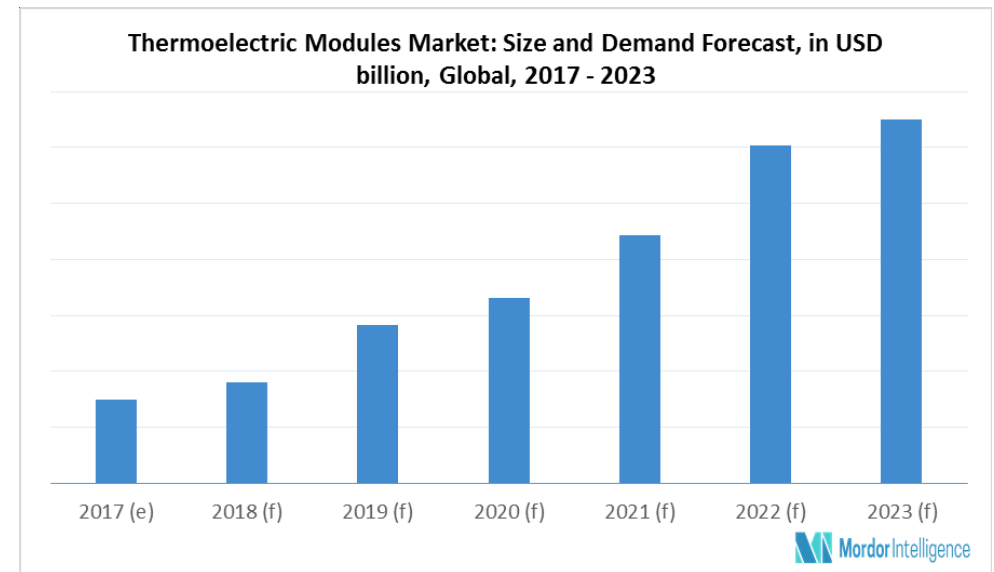

**Let's be optimistic**

# elements of a thermoelectric generator

## One couple of a seebeck module

consists of one N-Type and one P-type semiconductor pellet

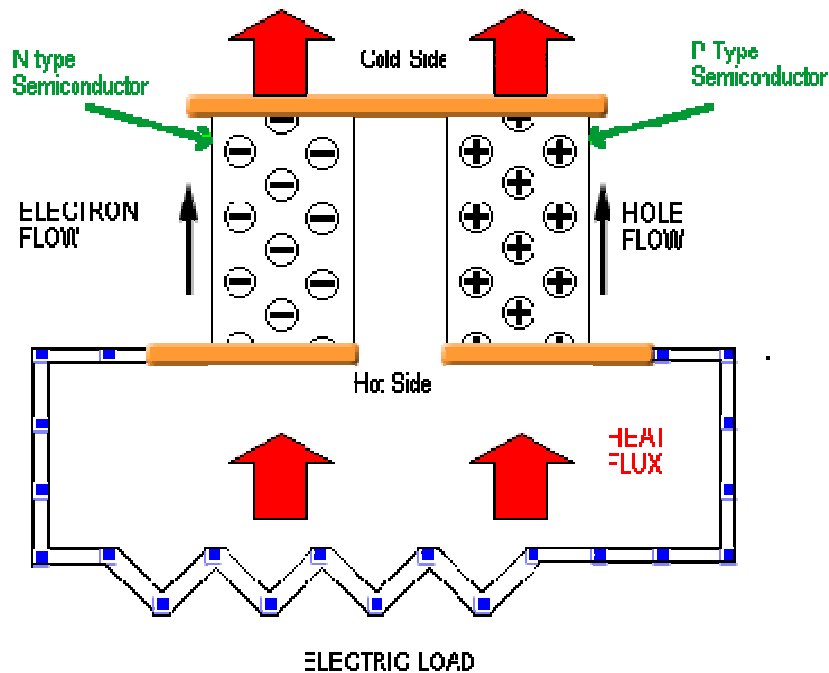

➤ figure of merit  $Z = \frac{\sigma \cdot \alpha^2}{\lambda}$

$\sigma$  is the electrical conductivity  
 $\lambda$  is the thermal conductivity

➤ dimensionless figure of merit ZT

$$ZT = \frac{\sigma \cdot \alpha^2 \cdot T}{\lambda} \quad T = \frac{T_h + T_c}{2}$$

ZT is a very convenient figure for comparing the potential efficiency of devices using different materials.

Values of  $ZT=1$  are considered good

$\text{Bi}_2\text{Te}_3$  ZT is about 1

# elements of a thermoelectric generator

## ➤ TE modules

individual couples connected electrically in series

Thermally in parallel to enhance the effect

Semiconductor P and N

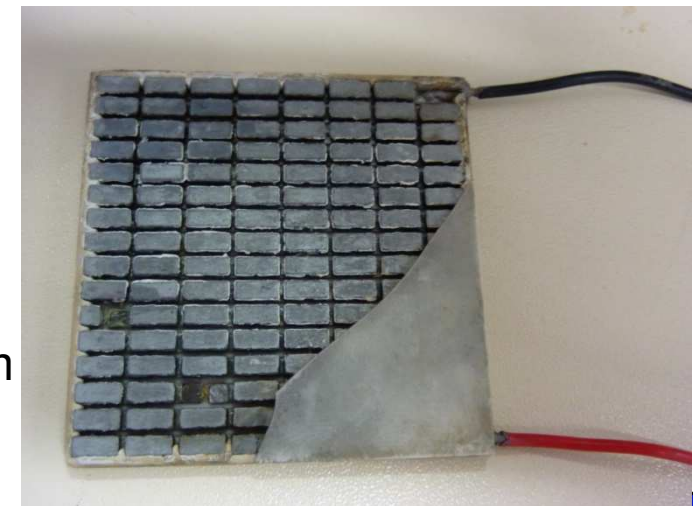
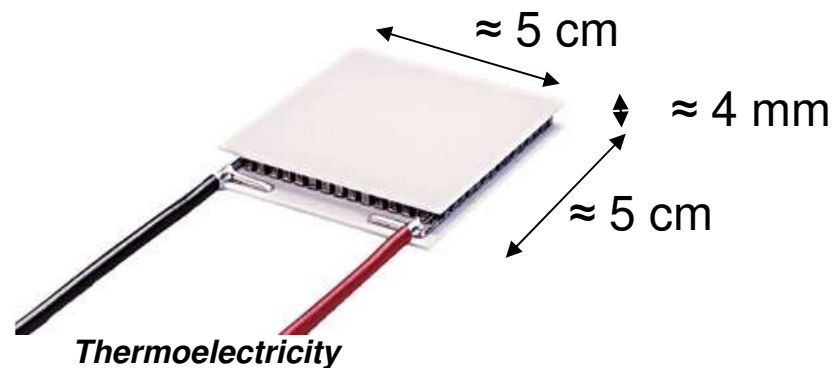
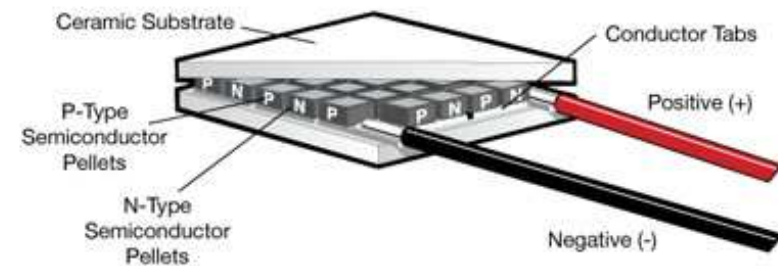
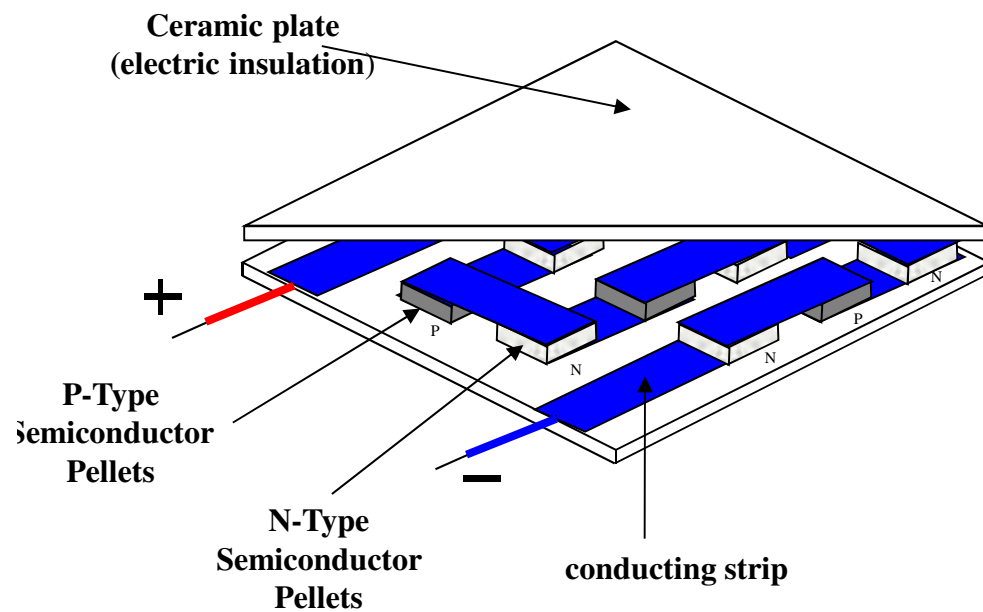

# elements of a thermoelectric generator

## Advantages of thermoelectric modules

- **Direct Energy Conversion**
- **No Moving Parts**
- **No Working Fluids**
- **Maintenance-free Durability**
- **High reliability: solid state construction.**
- **Small size and weight.**
- **Electrically and acoustically "quiet" Operation**
- **Operation in any orientation : aerospace and moving applications.**
- **Extreme climatic conditions (hot, cold, wet, dry)**

# Design of a ThermoElectric Generator TEG

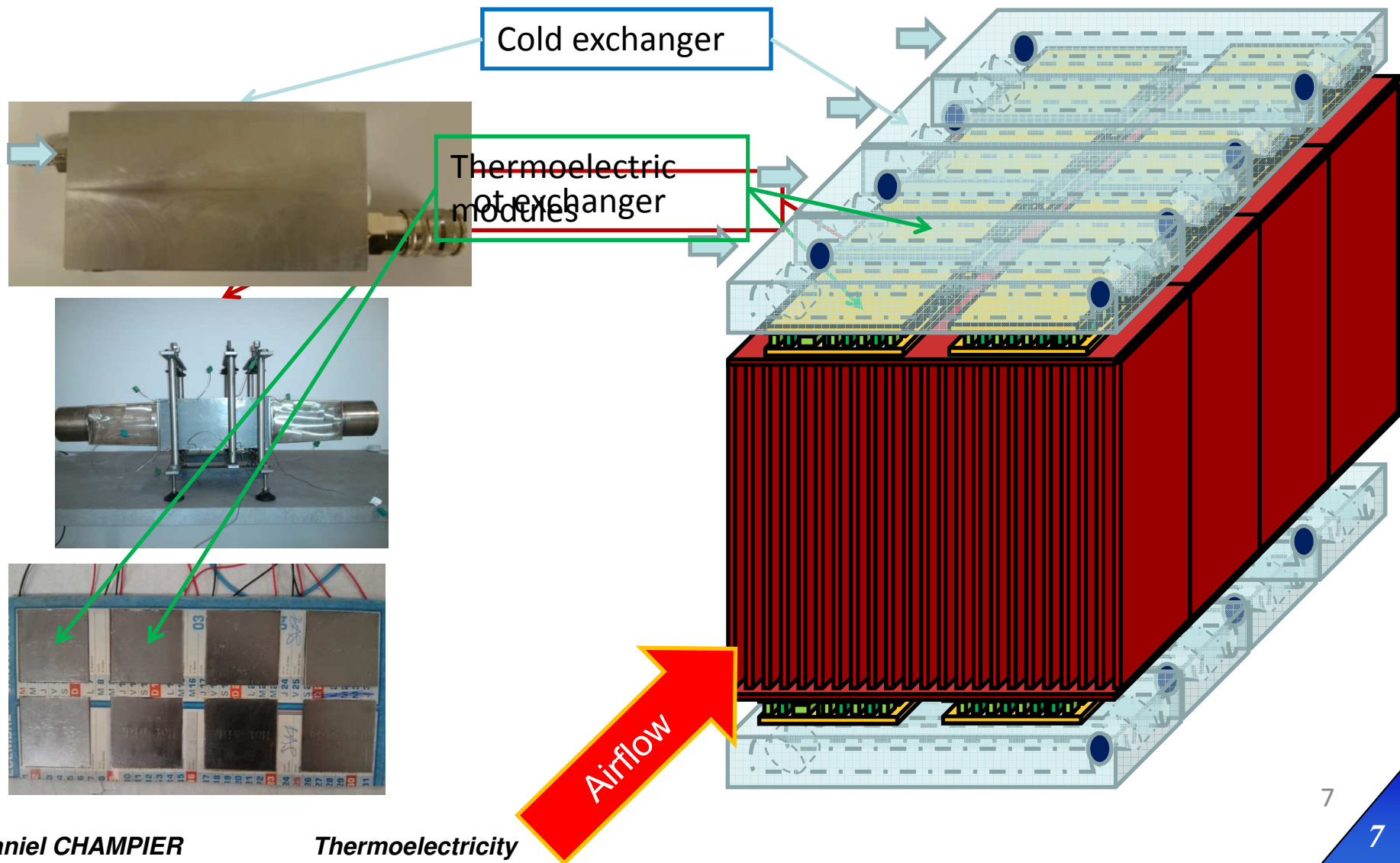



# Thermoelectric (TE) Generators TEG

*convert directly a very small part of the heat moving through them into electricity*

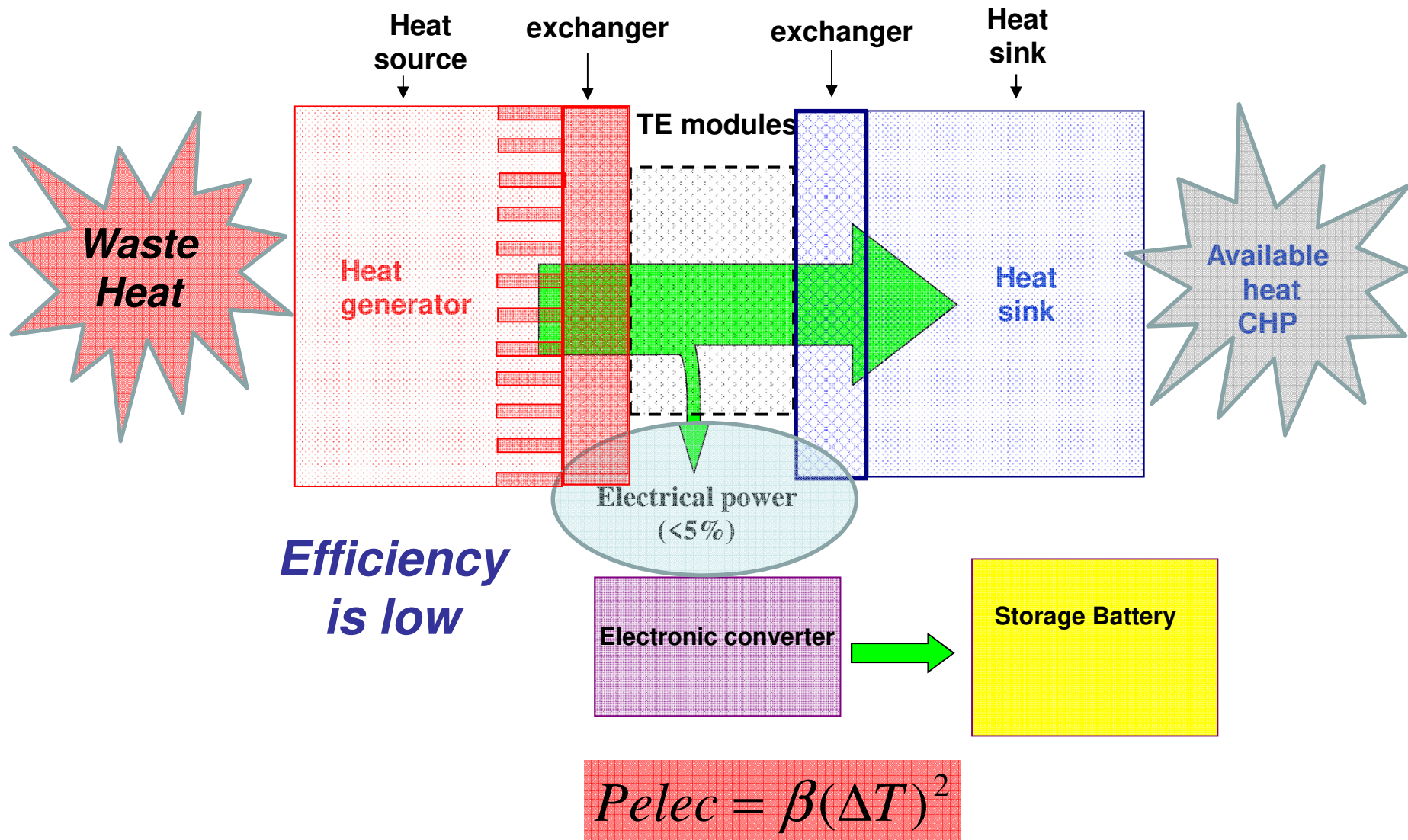

# Generality about Heat Transfer

## 3 Heat Transfer Modes

### 1) Conduction heat transfer

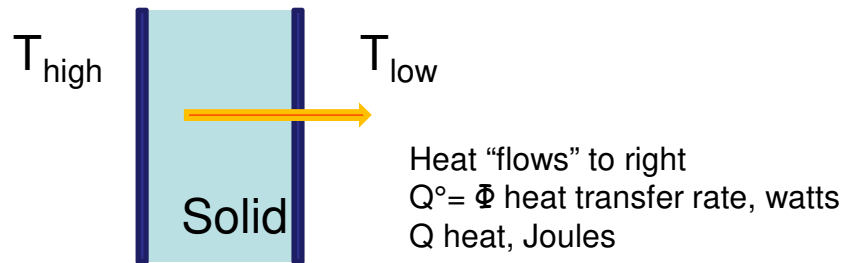

### 2) Convection heat transfer : heat transfer due to a flowing fluid. The fluid can be a gas or a liquid

### 3) radiation : transmission of energy through space without the necessary presence of matter.

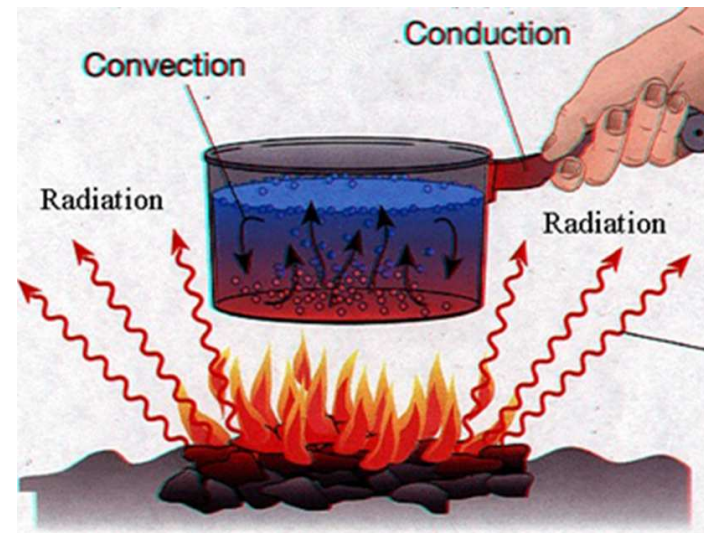

Picture: University of Wisconsin

# Generality about Heat Transfer

Conduction heat transfer (steady state case)

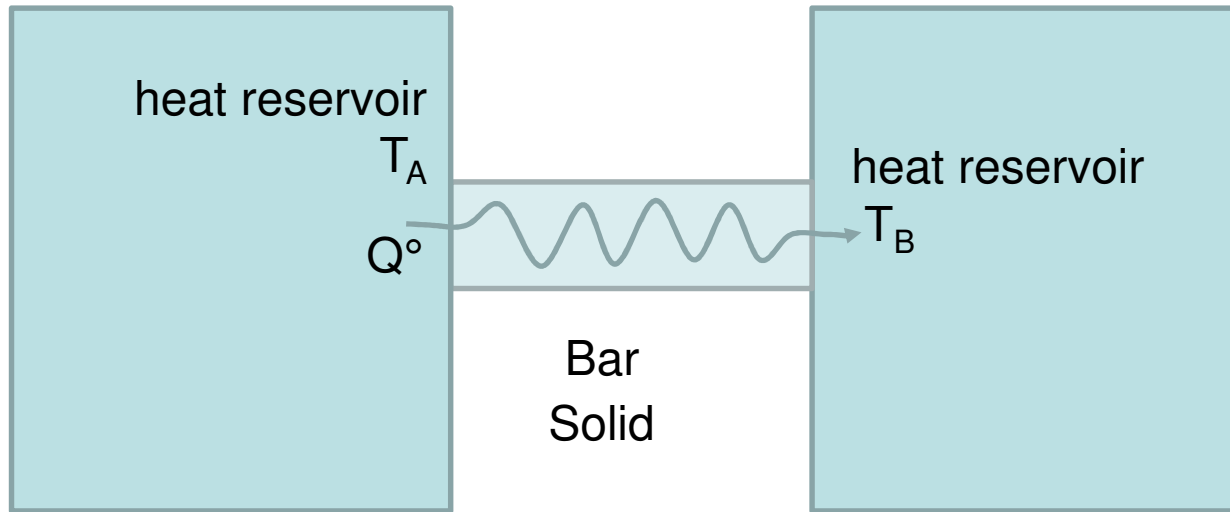

$\dot{Q} = \Phi$  heat transfer rate (W) (**flux de chaleur, puissance thermique, flux thermique**) is a function of the temperature of the two reservoirs, the bar geometry and the bar properties.

$$\dot{Q} = \frac{\lambda A}{L}(T_a - T_b) = \frac{(T_a - T_b)}{R_{th}} = G_{th} (T_a - T_b)$$

A area of the bar  
L length of the bar  
 $\lambda$  thermal conductivity ( $\text{W}\cdot\text{m}^{-1}\text{K}^{-1}$ )  
 $R_{th}$  Thermal resistance  
 $G_{th}$  Thermal conductance

Metals	Ag	Cu	Al	Fe	Steel
$\lambda$ [W/m-K]	420	390	200	70	50

Non-Metals	H <sub>2</sub> O	Air	Brics	Wood	Cork
$\lambda$ [W/m-K]	0.6	0.026	0.4-0.5	0.2	0,04

Solid means no moving particles

# Generality about Heat Transfer

## Analogy Heat transfer and Electricity

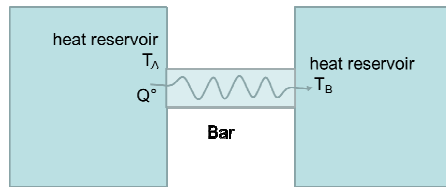

$$\dot{Q} = \frac{(T_a - T_b)}{R_{th}} \quad (\text{W})$$

$$R_{th} = \frac{L}{\lambda \cdot A} \quad (\text{K} \cdot \text{W}^{-1})$$

$\lambda$  thermal conductivity ( $\text{W} \cdot \text{m}^{-1} \text{K}^{-1}$ )

Convection, radiation and loss  
are also here

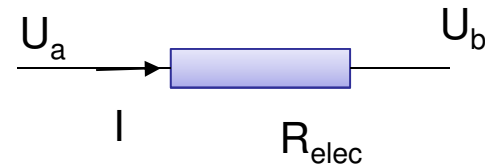

$$I = \frac{(U_a - U_b)}{R}$$

$$R_{elec} = \frac{\rho L}{A} = \frac{L}{\sigma \cdot A}$$

$\sigma$  electrical conductivity ( $\text{S/m}$ )

Almost perfect  
insulation

# Generality about Heat Transfer

Conduction heat transfer (steady state case)

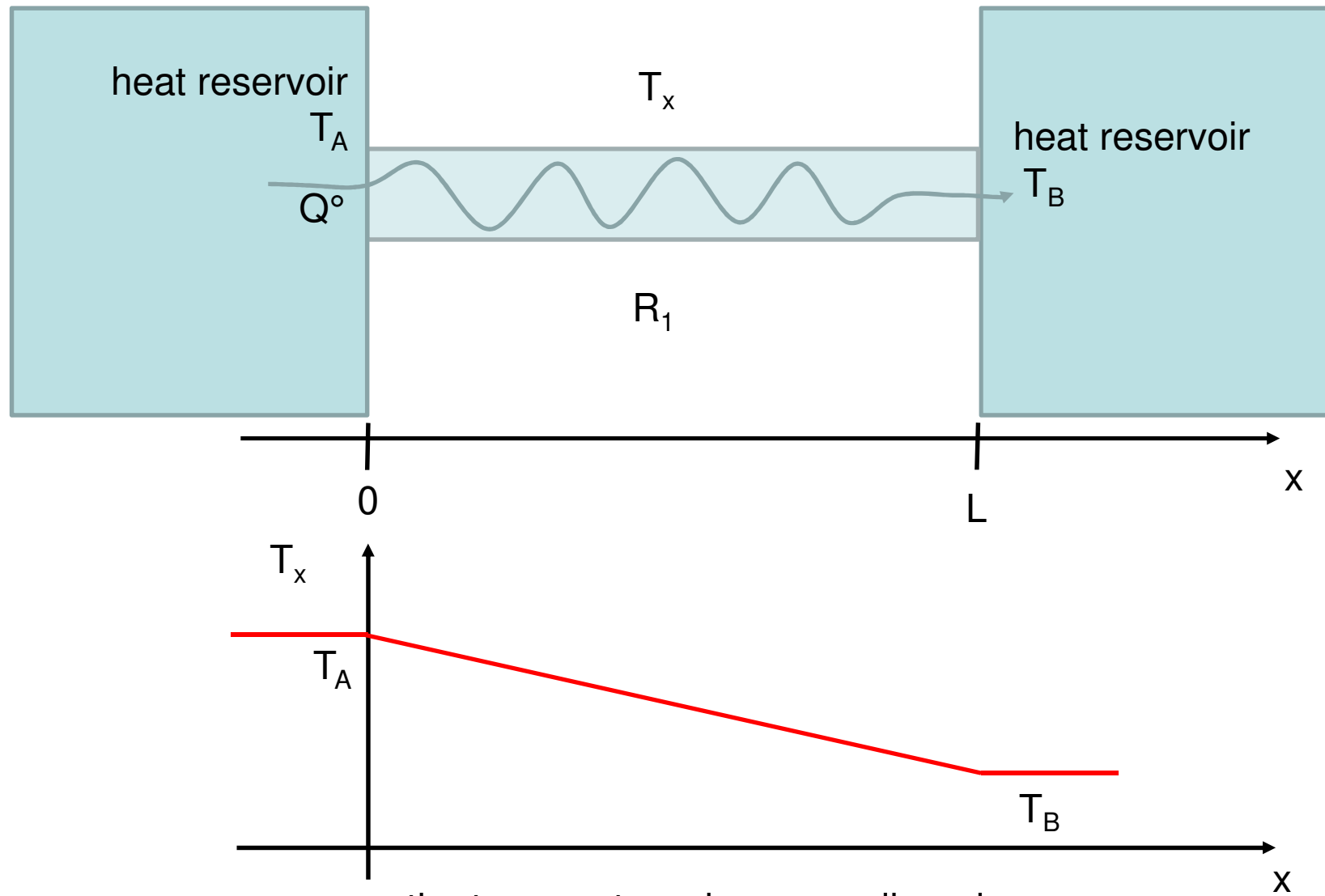

# Generality about Heat Transfer

Conduction heat transfer (steady state case)

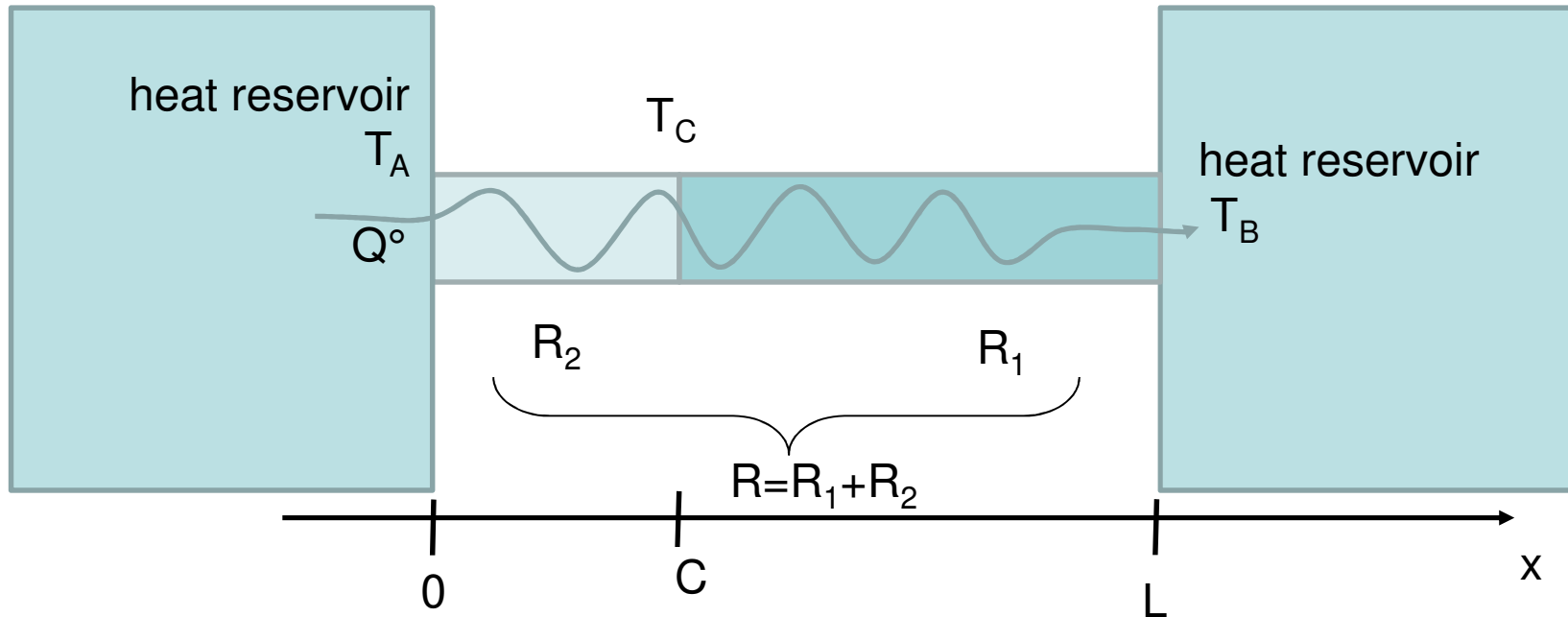

$$\dot{Q} = \frac{T_C - T_B}{R_1} = \frac{T_A - T_B}{R_1 + R_2}$$

$$T_C - T_B = \frac{R_1}{R_1 + R_2} (T_A - T_B)$$

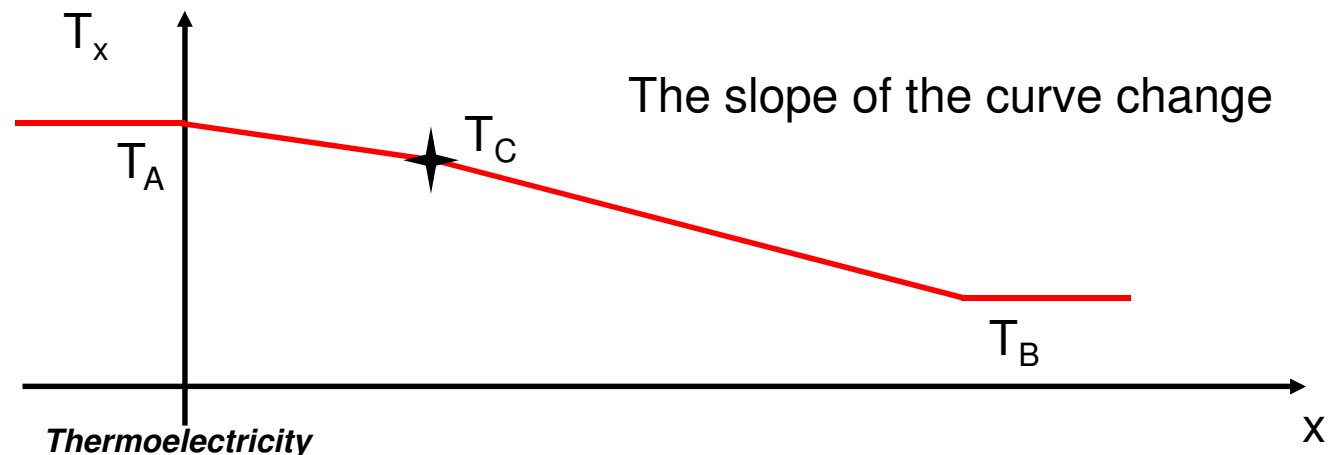

# Generality about Heat Transfer

## Conduction heat transfer (steady state case)

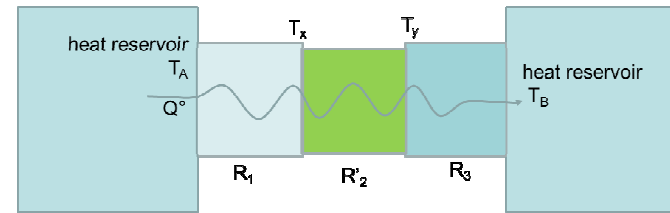
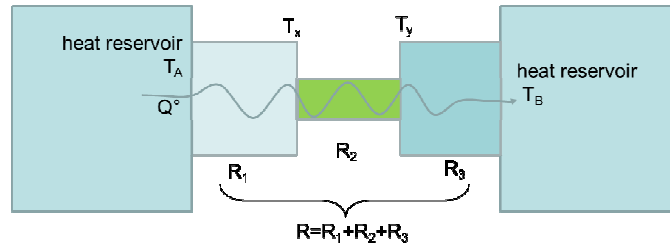

$$\dot{Q} = \frac{T_x - T_y}{R_2} = \frac{T_A - T_B}{R_1 + R_2 + R_3}$$

$$T_x - T_y = \frac{R_2}{R_1 + R_2 + R_3} (T_A - T_B)$$

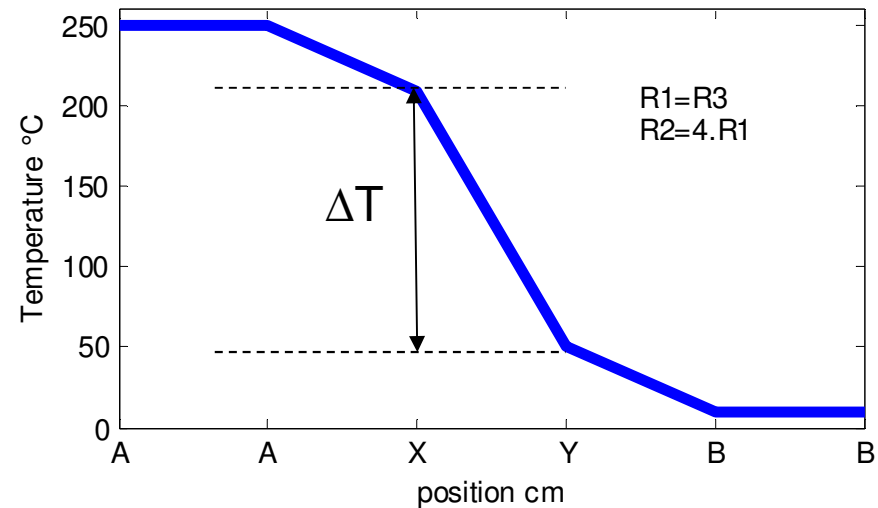
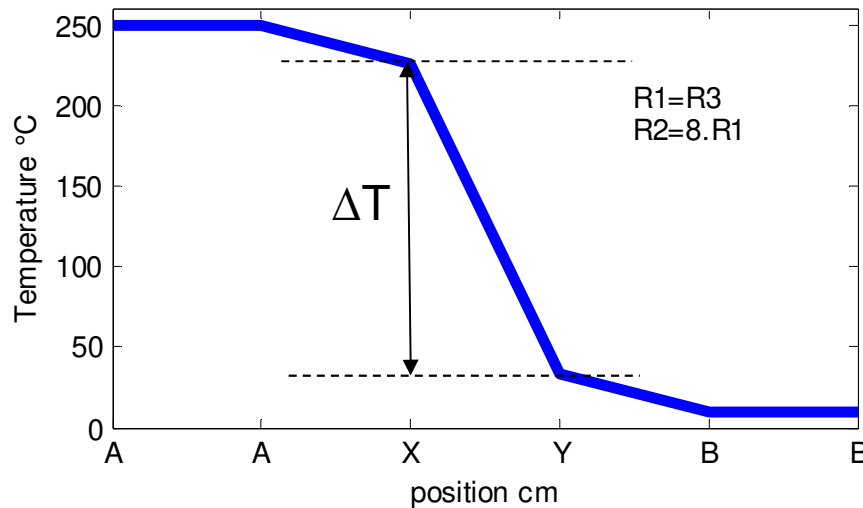

1 module  $P = K \Delta T^2$

2 modules  $P = 2K \Delta T'^2$

# Generality about Heat Transfer

## Convective heat transfer

air moving near a blade or a fin for example

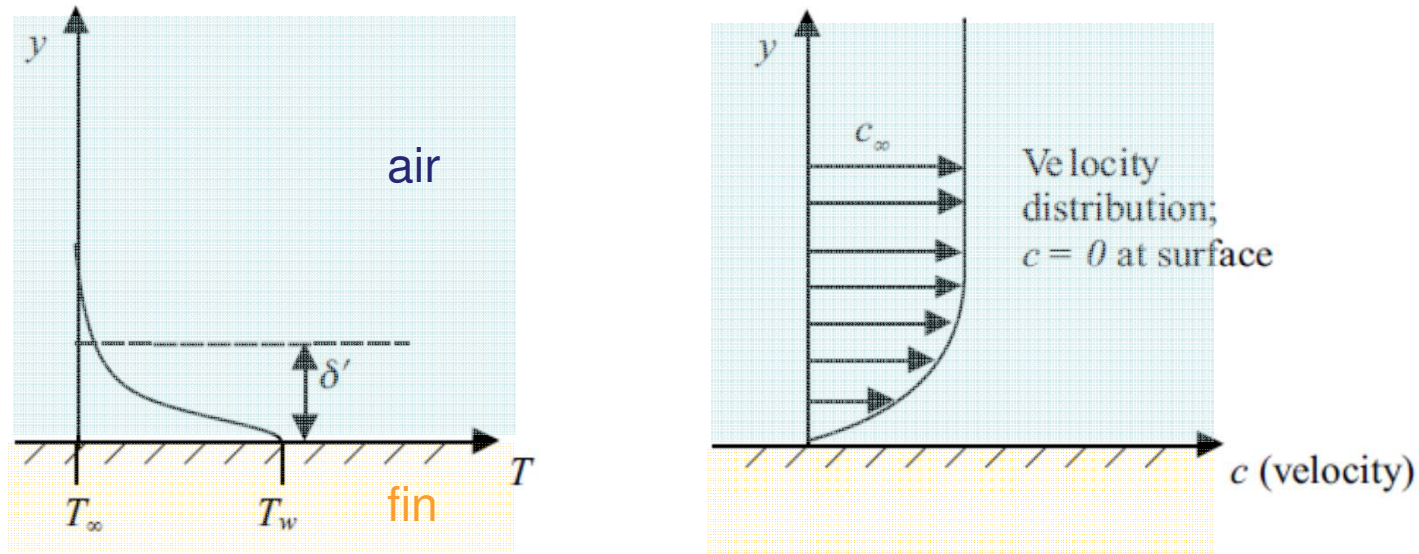

Region of thickness  $\delta'$  : thin "film" of slowly moving fluid  
 → most of the temperature difference occurs.

Outside this layer,  $T$  is roughly uniform

$$\dot{Q} = h \cdot A \cdot (T_w - T_\infty)$$

$h$  : convective heat transfer coefficient ( $\text{W}/\text{m}^2\text{K}$ )  
 $h$  is known mainly through experiments



# Generality about Heat Transfer

## Convective heat transfer

$$\dot{Q} = h \cdot A \cdot (T_w - T_\infty)$$

$h$  : convective heat transfer coefficient (W/m<sup>2</sup>K)

$h$  is known mainly through experiments

$$R_{th} = \frac{1}{h \cdot A}$$

### Typical values

Conditions of heat transfer	W/(m <sup>2</sup> K)
Gases in free convection	5–37
Water in free convection	100–1200
Oil under free convection	50–350
Gas flow in tubes and between tubes	10–350
Water flowing in tubes	500–1200
Oil flowing in tubes	300–1700
Molten metals flowing in tubes	2000–45000
Water nucleate boiling	2000–45000
Water film boiling	100–300
Film-type condensation of water vapor	4000–17000
Drops-size condensation of water vapor	30000–140000
Condensation of organic liquids	500–2300

# Generality about Heat Transfer

## Radiation Heat Transfer

All bodies radiate energy in the form of photons moving in a random direction, with random phase and frequency. When radiated photons reach another surface, they may either be absorbed, reflected or transmitted.

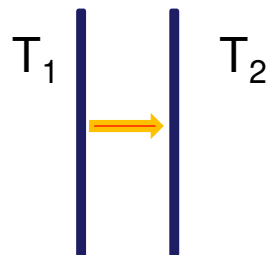
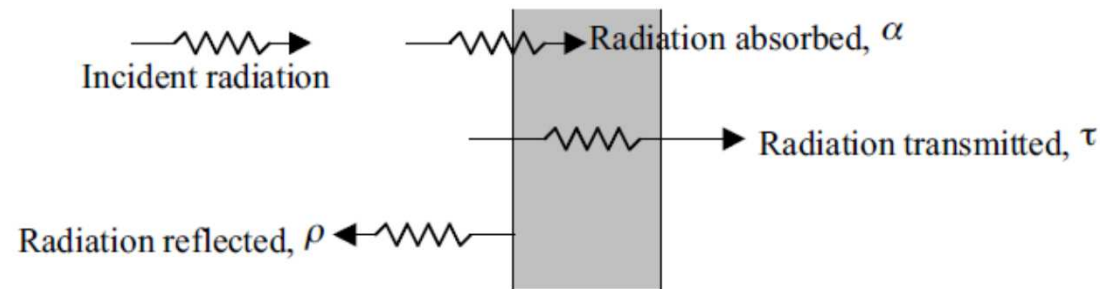

transfer between gray, planar, surfaces

$$\dot{Q} = \frac{\sigma \cdot A \cdot (T_1^4 - T_2^4)}{\frac{1}{\varepsilon_1} + \frac{1}{\varepsilon_2} - 1}$$

$\sigma$  is the Stefan-Boltzmann constant  
 $\sigma = 5.67 \cdot 10^{-8} \text{ W/m}^2\text{K}^4$   
 $\varepsilon$  emissivity : property of material  
 $T_1$  and  $T_2$  : Kelvin

Material	Emissivity
Aluminum polished	0.03
Aluminum Heavily oxidized	0.2 - 0.33
Asphalt	0.88
Brick	0.90
Concrete, rough	0.91
Copper, polished	0.04
Copper, oxidized	0.87
Paint	0.8 - 0.96
Paper white	0.95 to 0.98

# Maximum Power and Efficiency

These results will be explained in detail later

## Electrical Power

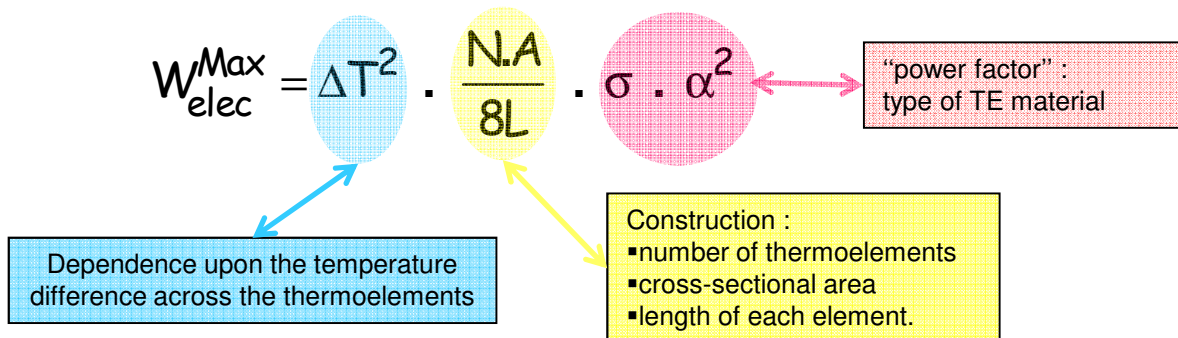

## Efficiency

$$\eta_{max} = \frac{W_{elec}}{\Phi_{thermal}} = \frac{\Delta T}{T_h} \cdot \frac{\sqrt{1+zT} - 1}{\sqrt{1+zT} + \frac{T_c}{T_h}}$$

Efficiency is a function of zT

$$z = \frac{\alpha^2}{\rho\lambda} = \frac{\sigma \cdot \alpha^2}{\lambda} \quad T = \frac{(T_h + T_c)}{2}$$

Efficiency is low

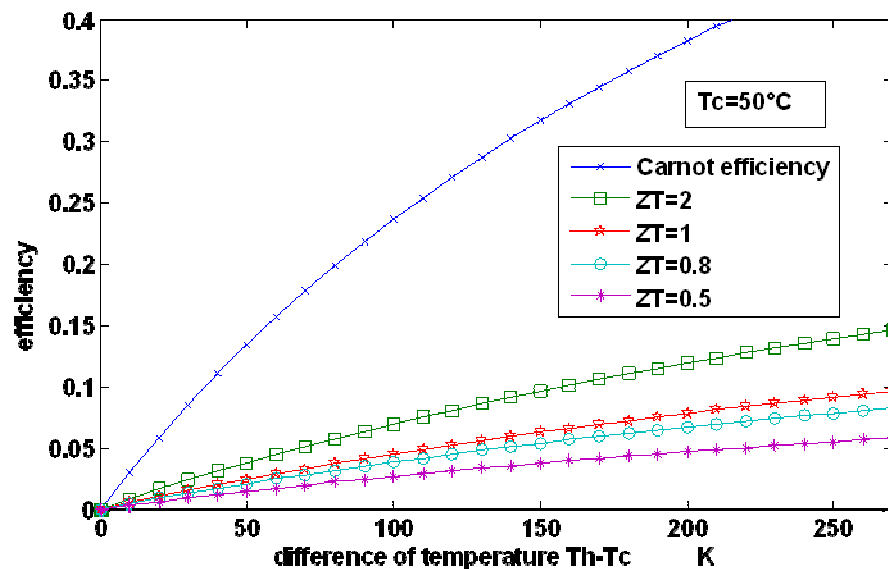

Main goals

Augment ZT

Augment  $\Delta T$

# ZT of Materials

## Laboratory

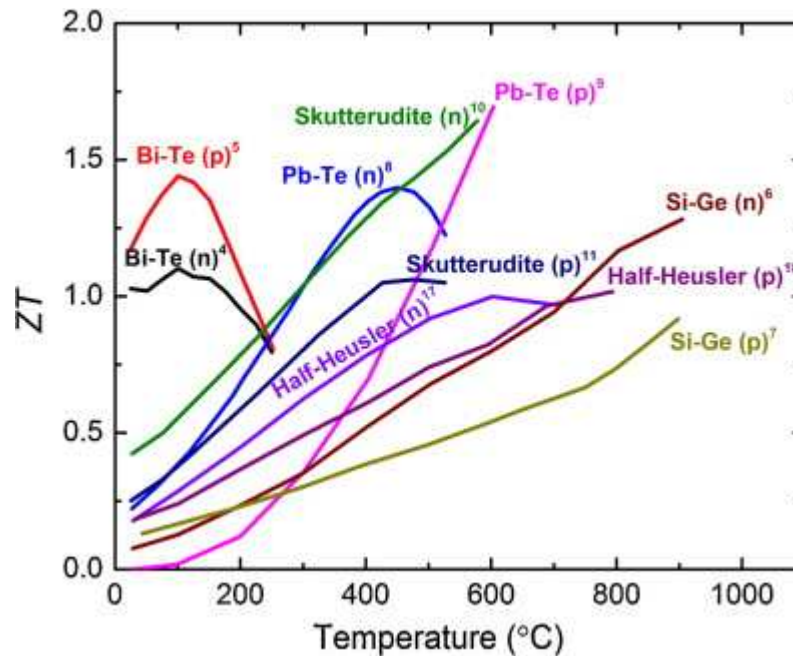

Overview of ZT vs temperature for different thermoelectric materials \*

\* Shuo Chen, Zhifeng Ren Recent progress of half-Heusler for moderate temperature thermoelectric applications materialstoday

## Industry

Industrial ingot (Thermonamic 2015)

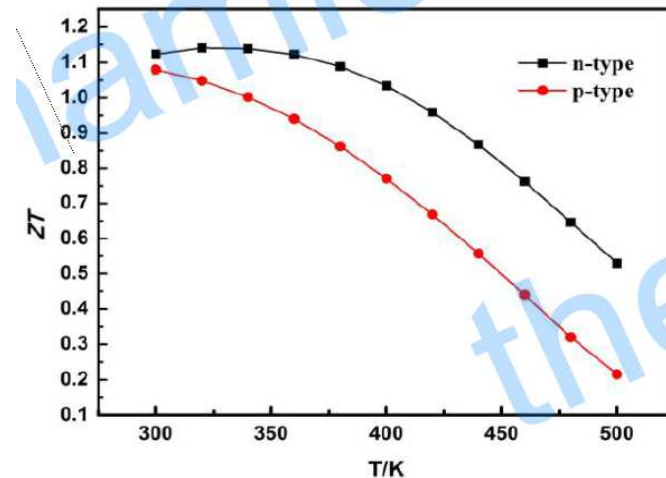

ZT values of the  $\text{Bi}_2\text{Te}_3$ -based ingot

**$\text{Bi}_2\text{Te}_3$  ZT is about 1**  
the only commercial module available at large scale

# From materials to modules

## Example of production in laboratory

### New lab-scale pilot line at Fraunhofer IPM

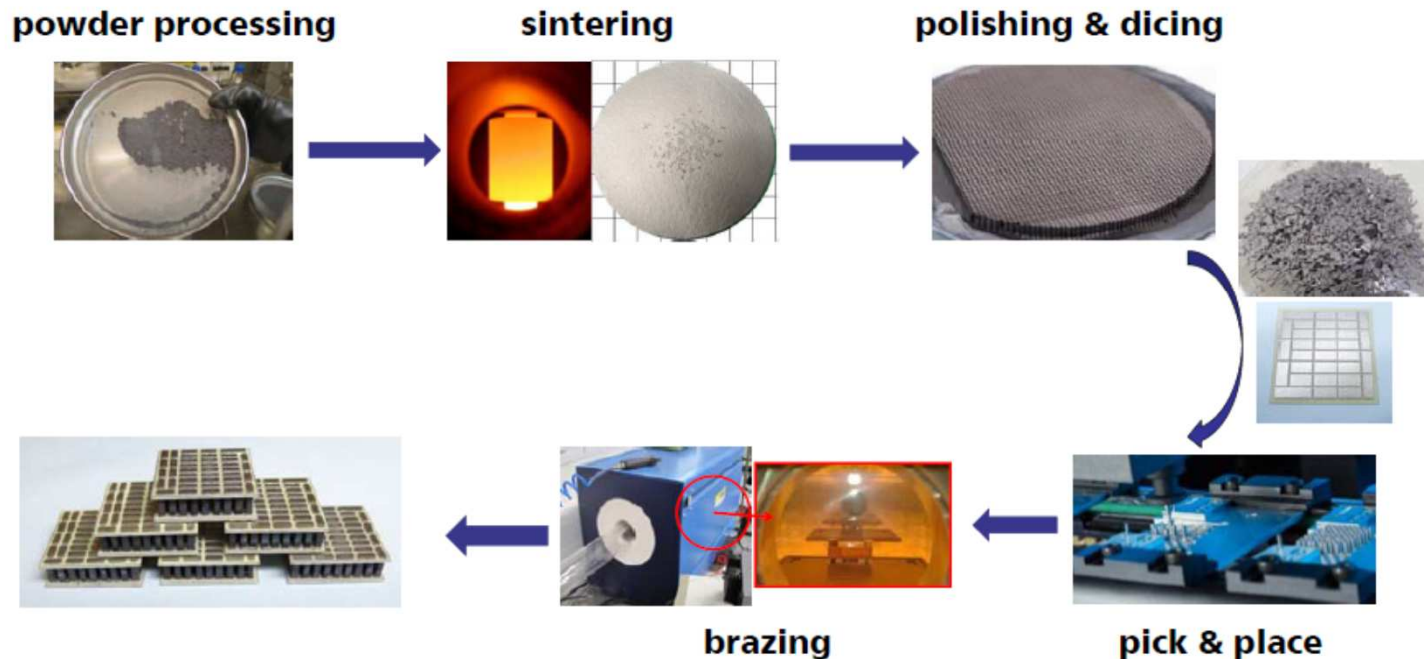

Thermoelectric modules (TEM) based on half-Heusler compounds

\* *Lab-scale pilot line for Thermoelectric Modules based on half-Heusler Compounds* J. D. König, M. Kluge, K. Bartholomé, E. Geczi, U. Vetter, M. Vergez, U. Nussel, K. R. Tarantik

# Industrial modules

manufacturer	Materials	$\Delta T$	Power	state	T Max	
HiZ, Thermonamic, Lairdtech, Marlow, etc.	$\text{Bi}_2\text{Te}_3$	300 K	20 W	40€-100€	300 °C	historical Scarce
Evident Thermoelectric <b>IsabellenHütte</b>	Half Heusler	500 K	15W	Coming soon <b>Lab available</b>	600°C	environmental-friendly, low cost, availability of raw materials
Shanghai Institute of Ceramics	skuterrudites	510 K	25W	Coming soon	600°C	environmental-friendly, low cost, availability of raw materials
TEGMA	skuterrudites			Coming soon		
TEGNOLOGY	$\text{Zn}_4\text{Sb}_3/\text{Mg}_2\text{SiSn}$ Zintl Phase	105 K	9 mW	Available 100€	125°C	
TECTEG MFR	Calcium/Manganese oxide	750 K	12.3W	Available 360\$	800°C	environmental-friendly, low cost, availability of raw materials. Weight : 6g
TECTEG MFR cascade modules	Calcium/Manganese oxides with $\text{Bi}_2\text{Te}_3$	435 K	11 W	Available 560\$	600°C	
Hotblock Onboard	silicon based alloy	500 K	3.6W	Available 200€	600°C	environmental-friendly, low cost, availability of raw materials. Weight : 6g
<del>Romny Scientific</del>	magnesium silicide					low \$/Watt
<del>Alphabet Energy</del>	p-type tetrahedrites n-type magnesium silicide ( $\text{Mg}_2\text{Si}$ )			<del>Coming soon</del>		Tetrahedrite is a naturally occurring p-type mineral
D.	Organics TEG	low		Still in lab	130°	

# Market for TEG

## Global Thermoelectric Generator (TEG) Modules Sales Market Research Report 2018 to 2025

Published (2018) By: QY RESEARCH

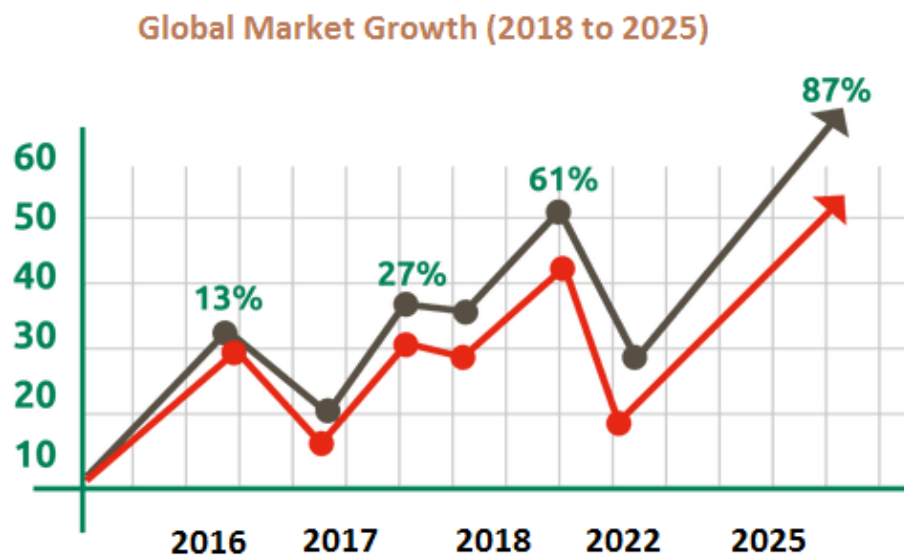

## Thermoelectric Modules Market- Leader

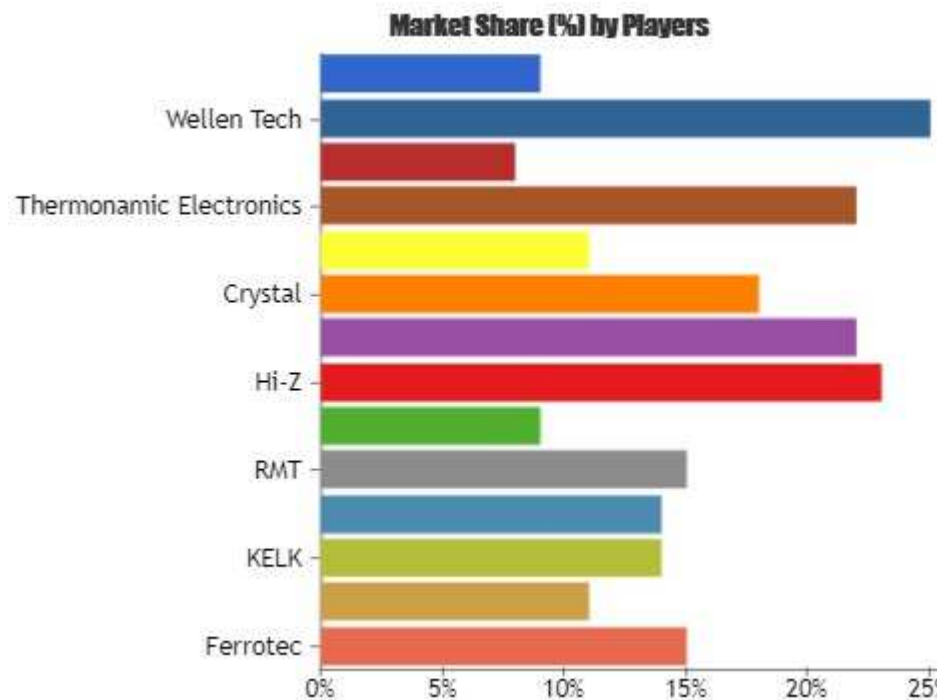

Nidhi Bhawsar June 26, 2018

# List of Thermoelectric / Peltier Manufactures, Companies and Suppliers major manufacturers

Applied Thermoelectric Solutions LLC
Acal BFI
Adcol Electronic
ADV Engineering
Alflex Technologies
Align Sourcing
Ambient Micro
<b>AMS Technologies</b>
Analog Technologies
Asia Inno
Beijing Huimao Cooling Co., Ltd.
Bentek Systems
BTS Europe
Cidete Ingenieros SL
<b>CUI</b>
Custom Thermoelectric Inc.
<b>Crystal LTD.</b>
European Thermodynamics
Everredtronics Ltd.
<b>Ferrotec Corporation</b>
Gentherm
Gentherm Global Power
Green TEG AG

Guang Dong Fuxin Electronic
Hangzhou Aurin Cooling
Hebei IT
Hicooltec Electronic
<b>Hi-Z Technology, Inc</b>
HotBlock OnBoard
Hui mao
Interm
<b>Kelk Ltd.</b>
<b>Kryotherm</b>
<b>Laird Tech Inc.</b>
<b>II-VI Marlow</b>
INB Thermoelectric
ISA Impex
Innoveco
Merit Technology Group
Micropelt GmbH
Newmark International
OTE International
<b>P&amp;N Tech</b>
Perpetua Power
Phononic
Qinhuangdao Fulianjing

Quick Cool
RFI Corp.
<b>RMT LTD</b>
Sheetak
S&PF Modul
Taicang TE Cooler
TE Technology, Inc.
TEC Microsystems
TECTEG
TEGEOS
TEGPRO Thermoelectric Generator
Termo-Gen AB
Thermal Electronics
Thermalforce
Thermion Company
Thermix
<b>Thermonamic Electronics</b>
Tybang Electronics
UWE Electronic
<b>Wellen Tech</b>
WeTEC
Yamaha
Z-max



## Modeling of thermoelectric modules

### Simplified Thermoelectric Equations and properties

Assumptions:

The material properties are temperature independent  
Calculations will be made in steady state conditions

# Thermoelectric equations (single couple)

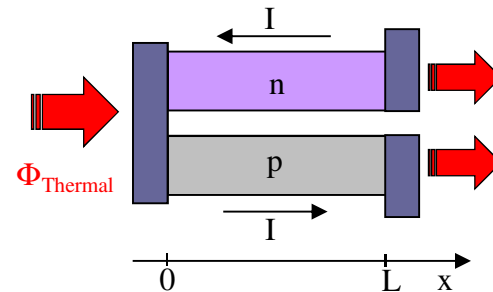

Assumption :

all the heat flow between the source and sink takes place within the thermocouple.

Thermal radiation and losses by conduction and convection through the surrounding medium are negligible.

The two thermocouple branches in our model have constant cross-sectional areas.

Thomson effects neglected.

For each branch of the thermoelectric module we have one thermoelectric flow (Peltier ) and a heat flow (conduction) :

$$\Phi_p = \Pi_p \times I - \lambda_p \times S_p \times \frac{dT}{dx} = \alpha_p \times I \times T - \lambda_p \times S_p \times \frac{dT}{dx} \quad (1)$$

$$\Phi_n = -\alpha_n \times I \times T - \lambda_n \times S_n \times \frac{dT}{dx}$$

$\lambda$  is the thermal conductivity of the material [ $W \cdot m^{-1} \cdot K^{-1}$ ],

$\Pi$  is the Peltier coefficient of the material [V]

$\alpha$  is the Seebeck coefficient of the material [ $V \cdot K^{-1}$ ]

$I$  is the norm of the electric current [A] which explains the minus sign in front.

# Thermoelectric equations (single couple)

conservation of energy to a differential control volume through which energy transfer is exclusively by conduction.

Heat equation in Cartesian Coordinates:

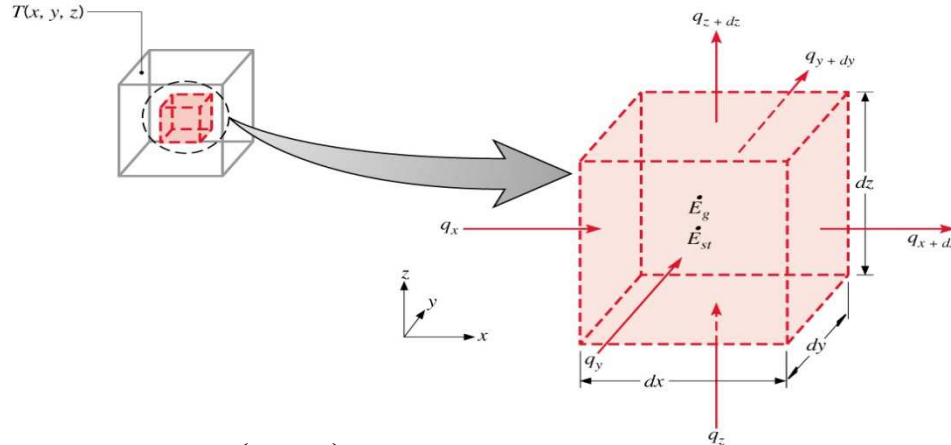

$$\underbrace{\frac{\partial}{\partial x} \left( \lambda \frac{\partial T}{\partial x} \right) + \frac{\partial}{\partial y} \left( \lambda \frac{\partial T}{\partial y} \right) + \frac{\partial}{\partial z} \left( \lambda \frac{\partial T}{\partial z} \right)}_{\text{Net transfer of thermal energy into the control volume (inflow-outflow)}} + \underbrace{\phi}_{\text{Thermal energy generation}} = \underbrace{\rho_m c_p}_{\text{Change in thermal energy storage}} \frac{\partial T}{\partial t}$$

$\rho_m$  is the specific weight       $C_p$  is the specific heat capacity       $\phi$  is the power density

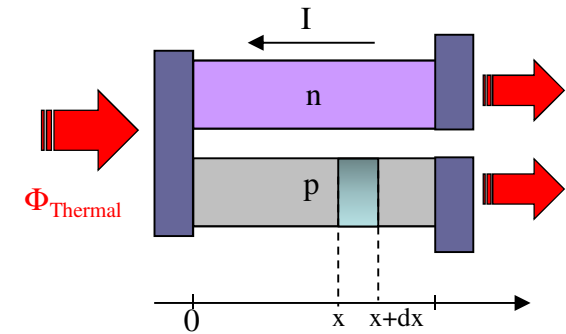

control volume : a slice along x

All the heat flow between the source and sink takes place within the thermocouple. Thus, thermal radiation and losses by conduction and convection through the surrounding medium are negligible.

It is therefore possible to neglect the temperature variations along the axes y and z.

All this brings us to solve a one-dimensional problem along the x axis

The heat equation can be written in this case

$$\frac{\partial^2 T}{\partial x^2} + \frac{\phi}{\lambda} = \frac{1}{a} \times \frac{\partial T}{\partial t}$$

$a = \lambda / c_p \cdot \rho$  is the thermal diffusivity

with  $\phi = \rho \frac{dx}{dz \cdot dy} \cdot I^2 \cdot \frac{1}{dx \cdot dy \cdot dz} = \frac{\rho}{S^2} I^2 \left[ \frac{W}{m^3} \right]$  heat generation by Joule effect       $\rho$  is the electrical resistivity

$S$  is the section of a leg

# Thermoelectric equations (single couple)

heat equation  $\frac{1}{a} \times \frac{\partial T}{\partial t} = \frac{\partial^2 T}{\partial x^2} + \frac{\phi}{\lambda}$  with  $\phi = \frac{I^2 \times \rho}{S^2}$

**Steady state.** The left term disappears.  $0 = \frac{\partial^2 T}{\partial x^2} + \frac{\phi}{\lambda} = \frac{\partial^2 T}{\partial x^2} + \frac{I^2 \times \rho}{\lambda \cdot S^2}$

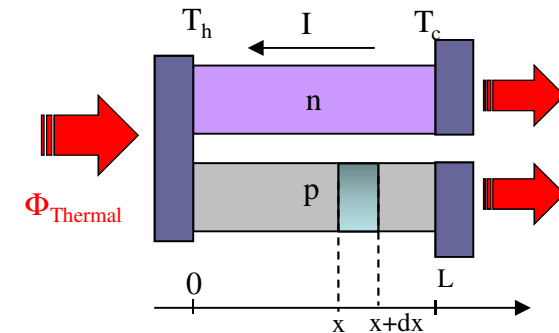

We have for each leg:  $-\lambda_p \times S_p \times \frac{\partial^2 T}{\partial x^2} = \frac{I^2 \times \rho_p}{S_p}$  and  $-\lambda_n \times S_n \times \frac{\partial^2 T}{\partial x^2} = \frac{I^2 \times \rho_n}{S_n}$  (2)

If we solve equation 2 for the branch p :

$$\lambda_p \times S_p \times \frac{\partial T}{\partial x} = - \left( \frac{I^2 \times \rho_p}{S_p} \right) x + B \quad (3a)$$

$$\lambda_p \times S_p \times T(x) = - \left( \frac{I^2 \times \rho_p}{2 \times S_p} \right) x^2 + Bx + C \quad (3b)$$

**Boundary conditions:**  $T(x=0) = T_h$  and  $T(x=L) = T_c$

for  $x=0$  we have :  $C = \lambda_p \times S_p \times T_h$

for  $x=L_p$  we have  $\lambda_p \times S_p \times T_c = - \left( \frac{I^2 \times \rho_p \times L_p^2}{2 \times S_p} \right) + B \times L_p + \lambda_p \times S_p \times T_h$

$$B = \frac{\lambda_p \times S_p \times (T_c - T_h)}{L_p} + \left( \frac{I^2 \times \rho_p \times L_p}{2 \times S_p} \right)$$

If we replace B in (3a)

$$\lambda_p \times S_p \times \frac{\partial T}{\partial x} = - \left( \frac{I^2 \times \rho_p \times \left( x - \frac{L_p}{2} \right)}{S_p} \right) + \frac{\lambda_p \times S_p \times (T_c - T_h)}{L_p} \quad (4.1)$$

and if we follow the same reasoning for the N-doped leg

$$\lambda_n \times S_n \times \frac{\partial T}{\partial x} = - \left( \frac{I^2 \times \rho_n \times \left( x - \frac{L_n}{2} \right)}{S_n} \right) + \frac{\lambda_n \times S_n \times (T_c - T_h)}{L_n} \quad (4.2)$$

# Thermoelectric equations (single couple)

$$\Phi_p = \alpha_p \times I \times T \left( \lambda_p \times S_p \times \frac{dT}{dx} \right) \quad (1) \quad \left( \lambda_p \times S_p \times \frac{\partial T}{\partial x} = - \left[ \frac{I^2 \times \rho_p \times \left( x - \frac{L_p}{2} \right)}{S_p} \right] + \frac{\lambda_p \times S_p \times (T_c - T_h)}{L_p} \right) \quad (4.1)$$

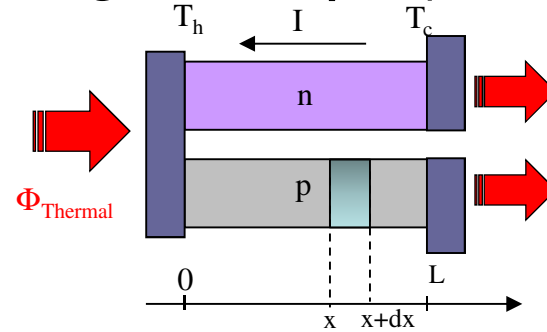

By combining (1) and (4):

$$\begin{aligned} \Phi_p &= \alpha_p \times I \times T + \frac{I^2 \times \rho_p \times \left( x - \frac{L_p}{2} \right)}{S_p} - \frac{\lambda_p \times S_p \times (T_c - T_h)}{L_p} \\ \Phi_p(x=0) &= \alpha_p \times I \times T_h - \frac{I^2 \times \rho_p \times L_p}{2 \times S_p} - \frac{\lambda_p \times S_p \times (T_c - T_h)}{L_p} \\ \Phi_p(x=L_p) &= \alpha_p \times I \times T_c + \frac{I^2 \times \rho_p \times L_p}{2 \times S_p} - \frac{\lambda_p \times S_p \times (T_c - T_h)}{L_p} \end{aligned}$$

$$\begin{aligned} \Phi_n &= -\alpha_n \times I \times T + \frac{I^2 \times \rho_n \times \left( x - \frac{L_n}{2} \right)}{S_n} - \frac{\lambda_n \times S_n \times (T_c - T_h)}{L_n} \\ \Phi_n(x=0) &= -\alpha_n \times I \times T_h - \frac{I^2 \times \rho_n \times L_n}{2 \times S_n} - \frac{\lambda_n \times S_n \times (T_c - T_h)}{L_n} \\ \Phi_n(x=L_p) &= -\alpha_n \times I \times T_c + \frac{I^2 \times \rho_n \times L_n}{2 \times S_n} - \frac{\lambda_n \times S_n \times (T_c - T_h)}{L_n} \end{aligned}$$

If we sum  $\Phi_p(x=0)$  and  $\Phi_n(x=0)$  we get the power at the hot side of the system  $\Phi_h$ .

Similarly if we sum  $\Phi_p(x=L)$  and  $\Phi_n(x=L)$  we obtain the power at the cold side  $\Phi_c$ .

$$\begin{aligned} \Phi_h &= (\alpha_p - \alpha_n) \times I \times T_h - \left( \frac{\rho_n \times L_n}{S_n} + \frac{\rho_p \times L_p}{S_p} \right) \frac{I^2}{2} - \left( \frac{\lambda_n \times S_n}{L_n} + \frac{\lambda_p \times S_p}{L_p} \right) \times (T_c - T_h) \\ \Phi_c &= (\alpha_p - \alpha_n) \times I \times T_c + \left( \frac{\rho_n \times L_n}{S_n} + \frac{\rho_p \times L_p}{S_p} \right) \frac{I^2}{2} - \left( \frac{\lambda_n \times S_n}{L_n} + \frac{\lambda_p \times S_p}{L_p} \right) \times (T_c - T_h) \\ W_{elec} &= \Phi_h - \Phi_c = (\alpha_p - \alpha_n) \times I \times (T_h - T_c) - r \times I^2 \end{aligned}$$

## Simplified Thermoelectric Equations for a single couple

With  $r = \frac{\rho_n \times L_n}{S_n} + \frac{\rho_p \times L_p}{S_p}$  the electrical resistance of a pair of legs PN.

$k = \frac{\lambda_n \times S_n}{L_n} + \frac{\lambda_p \times S_p}{L_p}$  the overall heat transfer coefficient of a pair of legs PN.

$\alpha = \alpha_p - \alpha_n$  the Seebeck coefficient of the thermocouple PN

$$\Phi_h = \alpha \times I \times T_h - \frac{r \times I^2}{2} + k \times (T_h - T_c)$$

$$\Phi_c = \alpha \times I \times T_c + \frac{r \times I^2}{2} + k \times (T_h - T_c)$$

$$W_{elec} = \alpha \times I \times (T_h - T_c) - r \times I^2$$

# Thermoelectric equations (modules)

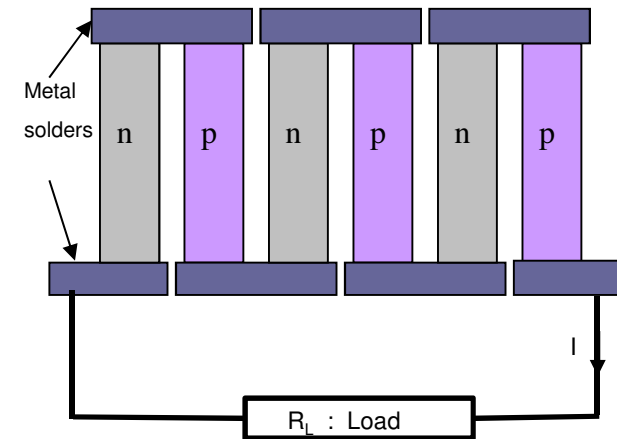
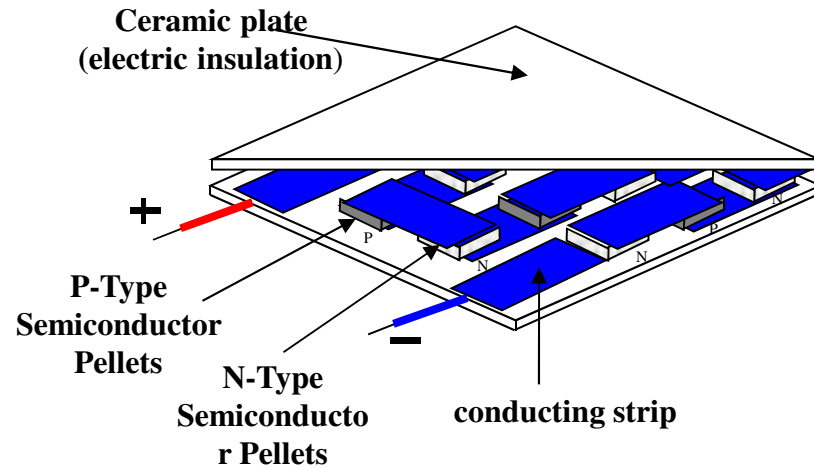

The n-type and p-type thermoelements are electrically connected in serie by a conductor, and thermally in parallel.  
**The conductor is assumed to have negligible electrical resistance and thermal resistance.**

$$\Phi_h = N \cdot \left( \alpha \times I \times T_h - \frac{r \times I^2}{2} + k \times (T_h - T_c) \right)$$

$$\Phi_c = N \cdot \left( \alpha \times I \times T_c + \frac{r \times I^2}{2} + k \times (T_h - T_c) \right)$$

$$W_{elec} = N \cdot (\alpha \times I \times (T_h - T_c) - r \times I^2)$$

$$r = \frac{\rho_n \times L_n}{S_n} + \frac{\rho_p \times L_p}{S_p}$$

$$k = \frac{\lambda_n \times S_n}{L_n} + \frac{\lambda_p \times S_p}{L_p}$$

$$\alpha = \alpha_p - \alpha_n$$

N number of couples (2N legs)

Assuming that the cross sections of the legs are the same ( $S_n = S_p$ ) and considering the leg lengths equal ( $L_n = L_p$ ) we can write:

$$K = N \frac{(\lambda_n + \lambda_p) \times S}{L} \quad R = N \frac{(\rho_n + \rho_p) \times L}{S}$$

Simplified Thermoelectric Equations for a module

$$\Phi_h = N \cdot \alpha \times I \times T_h - \frac{R \times I^2}{2} + K \times (T_h - T_c)$$

$$\Phi_c = N \cdot \alpha \times I \times T_c + \frac{R \times I^2}{2} + K \times (T_h - T_c)$$

$$W_{elec} = N \cdot \alpha \times I \times (T_h - T_c) - R \times I^2$$

# Electrical model of TE module

$$W_{elec} = N \cdot \alpha \times I \times (T_h - T_c) - R \times I^2$$

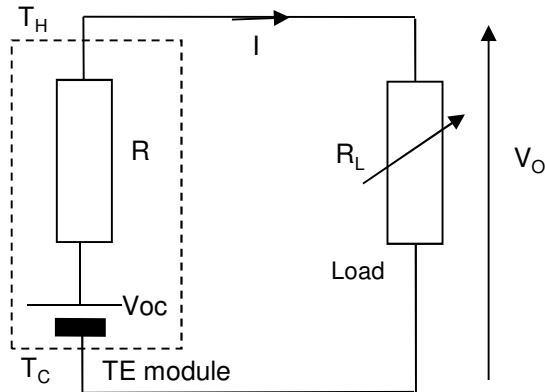

The module can be modeled as a voltage source  $V_{oc}$  with internal resistance  $R$

$$V_{oc} = N \cdot \alpha (T_h - T_c) \quad R = N \frac{(\rho_n + \rho_p) \times L}{S}$$

A load resistor  $R_L$  is connected to the module

$$I = \frac{V_{oc}}{R + R_L} = \frac{N \cdot \alpha (T_h - T_c)}{R + R_L} = \frac{N \cdot \alpha \cdot \Delta T}{R + R_L}$$

$W_{elec}$  can also be written :

$$W_{elec} = R_L \cdot I^2 = \frac{R_L}{(R + R_L)^2} N^2 \cdot \alpha^2 \cdot \Delta T^2$$

## Maximizing power output from a module

By differentiating  $W_{elec}$  with respect to  $R_L$  we can find the value of load resistance that gives the maximum output power.

$$\frac{\partial W_{elec}}{\partial R_L} = \frac{(R - R_L)}{(R + R_L)^3} N^2 \cdot \alpha^2 \cdot \Delta T^2 = 0$$

Adapted load  $R_L = R$

we can find the the maximum output power.

$$W_{elec}^{Max} = \frac{N^2 \cdot \alpha^2 \cdot \Delta T^2}{4 \cdot R} = \Delta T^2 \cdot \frac{N \cdot S}{4L(\rho_n + \rho_p)} \alpha^2 = \Delta T^2 \cdot \frac{N \cdot S}{8L} \cdot \frac{2}{(\rho_n + \rho_p)} \alpha^2 = \Delta T^2 \cdot \frac{N \cdot S}{8L} \cdot \frac{\alpha^2}{\rho_{pn}} = \Delta T^2 \cdot \frac{N \cdot S}{8L} \cdot \sigma_{pn} \alpha^2$$

$R = \frac{N(\rho_n + \rho_p) \times L}{S}$ 
 $\rho_{pn} = \frac{\rho_n + \rho_p}{2}$ 
 $\sigma_{pn} = \frac{1}{\rho_{pn}} = \frac{2\sigma_p \sigma_n}{\sigma_p + \sigma_n}$



# Maximizing power output from a module

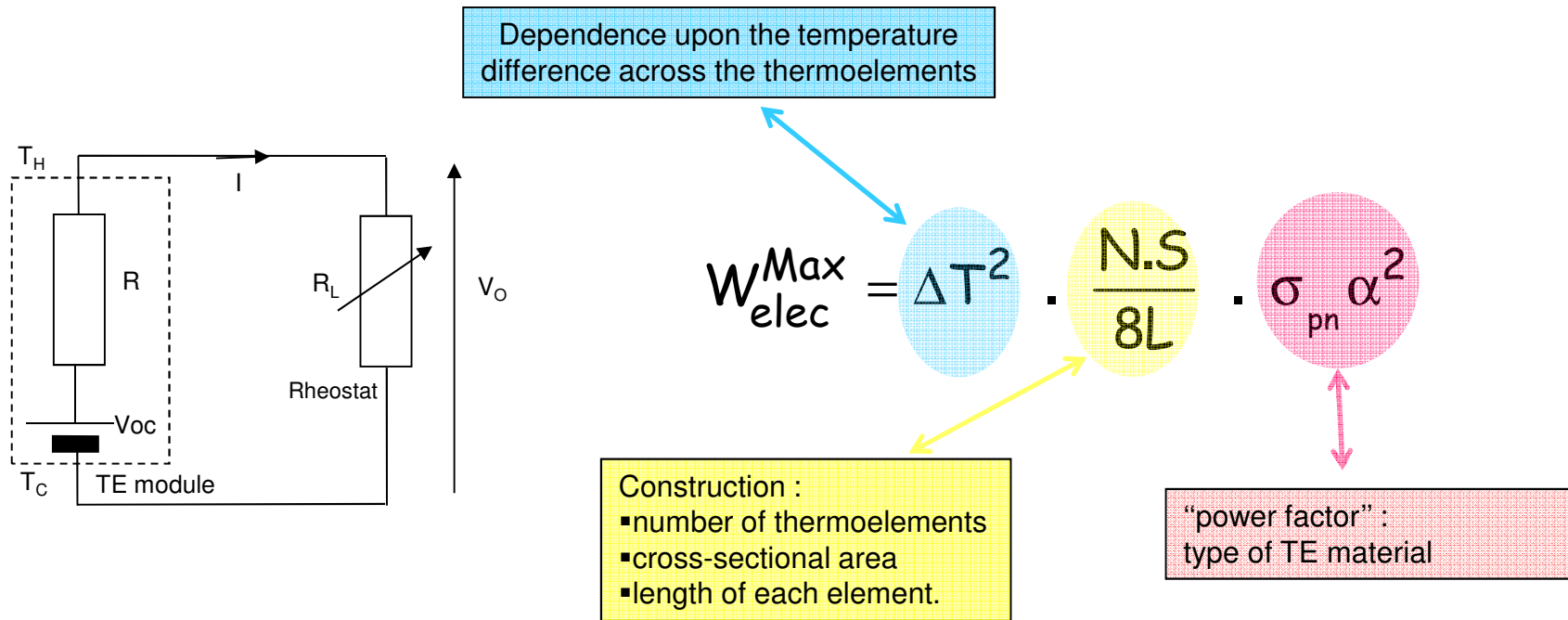

The thermal conductivity,  $\lambda$ , does not appear and so does not directly impact the maximum power.

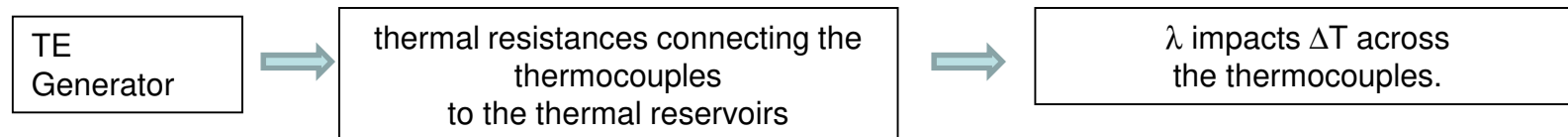



# Maximizing Efficiency

The input power is the heat entering the hot junction

$$\Phi_H = N\alpha_{pn} \times I \times T_h - \frac{R \times I^2}{2} + K \times \Delta T$$

The output power is the electrical energy

$$W_{elec} = R_L \cdot I^2 = \frac{R_L}{(R + R_L)^2} N^2 \cdot \alpha^2 \cdot \Delta T^2$$

Efficiency  $\eta = \frac{W_{elec}}{\Phi_H} = \frac{\frac{R_L}{(R + R_L)^2} N^2 \cdot \alpha^2 \cdot \Delta T^2}{N \cdot \alpha_{pn} \times I \times T_h - \frac{R \times I^2}{2} + K \times \Delta T}$

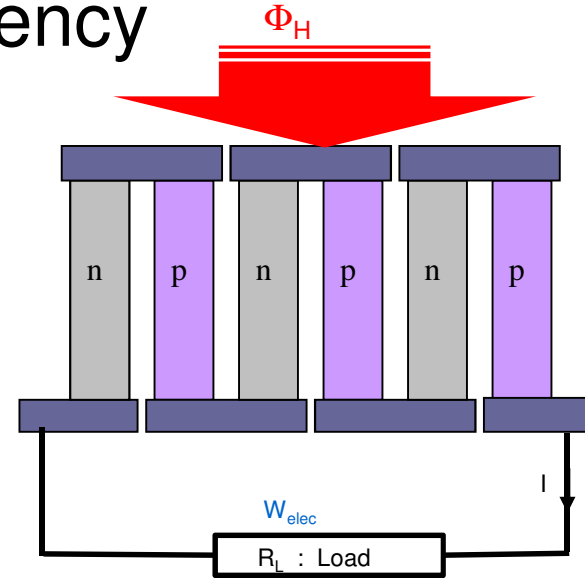

After some calculations and by defining

$$m = \frac{R_L}{R}$$

$$\eta = \frac{W_{elec}}{\Phi_H} = \frac{\Delta T}{T_h} \cdot \frac{\frac{m}{m+1}}{1 + \frac{KR(m+1)}{N^2 \cdot \alpha^2 T_h} - \frac{\Delta T}{2T_h \cdot (m+1)}}$$

Carnot efficiency

by defining  $z = \frac{N^2 \cdot \alpha^2}{K \cdot R} = \frac{\alpha^2}{4\rho_{pn} \cdot \lambda_{pn}} = \frac{\alpha^2}{\rho \cdot \lambda} = \frac{\sigma \cdot \alpha^2}{\lambda}$

$\rho = \rho_n + \rho_p = 2\rho_{pn}$        $\lambda = \lambda_n + \lambda_p$        $\alpha = \alpha_p - \alpha_n$

Figure of merit

The efficiency becomes

$$\eta = \frac{\Delta T}{T_h} \cdot \frac{\frac{m}{m+1}}{1 + \frac{(m+1)}{ZT_h} - \frac{\Delta T}{2T_h \cdot (m+1)}}$$

# Efficiency for different electrical loads

$$\eta = \frac{Welec}{\Phi_H} = \frac{\Delta T}{T_h} \cdot \frac{\frac{m}{m+1}}{1 + \frac{(m+1)}{zT_h} - \frac{\Delta T}{2T_h(m+1)}}$$

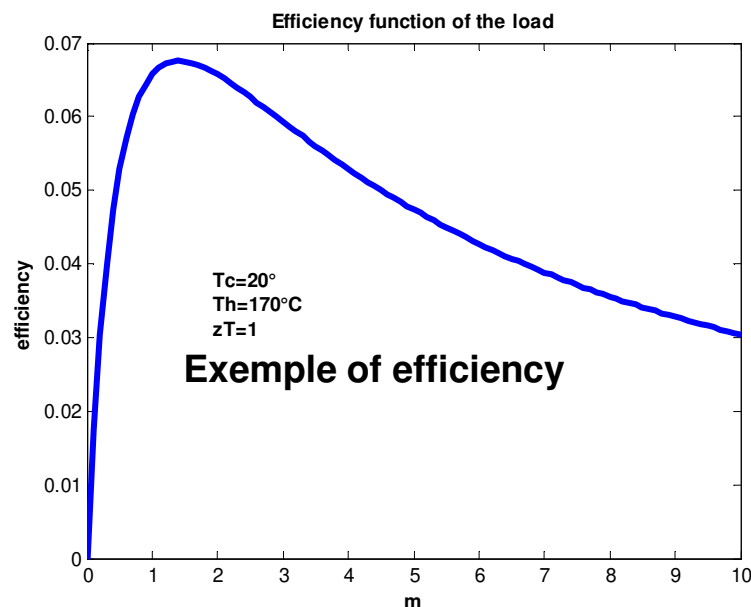

There is a maximum for  $m \approx 1.4$

The load must be adapted

m can be chosen to maximize the efficiency

$$\frac{\partial \eta}{\partial m} = \frac{\Delta T}{T_h} \cdot \frac{2(2m^2 - 2zT_h - 2 + \Delta Tz)Th.z}{(-2zThm - 2zTh - 2m^2 - 4m - 2 + \Delta Tz)^2}$$

$$\frac{\partial \eta}{\partial m} = 0 \rightarrow 2m^2 - 2zT_h - 2 + \Delta Tz = 0$$

$$m_{opt} = \frac{\sqrt{2zTh + 2zTc + 4}}{2} = \sqrt{z \frac{(Th + Tc)}{2} + 1}$$

$$m_{opt} = \sqrt{1 + zT}$$

Where T is the average temperature  $T = \frac{(Th + Tc)}{2}$

$$\eta_{opt} = \frac{\Delta T}{T_h} \cdot \frac{\sqrt{1 + zT} - 1}{\sqrt{1 + zT} + \frac{T_c}{T_h}}$$

Maximum of efficiency is a function of zT  
(Dimensionless figure of merit)

$$z = \frac{\alpha^2}{\rho\lambda} = \frac{\sigma \cdot \alpha^2}{\lambda}$$

$$T = \frac{(Th + Tc)}{2}$$

# Maximum Efficiency

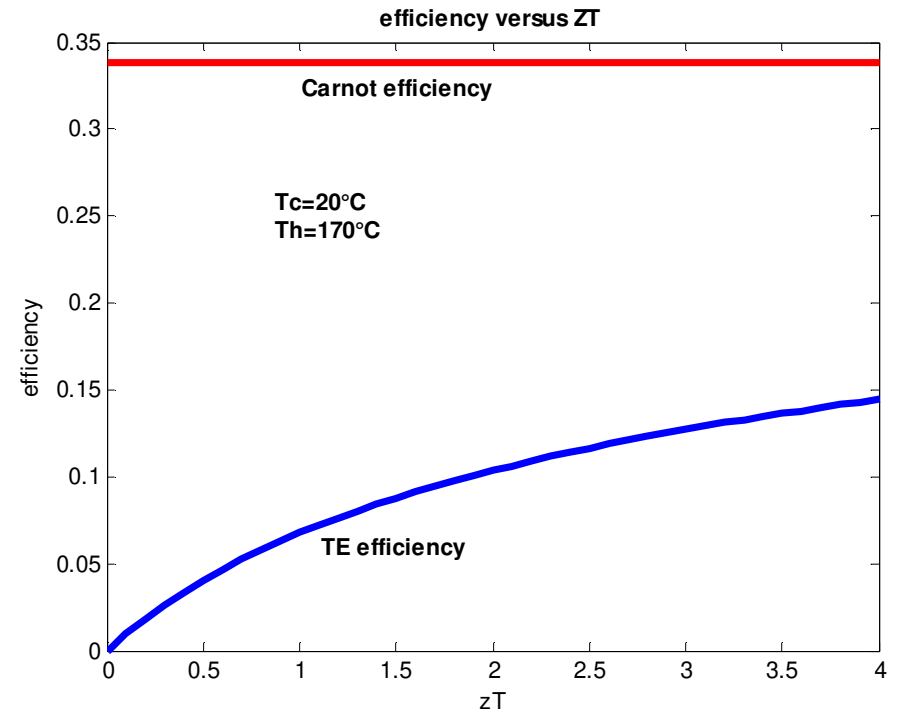
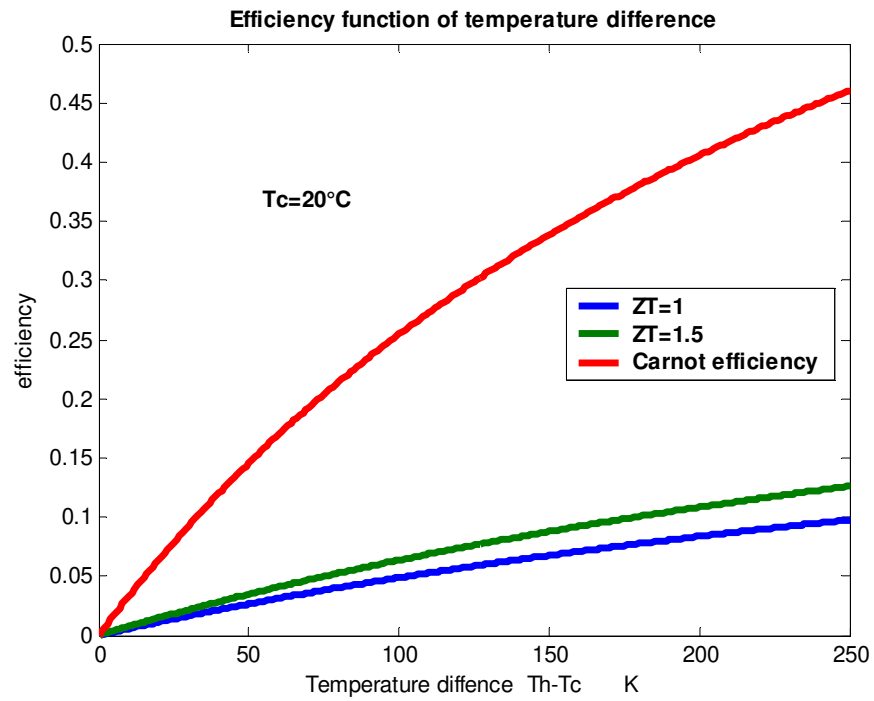

# Complete generator model

**From heat sources to electrical storage including electrical converters**

- 1) Adding the heat exchangers to hot and cold sources**
- 2) Electrical converters**

The thermoelectric elements are inserted between heat exchanger

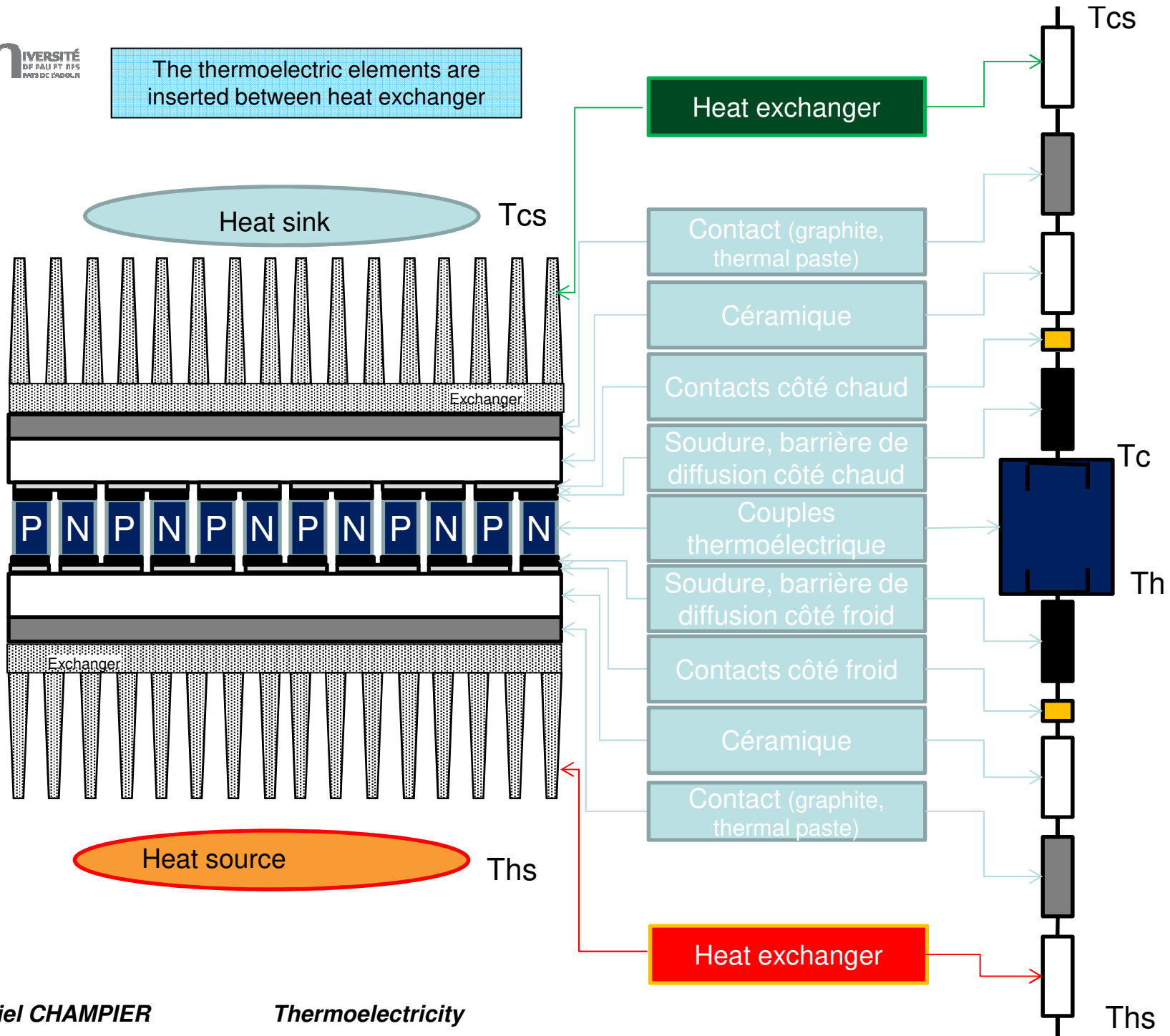

The TE module is inserted between two heat exchangers

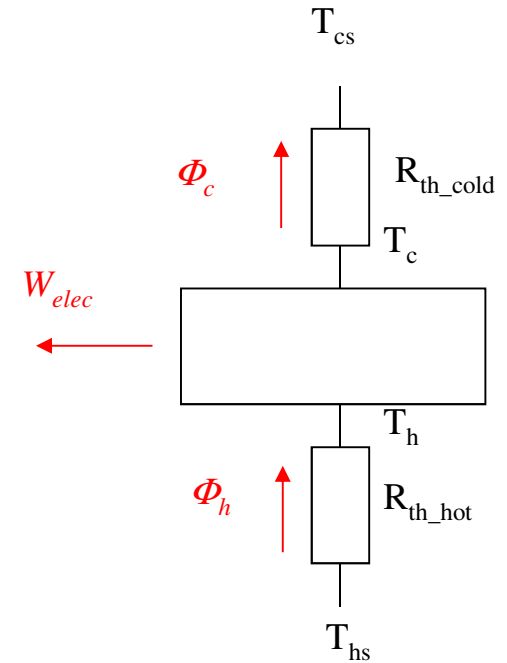
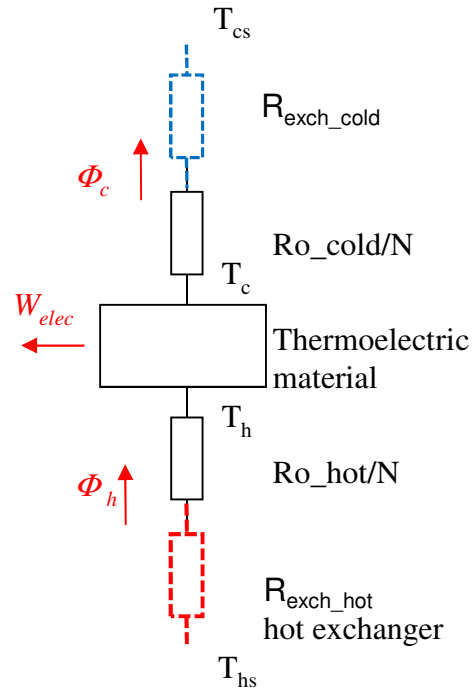
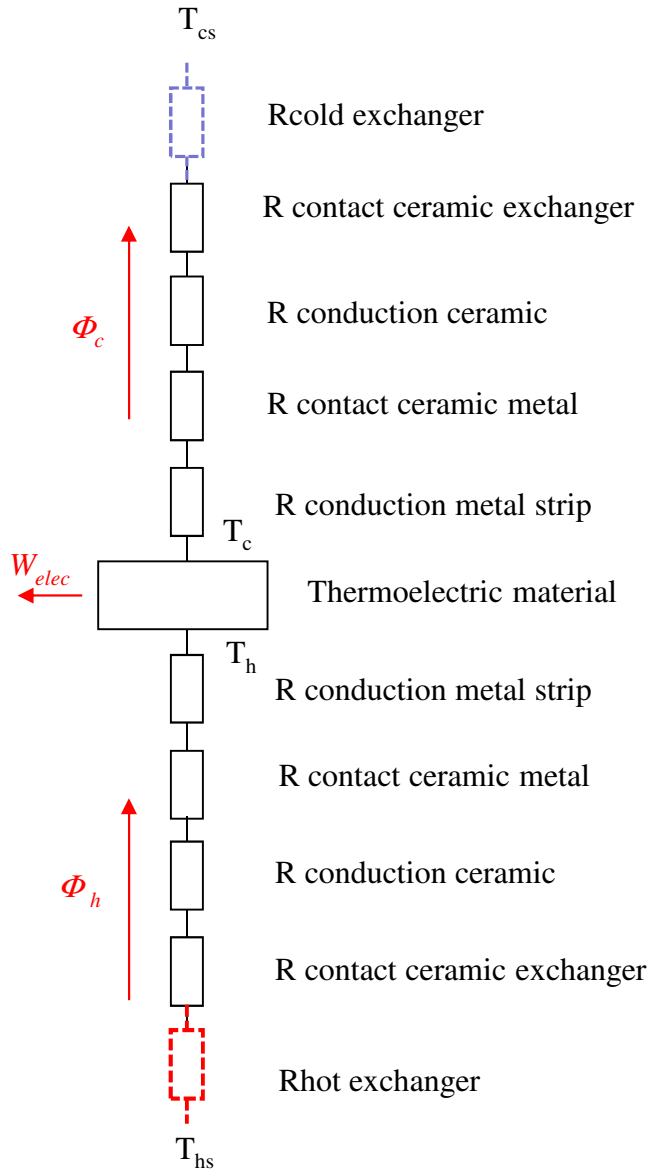

## Thermoelectric Equations

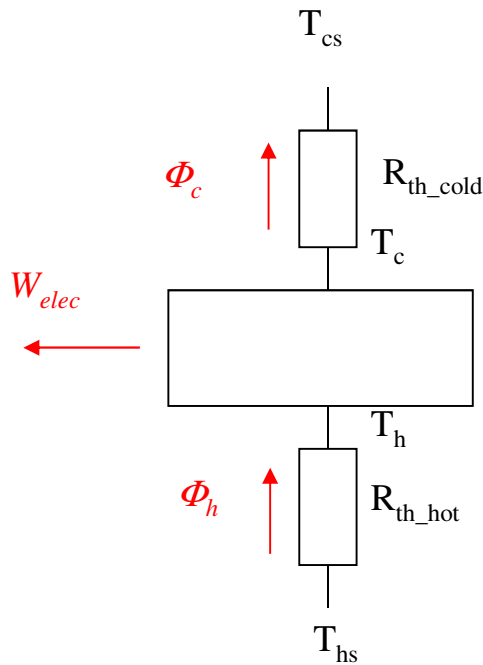

$$\Phi_h = N \cdot \left[ \alpha \cdot I \cdot T_h - \frac{1}{2} R_{e\_pn} \cdot I^2 + \frac{(T_h - T_c)}{R_{th\_pn}} \right] \quad (1)$$

$$\Phi_c = N \cdot \left[ \alpha \cdot I \cdot T_c + \frac{1}{2} R_{e\_pn} \cdot I^2 + \frac{(T_h - T_c)}{R_{th\_pn}} \right] \quad (2)$$

$$W_{elec} = N \cdot \alpha \cdot I \times (T_h - T_c) - N \cdot R_{e\_pn} \cdot I^2 \quad (3)$$

## Thermal Equations

$$\Phi_h = \frac{(T_{hs} - T_h)}{R_{th\_hot}} \quad (4)$$

$$\Phi_c = \frac{(T_c - T_{cs})}{R_{th\_cold}} \quad (5)$$

$R_{e\_pn}$  Electrical resistance of a couple **including contact resistance**

$R_{th\_pn}$  Thermal resistance of a couple **excluding contact resistance**

$$\Phi_h = N \cdot \left[ \alpha \cdot I \cdot T_h - \frac{1}{2} R_{e\_pn} \cdot I^2 + \frac{(T_h - T_c)}{R_{th\_pn}} \right] = \frac{(T_{hs} - T_h)}{R_{th\_hot}} \quad (1) \text{ \& \ } (4)$$

$$\Phi_c = N \cdot \left[ \alpha \cdot I \cdot T_c + \frac{1}{2} R_{e\_pn} \cdot I^2 + \frac{(T_h - T_c)}{R_{th\_pn}} \right] = \frac{(T_c - T_{cs})}{R_{th\_cold}} \quad (2) \text{ \& \ } (5)$$

These two equations can be rewritten in matrix form

$$\begin{pmatrix} N \cdot \alpha \cdot I + \frac{1}{R_{th\_hot}} + \frac{N}{R_{th\_pn}} & -\frac{N}{R_{th\_pn}} \\ \frac{N}{R_{th\_pn}} & N \cdot \alpha \cdot I - \frac{1}{R_{th\_cold}} - \frac{N}{R_{th\_pn}} \end{pmatrix} \begin{pmatrix} T_h \\ T_c \end{pmatrix} = \begin{pmatrix} \frac{T_{hs}}{R_{th\_hot}} + \frac{1}{2} N \cdot R_{e\_pn} \cdot I^2 \\ -\frac{T_{cs}}{R_{th\_cold}} - \frac{1}{2} N \cdot R_{e\_pn} \cdot I^2 \end{pmatrix}$$

Cramer's rule give an explicit formula for the solution of this system of linear equations

Then you can calculate the electrical output power

$$W_{elec} = N \cdot \alpha \cdot I \times (T_h - T_c) - N \cdot R_{e\_pn} \cdot I^2$$



# Annex Cramer's rule

Cramer's rule

$$\begin{pmatrix} a_1 & b_1 \\ a_2 & b_2 \end{pmatrix} \cdot \begin{pmatrix} x \\ y \end{pmatrix} = \begin{pmatrix} c_1 \\ c_2 \end{pmatrix}$$

$$x = \frac{\begin{vmatrix} c_1 & b_1 \\ c_2 & b_2 \end{vmatrix}}{\begin{vmatrix} a_1 & b_1 \\ a_2 & b_2 \end{vmatrix}} = \frac{c_1 b_2 - c_2 b_1}{a_1 b_2 - a_2 b_1}$$

$$y = \frac{\begin{vmatrix} a_1 & c_1 \\ a_2 & c_2 \end{vmatrix}}{\begin{vmatrix} a_1 & b_1 \\ a_2 & b_2 \end{vmatrix}} = \frac{a_1 c_2 - a_2 c_1}{a_1 b_2 - a_2 b_1}$$

# Which values for the material properties ?

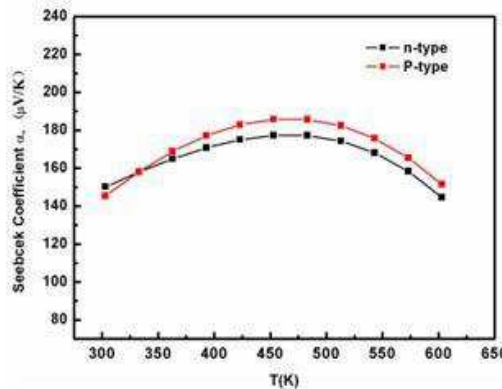
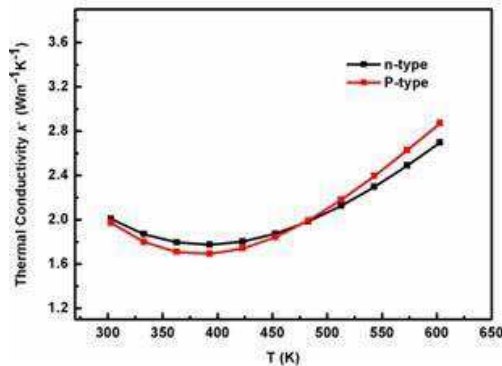
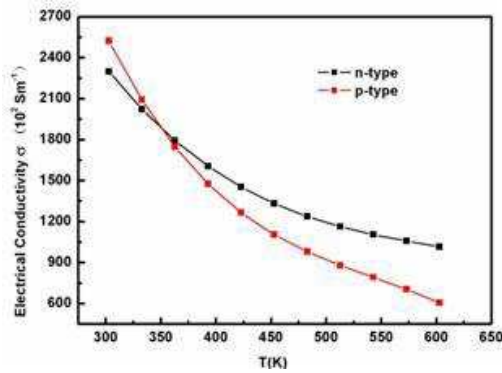

Assumptions for the calculations :

The material properties are temperature independent

The equations give good results if one chooses the value at the average

temperature.

$$T_{av} = T_m = \frac{T_h + T_c}{2}$$

$$\lambda = \lambda(T_{av})$$

$$\rho = \rho(T_{av})$$

$$\alpha = \alpha(T_{av})$$

But 
$$\frac{T_h + T_c}{2} \neq \frac{T_{hs} + T_{cs}}{2}$$

you have to do some iterations to find  $T_m$

$$T_m(0) = \frac{T_{hs} + T_{cs}}{2} \quad \Rightarrow \quad T_h(0) \text{ et } T_c(0)$$

$$T_m(1) = \frac{T_h(0) + T_c(0)}{2} \quad \Rightarrow \quad T_h(1) \text{ et } T_c(1)$$

you can make these iterations with  $l=0$  because the average temperature won't change a lot with  $l$

$\lambda$ ,  $\rho$ ,  $\alpha$  as function of the temperature for Thermoanamics Ingots

# Design (and optimization)

## Common error

Consider only the power given in manufacturer's datasheet, for example "19.2W".

19.2 W is for

- hot side at 300°C
- cold side at 30°C
- adapted electrical load

great disappointment

Hot Side Temperature (°C)	300
Cold Side Temperature (°C)	30
Open Circuit Voltage (V)	7.8
Matched Load Resistance (ohms)	0.8
Matched load output voltage (V)	3.9
Matched load output current (A)	4.9
Matched load output power (W)	19.2
Heat flow across the module(W)	≈400
Heat flow density(Wcm <sup>-2</sup> )	≈12.8

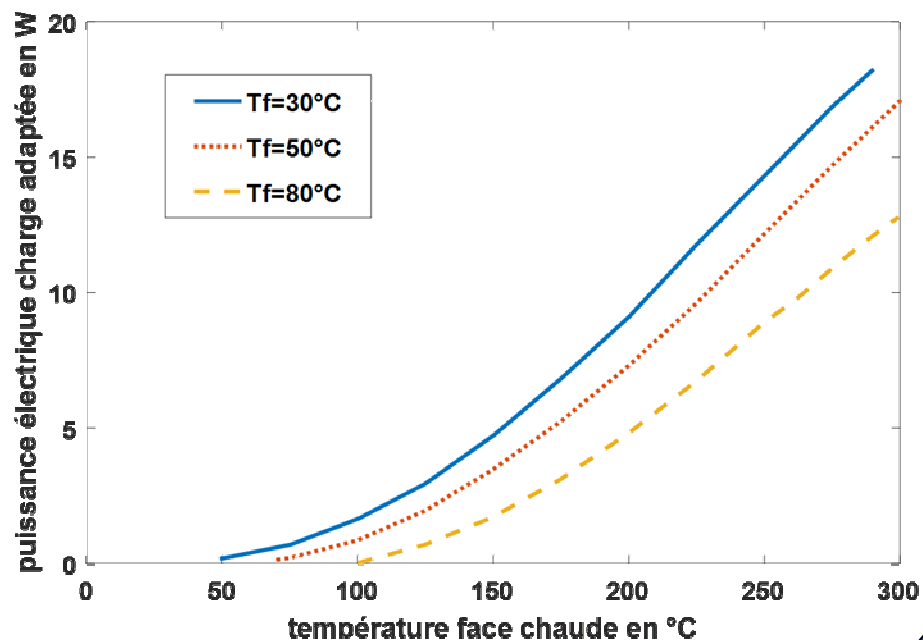

# Design (and optimization)

## Rough design

- temperatures of the two sources,
- thermal resistance of the exchangers
- thermal resistance of the modules
- No electric current

Calculate the temperature on either side of the modules.

➡ manufacturer curves gives an idea of the power

power will be overestimated : Joule effect, Peltier effect in the module significantly reduce the temperature difference at the faces of the module

This approach has often been used in the past by automotive integrators and has led to disillusionment with the powers obtained.

# Design and optimization

## Simplified design

- temperatures of the two sources,  $T_{cs}$  and  $T_{hs}$
- thermal resistance of the exchangers
- knowledge of the properties of materials

### I) Calculation of the average temperature for material properties **No electric current**

- 1) Choose  $T_m$  =average ( $T_{cs}, T_{hs}$ ) and calculate  $T_c(k=0)$  and  $T_h(k=0)$  without current
- 2) Choose  $T_m$  =average ( $T_c(k=0), T_h(k=0)$ ) and calculate  $T_c(k=1)$  and  $T_h(k=1)$  without current
- 3) Iterate on  $k$  (normally just a few time)

### II) Calculation of the electric output power

- 1) Calculate the open circuit voltage  $E_0$  (rough estimation of the maximum output power :  $\frac{E_0^2}{4R}$ )  $I=0$
- 2) Estimate the short circuit current  $I_{max}=E_0/R$
- 3) Calculate the output power for different values of  $I$ , between  $I=0$  and  $I_{max}$  using Kramer's formulas (*possibility to iterate on parameters calculation*)
- 4) Calculate the maximum electrical power.

# Example

$T_{hs}=500^{\circ}\text{C}$

$T_{cs}=30^{\circ}\text{C}$

$R_{exch\_hot}=1$

$R_{exch\_cold}=0.05$

$R_{o\_cold}/N = R_{o\_hot}/N = 0.14\text{K/W}$

$R_{th\_hot}=1.14;$

$R_{th\_cold}=0.14;$

$R_{contact}=0.30$  electric contact resistance for the whole module

Material properties of the previous slide

$N=128$  couples

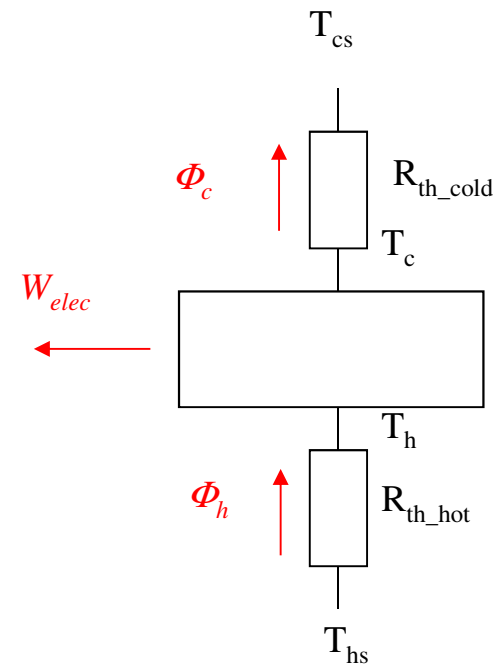
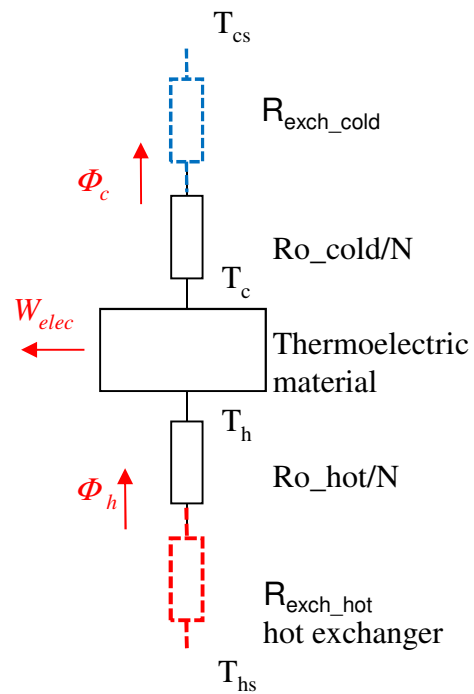

# Example : Calculation of the average temperature for material properties

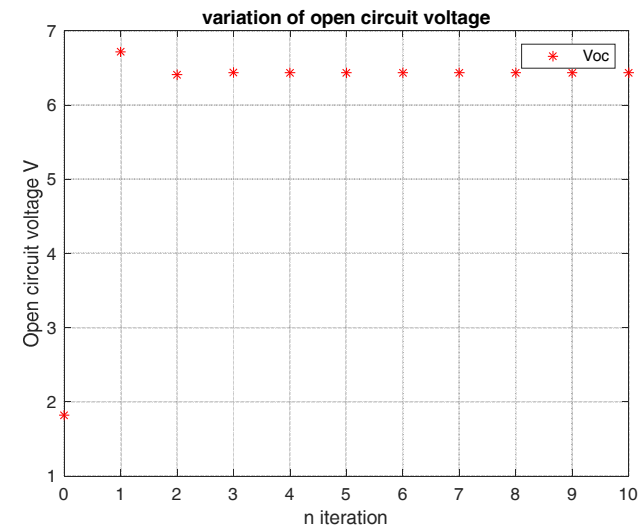
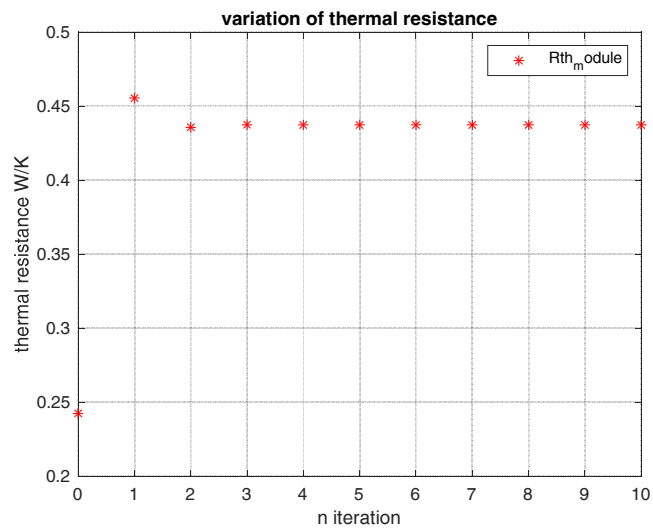
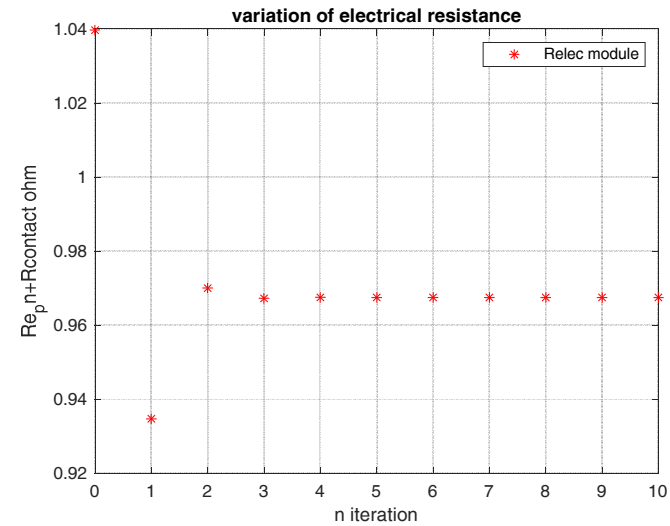
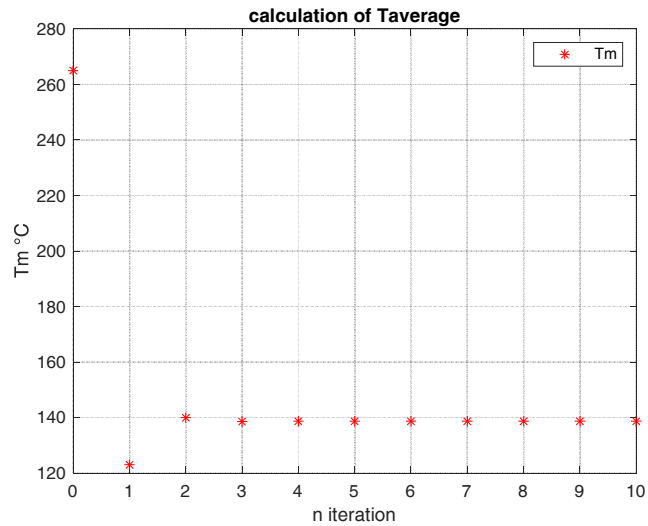

# Example : Calculation of the temperatures

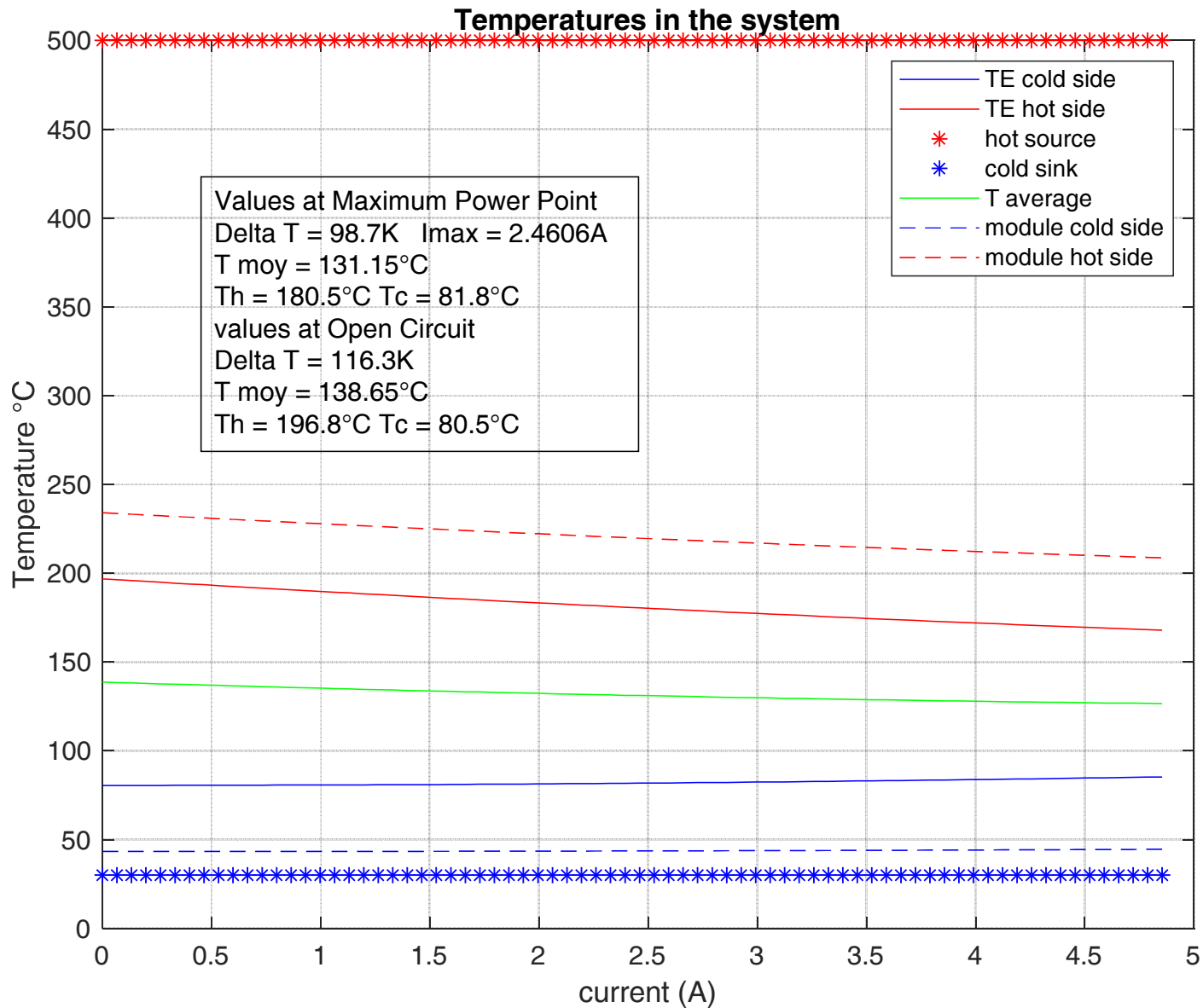



# Example : Calculation of electrical power

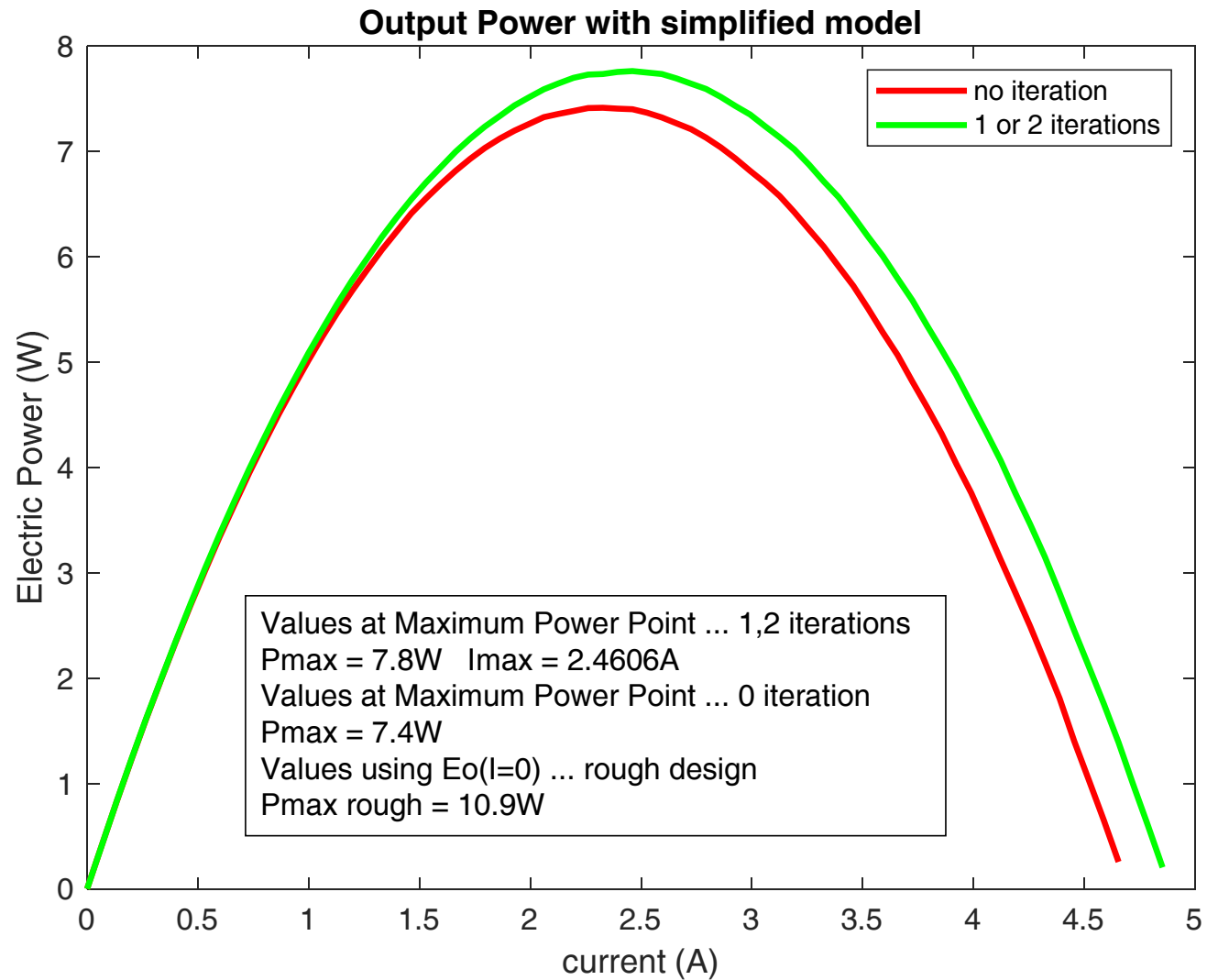

10.9W

7.4W  $\rightarrow$  7.8W is iteration necessary?

# Design (and optimization)

## Remarks on simplified design

- temperatures of the two sources,  $T_{cs}$  and  $T_{hs}$   
If not you must cut in different slides

Are they spatially constant ?

Are they constant over time ?

If not, you can consider dynamic equations for the thermal part and keep quasi-static equation for the TE parts

- thermal resistance of the exchangers  
exchange coefficients ... difficult part of the job

high uncertainty on convective heat

- knowledge of the properties of materials  
Some manufacturers give these properties (HiZ, Thermonamic)

Most manufacturers give only: electrical resistance and maximum output power as a function of temperatures but up to now they don't give the thermal conductance of their modules.

You need to estimate it by your own measurements (Manufacturers started to develop bench measuring Seebeck, Electrical Resistance and Thermal Resistance)

# Optimization : Maximizing power output from a generator

$$W_{elec}^{Max} = \Delta T^2 \cdot \frac{NS}{8L} \cdot \sigma_{pn} \alpha^2 = \Delta T^2 \cdot N \cdot \frac{S}{8L} \sigma_{pn} \alpha^2$$

How many modules to put on? More elegantly how much couple to put in?

# Optimization : Maximizing power output from a generator

Thermal resistance of N couples  $R_{th\_N\_couples} = \frac{L}{2 \cdot \lambda_{np} \cdot S} \cdot \frac{1}{N} = R_{th\_pn} \cdot \frac{1}{N}$

Thermal contact + resistance ceramic strip for each couple  $R_o = R_o\_cold + R_o\_hot$

If you neglect the Thermoelectric effect (Peltier and Joule) :

Thermal resistance of a module  $R_{th\_module} = R_{th\_N\_couples} + \frac{R_o}{N} = (R_{th\_pn} + R_o) \cdot \frac{1}{N}$

Calculating the temperature difference between the two side of the thermoelectric materials

$$\Delta T = \frac{R_{th\_N\_couples}}{R_{th\_module} + R_{exch\_cold} + R_{exch\_hot}} (T_{hs} - T_{cs}) = \frac{R_{th\_N\_couples}}{R_{th\_module} + R_{exc}} (T_{hs} - T_{cs}) = \frac{R_{th\_pn} \cdot \frac{1}{N}}{(R_{th\_pn} + R_o) \cdot \frac{1}{N} + R_{exc}} (T_{hs} - T_{cs}) = \frac{\frac{R_{th\_pn}}{R_{exc}}}{\frac{(R_{th\_pn} + R_o)}{R_{exc}} + N} (T_{hs} - T_{cs})$$

$$W_{elec}^{Max} = \Delta T^2 \cdot N \cdot \frac{S}{8L} \sigma_{pn} \alpha^2 = \left[ \frac{\frac{R_{th\_pn}}{R_{exc}}}{\frac{(R_{th\_pn} + R_o)}{R_{exc}} + N} (T_{hs} - T_{cs}) \right]^2 N \cdot \frac{S}{8L} \sigma_{pn} \alpha^2 = \frac{N}{\left( \frac{(R_{th\_pn} + R_o)}{R_{exc}} + N \right)^2} \left[ \frac{R_{th\_pn}}{R_{exc}} (T_{hs} - T_{cs}) \right]^2 \cdot \frac{S}{8L} \sigma_{pn} \alpha^2$$

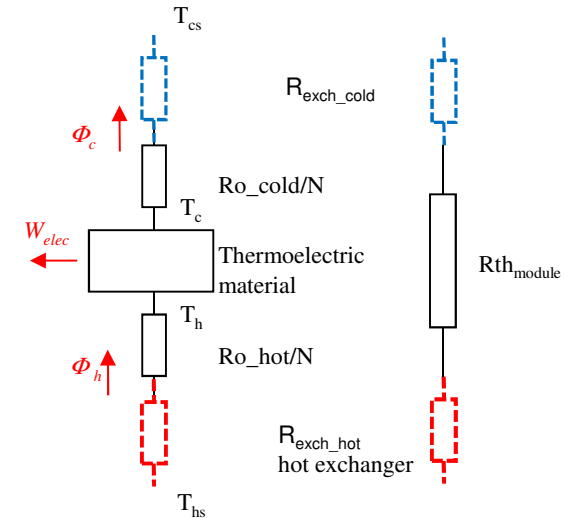

# Optimization : Maximizing power output from a generator

$$W_{elec}^{Max} = \frac{N}{\left(\frac{R_{th\_pn} + R_o}{R_{exc}} + N\right)^2} \left[ \frac{R_{th\_pn}}{R_{exc}} (T_{hs} - T_{cs}) \right]^2 \cdot \frac{S}{8L} \sigma_{pn} \alpha^2$$

Maximizing the electrical Power :

$$\frac{\partial W_{elec}^{Max}}{\partial N} = 0 \quad \frac{\partial W_{elec}^{Max}}{\partial N} = \frac{\frac{R_{th\_pn} + R_o}{R_{exc}} - N}{\left(\frac{R_{th\_pn} + R_o}{R_{exc}} + N\right)^3} \left(\frac{R_{th\_pn}}{R_{exc}}\right)^2 (T_{hs} - T_{cs})^2 \cdot \frac{S}{8L} \sigma_{pn} \alpha^2 \Rightarrow N = \frac{R_{th\_pn} + R_o}{R_{exc}}$$

$$R_{th\_module} = \frac{R_{th\_pn} + R_o}{N} = R_{exc}$$

**Thermal impedances matching**

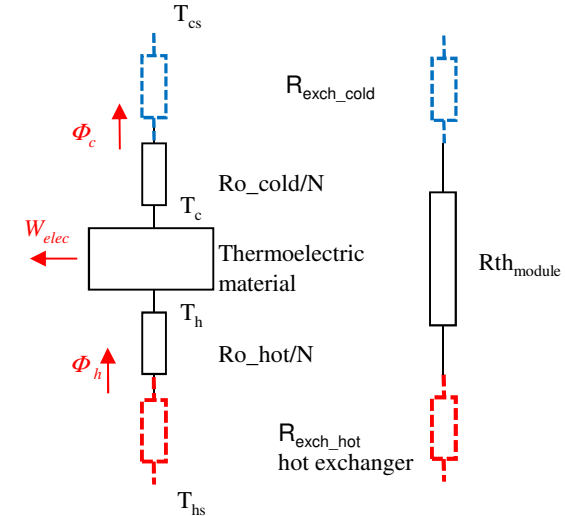

**The temperature difference of the 2 sides of the module is half of the temperature difference between sources.**

**Rule of thumb**

**Strong assumptions :** thermoelectric parameters do not depend on temperature neglecting thermoelectric effect.

$$W_{elec}^{Max} = \left(\frac{R_{th\_N\_couples}}{R_{th\_module}}\right)^2 \left(\frac{T_{hs} - T_{cs}}{2}\right)^2 \cdot \frac{NS}{8L} \sigma_{pn} \alpha^2$$

**Be careful, this relation overestimated the power, because again the temperature difference is calculated by neglecting Peltier and Joule effect.**

# Design and optimization

## Complexe design

In the case of non-ideal heat sources (e. g. hot gas cooling along an exchanger), the approach will be to use the TE equations and Thermal equations coupled with fluid dynamics equations.

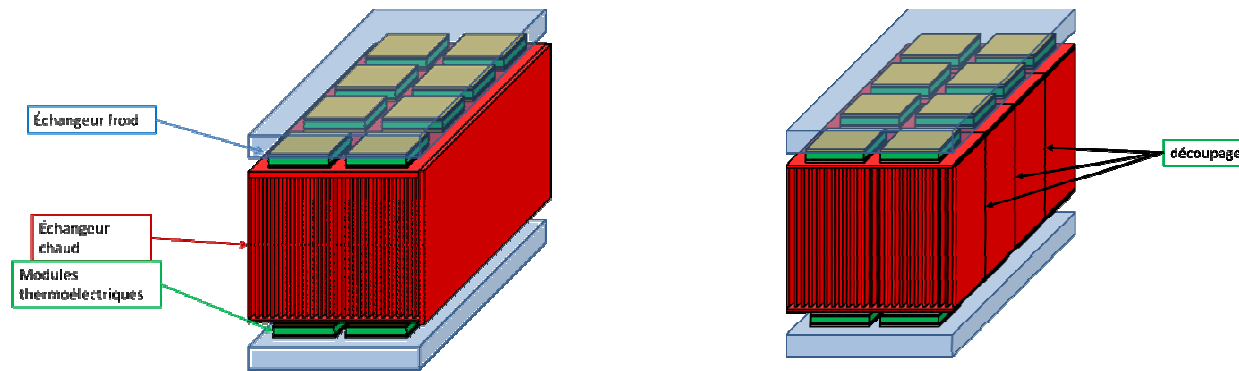

## optimization

Many parameters can be optimized, number of modules, heat exchanger, materials, geometry of modules

Heavy calculations



genetic algorithms

# Finite Element Models

a FE model can provide several unique advantages.

It can solve the governing set of partial differential equations that cannot be solved analytically.

It permits the investigation of complex geometries.

The non-linearities of the material property temperature-dependency can be handled, whereas an analytical solution does not exist.

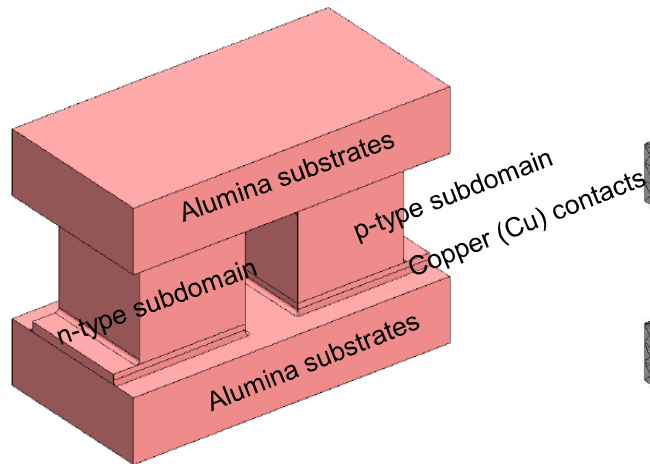

FEA model of a thermoelement junction in COMSOL

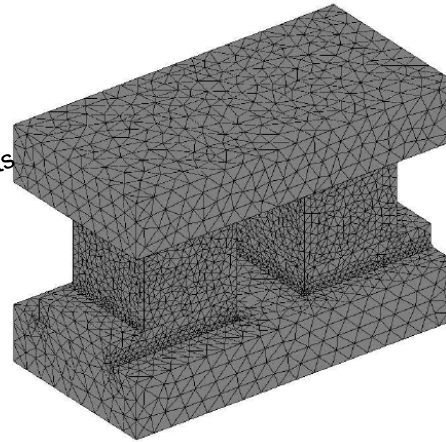

Final COMSOL mesh

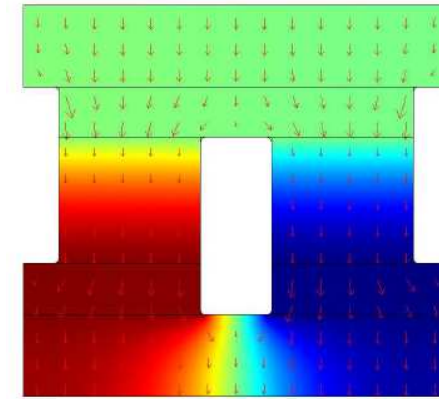

The voltage gradient is seen in color  
the arrows indicate heat flow

The analysis of hundred of thermoelements pairs is **highly computationally** intensive

The model are limited to a few pairs

Finite Element Software Package : Comsol, Ansys Fluent, etc

Emil Jose Sandoz-Rosado, Thesis, Improved Modeling of a Thermoelectric Module

# Thermoelectric equations : other models

Standard simplified model

$$\Phi_h = \alpha \times I \times T_h - \frac{r \times I^2}{2} + k \times (T_h - T_c) \quad \text{All parameter evaluated at } T_m = \frac{T_h + T_c}{2}$$

$$\Phi_c = \alpha \times I \times T_c + \frac{r \times I^2}{2} + k \times (T_h - T_c)$$

$$W_{elec} = \alpha \times I \times (T_h - T_c) - r \times I^2$$

Thomson simplified model

$$\Phi_h = \alpha \times I \times T_h - \frac{r \times I^2}{2} + k \times (T_h - T_c) - \frac{1}{2} \tau \times I \times (T_h - T_c)$$

Introducing Thomson' coefficient  $\tau = T \times \left. \frac{\partial \alpha(T)}{\partial T} \right|_{T_m}$

$$\Phi_c = \alpha \times I \times T_c + \frac{r \times I^2}{2} + k \times (T_h - T_c) + \frac{1}{2} \tau \times I \times (T_h - T_c)$$

$$W_{elec} = (\alpha - \tau) \times I \times (T_h - T_c) - r \times I^2$$

Thomson Seebeck simplified model

$$\Phi_h = \alpha(T_h) \times I \times T_h - \frac{r \times I^2}{2} + k \times (T_h - T_c) - \frac{1}{2} \tau \times I \times (T_h - T_c)$$

Seebeck' surface coefficients

$$\Phi_c = \alpha(T_c) \times I \times T_c + \frac{r \times I^2}{2} + k \times (T_h - T_c) + \frac{1}{2} \tau \times I \times (T_h - T_c)$$

$$W_{elec} = [\alpha(T_h) \times T_h - \alpha(T_c) \times T_c] \times I - r \times I^2 - \tau \times I \times (T_h - T_c)$$

1996 Chen The influence of Thomson effect on the maximum power output and maximum efficiency of a thermoelectric generator



# Power convertor

TE modules

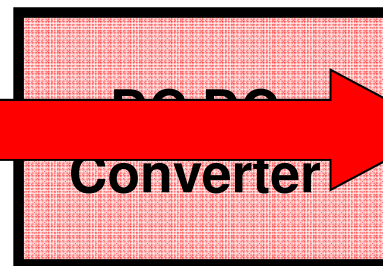

$$V_{oc} = N \cdot \alpha (T_h - T_c)$$

$$R = R(T_h, T_c)$$

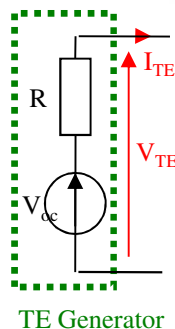

The temperature  $T_h$  and  $T_c$  varies a lot.



output voltage of the TE modules fluctuates a lot.

The loads need regulated voltage



An electric power convertor is necessary



# Power convertors for TE generators

Power convertors convert electric power from one form to another

TE modules are direct current (DC) source

Loads are mostly DC (batteries ) but possibly alternating current AC (grid connection)

DC – DC

Step-up (Boost) : The storage voltage is higher than the Te modules voltage

**Buck-Boost** : The storage voltage is higher or lower than the Te modules voltage

DC – AC

**Inverter** commonly used to supply AC power from DC sources such as solar panels or batteries

# Boost converter

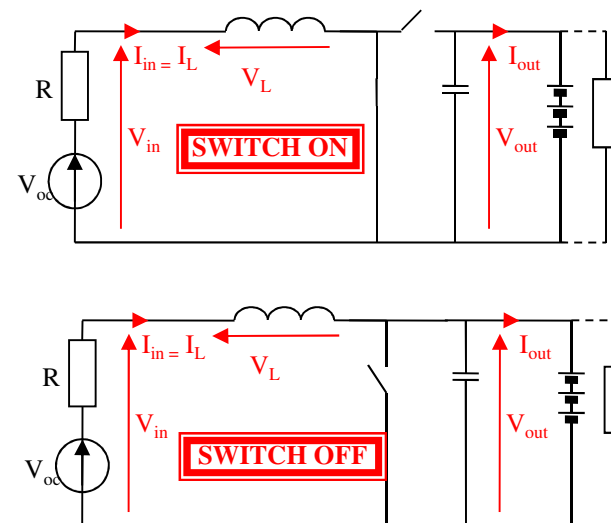
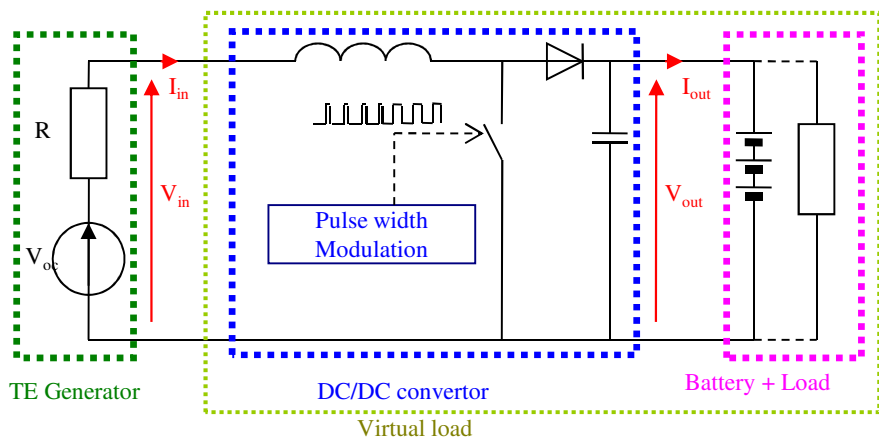

Dc duty cycle :  
fraction of the commutation period  $T$  during which the switch is On.

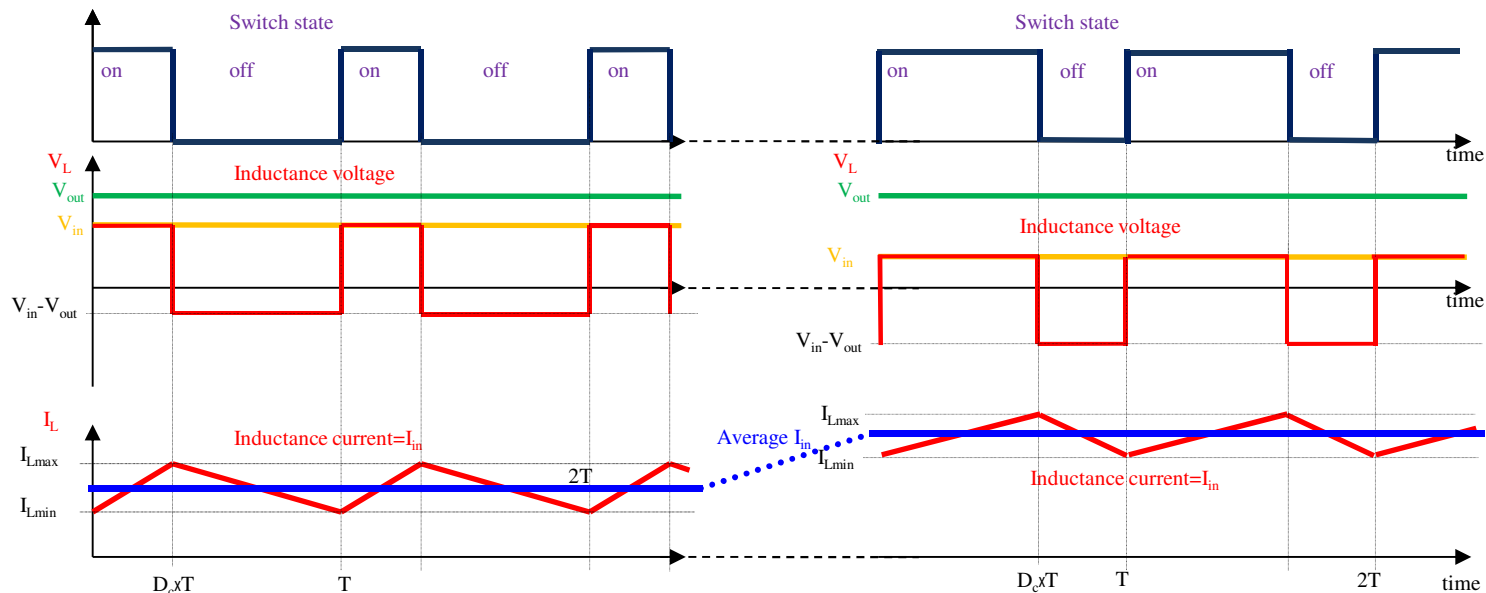

# Boost converter

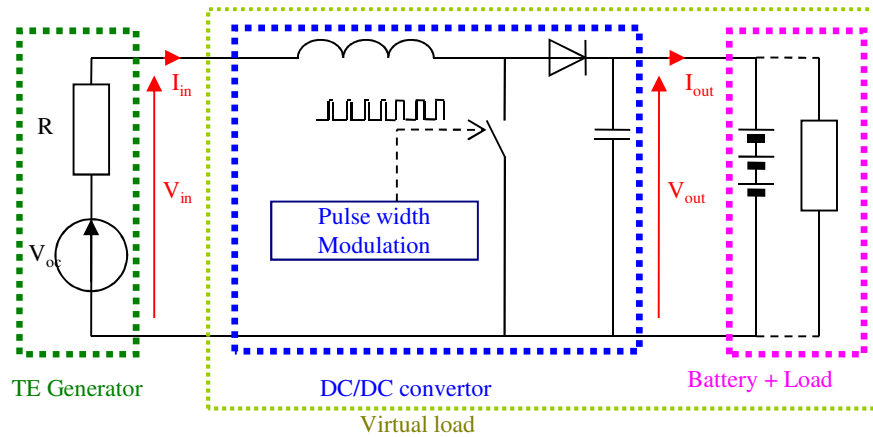

Ideal convertor :

$$\begin{cases} V_{in} = V_{out} \times (1 - Dc) \\ I_{in} = \frac{I_{out}}{(1 - Dc)} \end{cases}$$

$$P_{in} = V_{in} \times I_{in} = V_{out} \times I_{out} = P_{out}$$

$V_{out}$  is fixed by the battery voltage



The choice of the duty cycle therefore imposes the voltage  $V_{in}$  and thus the currents

$$I_{in} = \frac{V_{oc} - V_{in}}{R}$$

For an adapted load (maximum power)  $V_{in}$  must be equal to  $V_{oc}/2$

$V_{oc}$  of the TE modules fluctuates a lot.



The duty cycle needs to follow these variations

# Maximum Power Point (MPP)

Exemple of TE module HiZ 14

## Electrical Power

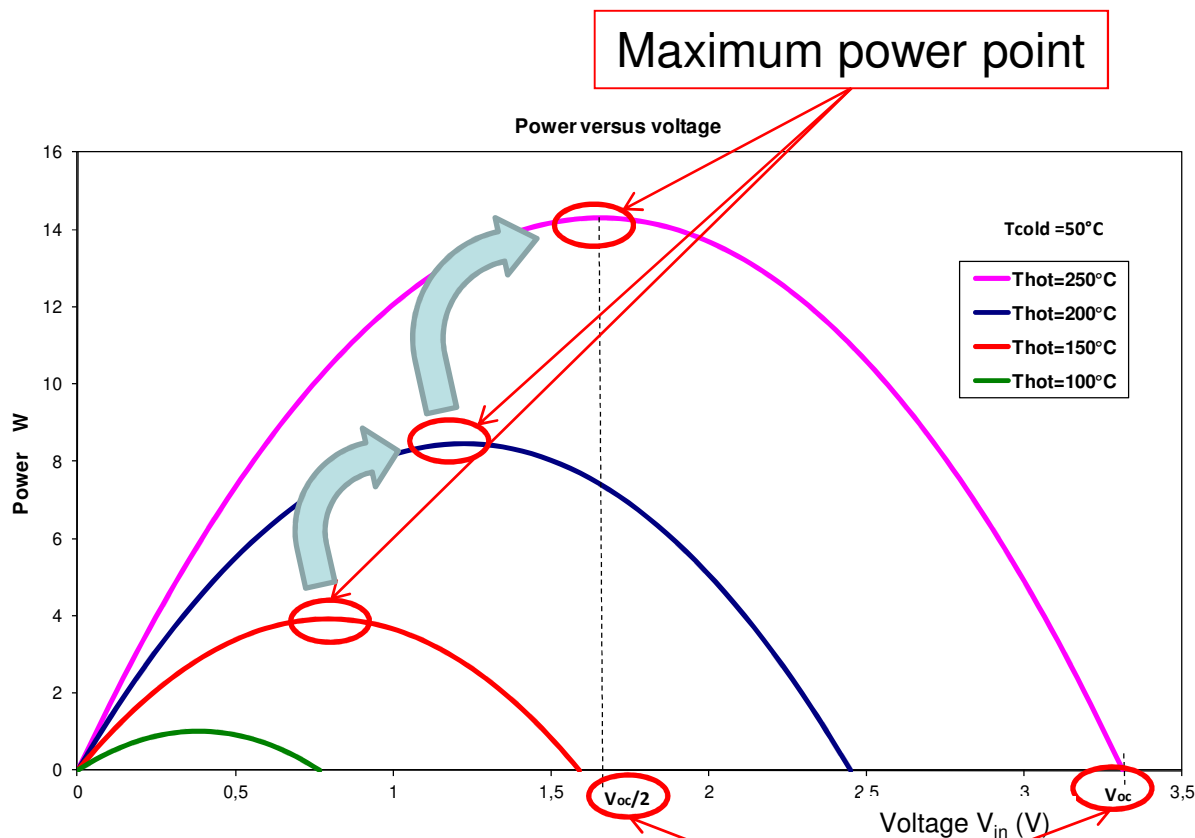
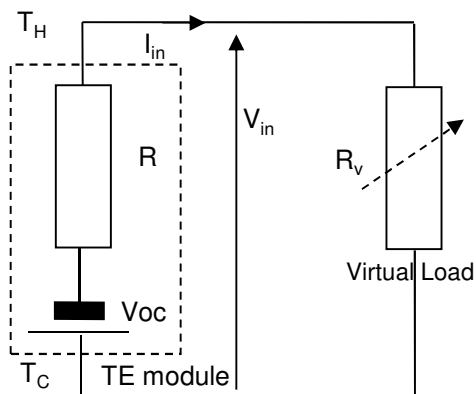

The MMP changes with the temperatures  
Intelligence is necessary

# Boost convertor with MPPT

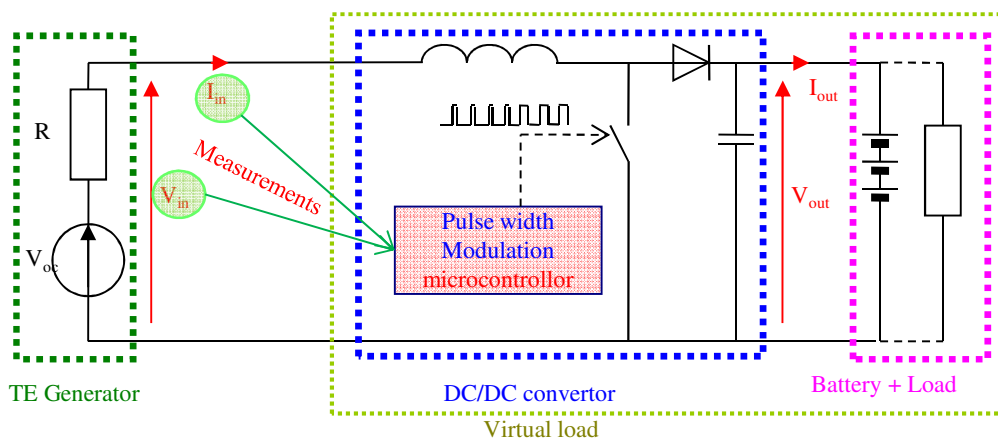

The solution is to control the DC/DC converter with a Maximum Power Point Tracker

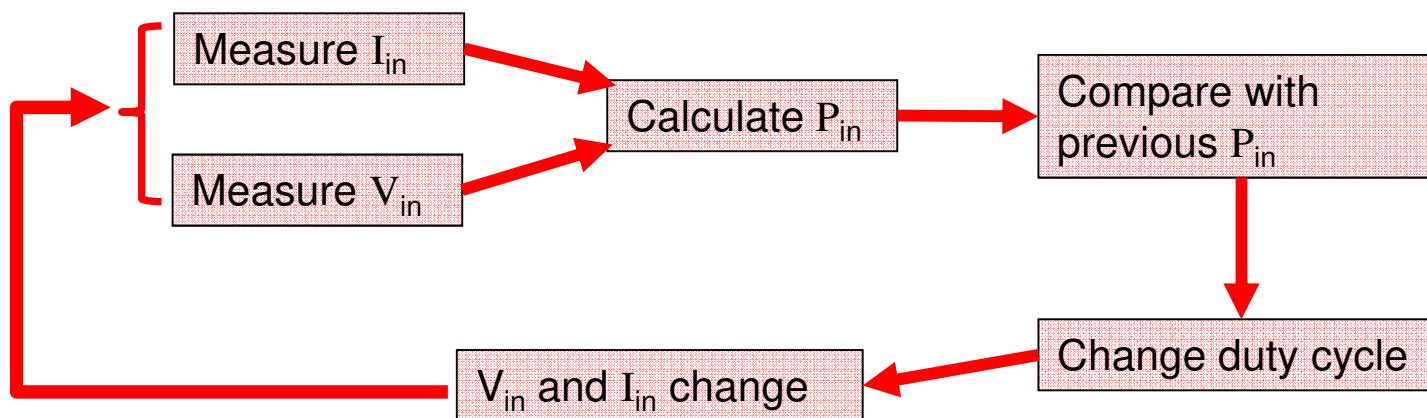

Question : how to change the duty cycle?  
Algorithm MPPT

# Remarks on electrical part

DC-DC efficiency

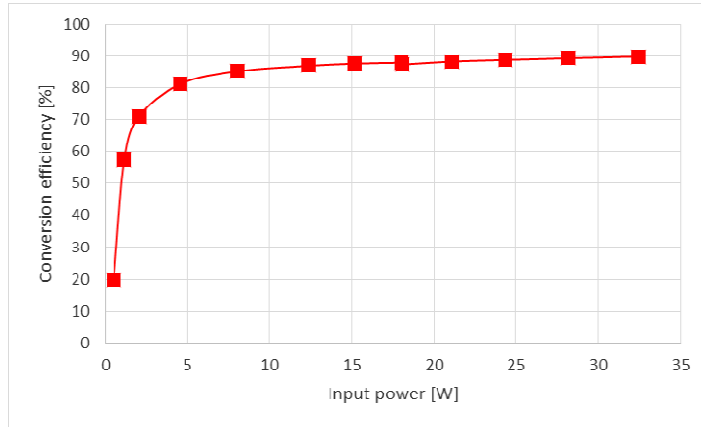

MPPT efficiency

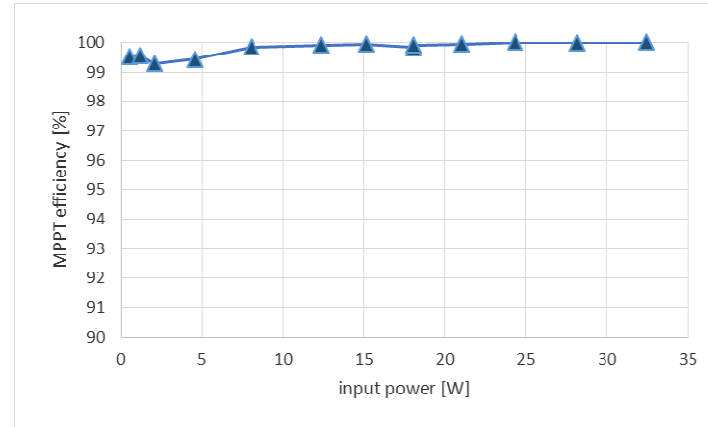

Optimization of modules (length and area of leg) does not take in account all the components (wires, power convertor, contacts) between modules and end use of the electricity.



Joule effect irreversible and every where

$$RI^2$$

# Applications

Production in extreme environments  
Waste Heat Recovery (WHR)  
Domestic production  
Microgeneration: sensors, connected objects (IOT)  
Thermoelectric solar power

Refrigeration and regulation

Metrology



# Electricity production in extreme environment

## critical applications:

- a power source extremely reliable over very long periods.
- extreme climatic conditions:
  - very hot
  - very cold
  - very wet
  - very dry.
- Maintenance as low as possible
  - helicopter access
  - several hour trip
- Maintenance does not exist in the case of space expeditions.
- operation in a vacuum
- vibrations.
- insensitive to radiation

The cost of watt is not essential

# Space applications

1961 : First use of a thermoelectric generator (Pb -Te) : navigation satellite Transit  
 SNAP-3 (Space Nuclear Auxiliary Power)  
 Electrical power ~2,7 watts  
 worked for more than fifteen years

## RTG Radioisotope Thermoelectric Generator

Radioisotope Thermoelectric Generators, or RTGs convert the heat generated by the decay of plutonium-238 (plutonium dioxide  $^{238}\text{PuO}_2$ ) fuel into electricity

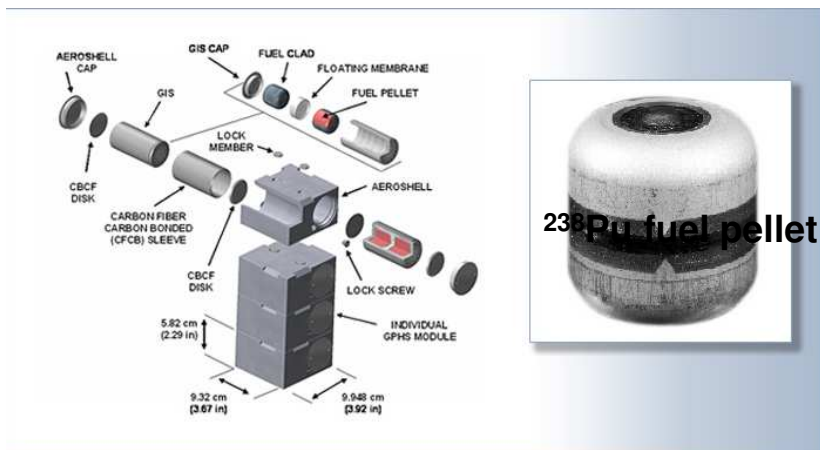

**GPHS : General Purpose Heat Source module**

<http://solarsystem.nasa.gov/rps/rtg.cfm>

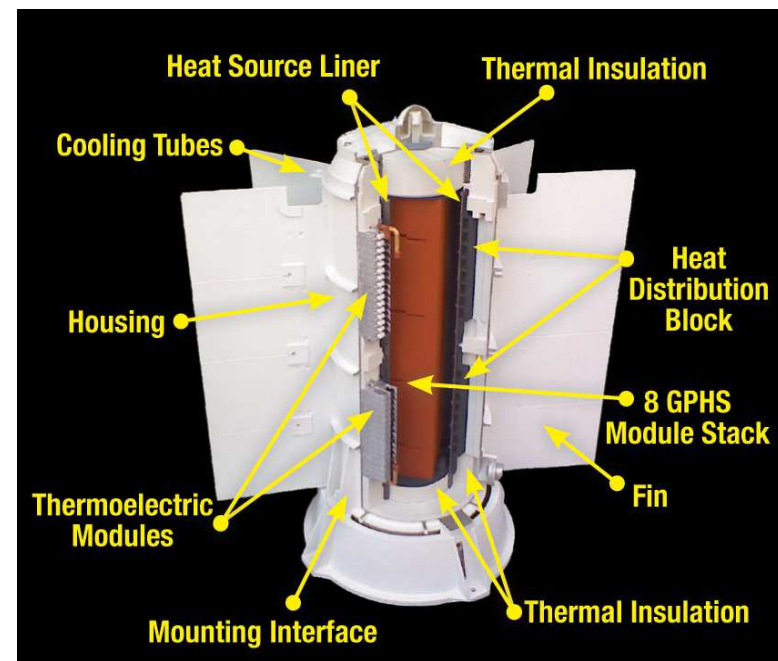

# Space applications

- Missions are long
  - Need power systems with >14 years life
- Mass is at an absolute premium
  - Power systems with high specific power and scalability are needed

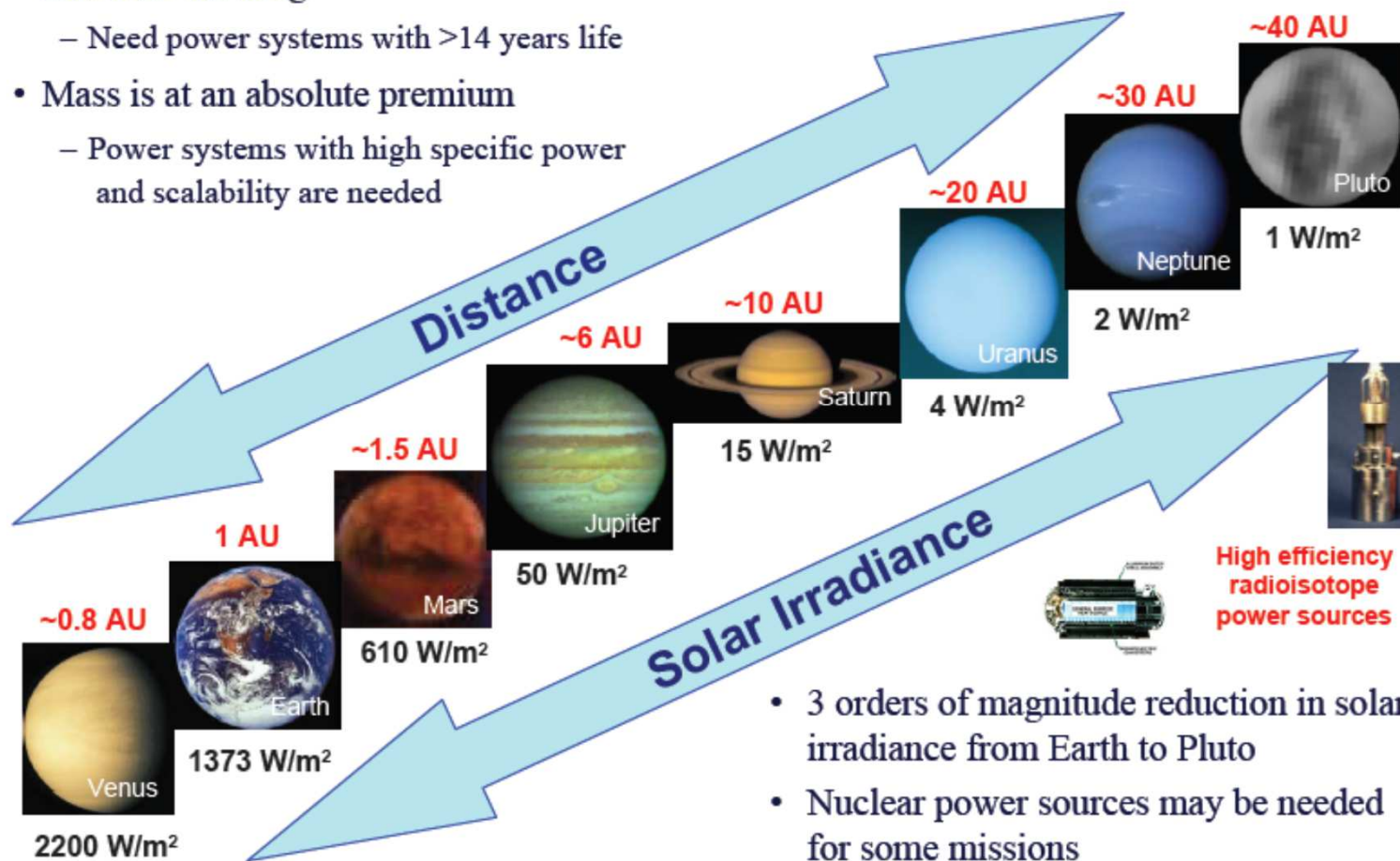

- 3 orders of magnitude reduction in solar irradiance from Earth to Pluto
- Nuclear power sources may be needed for some missions

T. Caillat et al 23rd rd Symposium on Space Nuclear Power and Propulsion STAIF 2006 Jet Propulsion Laboratory/California Institute of Technology

# Space applications (Mars exploration)

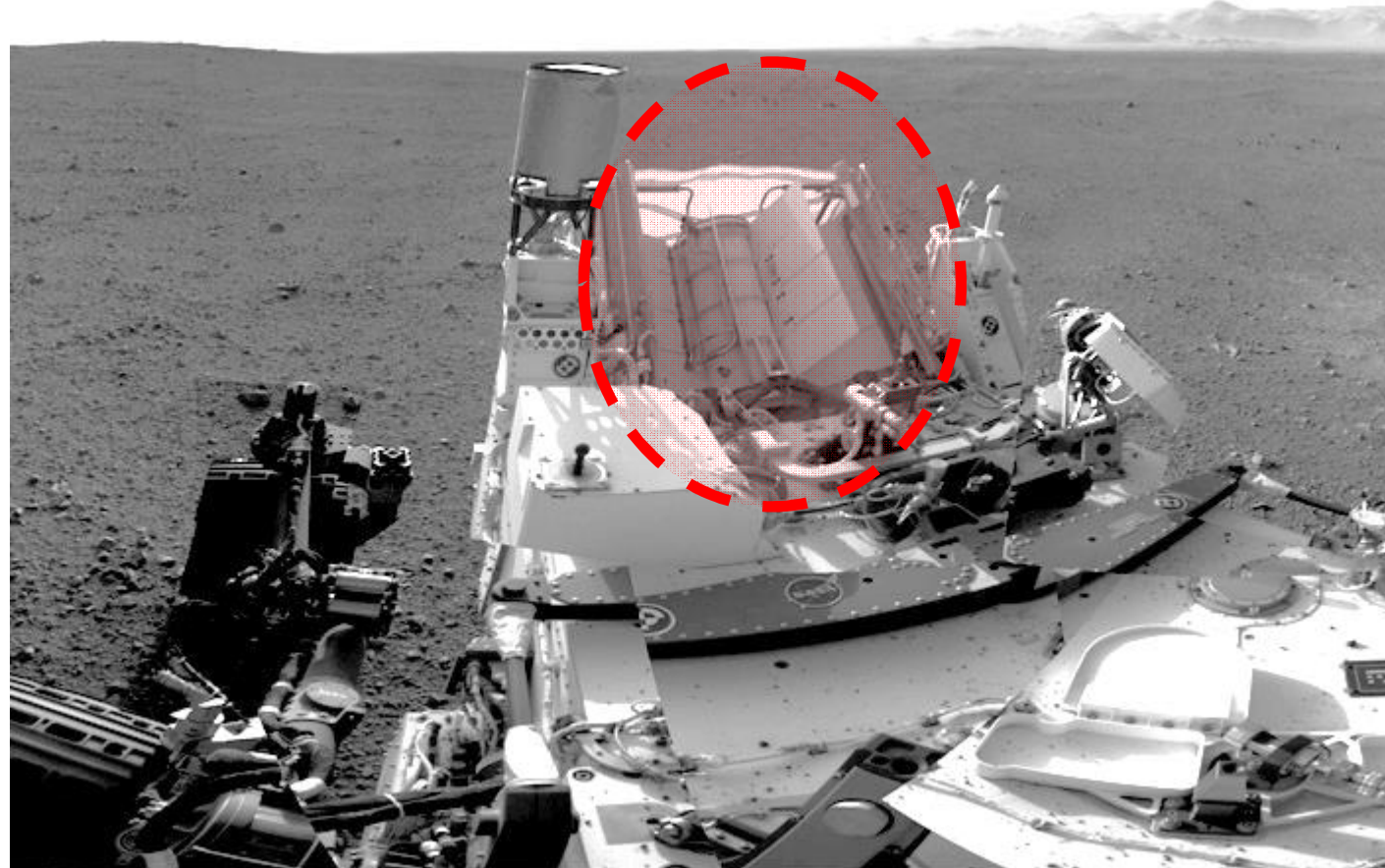

Curiosity 2m x 2m x 2m  
RTG 0.6m x 0.6m x 0.6m  
45kg 110W  
PbTe Tag

Curiosity's Radioisotope Thermoelectric Generator

<http://solarsystem.nasa.gov/rps/rtg.cfm>

# Space applications

Radioisotope Thermoelectric Generator RTG	Electric Power at beginning of mission per RTG	Number of RTG	Mission	destination	year	design lifetime	lifetime
Space Nuclear Auxiliary Power SNAP-3 <b>PbTe</b>	2,7 Watts	1	Transit	Navigation satellite	1961		15 years
SNAP-19B RTG <b>PbTe-Tags</b>	28.2 Watts	2	Nimbus III	meteorological satellite	1969		
SNAP-19 RTG <b>PbTe-Tags</b>	42.6 Watts	2	Viking 1	Mars landers	1975	90 days	6 years
		2	Viking 2	Mars landers	1975	90 days	4 years
	40.3 Watts	4	Pioneer 10	Jupiter, asteroid belt	1972	5 years	30 years
		4	Pioneer 11	Jupiter Saturn	1973	5 years	22 years
SNAP-27 RTG <b>PbSnTe</b>	70 Watts		Apollo 12, 14, 15, 16 , 17	Lunar Surface	1969-72	2 years	5-8 years
Multi-Hundred Watt (MHW) RTG <b>SiGe</b>	158 Watts	3	Voyager 1 & 2	edge of solar system	1977		still operating over 42 years
General Purpose Heat Source (GPHS) RTG <b>SiGe</b>	292 Watts	2	Galileo	Jupiter	1989		14 years
		3	Cassini	Saturn End mission 2017	1997		21 years
		1	Ulysses	Jupiter	1990		21 years
		1	New Horizons	Pluto (12/2014) , Kuiper Belt (2019)	2006		still operating after 13 years
Multi-Mission Radioisotope Thermoelectric Generator MMRTG <b>PbTe-Tags</b>	110 Watts	1	Curiosity	Mars Surface 5 Aug 2012	2011		Expected 14 years

# Space applications

## Conclusion

### Radioisotope Thermoelectric Generator

- compact
- Continuous power sources
- Heat exchange on the hot side by conduction (high temperature)
- Used in deep space for several decades
- reliable
- Use nuclear fuel relatively easy to manipulate Curium-244 and Plutonium-238
- Materials used: PbSnTe, PbTe, TAGS, SiGe

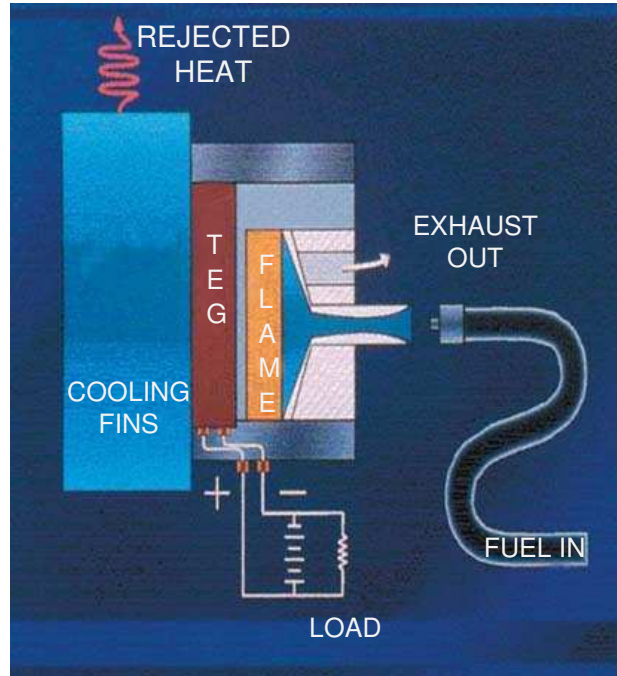

500 Watts 24 Volts  
 Natural Gas 48m<sup>3</sup>/day  
 Propane 76L/day or 38kg/day

Propane 38kg/day  
 Heating Value 50MJ/kg → Energy per day= 1900MJ=527kW.h  
 500 W electric → Energy per day= 12 kW.h Efficiency : 2.2 %

Critical application requiring highly reliable power  
 Low maintenance required  
 Long life  
 Extreme climatic conditions (hot, cold, wet, dry)  
 Remote locations



**Pipeline:** 550 watts communications system  
 Andes Mountains, Chile



**Off shore:** 200 watts communications and safety equipment, multiple systems  
 - Thailand

# Waste Heat Recovery

Estimated U.S. Energy Consumption in 2018: 101.2 Quads

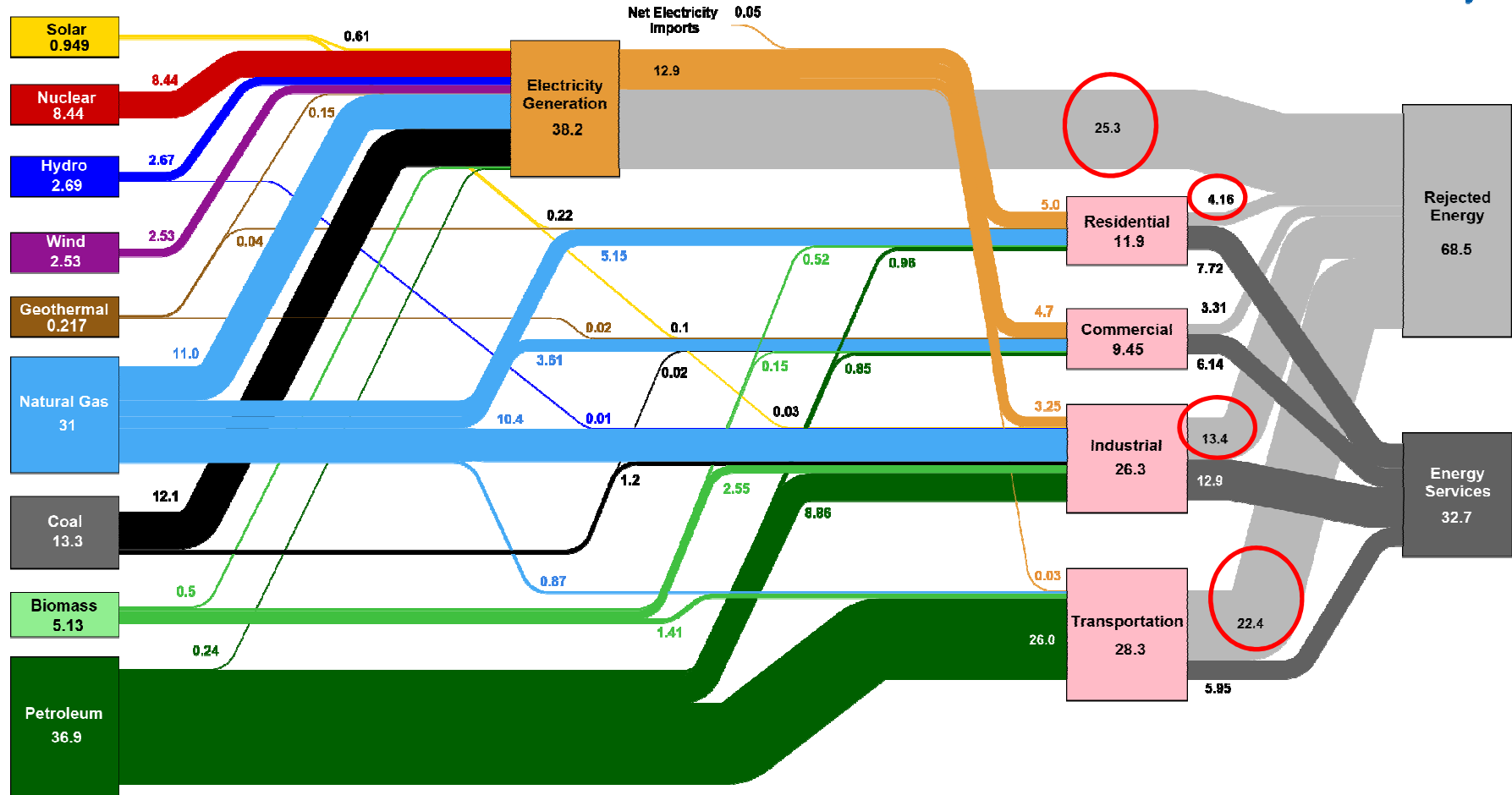

Source: EIA March, 2019. Data is based on DOE/EIA NEER (2018). If this information or a reproduction of it is used, credit must be given to the Lawrence Livermore National Laboratory and the Department of Energy, under whose auspices the work was performed. Distributed electricity represents only retail electricity sales and does not include self-generation. EIA reports consumption of renewable resources (i.e., hydro, wind, geothermal, and solar) for electricity in BTU-equivalent values by assuming a typical fossil fuel plant heat rate. The efficiency of electricity production is calculated as the total retail electricity delivered divided by the primary energy input into electricity generation. End use efficiency is estimated as 65% for the residential sector, 65% for the commercial sector, 21% for the transportation sector and 49% for the industrial sector, which was updated in 2017 to reflect DOE's analysis of manufacturing. Totals may not equal sum of components due to independent rounding. LBNL E1-410227

$$1 \text{ quad} = 2.93 \cdot 10^{11} \text{ kWh} = 1.055 \cdot 10^{18} \text{ J} = 293 \text{ million of MWh}$$



# Background

## Roadmap for climate and energy policies

### 2008 European Council

new environmental targets : "three 20 targets"  
by 2020

- To reduce emissions of greenhouse gases by 20%.
- To increase energy efficiency to save 20% of EU energy consumption
- To reach 20% of renewable energy in the total energy consumption in the EU.

### 2014 European Council

new environmental targets  
by 2030

- To reduce emissions of greenhouse gases by 40%.
- To continue improvements in energy efficiency
- To reach 27% of renewable energy in the total energy consumption in the EU.

## Thermoelectric technology for automotive Waste Heat Recovery

Prototypes :

- FIAT
- FORD
- GM
- BMW
- Renoter (Renault truck Volvo ...)
- Amerigon
- .....

# Thermoelectric technology for automotive Waste Heat Recovery

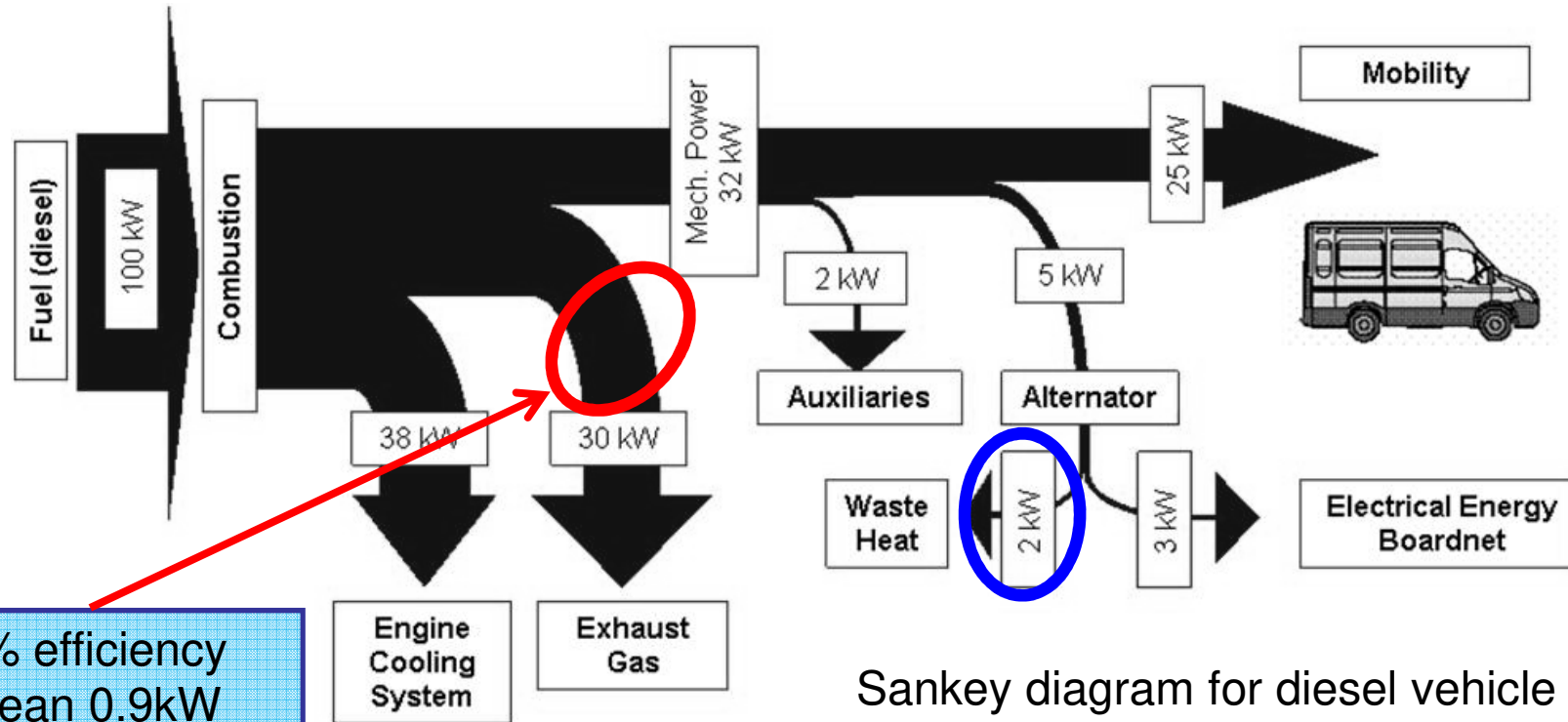

3% efficiency  
mean 0.9kW

light duty trucks

Sankey diagram for diesel vehicle

# Thermoelectric technology for automotive Waste Heat Recovery

## New CO<sup>2</sup> emission performance standards

Emission target for passengers cars

130g/km for 2012

drastically reduced to 95g/km for ~~2020~~ 2021 (-37,5% for 2030 (12/2018))

fuel consumption of around 4.1 l/100 km of petrol or 3.6 l/100 km of diesel

Emission target for light duty trucks

175g/km for ~~2014~~ 2017

~~135~~ 147g/km for 2020. 5.5 l/100 km of diesel

Fine and penalties to be paid by car manufacturers that exceed EU CO<sup>2</sup> limits

20€ per exceeding gram starting from 2012

95€ per exceeding gram starting from 2019

[ec.europa.eu/clima/policies/transport/vehicles/cars\\_en](http://ec.europa.eu/clima/policies/transport/vehicles/cars_en)

# Thermoelectric technology for automotive Waste Heat Recovery

## Electricity produced by alternator

- Conversion efficiency from fuel chemical energy to mechanical energy ➤ 25-27%
- alternator efficiency from mechanical to electrical energy ➤ 60%
- conversion efficiency from fuel chemical energy to electrical energy ➤ 15-16%

## Electricity produced by TEG

small-medium gasoline engine at motorway driving condition is characterized by a thermal power, in its exhaust gases, of **10kW** at 600°C, **4-5%** system conversion efficiency, which can be feasible with  $ZT=1-1.2$  is enough to guarantee 400-500  $W_{el}$ .

**400-500 $W_{el}$  means 6-7g/km CO<sup>2</sup> reduction** (Fiat Research Center)

## Requirements

- Backpressure limit in TEG
  - Exchanger must not disturb too much exhaust gases: pressure drops very low (tens of a few millibars).
- Temperature limit for TE materials (add bypass for exhaust gases)
- Durability test requirements
- Assembly requirements
- Control and sensor requirements
- Power conditioning (DC/DC converter)
- Recycling
- Price and Performance

# Possible locations for TEG

## TEG in a vehicle require

- Water supply
- By Pass
- Heat exchanger
- High Temperature and MassFlow

## Integration in the exhaust system:

### Advantages

- Highest recuperation potential

### Disadvantages

- Exchangers : high integration effort
- Connection to cooling system
- Bypass : (flat possible but expensive)

## Integration into the EGR (Exhaust Gas Recirculation) for a diesel engine:

### Advantages

- Easier to integrate (existing exchanger)
- Control for mass flow (EGR valve)
- Cooling water already there

### Disadvantages

- Reduced recuperation potential (5 à 35%)

Exhaust Gas Recirculation reduces NOx emissions by reducing the combustion temperature in Diesel engines.

EGR works by recirculating a portion of an engine's exhaust gas back to the engine cylinders.  
Gas must be cooled

A. Eder, BMW group, thermoelectrics applications San Diego 2011

# HeatReCar

first light commercial vehicle equipped with a TEG



## Vehicle



IVECO Daily, 2.3l Diesel engine

## Design reference condition

Vehicle 130km/h

Exhaust gas temperature: 450°C

Gas flow : 70g/s (max torque), 140g/s (full load)

## Target performance

TEG electrical output 1kW



# HeatReCar

first light commercial vehicle equipped with a TEG



Cross Flow architecture.

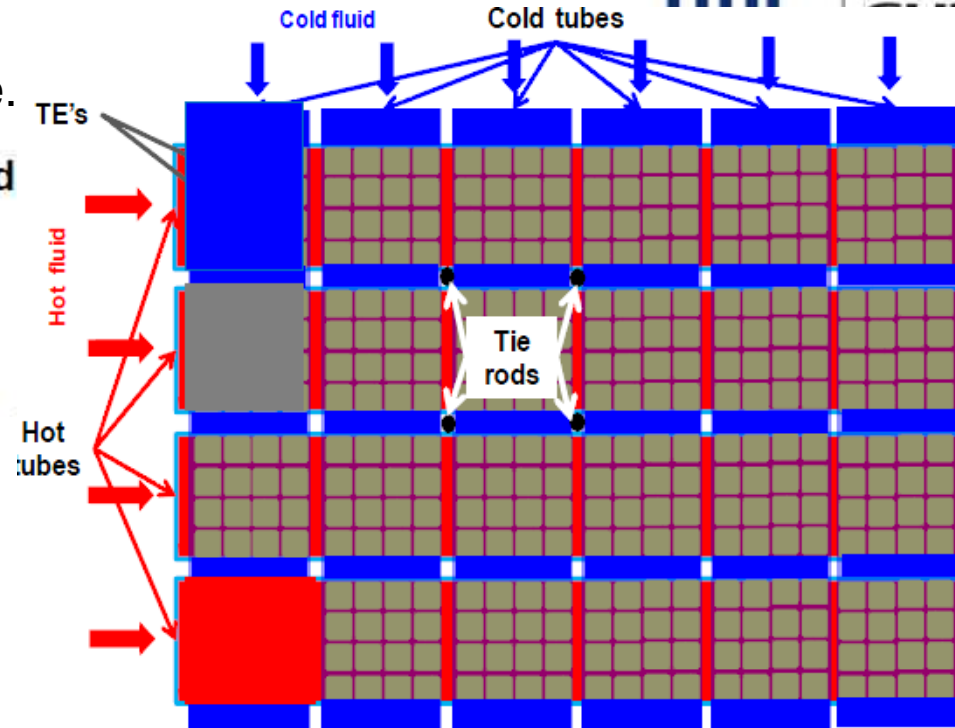
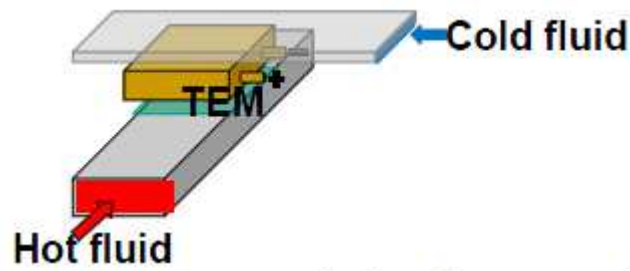

Material considered

- TAGS
- Segmented Bi<sub>2</sub>Te<sub>3</sub>-PTE
- Skutterudites: developed and manufactured at Module level
- Bi<sub>2</sub>Te<sub>3</sub>: used for the full scale prototype manufacturing with specific Module design**



16 x 16 mm

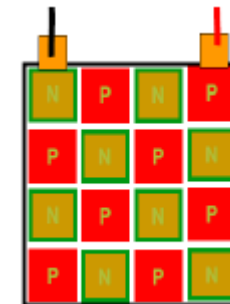

D. Magneto 3rd International Conference Thermal Management for EV/HEV Darmstadt 24-26 June 2013

# HeatReCar

first light commercial vehicle equipped with a TEG



TEG architecture.

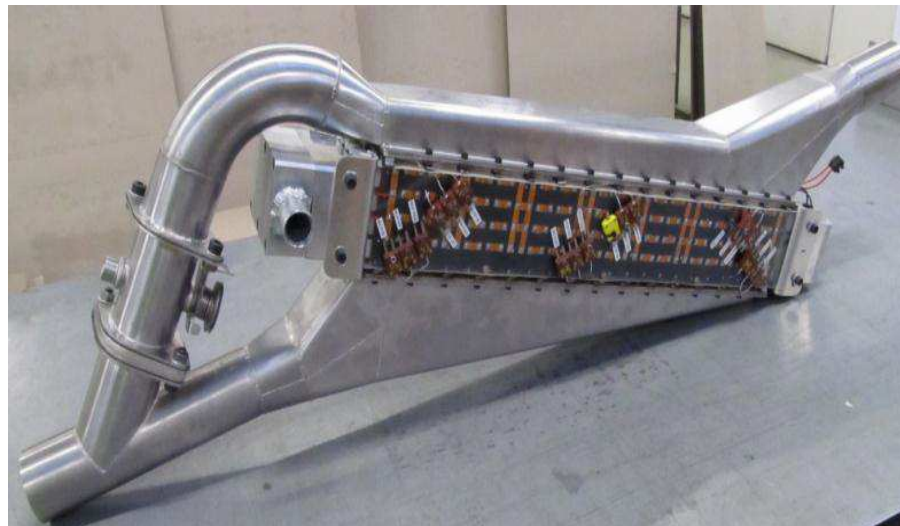
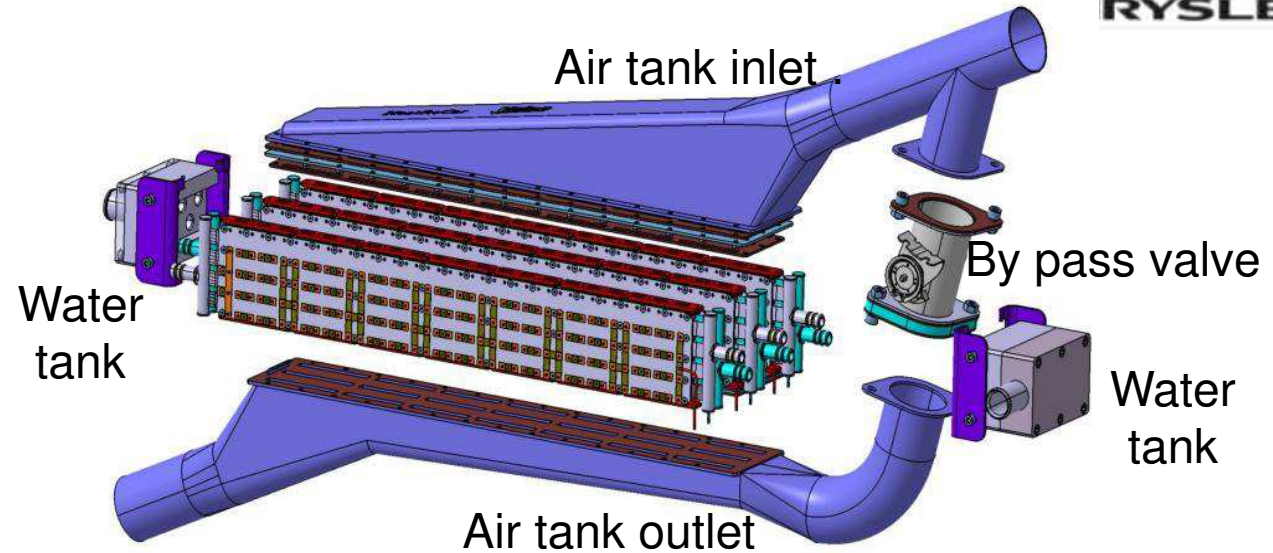

Core size 500x100x100mm

Core weight 4kg

D. Magneto 3rd International Conference Thermal Management for EV/HEV Darmstadt 24-26 June 2013

## TEG performances on the test bench

Hot gaz flow: 90g/s  
 $\Delta P$  hot gaz: **30mbar**  
 T hot gaz: 450°C

Cold liquid flow: 1200l/h  
 $\Delta P$  liquid flow: 0.15 bar  
 T cold flow 60°C

**U: 32.1V**  
**I : 15A**  
**P: 482W**

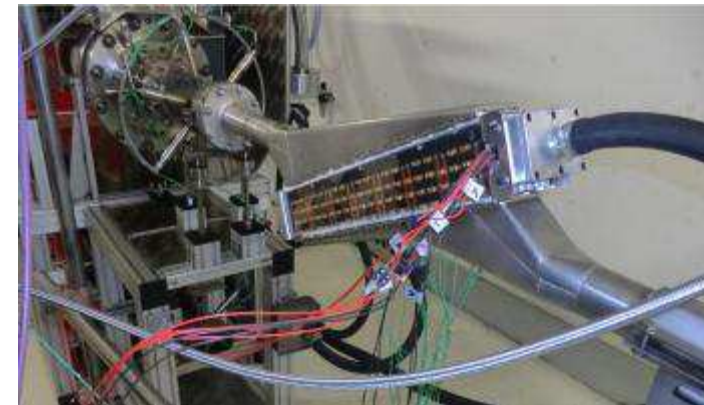
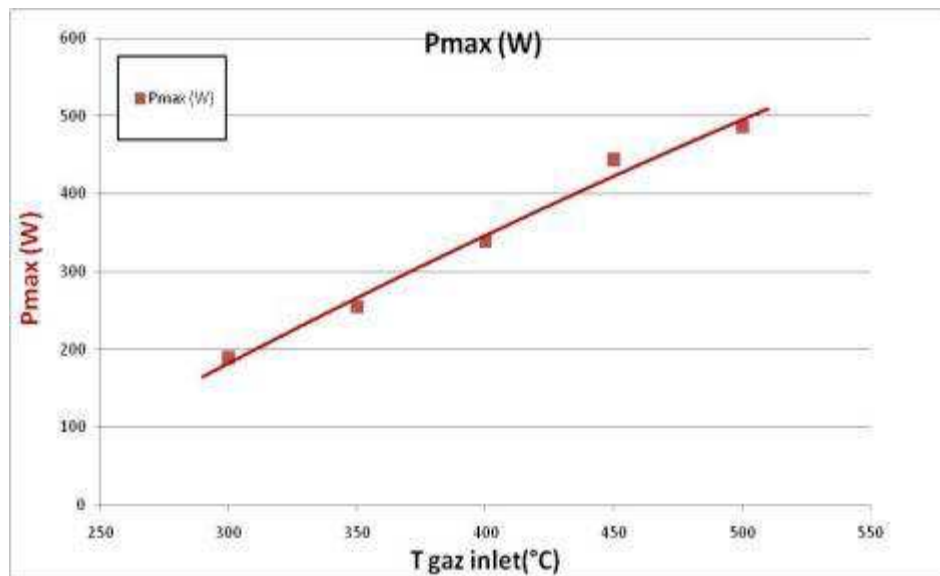

# HeatReCar

first light commercial vehicle equipped with a TEG

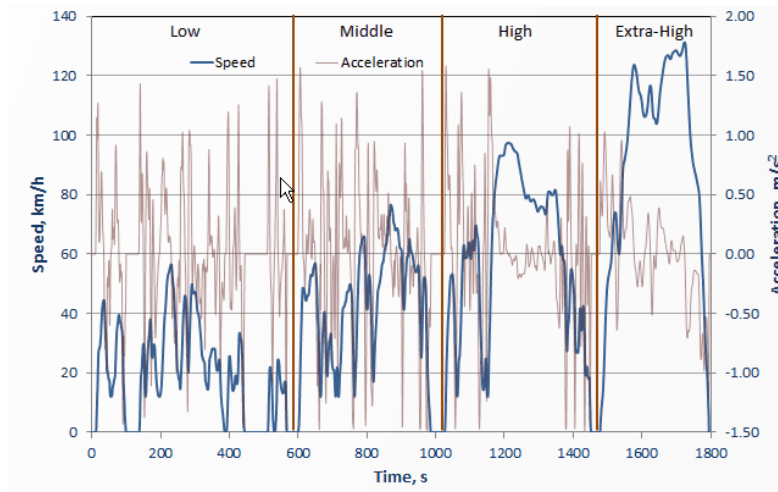

the WLTP test is expected to replace the European NEDC procedure for testing of light-duty vehicles

[www.dieseln.net/standards/cycles/wltp.php](http://www.dieseln.net/standards/cycles/wltp.php)

TEG on board installation



## On board vehicle results summary

- 4% fuel economy improvement over the WLTC cycle has been achieved

D. Magneto 3rd International Conference Thermal Management for EV/HEV Darmstadt 24-26 June 2013

GENTHERM ex AMERIGON ex BSST (BMW et Ford)

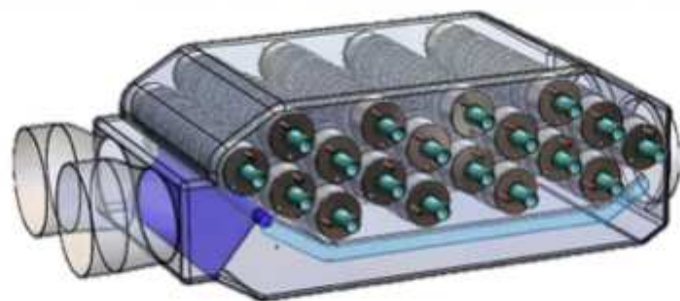

TEG building block  
(cartridge) defined  
and extrapolated to  
TEG design concept.

18 Cartridges

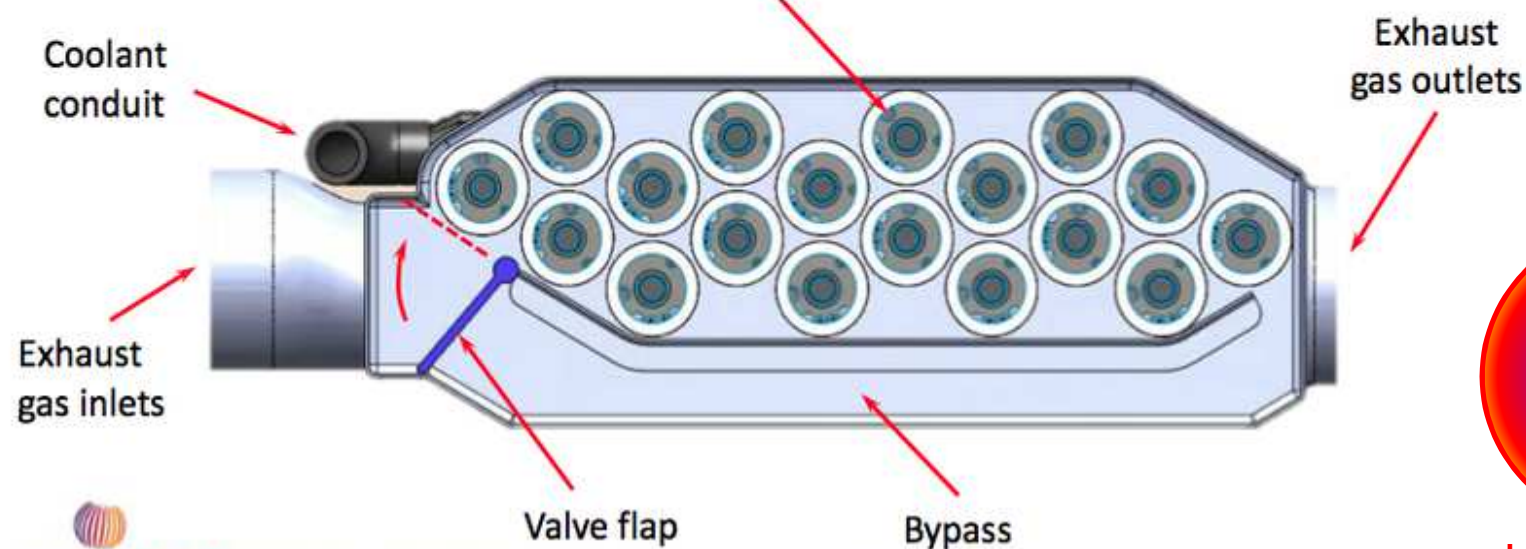

12

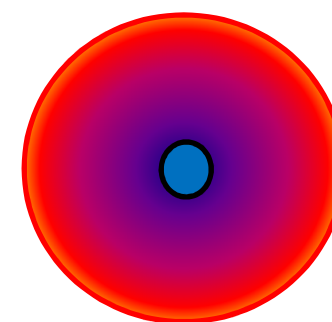

Hot side  
Larger area  
Best  
exchange

Tenneco's booth at the 2013 Frankfurt IAA Motor Show

# Automotive TEG (ATEG)

→ 2014

many projects financed on TEGs for the automotive sector  
prototypes assembled and tested under real operating conditions (NDEC cycles)

2014 → ?

still publications  
But no marketing of ATEG

Possible explanations :

- Cost (expected 0.5 – 1 €/W)
- End of diesel and petrol cars...2030? 2040? 20xx?  
(France 2040, Britain 2040, Northway 2025, India 2030)

Outlook

- Decreasing cost
- **Hybrid vehicle**
- **Heavy vehicle**

# hybrid vehicle

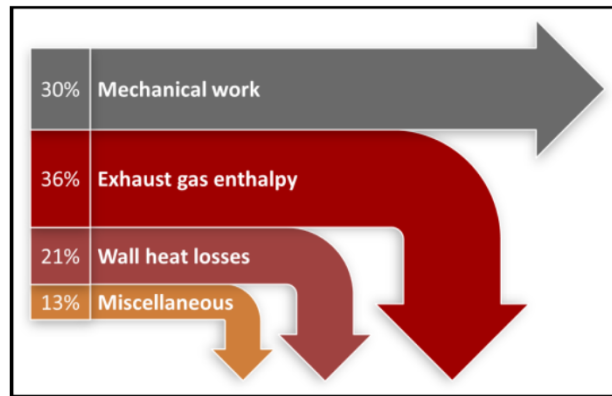

Energy flow diagram of a **conventional drive train** in average over the WLTP cycle

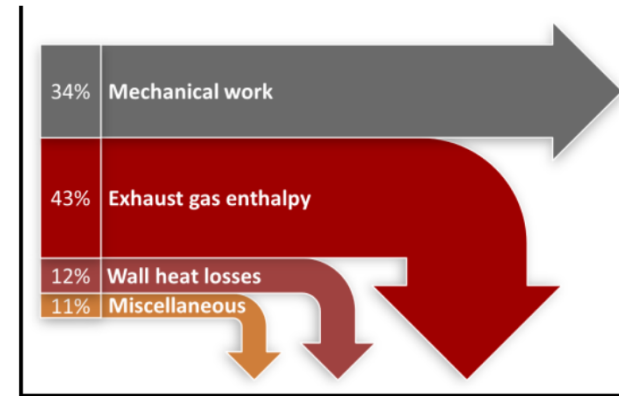

Energy flow diagram of a **power-split plug-in hybrid** in average over the WLTP cycle

Exhaust gas temperatures and Exergetic potential for waste heat recovery in hybrid vehicles are also higher

The high potential of thermoelectric generators for WHR in hybrid vehicle Martin Kober ICT2019

# Truck



## Eu6 6-cylinder Scania diesel engine for Titan Truck

TEMs in two separate locations in the exhaust system

- behind the after treatment system, ATS (ATS need high temperature)
- in the exhaust gas recirculation, EGR system.

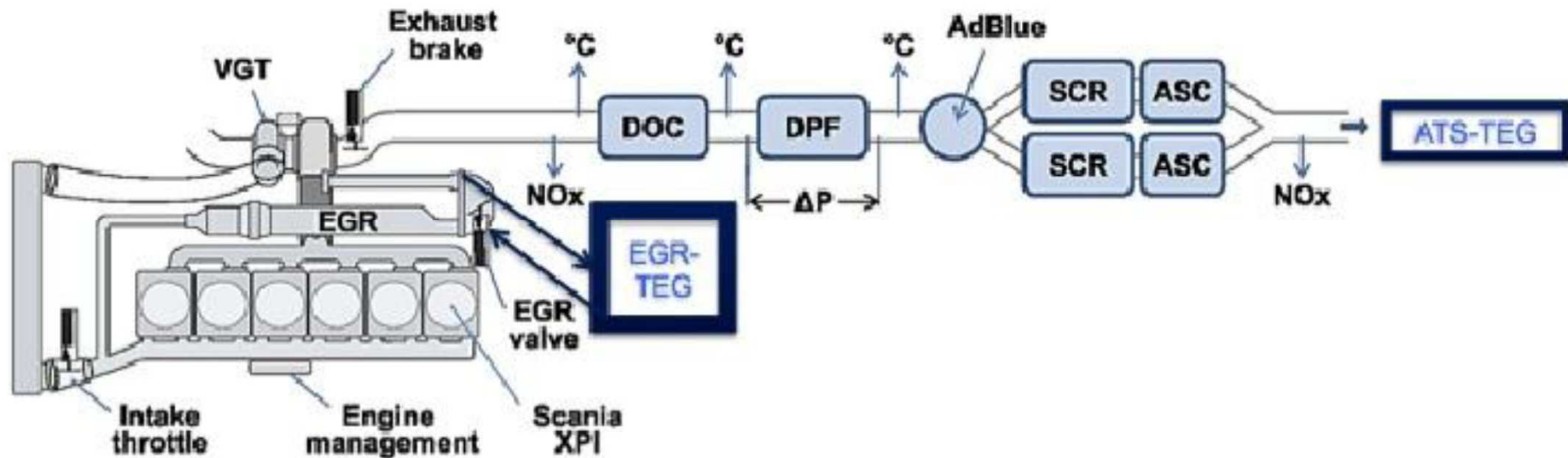

Eberspächer GmbH responsible for design and manufacture of the ATS-TEG and TitanX AB for the EGR-TEG.

2015 Waste heat recovery system with new thermoelectric materials J.Coyet F. Borgström



# Truck

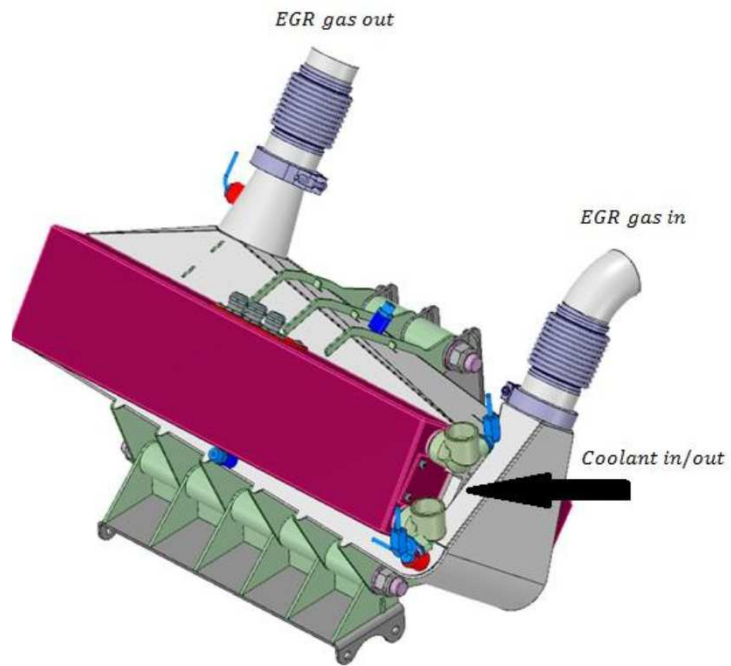

EGR-TEG

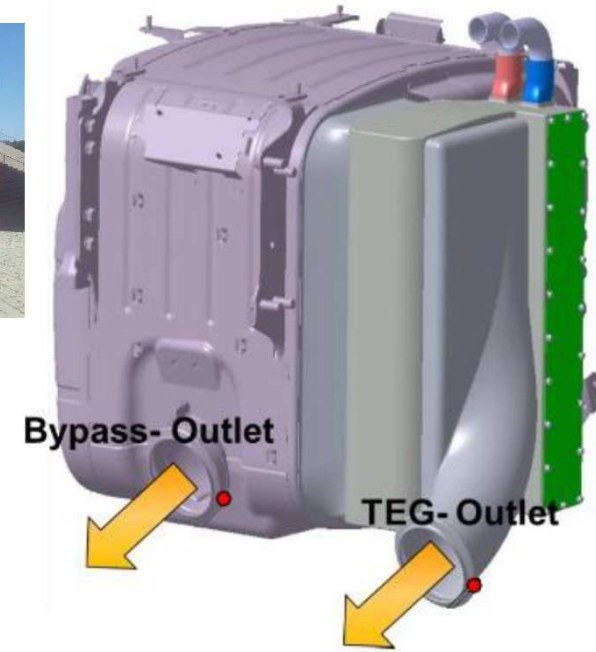

ATS-TEG



Photos ICT2015

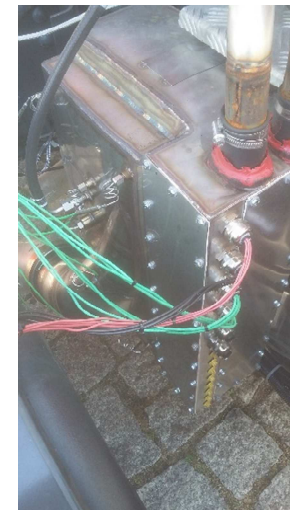

# Aircraft Thermoelectric Applications

How can Thermoelectric Contribute?

Aircraft engine waste heat harvesting has large potential payoffs

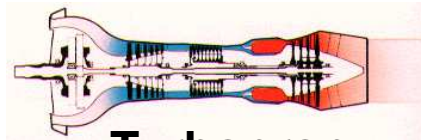

**Turboprop**



**Turboshaft**

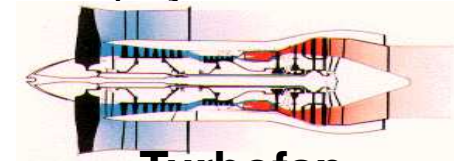

**Turbofan**



## Advantages

- Provides electrical power from waste heat – no fuel burn and no moving parts
- Operates over the entire aircraft flight envelope
- Operates independent of engines and does not affect engine operations

## Disadvantages

- New technology and **unproven**
- Cost & efficiency; further development is needed
- Power output limited by available waste heat, space, device efficiency.

### Fuel Reduction

Preliminary analysis showed that **0.5%** or more fuel reduction is achievable

### Operating Cost Reduction

Average monthly fuel costs for U.S. commercial planes is \$2.415B for the first 4 months of 2009 (Source: EIA)

A 0.5% fuel reduction : **\$12M monthly operating cost reduction**

2009 James Huang, Boeing Research & Technology

**Watt per kilo?**  
**Permitted 0.15 kW/kg**  
**Helicopter conical nozzle**  
**Champier : 0.04kW/kg**

# Usage of Thermoelectric Generators on Ships

## Ship transport generates a large amount of waste heat

- main engine (8-15 MW) (heavy fuel oil)
- auxiliary engines
- incinerator (waste oil : sludge representing 2% of oil consumption of the main engine)
- Workers at heavy cost .
- Cold sink between 5°C and 28°C available (seawater)
- no problem with space and weight

Wasted heat used for heating of heavy fuel oil  
 •Heating of accommodation areas  
 •freshwater generation

Work intermittently

Working time : 12h to 20h /day

Thermoelectric generator

Steam engine :  
 Needs a worker at start and stop : heavy cost

Kristiansen : incinerator 850kW, calculation : 38kW electric cost 2,7US\$/W.

# radiant heat in steelmaking industry

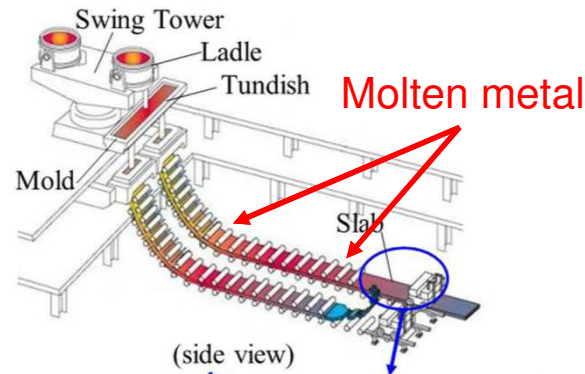

JFE Steel Corporation Japan

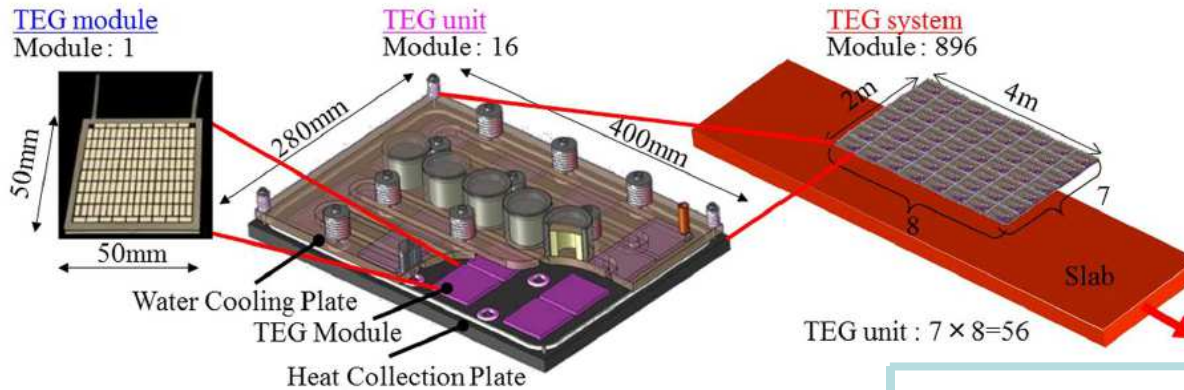

A TEG system (about 4 m x 2 m) using radiant heat from the continuous casting slabs  
896 TE modules (56 TEG units of 16 TE modules of Bi<sub>2</sub>Te<sub>3</sub>)  
The thermoelectric generation system outputs about 9 kW when the slab temperature is about 915°C

2014 kuroki Thermoelectric Generation Using Waste Heat in Steel Works

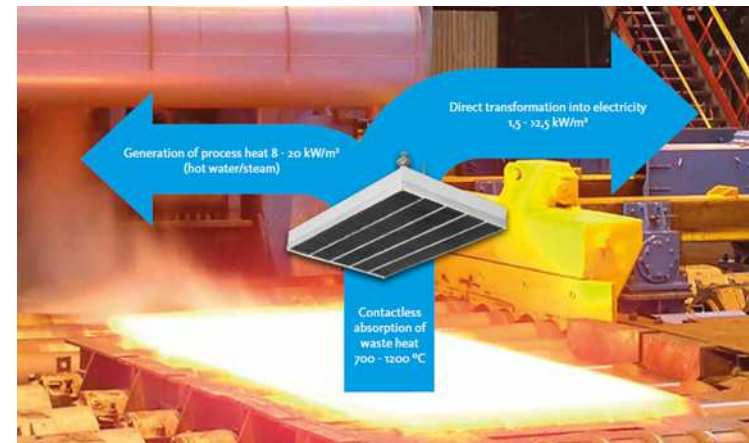

Thermagy™ heat panels:

# waste heat recovery

## Conclusion

New materials : light, environment friendly, cheap.

**Automotive (hybrid car, trucks and farm machines)**



**Ships**

Promising

**Airplanes**

More research is necessary

**radiant heat in industry**

Promising

# Domestic production : Decentralized electricity generation

## **Developing countries**

Biomass primary energy source  
(cooking, heating, domestic hot water)

## **Developed countries**

Connection to the network is not always  
economically attractive

Biomass stoves  
Combined Heat and Power (CHP)

# Developing countries : TEG for Biomass Stoves

**Biomass energy is used for basic needs : cooking and heating**



## Open fire

very low efficiency (5-10%)  
emission of harmful black fumes  
increase pressure on local forests



## Rocket stove

efficiency  
(~35%)



## T-LUD

(Top Lid UpDraft)

efficiency  
(~40%)

## improved multifunction biomass fired stove

85 % global efficiency  
maxi CO level of 200 g/GJ



wood consumption divide by two

cooking  
domestic hot water:  
low temperature radiant heating  
mechanical extraction no chimney



electric fan is necessary

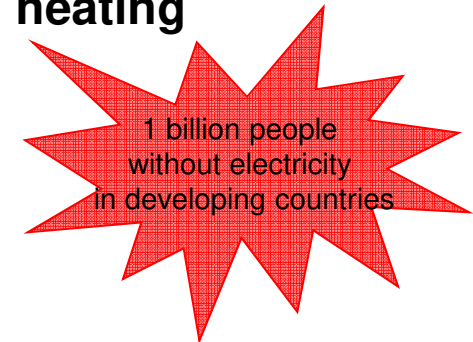

1 billion people  
without electricity  
in developing countries

They need electricity for light and cellular phone

Connecting to the power grid :  
cost of building new landlines  
from US\$300 to more than US\$4000  
cost of distribution of electricity  
from US\$0.07 to US\$5.1 per kWh



thermoelectric generators  
are cost-effective solutions



# “Planète Bois” Cooking stove and TEG

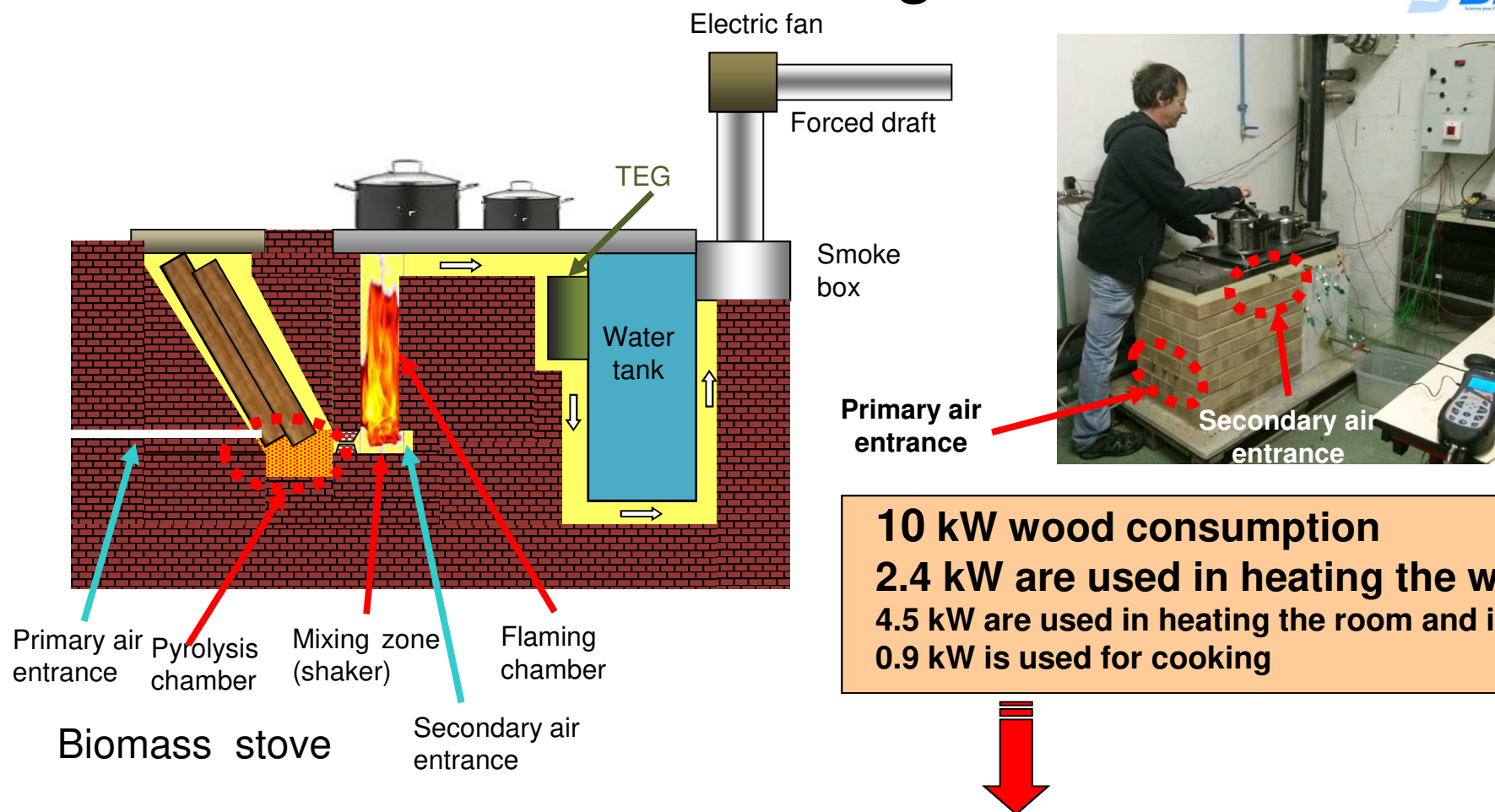

**10 kW wood consumption**  
**2.4 kW are used in heating the water**  
**4.5 kW are used in heating the room and inertia**  
**0.9 kW is used for cooking**

The idea is to put the TEG in a cogeneration system which simultaneously provides electric power and heat for the hot water



# TEG for stoves

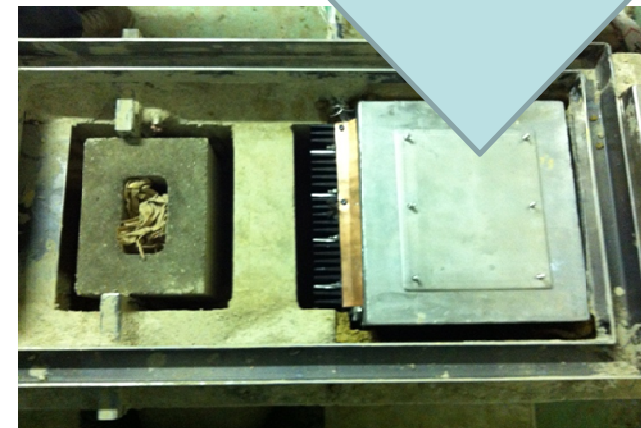
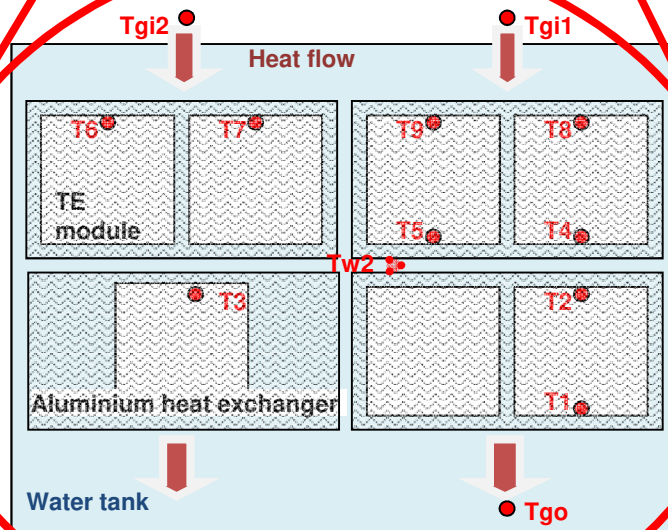
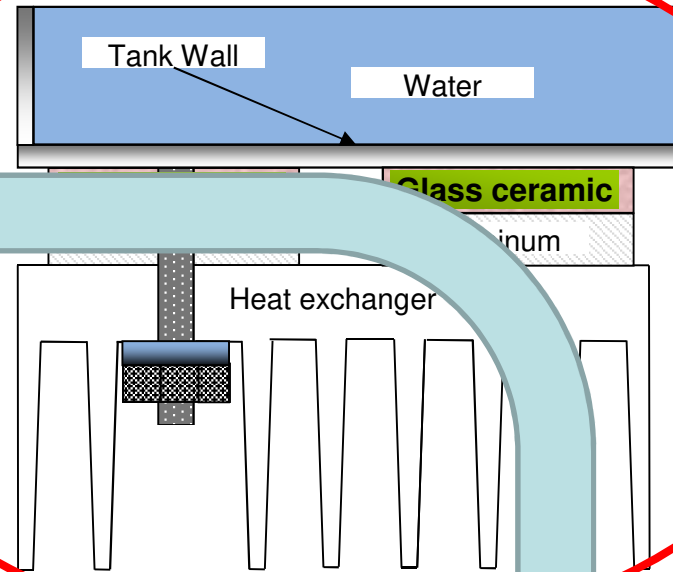
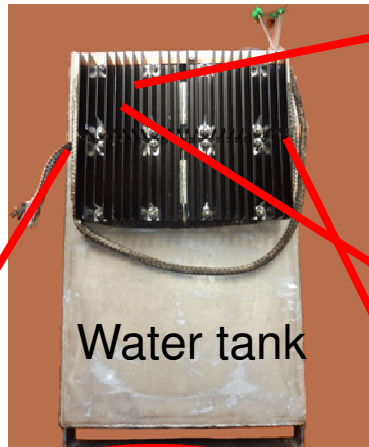

# “Planète Bois” Cooking stove and TEG

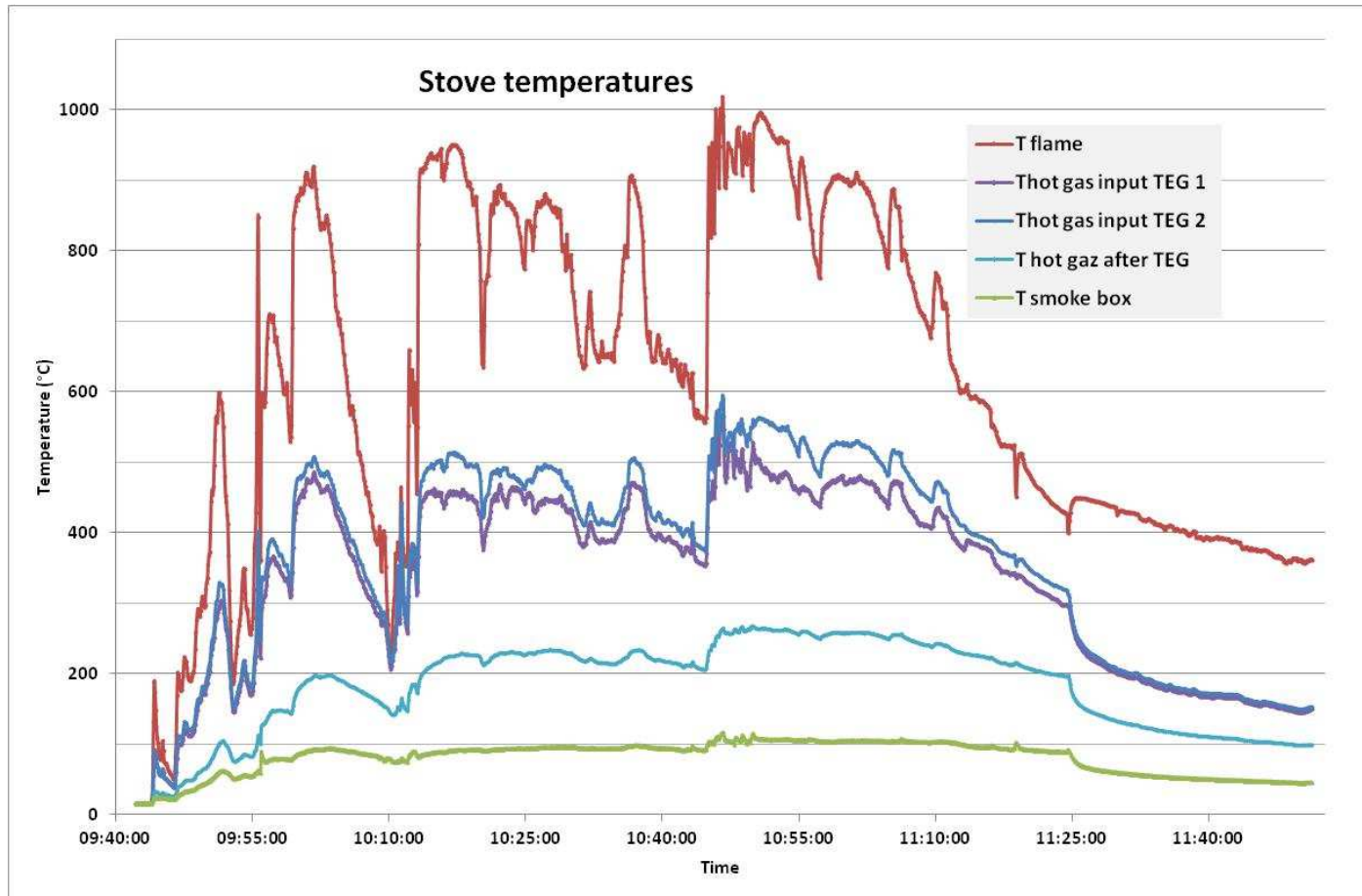

Temperatures fluctuate a lot

# “Planète Bois” Cooking stove and TEG

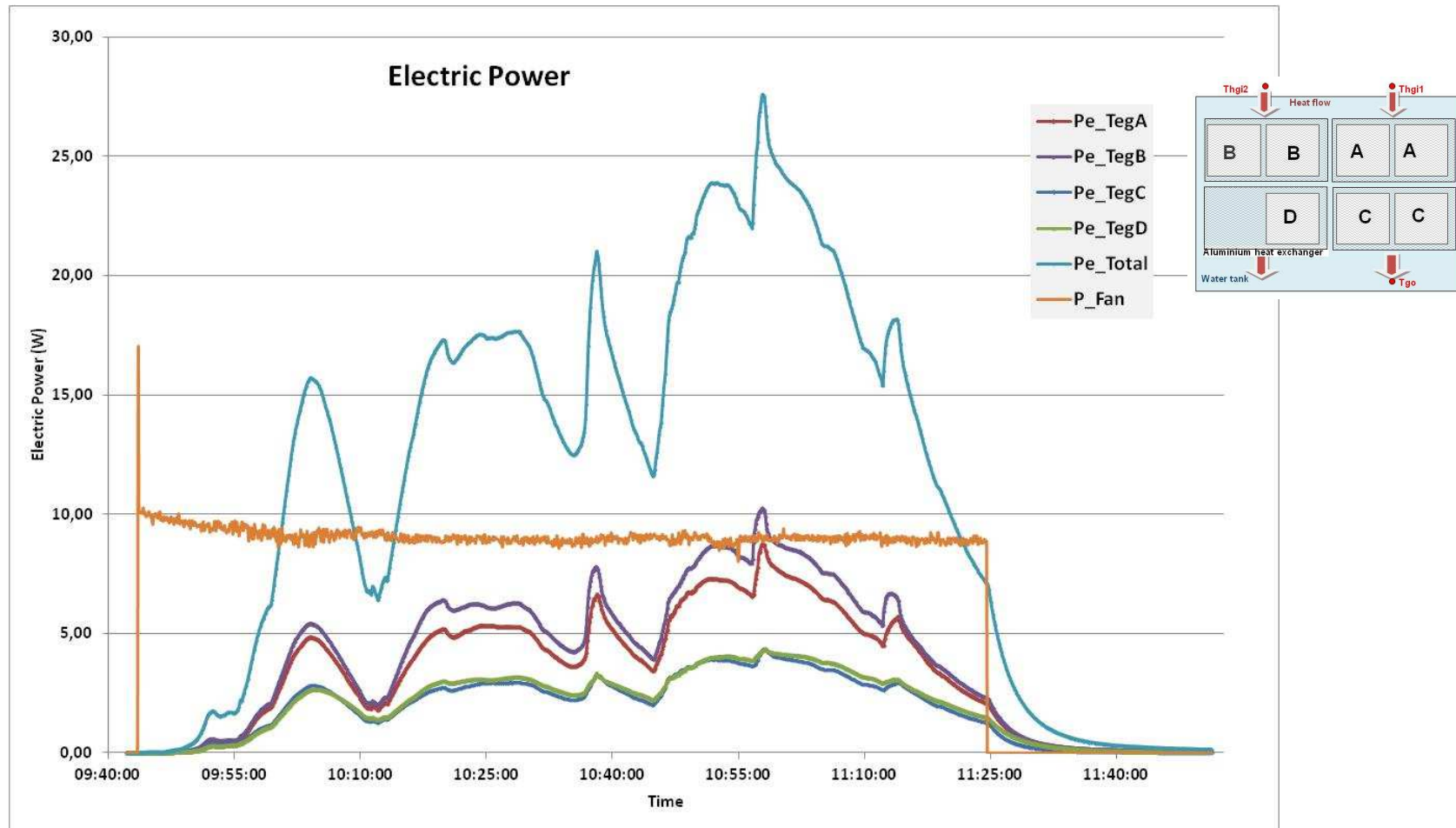

Output Electrical Energy : 23.7 W.h  
Fan consumption : 15.3 W.h

# TEG results.

<b>Cycle</b>	<b>one cooking 1h30min</b>	<b>Day 1 2 cookings</b>
Electrical energy produced	23.7Wh	<b>47,4Wh</b>
Average electric Power	15.8 W	
Fan consumption	15.3Wh	30,6Wh
Extra Use Use's exemple*	one phone charge 1 hours of light	<b>1 phone charge almost 4 hours of light</b>
<b>Major Advantage</b>	<ul style="list-style-type: none"> <li>- <b>Wood consumption divided by two</b></li> <li>- <b>Healthy (less black fumes)</b></li> <li>- <b>More comfort for women</b></li> <li>- <b>low CO</b></li> </ul>	

\* Phone battery of 3.7V, 1050mAh and light consumption of 4W

<b>Cost</b>	one sample	Big quantity
Aluminium	60€	30€
electronic part	31€	15€
TE modules	75€ <b>x6</b>	27€ <b>x 6</b>
<b>TE generator</b>	541€	207€

**TE generators are cost-effective solutions for off-grid households with low income.**

# SIAME prototype

## Advantages of TEG's

The advantages of thermoelectric generator are :

- It does not need extra energy from the stove.
  - It will use the heat flux between the gas and the water tank
  - It will only convert a small part into electrical energy.
- It is incorporated into the cook stove:
  - it requires no electrical link with the outside world, unlike solar panels, or manipulation of battery.
- The maintenance is very light:
  - nothing is moving,
  - everything is inside the house,
  - only the battery needs to be changed at the end of its life.
- The generator produces when the stove is on, day and night in good or in rainy weather (monsoon period) unlike solar panel.
- The battery does need to be oversized as each use of the stove recharges the battery unlike solar system where you need to store energy for the cloudy days.

# TEG in a biomass boiler

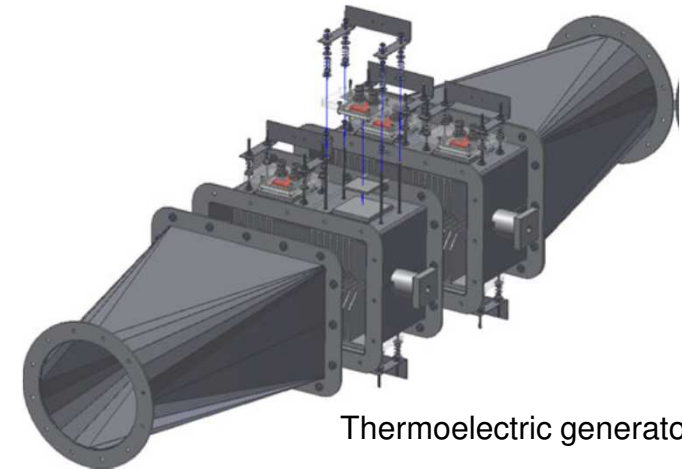
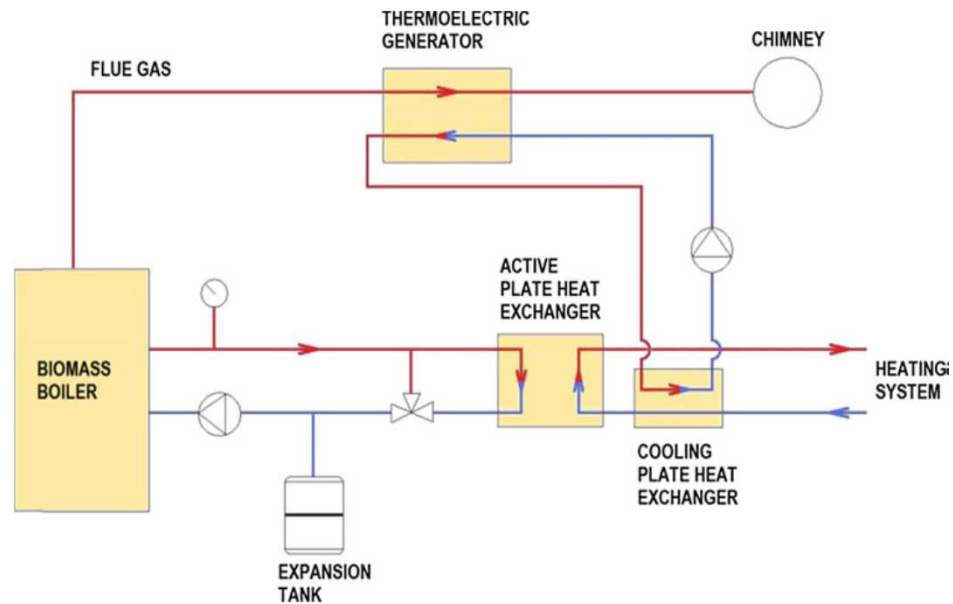

Thermoelectric generator.

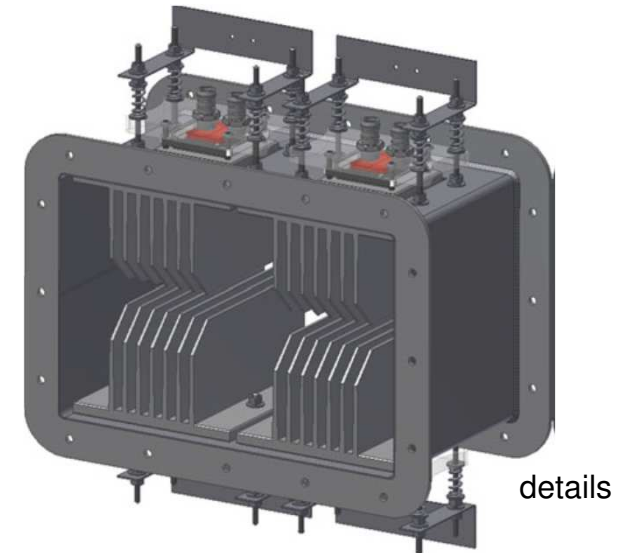

details

automatic biomass boiler Verner A251.1 with nominal rated heat output of 25 kW

$\Delta T = 113K$ .

Maximum measured output power 8.5 W.

Temperature lost by the flue gas in the TEG : 40K

➔ power for self-sufficient operation of the combustion and heating system without any negative influence on the boiler operation.

2013 Brazdil Thermoelectric power generation utilizing the waste heat from a biomass boiler Journal of ELECTRONIC MATERIALS,

# Biolite HomeStove and CampStove



Ghana



<https://biolite.boutiquesinternet.fr>  
99,95€ livraison gratuite

**USB 3W 5V**

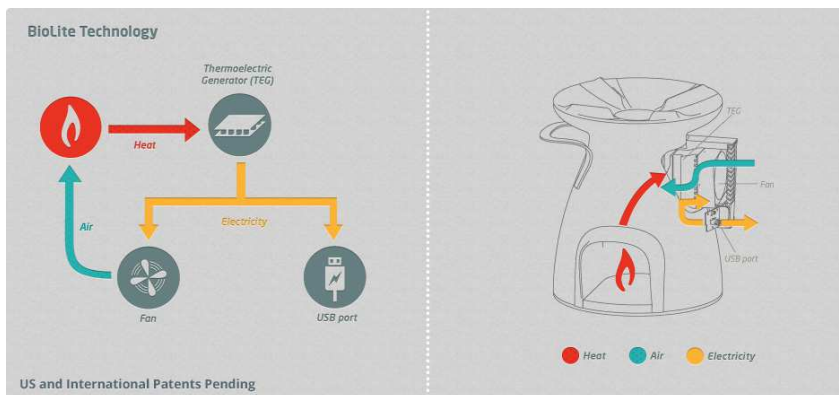

# micro CHP wood pellet stove

**BIOS BIOENERGIESYSTEME Graz**  
**RIKA Micheldorf, Austria**

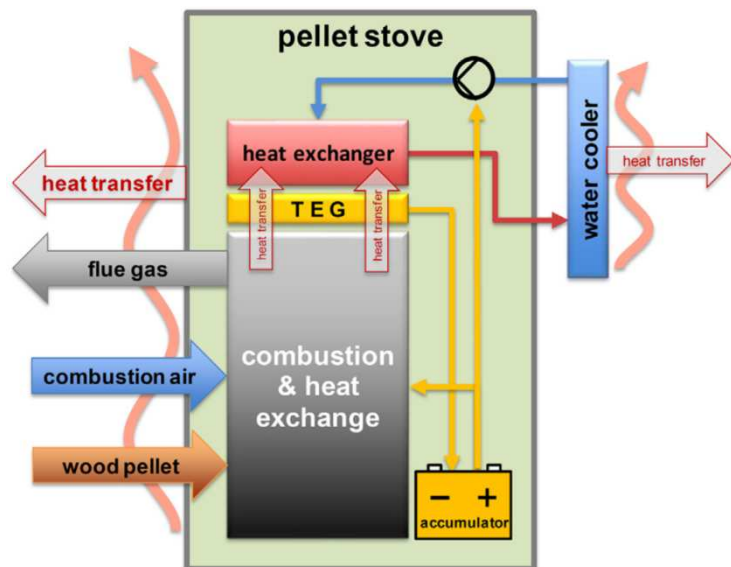

12 TEMs

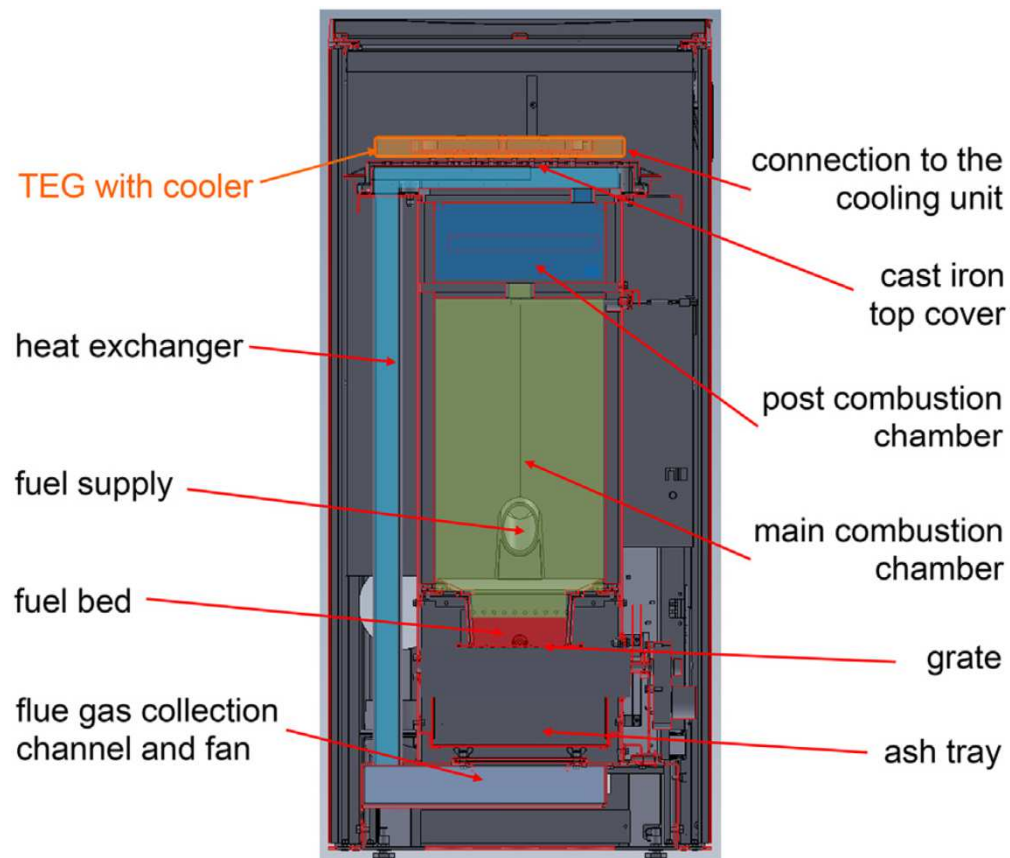

Cross section of the pellet stove CHP technology.

2018 Obernberger Development of a new micro CHP pellet stove technology, Biomass and Bioenergy



# micro CHP wood pellet stove thermal capacity 10.5 kW

**BIOS BIOENERGIESYSTEME Graz**  
**RIKA Micheldorf, Austria**



Testing plant

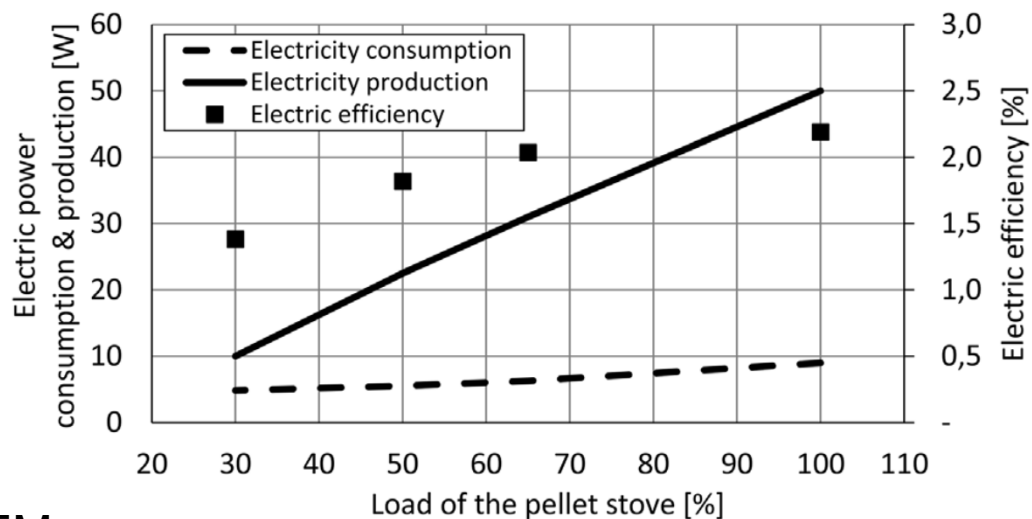

12 TEMs

surplus electricity production of about 40W at nominal load

at 30% part load the electricity demand of stove covered by the TEG.

Can operate **off-grid**

2017 :Its market introduction is planned by RIKA within 2018



## Stove “Seebeck 250W”



Seebeck 250W

Made in Germany by Thermoelect GmbH



wood gasification and two combustion chambers  
upper chamber is filled with logs

Exhaust gases are redirected to a second lower chamber by combustion nozzles for afterburning.

hot exhaust gases from the lower chamber tunnel flow into the flues of the back of the furnace

Lead to the chimney pipe around a water heat exchanger.

On the way up, the exhaust gases heat up the water in the heat exchanger.

Seebeck 250W : generation of heat, domestic hot water and electricity with thermoelectric generators (TEGs) with 250 watts

- 10-20 kW for heating and service water with high efficient wood-nano-cogeneration unit
- 60 liter filling volume for wood (logs) with a size of 33-40 cm
- up to 4 hours burning per wood charge
- a boiler for the heating room

250 watt of electricity for the entire house :

- Furnace as energy consumer (control system + fans) 50 W
- Boiler pump 20 W
- Heating circuit pump 15 W
- LED lighting, 14 LED lamps each 5 Watt 70 W
- Fridge/Freezer A++  
(Privileg PRB376, 196 l Fridge, 111 l Freezer, peak load 150 W)  
233kWh each year with average load of 27 W
- MacBook Pro in grid operation (100% brightness, MP4 Film) 20 W
- Charge iPhone 10 W
- Charge tablet 10 W

# Ecofan : heat-powered fans for stove heaters

The airflow created by the fan distributes the warm air from the stove more evenly in the room.

Average fuel saving of 14% for a range of standard test conditions Maintain user comfort levels over extended periods.



\$99.99

Time taken to reach 20°C from a cold start of 17°C in a standard test environment.

**With fan:** 68 minutes vs. **No fan:** 110 minutes

[www.caframolifestylesolutions.com](http://www.caframolifestylesolutions.com)

# Energy Harvesting for Low Power Electronics

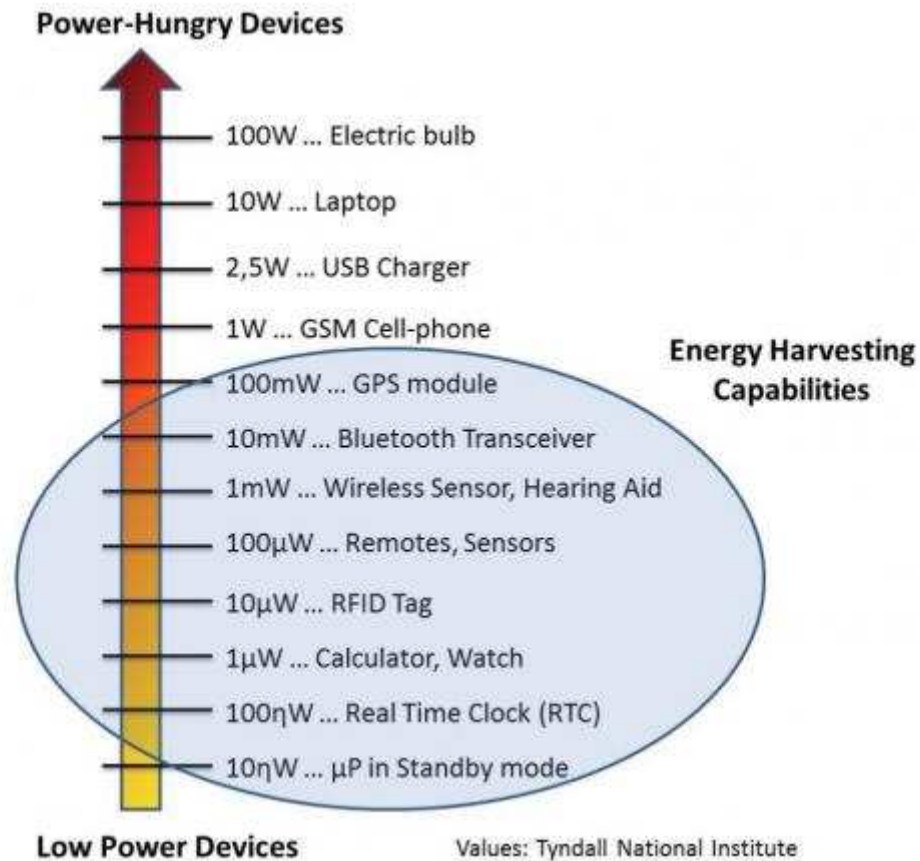

# Energy Harvesting for Low Power Electronics

Modern wireless sensor modules require only  $\sim 100 \mu\text{W}$  -  $10\text{mW}$   
Internet of Things (IoT)

Take a small portion of a lost flow of 'primary' energy, and convert it into a small flow of USEFUL electrical energy.

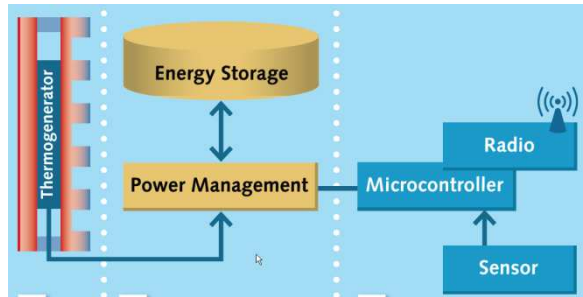

Every technical process produces waste heat

Micropelt thermogenerator offers a high density of up to 100 thermoelectric leg pairs per mm<sup>2</sup>

MPG-D751 dimensions (schematic drawing)

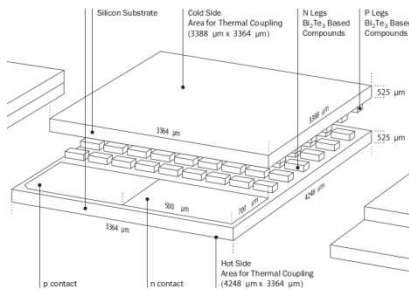

Electrical:

- Thermo-Voltage:  $u_{\text{TEG}} = 0.14 \text{ V/K}$
- Electrical Resistance:  $R_{\text{TEG}} \sim 350 \Omega$
- Thermal Resistance:  $R_{\text{th}} = 12,5 \text{ K/W}$



**4.2mmx3.3mmx1mm**

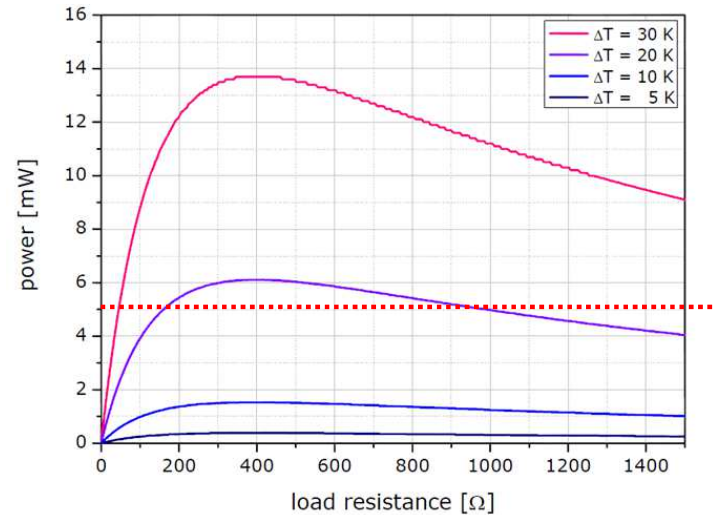

**5mW is enough for most microsensor**

<http://www.micropelt.com>

# Energy Harvesting for Low Power Electronics

**Emerson WiHART  
Differential Pressure Transmitter**

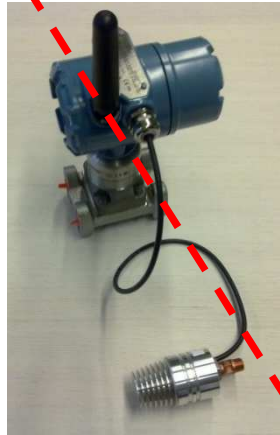

Use heat from 15 mm pipe

Output power 3.5mw  
at 60°C and ambient 25°C

- Applications :**
- Wireless sensors
  - Data loggers
  - Direct valve control
  - Wireless pneumatic control

<http://www.micropelt.com>



WPG-1 mounted vertically on side of oven

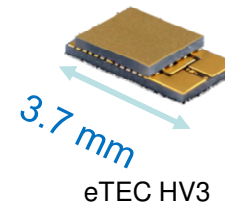
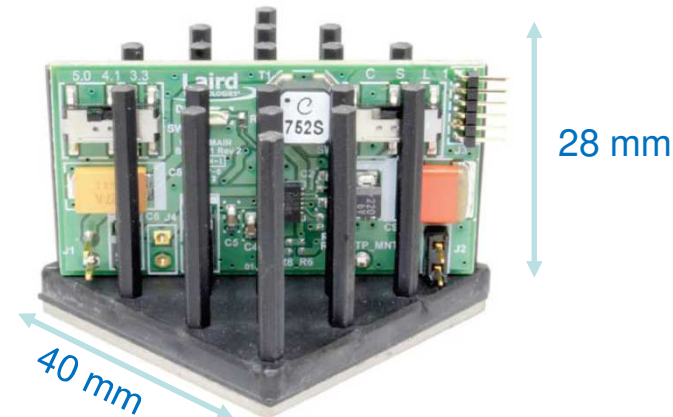

eTEC HV3

Laird technology

# Energy Harvesting for Low Power Electronics

## Fliptem 36

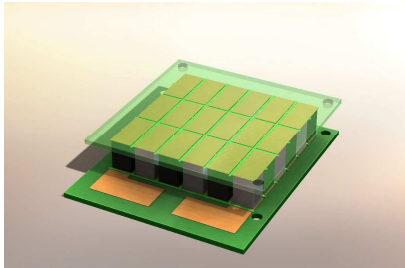

Zn<sub>4</sub>Sb<sub>3</sub> & Mg<sub>2</sub>SiSn  
[www.tegnology.dk](http://www.tegnology.dk)

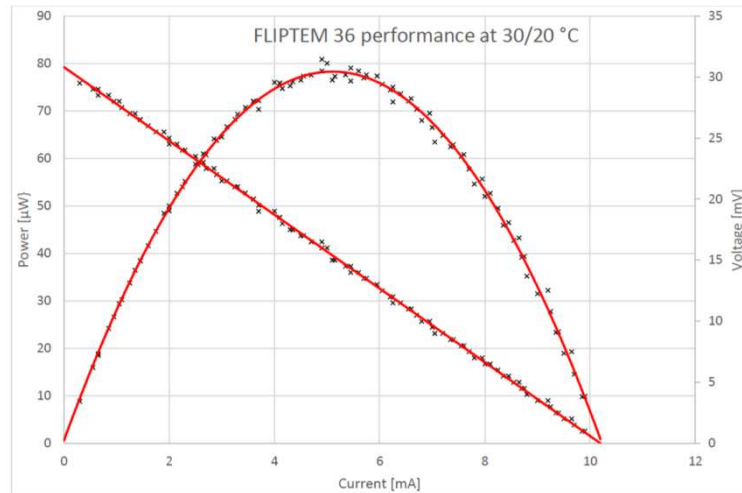

Electrical temperature monitoring  
 Small in size - ø30mm x 50mm  
 Hygienic and waterproof  
 Environmentally friendly  
 No hazardous materials  
 Sustainable - no batteries  
 Long lifetime - { 20 years }

## Sensever

Self powered hot pipe alert.

easily installed on any pipe which could cause injury due to its extreme heat. A light and/or optional wireless signal is emitted when the pipe temperature exceeds the programmable preset threshold, alerting that the pipe is hot.

Starting from 2013 TEC Microsystems GmbH

N-Type composition: BiTeSeS

P-Type composition: BiSbTe

[www.tec-microsystems.com](http://www.tec-microsystems.com)

Miniature  
 Thermoelectric  
 Generators

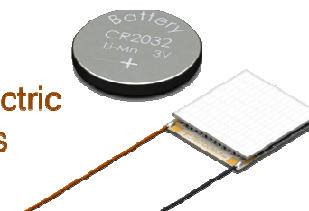

# Printed metallic thermoelectric generators for powering wireless sensors

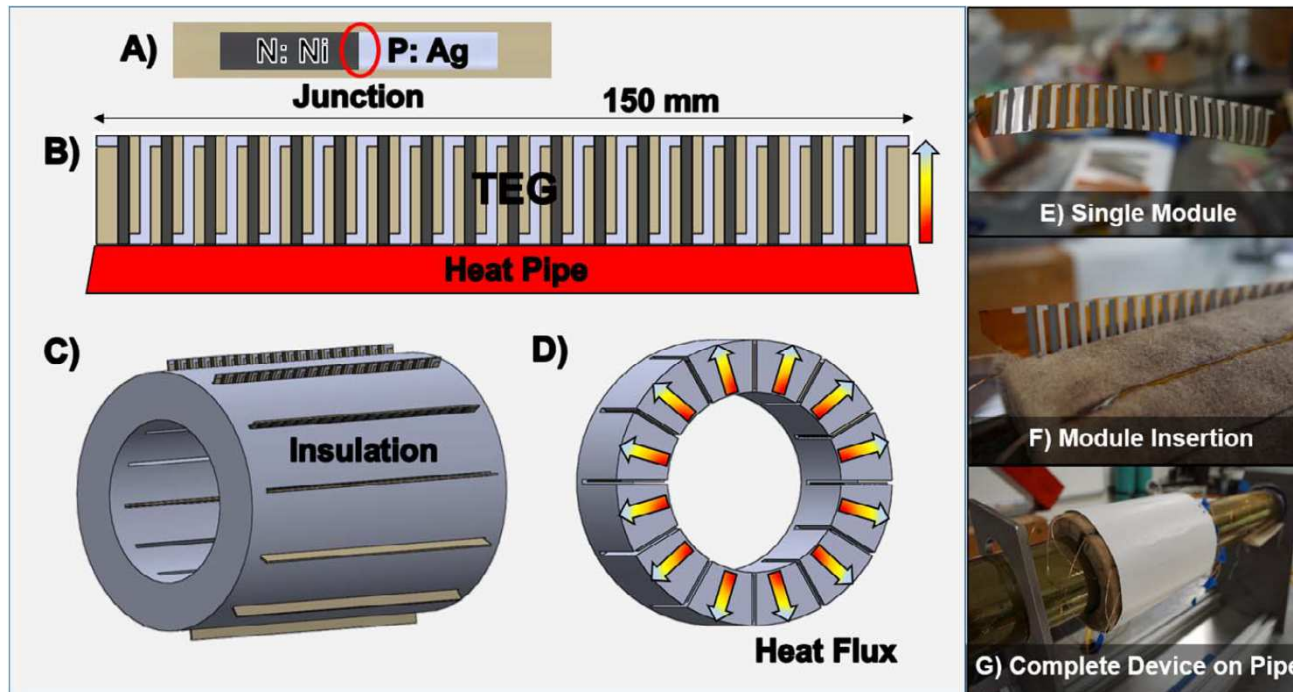

flexible TEGs  
fabricated from low  
cost, screen printed  
(Siebdruck) silver and  
nickel inks

- A) One junction composed of n-type nickel (Ni) and p-type silver (Ag) inks,  
 (B) Printed thermoelectric module consisting of 35 Ag/Ni couples
- Ag element 2 mm width
  - Ni element 3.5 mm width,
- (C) Insertion of 12 modules into steam pipe insulation to create 420 junction device,  
 (D) Cross section view of radial heat transfer through insulation,  
 (E–G) Images of a flexible 35 junction module inserted into the insulation with a cover in place.

2017 Iezzi Printed metallic thermoelectric generators integrated with pipe insulation for powering wireless sensors Applied Energy



## sub-watt thermoelectric generators (TEGs)

### Conclusion

- Micropelt stopped production of TEM
- Laird : no mass production, 11 pieces available on digikey
- New actors :
  - TECHNOLOGY
  - TEC Microsystems
  - .....

### Annual market for sub-watt thermoelectric generators (TEGs)

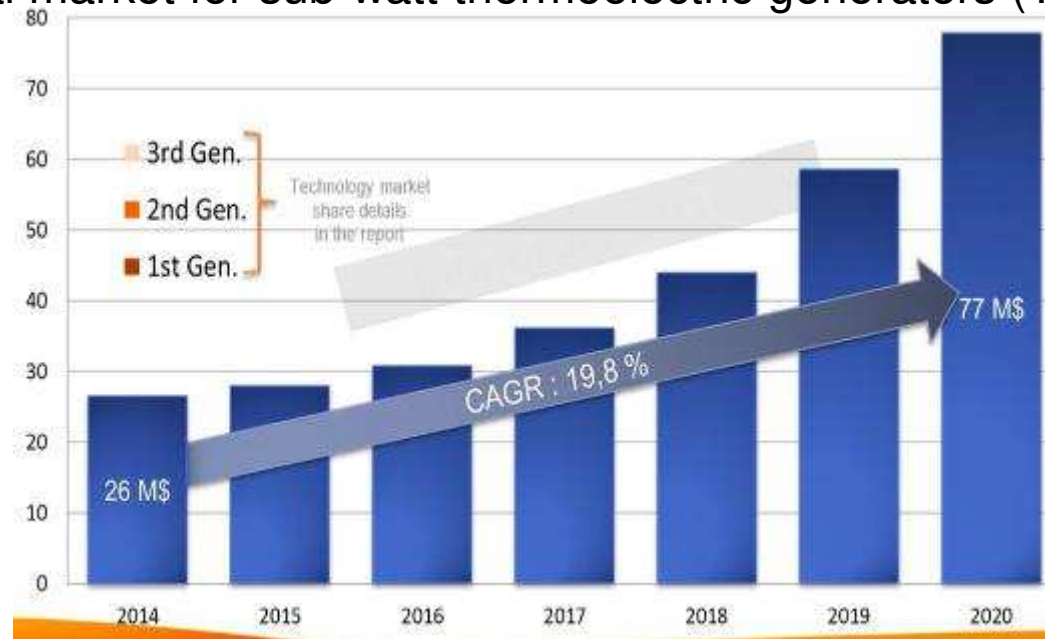

market research firm Infinergia LLC (Grenoble, France).

# Solar Thermal to Thermoelectricity

Heat flux through a thermoelectric leg

$$\frac{q}{A} \approx \lambda \frac{\Delta T}{L} \approx 1 \cdot \frac{100}{0.001} = 10^5 \text{ W/m}^2$$

$\lambda \approx 1 \text{ W.m}^{-1}\text{K}^{-1}$  (highlighted in blue)  
 $\Delta T \approx 100\text{K}$  (highlighted in green)  
 $L \approx 0.001\text{m}$  (highlighted in yellow)

Solar insulation:  $\sim 1\,000 \text{ W/m}^2$

Need to concentrate heat by  $\sim 100$  times

## Optical vs. Thermal Concentration

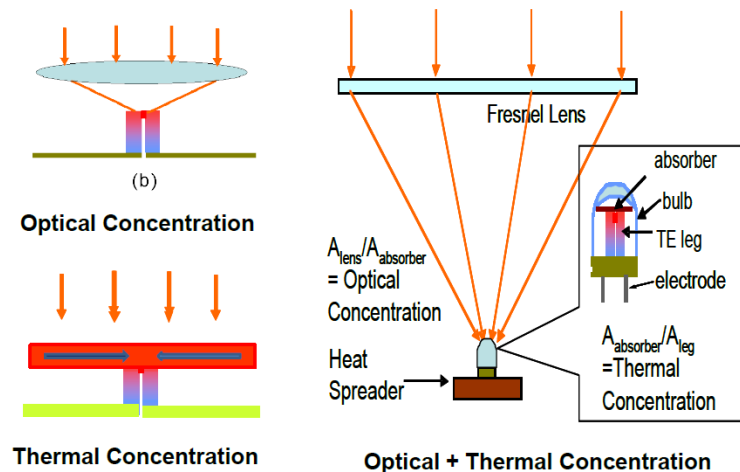

# Solar Thermoelectrics STEG

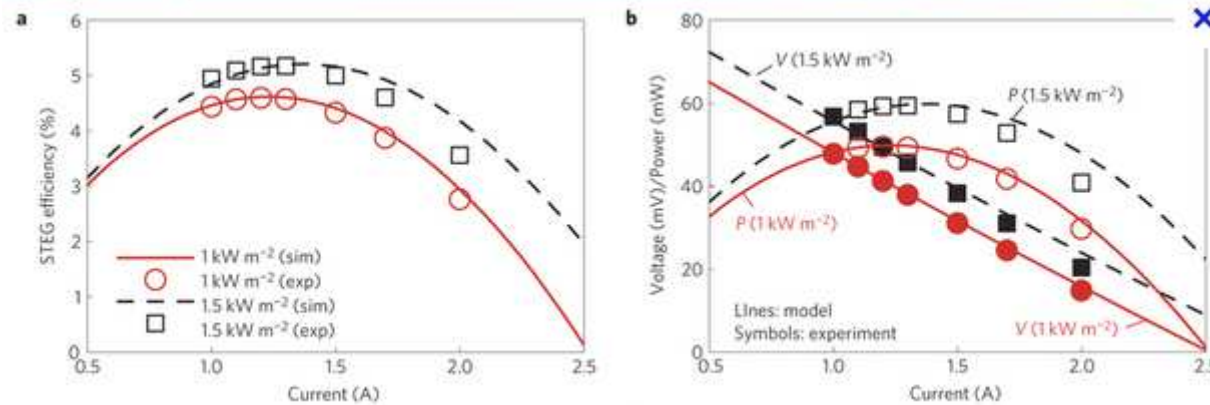
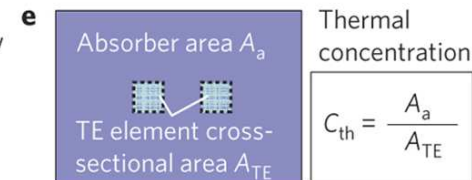
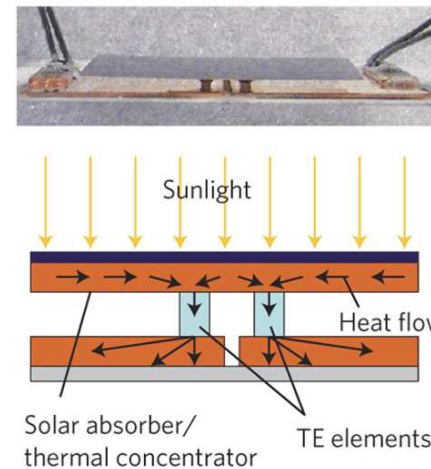
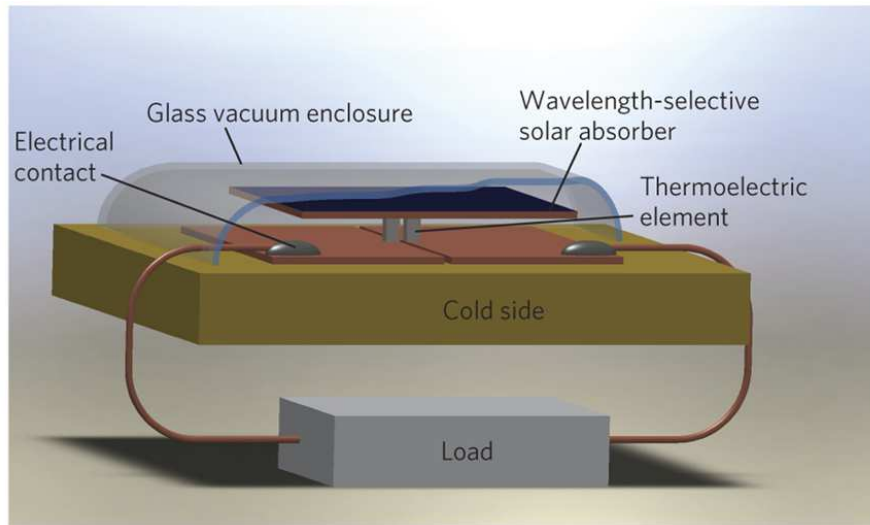

The developed solar thermoelectric generators (STEGs) achieved a peak efficiency of 4.6% under AM1.5G (1 kW m<sup>-2</sup>) conditions.

Kraemer High-performance flat-panel solar thermoelectric generators with high thermal concentration Nat mat 2011

# Conclusions

## Today

niche markets with high added value

- space and extreme environments where liability is critical
- Self powered sensors (IoT)
- CHP stoves

## Soon

Industrials markets

- Transports (automotive ? and ships)
- Combined heat and power system
- Developing countries
- steel industries
- Self powered sensors (IoT)

## Future

- Transports (planes)
- Solar ?
- Humans uses (organics TEG)

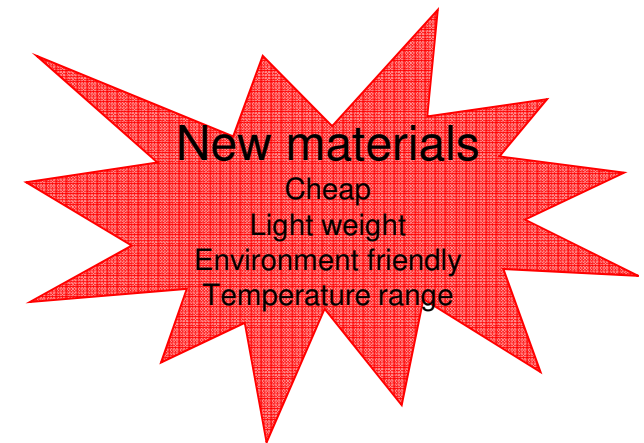

research outlook

- Materials
- Design
- Optimization
- New applications

# thermoelectric cooling and heating

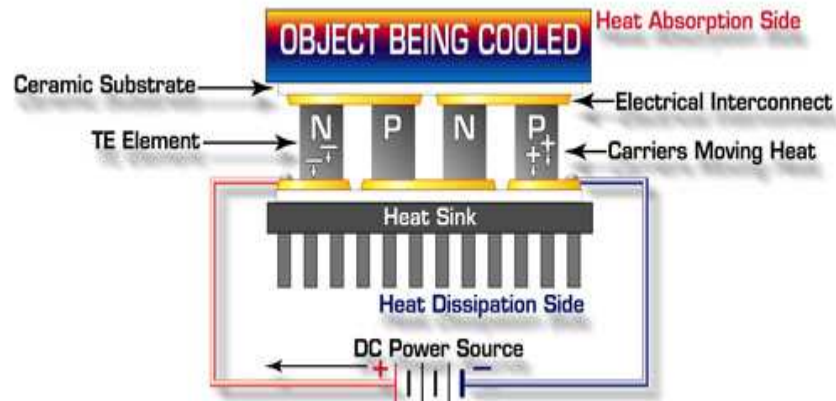

By applying a low voltage DC power to a TE module, heat will be moved through the module from one side to the other.

a change in the polarity of the applied DC voltage will cause heat to be moved in the opposite direction.

Consequently, a thermoelectric module may be used for both heating and cooling thereby making it highly suitable for precise **temperature control applications**

Coefficient of performance 
$$COP_{\max} = \frac{Q_c}{W_e} = \frac{T_c}{\Delta T} \frac{\sqrt{1+zT} - \frac{T_c}{T_h}}{\sqrt{1+zT} + 1}$$

Maximum temperature difference 
$$T_h - T_c = \frac{1}{2} Z T_c^2 \approx \frac{T_c}{2} Z T$$
 Tc in Kelvin

# Thermoelectric optoelectronics applications

## How does It work - Single- and Multistage TE Coolers

Maximum Temperature Difference between Cold and Hot Sides ( $dT_{max}$ ) at +27°C Ambient

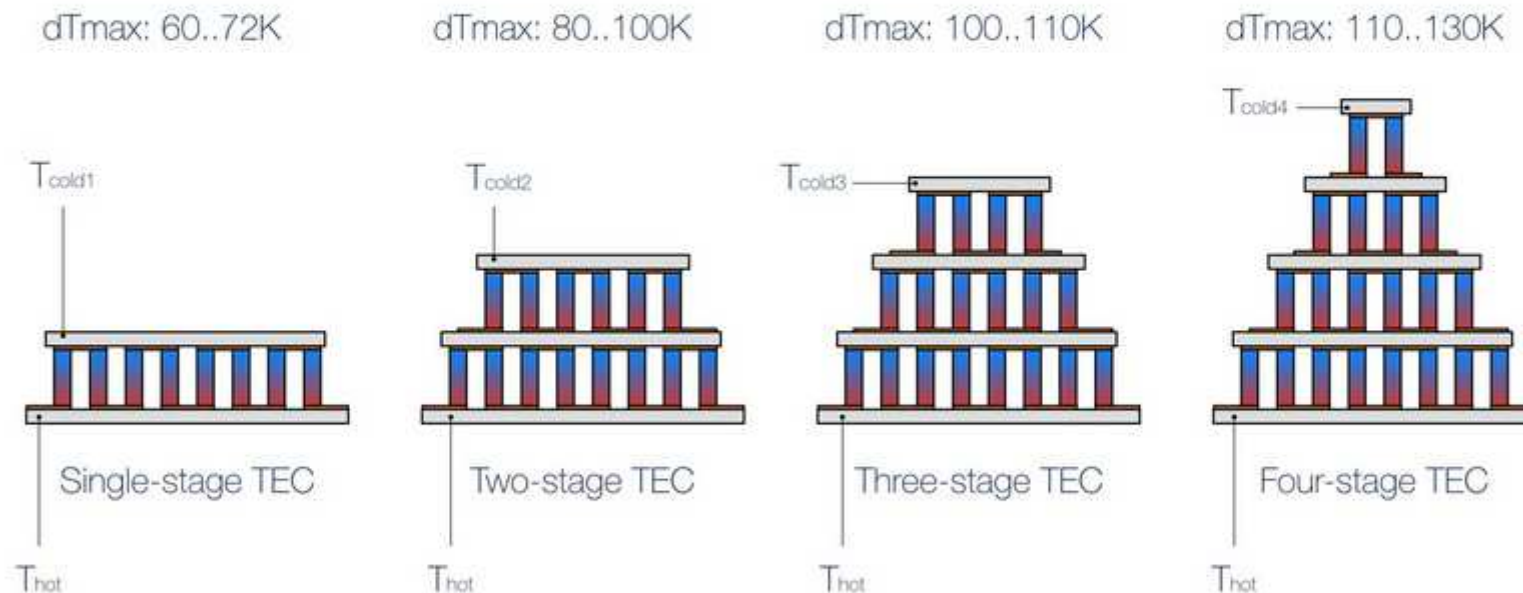

Multistage TEC construction increases max possible  $dT$  in application, but the opposite effect may be in less amount of heat to pump from TEC cold side.

Copyright TEC Microsystems GmbH. Images contain hidden watermark.

<http://www.tec-microsystems.com>

# thermoelectric cooling and heating

## advantages

Thermoelectric modules offer many advantages including:

- No moving parts
- Small and lightweight
- Maintenance-free
- Acoustically silent and electrically “quiet”
- Heating and cooling with the same module (including temperature cycling)
- Wide operating temperature range
- Highly precise temperature control (to within  $0.1^{\circ}\text{C}$ )
- Operation in any orientation, zero gravity and high G- levels
- Cooling to very low temperatures ( $-80^{\circ}\text{C}$ )

## drawbacks

- fall of COP when the temperature difference increases
- high dependence to room temperature

Cool only where you need  $\neq$  conventional systems

two mainstream directions :

- electronics and photonics, particularly optoelectronics and laser techniques
- low power cooling ( $<500\text{W}$ )

# Thermoelectric optoelectronics applications

commercially during recent decades

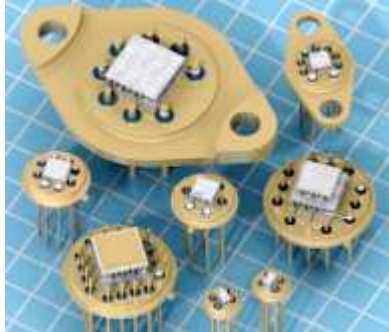

## Miniature Thermoelectric Coolers for Telecom Applications

Laser Diodes and Superluminescent Diodes  
X-Ray and IR- Sensors  
Photodetectors and Photomultipliers  
Avalanche Photodiodes (APD)  
Focal Plane Arrays (FPA)  
Charge Couple Devices (CCD)

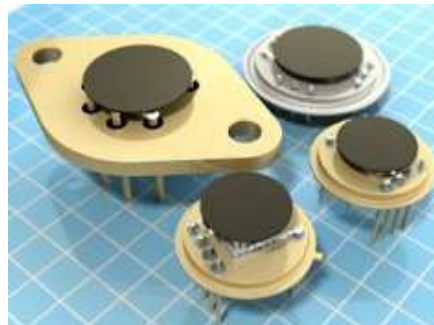

## Infrared Cameras

TEC sub-assemblies provide a temperature-controllable, uniform-temperature, high-emissivity surface used in calibrating infrared (IR) detector arrays and FLIR systems. (Infrared Cameras & Thermal Imagers )

<http://www.tec-microsystems.com>



# thermoelectric cooler/heater



## **koolatron**

Koolatron 12 Volt  
Coolers and Warmers  
heat or cool your lunch and beverages.

“LG Electronics Objet” refrigerator



capacity :40 liters

refrigerating temperature by minimum to 3°C

Seoul, South Korea, Nov. 19th, 2018



## DMD PROJECTOR COOLING MODULE

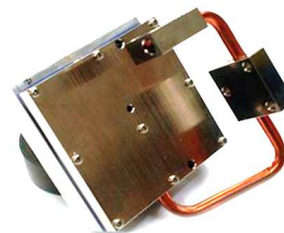

5000ANSI BX501B TE Cooling Module (LG)

- World first TE cooling module for LG high lumen DMD Projector
- High cooling effectiveness: COP>0.4
- Very low current operation
- Multi heat sources solution
- Supplying since 2008



## **TED Cup-Holders**

Cooling: 0~5C / Heating: 55~65C

Production since May 2014

Hyundai/Kia Motor Company

[www.tesbiinc.com](http://www.tesbiinc.com)



## **watercooler**

# Vehicles cooling and heating

Today's automotive climate control system exerts a large auxiliary load on the vehicle's powertrain

**Cool locally driver and passenger  
and not the whole car**

**Ford group :**  
**Thermoelectric HVAC (Heating, Ventilation and Air-Conditioning)**

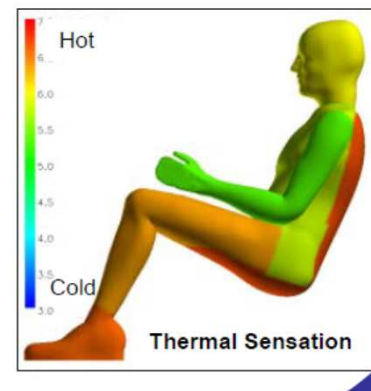

Seat Cooling and Heating Module TED for Hyundai Motor Company

- Eco-friendly, no refrigerating fluid is needed
- Cooling or heating by changing current direction
- Adopting Bimetal to prevent over-heating
- Operating Current: 6A
- Operating Voltage: 13.5V
- Max. Temperature Difference: 65.4 deg C
- Max. Refrigerating Power: 65.1W
- Size: 55 x 43 x 20 mm<sup>3</sup>
- Weight: 12g



**Sony's New Wearable 'Air Conditioner'**  
Will Keep You From Sweating  
Through Your Clothes

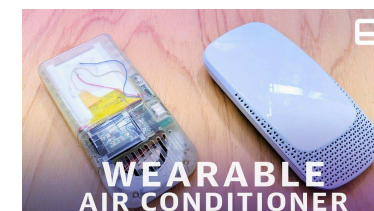
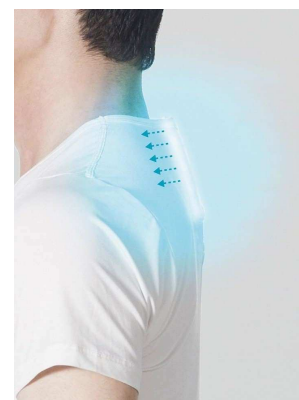

# Future : refrigeration systems

Vapour compression refrigeration systems have been subject to severe technological modifications due to strict regulations about the working fluids employed

- Safety aspects (toxicity and flammability),
- Environmental issues such as Ozone Depletion and Global Warming.

refrigerant	issue	ODP (Ozone depletion potential)	GPW Global Warming Potential	banned in year
<b>CFC ChloroFluoroCarbures</b>	<b>impact on the Ozone Layer</b>			2000
R12		1	10900	
<b>HCFC HydroChloroFluoroCarbures</b>	<b>impact on the Ozone Layer</b>			2015
R22		0,055	1810	
<b>HFC HydroFluoroCarbures</b>	<b>Impact Global Warming</b>		GPW>2500	January 2020
HFC	Impact Global Warming		GPW>150	January 2022
R404A		0	3900	January 2020
R507A		0	4000	January 2020
R134a : 1,1,1,2-tétrafluoroéthane ;		0	1430	January 2022
<b>other refrigerants</b>				
R744 CO2 (commercial use)	high pressure and low critical temperature, refrigeration systems require special equipment designs.	0	1	high safety level
R717 NH3 (industrial use)	most efficient refrigerant	0	0	Toxicity
R600 Isobutane (commercial use)	domestic and small commercial refrigerators.	0	3	Highly flammable

Refrigerants Environmental Data.Ozone Depletion and Global Warming Potential.

Ref LINDE Group [http://www.linde-gas.com/en/products\\_and\\_supply/refrigerants/](http://www.linde-gas.com/en/products_and_supply/refrigerants/)

Major difference between R744 (CO<sub>2</sub>) and other refrigerants :  
pressure/temperature characteristic.  
high pressure and low critical temperature : refrigeration systems require  
special equipment designs.

**Subcooling system is necessary to improve the COP for ambient temperature > 15°**

Research of different systems that could increase the COP of the CO<sub>2</sub> plants

**Thermoelectric refrigeration subcooling system (TESC) :** Improvement up to 33 % in the cooling capacity and up to 24 % in the COP.

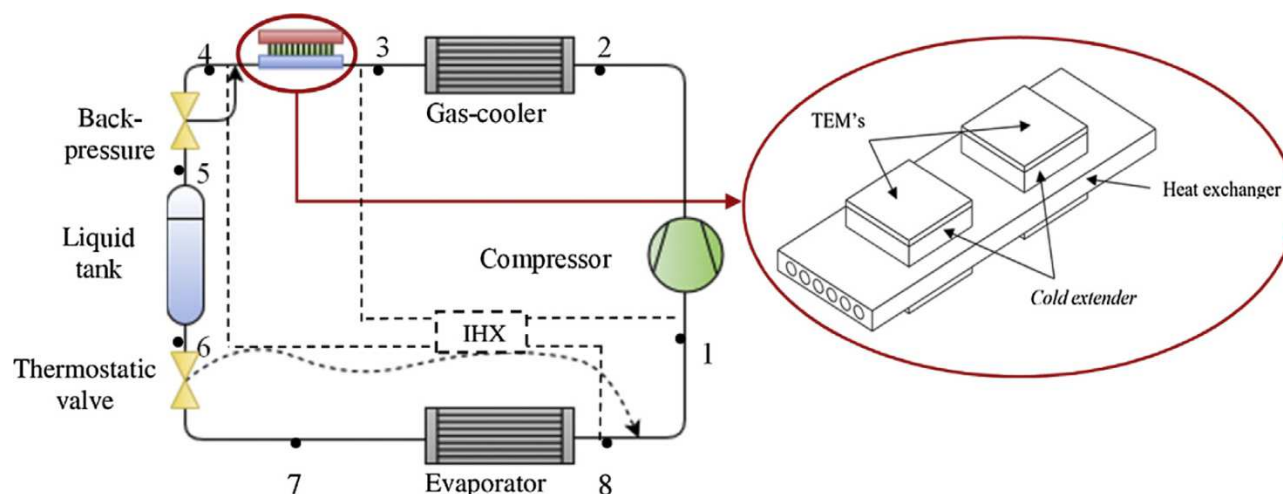

D. Astrain et al, Improvements in the cooling capacity and the COP of a transcritical CO<sub>2</sub> refrigeration plant operating with a thermoelectric subcooling system, Applied Thermal Engineering, Vol 155, 2019,

# Temperature measurements

The temperature is a particular quantity

We can define equality but we can not define the sum of two temperatures

$$10\text{kg} + 5\text{kg} = 15\text{kg}$$

$$10^\circ + 20^\circ = ?$$

ITS (International Temperature Scale) T90

Substance and its state	Defining point T90 K	T90 °C
Triple point of hydrogen	13.8033	-259.3467
Triple point of neon	24.5561	-248.5939
Triple point of oxygen	54.3584	-218.7916
Triple point of argon	83.8058	-189.3442
Triple point of mercury	234.3156	-38.8344
Triple point of water	273.16	0.01
Melting point of gallium	302.9146	29.7646
Freezing point of indium	429.7485	156.5985
Freezing point of tin	505.078	231.928
Freezing point of zinc	692.677	419.527
Freezing point of aluminum	933.473	660.323
Freezing point of silver	1234.93	961.78
Freezing point of gold	1337.33	1064.18
Freezing point of copper	1357.77	1084.62

**17 reference points of temperature**

# 2019 New SI

November 2018 revised definitions of the kilogram, ampere, kelvin and mole approved by the General Conference on Weights and Measures (CGPM)

The revised definitions came into force on 20 May 2019

*One kelvin is equal to the change of thermodynamic temperature that results in a change of thermal energy  $kT$  by  $1.380649 \times 10^{-23}$  J.*

Constante de Boltzmann

**Can I get my thermometer calibrated in the same way as I did before 20 May 2019?**

Yes. The new definition of the kelvin has not impacted the status of the widely-used ITS-90 and PLTS-2000 temperature scales. The Consultative Committee for Thermometry (CCT) has published information concerning immediate and future advantages of the new definition.

[www.bipm.org/en/measurement-units/faqs.html](http://www.bipm.org/en/measurement-units/faqs.html)

# Thermocouples

Thermocouple : a sensor for measuring temperature

It consists of two dissimilar **metals**, joined together.  
When the junction of the two metals is heated or cooled a voltage is produced that can be correlated back to the temperature.

$V_{AB}$  is function of:

- Nature of the two metals
- Temperatures  $T_1$  and  $T_2$

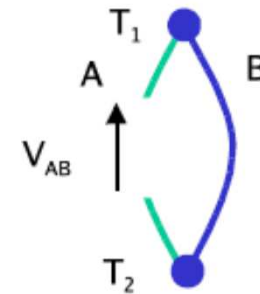

$T_1$  sensor junction

$T_2$  reference junction

Table for  $T_2 = 0$  and couple A,B  $E_{AB}(T_1)$

# Thermocouples Type K

°C	0	-1	-2	-3	-4	-5	-6	-7	-8	-9	-10
-20	-0.778	-0.816	-0.854	-0.892	-0.930	-0.968	-1.006	-1.043	-1.081	-1.119	-1.158
-10	-0.392	-0.431	-0.470	-0.508	-0.547	-0.586	-0.624	-0.663	-0.701	-0.739	-0.778
0	0.000	-0.039	-0.079	-0.118	-0.157	-0.197	-0.236	-0.275	-0.314	-0.353	-0.392
0	0.000	0.039	0.079	0.119	0.158	0.198	0.238	0.277	0.317	0.357	0.397
10	0.397	0.437	0.477	0.517	0.557	0.597	0.637	0.677	0.718	0.758	0.798
20	0.798	0.838	0.879	0.919	0.960	1.000	1.041	1.081	1.122	1.163	1.203
30	1.203	1.244	1.285	1.326	1.366	1.407	1.448	1.489	1.530	1.571	1.612
40	1.612	1.653	1.694	1.735	1.776	1.817	1.858	1.899	1.941	1.982	2.023
50	2.023	2.064	2.106	2.147	2.188	2.230	2.271	2.312	2.354	2.395	2.436
60	2.436	2.478	2.519	2.561	2.602	2.644	2.685	2.727	2.768	2.810	2.851
70	2.851	2.893	2.934	2.976	3.017	3.059	3.100	3.142	3.184	3.225	3.267
80	3.267	3.308	3.350	3.391	3.433	3.474	3.516	3.557	3.599	3.640	3.682
90	3.682	3.723	3.765	3.806	3.848	3.889	3.931	3.972	4.013	4.055	4.096
100	4.096	4.138	4.179	4.220	4.262	4.303	4.344	4.385	4.427	4.468	4.509
110	4.509	4.550	4.591	4.633	4.674	4.715	4.756	4.797	4.838	4.879	4.920

Temperature below 0 °C		
$E = \sum_{i=0}^n c_i t_{90}^i$ t <sub>90</sub> = Temperature (°C)    E = Voltage (mV)		
Temperature above 0 °C		
$E = \sum_{i=0}^n c_i t_{90}^i + a_0 e^{a_1 (t_{90} - a_2)^2}$		
Température (°C)	-270 à 0	0 à 1372
c <sub>0</sub>	0	-0.176004136860e-1
c <sub>1</sub>	0.394501280250e-1	0.389212049750e-1
c <sub>2</sub>	0.236223735880e-4	0.185587700320e-4
c <sub>3</sub>	-0.328569067640e-6	-0.994575928740e-7
c <sub>4</sub>	-0.499048287770e-8	0.318409457190e-9
c <sub>5</sub>	-0.675090591730e-10	-0.560728446890e-12
c <sub>6</sub>	-0.574103274280e-12	0.560750590590e-15
c <sub>7</sub>	-0.310868728940e-14	-0.320207200030e-18
c <sub>8</sub>	-0.104516093650e-16	0.971511471520e-22
c <sub>9</sub>	-0.198892668780e-19	-0.121047212750e-25
c <sub>10</sub>	-0.183228974880e-22	
a <sub>0</sub>		0.1185976
a <sub>1</sub>		-0.1183432e-3
a <sub>2</sub>		0.1269686e+3

$T_{90} = c_0 + c_1 E + c_2 E^2 + c_3 E^3 + c_4 E^4 + \dots + c_n E^n$			
Température (°C)	-200 à 0	0 à 500	500 à 1372
Tension (mV)	-5.891 à 0.000	0.000 à 20.644	20.644 à 54.886
c <sub>0</sub>	0	0	-1.318058E+02
c <sub>1</sub>	2.5173462E+01	2.508355E+01	4.830222E+01
c <sub>2</sub>	-1.1662878E+00	7.860106E-02	-1.646031E+00
c <sub>3</sub>	-1.0833638E+00	-2.503131E-01	5.464731E-02
c <sub>4</sub>	-8.9773540E-01	8.315270E-02	-9.650715E-04
c <sub>5</sub>	-3.7342377E-01	-1.228034E-02	8.802193E-06
c <sub>6</sub>	-8.6632643E-02	9.804036E-04	-3.110810E-08
c <sub>7</sub>	-1.0450598E-02	-4.413030E-05	0
c <sub>8</sub>	-5.1920577E-04	1.057734E-06	0
c <sub>9</sub>	0	-1.052755E-08	0
Erreur (°C)	-0.02 à 0.04	-0.05 à 0.04	-0.05 à 0.06

<http://srdata.nist.gov/its90/main/>



# Thermocouples

Letter-designation for Thermocouples.	Alloy	Domaine de la table en °C
K	Nickel-chromium alloy(+)/Nickel-aluminium alloy(-)	-270 to 1370 °C
T	Copper(+)/Copper-nickel alloy(-)	-270 to 400 °C
J	Iron(+)/Copper-nickel alloy(-)	-210 to 1200 °C
N	Nickel-chromium-silicon alloy(+)/Nickel-silicon alloy(-)	-270 to 1300 °C
E	Nickel-chromium alloy(+)/Copper-nickel alloy(-)	-270 to 1000 °C
R	Platinum13%Rhodium(+)/Platinum(-)	-50 to 1760 °C
S	Platinum10%Rhodium(+)/Platinum(-)	-50 to 1760 °C
B	Platinum30%Rhodium(+)/Platinum6%Rhodium(-)	0 to 1820 °C
G (Not Official Symbol or Standard)	Tungsten / Tungsten 26% Rhenium	1000 to 2300 °C
C (Not Official Symbol or Standard)	Tungsten 5% Rhenium / Tungsten 26% Rhenium	0 to 2300 °C
D (Not Official Symbol or Standard)	Tungsten 3% Rhenium / Tungsten 25% Rhenium	0 to 2400 °C

Standard IEC 584.1 (1995)

IEC - International Electrotechnical Commission

- IEC 60584-1 Thermocouple reference tables -  $E = f(T)$  e.m.f.-temperature relationships
- IEC 60584-2 Tolerances
  - This standard contains the manufacturing tolerances for both noble and base metal thermocouples manufactured in accordance with e.m.f.-temperature relationships of Part 1 of the standard.
- IEC 60584-3  
Thermocouples - : Extension and compensating cables - Tolerances and identification system

# Thermocouples

## Cold junction compensation

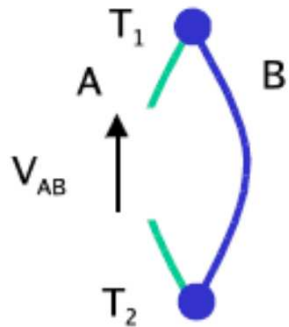

Thermocouples measure the temperature difference between two points, not absolute temperature

$$E(T_1) = V_{AB} + E(T_2)$$

## industrial thermocouples

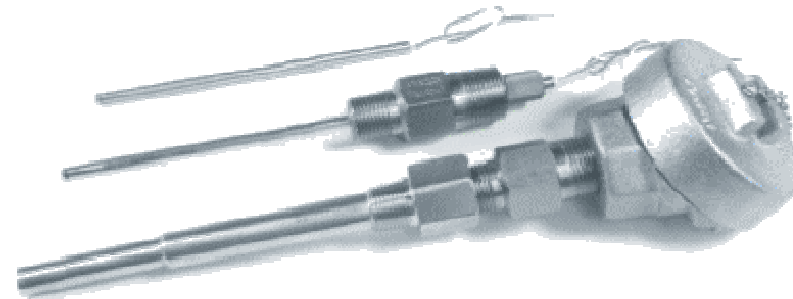
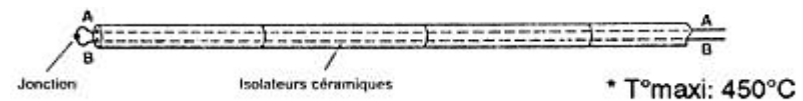
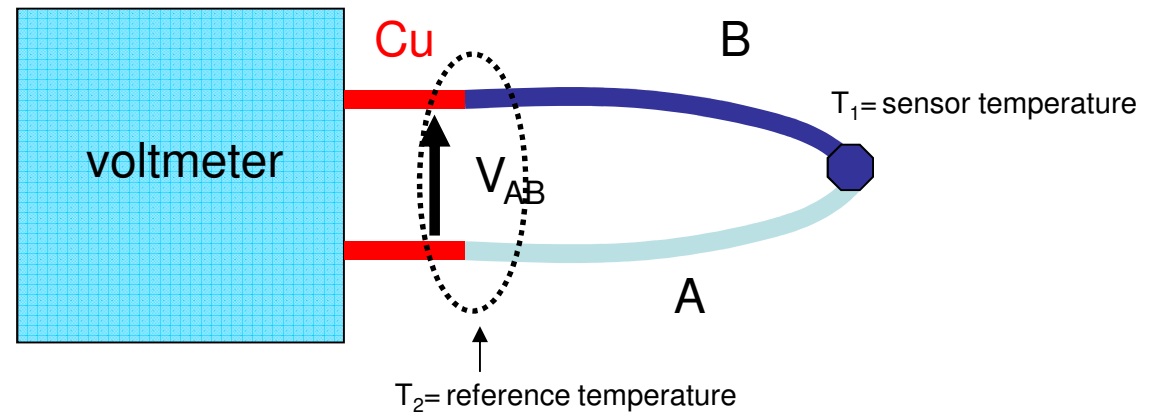

# Thermocouples : Extension Wire

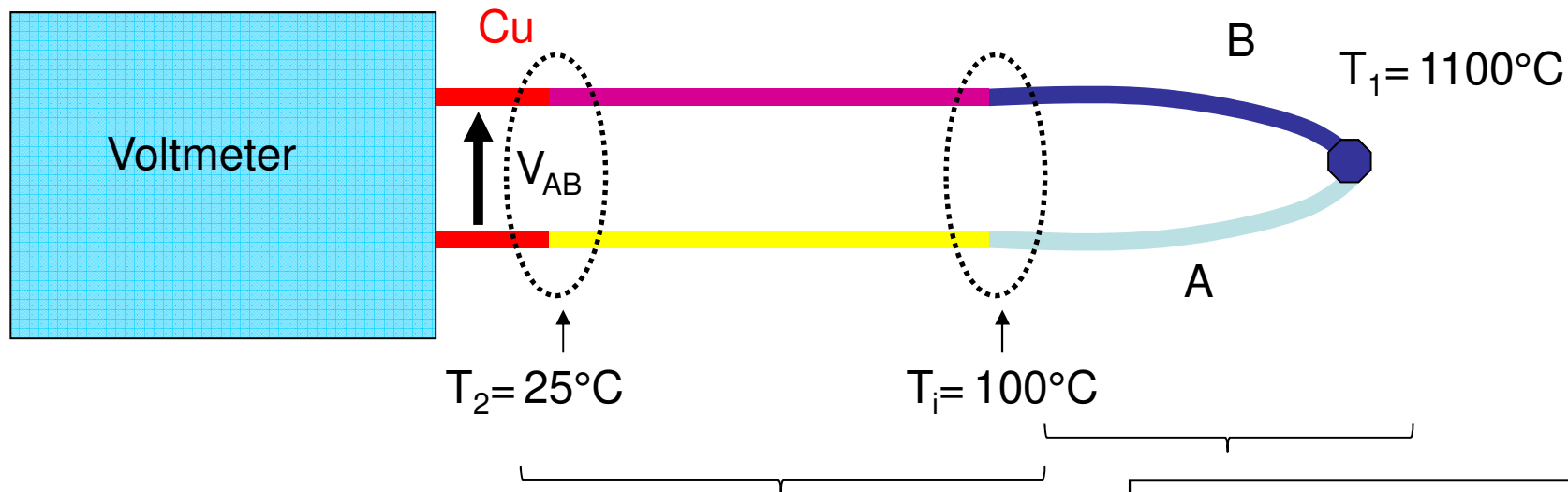

Extension grade wire is only used to extend a thermocouple signal from a probe back to the instrument reading the signal. The extension grade wire (or sheath) typically will have a lower ambient temperature limit in which the wire may be used

Cheap  
Thermoelectricity

Thermocouple grade wire is wire that is used to make the sensing point (or probe part) of the thermocouple.

Expensive

# Thermocouples : Properties

## sensitivity

Thermocouple Type	Seebeck Coefficient at 25°C ( $\mu\text{V}/^\circ\text{C}$ )	Sensitivity for 0.1°C ( $\mu\text{V}$ )
E	61	6.1
J	52	5.2
K	40	4.0
R	6	0.6
S	6	0.6
T	41	4.1

Measurement system with high resolution and quality  
Sensors are very sensitive to electric noises

### Advantages

- Large measuring range
- robust
- Many forms
- Response time
- Cost

### Disadvantages

- Decalibration (oxidation ...)
- Sensitivity to electrical noise