



**HAL**  
open science

## Classification of 3R Positioning Manipulators

Philippe Wenger

► **To cite this version:**

Philippe Wenger. Classification of 3R Positioning Manipulators. Journal of Mechanical Design, 1998, 120 (2), pp.327-332. 10.1115/1.2826976 . hal-02362907

**HAL Id: hal-02362907**

**<https://hal.science/hal-02362907v1>**

Submitted on 14 Nov 2019

**HAL** is a multi-disciplinary open access archive for the deposit and dissemination of scientific research documents, whether they are published or not. The documents may come from teaching and research institutions in France or abroad, or from public or private research centers.

L'archive ouverte pluridisciplinaire **HAL**, est destinée au dépôt et à la diffusion de documents scientifiques de niveau recherche, publiés ou non, émanant des établissements d'enseignement et de recherche français ou étrangers, des laboratoires publics ou privés.

# Classification of 3R Positioning Manipulators

P. Wenger Institut de recherche en Cybernétique de Nantes U.M.R. CNRS 6597 1 rue la Noë, BP 92101 44321 Nantes, France

*In this paper, the complete categorization of all generic 3-revolute jointed (3R) positioning manipulators is established using a homotopy based classification scheme. It is shown that there exists exactly eight subsets of homotopic generic manipulators which have similar global kinematic properties. The classification of generic manipulators serves as an efficient tool for the categorization of cuspidal and non cuspidal manipulators, i.e., manipulators which can or cannot change posture without meeting a singularity, respectively. As a result of this classification, it appears that, in contrast with common belief, most 3R manipulators are cuspidal.*

## 1 Introduction

Manipulator global kinematic properties are intimately related to the geometry and topology of singularities. Most of the considerable literature dealing with manipulator singularities are concerned with manipulator control and trajectory planning (Borrel and Liegeois, 1986; Tsai, 1990; Chevallereau, 1996). On the other hand, few authors have addressed manipulator singularities for global analysis purposes. Manipulator workspace has been frequently used as a tool for manipulator analysis and design (Kumar and Waldron, 1981; Gupta and Roth, 1982; Yang and Lee, 1983; Kholi and Hsu, 1987; Rastegar and Deravi, 1987; Paden and Sastry, 1988; Wenger and Chedmail, 1991; Ceccarelli, 1995). However, the workspace approach may not be sufficient for characterizing important kinematic features like the genericity. The geometry and topology of the critical point manifolds in the joint space turn out to be an interesting complementary way of globally analysing and categorizing the kinematic properties of manipulators. In 1988, Burdick presented a detailed analysis of 3R manipulator singularities (Burdick, 1988). One year later, Pai introduced the notion of generic manipulators (Pai, 1989). A manipulator is said generic if its singularities are generic, that is, if they form smooth manifolds in the joint space. The set of nongeneric manipulators forms hyper surfaces in the space of all manipulators. Consequently, a manipulator is almost generic, in the sense that if the geometric parameters of a manipulator are given at random, the probability to obtain a nongeneric manipulator is null. At the end of his work, Burdick, (1995) proposed a preliminary classification scheme for 3R positioning manipulators, using the number and homotopy class of their critical point manifolds. However, he did not attempt a complete enumeration of all possible generic manipulator classes.

The primary goal of this paper is to enumerate all possible classes of homotopic generic positioning 3R (nonredundant) manipulators. Positioning manipulators are referred to as serial manipulators whose primary task is to reach points in the 3-D Cartesian space. The main application of this study is the complete categorization of the 3R generic cuspidal and noncuspidal manipulators.

The remainder of this paper is organized as follows:

-section 2 recalls the notions of singularity, genericity, cuspidal-ity and homotopy class,

-section 3 sets new results about the geometry and topology of the critical point manifolds. It is proved that there are only eight classes of homotopic generic manipulators, with only one class of noncuspidal manipulators,

-section 4 illustrates the different manipulator classes, -section 5 is devoted to some important comments,

The last section concludes this paper.

## 2 Preliminaries

2.1 The Singularities of Positioning 3R Manipulators. Only positioning singularities will be studied here, and from now on, the word singularity will stand for positioning singularity. In a positioning singularity, the end-effector cannot be instantaneously translated along an axis.

The singularities of a positioning manipulator can be characterized by the set of joint configurations  $q$  which nullify the determinant of the Jacobian matrix. In the joint space, they form two-dimensional closed manifolds, referred to as *critical point manifolds* (Burdick, 1988, Tsai, 1990). They divide the joint space into at least two singularity-free domains called *aspects* (Borrel and Liegeois, 1986; Wenger and Chedmail, 1991; Ranjbaran and Angeles, 1994) or *c-sheets* (Burdick, 1988; Smith, 1990; Tsai, 1990). The global kinematic properties of a manipulator are intimately related to the geometry and topology of the critical point manifolds. Under the forward kinematic map, the critical point manifolds are rearranged into manifolds (*the critical value manifolds*) which divide the workspace into regions with different number of inverse kinematic solutions or *postures* (Rastegar and Deravi, 1987; Tsai, 1990). The joint space of a 3R manipulator has the structure of a 3-dimensional torus, but since the singularities are independent of the first joint axis, the critical point manifolds can be analyzed in the  $(\theta_2-\theta_3)$ -torus, where they form closed curves. For more convenience, however, the critical point manifolds are traced in a square of dimension  $2\pi$ , by cutting the torus along its generators. In order to keep the topology of torus, the opposite sides of square should be always identified.

2.2 Generic Manipulators. A manipulator is said to be *generic* when its singularities form a collection of smooth nonintersecting manifolds in the joint space (Pai, 1989). An algebraic condition for a 3-DOF positioning manipulator to be generic was also provided in Pai, (1989) but will not be reported here since it will not be used in the following.

It appears that nongenericity often arises from geometric simplification conditions in the manipulator structure (like two intersecting or parallel joint axes), and that most industrial manipulators are, in turn, nongeneric (Smith, 1990; Burdick, 1995). On the other hand, many nongeneric manipulators have no simple DH<sup>1</sup>-parameters.

<sup>1</sup> DH stands for Denavit-Hartenberg. Standard original notation will be used throughout this paper.

An important feature of generic manipulators is that their global kinematic properties remain stable under small changes in their kinematic parameters. This is not the case for nongeneric manipulators. This means that particular attention must be paid when manufacturing a nongeneric manipulator, since too large manufacturing tolerances may profoundly modify the expected kinematic properties of the manipulator.

**2.3 Cuspidal Manipulators.** A cuspidal manipulator is one which can change posture without meeting a singularity. The existence of manipulators having this property was first pointed out in 1988 by Parenti and Innocenti (1988), and, simultaneously by Burdick (1988). A theory and a methodology were developed in Wenger (1992) for the characterization of new uniqueness domains in the joint space of cuspidal manipulators. In Wenger (1996), the nonsingular posture changing feature was deeply analyzed using typical examples. It was shown, in particular, that if a manipulator can change posture without passing through a singularity, it cannot do so in all parts of its workspace, but only in a region with four inverse kinematic solutions. A major difficulty has been the characterization of cuspidal manipulators. It has been conjectured by different authors that: (1) manipulators with geometric simplifying conditions like intersecting, orthogonal or parallel joint axes are not able to avoid a singularity when changing posture, and, conversely, (2) manipulators with arbitrary kinematic parameters have the nonsingular posture changing property. These conjectures were based on the observation of several examples which seem to follow this rule. Unfortunately, the examination of counter-examples have clearly revealed that the aforementioned conjectures cannot be stated in such a general way. A significant progress in the characterization of cuspidal manipulators was done in Wenger (1995): a 3-DOF positioning manipulator can change posture without meeting a singularity if, and only if, there exists at least one point in its workspace with exactly three coincident inverse kinematic solutions. In a cross-section of the workspace, such a point appears as a cusp<sup>2</sup> point (hence the word "cuspidal" manipulators). Figure 1 depicts, in a half cross-section of the workspace, the critical value manifolds for a cuspidal manipulator (DH-parameters:  $a_1 = 1$ ,  $a_2 = 1.7$ ,  $a_3 = 1.3$ ,  $d_2 = 0.8$ ,  $d_3 = 0.5$ ,  $\alpha_1 = -70$  deg and  $\alpha_2 = 56$  deg). There are four cusp points in this workspace. The cusp points are always located at "corner points" of a region with four admissible postures.

The condition for the existence of a cusp point can be checked graphically or numerically. When integrated in a CAD environment, it provides a useful tool for the purpose of manipulator design. Unfortunately, it can be shown that the existence condition of a cusp point cannot be written in an explicit, amenable expression of the DH-parameters solely (El Omri, 1996), and it has not been possible to enumerate all nonsingular posture changing manipulators using a DH-parameter based general condition.

**2.4 Classification Using the Notion of Homotopy Class.** Two maps are said to be homotopic if there exist a continuous transformation between them. In the context of manipulator kinematics, two generic manipulators  $M_1$  and  $M_2$  are homotopic if the critical point manifolds of  $M_1$  can be smoothly deformed to the critical point manifolds of  $M_2$ . More importantly, it was shown in (Burdick, 1995) that the kinematic maps of two homotopic manipulators have the same multiplicity. This means that the maximum number of inverse kinematic solutions per c-sheet is the same for two homotopic manipulators. Consequently, if an arbitrary manipulator  $M$  is cuspidal (resp. noncuspidal), all manipulators which are homotopic to  $M$  will be also cuspidal

<sup>2</sup> The cusp point is one of the two typical singular points on algebraic curves (a singular point is defined here as one point where the partial derivative with respect to each independent variable of the curve is zero). The other singular point is the double point, occurring at self-intersection points (Smith, 1990).

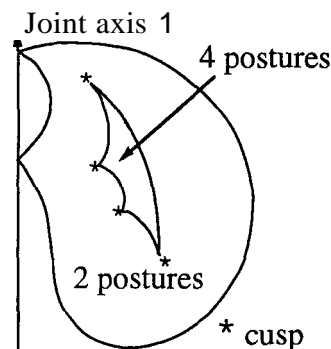

fig. 1 Cusp points in the workspace cross section of a cuspidal manipulator

(resp. noncuspidal). The homotopy based classification scheme is the following:

- the space of all quaternary<sup>3</sup> 3R positioning manipulators is naturally divided by the set of nongeneric manipulators, into disjoint subspaces of homotopic generic manipulators.
- the homotopic generic manipulators are characterized by the number and homotopy class of their critical point manifold branches in the joint space. The word "branches" is referred to as the connected components of the critical point manifolds.

For a generic manipulator, it has been shown that each branch forms a one-dimensional loop (i.e., a closed curve) on the surface of the  $(\theta_2 - \theta_3)$ -torus. The branch homotopy classes are closely related to the topological properties of loops on the  $(\theta_2 - \theta_3)$ -torus. In the plane  $R^2$ , all loops can be continuously deformed to one point: they are all homotopic. This is not the case on the torus, where there are as many loop classes as ways of encircling the two generators of the torus. Figure 2 illustrates loops with three different homotopy classes. The homotopy class of  $L_1$  is a circle along the  $\theta_2$ -generator of the torus. In a square representation  $(-\pi \leq \theta_2 < \pi, -\pi \leq \theta_3 < \pi)$  of the torus,  $L_1$  appears as an horizontal line. The homotopy class of  $L_2$  is a circle along the  $\theta_3$ -generator, and its square representation is a vertical line. Finally,  $L_3$  does not encircle any of the two generators:  $L_3$  is homotopic to one point. There are a double infinity of possible loop homotopy classes on the torus, in accordance with the number of times a loop may encircle each generator.

The homotopy class of a critical point manifold branch can be defined by a set of two integers  $(n_2, n_3)$ . Integer  $n_2$  (resp.  $n_3$ ) characterizes the number of times the branch encircles the  $\theta_2$ -generator (resp.  $\theta_3$ -generator) of the torus  $(\theta_2, \theta_3)$ . In Fig. 2, the homotopy class of  $L_1$  (resp.  $L_2, L_3$ ) is  $(1, 0)$  (resp.  $(0, 1), (0, 0)$ ). Accordingly, the homotopy class of a generic manipulator is characterized by a series of couples  $(n_2, n_3)$  which define the homotopy classes of each of its branches.

The drawback of the square representation of the torus is that, since it splits artificially the critical point manifolds along the generators of the torus, it is sometimes difficult to identify their shape, especially when we have a  $(0, 0)$ -branch which is not confined within the square representation. To better understand that there is actually one single critical point manifold branch with homotopy class  $(0, 0)$ , it is useful to "reconstruct" the critical point manifold by identifying the opposite sides of

<sup>3</sup> Most 3R manipulators are quaternary, i.e., have four inverse kinematic solutions. Under special geometric conditions (like d4 d3), 3R manipulators may have only two inverse solutions, one in each c-sheet, and it can be shown that such manipulators are always noncuspidal. Quaternary manipulators are more desirable since the possibility to reach a location with four different postures is more interesting. Only quaternary manipulators will be considered in this classification.

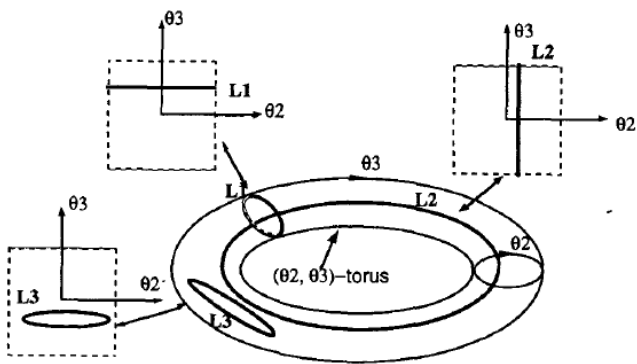

Fig. 2 Some loop homotopy classes on the torus

the square representation of the torus. Figure 3 (a) depicts a manipulator with DH-parameters  $a_1 = 1, a_2 = 2, a_3 = 2.5, d_1 = 1, d_2 = 0.2, \alpha_1 = -62 \text{ deg}, \alpha_2 = 90 \text{ deg}$ . From Fig. 3(b), it is clear that there is only one branch, which can be smoothly contracted to one point. Thus, this manipulator is  $1(0, 0)$ . A simple, general procedure for recognizing the homotopy class of an arbitrary generic manipulator can be established (see Section 4).

The enumeration of all generic manipulator classes has not been attempted yet. In the following section, a series of seven new theorems will be set which will permit to enumerate all possible classes.

### 3 Enumeration of all Branch Homotopy Classes

3.1 Separating and Nonseparating Critical Point Manifolds. The critical point manifolds divide the joint space of 3R manipulators in at least two c-sheets. A single critical point manifold branch has not necessarily the ability to cut the joint space into several c-sheets. When it can do so, the branch is said to be separating (Burdick, 1988; Tsai, 1990).

**Theorem 1:** A branch is separating if and only if its homotopy class is  $(0, 0)$ . Thus, the only branch which can appear alone in a generic manipulator is a  $(0, 0)$ -branch.

*Proof* This result is due to the topology of the torus, which, unlike  $R^2$ , is not simply connected. The only loop which can

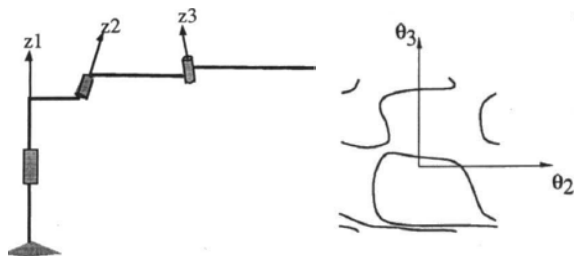

Fig.3(a) Manipulator with  $(0, 0)$  homotopy class

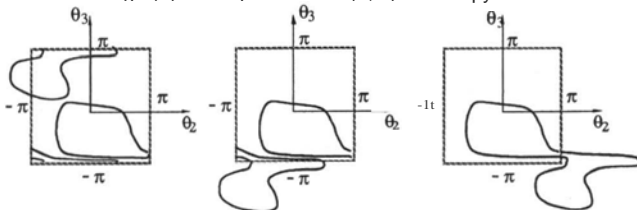
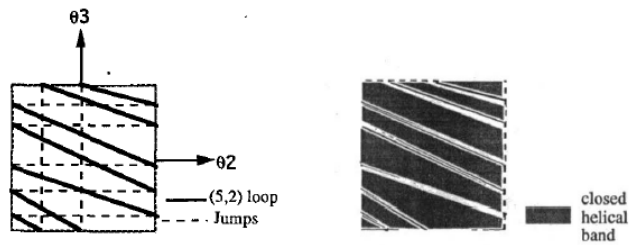

Fig. 3(b) Critical point manifold shape reconstruction by opposite sides identification

Fig. 4 Square representation of a non separating loop on the torus



divide the torus is one which encircles no generators. In Fig. 2 it is clear that  $L_1$  and  $L_2$  do not divide the torus, while  $L_3$  does. Any other (regular, i.e., without self-intersection) loop appears as a helical closed curve on the torus, and it is always possible to link any two points on the torus without encountering the loop. In effect, the set obtained by removing the helical loop from the torus forms an helical closed band. Figure 4 illustrates this result with a  $(5, 2)$ -loop (the dashed lines show the "jumps" of the loop between two opposite sides of the square, indicating that the loop wraps around one generator). Since a generic 3R manipulator must have at least two c-sheets,  $(0, 0)$  is the only possible homotopy class for a single critical point manifold branch.

3.2 Enumeration of the Possible Loop Homotopy Classes. Many branch homotopy classes cannot exist in generic manipulators, as will be shown in the following theorems.

**Theorem 2:** The branch of a generic 3R positioning manipulator cannot encircle the  $\theta_3$ -generator more than once (i.e.,  $n_3 \leq 1$  for a generic 3R manipulator)

*Proof:* The critical point manifolds of 3R positioning manipulators are analytically defined by the zero sets of the determinant of the Jacobian  $\det(\mathbf{J})$ , which can be put in a polynomial of degree 2 in  $t_2$  and 4 in  $t_3$ , where  $t_2 = \tan(\theta_2/2)$  and  $t_3 = \tan(\theta_3/2)$  (Burdick, 1988). Thus,  $\det(\mathbf{J}) = 0$  has at most two solutions in  $\theta_2$  when  $\theta_3$  is fixed. In other words, the critical point manifolds cannot be cut more than twice by the  $\theta_2$ -generator. Since there are  $n_3$  intersections between the  $\theta_2$ -generator and a loop which wraps around the  $\theta_3$ -generator of the torus  $n_3$  times,  $n_3$  is necessarily less than three. Assume that  $n_3 = 2$ . Since a  $(n_2, 2)$ -critical point manifold branch is not separating (from Theorem 1), and since a 3R positioning manipulator has at least two c-sheets, a  $(n_2, 2)$ -branch cannot exist alone. But an additional critical point manifold branch would lead to either more than two intersections with the  $\theta_2$ -generator, or nongeneric intersecting points between the critical point manifold branches (Fig. 5). Thus  $n_3 \leq 1$ .

**Theorem 3:** If  $n_3 = 0$ , then  $n_2 \leq 1$ .

*Proof:* Consider a curve which does not encircle the  $\theta_3$ -generator. If it encircles the  $\theta_2$ -generator only once, this is a circle like  $L_1$  (Fig. 2). If it encircles the  $\theta_2$ -generator more than once,

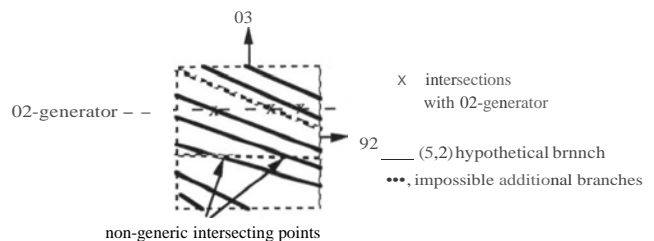

Fig. 5 Impossible branch

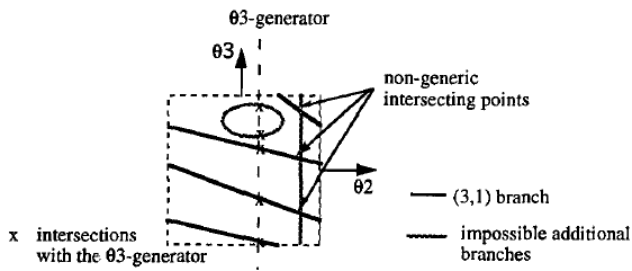

Fig. 6 A (3,1)-branch is not possible

this is a helical curve which proceeds along the  $\theta_3$ -generator. But since this curve cannot wrap around the  $\theta_3$ -generator, the only closing way for this helical curve is to go backward, which cannot be done without self intersections.

**Theorem 4:** The critical point manifold branch of a generic 3R positioning manipulator cannot encircle the  $\theta_2$ -generator more than twice (i.e.,  $n_2 \leq 2$  for a generic 3R manipulator)

*Proof:* Since  $\det(\mathbf{J})$  is fourth degree in  $t_3$ ,  $n_2$  cannot be more than four. On the other hand,  $n_2 = 4$  is not possible since a  $(n_3, 4)$ -critical point manifold branch cannot exist alone (from Theorem 1), and its coexistence with any other branch would imply that  $\det(\mathbf{J}) = 0$  has more than four solutions in  $\theta_3$  when  $\theta_2$  is fixed.

Now, we show that  $n_2 = 3$  is not possible either. By virtue of Theorem 2, we know that  $(3, n_3)$  is not possible for  $n_3 > 1$ . Moreover, Theorem 3 tells us that  $(3, 0)$  is not possible. Thus, we need only to prove that  $(3, 1)$  cannot exist. This branch cannot exist alone since it is not separating. However, it is not possible to add another branch. In effect,  $(1, 0)$  and  $(0, 1)$  additional branches would intersect the  $(3, 1)$ -branch, and any other additional branch like  $(0, 0)$  would exceed the maximum allowable number of solutions to  $\det(\mathbf{J}) = 0$  when  $\theta_2$  is fixed (Fig. 6).

From Theorems 2, 3 and 4, it follows that the only possible branch homotopy classes are  $(0, 0)$ ,  $(0, 1)$ ,  $(1, 0)$ ,  $(1, 1)$ ,  $(2, 1)$ . Next theorems will enumerate the possible combinations.

**3.3 Enumeration of the Possible Branch Combinations.** In this section, we show that many branch combinations are not possible.

**Theorem 5:** Branches with homotopy class  $(0, 1)$ ,  $(1, 0)$ ,  $(1, 1)$ , and  $(2, 1)$  cannot appear in a mixed combination.

*Proof:* Any mixed combination would lead to intersecting branches, as shown in Fig. 7.

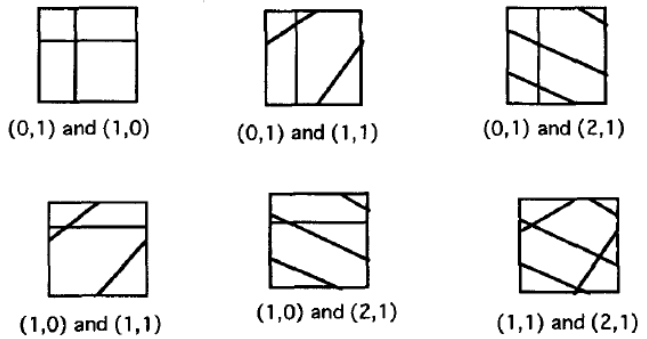

Fig. 7 Incompatible homotopy classes

**Theorem 6:** Branches of homotopy class  $(0, 1)$ ,  $(1, 1)$  and  $(2, 1)$  always appear in pairs;  $(1, 0)$ -branches appear in pairs or in sets of four.

*Proof:* We know that  $(0, 1)$ ,  $(1, 1)$ ,  $(2, 1)$ , and  $(1, 0)$  branches cannot appear alone (from Theorem 1), and that they cannot coexist with branches of different classes (from Theorem 5). On the other hand, more than two coexisting branches with homotopy class  $(0, 1)$ ,  $(1, 1)$  or  $(2, 1)$  would cut the  $\theta_2$ -generator more than twice, which is not possible. Finally, a generic manipulator cannot have three  $(1, 0)$ -branches, otherwise its critical point manifolds would be cut three times by any  $\theta_3$ -generator. If so, the coefficient in  $t^4$  of  $\det(\mathbf{J})$  would be zero for all  $\theta_2$ , which was proved in Burdick (1995) to be a special case of nongenericity.

**Theorem 7:** A  $(0, 0)$ -branch may either appear alone, together with an additional  $(0, 0)$ -branch, or with two  $(1, 0)$ -branches.

*Proof:* A  $(0, 0)$ -branch cannot coexist with a  $(0, 1)$ ,  $(1, 1)$  or  $(2, 1)$ -branch, otherwise the critical point manifold would be cut more than twice by the  $\theta_2$ -generator. A  $(0, 0)$ -branch with only one  $(1, 0)$ -branch would yield a maximum of three intersecting points with the  $\theta_3$ -generator, which, as recalled above, is a special case of nongenericity. On the other hand, more than two coexisting  $(0, 0)$ -branches would yield more than four intersections with the  $\theta_3$ -generator. For the same reason, a pair of  $(0, 0)$ -branches cannot coexist with a  $(1, 0)$ -branch. On the other hand, we know from Theorem 1 that a  $(0, 0)$ -branch may appear alone.

**3.4 Theorem 8: The Homotopy Classes of Generic Manipulators.** The preceding Theorems show that there are exactly eight classes of homotopic generic 3R manipulators:  $\{1(0,$

Table 1 The eight classes of generic manipulators

Class	# c-sheets	cuspidal	DH-parameters of manipulator example shown						Fig. 8	
			$a_1$	$a_2$	$a_3$	$d_2$	$d_3$	$\alpha_1$		$\alpha_2$
1(0,0)	2	yes	1.5	1	2	1	1	45°	80°	(a)
2(0,0)	3	yes	2.5	0.6	2.6	1	-4	-90°	90	(b)
1(0,0)+2(1,0)	3	yes	3	0.8	2.8	0.1	1	70°	-56°	(c)
2(1,0)	2	yes	1	2	1.5	1	0	-90°	90°	(d)
4(1,0)	4	NO!	2.5	0.5	2	1	0.3	-80°	70°	(e)
2(0,1)	2	yes	0.5	0.7	1.5	0	0	80°	60°	(f)
2(1,1)	2	yes	1.3	1.7	0.8	-0.3	0.4	50°	-30°	(g)
2(2,1)	2	yes	0.8	1	1.4	0.3	0.3	45°	-70°	(h)

0), 2(0, 0), 1(0, 0) + 2(1, 0), 2(1, 0), 4(1, 0), 2(0, 1), 2(1, 1), 2(2, 1)}.

#### 4 Examples

Systematic investigations have confirmed the existence of the preceding eight homotopy classes (El Omri, 96). In this section, we provide an example for each class. For each example, a figure depicts the manipulator geometry in the zero configuration, the critical point manifolds and the critical value manifolds in a cross section of the workspace (e.g., in a plane  $x, \rho = x^2 + y^2$ ), along with the number of postures in each region.

To identify the homotopy class of a given generic manipulator, one can follow the following procedure. The idea is to track each branch, and to count for the number of "jumps" between to opposite sides of the square representation. At each jump,  $n_2$  and  $n_3$  are either increased or decreased, according to whether the jump occurs from  $-P_i$  to  $+P_i$  or from  $+P_i$  to  $-P_i$ , respectively. Table 1 synthesizes the main properties of the eight classes of homotopic manipulators found and the DH-parameters of the manipulator examples shown in Fig. 8(a-h).

#### 5 Comments

5.1 Interesting Results for Generic Manipulators. From the above categorization, it is apparent that:

- a generic 3R manipulator may have two, three, or four c-sheets. It has often been thought that manipulators with general geometry should have only two c-sheets, and that manipulators with four c-sheets should have some simple geometric parameters. It has been established here that a manipulator with general DH-parameters may have four c-sheets. Manipulators with four c-sheets have only one inverse kinematic solution in each c-sheet. Manipulators with three c-sheets have two inverse kinematic solutions in one of their c-sheets, and there is only one solution in each of the remaining two c-sheets.
- most generic manipulators are cuspidal. In effect, the only way for a generic manipulator to be noncuspidal, is either to have only two inverse kinematic solutions (which requires specific geometric conditions), or to belong to the class of 4(1, 0)-manipulators, which was shown to be the least populated class (El Omri, 96). From a design point of view, this means that the set of admissible design variables is limited for a generic noncuspidal manipulator, and the possibility to optimize additional design criteria is, in turn, also limited.
- the only generic manipulators with four c-sheets are the 4(1, 0)-manipulators, which are the only noncuspidal manipulators with four solutions. Thus, the following new result can be stated:

**Theorem 9:** a generic quaternary 3R manipulator is noncuspidal if and only if it has four c-sheets.

5.2 Nongeneric Manipulators. The eight homotopy classes of generic manipulators are connected through the set of nongeneric manipulators. When a generic manipulator changes class (under modification of the DH-parameters), it must pass through an intermediate (unstable) nongeneric state, which can be interpreted as a bifurcation. A nongeneric manipulator can be cuspidal or noncuspidal. Determination of cuspidal and noncuspidal nongeneric manipulators is still a subject of research.

5.3 Workspace Structure of Homotopic Manipulators. The classification presented in this work relies on the geometry and topology of the critical point manifolds in the joint space. Workspace boundaries are generated by the transformation of these manifolds under the action of the forward kinematic map,

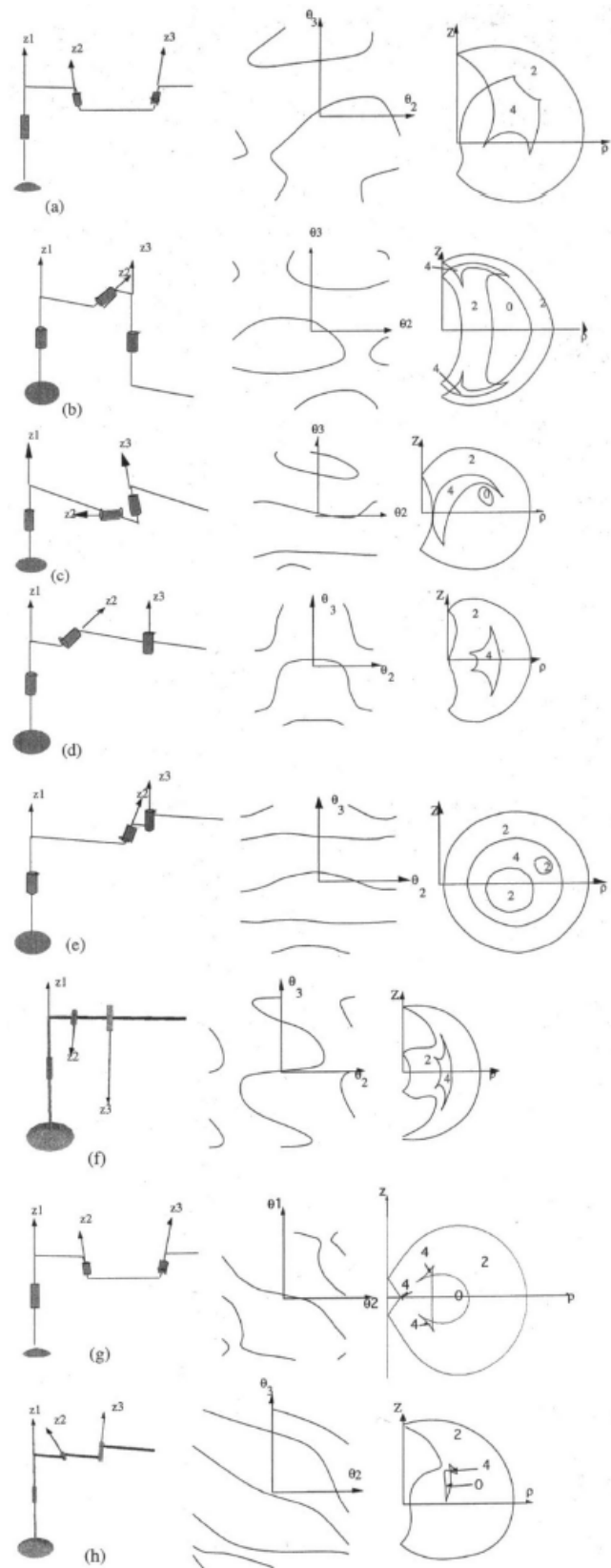

Fig. 8 The eight classes of generic manipulators

which reorganizes the initial geometrical and topological features. More importantly, two manipulators of the same homotopy class may have different workspace structures. In particu-

Jar, the occurrence of voids in the workspace is not related to a particular homotopy class.

## 6 Conclusions and Perspectives

This paper has established the complete classification of all generic positioning 3R manipulators. The classification was based on the number and loop homotopy class of manipulator critical point manifold branches. The homotopy class was defined by a pair of two integers which indicate the number of times a branch wraps around each generator of the  $(\{12, 03\})$ -torus. A series of theorems have shown that there are no more than eight distinct classes of homotopic manipulators. It was found that all manipulators with homotopy class  $1(0, 0)$ ,  $2(1, 0)$ ,  $2(0, 1)$ ,  $2(1, 1)$ , and  $2(2, 1)$  have two c-sheets. Manipulators with homotopy class  $2(0, 0)$  and  $1(0, 0) + 2(1, 0)$  have 3 c-sheets. Finally, all manipulators with homotopy class  $4(1, 0)$  have four c-sheets. The classification proposed in this paper provides an efficient synthetic tool for categorizing cuspidal and noncuspidal manipulators. It was shown that the only non-cuspidal generic 3R manipulators are the  $4(1, 0)$ -manipulators. More generally, it has been pointed out that most generic 3R manipulators are cuspidal. This is an interesting, nonintuitive new result.

The classification presented here applies to 6R manipulators with spherical wrist as well, and can be extended without difficulty to 3-DOF manipulators with prismatic joints. On the other hand, generalization to 6-DOF manipulators with nonspherical wrist is not so easy, because their critical point manifolds must be analyzed in a four-dimensional space (since they depend on four joint variables  $q_2$  to  $q_5$ ).

Future research work is to include the complete categorization of nongeneric 3-DOF manipulators.

## References

Ranjbaran, F., and Angeles, J., 1994, "On Positioning Singularities of 3-Revolute Robotic Manipulators," *Proc. 12th Symp. on Engineering Applications in Mechanics*, pp. 273-282, June 94, Montreal, Canada.

Borrel, P., and Liegeois, A., 1986, "A Study of Manipulator Inverse Kinematic Solutions With Application to Trajectory Planning and Workspace Determination," *Proc. IEEE Int. Conf. Rob. and Aut.*, pp. 1180-1185.

Burdick, J. W., 1988, "Kinematic Analysis and Design of Redundant Manipulators," Ph.D. Dissertation, Stanford.

Burdick, J. W., 1995, "A Classification of 3R Positioning Manipulator Singularities and Geometries," *Journal of Mechanisms and Machine Theory*, Vol. 30, pp. 71-89.

Ceccarelli, M., 1995, "A Synthesis Algorithm for Three-Revolute Manipulators by Using an Algebraic Formulation of Workspace Boundary," *ASME JOURNAL OF MECHANICAL DESIGN*, Vol. 117, pp. 298-302.

Chevallereau, C., 1996, "Feasible Trajectories for a Non-Redundant Robot at a Singularity," *Proc. IEEE Int. Conf. on Rob. and Aut.*, pp. 1871-1876.

El Omri, J., "Kinematic Analysis of Robot Manipulators," (in french) Ph.D. Dissertation, Ecole Centrale de Nantes, France, 1996.

Gupta, K. C., and Roth, B., 1982, "Design Considerations for Manipulator Workspaces," *ASME JOURNAL OF MECHANICAL DESIGN*, Vol. 104, pp. 704-711.

Kholi, D., and Hsu, M. S., 1987, "The Jacobian Analysis of Workspaces of Mechanical Manipulators," *Journal of Mechanisms and Machine Theory*, Vol. 22, No. 3, pp. 265-275.

Kumar, A., and Waldron, K. J., 1981, "The Workspace of Mechanical Manipulators," *ASME JOURNAL OF MECHANICAL DESIGN*, Vol. 103, pp. 665-672.

Paden, B., and Sastry, S., 1988, "Optimal Kinematic Design of 6R Manipulators," *The Int. Journal of Robotics Research*, Vol. 7, No. 2, pp. 43-61.

Pai, D. K., "Generic Singularities of Robot Manipulators," *Proc. IEEE Int. Conf. on Rob. and Aut.*, pp. 738-744, 1989.

Parenti, C. V., and Innocenti, C., "Spatial Open Kinematic Chains: Singularities, Regions and Subregions," *Proc. 7th CISM-IFTOMM Romansy '88*, pp. 400-407, Sept. 1988, Udine, Italy.

Rastegar, J., and Deravi, P., 1987, "Methods to Determine Workspace with Different Numbers of Configurations and all the Possible Configurations of a Manipulator," *Journal of Mechanisms and Machine Theory*, Vol. 22, No. 4, pp. 343-350.

Smith, D. R., "Design of Solvable 6R Manipulators," Ph.D. Thesis, Georgia Inst. of Tech., Atlanta, 1990.

Tsai, K. Y., "Admissible Motions in Manipulator's Workspace," Ph.D. Dissertation, Univ. Wisconsin, 1990.

Wenger, P., and Chedmail, P., "On the Connectivity of Manipulator Free-Workspace," *Journal of Robotic Systems*, Vol. 8(6), Dec. 1991.

Wenger, P., 1992, "A New General Formalism for the Kinematic Analysis of all Non-Redundant Manipulators," *IEEE Int. Conf. on Rob. and Aut.*, pp. 442-447, 1992, Nice, France.

Wenger, P., and El Omri, J., "How to Recognize Simply a Non-Singular Posture Changing 3-DOF Manipulator," *7th Int. Conf. on Advanced Robotics (ICAR'95)*, Sept. 95, San Feliu de Glixol, Spain.

Wenger, P., and El Omri, J., "Changing Posture for Cuspidal Robot Manipulators," *IEEE Int. Conf. on Rob. and Aut.*, pp. 3173-3178, May 1996, Minneapolis, USA.

Yang, D. C. H., and Lee, T. W., 1983, "On the Workspace of Mechanical Manipulators," *ASME JOURNAL OF MECHANICAL DESIGN*, Vol. 105, pp. 62-70.