



HAL
open science

Microwave drying of wet clay with intermittent heating

Nicole Vorhauer, Anne Tretau, Andreas Bück, Marc Prat

► **To cite this version:**

Nicole Vorhauer, Anne Tretau, Andreas Bück, Marc Prat. Microwave drying of wet clay with intermittent heating. *Drying Technology*, 2019, 37 (5), pp.664-678. 10.1080/07373937.2018.1547740 . hal-02361159

HAL Id: hal-02361159

<https://hal.science/hal-02361159>

Submitted on 13 Nov 2019

HAL is a multi-disciplinary open access archive for the deposit and dissemination of scientific research documents, whether they are published or not. The documents may come from teaching and research institutions in France or abroad, or from public or private research centers.

L'archive ouverte pluridisciplinaire **HAL**, est destinée au dépôt et à la diffusion de documents scientifiques de niveau recherche, publiés ou non, émanant des établissements d'enseignement et de recherche français ou étrangers, des laboratoires publics ou privés.



Open Archive Toulouse Archive Ouverte (OATAO)

OATAO is an open access repository that collects the work of Toulouse researchers and makes it freely available over the web where possible.

This is an author-deposited version published in: <http://oatao.univ-toulouse.fr/>
Eprints ID: 24634

To link to this article : DOI:10.1080/07373937.2018.1547740

URL : <https://doi.org/10.1080/07373937.2018.1547740>

To cite this version: Vorhauer, Nicole^{ORCID} and Tretau, Anne and Bück, Andreas^{ORCID} and Prat, Marc^{ORCID} *Microwave drying of wet clay with intermittent heating*. (2019) *Drying Technology*, 37 (5). 664-678. ISSN 0737-3937

Microwave drying of wet clay with intermittent heating

N. Vorhauer^a, A. Tretau^b, A. Bück^c, and M. Prat^{d,e}

^aOtto von Guericke University Magdeburg, Magdeburg, Germany; ^bBrick and Tile Research Institute Essen Regd., Essen, Germany;

^cFriedrich Alexander University Erlangen Nuremberg, Erlangen, Germany; ^dINPT, UPS, IMFT (Institut de Mécanique des Fluides de Toulouse), Université de Toulouse, Toulouse, France; ^eCNRS, IMFT, Toulouse, France

ABSTRACT

In this article, we study an alternative process for the conservative drying of wet clay based on combined microwave heating and convective drying. The study is founded on an experimental analysis of the processes that control drying of porous matter in presence of temperature gradients. We show and discuss that process control cannot be reliably based on temperature alone because mass transfer phenomena associated with microwave heating dictate drying kinetics. Essentially, the occurrence of pressure build up and liquid expulsion, dominating mass transfer if microwave heating is uncontrolled or with high power, vitally depend on the moisture content of the clay. As a consequence, the deterioration of clay is problematic if internal evaporation rates are high, thus at the start of drying when also the moisture content is high. Following this, we propose intermittent microwave heating in combination with convective drying periods with the aim to reduce overall drying time (compared to conventional convective drying) and to improve product quality by reduced material shrinkage. Drying experiments indicate that the overall drying time reduction and product quality depend on the frequency and duration of the two subsequent periods of intermittent heating and convective drying. The observations can be explained with the evolution of the pore-scale distribution of liquid and vapor during drying.

KEYWORDS Drying; microwave; intermittent dielectric heating; clay

Introduction

Wet clay is the raw material in production of bricks used in the building industry as clay blocks, roof tiles or facing bricks. It is a natural product and underlies natural variations of composition and water content. In the production process, wet clay is initially pretreated and molded. The pretreatment usually involves homogenization of the natural product with additives and water. The molded wet clay is then dried before it is fired in tunnel kilns at temperatures between 900 and 1200 °C. Besides solar drying, which is used in brick production already since centuries, in most cases the drying process is realized in tunnel ovens with convective hot air flowing counter-current to the stacked clay. Contemporary, it is the state of the art to couple the drying process with the firing process by using the hot gas from the cooling zone of the kilns with a temperature of around 100–300 °C and humidity of 1% as heat source.^[1] The energy coupling is a result of the optimization of temperature profiles in the tunnel kilns by the volume flow rate of the hot gas. This has led to very high gas flow rates related to the overall solid flow rate through the tunnel kilns. In detail, the

ratio of the volume flow rates of gas to solid is usually >1. Currently, more than 50% of the primary fossil energy originally supplied to the kiln is re-used for drying and pre-heating.^[2] The re-use of the hot air aims on the improvement of the energy specific efficiency of the complete production process.^[1] Nevertheless, the efficiency of the total process is still only around 25% which is mainly ascribed to the low performance of the drying process if it is assumed that sintering of the clay does not require additional enthalpy.^[2] Independent of this, the coupling has basically two disadvantages. At first, dryer and kiln are operated asynchronously (e.g. Ref. 1). Secondly, the energy efficiency of both processes cannot be improved as long as the two processes are energetically coupled. Recent developments (e.g. Refs. 3, 4) reveal that the firing process can be energetically more efficient if the volume flow rate of air is reduced while the geometrical arrangement of the setting of the clay internal of the kiln and the fan are optimized or if the kiln is realized with solid–solid recuperation.^[2] The reduction of the volume flow rate of air in the firing step though demands reconciliation of the drying process as well.

The energy efficiency of the drying process is generally kinetically controlled and limited by the requirements of product quality. Therefore, different process temperatures are applied during the different stages of drying. In the first stage of drying, the green bricks are usually dried at low wet bulb temperatures (very often $T < 60^\circ\text{C}$) in order to achieve high moisture permeability within the porous medium and to avoid cracking of the material as well^[3,5,6] whereas at later stages of drying, when the overall moisture content is low, higher gas temperatures are applied with the purpose to increase the driving force for the transport of water vapor from the porous medium. The advantages of such process conditions can be explained from the pore-scale analysis of drying. While slow drying at low process temperatures and/or higher relative humidity, such as during the initial drying stage in clay drying ovens, results in a rather homogeneous distribution of liquid patches at the transition of the period of constant drying rates (i.e. the constant rate period, CRP) and the period in which the liquid phase recedes from the open surface (i.e. the receding front period), fast drying (i.e. with high process temperatures and lower relative humidity) sharpens the drying front wherefore the CRP diminishes. The sharpening effect is higher for higher temperature gradients. A different situation though is expected if the latent heat for the vaporization of water is additionally supplied by contact heating (e.g. from the transport cars which carry the clay through oven and kiln). However, thermal conductivity of dry clay is rather low ($\lambda < 0.6 \text{ W m}^{-1} \text{ K}^{-1}$) wherefore thermal gradients along the porous material are relatively difficult to control with the currently established drying processes.

A remedy to overcome, both, heat and mass transfer resistances can be seen in the application of microwave heating. Microwave drying has already successfully been applied in the food industry, ceramic production or the paper industry. Reviews can be found in Refs 7, 8, or 9. Microwave heating of water wet porous media is based on the dissipation of energy from the dielectric field based on the dielectric properties of the porous material, the electric field strength E , frequency f as well as duration of the exposure to the dielectric field. The dielectric properties are described by the permittivity

$$\varepsilon = \varepsilon' - i\varepsilon'', \quad (1)$$

which comprises the relative permeability ε' (real part) and the loss factor ε'' (imaginary part).^[7] The latter defines the amount of dissipated energy and depends on the moisture content X (kg water per kg dry solid) of the porous medium with water as well as temperature T (e.g. Refs. 7, 10, 11):

$$P = cE^2f\varepsilon''(X, T), \quad (2)$$

with P in W cm^{-3} .

The advantages of microwave heating are explained with the dissipation of electromagnetic energy by water dipoles. The dielectric properties vary almost linearly with the moisture content of the product in a wide range.^[10] Thus, at the start of drying, when the moisture content is high, very good dielectric properties are anticipated. In contrast to convective drying, where the highest temperatures are always at the surface of the porous material, in microwave heating the highest temperatures are expected where the moisture content is high, that is, inside the porous medium.^[12,13] Depending on the initial moisture content and geometry of the product the temperature can be equally distributed at the start of drying, while at later drying stages the maximum temperature is expected inside the product.^[14–16] Consequently, heat transfer resistances, limiting the kinetics of conventional drying, are less severe in dielectric heating.

From pore scale studies presented in Refs. 17, 18 and 19 it can be concluded that the direction of moisture migration can be controlled by the thermal gradient imposed on the porous medium. In contrast to convective drying where the drying front recedes from the surface (with maximum product temperature), the liquid phase is expected to travel towards the surface in microwave drying processes, as illustrated in Figure 1.^[12] Efficiency of microwave drying processes is thus not only referred to the diminishing of heat transfer resistances but also to the favorable drying front position.^[15] It is highlighted, that dependency of the heat generation on the pore scale liquid distribution is in contrast to conventional drying processes, where the temperature profile usually depends on the way of heat supply and thermal conductivity of the product. In contact drying processes maximum temperature is usually found at the contact point of the product with the hot surface whereas in convective drying a temperature profile with maximum temperature at the surface of the porous medium develops (Figure 1a).

The local warming by energy dissipation, however, can result in a rapid increase of the internal product temperature if the microwave is operated at high power. This can result in high internal evaporation rates and the development of high pressures if vapor permeability of the material is low. The pressure build up can positively affect the transport of vapor due to the evolving pressure gradients inside the product. According to Ref. 13 or 16, the pressure build up also facilitates expulsion of liquid, if the liquid phase is interconnected and connected to the surface as well.

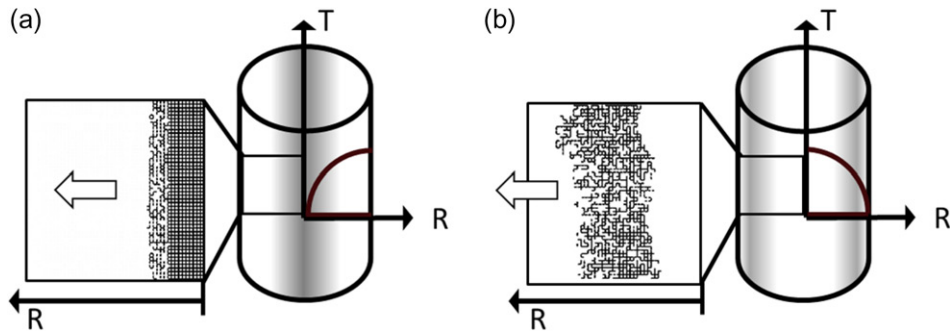

Figure 1. Comparison of pore level moisture transfer during (a) conventional drying and (b) drying with dielectric heating. Liquid phase is black and gas phase in white.

However, as discussed in this article, the effects related to the pressure build up are only affordable if the material has a high mechanical strength or high porosity. Previous studies of microwave drying of wet clay though revealed damages or completely deterioration if heat supply by electromagnetic waves is not carefully controlled.^[6,20] As a consequence, microwave drying has rather rarely been considered as an alternative drying process for wet clay.

This reveals the high demand on process control, if microwave heating shall be applied with the purpose to improve efficiency of the drying process (e.g. Refs. 13, 21, 22) Starting from this, we study microwave drying of wet clay using a domestic microwave with $P=800$ W. But contrary to previous studies^[6] we propose an intermittent drying process combining microwave heating and convective drying. The microwave heating intervals are very short (only a few seconds) whereas duration of the convective drying intervals is at least one order of magnitude longer. We assume that with the reduction of the total power supplied to the wet product, achieved by the reduction of the duration of microwave heating, and the combination with an interval of purely convective drying, rather homogenous temperature profiles evolve in the drying product. We assume furthermore that the interruption of microwave heating during the convective drying interval allows reducing internal pressures due to the reduction of local evaporation rates and due to the spread of vapor from regions with higher vapor pressure towards the surface, accompanied by the condensation of vapor.^[23] In addition to that, we expect that the short intervals of microwave heating are sufficient to impose a favorable temperature gradient with high temperatures in the wet core and lower temperatures at the surface of the clay.^[24] Following Ref. 13, we expect that this temperature gradient can generally lead to an improvement of pore scale transport properties in comparison to conventional convective drying. Indeed, experimental results already reported in

Ref. 20 indicate that moisture distribution is more homogenous if the interval of microwave heating is short. However, the moderate drying method is less efficient than drying with uncontrolled dielectric heating because moisture transfer is basically by capillary liquid pumping and convection diffusion whereas pressure build up and liquid expulsion are excluded. But, as will be shown, this can be in favor for the prevention of cracks while the combination of microwave heating with convective drying reduces the overall drying time compared to purely convective drying.

This article is organized as follows. At first we present a pilot study in which we estimate the limits of drying of wet clay with microwave heating for different materials and geometry. The optimal drying procedure estimated in this study is then applied in a second experimental study in which intermittent microwave heating is combined with convective drying. It is shown that drying with intermittent microwave heating is especially efficient if the specimens are thin and if all surfaces are accessible for vapor transport. In the last section we summarize the most striking outcomes of this study with perspectives for future work.

Pilot study

In this section we recall the results of the feasibility study partly presented in Ref. 20. Additionally we present new results obtained from experiments with different materials and drying modes.

For this study we used a domestic microwave with frequency $f=2.45$ GHz and maximum power $P=800$ W (Figure 2). The specimens were positioned on a PVC sample holder in the center of the microwave in upright position to allow maximum energy coupling along the center line of the samples. If not mentioned otherwise, the specimens were not rotated in the pilot study but kept at constant position during microwave heating for reasons of reproducibility. The

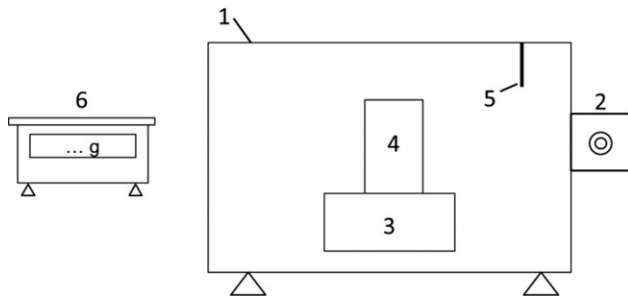

Figure 2. Sketch of the experimental set-up. (1) Microwave housing, (2) magnetron, (3) sample holder, (4) sample, (5) thermocouple, (6) balance.

distance of the sample center from the magnetron was approximately 15 cm. The mass of the samples was measured with an external balance (Sartorius MC401S, precision 10^{-4} g). For this purpose, they were removed from the microwave at distinct time steps during drying (when microwave heating was interrupted). The temperature inside the microwave was measured with a thermocouple of type K. The thermocouple was brought into the microwave through a bore hole at the top side of the microwave (Figure 2) when operation of the microwave was interrupted (i.e. during weighting of the samples).

Procedure of the drying experiments followed a fixed scheme in which the mass of the samples and the temperature of samples and microwave were initially measured before the samples were placed inside the microwave. The microwave was then operated at $P=800$ W. The drying experiments were stopped if any material damage was observed. In most cases, the deterioration of the samples was accompanied by small explosions with noticeable noise. Then the mass of the samples was measured again, taking care to include also the spalled material in the measurements. Table 1 gives an overview of the different clay materials used in the pilot study. Notice that each drying experiment was carried out with only one sample at a time.

The pilot study focused on the identification of the limits of microwave drying of wet clay. In detail, two different drying modes were applied. In the first drying mode, operation of the microwave was uncontrolled at $P = 800$ W with the purpose to estimate the limits of microwave heating whereas in the second drying mode the microwave was operated intermittently in combination with a resting period in which the samples dried under ambient conditions (without any other treatment). The second drying mode is based on the conclusions drawn from experimental results obtained in studies with uncontrolled heating at maximum power, as will be discussed below. The

Table 1. Material properties of the specimens used for the pilot study.

Type of clay	Geometry	\bar{r}_p (nm)	ρ_{bulk} (g cm^{-3})	ρ_{clay} (g cm^{-3})	φ (vol%)	\bar{X}_0 (-)
#1	rectangular	57.5	1.609	2.534	36.50	0.29
#2	cylindrical	30.5	2.006	2.523	20.50	0.19

drying experiments with intermittent heating were interrupted when the mass reduction during microwave heating approached $dM/dt \rightarrow 0$. Table 2 summarizes the experiments of the pilot study.

Figure 3 shows two samples from clay #2. The sample on the left is completely destroyed by a crack spanning it from top to bottom (Figure 3a). The figure exemplarily reveals the limits of microwave heating of wet clay and the importance of a careful heating management.^[24] It shows that already small specimens (with height 49 mm and diameter 33 mm) can be completely destroyed if the energy supply by microwave heating is not carefully controlled. The sample shown in Figure 3a is illustrative for drying with uncontrolled microwave heating at maximum power (800 W), as, for example applied in experiments 6–11 in Table 2. In certain cases, the cracks appeared already within the first 10 s of microwave heating (e.g. experiment 11). In rectangular samples we observed material spalling as well as smaller cracks along the surface (in agreement with the predictions of Ref. 25) However, while the cylindrical samples were always destroyed when drying with maximum power (experiments 6–11), the rectangular samples could remain intact for a much longer drying period (e.g. experiments 1,2,4). This is explained with the experimental setup and the profiles of the electromagnetic field inside the domestic microwave used in these experiments. More clearly, the samples were kept in constant position and additional technical equipment, such as mode stirrers, were not applied. As a consequence, hot spots could occur in the wet samples as exemplarily revealed in Figure 3b. The dry zones internal of the sample shown in Figure 3b are associated with spots of higher evaporation rates resulting from the hot spots evolving in the heterogeneous electromagnetic field. Obviously, the rectangular specimens from clay #1, with depth 49 mm, different lengths ranging from 25 to 78 mm and comparably small height of 25 mm, did not experience such hot spots in experiments 1,2,4, wherefore evaporation was less efficient than in the cylindrical samples. As a result, the rectangular samples remained intact for a much longer drying period. In addition to that, different temperature profiles are expected in the rectangular specimens: the maximum temperature is expected

Table 2. Overview of experiments from the pilot study with rectangular specimens of depth 49 mm, height 25 mm and different lengths as well as cylindrical specimens with diameter 33 mm and different heights.

Exp.	Clay	Size (mm ³)	M_s (g)	X_0 (-)	$T_{\text{clay},0}$ (°C)	$T_{\text{MW},0}$ (°C)	$T_{\text{clay,max}}$ (°C)	\bar{T}_{MW} (°C)	t_{dh}/t_r	Observ.
1	1	28 × 49 × 25	50.7	0.29	20	24	n.d.	n.d.	10 min	-
2	1	25 × 49 × 25	45.0	0.29	22	34	76	34	60s/5min	-
3	1	39 × 49 × 25	71.5	0.29	23	23	n.d.	n.d.	4.33 min	*
4	1	78 × 49 × 25	143	0.29	22	24	n.d.	n.d.	10 min	-
5	1	78 × 49 × 25	143	0.29	22	36	70	39	60s/5min	*
6	2	49 × 33	68.8	0.19	20	32	68	33	47 s	×
7	2	45 × 33	70.1	0.19	22	23	n.d.	n.d.	50 s	×
8	2	49 × 33	70.4	0.19	23	23	72	n.d.	1 min	×
9	2	49 × 33	71.0	0.19	21	22	59	27	40 s	×
10	2	49 × 33	72.6	0.19	22	23	44	n.d.	30 s	×
11	2	45 × 33	69.0	0.19	21	28	33	28	10s/5min	×
12	2	49 × 33	69.5	0.19	23	24	51	25.5	7s/10min	-
13	2	49 × 33	70.4	0.19	21	24	54	n.d.	6-10s/10min	-
14	2	49 × 33	70.8	0.19	23	26	42	n.d.	6-9s/10min	-
15	2	49 × 33	69.6	0.18	21	25	47	26	5-10s/5min	-
16	2	100 × 33	140	0.21	23	24	80	n.d.	6-10s/10min	-
17	2	49 × 33	70	0	23	22	180	n.d.	5 min	-

The column t_{dh}/t_r specifies the duration of dielectric heating t_{dh} and, if applied, the duration of the resting period t_r . During the resting periods the samples were kept under lab conditions without any other treatment. Parameters that have not been documented during experiments are indicated with n.d. The observations (observ.) are differentiated as follows: - no cracks, × material penetrating crack (Figure 3). *Material explosion.

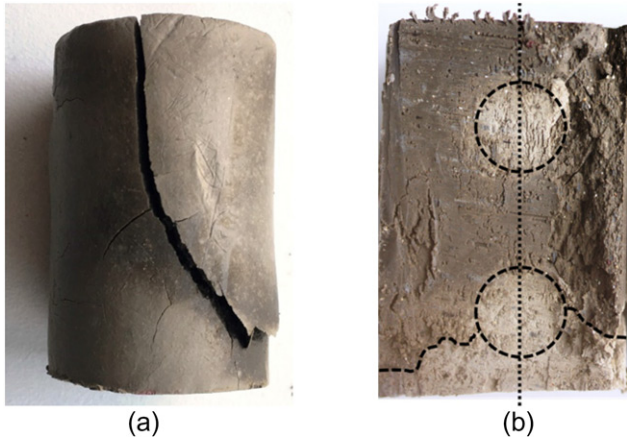

Figure 3. (a) Deterioration of a cylindrical sample of height 49 mm and diameter 33 mm by uncontrolled dielectric heating at $P = 800$ W. (b) Internal moisture distribution of a destroyed cylindrical sample with identical dimensions. The dark gray regions are related to higher moisture content and the light gray regions are assumed totally dry. The lines indicate the center line of the cylindrical sample as well as three drying fronts evolving in the core of the sample.

close to the surface of the material. This is also revealed by the different deterioration behavior. While the cylindrical specimens showed material penetrating cracks, the rectangular specimens revealed surface spalling cracks. These observations indicate the relevance of hot spots for the efficiency of the drying process and the occurrence of material damages as well. In addition to that, it is highlighted that in experiments summarized in Table 2 the sample surface temperature varied between 33 and 72 °C at the moment when the deterioration occurred, indicating that this phenomenon is not solely controlled by the maximum temperature. This is furthermore confirmed by

experiment 17, where no cracks were observed in the totally dry sample heated up to 180 °C in the microwave. Instead, as already discussed in Ref. 20, the internal processes of energy dissipation, its dependency on the moisture distribution and its impact on moisture transfer are expected to play a vital role for the drying performance.

Following this, the second drying mode was explored. In this, duration of microwave heating was drastically reduced to some seconds and combined with resting periods in which the samples were dried either at ambient conditions or with convective air flow (as will be discussed in the next section). In this mode, the intermittent heating with microwave was either with constant interval length (experiments 11–12 in Table 2) or with variable interval length (experiments 13–16). In experiments 15 and 16 also the sample bottom and top sides were swapped in each heating interval in order to allow a more homogeneous temperature distribution. It was found that duration of microwave heating could be slowly increased when the moisture content decreases; however, a more detailed study of the pore scale mass transfer conditions is still necessary to explain these observations.

In summary, the following conclusions can be drawn from the experimental observations presented in this section. Figure 3b indicates that the drying front is within the porous medium from the start of drying (light gray), while the regions at the surface of the porous medium are predominantly wet (dark gray). More clearly, evaporation occurs at the surface of the brick as well as within the wet zones and at the drying fronts emerging in the center of the brick.

From Figure 3b it is anticipated that higher evaporation rates are found in the core of the sample, where depending on the penetration depth maximum energy is dissipated by the water dipoles. This leads to the development of dry zones around the spots of maximum energy dissipation. As can be seen in Figure 3b two distinct drying fronts with almost radial geometry develop along the center line of the cylindrical sample: one drying front develops in the upper half and the second drying front develops in the lower half of the sample. The distance between the two center points of the radial fronts (i.e. the origins) is approximately 2.5 cm. The lower radial front merges with a third front that develops from the bottom of the sample as a result of contact heating of the bottom surface. Note that the magnetron is located perpendicular to the sample axis. The emerging vapor flows either slowly through the wet zone between the center line and the surface (dark gray zone in Figure 3b), provided that this zone is only partially saturated, or it is trapped inside the radial dry zones. Since the rate of phase transition is orders of magnitude higher than vapor transport, pressure rapidly increases in the radial dry zones leading to a pressure build up at the radial drying fronts. According to Ref. 13, the increase of pressure internal of the porous medium must lead to the expulsion of liquid which becomes the major mass transfer process towards the surface as long as the liquid phase is interconnected and provides a continuous flow path. Due to this the surface can remain wet while the core of the sample dries. However, if the liquid phase is weakly connected or if it becomes disconnected, liquid expulsion is interrupted leading to the stagnation of drying front expansion. At the same time, evaporation at the hot spots accelerates as the temperature increases further. This leads to further increase of pressure until the crack of the sample occurs.

A similar effect is expected in samples in which the drying front recedes from the surface, as, for example, in the rectangular specimens. If the distance between the drying front and the surface has reached a critical value, the ratio between the vapor transport through the dry zone (basically decreasing) and the evaporation rate (increasing) exhibits a minimum value at which the pressure at the evaporation front becomes high enough to induce material stresses that can lead to the rupture of the material. It is highlighted that this effect vitally depends on the size and geometry of the sample, moisture distribution, pore sizes and porosity, mechanical strength as well as distribution of the electromagnetic field.



Figure 4. Internal moisture distribution in a sample dried with controlled microwave heating. The picture was taken after a total drying time of 122 min (exp. 14). (Image from Ref. 20)

If the samples are small enough, they might be dried with a greater heating rate without material alteration. Also smaller material thicknesses or higher porosities (as usually found in microwave dried ceramics) allow for higher evaporation rates without material deterioration.

Alternatively and further magnified by the results presented in the next section, limitation of microwave heating by application of the intermittent drying mode and combination with a longer period of convective drying facilitates homogenization of moisture distribution (Figure 4). This is explained by two effects: At first, interruption of internal heating results in temperature equalization between hot and colder zones of the porous material. At second, the vapor pressure build up in the hot zones is equalized either by vapor transport or by condensation of vapor. (See Ref. 23 for a detailed study of pore scale vapor diffusion accompanied by condensation). Consequently, the development of internal drying fronts is not observed in this heating mode. Instead the liquid moisture is predominantly homogeneously distributed inside the porous sample, provided that the geometrical arrangement of the sample is optimized accordingly. In addition to that, experiments 13–16 have shown that length of the heating intervals can be increased with decreasing moisture content without material deterioration, demonstrating that the moisture content and pore scale mass transfer dictate the drying performance rather than the maximum product temperature. The heating procedures of these experiments are shown in Figure 5. Furthermore, Figure 6 shows the temperature profiles from experiment 14. They were measured by a thermocouple inserted into the top and the bottom side of the sample with a depth of 5 mm during the resting interval (immediately after interruption of microwave heating). The curves correlate with the protocols of intermittent heating (Figure 5) and indicate that the average

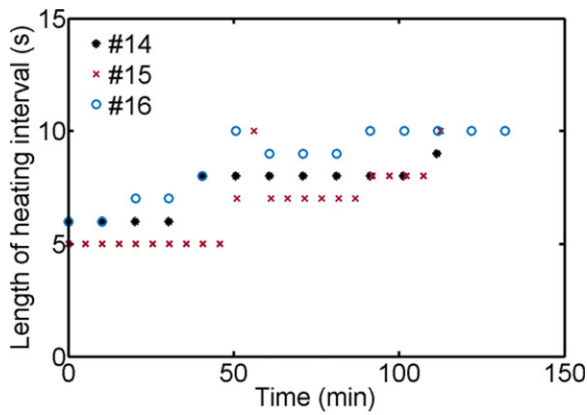

Figure 5. Protocol of the duration of the heating intervals in experiments 14–16.

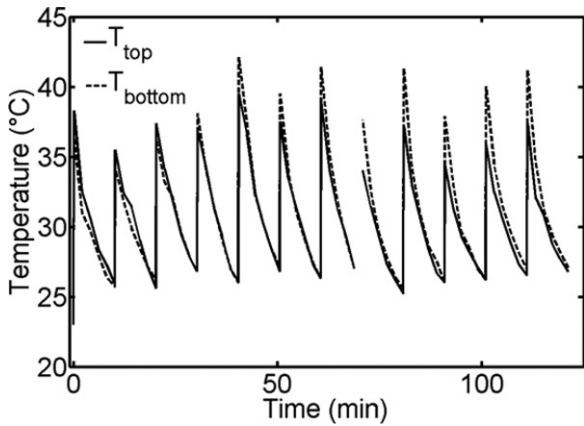

Figure 6. Temperature evolution in a sample with fixed position (experiment 14) (image from Ref. 20). Temperatures were measured with a thermocouple of type K brought into samples at bottom and top side by around 5 mm.

temperature of the sample as well as maximum and minimum temperature are almost constant during the experiment. The maximum temperature was around 42°C. It was detected inside the bottom side after increasing the length of the heating interval from 6 to 8 s (around 40 min after start of the experiment).

Figure 7 shows the drying curves of experiments 14–16 estimated by gravimetrical measurements. In experiments 14 and 16 the mass was detected continuously with a rate of $1/120\text{ s}^{-1}$. In experiment 15 the mass was detected once during the heating interval and once during the resting interval. Accordingly, the decrease of moisture content appears more unsteady when referring to experiments 14 and 16. In detail, the moisture content decreases with different slopes during the microwave heating interval and the resting interval. This is also revealed in Figure 8 where the drying rate is plotted against the moisture content. Apart from that, the drying curves decrease almost linearly during most of the drying experiment. Decrease of the slope at low water contents ($X \cong 0.15$

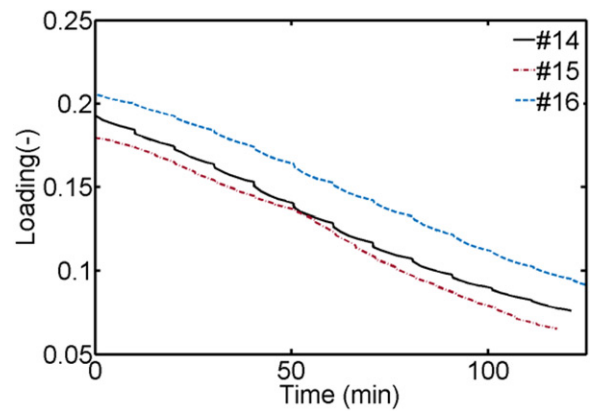

Figure 7. Drying curves from experiments 14–16 reveal almost linearly decreasing trends until low moisture contents of around $X \cong 0.15$ to 0.1.

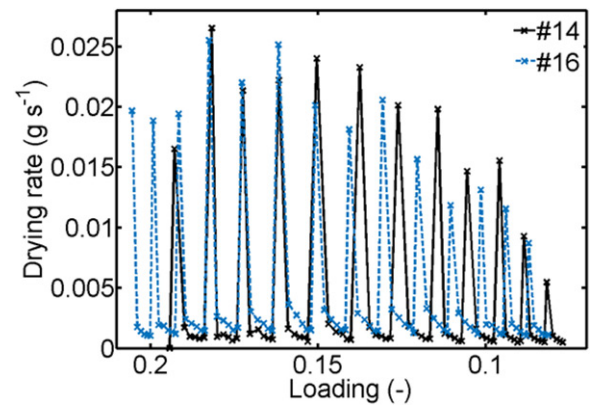

Figure 8. Drying rate curves from experiments 14 and 16. Note that the loading decreases from left to right.

to $X \cong 0.1$) indicates the transition of drying regimes. This is also reflected by Figure 8 which shows an overall decrease of drying rates during the heating intervals (i.e. the peak of the curves tend to smaller values) for moisture contents $X \leq 0.15$. The experiments were interrupted in this transition period. Besides this, a significant alternation of drying rates is observed. In detail, the drying rates are high during the short intervals of microwave heating and decrease drastically during the resting periods. Interestingly, a correlation between the maximum height of drying rates during the heating intervals and the increase of the length of the heating intervals is found. Exemplarily, the drying rate increases slightly in experiment 14 during the 5th interval of microwave heating (when duration of the heating interval is increased from 5 to 8 s). The maximum drying rate correlates also with maximum product temperature which was measured in this moment. In experiment 16 the heating intervals were extended during the 3rd interval (from 6 to 7 s) and during the 5th interval (from 7 to 8 s) as well as during the 6th interval

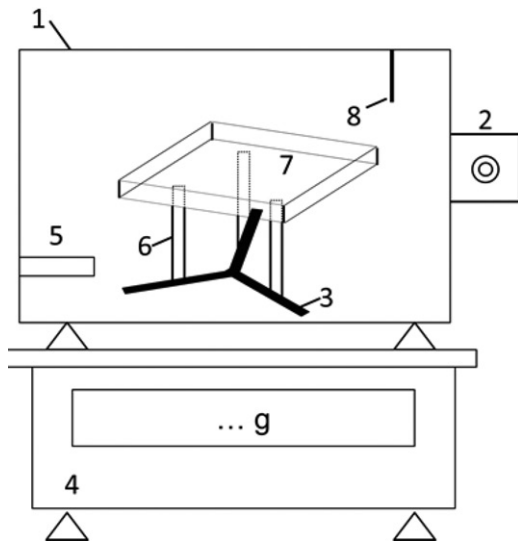

Figure 9. Sketch of the experimental set-up. (1) Microwave housing, (2) magnetron, (3) rotator, (4) balance, (5) air supply, (6) sample holders, (7) sample, (8) thermocouple.

(from 8 to 10 s) (Figure 5). The increase of drying rates in Figure 8 is in good agreement with this heating protocol.

In summary, increase of the duration of the heating intervals, which leads to increase of product temperature (as exemplarily shown in Figure 6), positively affects drying rates. It is assumed that the drying rates can remain on a higher level for a longer period of drying than compared to drying in which the heating intervals are not adapted. This observation is a key issue in control of absolute drying time and energy consumption and shall be investigated in a future work based on pore network modeling and drying experiments.

Finally, it can be concluded that the presented results are a very good base for the development of intermittent microwave drying processes as an alternative drying method for wet clay. Basically, the intermittent heating allows to rapidly increase internal temperatures (as a function of the duration of microwave heating and moisture content) and thus to overcome heat transfer limitations as usually faced in conventional drying processes. However, the outcomes of the pilot study also indicate that the energy supply must be carefully adjusted to prevent material damages. It was shown that the adjustment can be based on geometrical arrangement of magnetron and specimens as well as the combination of microwave heating and convective drying in a serial process. While the first option might partly be assisted by installation of, for example, rotators, it still appears somehow limited by the geometry of the specimens (roof tiles, clay blocks, facing bricks). The second option offers an

alternative possibility for the homogenization of the internal temperature profile because the heat generated during the short intervals of microwave drying can be distributed during the interval of convective drying. Additionally, mechanical stresses are relieved due to the pressure equalization within the porous medium (as a result of vapor transfer and condensation).

Combined intermittent microwave heating and convective drying

The same domestic microwave ($f=2.45$ GHz and $P=800$ W) was used for this study, but the experimental set-up and procedure were slightly modified (Figure 9). The samples were positioned on a horizontal rotator installed at the bottom of the microwave housing (Figure 9). The rotation speed was $\simeq 5$ min⁻¹. We used two different designs as sample holders: (i) a plane holder with a surface equivalent to the surface of the specimen and (ii) a three-armed rotator with PVC stick holders installed at each arm 45 mm from the center of the rotator (Figure 9). With the second design we were able to minimize the contact area between the specimens and the sample holder in order to enable drying from all sides. With this local surface warming of the specimens could additionally be minimized. Since the evolving temperature profiles inside the material depend on the penetration of electromagnetic waves into the material, both, the arrangement of the samples and the rotation speed have a crucial impact on drying. As will be shown and discussed below, the overall drying time can be reduced if the brick is vertically adjusted in front of the magnetron and additionally rotated.

The different clay materials used in this study are summarized in Table 3 and the experiments are summarized in Table 4. Specimens from clay #3 were from facing bricks and specimens from clay #4 were from roof tiles. It is highlighted that the specimens were rectangular in this study and thus closer to realistic geometries usually found in the brick producing industry. Additionally, the specimens from the roof tiles were flat with $100 \times 100 \times 20$ mm³ (the ratio of the in-plane diagonal to thickness was $\simeq 7$). The samples in experiments 18–22 were dried with the plane sample holder on which the samples were positioned with their largest surface (Table 4). In experiments 23–37 the stick holder was applied instead (Figure 9). In these experiments the samples were dried with different orientation, namely horizontally, experiments 23–25, and in upright position in front of the

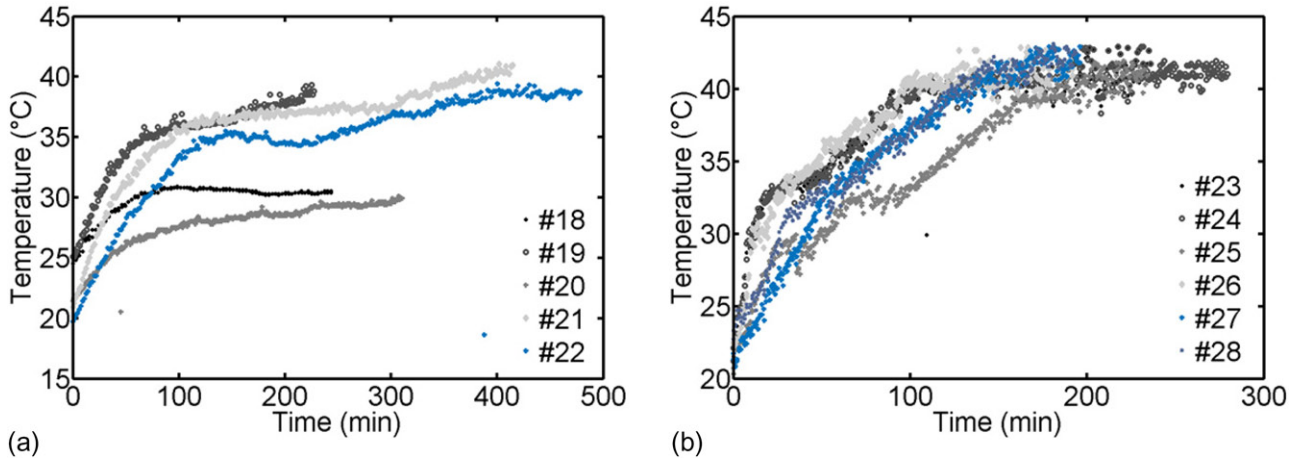

Figure 10. Average temperature inside the microwave drying chamber in experiments (a) 18–22 (clay #3) and (b) 23–28 (clay #4).

Table 3. Material properties of the specimens used in the study with combined intermittent microwave heating and convective drying.

Type of clay	Geometry	\bar{r}_p (nm)	ρ_{bulk} (g cm ⁻³)	ρ_{clay-3} (g cm ⁻³)	ϕ (vol%)	\bar{X}_0 (-)
#3	rectangular	27	2.021	2.602	22.31	0.18
#4	rectangular	13	2.020	2.578	21.63	0.19

magnetron, experiments 26–37 (Table 4). The samples were rotated with constant velocity, except in experiment 18, where the sample was not rotated but kept in constant position.

The drying experiments were realized with convective dry air with a dew point temperature of -15°C , varying temperature between around 20°C (experiments 18–34) and 40°C (experiments 35–37) as well as different volume flow rates as specified in Table 4.

Procedure of the drying experiments followed a fixed scheme, developed based on the findings of the pilot study presented above. Basically a serial combination of intermittent microwave heating and convective drying at low temperature level was applied. In the present study we applied the heating intervals depicted in Table 4 (denoted as t_{dh}/t_r) as they allowed for moderate drying without product damages within a reasonable drying time. The whole drying process was carried out inside the microwave. In addition to this, samples with similar initial mass and loading were dried purely convectively with warm air at 40°C using the same setup but without any microwave heating (refer to black lines in Figure 13). Note that drying without dielectric heating was comparably very slow. Due to this, drying in the microwave chamber was interrupted already at higher moisture contents of around $X \cong 0.03$ to $X \cong 0.02$. (The final saturation was obtained in an drying oven from Memmert). Experiments 18–34 were conducted with cold air

($T \cong 20^\circ\text{C}$) (Figure 10a,b), whereas in experiments 35–37 we applied warm air with $T = 40^\circ\text{C}$. The drying curves were estimated with a balance of type Sartorius MC1 IC64 410 S (precision 1 g). The drying experiments were stopped when the mass reduction during microwave heating approached $dM/dt \rightarrow 0$ for more than 10 heating intervals. After each drying experiment, the specimens were heated up to $T = 100^\circ\text{C}$ for 24 h in an oven (Memmert) to remove residual moisture and to obtain the dry mass of each sample. Note that in experiments 18–22 microwave drying was stopped already at higher moisture contents when $dM/dt \rightarrow 0$. As the loss factor of the clay material is around factor 10 smaller than that of water, the decrease of the water content drastically decreases efficiency of microwave heating. Additionally, the vapor transfer resistances increase, leading to deceleration of drying. As a consequence, the drying process becomes very slow in the second drying period, when most of the water is already removed and when furthermore the drying front has receded into the porous material. In these experiments, a significant amount of water was removed during the subsequent drying in the oven. In experiments 23–37 instead, water was completely removed during microwave drying because principally the drying rates remained on a high level until the end of drying. This is explained with the small thickness of the specimens and the expected relatively lower vapor transfer resistances in the second drying period.

Due to the different treatment of samples in experiments 18–22 and 23–37, shrinkage of the specimens was estimated differently. In experiments 18–22, shrinkage was determined from the volume reduction during microwave drying (V/V_0 (MW)) and from the volume reduction during the subsequent oven drying (V/V_0 (dry)), whereas in experiments 23–37 shrinkage

Table 4. Summary of drying experiments with combined intermittent microwave heating and convective drying.

Exp.	Clay	$L \times D \times H$ (mm ³)	M_s (g)	X_0 (-)	\dot{V}_{air} (l min ⁻¹)	$T_{air,0}$ (°C)	\bar{T}_{MW} (°C)	Orientation	t_{th}/t_r	V/V_0 (MW)	V/V_0 (dry)
18	3	123 × 60 × 65	889	0.18	5	≈25	30	horizontally	5s/3min	0.96	0.93
19	3	123 × 60 × 65	908	0.17	6	≈25	35	horizontally	5s/1min	0.94	0.92
20	3	123 × 60 × 65	873	0.17	6	≈21	28	horizontally	3s/1min	0.97	0.95
21	3	123 × 60 × 65	838	0.19	6	≈22	36	horizontally	5s/1.5min	0.93	0.92
22	3	123 × 60 × 65	841	0.19	6	≈20	34	horizontally	5s/1.5min	0.94	0.93
23	4	100 × 100 × 20	332	0.19	6	≈25	38	horizontally	5s/1min	–	0.83
24	4	100 × 100 × 20	359	0.19	6	≈25	38	horizontally	5s/1min	–	0.81
25	4	100 × 100 × 20	341	0.19	6	≈25	35	horizontally	5s/1min	–	0.77
26	4	100 × 100 × 20	331	0.19	7	≈22	37	vertically	5s/1min	–	0.86
27	4	100 × 100 × 20	347	0.19	7	≈21	35	vertically	5s/1min	–	0.88
28	4	100 × 100 × 20	376	0.19	7	≈22	36	vertically	5s/1min	–	0.88
29	4	100 × 100 × 20	326	0.18	7	≈25	39	vertically	3–7s/1min	–	0.88
30	4	100 × 100 × 20	315	0.19	7	≈25	40	vertically	5–7s/1min	–	–
31	4	100 × 100 × 20	312	0.19	7	≈25	40	vertically	5–7s/1min	–	–
32	4	100 × 100 × 20	394	0.19	35	≈25	36	vertically	5s/1min	–	0.88
33	4	100 × 100 × 20	404	0.18	35	≈25	36	vertically	5s/1min	–	0.88
34	4	100 × 100 × 20	356	0.19	35	≈25	36	vertically	5s/1min	–	0.89
35	4	100 × 100 × 20	343	0.18	35	≈40	53	vertically	5s/1min	–	0.88
36	4	100 × 100 × 20	367	0.19	35	≈40	53	vertically	5s/1min	–	0.87
37	4	100 × 100 × 20	350	0.19	35	≈40	52	vertically	5s/1min	–	0.87

Clay from Table 3, with length L , depth D and height H .

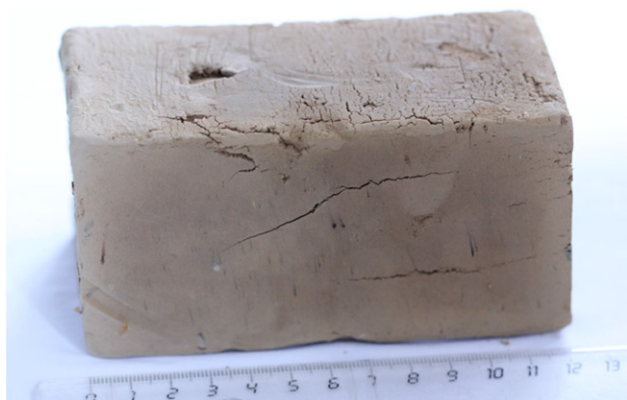

Figure 11. Specimen from clay # 3 dried with intermittent dielectric heating of 10 s combined with convective drying of 10 min. Cracks are observed at the surface of the sample.

was determined only from the volume reduction during microwave drying (V/V_0 (dry)) (Table 4). Note that the average volume reduction was estimated based on the measurement of the length reduction of the 12 sides of the samples.

The limits of the study are shown in Figure 11. Small cracks along the surface of specimen from clay #3 were observed in experiments with intermittent heating of 10 s (in serial combination with 10 min convective drying) and 7 s (and 3 min convective drying) as well as 5 s/1 min and 5 s/1.5 min when the sample was not rotated (these experiments are not shown in Table 4). Instead no material deterioration was observed when duration of the heating interval was reduced and when the sample was additionally rotated (experiments in Table 4).

Figure 12 shows the drying curves obtained from experiments with clay #3 (Figure 12a) and clay #4

with similar air flow rate (Figure 12b). The most striking difference between the two figures is the overall drying time. Specimens from flat roof tiles in Figure 12b could be dried completely within less than 210 min. Furthermore, the drying time was slightly shorter if the specimens were placed in vertical position on the rotating arms, thus with expected higher impact of electromagnetic waves from the magnetron on the samples and additionally with a higher availability of the sample surface for the transport of vapor. In contrast, the moisture content of the comparably thick specimens of clay #3 could only be reduced by half within the same time (Figure 12a). This is explained with the greater total mass of water initially contained in specimens from clay #3, but also with greater thickness and the associated higher moisture transfer resistances at lower moisture contents. Anyways, in comparison to that, drying of the clay samples only in the oven (Mettler) operating at $T = 40^\circ\text{C}$ revealed drying times of around 96 h (clay #3) and 117 h (clay #4).

Figure 13 compares intermittent microwave drying with higher air flow rates (35 l min^{-1}) with purely convective drying in the same setup. As can be seen, drying assisted by intermittent microwave heating is about factor 5 faster than convective drying. Note that the residual moisture, $X \leq 0.03$ to 0.02 , in the purely convectively dried samples was removed at 100°C . It can also be seen that neither the increase of the air flow rate nor the increase of the air temperature affects microwave drying of the samples; instead very similar drying times as in Figure 12 are found in Figure 13a (compare blue and gray curves of Figure 13a with Figure 12b). This indicates the potential of

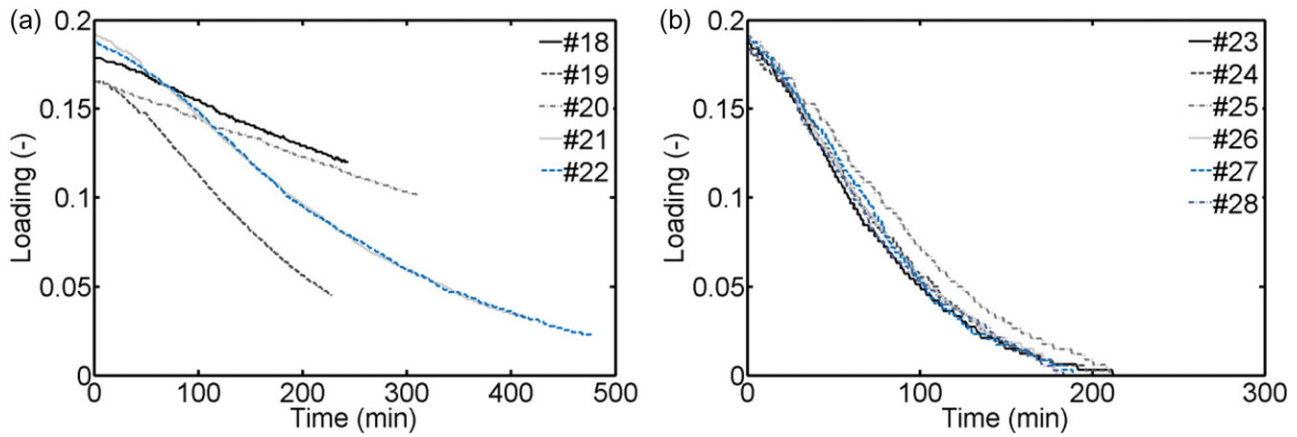

Figure 12. Drying curves from experiments (a) 18–22 (clay #3) and (b) 23–28 (clay #4).

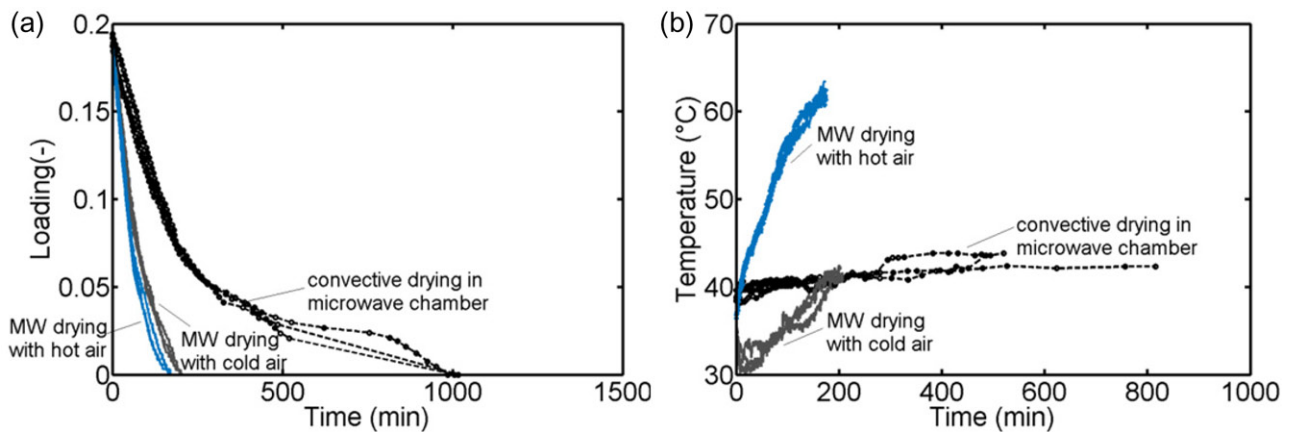

Figure 13. (a) Drying curves from experiments 32–37 in comparison to convective drying experiments carried out inside the microwave drying chamber, but without dielectric heating, at similar temperature of $T \cong 40^\circ\text{C}$. The gray curves represent experiments 32–34 with $T_{\text{air}} = 20^\circ\text{C}$ (indicated as MW drying with cold air) and the blue curves show experiments 35–37 with $T_{\text{air}} = 40^\circ\text{C}$ (indicated as MW drying with hot air). The black curves correspond to the reference drying experiments without dielectric heating. (b) Temperature profiles.

the optimization of the overall energy efficiency of the drying process.

In general, the acceleration of the drying process is explained with the instantaneous heat supply to the evaporation front and the temperature gradient dependent moisture transfer by capillary liquid pumping, as long as the liquid phase is macroscopically continuous and interconnected with the surface of the porous medium. Pressure build up and liquid expulsion though are excluded at the low heating rates. If, however, liquid connectivity to the surface is interrupted, vapor diffusion dominates pore scale mass transfer, similar as in convective drying, leading to the deceleration of the drying process. Wet patches observed at the bottom of the samples of clay #3 (sealed by the sample holder during drying) indicate that in absence of liquid connectivity to the open surface the vapor diffusion kinetics limit the drying process with low microwave power. This is explained

with internal vapor transfer resistances which limit the drying performance when the distance between the liquid moisture inside the product and the product surface becomes sufficiently large and it is associated with the low vapor permeability of the small pores. For this reason, we have interrupted drying when the drying rates became unreasonably low. The deceleration of drying is revealed by Figure 12 where the slopes of the drying curves change at the transition from the first drying period with almost constant drying rates to the second drying period with decreasing drying rates. We found on average a maximum drying rate of 0.2 g s^{-1} , which is, however, in the range of the precision of the balance. This shows that drying with intermittent microwave heating is only efficient as long as liquid moisture remains close to the product surface; the thin specimen from roof tiles dried much faster than the specimen from the facing bricks.

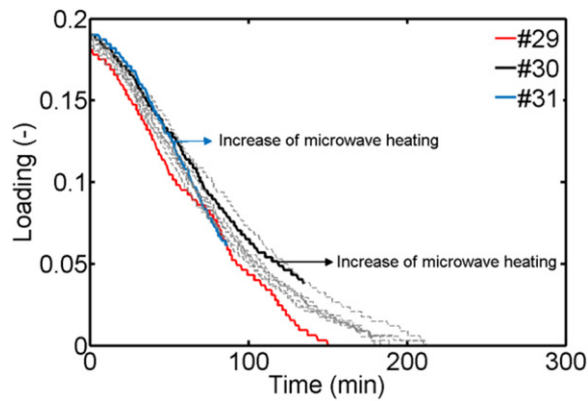

Figure 14. Impact of duration of the heating interval on drying kinetics of clay #4 (experiments 29–31): the moisture content can be reduced with a greater drying rate, if duration of the heating interval is increased from 5 to 7 s already at $X=0.13$ (Exp. 31) whereas increase of the duration at lower moisture content, $X=0.05$, has no obvious impact on drying kinetics (Exp. 30). The drying experiments were stopped when both samples cracked in the microwave. In experiment 29 the heating interval was randomly varied between 3 s and 7 s already from the start of drying. (The gray curves are from Figure 12b, Exps. 23–28).

The critical moisture content, at which the drying rates dropped to a lower level was around $X = 0.1$ to $X = 0.08$ in clay #3 (experiments 19, 21, 22) and $X = 0.09$ to $X = 0.05$ in clay #4 (experiments 23–28). These results are very similar to oven drying, where the critical moisture content was around $X = 0.015$ – 0.06 (clay #3) and $X = 0.07$ (clay #4). However the critical moisture contents were achieved within significantly shorter time when the samples were dried with microwave heating. Exemplarily, in the oven the transition occurred between 14 and 48 h (clay #3), which is around 4–12 times longer than drying with intermittent microwave heating at the same temperature level. This result is indeed encouraging as it shows that at least similar good moisture transport conditions are achieved with microwave drying as with very slow and conservative drying of the clay using the reference drying method (oven at $T = 40^\circ\text{C}$) although the drying time is much shorter. In addition to that, in general slightly lower critical moisture contents could be obtained for overall smaller slopes of the drying curves, that is, if microwave drying was overall slower from the start.

Interestingly, the drying curves in Figure 14 indicate that drying can be even more accelerated if duration of the heating intervals is successively increased (from 5 to 7 s). Obviously, the faster decrease of moisture content is achieved if the heating interval is extended already at high moisture contents whereas

no significant improvement of the drying curve is found if duration of the heating interval is increased at lower moisture contents. This drying mode can be seen as a remedy for the drying performance of clay #3 as it allows sustaining high evaporation rates for a longer time period. Unfortunately, the risk of cracks is higher if energy supply is increased (as indicated by the blue and black curves in Figure 14). This reflects the demands of a careful heating management in microwave drying of wet clay. But it also shows the potential to decrease drying time significantly compared to conventional convective drying.

Finally, Table 4 indicates that shrinkage of clay #3 is higher if the convective drying interval is longer (except in experiment 19). Accordingly, the lowest size reduction was found for drying with 3 s intermittent heating and 1 min convective drying. In comparison to that, we found a ratio of $V/V_0 = 0.88$ to 0.91 in oven drying (clay #3), thus a slightly greater volume reduction. Clay #4 revealed overall greater shrinkage if the samples were dried in horizontal position inside the microwave (experiments 23–25). Less shrinkage was instead observed if clay #4 was dried in vertical position (experiments 26–37). Drying clay #4 only in the oven revealed a ratio of $V/V_0 = 0.87$, thus similar to the realization with microwave drying and vertical position of the samples. These results show again that with microwave drying at least the same good product quality as with very slow and conservative drying (oven at $T = 40^\circ\text{C}$) can be achieved within considerably shorter drying time. Exemplarily, the drying of clay #4 in the microwave was around 200 min whereas the drying time in the oven was around 117 h, thus 35 times longer.

Summary and discussion

We have shown by an experimental study, using a domestic microwave, that convective drying of wet clay can be drastically accelerated by intermittent microwave heating if it is carefully controlled based on an analysis of the pore scale moisture and temperature distribution and vapor transport kinetics during drying (e.g. Refs. 19, 26, 27). Experiments from the pilot study indicate that the appearance of hot spots can lead to a local increase of vapor pressure and liquid expulsion. If, however, the liquid phase is disconnected and the evaporation rate much higher than the vapor flow rates through the partially saturated zone, the local increase of pressure can exceed a critical value which finally results in the deterioration of the product. This can already occur after a few

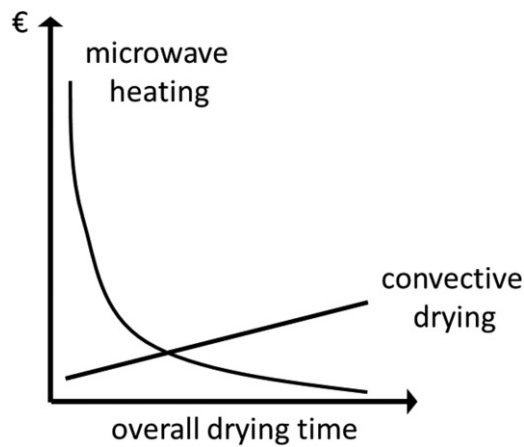

Figure 15. Assessment of the energy efficiency of convective drying assisted by intermittent microwave heating. The decrease of drying time can be achieved by longer intervals of microwave heating. However, the energy efficiency is limited by the limitation of the loss factor at low moisture contents (e.g. Ref. 10)

seconds of microwave heating if the microwave is operated at high power ($P = 800 \text{ W}$). This is based on the material, geometry and dielectric properties. We found that the occurrence of material deterioration is not dictated by the maximum temperature (the clay can in principle be heated up to 1200°C in the firing process) but rather by the moisture content and the size of the sample, from which it can be concluded that process control should take into account the mass transfer processes in the porous product additionally to the temperature data.

Based on this finding, we have proposed to limit the heat supply by the electromagnetic field and to allow for homogenization of the vapor pressure field between the heating intervals. In fact, we have proposed a new drying method of serial combination of very short intermittent microwave heating and convective drying. In the optimum drying procedure, duration of the heating interval is only a few seconds ($<10\text{s}$) while duration of the resting interval is up to several minutes. In contrast to previous studies^[6] we could achieve very good product quality if the samples were additionally rotated. We assume that similar observations can be found in drying with overall lower maximum microwave power.

In summary we could show that drying with intermittent microwave heating allows for similar good moisture transfer conditions as very conservative drying with low temperature and low overall drying rates at sustained product quality and within a drying time that can be at least one order of magnitude smaller than compared to the alternative drying method.

Outlook

Our experimental study involved specimens with relatively small size compared to the size of real clay products (e.g. roof tiles or bricks). As the critical drying phenomena, such as the localized pressure build up, liquid expulsion and material deterioration, depend on the size of the specimens, material properties and the properties of the electromagnetic field, future work addresses the transfer of the lab-scale experiments to the product scale (by application of an industrial scale microwave dryer). Additionally, so far we have studied relatively simple geometries (cylindrical, rectangular); however, roof tiles for example can have complex geometries (e.g. interlocking joints) and shall be studied in more detail in future.

The energy efficiency of convective drying assisted by intermittent microwave heating is one of the main issues. In the best case, material properties of the product are improved at reduced drying time and reduced overall energy consumption. As shown in Figure 15, microwave heating is currently much more expensive than convective drying. The best tradeoff consists of minimizing the electrical energy demanded for the operation of the microwave at maximum reduction of drying time. In this regard, optimization of the drying process, in terms of the duration of the heating and the resting intervals, might involve pore network studies of mass and heat transfer in future work (e.g. Refs. 17, 19, 27). Pore network models are especially suitable to study processes where simultaneous evaporation (in the core of the sample) and condensation (of vapor flowing towards the cold surface) leads to a hysteresis of the gas-liquid phase distributions. They offer also a very nice tool to study the formation and the effect of local hot spots.^[26]

Acknowledgements

We greatly acknowledge the contributive work of Niloofar Mirsadraee, Christin Velten and Aiham Adi, who jointly participated in this project in the frame of students work.

Notation

E	electric field strength V m^{-1}
f	frequency Hz
D	depth m
H	height m
L	length m
M	mass kg
M_s	dry mass of solid kg
P	power W
r_p	pore radius m
R	sample radius m

t	time s
t_{dh}	duration of dielectric heating s
t_r	duration of resting period s
T	temperature K
X	moisture content (dry base) kg kg ⁻¹
ϵ	permittivity A s V ⁻¹ m ⁻¹
ϵ'	relative permittivity A s V ⁻¹ m ⁻¹
ϵ''	loss factor -
ρ	density kg m ⁻³
φ	porosity -

Subscripts

0	initial value (moisture content, temperature)
MW	microwave

Subscripts

–	average value
---	---------------

References

- [1] Junge, K.; Telljohann, U. Energy Demand for the Production of Bricks and Tiles: Decoupling of Kiln and Dryer by Preheating of Combustion Air and Intermediary Storage of the Combined Heat. *ZI Ziegelind. Int.* **2002**, *55*, 12–22.
- [2] Meng, P.; Specht, E.; Tretau, A.; Rimpel, E. The Solid-Solid-Recuperator Tunnel Kiln for Energy Conserving Firing of Facing Bricks and Roof Tiles. Annual for the Brick and Tile, Structural Ceramics and Clay Pipe Industries, Bauverlag, Germany, **2012**, pp. 89–100.
- [3] Tretau, A. Einfluss der Prozessführung auf den thermischen Energiebedarf von Konvektionstrocknern in der Ziegelindustrie, PhD Thesis, Otto von Guericke University, Magdeburg, Germany; **2008**.
- [4] Redemann, T.; Specht, E. Mathematisches Modell zur Untersuchung des Einflusses von Umwälzern auf den Ofenprozess von Dachziegeln. 1. Aachener Ofenbau- und Thermoprocess Kolloquium., Aachen, Germany, May 11–12, **2017**. ISBN 978-3-95886-165-7
- [5] Ackermann, C.; Gauglitz, R.; Hennike, H. W. Das Bourry-Diagramm und die Trockenschwindung trocken verpresster Massen. IX. Int. Keram. Kongr. Brüssel, **1964**, pp. 115–123.
- [6] Junge, K.; Tretau, A.; Petereit, S.; Popken, S. Microwave Drying: Not an Alternative for the Drying of Shrinking Green Products. *ZI Ziegelind. Int.* **2005**, *58*, 8.
- [7] Schiffmann, R. F. Microwave and dielectric drying. In: *Industrial Handbook of Drying*, 4th ed., Mujumdar, A. S., Ed.; CRC Press: Boca Raton, **2015**.
- [8] Rattanadecho, P.; Makul, N. Microwave-assisted Drying: A Review of the State-of-the-Art. *Dry. Technol.* **2016**, *34*, 1–38. DOI: [10.1080/07373937.2014.957764](https://doi.org/10.1080/07373937.2014.957764).
- [9] Gaukel, V.; Siebert, T.; Erle, U. Microwave assisted drying, In: *The Microwave Processing of Foods*, 2nd ed.; Regier, M., Knoerzer, K., Schubert, H., Eds., Woodhead Publishing Series in Food Science, Technology and Nutrition, Elsevier, Amsterdam, **2017**.
- [10] Jones, P. L.; Rowley, A. T. Dielectric Drying. *Dry. Technol.* **1996**, *14*, 1063–1098. DOI: [10.1080/07373939608917140](https://doi.org/10.1080/07373939608917140).
- [11] Feng, H.; Yin, Y.; Tang, J. Microwave Drying of Food and Agricultural Materials: Basics and Heat and Mass Transfer Modeling. *Food Eng. Rev.* **2012**, *4*, 89–106. DOI [10.1007/s12393-012-9048-x](https://doi.org/10.1007/s12393-012-9048-x)
- [12] Stammer, A.; Schlünder, E.-U. Mikrowellen-Trocknung: Grundlegende Untersuchungen und Scale-Up. *Chemie Ingenieur Technik* **1992**, *64*, 986–990. DOI: [10.1002/cite.330641104](https://doi.org/10.1002/cite.330641104).
- [13] Constant, T.; Moyne, C.; Perré, P. Drying with Internal Heat Generation: Theoretical Aspects and Application to Microwave Heating. *AIChE J.* **1996**, *42*, 359–368. DOI: [10.1002/aic.690420206](https://doi.org/10.1002/aic.690420206).
- [14] Wei, C. K.; Davis, H. T.; Davis, E. A.; Gordon, J. Heat and Mass Transfer in Water-laden Sandstone: Microwave Heating. *AIChE J.* **1985**, *31*, 842–848.
- [15] Perré, P.; Turner, I. W. Microwave Drying of Softwood in an Oversized Waveguide: theory and Experiment. *AIChE J.* **1997**, *43*, 2579–2595. DOI: [10.1002/aic.690431019](https://doi.org/10.1002/aic.690431019).
- [16] Ni, H.; Datta, A. K.; Torrance, K. E. Moisture Transport in Intensive Microwave Heating of Biomaterials: A Multiphase Porous Media Model. *Int. J. Heat Mass Transf.* **1999**, *42*, 1501–1512. DOI: [10.1016/S-9310\(98\)00123-9](https://doi.org/10.1016/S-9310(98)00123-9).
- [17] Huinink, H. P.; Pel, L.; Michels, M. A. J.; Prat, M. Drying Processes in the Presence of Temperature Gradients-Pore-Scale Modelling. *Eur. Phys. J. E Soft Matter.* **2002**, *9*, 487–498.
- [18] Plourde, F.; Prat, M. Pore Network Simulations of Drying of Capillary Porous Media. Influence of Thermal Gradients. *Int. J. Heat Mass Transf.* **2003**, *46*, 1293–1307. DOI: [10.1016/S-9310\(02\)00391-5](https://doi.org/10.1016/S-9310(02)00391-5).
- [19] Surasani, V.; Metzger, T.; Tsotsas, E. Drying Simulations of Various 3D Pore Structures by a Nonisothermal Pore Network Model. *Dry. Technol.* **2010**, *28*, 615–623. DOI: [10.1080/07373931003788676](https://doi.org/10.1080/07373931003788676).
- [20] Vorhauer, N.; Mirsadraee, N.; Tretau, A.; Bück, A.; Tsotsas, E.; Prat, M. Combined convective and microwave drying of wet clay, Proceedings of the 2nd Nordic Baltic Drying Conference, June 7–9 2017, Hamburg, Germany, **2017**.
- [21] Turner, I. W.; Jolly, P. C. Combined Microwave and Convective Drying of a Porous Material. *Dry. Technol.* **1991**, *9*, 1209–1269. DOI: [10.1080/07373939108916749](https://doi.org/10.1080/07373939108916749).
- [22] Itaya, Y.; Uchiyama, S.; Hatano, S.; Mori, S. Drying Enhancement of Clay Slab by Microwave Heating. *Dry. Technol.* **2005**, *23*, 1243–1255. DOI: [10.1081/DRT-200059487](https://doi.org/10.1081/DRT-200059487).
- [23] Vorhauer, N.; Tsotsas, E.; Prat, M. Temperature Induced Double Stabilization of the Evaporation Front within a Drying Porous Medium. *Phys. Rev. Fluids* **2018**, *3*, 114201.
- [24] Kowalski, S. J.; Rajewska, K.; Rybicki, A. Stresses Generated during Convective and Microwave Drying. *Dry. Technol.* **2005**, *23*, 1875–1893. DOI: [10.1080/07373930500210226](https://doi.org/10.1080/07373930500210226).

- [25] Dincov, D. D.; Parrott, K. A.; Pericleous, K. A. Heat and Mass Transfer in Two-phase Porous Materials under Intensive Microwave Heating. *J. Food Eng.* **2004**, *65*, 403–412. DOI: [10.1016/j.jfoodeng.2004.02.011](https://doi.org/10.1016/j.jfoodeng.2004.02.011).
- [26] Bück, A.; Dürr, R.; Vorhauer, N. Feedback control of microwave drying, In: Martynenko, A., Bück, A., Eds., *Intelligent Control in Drying*; CRC Press: Boca Raton, FL, **2018**.
- [27] Metzger, T.; Tsotsas, E.; Prat, M. Pore-network models: A powerful tool to study drying at the pore level and understand the influence of structure on drying kinetics, *Modern Drying Technology, Vol. 1: Computational Tools at Different Scales*; Tsotsas, E., Mujumdar, A.S., Eds.; Wiley-VCH: Weinheim, **2007**, pp. 57–102