



HAL
open science

Contribution for analysing the intra-ply yarn sliding mechanism in preforming of the woven fabric

Amad Labanieh, Christian Garnier, Pierre Ouagne, Olivier Dalverny, Damien Soulat

► To cite this version:

Amad Labanieh, Christian Garnier, Pierre Ouagne, Olivier Dalverny, Damien Soulat. Contribution for analysing the intra-ply yarn sliding mechanism in preforming of the woven fabric. Autex 2018 World Textile conference, Jun 2018, Istanbul, Turkey. hal-02359824

HAL Id: hal-02359824

<https://hal.science/hal-02359824>

Submitted on 12 Nov 2019

HAL is a multi-disciplinary open access archive for the deposit and dissemination of scientific research documents, whether they are published or not. The documents may come from teaching and research institutions in France or abroad, or from public or private research centers.

L'archive ouverte pluridisciplinaire **HAL**, est destinée au dépôt et à la diffusion de documents scientifiques de niveau recherche, publiés ou non, émanant des établissements d'enseignement et de recherche français ou étrangers, des laboratoires publics ou privés.



Open Archive Toulouse Archive Ouverte (OATAO)

OATAO is an open access repository that collects the work of some Toulouse researchers and makes it freely available over the web where possible.

This is an author's version published in: <http://oatao.univ-toulouse.fr/23144>

Official URL: <https://www.sciencedirect.com/science/article/pii/S1359835X18300186>

To cite this version:

labanieh, Amad and Garnier, Christian and Ouagne, Pierre and Dalverny, Olivier and Soulat, Damien Contribution for analysing the intra-ply yarn sliding mechanism in preforming of the woven. (2018) In: Autex 2018 World Textile conference, 20 June 2018 - 22 June 2018 (Istanbul, Turkey).

Any correspondence concerning this service should be sent to the repository administrator:

tech-oatao@listes-diff.inp-toulouse.fr

Contribution for analyzing the intra-ply yarn sliding mechanism in preforming of the woven fabric

A. R. Labanieh¹, C. Garnier², P. Ouagne², O. Dalverny², D. Soulat¹

¹*Génie et Matériaux Textiles (GEMTEX), ENSAIT, 2 allée Louise et Victor Champier, 59056 Roubaix, France.*

²*Génie de Production (LGP), ENIT, 47 avenue d'Azereix, 65016 Tarbes, France.*

Corresponding author: ahmad.labanieh@ensait.fr

Abstract Manufacturing complex composite part via Liquid Composite Molding (LCM) processes involves preforming dry textile perform before injecting the liquid resin. The defect that may be encountered within the textile structure during preforming step decreases the expected mechanical properties of the composite part. The intra-ply yarn sliding is a defect frequently observed during preforming of a woven preform but its mechanism is far from being fully understood. In this paper, a contribution for analyzing the mechanism of this defect and the influencing process parameters is presented. This analysis is based on an experimental study performed for one ply carbon fabric using a hemispheric punch. The effect of the ply orientation and blank holder force on the fabric behavior during preforming is evaluated regarding the required preforming force and yarn slippage. For the performed tests, it was obvious the impact of these two factors on the fabric behavior. The slippage phenomenon occurred in zones with low shear angles, for specific ply orientation. The fabric behavior has been analyzed by considering the evolution of the yarn tension which is related to the contact shear stress induced by sliding the fabric across the die and blank holder during preforming. Using an analytical model for the yarn tension in friction sliding, the influencing ply geometry and process parameters have been identified. Based on this analysis a solution relative the ply geometry to reduce the yarn tension is examined.

Keywords—Woven Fabric, Composite manufacturing, Preforming, Defect

I. INTRODUCTION

Liquid Composite Moulding (LCM) processes [1] offer a good compromise in terms of repeatability, production rates, low-energy consumption and low final cost [2] for manufacturing a complex composite parts. Preforming is the first step in this process. It is a difficult phase, and the physical mechanisms are complex because they depend on many parameters (shape of tools, characteristics of the preform, number and orientation of plies, loads applied, etc.). If the mechanical loadings (tension, shear, compression, bending, friction, etc.) to which the reinforcements are subjected during the preforming step have been well described in the literature [3]-[6], the generation and the control of defects are far from being entirely understood. Wrinkle is a frequent defect occurs at the macroscopic scale (preform scale). The origin of the wrinkle is related to the weak preform bending stiffness due to the possible inter-yarn slippage [8]. Several numerical [7] - [9] and experimental [10] - [12] studies were conducted to analyze the effect of the friction-based blank holder system on the wrinkles occurrence. This system induces high yarn tension on the preform that prevents wrinkles [13]. However, Nezami et al [14] underlined that this system or other technique may reduce wrinkles but induce other defects in the fabric such as parallel fiber distortions without gaps, fiber distortions with small/large gaps, filament damage, broken or pulledout roving. Except the filament damage, these defects are related to the lack of cohesion in the woven structure network and the possibility of intra-ply yarns slippage. Barbagello et al [15] noted the presence of measurable yarn slippages (up to a maximum that is around 10% of the total length of the yarns). In papers dedicated to the preforming of NCF fabrics [16], [17] intra-ply slippage between fibers has been observed, without solutions to prevent or reduce this defect qualified as irreversible in [17]. Except in these studies, few articles of the literature deal with this type of defect. In this paper, experimental preforming tests were conducted on a carbon twill weave fabric. The slippage phenomenon occurred in zones with

low shear angles, for specific ply orientation. Yarn tensions were analytically computed relatively to tools load to understand this slippage defect. The influence of the ply orientation and the ply dimension were experimentally studied to reduce tension in yarns and reduce this slippage. Finally, solution based on the geometry of tools was proposed to prevent this type of defect.

II. EXPERIMENTAL CONDITION

A. Forming machine

Experimental preforming machine developed at the GEMTEX laboratory [18], [19], which is illustrated in Fig 1, is used to conduct the preforming tests. The machine is composed of three basic parts: a punch and two square-shaped plates. The punch has hemisphere geometry (double curved surface) and its movement is controlled by a pneumatic actuator with a constant mounting speed (45 mm/sec). Both upper and lower plates are a square shaped plate with a circular hole in its center. The lower plate is fixed into position whereas the upper one is mobile, parallel to the punch axis. This allows the arrangement of the fabric ply between the two plates in the desired orientation. The upper plate is subjected to a normal pressure applied by four pneumatic actuators placed on the plate corners. This normal pressure is controlled by the pressure of the compressed air supplied to the actuators. The experiments were conducted with two operating pressures 0.025 and 0.075 MPa that correspond to normal forces by each cylinder equals to 77.9 and 233.7 N respectively, according to the actuator specifications. These operating pressures were chosen after a first preliminary set of test and are related to the appearance of the intra-ply yarn sliding defect. When the minimum operating pressure (0.025 MPa) is applied, no sliding defect occurs. From an applied operating pressure of 0.075MPa this defect takes place. The upper plate is considered as the blank-holder because it is the mobile plate and the normal force (P) is applied on its top surface, Fig 1. The force (P) is called the holder force all over this paper. The lower plate is considered as the die since it is fixed into position in this machine configuration.

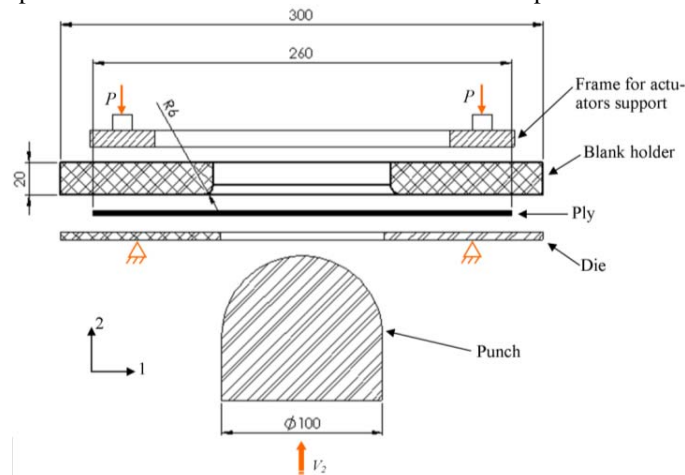

Fig 1: Forming machine scheme with characteristic dimensions. All dimensions are in mm.

For each experiment, the preforming force exerted by the punch is recorded as a function of the punch displacement. The force measurement is performed by means of a load cell mounted between the punch and the driving actuator. Also, the ply draw-in, border position and yarn arrangement after preforming are captured by a CCD camera. The camera is placed on the top side and its optical axis is aligned with the punch movement path.

B. Material properties and ply geometry

Commercial fabric “Hexcel HexForce 48600 U 1250” was used in this study to perform the experimental work. It is classified as a 2D woven fabric made with a twill 2/2 weaving architecture and constructed of 3.7 warps/cm and 3.7 wefts/cm with a nominal area density of 600 g/m² and a nominal thickness of 0.62 mm. The constituent yarns, both warp and weft, are “AS4 C GP 12K” high strength carbon fibres and they have a linear density of 0.8 g/m. Both yarns are not twisted and not powdered.

The forming tests were conducted using one ply of the woven fabric cut in a square shape with 260 mm side length. The tests were performed using two initial orientations (0° and 45°) of the fabric on the die as presented in Fig 2. The dashed lines sketched on the ply in Fig 2 represent the warp and weft yarns passing through the punch main axis and aligned with the radius of the hole. These yarns are called radial yarn in the next sections. On the 0° orientation ply, the warp and weft yarns are parallel to the plate side edges, Fig 2-a. For the 45° orientation, the warp and weft yarns

are parallel to the plate diagonal and they create an angle of 45° with plate side edge, Fig 2-b. The plies with 0° and 45° orientations are denoted across this paper as ply-0 and ply-45 respectively. One can note that the length of the portion of the radial yarns which is in contact with the two upper and lower plates is different for both orientations. In ply-0, a half of this length is marked as $L_0 = 68.6$ mm whereas in ply-45 it is marked as $L_{45} = 122.5$ mm as illustrated in Fig 2.

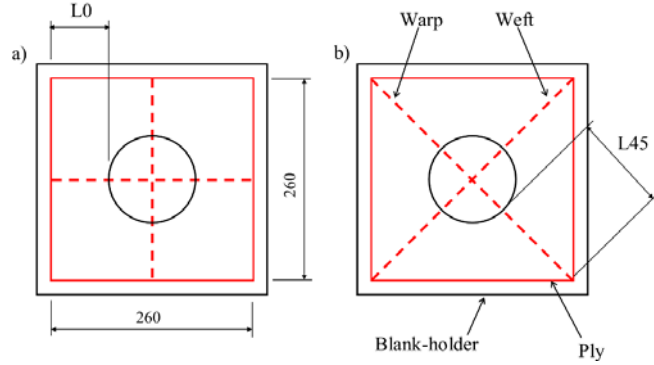

Fig 2: Dimensions and placement of the plies on the machine under the blank holder plate, ply-0 (a) ply-45 (b). Dashed lines represent the radial warp and weft yarns. All dimensions are in mm

III. RESULT

A. Preforming force

Fig 3 shows the preforming force as a function of the punch displacement for both ply-0 and ply-45 when preforming with the two operating pressures for the holder actuators. The experiments were repeated three times at the pressure (0.025 and 0.075 MPa) for both ply orientations. The mean value of the recorded force is presented on the graph with error bars pointing out the standard deviation of the measurements. It is clear from Fig 3 that the augmentation of the blank holder force causes the increase of the preforming force for both ply orientations. This is the results of a higher friction force standing against the ply sliding across the die and blank holder surfaces. The preforming of a ply with an initial 45° orientation requires higher effort in comparison to ply-0 in spite of similar blank holder pressure and identical initial ply dimension and shape as shown in Fig 2. The relative differences in the preforming force are about 56% and 63% for ply-0 at maximum displacement of the punch for the operating pressure of 0.025 MPa and 0.075 MPa respectively. The reason of this difference in the preforming force depending on the ply orientation for the performed test is investigated and discussed in the next sections.

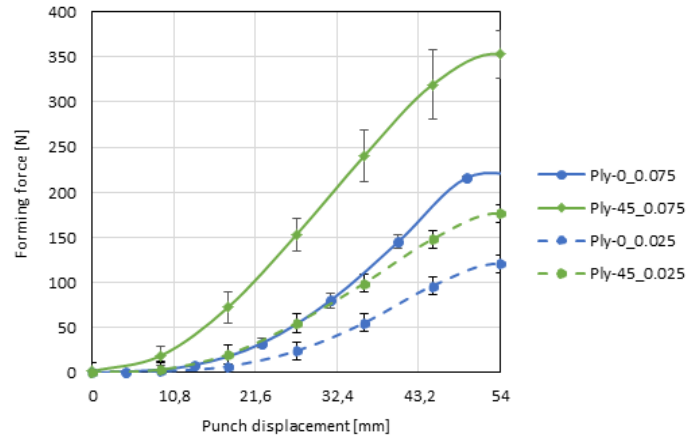

Fig 3: Preforming force for ply-0 and ply-45.

B. Intra-ply yarn sliding defect

Intra-ply yarn sliding defect is a loss of cohesion between the two orthogonal yarn sets constructing the woven ply [19]. It occurs when the applied efforts on a transversal yarn, such as axial tension or tangential friction force on the yarn exposed surface, overcomes the inter-yarn friction force, thus the transversal yarn is locked into position and the

longitudinal yarns slide across it. Length and width of the created gap between transversal yarns in addition to number of the involved yarns determine the amplitude of the defect.

For the preformed plies, the yarn sliding was observed when preforming ply-45 with 0.075 MPa operating pressure on the three tested samples. However, it was not remarked with lower pressure (0.025 MPa) nor for ply-0 with both applied operating pressures. The intra-ply yarn sliding occurred in the non-sheared zone of the ply on the rounded corner of the upper plate hole, Fig 4-a.

In order to characterize this defect, the yarns position after preforming and the local relative inter-yarn slippage have to be spotted. However, the carbon fibers are characterized by a light reflecting surface. Furthermore, the normal orientation and altitude of the useful part (3D deformed) of the ply surface change during the preforming process. Therefore white dots have been speckled on the apparent yarn surface with an alternative pattern (one with a dot and one with no dot), Fig 4-b. The dots have been speckled over a diagonal portion of the ply, as shown in Fig 4-a, where the defect is expected to take place. To distinguish between longitudinal and transversal yarns over this diagonal part, round (red) and cross (blue) marks were superimposed to the white dots on the treated photos.

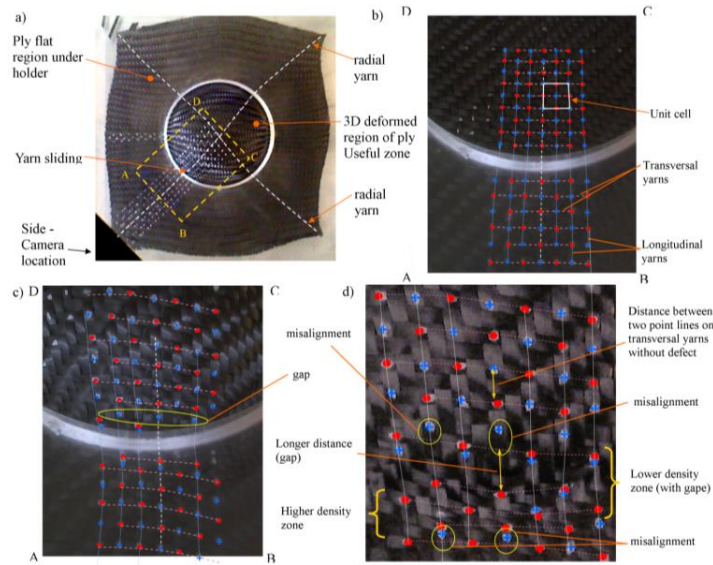

Fig 4: intra-ply yarn sliding on ply-45 after preforming with 0.075MPa operating pressure. Top view (a), zoomed portion (ABCD) before preforming (b), after preforming (c) and zoom on the defect zone after removal of the blank-holder plate (d).

On the zoomed rectangle zone ABCD defined in Fig 4-a, the yarn slippage defect is expected to take place. The yarns arrangements were observed before and after preforming. Before preforming, that corresponds to the initial planar state of the ply (Fig 4-b), the yarn count per unit length is uniform (same distance between dots). Furthermore, the dots belonging to the transversal yarn are aligned with the corresponding longitudinal yarns. The path of the longitudinal yarns was determined by spline connecting the dots. Similarly, the dots belonging to the longitudinal yarns are also aligned with corresponding transversal yarns.

After preforming, corresponding to the final state of the ply Fig 4-c and d, intra-ply yarn sliding defect occurs on the non-sheared region along the radial yarns on the holder corner when the ply exits from the die-holder zone. Out of the defect region (Fig 4-d), there is no disarrangement or misalignment between the two yarn sets. The longitudinal yarn dots remain aligned with transverse yarn indicating that no yarn sliding takes place. In the defect region, two zones are distinguished: high-density and low-density zone of the transversal yarns. On the first one (towards the 3D deformed zone), a gap is created between the last transverse yarn brought by the radial yarn and the next one. About 7 successive transverse yarns along the same radial yarns contribute to this defect and it is expanded across 11 longitudinal yarns. The first transversal yarn from the useful zone side shows the maximum bending. It is therefore associated to a large gap. Below the blank-holder, the transversal yarns accumulate creating a high density zone. This accumulation of the yarns increases the inter-yarn contact pressure between the two interlaced yarn sets on the crossing areas leading to stop the yarn slippage. Out of the defect region, a moderate misalignment is also observed but with a low amplitude. In the defect zone, no out of plane displacement of yarn is observed. This is even the case of yarns that bend in the ply plane. In those conditions one may have expected to observe the occurrence of tow buckles [21], but the load of the involved yarns as well as their in-plane bending angle magnitude did not favor the conditions of their occurrence. Otherwise, over the defect zones no transversal disarrangement of the longitudinal

yarn is observed. There is no gap between the longitudinal yarns and the dots placed on the transverse yarns remain aligned along the longitudinal yarns axis.

IV. ANALYSIS AND DISCUSSION

Two strips may be distinguished on the deformed ply in relation to the dominated deformation mechanisms: tension strip and shear strip. The tension strip involves one radial yarn, pointed out on Fig 4-a, which intersects with the punch translating axis and it is aligned with the hole radius of the blank-holder plate. The radial yarn on this strip is driven by the punch that pulls it from the die-holder contact zone. During this slid an axial tension on the yarn due to the friction resistance on the contact surfaces (with the other yarns and with the die-holder system) takes place. The shear angle between the radial yarn and the transversal yarns was measured on the planar part of the strip. The measured angles between the radial and the transverse yarns are globally equal to zero. This indicates that no in-plane shear deformation takes place in this zone. Therefore, this strip is mainly submitted to tension deformation. The shear strip is characterised by a trellis of crossing yarns. In order to fit the punch 3D surface shape, the crossing yarns rotate relative to each other in the inter-yarn crossing area. The shear angles were measured on the planar part of this strip. The values vary along the strip and a maximum value is observed at the holder corner location near to punch. Therefore, the in-plane shear is considered as the dominating deformation mechanism that takes place in this strip and tension mechanisms can be neglected. The angle between the two strips is 45° on both ply-0 and ply-45. The ply behaviour between these two strips is seen as an interaction between these two deformation types. The tension force on the tension strip is evaluated as a function of the punch displacement by implementing an analytical study of the fabric behaviour during preforming with a simple curved punch surface (hemi-cylindrical). Based on this analysis, the friction force limit (once the strip slippage initiates) to pull one yarn of the tension strip across the machine plates is defined in the Equation (1), by considering the friction on the flat contact surface of the die and holder in addition to the friction on the curved contact surface of the die with the tension strip.

$$t^y = 2 \mu (P - T \sin \alpha) \frac{A^p}{S} e^{\mu \alpha} \quad (1)$$

The yarn tension (t^y) depends on the friction coefficient between the tools and the fabric (μ), the contact angle (α) at the holder corner, the strip tension (T) and the holder force (P). The direct proportional relationship between the holder force and yarn tension in the equation coincides with experimental results, Fig 3. The yarn tension, Equation (1), depends also on the ratio (A^p/S) of the contact area of the sliding yarn on the flat part of the blank-holder (on the die) relative to the area of contact of the whole preform with the die.

Sliding the ply across the contact surfaces during the process with the punch motion is associated with normal contact and tangential contact shear stress generated on the contact surfaces and related directly to the yarn tension. These contact stresses increase gradually along the strip length over the flat area (A^p) from the ply border and it get its maximum value at the fabric entrance toward the punch on the curved die surface (A^c).

Back to Equation (1) the flat contact area (A^p) decreases whereas the contact angle (α) increases as the punch moves up. Consequently the contact area of the fabric with the curved die surface increase resulting in exponential augmentation of yarn tension, according to Capstan equation [22]. Thus highest normal contact and tangential contact shear stress are expected on this curved part. In case of higher contact shear stress than the inter yarn cohesion stress between the crossed yarns within the fabric, the generated contact shear stress causes sticking the transversal yarns of the tension strips on contact surface while the longitudinal radial yarns, which are driven by the punch, slid over them and create a gap between the successive transversal yarns. That conforms to the observation of the defect occurrence for ply-45° on the curved surface of the die along the radial yarns. However, on the shear strip, the yarns shear to fit the punch shape and the amount of the yarn movement and generated tension is too less than the yarn sliding on the tension strip as it is a structural deformation and the fabric has poor shearing resistance. Therefore less contact shear stress and no intra-ply yarn sliding is expected on the shear strip.

Otherwise, higher required yarn tension to pull the fabric out of the contact surfaces causes a higher preforming force, which is the sum of all required force to do the required yarn movement (sliding) and fabric deformation (shear and yarn bending). Therefore higher yarn tension generated by higher holder force (P) leads to higher forming force. Also the effect of the ply orientation (ply-0 and ply-45) on the preforming force which is illustrated in Fig 3 can be explained through Equation (1). The length of radial yarn for the ply-45 ($L_{45} = 121.42$ mm) is longer than the ply-0 ($L_0 = 68.8$ mm), as illustrated in Fig 2. That results in a higher (A^p/S) ratio for the ply-45 and consequently a higher yarn tension and preforming force on the tension strip.

V. SOLUTION

Based on the analytical analysis, a solution related to the ply geometry (radial yarn length) is proposed to inhibit the intra-ply yarn sliding. The yarn tension is directly proportional to the ratio (A^p/S) as shown in Equation (1). In order to explore into more depth the effect of the ply geometry, two different configurations for the ply-45 orientation were considered relative to the length of the radial yarn on the contact surface with the machine plates. The ply corners are cut into two different geometries to obtain two lengths for the radial yarn (L_1 and L_2) as illustrated in Fig 5. The length L_2 is equal to the length of the radial yarn on the contact surface in the ply-0 configuration, ($L_2 = L_0 = 68.6$ mm). However, the fabric contact area (S) for ply-45_L2 is smaller than that for ply-0. The length L_1 is defined by the following equation: $L_1 = \frac{1}{2} (L_{45} + L_0) = 95.5$ mm.

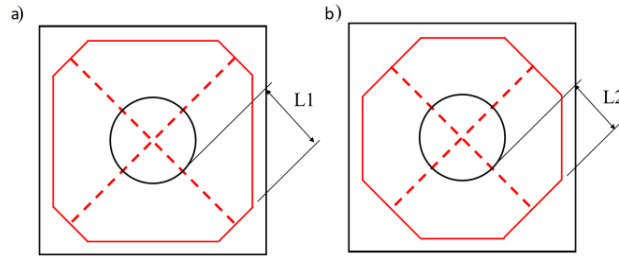

Fig 5: Modified ply-45-L1 and ply-45-L2

Preforming tests with a hemispheric shape punch and an operating pressure of 0.075 MPa for the holder actuators were conducted for both ply-45_L1 and ply-45_L2. The preforming punch force was recorded in both cases and plot as a function of its displacement (Fig 6). It clearly appears that a shorter radial yarn length is associated to a lower preforming force. This observation is completely consistent with Eq. (1). That reveals also the high impact of the yarn tension caused by the friction stress on the contact surfaces (die and blank-holder) and the preforming force. A difference in the preforming force is noted between the ply-0 and ply-45_L2, Fig 6, even if the radial yarn lengths are identical. This difference may be attributed to a higher fabric contact area (S) for ply-45_L2 resulting in a higher normal contact and friction contact force.

During the experimental tests, the intra-ply yarn sliding defect was only observed on ply-45_L1, Fig 7-a, but with lower amplitude than the one observed for ply-45 (Fig 4-d). Only a small gap appears between the transverse yarns on the tension strip in the useful zone. Furthermore, this defect occurs only along the radial yarns near the holder corner, as noticed earlier for ply-45. On the modified ply-45_L2 a slight misalignment can be observed on the non-sheared zone, Fig 7-b.

As a conclusion of this section, increasing the length of the radial yarns (or the longitudinal yarn of the non-sheared strip between the contact surfaces with the machine plates) has for consequence to raise the yarn tension resulting in higher preforming force. It also causes the rise of the normal contact force and the frictional force on that radial yarn at the holder corner that enhances the friction force between the transverse yarn and the machine tool at this zone. Consequently, the longitudinal yarns cannot bring the transversal yarns with them and the transversal yarns are locked into position on the holder corner causing the yarns sliding defect. On the contrary, reducing the length of the stretched yarn by cutting the samples corners may be a solution to prevent the occurrence of the yarn sliding defect.

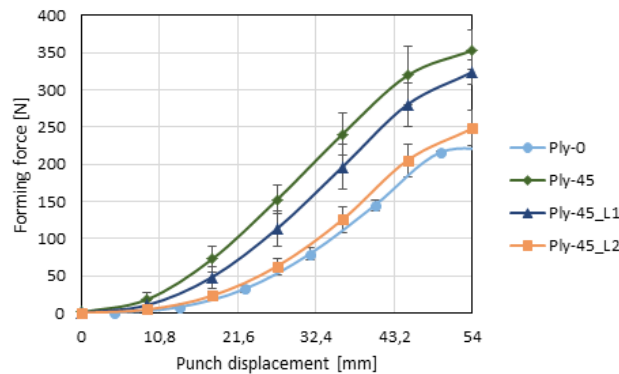

Fig 6: Preforming force of ply-0 and ply-45 with variation of the radial yarn length, ply-45-L1 and ply-45-L2.

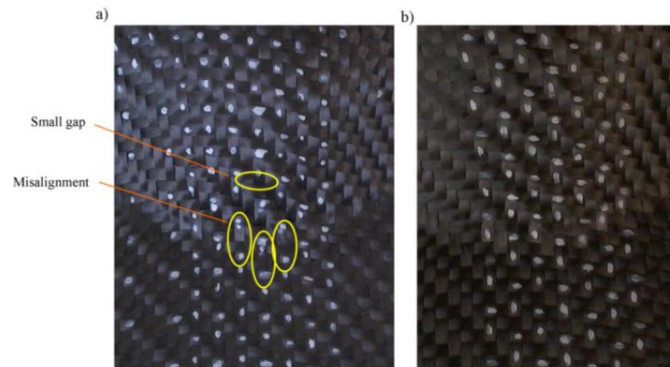

Fig 7: Zoomed photo for the ply/holder corner contact zone after preforming operation on ply-45-L1 (a) and ply-45-L2 (b).

VI. CONCLUSION

The behavior of the “HexForce 48600 U 1250” carbon woven fabric during the friction-based blank-holders preforming process with a hemispheric-shaped punch was conducted with a particular attention given to the observation of the occurrence of the intra-ply yarn sliding defect. The experiments were performed for two orientations of a mono-ply: ply-0 and ply-45. A higher preforming force is required to form the ply-45. Furthermore, this higher force is associated to the occurrence of the intra-ply yarn sliding defect on the holder corner along the radial yarns in the non-sheared zone.

Two strips from the ply were distinguished relative to the main deformation mechanism: tension strip and shear strip. The yarn tension on the tension strip was related to the friction on both ply/die and ply/holder contact surfaces based on analytical analysis developed previously. The analytical model shows that the longitudinal yarn tension, once the fabric slippage takes place across the die and the blank holder, depends only on the friction properties of the ply/tool contact surfaces and the applied holder force.

This work also showed that the yarn tension is related to its length between the machine plates contact surfaces. The effect of this length was investigated by testing two modified shapes for the ply-45. It was clear that a longer length of the radial yarn on the contact surface involves higher tension within the yarns and higher global preforming forces. This higher tension is associated to a higher normal contact and a higher tangential friction contact force on the ply/holder corner contact surface. When the friction between the transversal yarns and the holder corner surface becomes higher than the inter-yarns friction at the yarn crossing area, the radial yarns that are stretched and pulled by the punch cannot bring the transversal yarn with them. That has for consequence to initiate intra-ply yarn sliding that may be considered as a preforming defect as locally, the density of yarn may be severely reduced and therefore is a zone rich in resin and a potential zone of weakness for the composite part. Consequently, the yarn slippage is associated to the radial yarn tension induced by friction on the machine tool. Thus it is important to localize the zone with the high tangential friction on the ply during preforming and this work proposed it for the studied hemispherical shape.

The analysis of the evolution of process parameters and the fabric properties (weaving pattern, surface properties of the yarns) should be realized in future works.

REFERENCES

- [1] Boisse P. Advances in composites manufacturing and Process Design. In Boisse P, editor. Woodhead Publishing Series in Composites Science and Engineering: Number 56. 2015.
- [2] Allaoui S, Cellard C, Hivet G. Effect of inter-ply sliding on the quality of multilayer interlock dry fabric preforms. *Composites: Part A* 2015; 68 :336–345
- [3] Boisse P, Hamila N, Guzman-Maldonad E, Madeo A, Hivet G, dell’Isola F. The bias-extension test for the analysis of in-plane shear properties of textile composite reinforcements and prepregs: a review. *International Journal of Material Forming* 2016 doi:10.1007/s12289-016-1294-7.
- [4] Tephany C, Soulat D, Gillibert J, Ouagne P. Influence of the non-linearity of fabric tensile behavior for preforming modeling of a woven flax fabric. *Textile Research Journal*. 2016;86 (6):604-17.
- [5] Harrison P. Modelling the forming mechanics of engineering fabrics using a mutually constrained pantographic beam and membrane mesh. *Composites: Part A* 2016;81:145–157
- [6] Gereke T, Dobrich O, Hubner M, Cherif C. Experimental and computational composite textile reinforcement forming: A review. *Composites: Part A* 2013;46 :1–10.

- [7] Hamila N. Boisse P. Sabourin F. Brunet M. A semi-discrete shell finite element for textile composite reinforcement forming simulation. *International Journal for Numerical Methods in Engineering*. 2009;79(12):1443–1466
- [8] Charmetant A. Oriac J.G. Vidal-Sallé E. Boisse P. Hyperelastic model for large deformation analyses of 3D interlock composite preforms. *Composites Science and Technology* 2012;72(12):1352–1360
- [9] Boisse P. Finite element analysis of composite forming. In Long A.C. editor. *Composite Forming Technologies*. Woodhead Publishing. Cambridge. 2007: 46–79
- [10] Sjölander J. Hallander P. Åkermo M. Forming induced wrinkling of composite laminates: A numerical study on wrinkling mechanisms. *Composites: Part A*. 2016; 81: 41–51
- [11] Allaoui S. Boisse P. Chatel S. Hamila N. Hivet G. Soulat D. Vidal-Salle. Experimental and numerical analyses of textile reinforcement forming of a tetrahedral shape. *Composites: Part A*. 2011; 42(6): 612–622
- [12] Allaoui S. Hivet G. Soulat D. Wendling A. Ouagne P. Chatel S. Experimental preforming of highly double curved shapes with a case corner using an interlock reinforcement. *International Journal of Material Forming*. 2014; 7(2): 155–165
- [13] Nezami F. Nosrat. Gereke T. Cherif C. Analyses of interaction mechanisms during forming of multilayer carbon woven fabrics for composite applications. *Composites: Part A* 2016;84:406–16.
- [14] Nezami F. Nosrat. Gereke T. Cherif C. Active forming manipulation of composite reinforcements for the suppression of forming defects. *Composites Part A* 2017;99:94–101.
- [15] Barbagallo G., Madeo A., Giorgio I., Morestin, F., Boisse P. Bias extension test on an unbalanced woven composite reinforcement: Experiments and modeling via a second-gradient continuum approach. *Journal of Composite Materials*, 51 (2), (2017), 153-170
- [16] Margossian A. Bel S. Balvers J.M. Leutz D. Freitas R. Hinterhoelzl R. Finite element forming simulation of locally stitched non-crimp fabrics. *Composites: Part A*. 2014;61:152-162
- [17] Schirmaier F. Weidenmann KA. Kaerger L. Henning F. Characterization of the draping behaviour of sewed unidirectional non-crimp fabrics (UD-NCF). *Composites: Part A*. 2016;80:28–38
- [18] Wang P. Legrand X. Boisse P. Hamila N. Soulat D. Experimental and numerical analyses of manufacturing process of a composite square box part: Comparison between textile reinforcement forming and surface 3D weaving. *Composites Part B* 2015; 78: 26-34.
- [19] Gatouillat S. Bareggi A. Vidal-Sallé E. Boisse P. Meso modelling for composite preform shaping simulation of the loss of cohesion of the woven fibre network. *Composites: Part A* 2013;54:135–44
- [20] Jacquot P.B. Wang P. Soulat D. Legrand X. Analysis of the preforming behaviour of the braided and woven flax/polyamide fabrics. *Journal of Industrial Textiles*. September 2016;46(3):698-718.
- [21] Ouagne P, Soulat D, Hivet G, Allaoui S, Duriatti D. Analysis of defects during the preforming of a woven flax. *Adv Compos Lett* 2011;20:105–8.
- [22] W. Stephen. The mechanics of friction in rope rescue. *International Technical Rescue Symposium (ITRS 99)*.