



HAL
open science

Optimal control for a mobile robot with a communication objective

Jérôme Lohéac, Vineeth S. Varma, Irinel-Constantin Morarescu

► **To cite this version:**

Jérôme Lohéac, Vineeth S. Varma, Irinel-Constantin Morarescu. Optimal control for a mobile robot with a communication objective. 2019. hal-02353582v1

HAL Id: hal-02353582

<https://hal.science/hal-02353582v1>

Preprint submitted on 7 Nov 2019 (v1), last revised 26 Apr 2020 (v2)

HAL is a multi-disciplinary open access archive for the deposit and dissemination of scientific research documents, whether they are published or not. The documents may come from teaching and research institutions in France or abroad, or from public or private research centers.

L'archive ouverte pluridisciplinaire **HAL**, est destinée au dépôt et à la diffusion de documents scientifiques de niveau recherche, publiés ou non, émanant des établissements d'enseignement et de recherche français ou étrangers, des laboratoires publics ou privés.

Optimal control for a mobile robot with a communication objective

J. Lohéac¹ V. S. Varma¹ I. C. Morărescu¹

Abstract

In this paper, we design control strategies that minimize the time required by a mobile robot to accomplish a certain task (reach a target) while transmitting/receiving a message. To better illustrate the solution we consider a simple model for the robot dynamics. The message delivery is done over a wireless network, and we account for path-loss, i.e., the transmission rate depends on the distance to the wireless antenna. In this work, we consider only one wireless antenna and disregard any shadowing phenomena. To render the problem interesting from a practical point of view we assume that the robot cannot move with infinite velocity. The general problem involves a switching control signal due to the complementarity of the objectives (message transmission can require to approach the antenna situated in the opposite direction of the final target to reach). Our minimal-time control design is based on the use of Pontryagin maximum principle. A numerical example illustrates the theoretical results.

Key-words: Time optimal control, Pontryagin maximum principle, wireless communication.

1 Introduction

More and more frequently in practical nowadays problems a mobile robot must transmit/receive a certain amount of data over a wireless network while moving to a certain destination as quickly as possible. This situation requiring a kind of multi-objective optimization (maximize transmission rate and minimize the time to complete the task) often appears in the wide area of networked robotics see [10]. For example, when an unmanned aerial vehicle or a ground robot has to collect data from a field of wireless sensors, it typically has to optimize its trajectory to minimize the task time while collecting correctly the data (see e.g., [19] and [15]). The emergence of this new type of optimal control problem with communication-based constraints has led the authors to state the problem described and analyzed throughout this paper.

The problem under consideration is as follows. A robot has to move from a starting point to a target point within the shortest possible time. However, it must also ensure that it has transmitted a certain amount of data, while on its trajectory, to a wireless access point. The access point receives the signal with a signal-to-noise ratio (SNR) which primarily depends on the distance between the mobile and the base. Therefore, the mobile has to choose a trajectory which allows the data to be uploaded successfully (which is made possible by having a sufficiently large SNR) and to minimize the time taken for reaching its target point. Another relevant paper is given by [6], in which a similar problem is solved numerically, but with some analytic insights which provides some conditions for the optimal solution. In contrast with these works, the main contribution of this paper is to analytically provide the optimal solution to our problem of time

¹Université de Lorraine, CNRS, CRAN, F-54000 Nancy, France
(e-mail addresses: jerome.loheac@univ-lorraine.fr, vineeth.satheeskumar-varma@univ-lorraine.fr,
constantin.morarescu@univ-lorraine.fr).

minimization. This is done through the use of the Pontryagin maximum principle, see for instance [12, 5].

Similar results dealing with minimal energy consumption can be found in [16, 13, 2, 4, 3]. Note that in most of these results, only a heuristic solution is provided. This is due to the fact that the SNR is taken as a random variable.

This paper is organized as follows. In Section 2 we state the constrained minimization problem considered along this work. Based on some geometrical facts, in Section 3, we reduce the above minimization problem to a simpler one. Precisely, we show that it is sufficient to consider that the robot evolves in the two-dimensional plane. Moreover, if the size of the message to transmit is small or large enough the solution can be easily found. In Section 4, we apply the Pontryagin maximum principle and compute the optimal control and the corresponding minimal time. Finally, in Section 5, we give a complete numerical example. The paper ends with some concluding remarks.

2 Problem statement

Let us consider a robot with a simplified single integrator dynamics,

$$\dot{x} = u, \tag{2.1}$$

where $x \in \mathbb{R}^d$ is the robot's position and $u \in \mathbb{R}^d$ the control input representing its velocity. The choice of this dynamics is largely motivated in the literature (see for instance [7]). Besides the relevance of this choice for practical applications, we will also see that mathematical analysis of this simple dynamics is not trivial. Therefore, keeping the dynamics simple facilitates the mathematical presentation of the results. Throughout the paper, we assume that the control input/velocity is bounded and without loss of generality we consider that $|u(t)| \leq 1$, where $|\cdot|$ is the Euclidean norm of \mathbb{R}^d . One task of the robot is to deliver a message over a wireless network. This is represented in the following as the problem of emptying a buffer whose size at time t is denoted by $b(t)$.

Communication model Typically in wireless communication, the communication rate is modeled as a stochastic function which depends on the distance between the transmitting node and the receiving node. We use $R(|x(t)|)$ to denote the communication rate at time t . In practice, communication is performed over certain intervals over which communication packets are transmitted and received with some probability depending on the channel quality, see [18]. The duration of a frame is typically of the order of 10ms (see [17]) in the LTE communication framework. This implies that if a robot moves sufficiently slowly (speeds of 2 or 3 m/s), the rate function can be well approximated by its expectation over channel fast fading as shown in [11]. Therefore, for the rest of this paper, we assume that R satisfies the following assumption:

Assumption 1.

- (a) $R : \mathbb{R}_+ \rightarrow \mathbb{R}_+$ is an absolutely continuous, non-increasing function;
- (b) $R(0) > 0$;
- (c) R is decreasing on the set $\{\rho \in \mathbb{R}_+ \mid R(\rho) > 0\}$.

In our numerical examples, we will consider a specific rate function similar to the one provided by [11]. With this assumption, it turns out that we end up with a hybrid control problem in which the robot has first to apply a control action to approach the antenna (increase the transmission rate) and second, switch the control to a point stabilization one (reach the destination). Formally, the state of the system will be (x, b) where dynamics of x is given in (2.1) and b is solution of

$$\dot{b} = -R(|x|). \tag{2.2}$$

Remark 2.0.1. The Assumption 1-(b) is used to prove the existence of a time optimal solution. The absolute continuity of R is required to apply the Pontryagin maximum principle. The decreasing properties of R are motivated by the physical nature of the problem.

Objective We are now ready to formalize the time optimal control problem which is studied in this paper. Given any initial position x^0 and any target position x^1 in \mathbb{R}^d , the goal is to move the robot from x^0 to x^1 in minimal time following a trajectory allowing at emptying the buffer b , i.e., $b(T) \leq 0$ (in practice, the data is transmitted as soon as $b(t) > 0$ and the transmission is stopped after time the time instant t_0 where $b(t_0) = 0$). In other words, we aim to solve the following constrained time optimal control problem:

$$\min \begin{cases} T = \int_0^T dt, \\ T \geq 0, \\ u \in L^\infty(0, T)^d, \quad \|u\|_{L^\infty(0, T)^d} \leq 1, \\ x(0) = x^0, \quad x(T) = x^1, \\ b(0) = b^0 > 0, \quad b(T) \leq 0 \\ \text{with } (x, b) \text{ solution of (2.1)-(2.2).} \end{cases} \quad (2.3)$$

Results Before entering the core of this article, let us give a brief summary of the obtained results. See also Figure 6, at the end of this paper, or an example of time optimal controlled path.

- When b^0 is small, the optimal time is given by Proposition 3.0.5.
- When b^0 is large, the optimal time is given by Proposition 3.0.6.
- When b^0 takes intermediate values and x^0 , x^1 and 0 are aligned, the optimal time is given by Proposition 3.0.7.
- When b^0 takes intermediate values and x^0 , x^1 and 0 are not aligned, the optimal time is given by Theorem 4.0.9.

3 Preliminary observations

In this section, we will first use the classical Filippov Theorem to ensure the existence of a minimizer (T, u) for the minimization problem (2.3). Then, using some simple geometric facts to reduce the general d -dimensional problem (2.3) to the same problem but with $d = 2$. Furthermore, we will show that there exist an optimal path x such that $x(t)$ belongs to the convex hull of $\{x^0, 0, x^1\}$ for every time $t \in [0, T]$. Finally, we will give the closed form of the control signal and of the minimal time in some particular situations. Precisely, the analytic solution is provided when b^0 is small or large enough, as well as when the initial position (x^0), the position of the antenna (0) and the final position (x^1) are aligned.

Existence of a minimizer It is easy to see, under the Assumption 1, in particular $R(0) > 0$, that there exist $T > 0$ and $u \in L^\infty(0, T)^d$, with $\|u\|_{L^\infty(0, T)^d} \leq 1$, such that the solution of (2.1)-(2.2), with initial condition $x^0 \in \mathbb{R}^d$ and $b^0 \in \mathbb{R}$ satisfies $x(T) = x^1$ and $b(T) \leq 0$. In fact, it is enough to consider piece-wise constant controls as in Proposition 3.0.6 below. In addition to this reachability property, by application of Filippov Theorem (see for instance [8, Chapter 9]), it is easy to see that this problem admits a minimum.

Reduction to a planar motion Let us first emphasize an invariance property with respect to the change of the basis used to express the vectors $x \in \mathbb{R}^d$.

Remark 3.0.1. It is straightforward to show that for every orthogonal matrix $Q \in \mathbb{R}^{d \times d}$, if (T, u) is an optimal solution of the constrained minimization problem (2.3), then (T, Qu) is also an optimal solution of (2.3) with x^0 replaced by Qx^0 and x^1 replaced by Qx^1 .

Secondly, we can show that there exist a time-optimal solution for which the motion of the robot is performed in a 2D space, namely $\text{Span}\{x^0, x^1\}$.

Lemma 3.0.2. *Given $x^0, x^1 \in \mathbb{R}^d$ and $b^0 \in \mathbb{R}_+$, then there exists a solution (T, u) of (2.3) such that the trajectory x of (2.1) associated with u , satisfies $x(t) \in \text{Span}\{x^0, x^1\}$ for every $t \in [0, T]$.*

Proof. Let us define $P \in M_d(\mathbb{R})$ the orthonormal projector from \mathbb{R}^d to $\text{Span}\{x^0, x^1\} \subset \mathbb{R}^d$. Let (T, u) be an optimal solution, and set (x, b) the corresponding time-optimal trajectory. We set $\tilde{u} = Pu$ and $\tilde{x} = Px$, and we obtain $\dot{\tilde{x}} = \tilde{u}$, $\tilde{x}(0) = x^0$, $\tilde{x}(T) = x^1$ and $|\tilde{u}(t)| \leq |u(t)| \leq 1$. Let us also define $\tilde{b}(t) = b^0 - \int_0^t R(|\tilde{x}(\tau)|) d\tau$. Since $|\tilde{x}(t)| \leq |x(t)|$ and since R is a decreasing function, we have $\tilde{b}(t) \leq b(t)$ for every $t \in [0, T]$ and in particular, $\tilde{b}(T) \leq 0$.

In conclusion we have found a control in time T which is admissible (i.e., is of L^∞ -norm lower than 1 for which we have $x(T) = x^1$ and $b(T) \leq 0$) such that the trajectory of the robot belongs to $\text{Span}\{x^0, x^1\}$. \square

From Remark 3.0.1 and Lemma 3.0.2, we can assume without loss of generality that $d = 2$.

The next result shows that, there always exists a time-optimal solution such that the trajectory x belongs to the following convex and bounded set $\text{co}\{0, x^0, x^1\}$, where $\text{co} A$ denotes the convex hull of the set A .

Lemma 3.0.3. *Given $x^0, x^1 \in \mathbb{R}^d$ and $b^0 \in \mathbb{R}_+$, there exist a solution (T, u) of (2.3) such that the trajectory x of (2.1) associated with u satisfies,*

$$x(t) \in \text{co}\{0, x(t_0), x(t_1)\} \quad (t \in (t_0, t_1)), \quad (3.1)$$

for every t_0, t_1 such that $0 \leq t_0 \leq t_1 \leq T$.

Proof. Assume that (T, u) is optimal and let x be the corresponding path. Since x is continuous, if this property is not satisfied, there exist two time t_0 and t_1 such that $0 \leq t_0 \leq t_1 \leq T$ and $x(t) \notin \text{co}\{0, x(t_0), x(t_1)\}$ for every $t \in (t_0, t_1)$.

Then, for every $t \in (t_0, t_1)$, we define $\tilde{x}(t) \in \text{co}\{0, x(t_0), x(t_1)\}$ such that $\tilde{x}(t)$ minimizes $y \mapsto |x(t) - y|$ under the constraint $y \in \text{co}\{0, x(t_0), x(t_1)\}$, and for $t \in [0, T] \setminus (t_0, t_1)$, we simply set $\tilde{x}(t) = x(t)$. It is easy to see that \tilde{x} is almost everywhere differentiable on (t_0, t_1) and $|\dot{\tilde{x}}| \leq 1$. We thus have build an admissible path \tilde{x} satisfying $|x(t)| \geq |\tilde{x}(t)|$ for every $t \in [0, T]$, and since R is non-increasing, we have $\int_{t_0}^{t_1} R(|x(t)|) dt \leq \int_{t_0}^{t_1} R(|\tilde{x}(t)|) dt$. \square

Remark 3.0.4. The result of Lemma 3.0.3 ensures that there always exists a time optimal control u such that the solution x of (2.1) satisfies (3.1). However, it can be possible that some other time optimal trajectories do not satisfy the property (3.1). This is, in particular, the case when R is constant on a ball centered on 0. However, when b^0 is large enough and when the Assumption 1-(c) is used, we will see in Lemma 3.0.10 that the time optimal trajectory of the robot necessarily satisfies (3.1).

Minimal time for small or large enough initial buffer For every $x^0, x^1 \in \mathbb{R}^d$, let us define

$$B(x^0, x^1) = |x^1 - x^0| \int_0^1 R(|x^0 + s(x^1 - x^0)|) ds, \quad (3.2)$$

representing the quantity of buffer transmitted when going on a straight line from x^0 to x^1 with velocity one.

In the next proposition, we give the optimal time and the optimal control when b^0 is small.

Proposition 3.0.5. *Given $x^0, x^1 \in \mathbb{R}^d$ and $b^0 \in \mathbb{R}_+$. If $B(x^0, x^1) \geq b^0$, then the minimal time is $|x^1 - x^0|$ and the optimal control is $u(t) = (x^1 - x^0)/|x^1 - x^0|$.*

In other words, the optimal path of the robot is to go straight to the target.

Proof. The proof is straightforward. Indeed, when the buffer to transmit is smaller than the quantity of information that can be transmitted while going from x^0 to x^1 with the maximum speed, it is optimal to apply a control that achieves this straight line motion. It is clear that, with this control, we get $b(T) \leq 0$. \square

The next result considers the other extreme case (b^0 large) in which going straight to antenna (where the transmission rate is maximal) and then going to the target provides a time which is not sufficient to empty the buffer. Therefore, we basically show that the optimal strategy is to go to the antenna, stay there for a certain period, and then go straight to the target.

Proposition 3.0.6. *Given $x^0, x^1 \in \mathbb{R}^d$ and $b^0 \in \mathbb{R}_+$. If $B(x^0, 0) + B(0, x^1) \leq b^0$, then the optimal time is*

$$T = |x^0| + |x^1| + (b^0 - B(x^0, 0) - B(0, x^1)) / R(0) \quad (3.3a)$$

and an optimal control is

$$u(t) = \begin{cases} -x^0/|x^0| & \text{if } t < |x^0|, \\ 0 & \text{if } |x^0| < t < T - |x^1|, \\ x^1/|x^1| & \text{if } T - |x^1| < t. \end{cases} \quad (3.3b)$$

Proof. It is easy to see that the maximal amount of buffer that can be transmitted during the time interval $[0, |x^0|]$ is $B(x^0, 0)$, and the maximal amount of buffer that can be transmitted during the time interval $[T - |x^1|, T]$ is $B(0, |x^1|)$, and finally, the maximal amount of buffer that can be transmitted during the time interval $[|x^0|, T - |x^1|]$ is $R(0)(T - |x^1| - |x^0|)$. Consequently, the minimal time cannot be lower than T given by (3.3a). We conclude the proof by noticing that the control u given by (3.3b) allows to reach the target in this time T , hence is optimal. \square

Minimal time when x^0, x^1 and 0 are aligned From the convexity result Lemma 3.0.3, we know that an optimal trajectory belongs to the triangle formed by x^0, x^1 and 0. Furthermore, if $b^0 \leq B(x^0, x^1)$ or $b^0 \geq B(x^0, 0) + B(0, x^1)$, an optimal trajectory has been obtained in Propositions 3.0.5 and 3.0.6 respectively. Note that these cases include the case where 0 is included in the segment $[x^0, x^1]$. Let us state the result for the other cases.

Proposition 3.0.7. *Let $x^0, x^1 \in \mathbb{R}^d$ and $b^0 \in \mathbb{R}_+$ and assume that x^0, x^1 and 0 are aligned and that $B(x^0, x^1) < b^0 < B(x^0, 0) + B(0, x^1)$, then there exist $\lambda \in (0, 1)$ such that*

$$\lambda|x^0| < |x^1| \quad \text{and} \quad b^0 = B(x^0, \lambda x^0) + B(\lambda x^0, x^1).$$

Furthermore, the minimal time is given by

$$T = |x^0| + |x^1| - 2\lambda|x^0|$$

and an optimal control is

$$u(t) = \begin{cases} -x^0/|x^0| & \text{if } t < (1 - \lambda)|x^0|, \\ x^0/|x^0| & \text{if } (1 - \lambda)|x^0| < t. \end{cases}$$

The proof of this result is a direct application of Lemma 3.0.3 and is not detailed here.

A priori conditions when b^0 takes intermediate values To conclude this paper, we consider the last case, i.e., the case where x^0 , x^1 and b^0 satisfy the following assumptions:

Assumption 2.

- (a) $\dim \text{Span}\{x^0, x^1\} = 2$ (i.e., x^0 , x^1 and 0 are not aligned);
- (b) $B(x^0, x^1) < b^0 < B(x^0, 0) + B(0, x^1)$.

In the following lemma, we give some preliminary observations on the optimal solution when Assumption 2 is satisfied.

Lemma 3.0.8. *Let $x^0, x^1 \in \mathbb{R}^d$ and $b^0 \in \mathbb{R}_+$ satisfying the Assumption 2, let (T, u) be a minimizer of (2.3) and let (x, b) be the corresponding optimal state trajectory. Then we have:*

- (i) $|x^1 - x^0| < T < |x^0| + |x^1|$;
- (ii) $\min_{t \in [0, T]} |x(t)| > 0$;
- (iii) $b(T) = 0$.

Proof. The first item is trivial. In fact, the first inequality says that the optimal time T is larger than the time required to go from x^0 to x^1 on a straight line, and the second inequality says that the optimal time T is smaller than the time required to go from x^0 to 0 and then to x^1 following two straight lines.

The second item can be proven by contradiction. If there exist a time t such that $x(t) = 0$, we necessarily have $T \geq |x^0| + |x^1|$, which contradicts the first item.

For the last item, assume by contradiction that $b(T) < 0$. For every $\tau \in [0, T]$, let us define the path x_τ by

$$x_\tau(t) = \begin{cases} x(t) & \text{if } 0 \leq t \leq \tau, \\ x(\tau) + \frac{t - \tau}{T_\tau - \tau}(x^1 - x(\tau)) & \text{if } \tau < t \leq T_\tau, \end{cases}$$

with $T_\tau = \tau + |x^1 - x(\tau)|$. Note that we have by construction $x_\tau(0) = x^0$, $x_\tau(T_\tau) = x^1$ and $|\dot{x}_\tau(t)| \leq 1$ for almost every $t \in [0, T_\tau]$. Note also that $T_\tau \leq T$ for every $\tau \in [0, T]$. Let us also define b_τ the buffer size associated with the path x_τ . We then have $b_\tau(T_\tau) = b(\tau) - B(x(\tau), x^1)$. Note that $\tau \mapsto b_\tau(T_\tau)$ is continuous, $b_0(T_0) = b^0 - B(x^0, x^1) > 0$ and $b_T(T_T) = b(T) < 0$. Consequently, there exist $\tau^* \in (0, T)$ such that $b_{\tau^*}(T_{\tau^*}) = 0$. Note now that we have $T_{\tau^*} < T$. In fact if $T_{\tau^*} = T$ then we have $x = x_{\tau^*}$ on $[0, T]$, and hence $b_{\tau^*} = b$, which is impossible (because $b(T) < 0$). This leads to a contradiction with the optimality of T . \square

Remark 3.0.9. Note that the item (iii) is valid with the only assumption being $b^0 > B(x^0, x^1)$.

This last result, together with a more careful use of Assumption 1, leads to a refined version of Lemma 3.0.3.

Lemma 3.0.10. *Let $x^0, x^1 \in \mathbb{R}^d$ and $b^0 \in \mathbb{R}_+$ satisfying the Assumption 2, let (T, u) be a minimizer of (2.3) and let (x, b) be the corresponding optimal state trajectory. Then for every $t_0, t_1 \in [0, T]$, with $t_0 \leq t_1$, the convex property (3.1) is fulfilled.*

Proof. We reproduce here the proof of Lemma 3.0.3. If this property is not satisfied, there exist two time t_0 and t_1 such that $0 \leq t_0 \leq t_1 \leq T$ and $x(t) \notin \text{co}\{0, x(t_0), x(t_1)\}$ for every $t \in (t_0, t_1)$. For every $t \in [t_0, t_1]$, we then define $\tilde{x}(t) \in \text{co}\{0, x(t_0), x(t_1)\}$ such that $\tilde{x}(t)$ minimizes $y \mapsto |x(t) - y|$ under the constraint $y \in \text{co}\{0, x(t_0), x(t_1)\}$. Thus, we have built an admissible path \tilde{x} on $[t_0, t_1]$ satisfying $|x(t)| \geq |\tilde{x}(t)|$ for every $t \in [t_0, t_1]$, and since R is non-increasing, we have $\int_{t_0}^{t_1} R(|x(t)|) dt \leq \int_{t_0}^{t_1} R(|\tilde{x}(t)|) dt$. Two situations can happen: either we have $R(|\tilde{x}(t)|) = 0$ for every $t \in [t_0, t_1]$, or there exist a time $t \in [t_0, t_1]$ such that $R(|\tilde{x}(t)|) > 0$.

1. In the first case ($R(|\tilde{x}|) = 0$ on $[t_0, t_1]$) no buffer is transmitted and obviously the optimal path to steer $x(t_0)$ to $x(t_1)$ is a straight line. This contradicts the fact that x was optimal and $x(t) \notin \text{co}\{0, x(t_0), x(t_1)\}$ for every $t \in (t_0, t_1)$.
2. In the second case ($\exists t \in [t_0, t_1] \mid R(|\tilde{x}(t)|) > 0$), the continuity of R and x , ensure the existence of a time $\bar{t} \in (t_0, t_1)$ such that $R(|\tilde{x}(\bar{t})|) > 0$. Since, by assumption, we have $x(\bar{t}) \notin \text{co}\{0, x^0, x^1\}$, we can conclude that $|\tilde{x}(\bar{t})| < |x(\bar{t})|$. This means (using the strict monotonicity of R , see Assumption 1), that $R(|x(\bar{t})|) < R(|\tilde{x}(\bar{t})|)$, and hence, from the continuity of x and R , we conclude that $\int_{t_0}^{t_1} R(|x(t)|) dt < \int_{t_0}^{t_1} R(|\tilde{x}(t)|) dt$. In conclusion, we have built an admissible path, for which the corresponding buffer size satisfies $\tilde{b}(T) < 0$. This leads to a contradiction with the item (iii) of Lemma 3.0.8.

□

In the next section, we give some more precise results when the Assumption 2 is satisfied. These result will be derived from the Pontryagin maximum principle.

4 Pontryagin maximum principle

In this section, we are going to apply the well-known Pontryagin maximum principle to solve the problem (2.3). We first write the Pontryagin maximum principle in the general case $d \in \mathbb{N}^*$. Next, based on the results in Section 3, we reduce the analysis without loss of generality to the particular case $d = 2$. Finally, the results obtained are summarized in Theorem 4.0.9. In addition, since the optimal controls and times have already been obtained for b^0 small or large (see Propositions 3.0.5 and 3.0.6), and for x^0, x^1 and 0 aligned (see Proposition 3.0.7), we will assume in this section that x^0, x^1 and b^0 satisfy the Assumption 2.

General case $d \in \mathbb{N}^*$ Let us recall that we assume that R is an absolutely continuous function. The Hamiltonian associated to the optimal control problem (2.3) is defined by

$$H(x, b, u, \xi, \beta, s_0) = -s_0 + \langle \xi, u \rangle - \beta R(|x|),$$

for $(x, b, u, \xi, \beta, s_0) \in \mathbb{R}^d \times \mathbb{R} \times \mathbb{R}^d \times \mathbb{R}^d \times \mathbb{R} \times \mathbb{R}_+$. The Pontryagin maximum principle (see for instance [1, Chapter 12] or [14, Chapter 11]) ensures that if (T, x, b, u) is an optimal solution, then, for almost every $t \in [0, T]$, we have,

$$0 = \max_{v \in D} H(x(t), b(t), v, \xi(t), \beta(t), s_0) = H(x(t), b(t), u(t), \xi(t), \beta(t), s_0), \quad (4.1)$$

where D is the closed unit ball of \mathbb{R}^d .

We note that in (4.1), ξ and β (the adjoint states) are solutions of

$$\dot{\xi} = -\frac{\partial H(x, b, u, \xi, \beta, s_0)}{\partial x} = \beta R'(|x|) \frac{x}{|x|}, \quad (4.2a)$$

$$\dot{\beta} = -\frac{\partial H(x, b, u, \xi, \beta, s_0)}{\partial z} = 0, \quad (4.2b)$$

with $R' \in L_{loc}^\infty(\mathbb{R}_+)$ is the derivative of R . Recall that if x^0 , x^1 and b^0 satisfy the Assumption 2 then the optimal path of the robot do not pass through 0 (see item (i) of Lemma 3.0.8). This ensures the validity of the relation (4.2a). The relation (4.2b) trivially ensures that β is constant.

Note also that the relation (4.1), ensures that

$$u(t) = \frac{\xi(t)}{|\xi(t)|}, \quad (4.3)$$

for every $t \in [0, T]$ such that $\xi(t) \neq 0$. Using (4.1) together with the expression of u , we deduce that

$$s_0 + \beta R(|x|) = |\xi| \quad (t \in [0, T]). \quad (4.4)$$

The next proposition summarize the above discussion.

Proposition 4.0.1. *Let $x^0, x^1 \in \mathbb{R}^d$ and $b^0 \in \mathbb{R}_+$ satisfying the Assumption 2, let (T, u) be a minimizer of (2.3) and let (x, b) be the corresponding optimal state trajectory. Then there exist $s_0 \geq 0$, $\beta \in \mathbb{R}$ and an absolutely continuous function $\xi : [0, T] \rightarrow \mathbb{R}^d$, such that (s_0, β, ξ) is not trivial and satisfies (4.2a) together with (4.4). Furthermore, u is given by (4.3) for every $t \in [0, T]$ such that $\xi(t) \neq 0$.*

In addition to this initial result, we can give some more properties on s_0 and β .

Lemma 4.0.2. *With the notations and assumptions introduced in Proposition 4.0.1, we have in addition $\beta < 0$ and $s_0 > 0$.*

Proof. The fact that $\beta \leq 0$ follows from transversality conditions (see e.g. [5]). Consequently, we only have to prove that $\beta \neq 0$ and $s_0 \neq 0$.

Let us assume by contradiction that $\beta = 0$, which yields, from (4.2a), ξ is constant. Since (s_0, β, ξ) shall not be trivial, we necessarily have (using (4.4)) $\xi \neq 0$. Consequently, using (4.3), u is a constant vector of the unit sphere of \mathbb{R}^d . In order to reach the target x^1 , we necessarily have $u = (x^1 - x^0)/|x^1 - x^0|$ and $T = |x^1 - x^0|$. But with this path, the transmitted information will be $B(x^0, x^1)$ which is strictly smaller than b^0 . Consequently, one has $b(T) > 0$ which is a contradiction with item (iii) of Lemma 3.0.8. This proves that $\beta < 0$.

Since $b^0 > 0$, there exist a time $\tau \in [0, T]$ such that $R(|x(\tau)|) > 0$. Consequently, from (4.4) (together with $\beta < 0$), we deduce that $s_0 \geq |\beta|R(|x(\tau)|) > 0$. \square

As a consequence of this result, we assume without loss of generality that $\beta = -1$ (recall that s_0 , ξ and β are defined up to a multiplicative constant).

Let us now show that the adjoint state ξ vanishes at most one time.

Lemma 4.0.3. *With the notations and assumptions of Proposition 4.0.1, the adjoint state ξ vanishes at most one time.*

Proof. Assume there exist two times t_0 and t_1 such that $0 \leq t_0 < t_1 \leq T$ and $\xi(t_0) = \xi(t_1) = 0$. Using (4.4) this yields that $R(|x(t_0)|) = R(|x(t_1)|) = s_0$. By Assumption 1-(c), we have that R

is injective on $R^{-1}(\mathbb{R}_+^*)$. In addition, since $s_0 > 0$ (see e.g. Lemma 4.0.2), we conclude that $R^{-1}(\{s_0\})$ is a single point and $|x(t_0)| = |x(t_1)|$. Using (4.4), once again, we have for every $t \in [t_0, t_1]$, $R(|x(t)|) = s_0 - |\xi(t)| \leq s_0 = R(|x(t_0)|) = R(|x(t_1)|)$. By Assumption 1 (R is nonincreasing), we deduce that $0 \leq |x(t_0)| = |x(t_1)| \leq |x(t)|$ for every $t \in [t_0, t_1]$. Obviously, this situation is impossible due to the convexity result of Lemma 3.0.10 and the fact that $|x(t)| > 0$ for every $t \in [0, T]$ (see item (iii) of Lemma 3.0.8). \square

Remark 4.0.4. This last result ensures that any time optimal control u is given by (4.3) for almost every time $t \in [0, T]$.

Case $d = 2$ Let us now particularise the consequences of the Pontryagin maximum principle to the particular case $d = 2$. Recall that the study of the case $d = 2$ is not a restriction, see Remark 3.0.1 and Lemma 3.0.2.

In order to integrate the Pontryagin maximum principle, we identify \mathbb{R}^2 with \mathbb{C} . Consequently, we set $x(t) = \rho(t)e^{i\theta(t)}$ and $\xi(t) = \sigma(t)e^{i\gamma(t)}$, with ρ and σ non-negative. Recall also that due to the item (ii) of Lemma 3.0.8, if x is a time optimal path, then $\rho(t)$ is positive for every time t . From (4.2), we deduce that σ and γ satisfy (recall that we have chosen, without loss of generality, $\beta = -1$):

$$\dot{\sigma} = -R'(\rho) \cos(\theta - \gamma), \quad (4.5a)$$

$$\sigma \dot{\gamma} = -R'(\rho) \sin(\theta - \gamma). \quad (4.5b)$$

and we have from (4.4),

$$\sigma = s_0 - R(\rho). \quad (4.6)$$

According to Remark 4.0.4, the optimal control u is given by $u(t) = e^{i\gamma(t)}$ for almost every $t \in [0, T]$. Thus, from (2.1) and (2.2), we deduce that ρ , θ and b satisfy:

$$\dot{\rho} = \cos(\theta - \gamma), \quad (4.7a)$$

$$\rho \dot{\theta} = -\sin(\theta - \gamma), \quad (4.7b)$$

$$\dot{b} = -R(\rho). \quad (4.7c)$$

In addition, from Remark 3.0.1 (with Assumption 2-(a)), we can assume without loss of generality that the initial and final state constraints are

$$\rho(0) = \rho^0 > 0, \quad \rho(T) = \rho^1 > 0 \quad \text{and} \quad \theta(T) = -\theta(0) = \Theta \in [0, \pi/2]. \quad (4.8)$$

By eventually performing the change of variables $t \mapsto T - t$ and using again Remark 3.0.1, it can also be assumed that

$$\rho^0 \geq \rho^1. \quad (4.9a)$$

Note also that the cases $\Theta = 0$ and $\Theta = \pi/2$ means that x^0 , x^1 and 0 are aligned. This situation is excluded from Assumption 2-(a) and has already been considered in Proposition 3.0.7. Consequently, in the rest of this section, we also assume that

$$\Theta \in (0, \pi/2). \quad (4.9b)$$

Let us finally define $\alpha = \gamma - \theta$. We are now ready to state the following lemma.

Lemma 4.0.5. *Let $x^0 = \rho^0 e^{-i\Theta}$ and $x^1 = \rho^1 e^{i\Theta}$ satisfying the assumptions given by (4.9), and let $b^0 \in \mathbb{R}_+$ satisfying the Assumption 2-(b). Given any minimizer (T, u) of (2.3), we set $x = \rho e^{i\theta}$ and b the corresponding optimal state trajectory. Then there exist three constants $\bar{\rho} \in [0, \rho^1]$, $s_0 > R(\bar{\rho})$ and $\beta < 0$, and an absolutely continuous function $\xi = \sigma e^{i\gamma}$ such that ρ , θ , b , σ , γ , β and s_0 satisfy (4.5), (4.6) and (4.7), and in addition,*

$$\sigma(t) \neq 0 \quad (t \in [0, T]) \quad (4.10)$$

and $\alpha = \gamma - \theta$ satisfies:

$$\sin \alpha(t) = \frac{\bar{\rho}(s_0 - R(\bar{\rho}))}{\rho(t)(s_0 - R(\rho(t)))} \quad (t \in [0, T]), \quad (4.11)$$

together with $\alpha(0) \in (\pi/2, \pi]$ (modulo 2π) and α is non-increasing. Finally, the time optimal control is given by $u = e^{i\gamma}$ everywhere on $[0, T]$.

Proof. Most of the results of this lemma are direct consequences of the previous results introduced in this paper. In fact, it remains to prove (4.10), the existence of $\bar{\rho}$, that $s_0 > R(\bar{\rho})$ and the claimed properties on α .

Using the notation $\alpha = \gamma - \theta$, (4.5) and (4.7), become:

$$\begin{aligned} \dot{\rho} &= \cos \alpha, & \rho \dot{\theta} &= \sin \alpha, \\ \dot{\sigma} &= -R'(\rho) \cos \alpha, & \sigma \dot{\gamma} &= R'(\rho) \sin \alpha. \end{aligned}$$

and, for every $t \in [0, T]$ such that $\sigma(t) \neq 0$, we have

$$\dot{\alpha} = \left(\frac{-1}{\rho} + \frac{R'(\rho)}{\sigma} \right) \sin \alpha. \quad (4.12)$$

Let us denote by \mathcal{T} a connected component of $[0, T] \setminus \sigma^{-1}(\{0\})$ (recall that according to Lemma 4.0.3, $\sigma^{-1}(\{0\})$ is either the empty set or a singleton). Note that, if $\alpha(\bar{t})$ is given for some $\bar{t} \in \mathcal{T}$, then α solution of (4.12), is uniquely determined in \mathcal{T} . Consequently, we have either $\alpha(t) = 0$, or $\alpha(t) \neq 0$ (modulo π) for every $t \in \mathcal{T}$.

1. If we are in the second situation ($\alpha(t) \neq 0$ (modulo π) for every $t \in \mathcal{T}$), we have,

$$\frac{\cos \alpha}{\sin \alpha} \dot{\alpha} = -\frac{\dot{\rho}}{\rho} - \frac{\dot{\sigma}}{\sigma} \quad (\text{on } \mathcal{T}).$$

From which we obtain,

$$\sin \alpha = \frac{c}{\rho \sigma} = \frac{c}{\rho(s_0 - R(\rho))} \quad (\text{on } \mathcal{T}), \quad (4.13)$$

with c a constant depending only on of the connected component \mathcal{T} of $[0, T] \setminus \sigma^{-1}(\{0\})$. Note that if $\sigma^{-1}(\{0\}) = \{\bar{t}\}$ is not empty, we have

$$\lim_{t \rightarrow \bar{t}} \rho(t)(s_0 - R(\rho(t))) = 0.$$

Hence, this ensures that if $\sigma^{-1}(\{0\})$ is not empty, we have $c = 0$.

2. If we are in the second situation ($\alpha = 0$ (modulo π) on \mathcal{T}), then by continuity of α on \mathcal{T} , we conclude that α is constant equal to 0 (modulo π) on \mathcal{T} .

In both cases, if $\sigma^{-1}(\{0\})$ is not empty or if there exist $\bar{t} \in [0, T] \setminus \sigma^{-1}(\{0\})$ such that $\alpha(\bar{t}) = 0$ (modulo π), then α is constant equal to 0 (modulo π) on each connected component of $[0, T] \setminus \sigma^{-1}(\{0\})$. Thus, using the expression of $\dot{\theta}$ and $\dot{\gamma}$, we deduce that θ and γ are constant on each component of $[0, T] \setminus \sigma^{-1}(\{0\})$. Note that θ is also continuous on each connected component of $[0, T] \setminus \sigma^{-1}(\{0\})$, and the only point of discontinuity of θ can be when $\rho = 0$. But, since $\theta(T) = -\theta(0) = \Theta \in (0, \pi/2)$, θ necessarily have a discontinuity point, meaning that there exist a time \bar{t} such that $\rho(\bar{t}) = 0$. This leads to a contradiction with the item (ii) of Lemma 3.0.8. In conclusion, we have $\sigma(t) \neq 0$ for every $t \in [0, T]$ and there exist a constant $c \neq 0$ such that (4.13) holds on $[0, T]$. In particular, this ensures that $\rho, \sigma, \theta, \gamma$ and α are continuous on $[0, T]$. Note that this also ensure that $u = e^{i\gamma}$ everywhere on $[0, T]$.

Note that, due to the assumption $\rho^0 \geq \rho^1$ and due to the convexity result (Lemma 3.0.10), one has $\gamma(0) \in (-\Theta + \pi/2, -\Theta + \pi]$ (modulo 2π), and hence $\alpha(0) \in (\pi/2, \pi]$ (modulo 2π) (see Figure 1). This, in particular, ensures that $c > 0$, and hence $\alpha(t) \in (0, \pi)$ (modulo 2π) for every $t \in [0, T]$. From the above result, and using (4.12), we can now state that α is a non-increasing function.

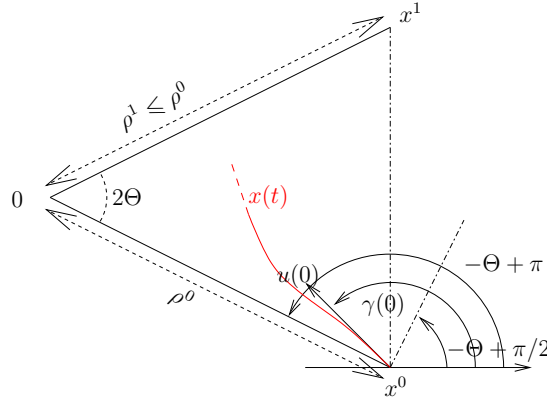

Figure 1: Graphical illustration of the fact that $\gamma(0) \in (-\Theta + \pi/2, -\Theta + \pi]$ (modulo 2π), and $\alpha(0) = \gamma(0) - \theta(0) = \gamma(0) + \Theta \in (\pi/2, \pi]$ (modulo 2π).

Let us finally prove the existence of $\bar{\rho}$ such that $c = R(\bar{\rho})$. Note that $\rho \mapsto \rho(s_0 - R(\rho))$ is increasing on $[\rho_m, \infty)$ with $\rho_m = 0$ if $s_0 \geq R(0)$, and $\rho_m \in \mathbb{R}_+$ is such that $s_0 = R(\rho_m)$ otherwise. In any cases, we have $0 = \rho_m(s_0 - R(\rho_m)) \leq c \leq \rho^1(s_0 - R(\rho^1))$ (the second inequality follows from the fact that (4.13) holds on the full interval $[0, T]$). Consequently, there exist $\bar{\rho} \in (\rho_m, \rho^1]$ such that $c = \bar{\rho}(s_0 - R(\bar{\rho}))$ yielding that $s_0 > R(\bar{\rho})$. \square

Remark 4.0.6. Let us mention that once s_0 and $\bar{\rho}$ are found, the control law is purely a feed-back control law. More precisely, the optimal control is given by $u = e^{i\gamma}$ with γ given by the ordinary differential equation:

$$\dot{\gamma} = \frac{\bar{\rho}R'(\rho)(s_0 - R(\bar{\rho}))}{\rho(s_0 - R(\rho))^2}, \quad (4.14a)$$

with the initial condition:

$$\gamma(0) = -\Theta + \pi - \arcsin \frac{\bar{\rho}(s_0 - R(\bar{\rho}))}{\rho^0(s_0 - R(\rho^0))}. \quad (4.14b)$$

In what follows we distinguish two possible situations $\alpha(T) < \pi/2$ and $\alpha(T) \geq \pi/2$ (modulo 2π). Let us first set

$$f_{s_0, \bar{\rho}}(\rho) = \frac{\bar{\rho}(s_0 - R(\bar{\rho}))}{\rho(s_0 - R(\rho))} \quad (\rho^1 \geq \bar{\rho} \geq 0, s_0 > R(\bar{\rho}), \rho \geq \bar{\rho}). \quad (4.15)$$

- Case $\alpha(T) \leq \pi/2$ (modulo 2π):

In this case, there exist $\bar{t} \in [0, T]$ such that $\sin \alpha(\bar{t}) = 1$, we then have $\bar{\rho} = \rho(\bar{t})$. Note that according to (4.7a), we have $\bar{\rho} = \min_{[0, T]} \rho$. Using the monotonicity properties of ρ , we can see that $t \in [0, \bar{t}] \mapsto \rho(t) \in [\bar{\rho}, \rho^0]$ and $t \in [\bar{t}, T] \mapsto \rho(t) \in [\bar{\rho}, \rho^1]$ are two diffeomorphisms. Thus, using (4.7a)–(4.7c) and the expression (4.11), we deduce that s_0 and $\bar{\rho}$ shall, in addition to $s_0 > R(\bar{\rho})$, satisfy

$$2\Theta = \int_{\bar{\rho}}^{\rho^0} \frac{f_{s_0, \bar{\rho}}(\rho)}{\rho \sqrt{1 - f_{s_0, \bar{\rho}}(\rho)^2}} d\rho + \int_{\bar{\rho}}^{\rho^1} \frac{f_{s_0, \bar{\rho}}(\rho)}{\rho \sqrt{1 - f_{s_0, \bar{\rho}}(\rho)^2}} d\rho \quad (4.16a)$$

and

$$b^0 = \int_{\bar{\rho}}^{\rho^0} \frac{R(\rho)}{\sqrt{1 - f_{s_0, \bar{\rho}}(\rho)^2}} d\rho + \int_{\bar{\rho}}^{\rho^1} \frac{R(\rho)}{\sqrt{1 - f_{s_0, \bar{\rho}}(\rho)^2}} d\rho. \quad (4.16b)$$

The corresponding minimal time is given by

$$T = \int_{\bar{\rho}}^{\rho^0} \frac{d\rho}{\sqrt{1 - f_{s_0, \bar{\rho}}(\rho)^2}} + \int_{\bar{\rho}}^{\rho^1} \frac{d\rho}{\sqrt{1 - f_{s_0, \bar{\rho}}(\rho)^2}}. \quad (4.16c)$$

Note that the above integrals are well-defined as soon as $s_0 > R(\bar{\rho})$.

- Case $\alpha(T) > \pi/2$ (modulo 2π):

In this case, ρ is strictly decreasing and $t \in [0, T] \mapsto \rho(t) \in [\rho^1, \rho^0]$ is a diffeomorphism. Using (4.7a)–(4.7c) and the expression (4.11), we deduce that s_0 and $\bar{\rho}$ shall, in addition to $s_0 > R(\bar{\rho})$, satisfy

$$2\Theta = \int_{\rho^1}^{\rho^0} \frac{f_{s_0, \bar{\rho}}(\rho)}{\rho \sqrt{1 - f_{s_0, \bar{\rho}}(\rho)^2}} d\rho \quad (4.17a)$$

and

$$b^0 = \int_{\rho^1}^{\rho^0} \frac{R(\rho)}{\sqrt{1 - f_{s_0, \bar{\rho}}(\rho)^2}} d\rho. \quad (4.17b)$$

The corresponding minimal time is given by

$$T = \int_{\rho^1}^{\rho^0} \frac{d\rho}{\sqrt{1 - f_{s_0, \bar{\rho}}(\rho)^2}}. \quad (4.17c)$$

Remark 4.0.7.

1. We can have $\alpha(T) > \pi/2$ only if $\Theta < \pi/4$ and $\rho^0 > \rho^1 / \cos(2\Theta)$.
If $\alpha(T) > \pi/2$, then we have $\min_{[0, T]} \rho = \rho^1$ and $\rho'(T) \neq 0$. This together with the convexity result Lemma 3.0.10 leads to the claim of the remark. To clarify the reasoning, we refer to Figure 2.
2. If $\alpha(T) \geq \pi/2$, then $\bar{\rho} > \rho_m$, with

$$\rho_m = \min_{\lambda \in \mathbb{R}} |x^0 + \lambda(x^1 - x^0)| = \sqrt{|x^0|^2 - \left\langle \frac{x^1 - x^0}{|x^1 - x^0|}, x^0 \right\rangle^2}.$$

In fact, this relation is obvious if $\bar{\rho} = \rho^1$. If $\bar{\rho} < \rho^1$, then for every $\tau > 0$, the optimal trajectory can be continued on $[T, T + \tau]$, to create a new optimal path for some other initial buffer $b_\tau^0 > b^0$. Knowing that at time T , $\rho(T) = \rho^1$, this result can be proved using the convexity result Lemma 3.0.10 for $t_1 < T$ and $t_2 > T$. This is illustrated on Figure 3.

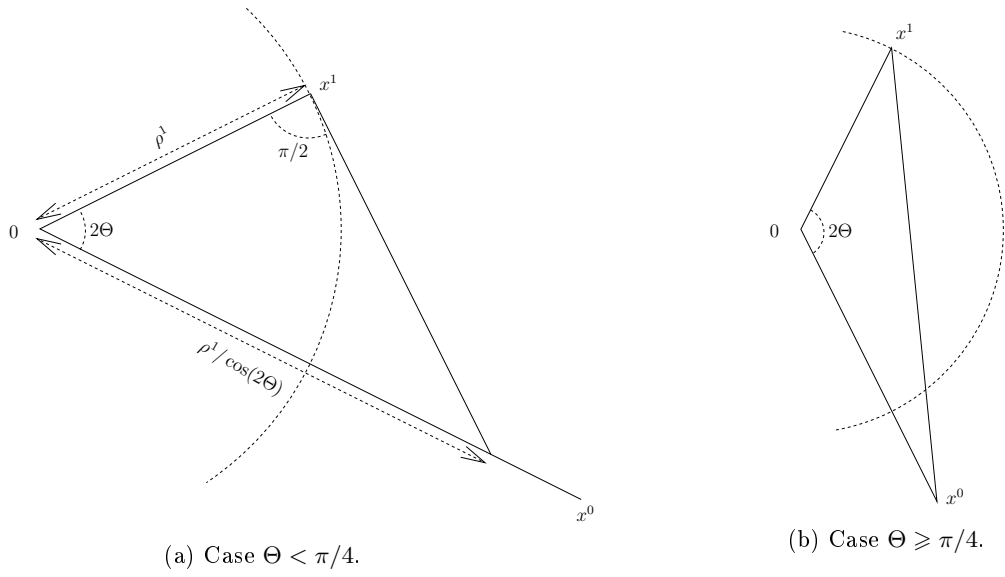

Figure 2: Illustration of the 1st claim of Remark 4.0.7.

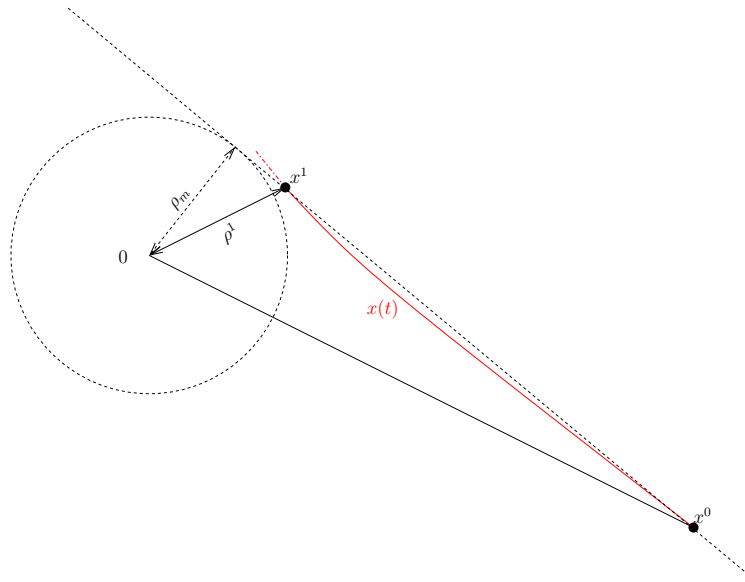

Figure 3: Illustration of the 2nd claim of Remark 4.0.7.

3. In any cases, if $(s_0, \bar{\rho})$ is a solution to the equation (4.16b) or (4.17b), with $b^0 > 0$, we necessarily have $\bar{\rho} > 0$.

Remark 4.0.8. In both situations, the time t , the angle θ and the buffer size b can be recovered in term of ρ , for instance, in the situation $\alpha(T) < \pi/2$, we set,

$$\bar{t} = \int_{\bar{\rho}}^{\rho^0} \frac{dr}{\sqrt{1 - f_{s_0, \bar{\rho}}(r)^2}}$$

and for $t \leq \bar{t}$, we have,

$$t = t(\rho) = \int_{\rho}^{\rho^0} \frac{dr}{\sqrt{1 - f_{s_0, \bar{\rho}}(r)^2}}$$

and for $t \geq \bar{t}$, we have,

$$t = t(\rho) = \bar{t} + \int_{\bar{\rho}}^{\rho} \frac{dr}{\sqrt{1 - f_{s_0, \bar{\rho}}(r)^2}}.$$

Let us also define for $\epsilon = \pm 1$ the maps

$$J_{\epsilon}^T(s_0, \bar{\rho}) = \int_{\bar{\rho}}^{\rho^0} \frac{d\rho}{\sqrt{1 - f_{s_0, \bar{\rho}}(\rho)^2}} + \epsilon \int_{\bar{\rho}}^{\rho^1} \frac{d\rho}{\sqrt{1 - f_{s_0, \bar{\rho}}(\rho)^2}}, \quad (4.18a)$$

$$C_{\epsilon}^{\Theta}(s_0, \bar{\rho}) = \int_{\bar{\rho}}^{\rho^0} \frac{f_{s_0, \bar{\rho}}(\rho) d\rho}{\rho \sqrt{1 - f_{s_0, \bar{\rho}}(\rho)^2}} + \epsilon \int_{\bar{\rho}}^{\rho^1} \frac{f_{s_0, \bar{\rho}}(\rho) d\rho}{\rho \sqrt{1 - f_{s_0, \bar{\rho}}(\rho)^2}} \quad (4.18b)$$

and

$$C_{\epsilon}^b(s_0, \bar{\rho}) = \int_{\bar{\rho}}^{\rho^0} \frac{R(\rho) d\rho}{\sqrt{1 - f_{s_0, \bar{\rho}}(\rho)^2}} + \epsilon \int_{\bar{\rho}}^{\rho^1} \frac{R(\rho) d\rho}{\sqrt{1 - f_{s_0, \bar{\rho}}(\rho)^2}}, \quad (4.18c)$$

and the sets

$$E_{\epsilon} = \left\{ (s_0, \bar{\rho}) \in \mathbb{R}_+ \times [0, \rho^1] \mid s_0 \geq R(\bar{\rho}), C_{\epsilon}^{\Theta}(s_0, \bar{\rho}) = 2\Theta \text{ and } C_{\epsilon}^b(s_0, \bar{\rho}) = b^0 \right\}. \quad (4.19)$$

We are now in a position to give the main result.

Theorem 4.0.9. *Let $x^0, x^1 \in \mathbb{R}^d$ and $b^0 \in \mathbb{R}_+$ satisfying the Assumption 2, and let (T, u) be a minimizer of (2.3). Let us define $\rho^0 = \min\{|x^0|, |x^1|\}$ and $\rho^1 = \max\{|x^0|, |x^1|\}$. Then $T = \min\{T_{-1}, T_{+1}\}$, where for $\epsilon = \pm 1$, T_{ϵ} is the minimum of J_{ϵ}^T (defined by (4.18a)) on the set E_{ϵ} (defined by (4.19)) (by convention, we have set $T_{\epsilon} = \infty$ if $E_{\epsilon} = \emptyset$).*

In addition, once $\epsilon \in \{-1, 1\}$ and the parameters s_0 and $\bar{\rho}$ minimizing J_{ϵ}^T on E_{ϵ} are found, the control $u = e^{i\gamma}$ can be recovered from (4.14), and the state trajectories can be recovered by using the process described in Remark 4.0.8.

Recall that according to Remark 4.0.7, we already know that $E_{-1} = \emptyset$ for $\Theta \geq \pi/4$ or for $\Theta < \pi/4$ and $\rho^0 \leq \rho^1 / \cos(2\Theta)$. The problem is now to minimize J_{ϵ}^T on the set E_{ϵ} . We conjecture that the set E_{ϵ} is the empty set or a singleton. Proving such a fact does not seem to be an easy task. However, we can make the next remark ensuring that s_0 is uniquely determined by $\bar{\rho}$.

Remark 4.0.10. Let $\bar{\rho} \in (0, \rho^1]$, then when (4.9) holds, for every $\epsilon \in \{-1, 1\}$, there exists at most one $s_0 = s_0(\bar{\rho})$ such that $(s_0, \bar{\rho}) \in E_{\epsilon}$.

Let us first recall that according to the 3rd claim of Remark 4.0.7, we necessarily have $R(\bar{\rho}) > 0$. To prove the claim of the remark, we first define,

$$I_{\Theta}^{\hat{\rho}}(s_0, \bar{\rho}) = \int_{\bar{\rho}}^{\hat{\rho}} \frac{f_{s_0, \bar{\rho}}(\rho)}{\rho \sqrt{1 - f_{s_0, \bar{\rho}}(\rho)^2}} d\rho \quad (\hat{\rho} \in \mathbb{R}_+^*, (s_0, \bar{\rho}) \in D(\hat{\rho})),$$

where $D(\hat{\rho}) = \{(s_0, \bar{\rho}) \in \mathbb{R}_+ \times (0, \hat{\rho}) \mid s_0 > R(\bar{\rho}) > 0\}$, and where $f_{s_0, \bar{\rho}}$ is given by (4.15). Note that we have:

$$C_{\epsilon}^{\Theta}(s_0, \bar{\rho}) = I_{\Theta}^{\rho^0}(s_0, \bar{\rho}) + \epsilon I_{\Theta}^{\rho^1}(s_0, \bar{\rho}).$$

Note also that the above functions are continuously differentiable on $D(\hat{\rho})$ for every $\hat{\rho} > 0$, and, after some computations, we obtain,

$$\partial_{s_0} I_{\Theta}^{\hat{\rho}}(s_0, \bar{\rho}) = \int_{\bar{\rho}}^{\hat{\rho}} \frac{\partial_{s_0} f_{s_0, \bar{\rho}}(\rho)}{\rho (1 - f_{s_0, \bar{\rho}}(\rho)^2)^{3/2}} d\rho,$$

with,

$$\partial_{s_0} f_{s_0, \bar{\rho}}(\rho) = \frac{\bar{\rho} (R(\bar{\rho}) - R(\rho))}{\rho (s_0 - R(\rho))^2}.$$

Using the monotonicity of R , we obtain (recall that $R(\bar{\rho}) > 0$) that

$$\partial_{s_0} \left(I_{\Theta}^{\rho^0}(s_0, \bar{\rho}) + \epsilon I_{\Theta}^{\rho^1}(s_0, \bar{\rho}) \right) > 0.$$

This in particular ensures that given $\bar{\rho}$, there exist at most one $s_0 = s_0(\bar{\rho})$ such that

$$2\Theta = I_{\Theta}^{\rho^0}(s_0(\bar{\rho}), \bar{\rho}) + \epsilon I_{\Theta}^{\rho^1}(s_0(\bar{\rho}), \bar{\rho}).$$

Furthermore, if such an s_0 exist, then, using the implicit function Theorem, $\bar{\rho} \mapsto s_0(\bar{\rho})$ is absolutely continuous.

5 Numerical example with a particular choice of transmission rate

Let us first define the transmission rate R used to provide some numerical simulations. We chose R defined by

$$R(\rho) = Q(a(\rho - \rho_0)) \quad (\rho \geq 0), \quad (5.1)$$

where ρ_0 is a non-negative constant, and Q is the Q -function given by $Q(\rho) = \frac{1}{\sqrt{2\pi}} \int_{\rho}^{\infty} e^{-\tau^2/2} d\tau$. The expected rate is of this form when packets of a fixed size are received only if the SNR is above a certain threshold, where the SNR depends on both the path loss and a random Gaussian variable due to fast fading in the wireless channel, see [9]. For the practical examples below, we chose $\rho_0 = 3$ and $a = 2$. The corresponding graph of $\rho \mapsto R(\rho)$ is displayed on Figure 4, which is similar to the rate function for a fixed modulation given in [11, Figure 2].

Let us precise our choice of initial and final conditions. We place ourselves in the case $d = 2$, and we set $x^1 = \rho^1 e^{i\Theta}$ and $x^0 = \rho^0 e^{-i\Theta}$, with $\Theta = \pi/8$, $\rho^1 = 2$ and $\rho^0 = 2\rho^1 / \cos(2\Theta)$. This choice has been made in order to allow the existence of a minimizer of J_{-1}^T on the set E_{-1} (see Remark 4.0.7). Let us define $b_0^0 = B(x^0, x^1)$ and $b_{20}^0 = B(x^0, 0) + B(0, x^1)$. Numerically we obtain $b_0^0 \simeq 1.4858$ and $b_{20}^0 \simeq 4.9958$, for the initial condition on b , we will take $b^0 = b_k^0$, with $b_k^0 = b_0^0 + k(b_{20}^0 - b_0^0)/20$, for $k = 0, \dots, 20$. In order to also show the optimal trajectory in

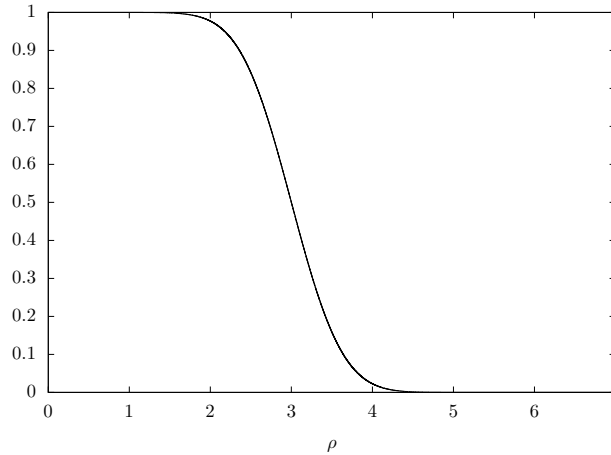

Figure 4: Illustration of the transmission rate function R , given by (5.1), for $\rho_0 = 3$ and $a = 2$.

the situations given by Propositions 3.0.5 and 3.0.6, we will also consider the initial conditions $b^0 = 2b_0^0/3 < b_0^0$ and $b^0 = b_{20}^0 + b_0^0/2 > b_{20}^0$. In order to obtain the optimal solution for the given initial condition b^0 , we chose to use the property claimed in Remark 4.0.10, that is to say that for every $\bar{\rho} \in [0, \rho^1]$, and every $\epsilon \in \{-1, +1\}$ we try to compute an $s_0 \geq R(\bar{\rho})$ such that $C_\epsilon^\Theta(s_0, \bar{\rho}) = 2\Theta$. The results of these computations are given on Figure 5a, and the computation has been done with the `fsolve` function of `matlab`. Once s_0 is known in term of ϵ and $\bar{\rho}$, we draw the corresponding buffer and time, see Figures 5b and 5c.

Let us also mention that in order to numerically compute the integrals given in (4.16) and (4.17), we use the midpoint rule, which is known to be convergent for improper integrals. For the computation presented here, we have used 10^5 discretization points.

On Figure 5b, we observe that given $b^0 \in (b_0^0, b_{20}^0)$, there exist one and only one corresponding value for $\bar{\rho}$ and ϵ , leading to the time optimal solution.

Finally, on Figure 6, we display the optimal state trajectories associated to b_0^0, \dots, b_{20}^0 .

6 Conclusions

In this paper, we design a time-optimal control strategy allowing a mobile robot to reach a target while transmitting a message in minimum time. We consider one of the simplest situations in which there is only one antenna, there are no shadowing effects (the transmission rate only depend on the distance to the antenna) and the dynamics of the robot is described by a single integrator. In this framework, we give both a theoretical description of the optimal control and a strategy for its numerical implementation. Further works should consider the presence of multiple antennas and noises.

References

- [1] A. A. Agrachev and Y. L. Sachkov. *Control theory from the geometric viewpoint*, volume 87 of *Encyclopaedia of Mathematical Sciences*. Springer-Verlag, Berlin, 2004. Control Theory and Optimization, II.

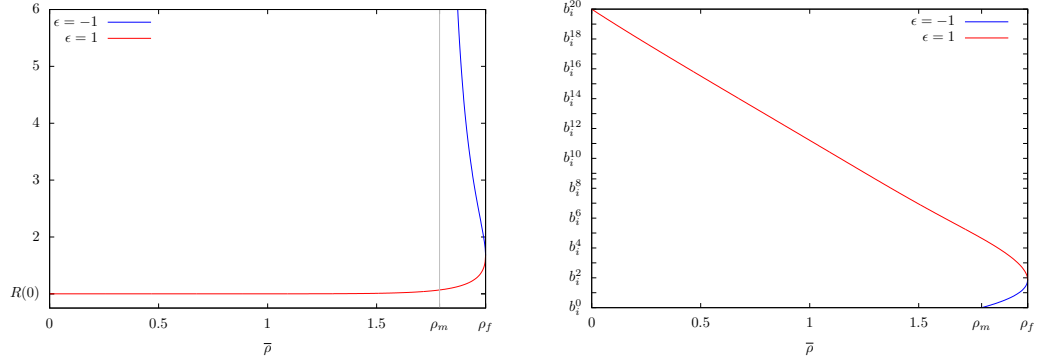

(a) Value of $s_0 = s_0(\bar{\rho}; \epsilon)$. ρ_m was introduced in the 3rd claim of Remark 4.0.7.

(b) Value of $C_\epsilon^b(s_0, \bar{\rho})$, with $s_0 = s_0(\bar{\rho}; \epsilon)$ given in Figure 5a.

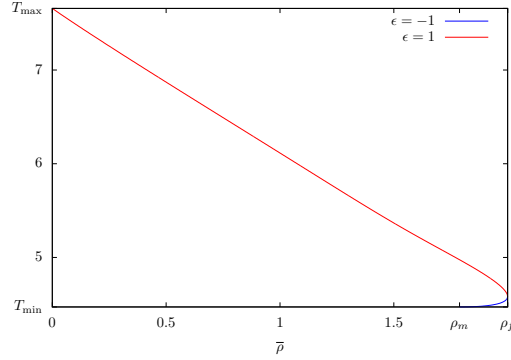

(c) Value of $J_\epsilon^T(s_0, \bar{\rho})$, with $s_0 = s_0(\bar{\rho}; \epsilon)$ given in Figure 5a. $T_{\min} = |x^1 - x^0|$ and $T_{\max} = |x^0| + |x^1|$.

Figure 5: Computation of s_0 such that $C_\epsilon^\Theta(s_0, \bar{\rho}) = 2\Theta$ and associated values of C_ϵ^b and J_ϵ^T . Explicit values of ρ^0 , ρ^1 and Θ are given in the introduction of Section 5.

- [2] U. Ali, H. Cai, Y. Mostofi, and Y. Wardi. Motion-communication co-optimization with cooperative load transfer in mobile robotics: an optimal control perspective. *IEEE Transactions on Control of Network Systems*, 2018.
- [3] U. Ali and Y. Wardi. Multiple shooting technique for optimal control problems with application to power aware networks. *IFAC-PapersOnLine*, 48(27):286–290, 2015.
- [4] U. Ali, Y. Yan, Y. Mostofi, and Y. Wardi. An optimal control approach for communication and motion co-optimization in realistic fading environments. In *2015 American Control Conference (ACC)*, pages 2930–2935. IEEE, 2015.
- [5] A. V. Arutyunov, D. Y. Karamzin, and F. L. Pereira. The maximum principle for optimal control problems with state constraints by R. V. Gamkrelidze: revisited. *J. Optim. Theory Appl.*, 149(3):474–493, 2011.

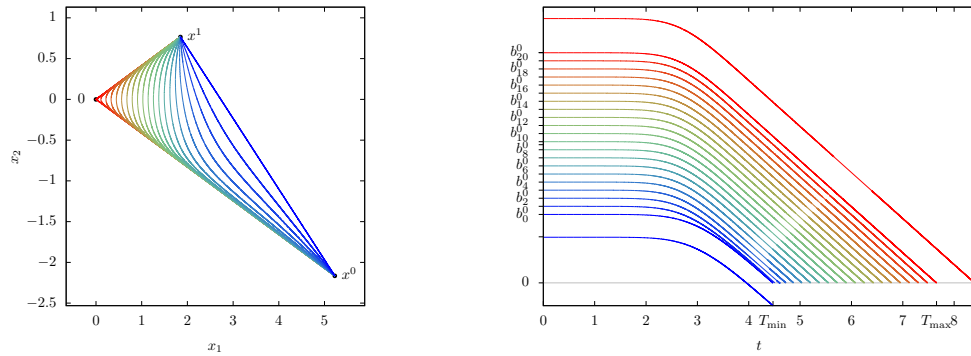

(a) Time optimal path of the robot for $b^0 \in \{b_0^0, \dots, b_{20}^0\}$.

(b) Time optimal buffer discharge of the robot for $b^0 \in \{b_0^0, \dots, b_{20}^0\}$.

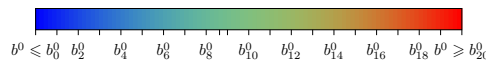

(c) Color-map for the different values of b^0 .

Figure 6: Time optimal state trajectories for different values of b^0 . Explicit values of x^0 and x^1 are given in the introduction of Section 5.

- [6] D. Bonilla, V. Varma, S. Lasaulce, J. Daafouz, and M. Ghogho. Trajectory planning for energy-efficient robots with communications constraints. In *The International Conference on Wireless Networks and Mobile Communications, Wincom'16*, Fez, Morocco, Oct. 2016.
- [7] F. Bullo, J. Cortés, and S. Martínez. *Distributed control of robotic networks*. Princeton Series in Applied Mathematics. Princeton University Press, Princeton, NJ, 2009. A mathematical approach to motion coordination algorithms.
- [8] L. Cesari. *Optimization—theory and applications*, volume 17 of *Applications of Mathematics (New York)*. Springer-Verlag, New York, 1983. Problems with ordinary differential equations.
- [9] M. Chiani, D. Dardari, and M. K. Simon. New exponential bounds and approximations for the computation of error probability in fading channels. *IEEE Transactions on Wireless Communications*, 2(4):840–845, 2003.
- [10] S. M. Das, Y. C. Hu, C. G. Lee, and Y.-H. Lu. An efficient group communication protocol for mobile robots. In *Robotics and Automation, 2005. ICRA 2005. Proceedings of the 2005 IEEE International Conference on*, pages 87–92. IEEE, IEEE, 2005.
- [11] G. Holland, N. Vaidya, and P. Bahl. A rate-adaptive mac protocol for multi-hop wireless networks. In *Proceedings of the 7th annual international conference on Mobile computing and networking*, pages 236–251. ACM, 2001.
- [12] A. D. Ioffe and V. M. Tihomirov. *Theory of extremal problems*, volume 6 of *Studies in Mathematics and its Applications*. North-Holland Publishing Co., Amsterdam-New York, 1979. Translated from the Russian by Karol Makowski.

- [13] H. Jaleel, Y. Wardi, and M. Egerstedt. Minimizing mobility and communication energy in robotic networks: An optimal control approach. In *2014 American Control Conference*, pages 2662–2667. IEEE, 2014.
- [14] V. Jurdjevic. *Geometric control theory*, volume 52 of *Cambridge Studies in Advanced Mathematics*. Cambridge University Press, Cambridge, 1997.
- [15] R. M. Murray. Recent research in cooperative control of multivehicle systems. *Journal of Dynamic Systems, Measurement, and Control*, 129(5):571–583, 05 2007.
- [16] C. C. Ooi and C. Schindelhauer. Minimal energy path planning for wireless robots. *Mobile Networks and Applications*, 14(3):309–321, Jun 2009.
- [17] B. T. Schemm. LTE: the evolution of mobile broadband. *IEEE Communications magazine*, 45:44–51, 2009.
- [18] T. Ue, S. Sampei, N. Morinaga, and K. Hamaguchi. Symbol rate and modulation level-controlled adaptive modulation/tdma/tdd system for high-bit-rate wireless data transmission. *IEEE Transactions on Vehicular Technology*, 47(4):1134–1147, 1998.
- [19] N. Wang, N. Zhang, and M. Wang. Wireless sensors in agriculture and food industry—Recent development and future perspective. *Computers and Electronics in Agriculture*, 50(1):1–14, 2006.