



HAL
open science

Fractionation of Biomolecules from Microalgae: Characterization of Membranes Fouled by Lipids

S. Liu, V Drevet, E Clavijo Rivera, L Villafaña López, M Frappart, M Rabiller-Baudry, Estelle Couallier, Anthony Szymczyk

► To cite this version:

S. Liu, V Drevet, E Clavijo Rivera, L Villafaña López, M Frappart, et al.. Fractionation of Biomolecules from Microalgae: Characterization of Membranes Fouled by Lipids. International Conference on Membranes In Drinking And Industrial Water Production (MDIWP), Feb 2017, Leeuwarden, Netherlands. hal-02353508

HAL Id: hal-02353508

<https://hal.science/hal-02353508v1>

Submitted on 7 Nov 2019

HAL is a multi-disciplinary open access archive for the deposit and dissemination of scientific research documents, whether they are published or not. The documents may come from teaching and research institutions in France or abroad, or from public or private research centers.

L'archive ouverte pluridisciplinaire **HAL**, est destinée au dépôt et à la diffusion de documents scientifiques de niveau recherche, publiés ou non, émanant des établissements d'enseignement et de recherche français ou étrangers, des laboratoires publics ou privés.

Fractionation of Biomolecules from Microalgae: Characterization of Membranes Fouled by Lipids

S. Liu¹, V. Drevet², E. Clavijo Rivera¹, L. Villafaña López¹, M. Frappart¹, M. Rabiller-Baudry², E. Couallier¹, A. Szymczyk²

¹ CNRS, Université de Nantes, GEPEA, Université Bretagne Loire, Saint Nazaire, France

² Université de Rennes 1, Institut des Sciences Chimiques de Rennes, UMR CNRS 6226, Rennes, France

Context

The use of microalgae for the production of biofuels and renewable feedstocks is an extremely promising sustainable technology. However, there are still challenges for its large scale implementation. The harvesting and extraction steps are two main areas of improvement. Harvested microalgae have to be grinded and lipids extracted, concentrated and purified. This downstream processing can be implemented by several processes within membrane filtration.

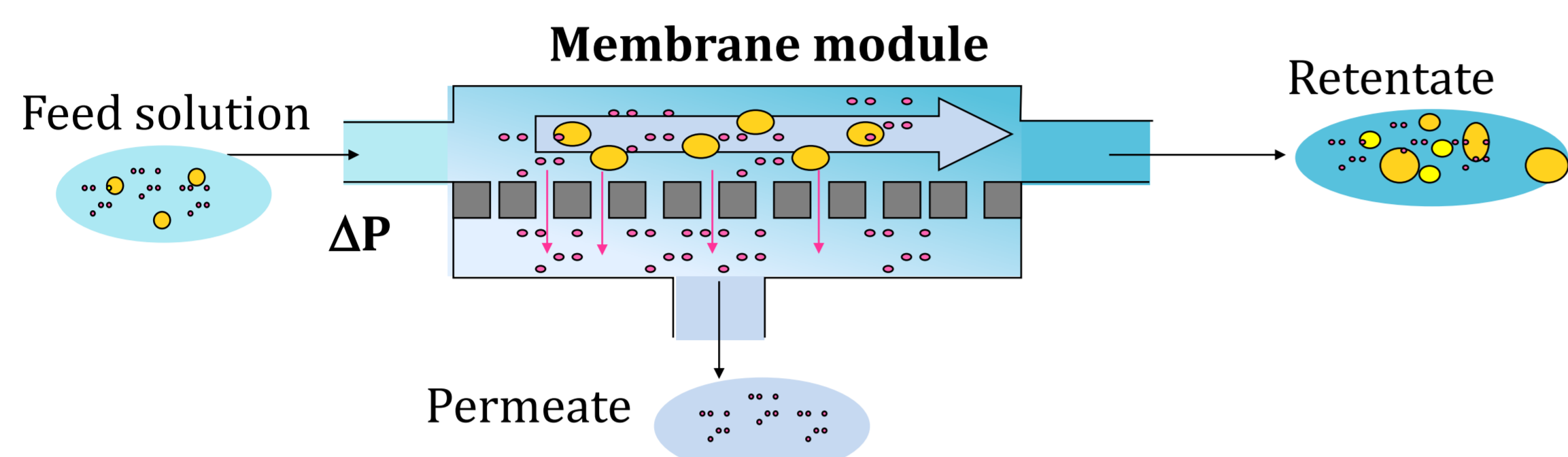

However, the integration of membrane processes is not trivial, considering the complexity of solutions to be handled, i.e. mixtures containing cell debris, organic and mineral compounds. In this work, several commercial membranes with different hydrophilic/hydrophobic properties and molecular weight cut-offs were screened aiming at limiting the fouling due to hydrophobic interactions between oil and membrane during filtration. Membrane fouling by lipids was investigated by means of ATR-FTIR spectroscopy and zeta potential measurements.

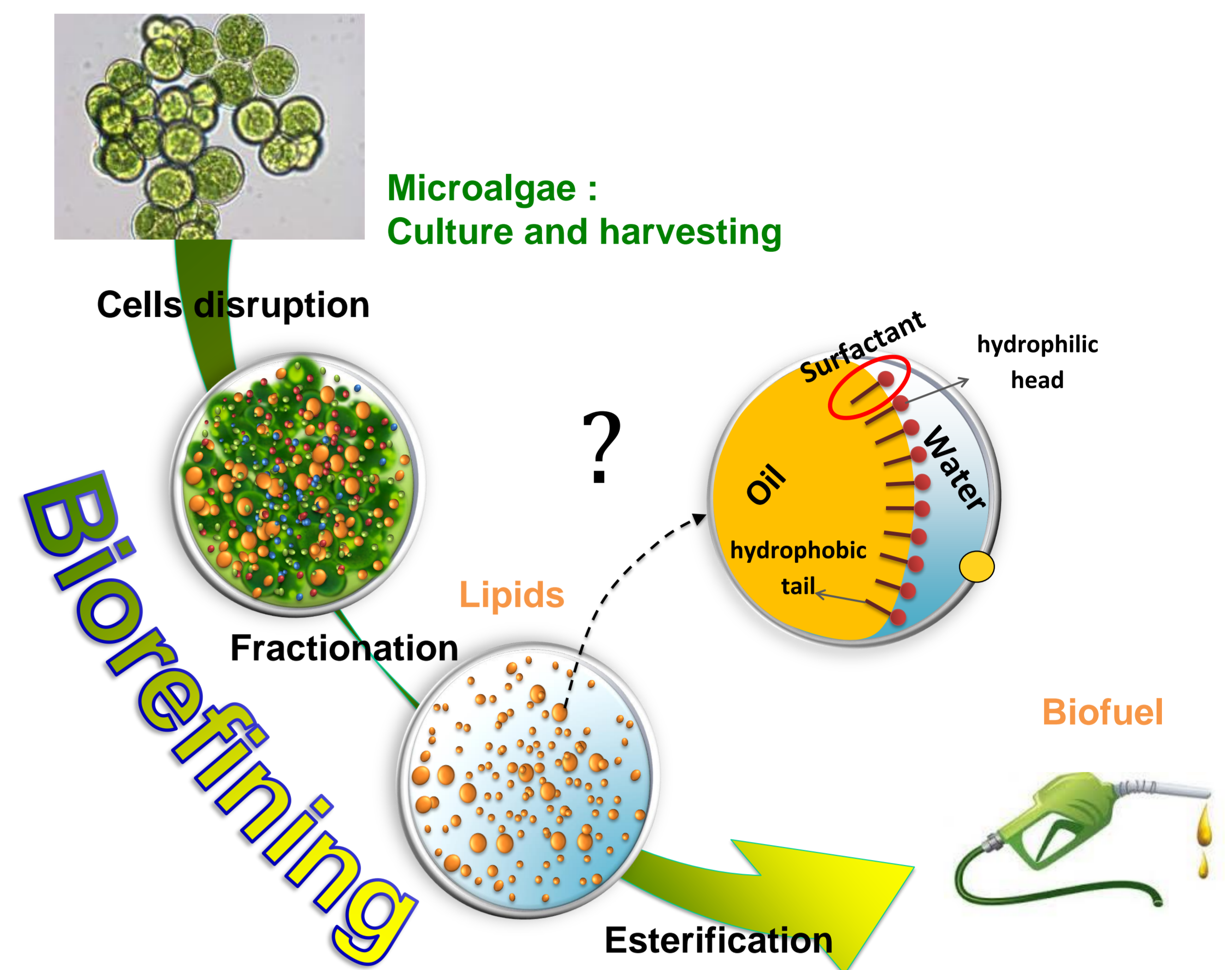

Material and methods

Membranes:

- Polyethersulfone 200 kDa (PES Orelis)
- Polyacrylonitrile 500 kDa (PAN Orelis)

Oil: Vegetable Oil (TAGs, free fatty acids)

Membrane conditioning:

Characterization: Sonication (2 min) in (i) Water/EtOH (v/v) and (ii) Milli Q water

Membrane fouling:

Characterization: Soaking in oil for 2 hours (fouling by adsorption)

Membrane characterization:

- ATR FTIR (Jasco 4100)
- Streaming current measurements (SurPASS, Anton Paar, Austria) : pressure ramp: from 0 to 300 mbar.

Filtration set-up:

Ray-Flow module: membrane surface area 129 cm²

Filtration with PAN:

$P_{critical} = 0.4$ bar
TMP = 0.38 bar

Filtration PES:

$P_{critical} = 0.3 - 1.5$ bar
TMP = 0.25 - 1 bar

T=30°C
v = 3 m s⁻¹
VRR= 1 → 4

Emulsion containing 2% of vegetable oils and polar lipids representative of a supernatant of grinded microalgae

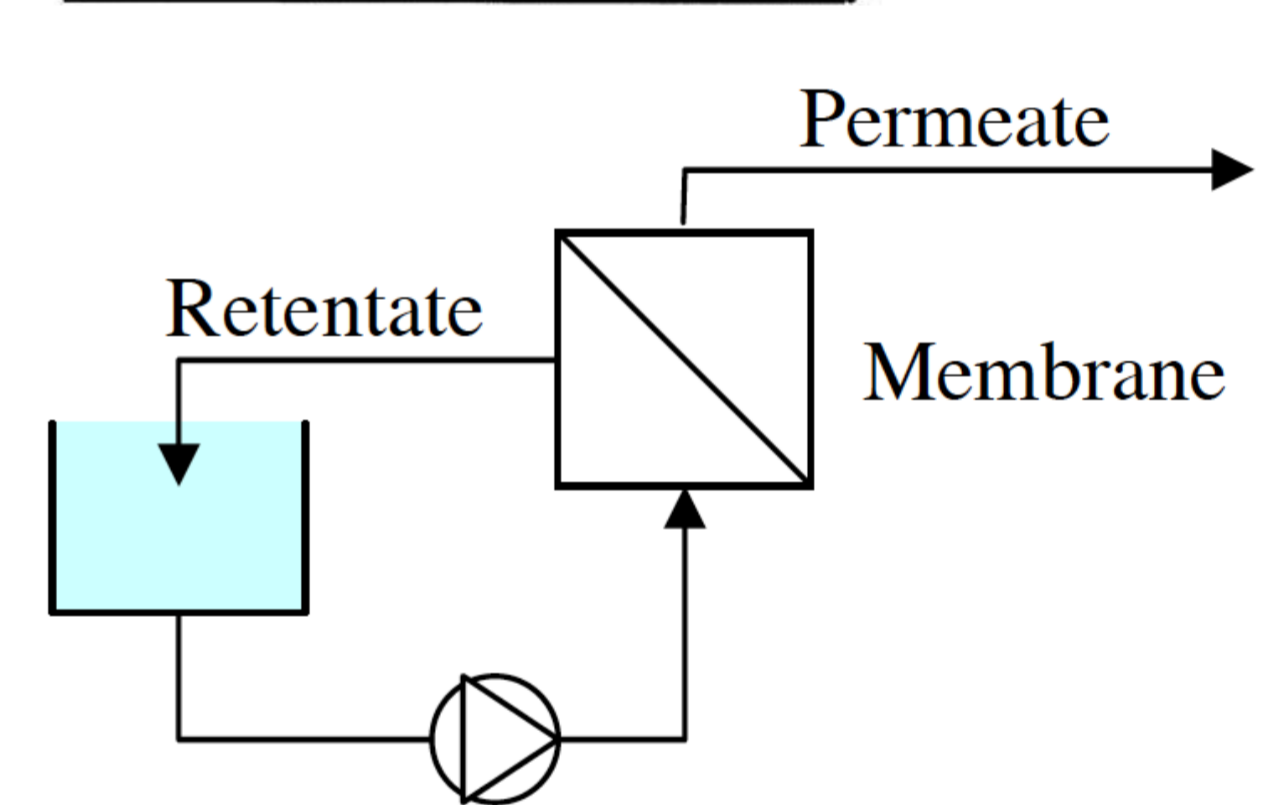
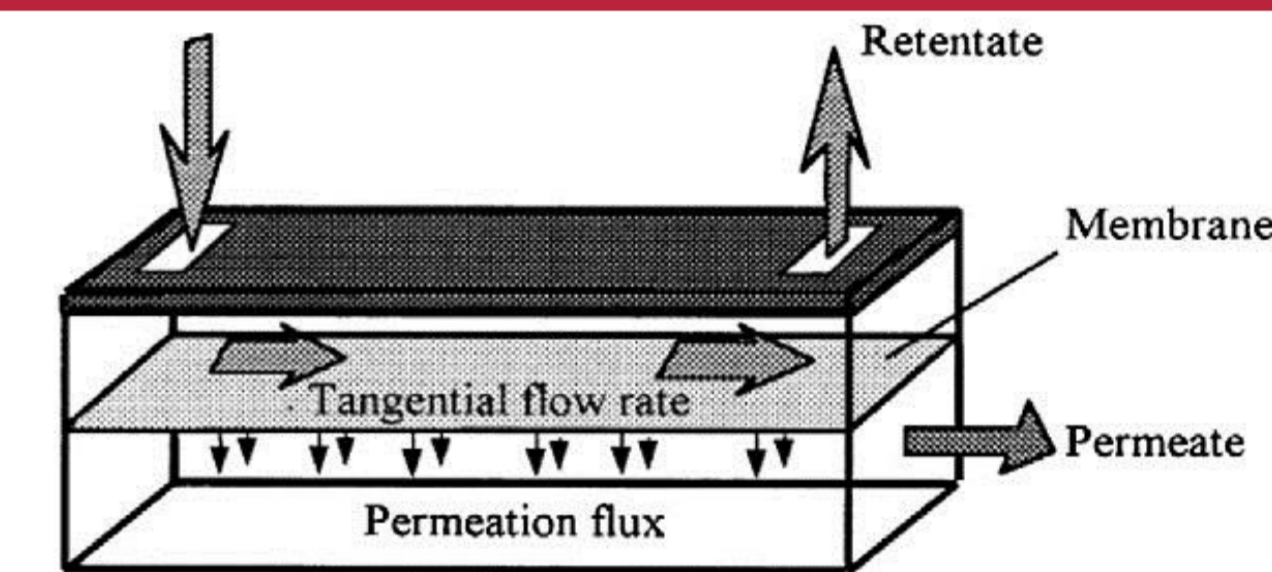

Concentration mode

Results

Impact of fouling on the permeate flux

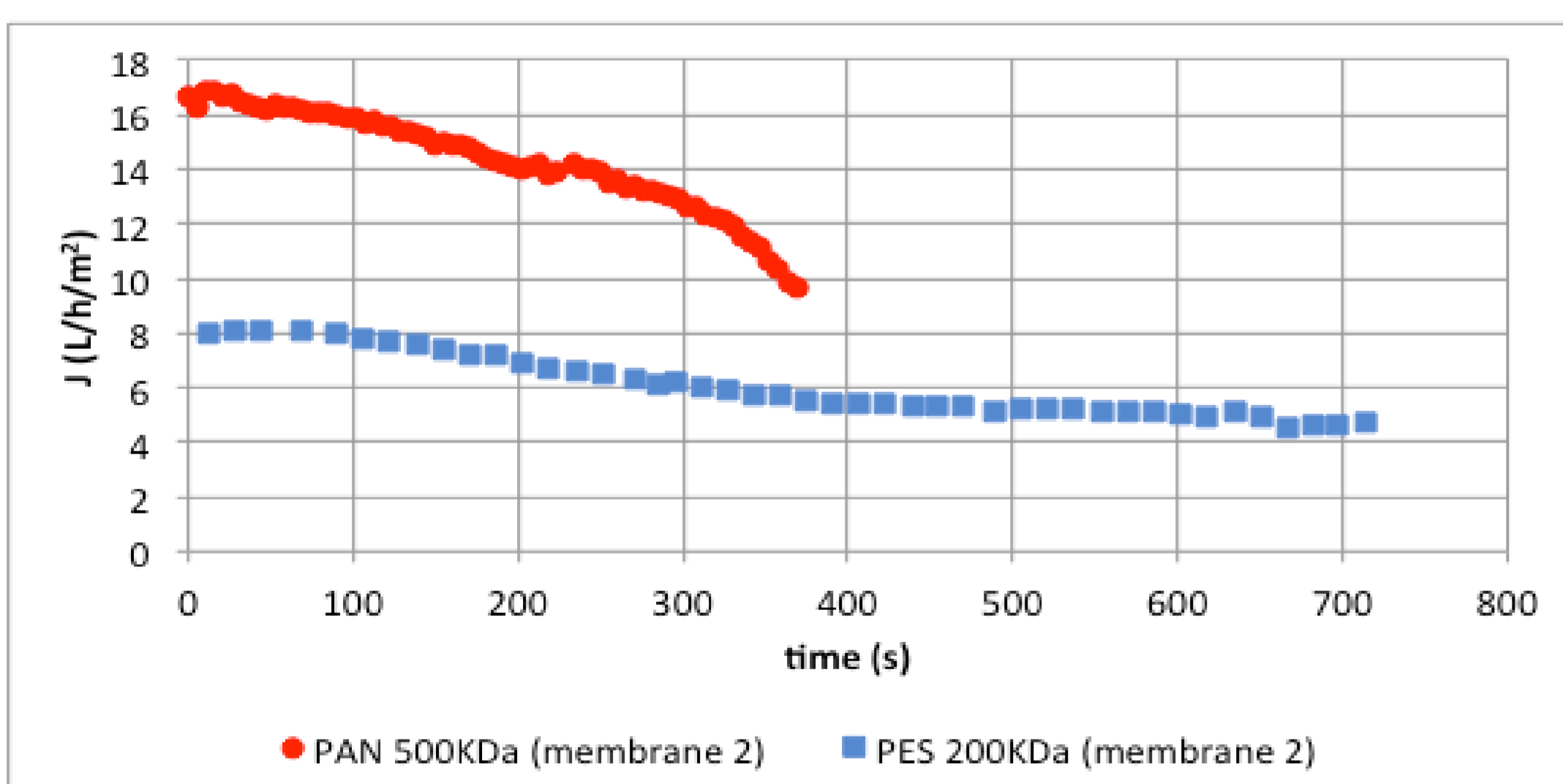

- The fouling mechanisms are not the same for the PAN and PES membranes.
- The flux analysis (Hermia, 1981) did not allow to highlight a major fouling mechanism among intermediate and complete pore blocking, pore constriction or cake filtration.
- Physico-chemical interactions may be preponderant in the fouling: local characterization of the fouling is necessary for a better understanding.

Evidence of fouling by lipids from ATR-FTIR analysis

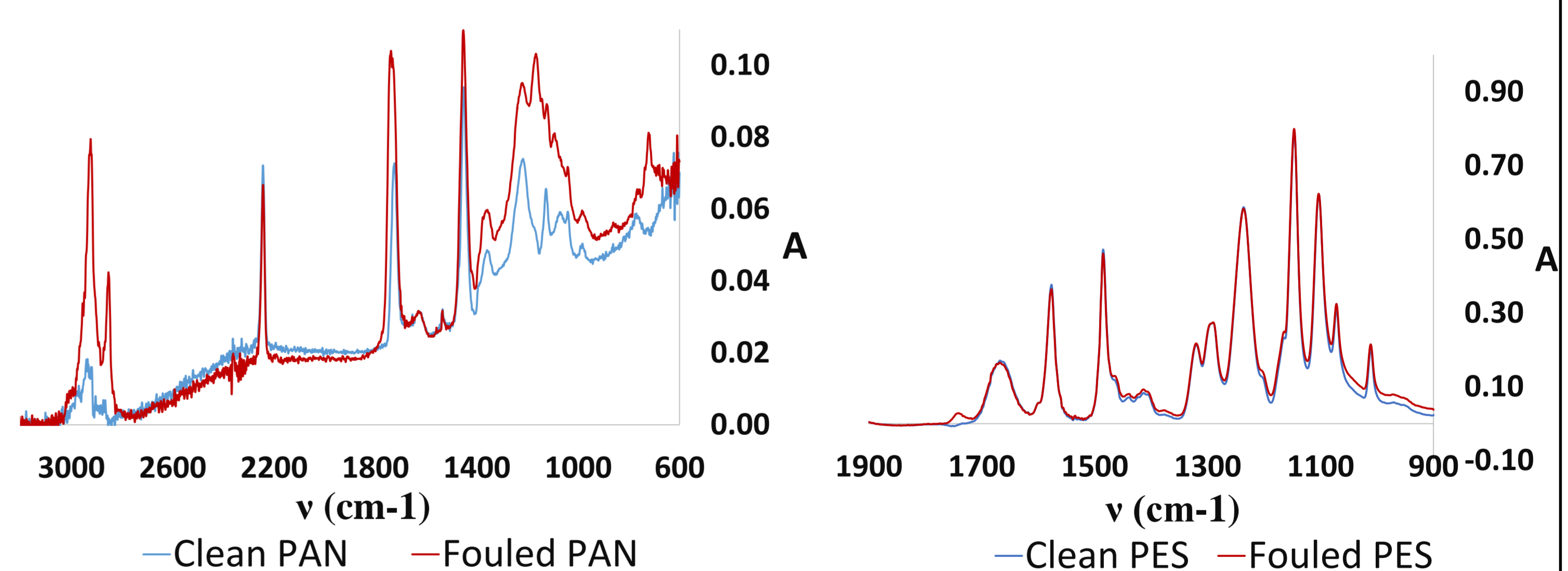

- Appearance of oil characteristic band at 2922 cm⁻¹ ($\nu_{as}CH_2$) and 2852 cm⁻¹, 1744 cm⁻¹ (δ_{C-O}) and between 1000 - 1400 cm⁻¹.
- Oil less visible for PES because of higher absorbance of the membrane, fouling visible by oil band at 1744 cm⁻¹.

	PAN 500 kDa		PES 200 kDa	
	membrane 1	membrane 2	membrane 1	membrane 2
LP_{water} (L/h/m ² /bar) 30°C	337.8	82.2	129.1	20.3
$LP_{emulsion}$ (L/h/m ² /bar) 30°C	156.6	43.7	57.0	8.0
$LP_{emulsion} / LP_{water}$	0.5	0.5	0.4	0.4
J (L/h/m ²)	64.1	16.6	14.3	8.1
TMP (bar)	0.37	0.38	0.25	1.01
Membrane résistance R_m (m ⁻¹)	1.3E+09	5.5E+09	3.5E+09	2.2E+10
Total resistance R_{tot} (m ⁻¹)	1.7E+10	1.4E+10	2.4E+10	9.7E+10
Retention rate	96.4 %	96.7 %	97.4 %	98.0 %

Impact of fouling by lipids on the membrane zeta potential

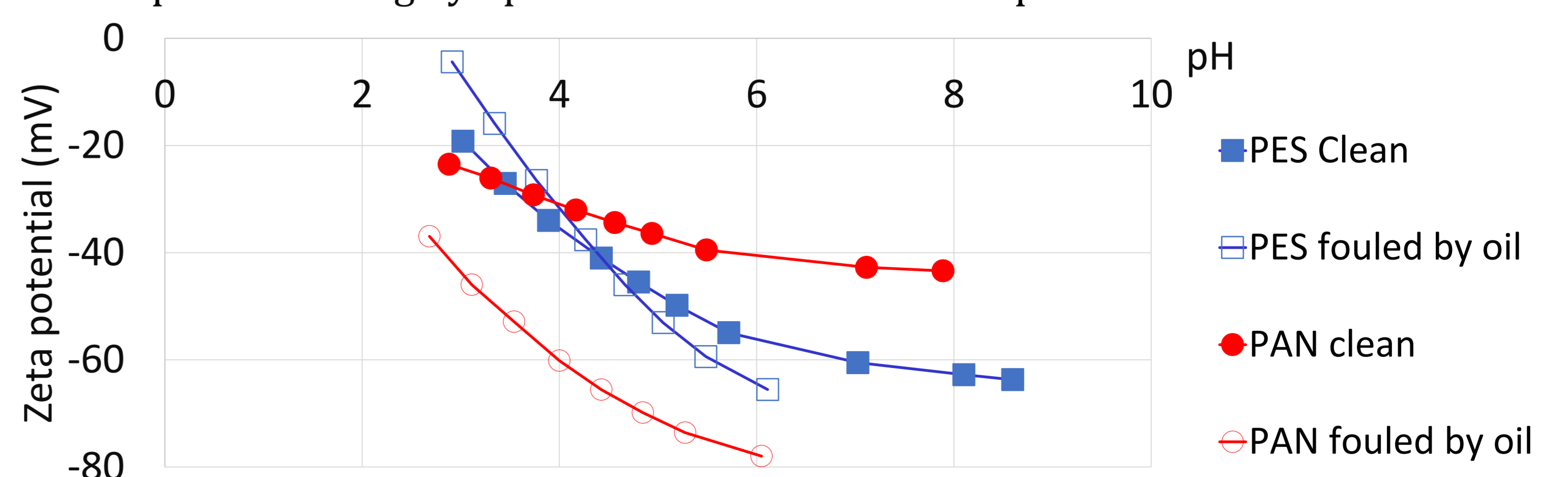

- The PES membrane isoelectric point increases after fouling
- The PAN membrane surface charge is more negative after fouling
- Fouling has more impact on the PAN membrane surface charge

Acknowledgments

The authors are grateful for their financial support to the GIS Europe Mer through the research program MACCLIME, and the CNRS through the interdisciplinary research program Algues-Molécules-Territoire.