

# Towards a beam-tagging diamond hodoscope for online ion range monitoring



S. Curtoni, G. Bosson, J. Bouvier, J. Collot, D. Dauvergne, JY. Hostachy, L. Gallin-Martel, ML. Gallin-Martel, A. Ghimouz, J. Livingstone, S. Marcatili, JF. Muraz, F.E. Rarbi, O. Rossetto, M. Yamouni



F. Haddad, C. Koumeir



V. Métivier, N. Servagent



E. Testa



JM. Létang

# Ion range uncertainties

## Ideal treatment plan

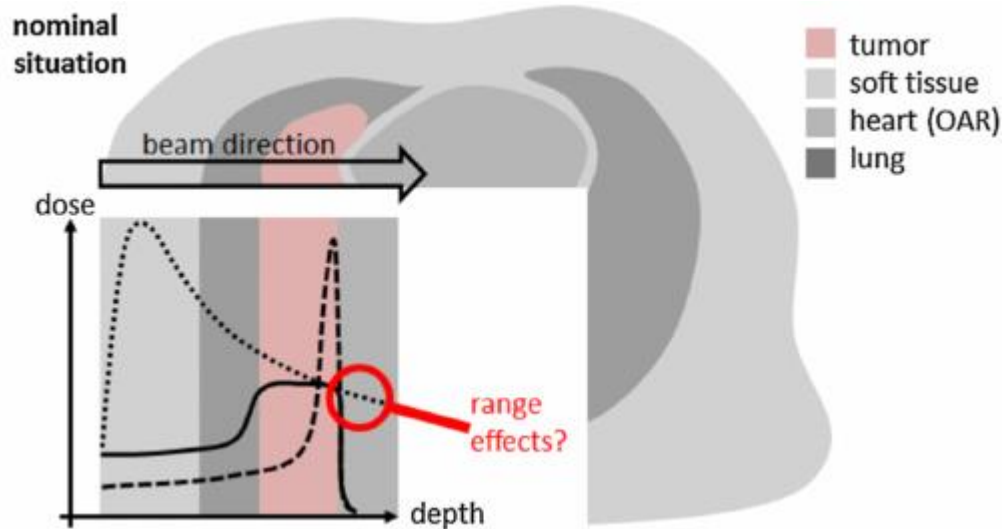

## Effect of tissues heterogeneities

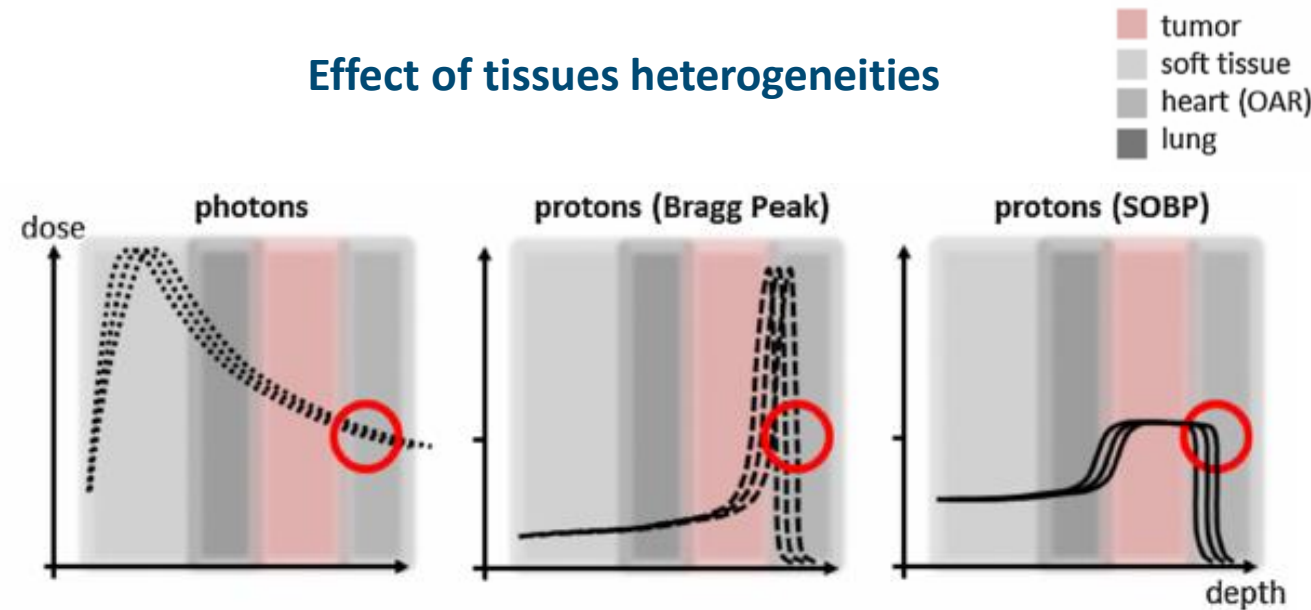

Knopf and Lomax, Phys. Med. Biol. **58** (2013) R131–R160

## Uncertainties

- Treatment planning
- Patient positioning
- Organ motion
- Morphological evolution of tumor volume through treatment



**Security margins on actual range  
(ex : 1 cm for 20 cm prescribed range)**



**Need for an online ion range monitoring system**

## Production of secondary particles

### Geant4 simulation

160 MeV protons  
in water target

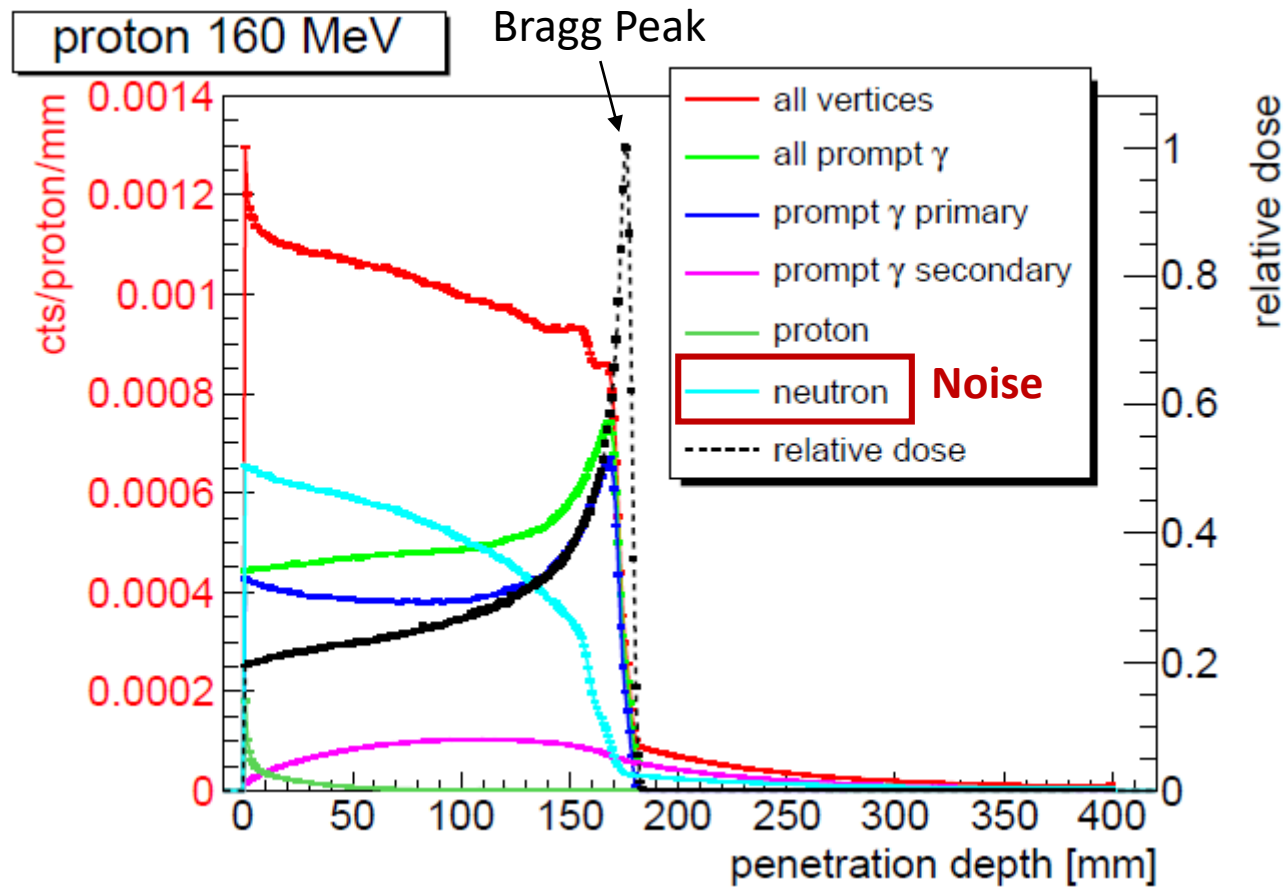

Krimmer et al., Nucl. Instr. Meth. A, **878** (2017) 58-73

### CLaRyS collaboration

CLaRyS: Contrôle en Ligne de l'hadronthérapie par détection de Rayonnements Secondaires

4 laboratories: LPSC, IPNL, CPPM, CREATIS Lyon

# Prompt-gamma detection devices

## Time-of-Flight resolved Prompt-Gamma Imaging

### Multi-slit collimated camera (1D)

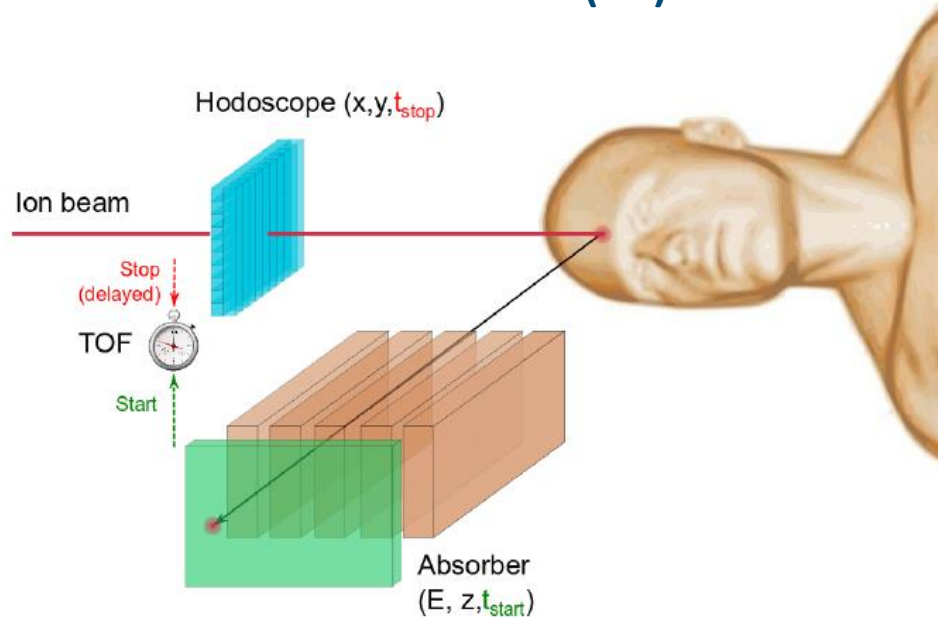

Hodoscope : neutron-induced background reduction & transverse position

CLaRyS-Ultra-Fast Timing goal : 100 ps resolution

→ Prompt-Gamma Timing

### Compton camera (2D ou 3D)

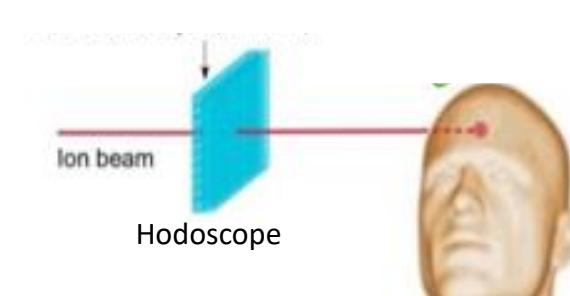
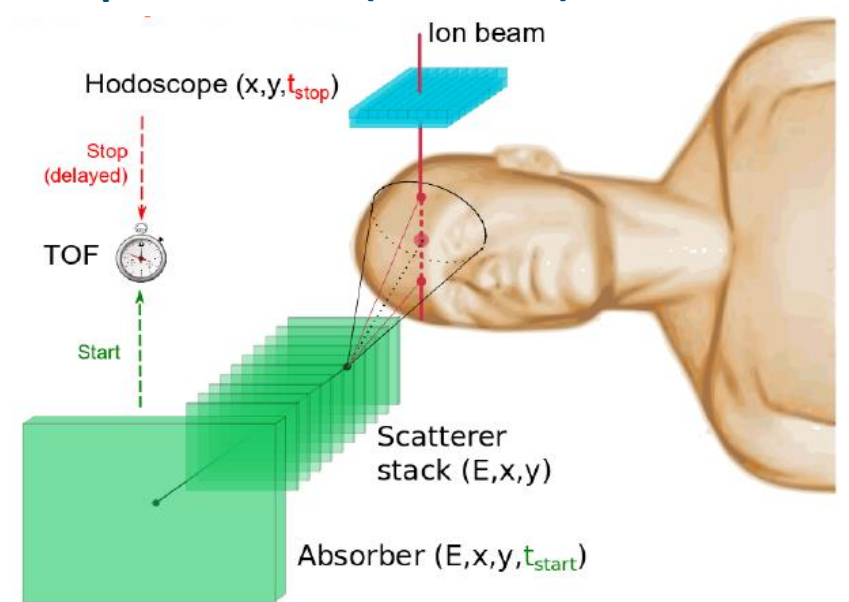

## Development of a beam hodoscope

### IPNL : Scintillating fiber hodoscope

- $\sigma_t \sim 1 \text{ ns}$  → background rejection
- Photomultipliers (512 channels)
- Sensitive area:  $12.8 \times 12.8 \text{ cm}^2$
- Currently under tests at Centre Antoine Lacassagne (Nice)

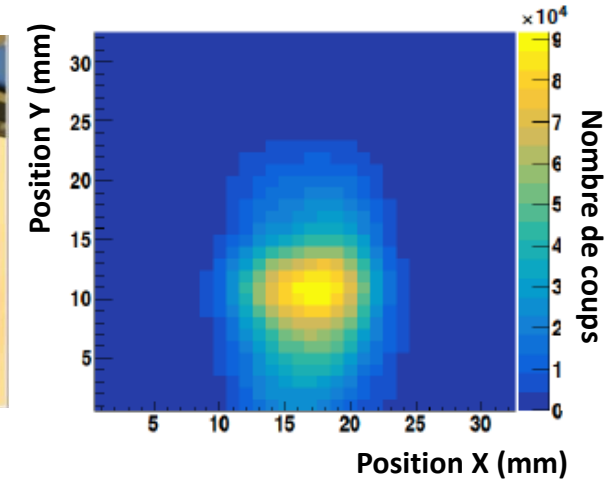

Mattia Fontana's Thesis, Univ. Lyon (2018)

### Strong interest in developing a new hodoscope with:

- Excellent time resolution  
→ Prompt-Gamma Timing is foreseen
- Radiation hardness
- High count rate



**Synthetic diamond**

## Diamond : an intrinsic semi-conductor

### Specifications at 300 K

	Diamond	Silicon
Resistivity ( $\Omega.m$ )	$> 10^{13}$	$2.3 \cdot 10^7$
Gap (eV)	5.5	1.1
e <sup>-</sup> /h pair creation energy (eV)	13.1	3.6
Threshold displacement energy (eV)	43	25
Charge carrier mobilities ( $cm^2.V^{-1}.s^{-1}$ )	$> 2000$	800 – 1400
Thermal conductivity ( $W.cm^{-1}.K^{-1}$ )	18	2



- **Very low leakage currents**
- **Low noise**
- **Radiation hard**
- **Very fast**
- **Room temperature operation**

### Electronic grade diamonds Chemical Vapor Deposition (CVD)

- Single-crystal (mono)
- Polycrystalline (poly)
- Diamond On Iridium (DOI)

# Synthetic diamond as radiation detector

## Solid-state ionization chamber

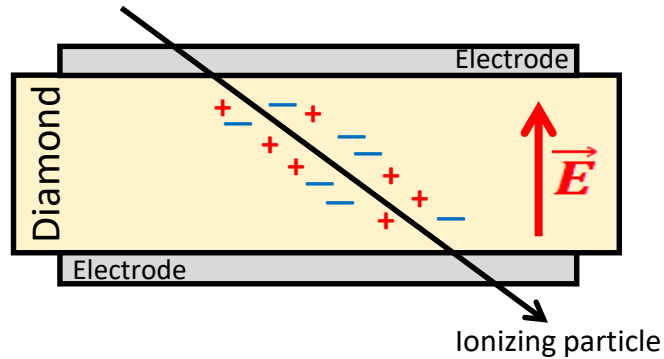

## Detector assembly

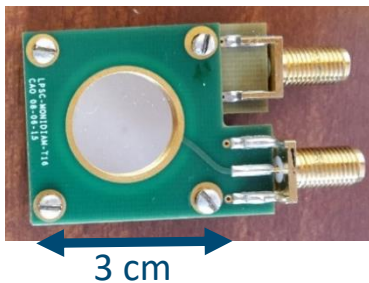
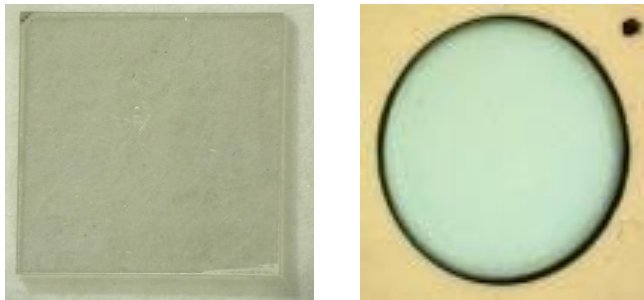

50Ω-adapted printed circuit board

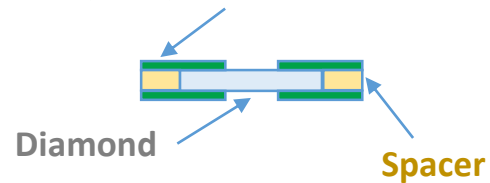

## Our project (LPSC) : Diamond hodoscope

### Specifications:

- $\sigma_t \sim 100 \text{ ps}$
- Count rate  $\sim 10 \text{ MHz/channel}$
- Spatial resolution  $\sim 1 \text{ mm}$
- Radiation hard

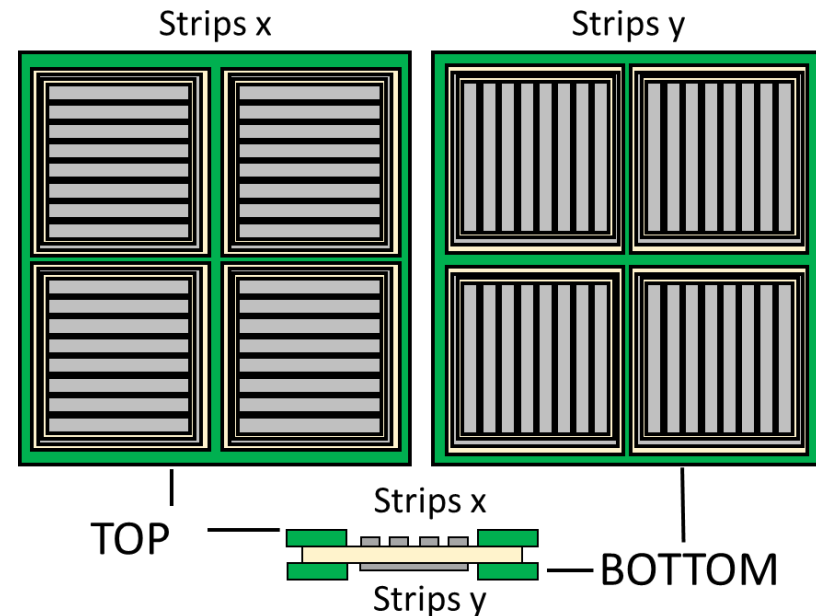

# Strip detectors

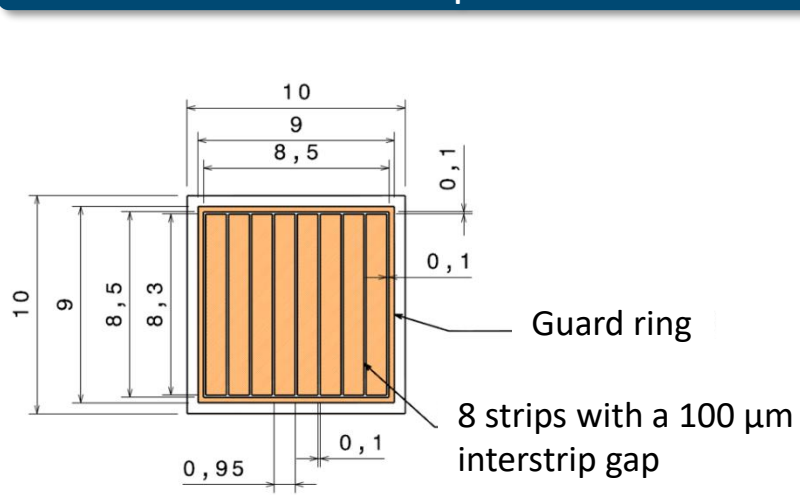

1 cm<sup>2</sup> poly

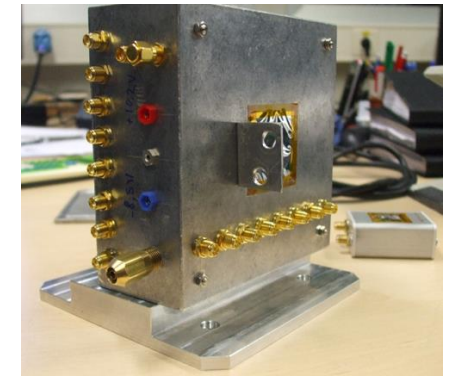
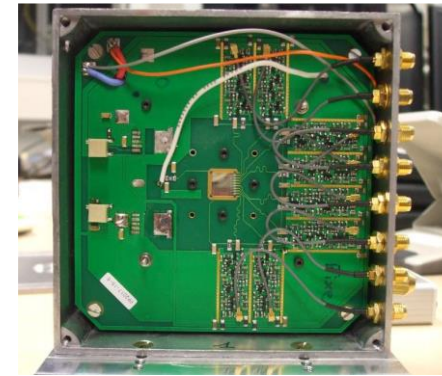
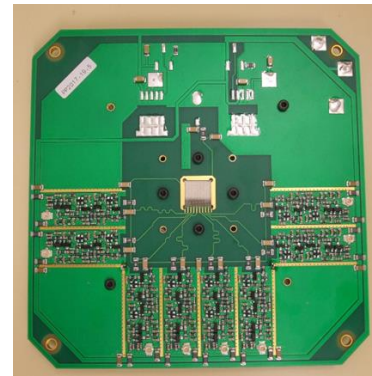
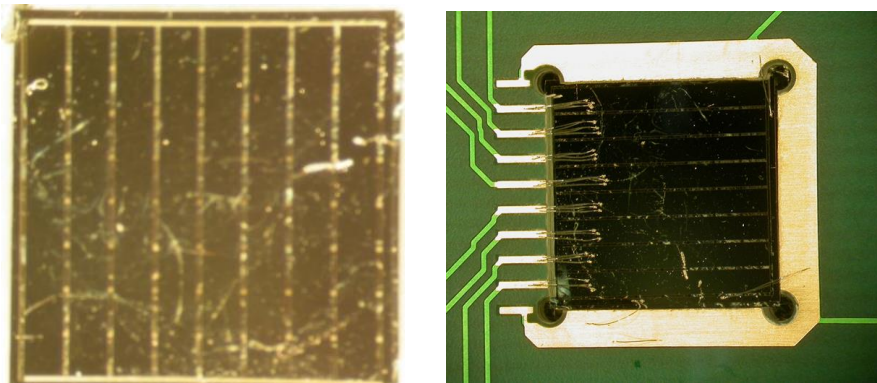
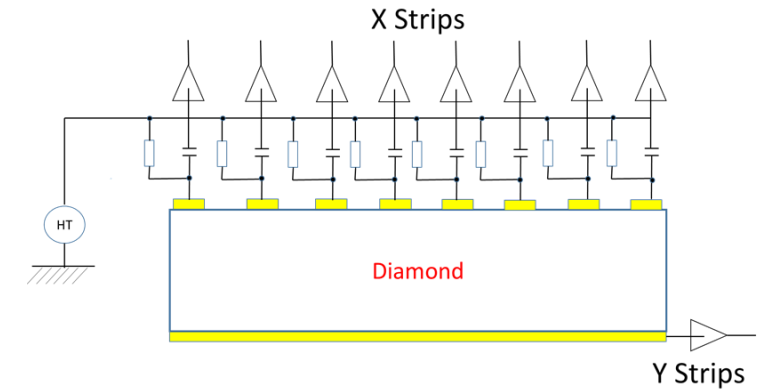
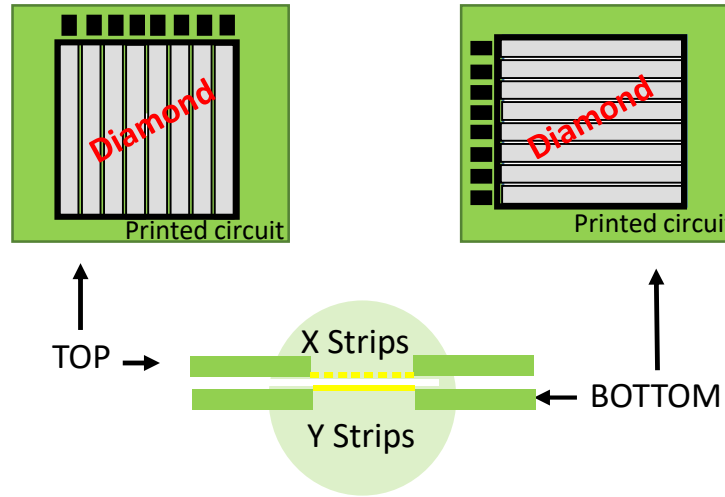

## NANOFAB plateform @ Néel Insitute, Grenoble

- Strips by UV lithography
- Wire bonding

## LPSC Grenoble

- Printed Circuit Boards
- Discrete current preamplifiers
- Mounting and assembling



# Time-of-Flight resolution

## Time resolution assessment

- Digitization of signals
- Normalized threshold discrimination
- Fitting

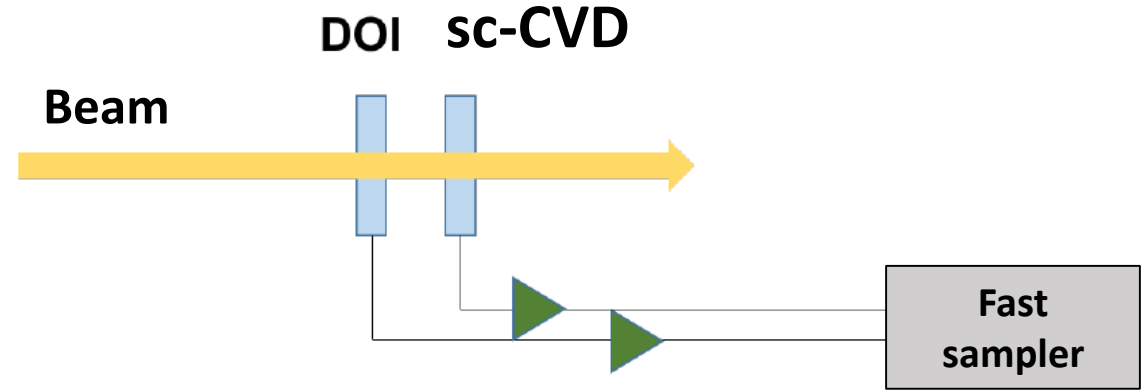

### 95 MeV/u $^{12}\text{C}$ ions @ GANIL

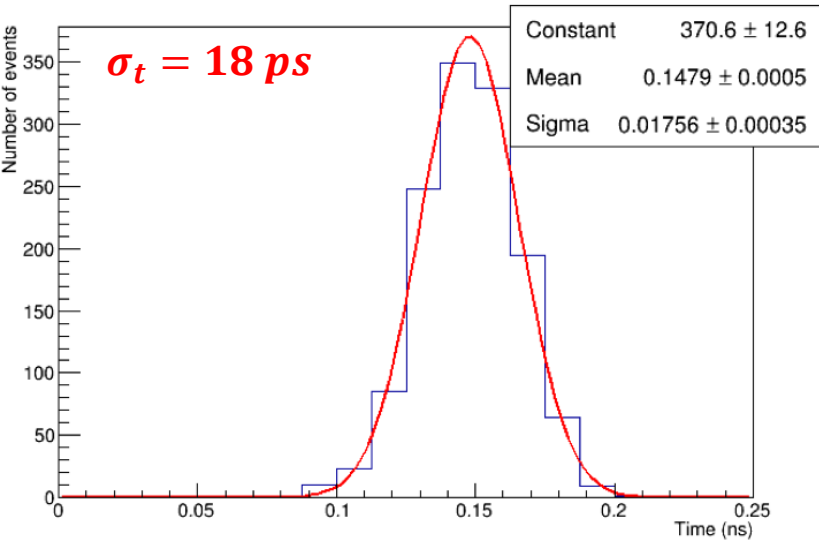

$\Delta E = 25 \text{ MeV}$  (300  $\mu\text{m}$  diamond)

### 68 MeV protons @ ARRONAX

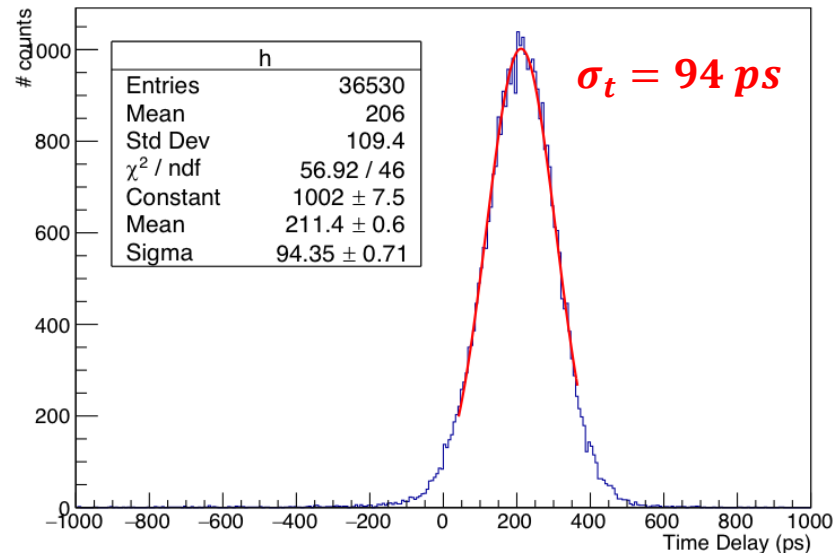

$\Delta E = 1 \text{ MeV}$  (300  $\mu\text{m}$  diamond)

### 8.5 keV photons @ ESRF

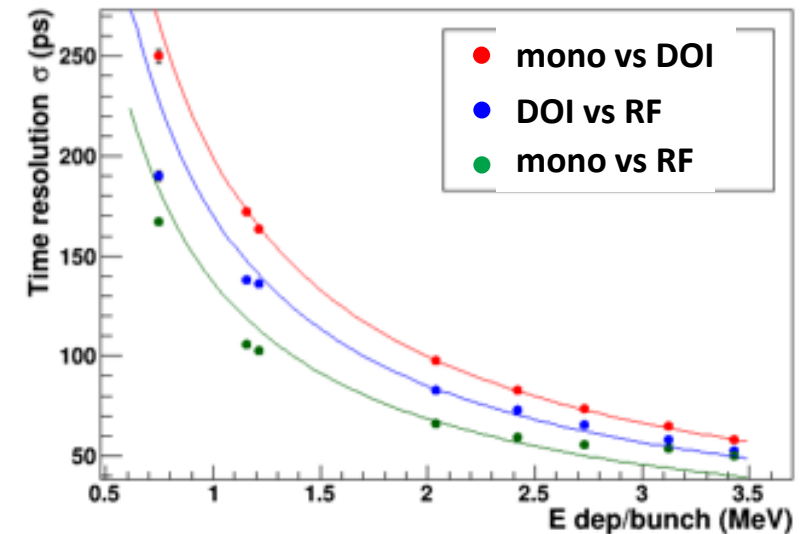

## Specific detection efficiency

Pulsed beam - 68 MeV protons  
 $\Delta E = 2 \text{ MeV}$  (2 protons in 300  $\mu\text{m}$  diamond)

- Event filtering (amplitude and Time-of-Flight)
- Opposite faces signal summation:  
 $\rightarrow$  Signal-to-noise ratio  $\times \sqrt{2}$
- Offline absolute threshold-based scanning

$$\varepsilon = \frac{N_{\text{triple}}}{N_{\text{double}}} \left( 1 - \frac{N_{\text{random}}}{N_{\text{double}}} \right)$$

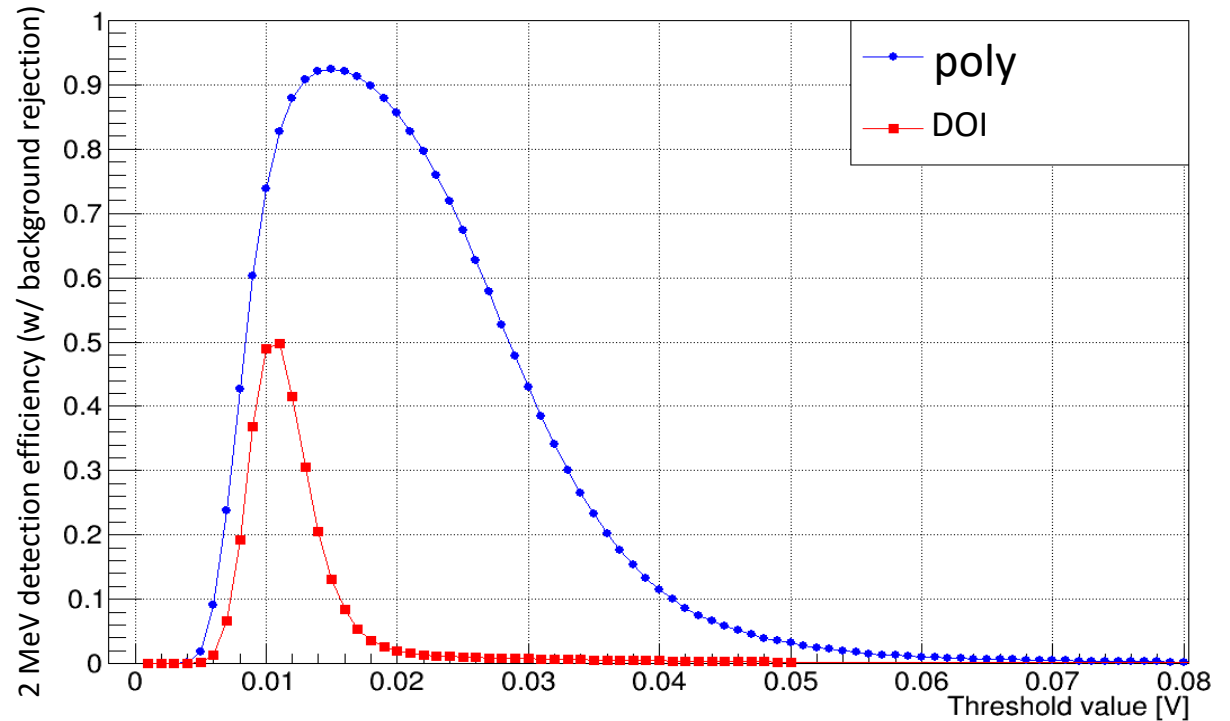
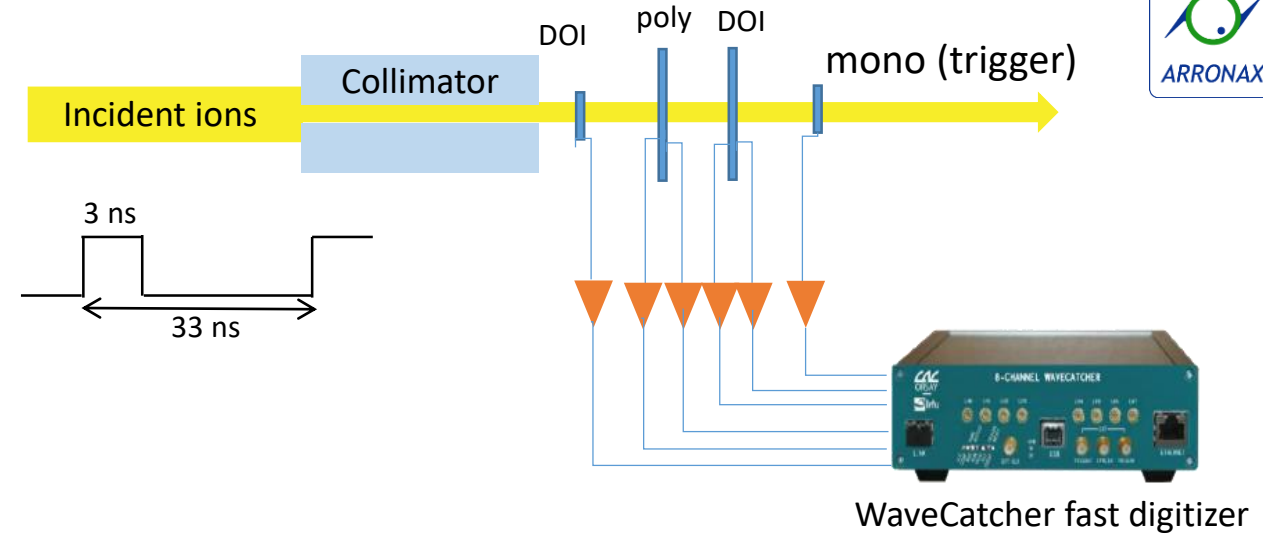

# High beam current response

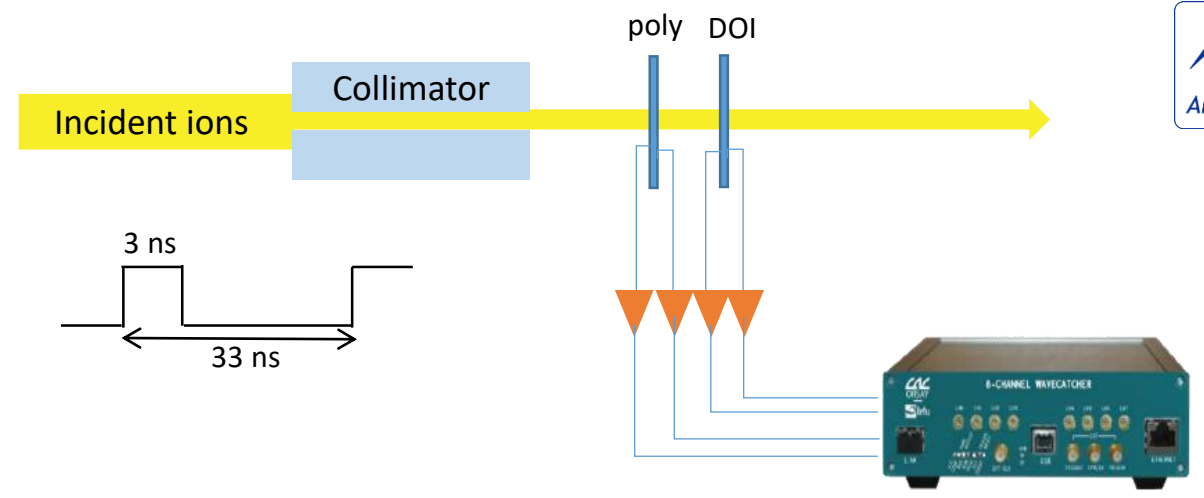

WaveCatcher fast digitizer

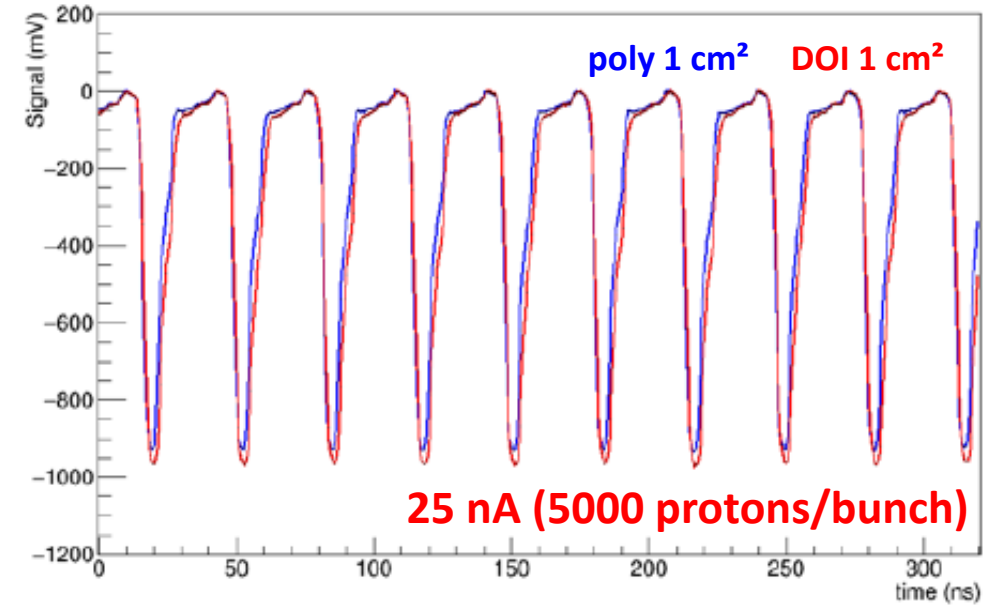
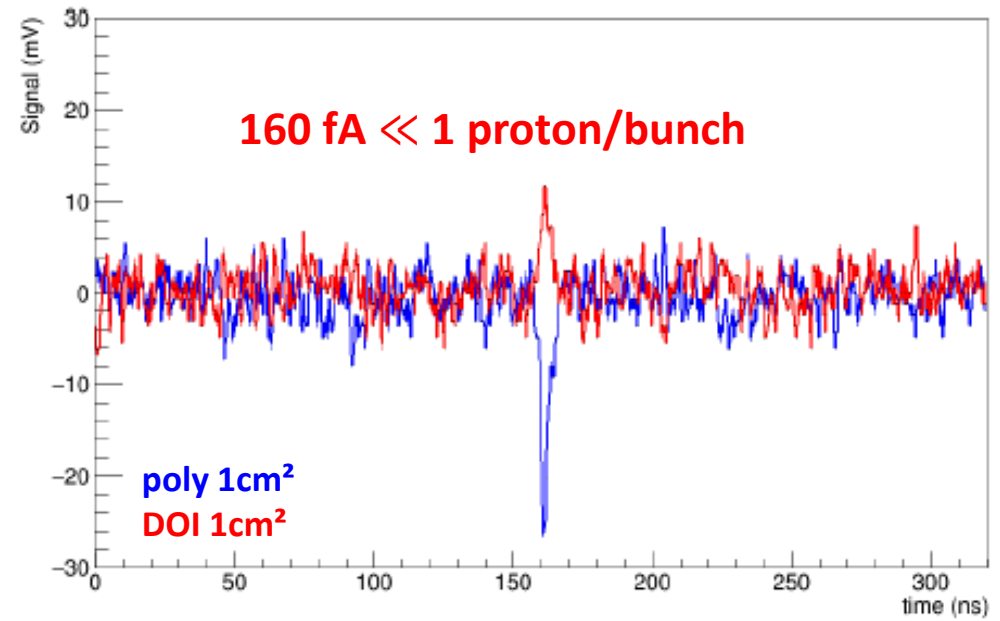

## Characterization with X-ray micro-beam



Pulsed X-ray micro-beam (8.5 keV)

~1500 photons / pulse

$\varnothing$  spot : 1  $\mu\text{m}$

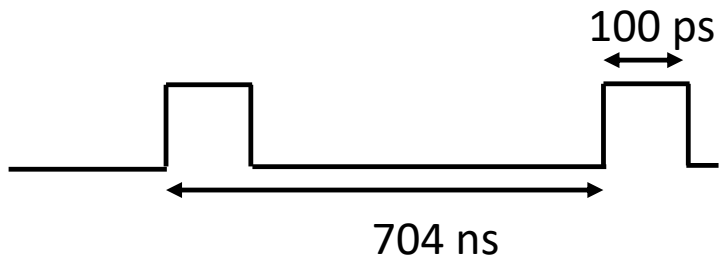

- Current mode: Surface scanning
- Pulse mode: Strip detectors performance

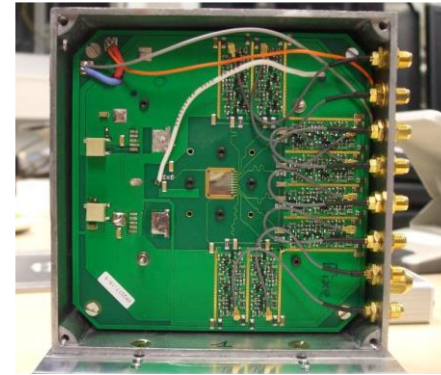

1 cm<sup>2</sup> poly

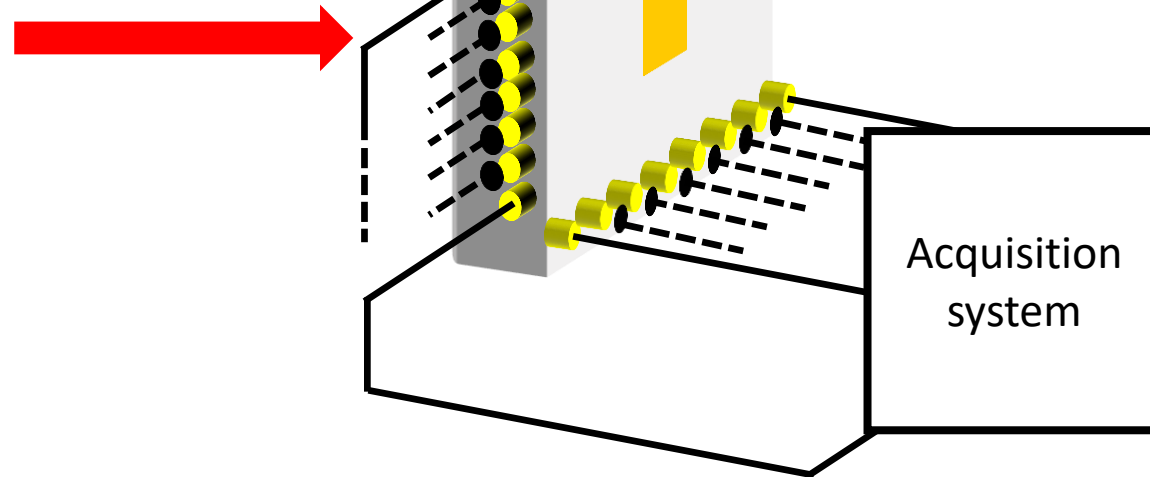
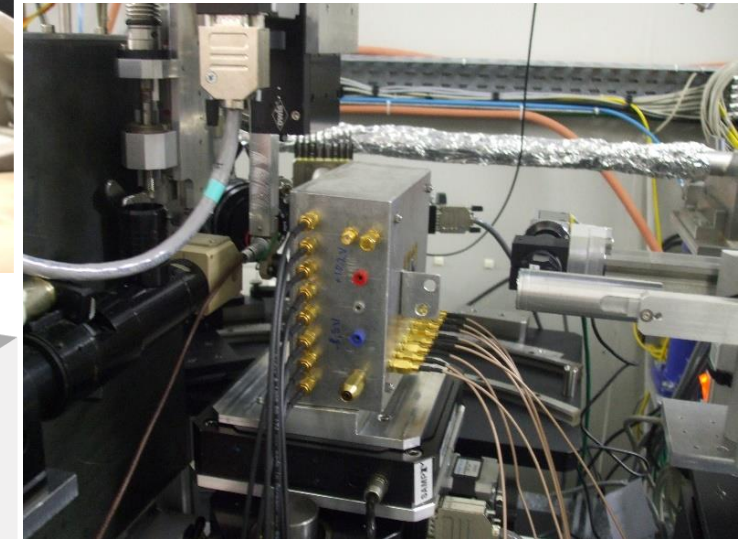

# Strip detector time resolution

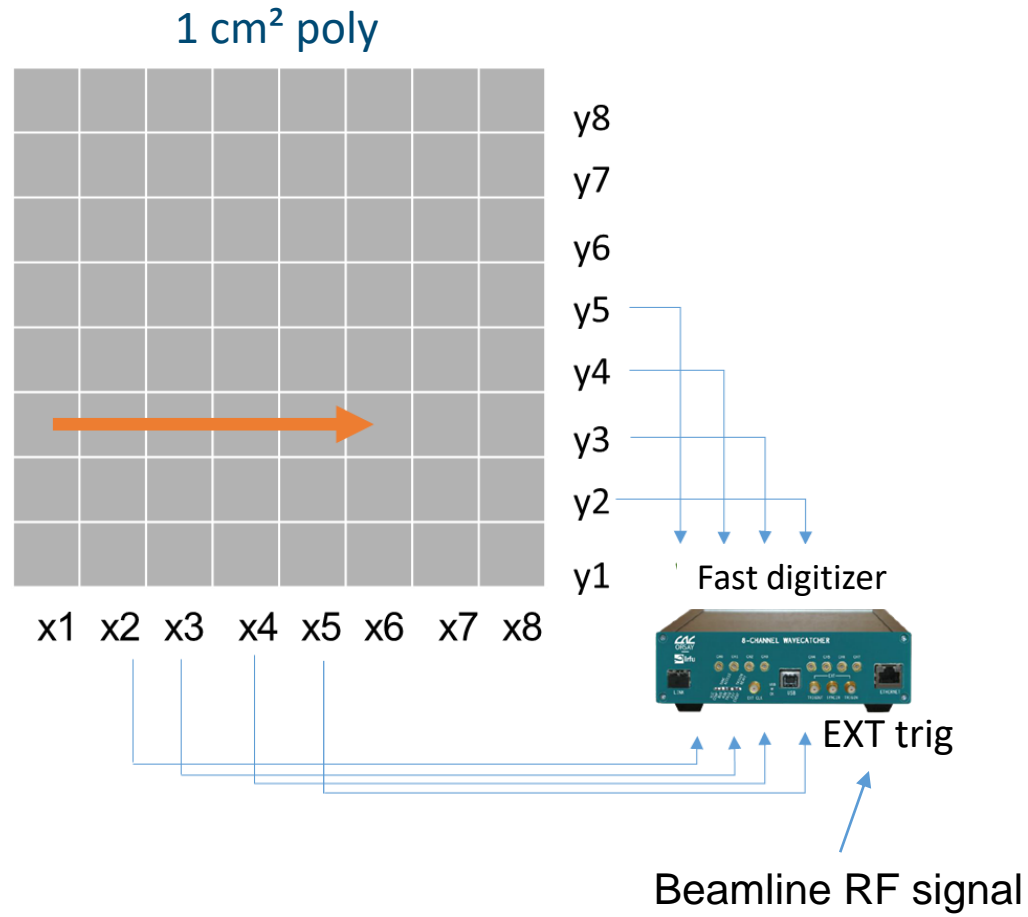

## Intrinsic time resolution (rms)

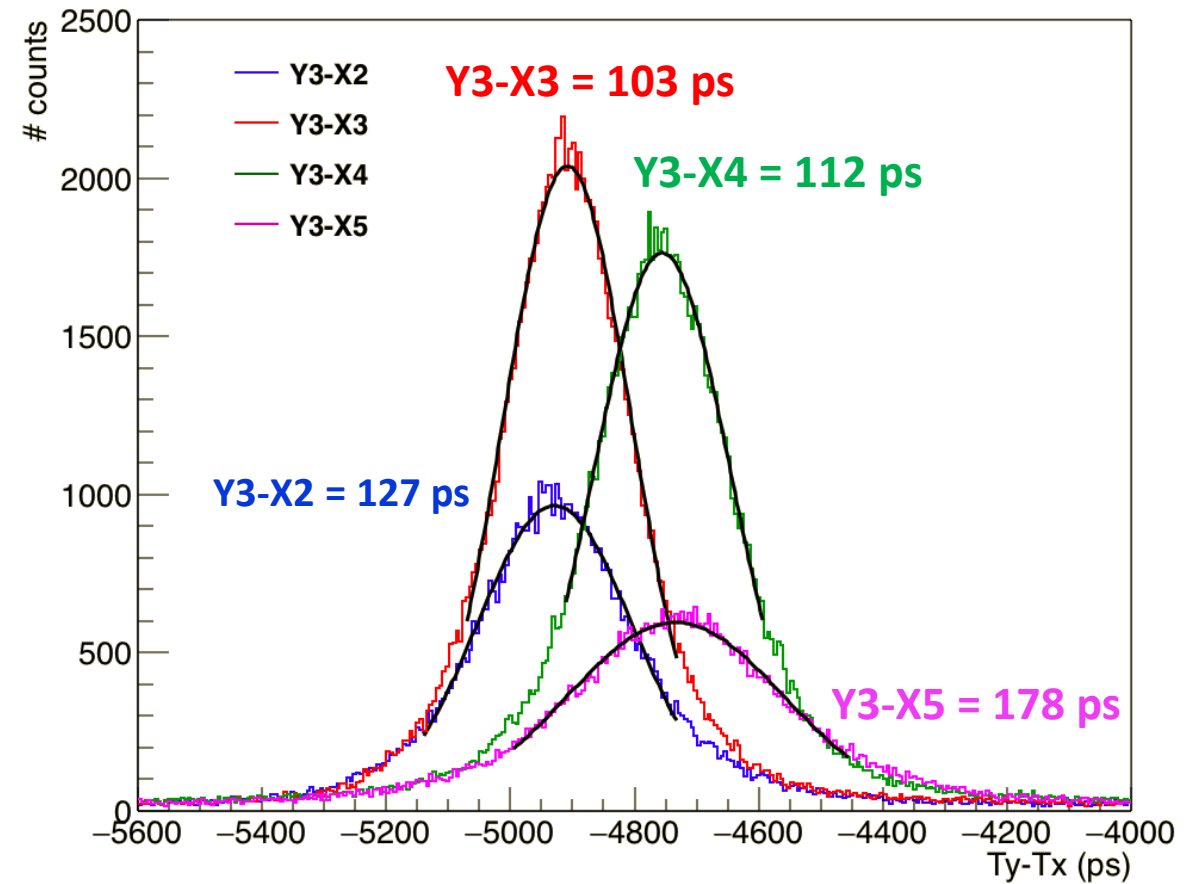

# Strip detector detection efficiency

Detection efficiency  
(with respect to the  
beamline RF signal)

- Y3-X2
- Y3-X3
- Y3-X4
- Y3-X5

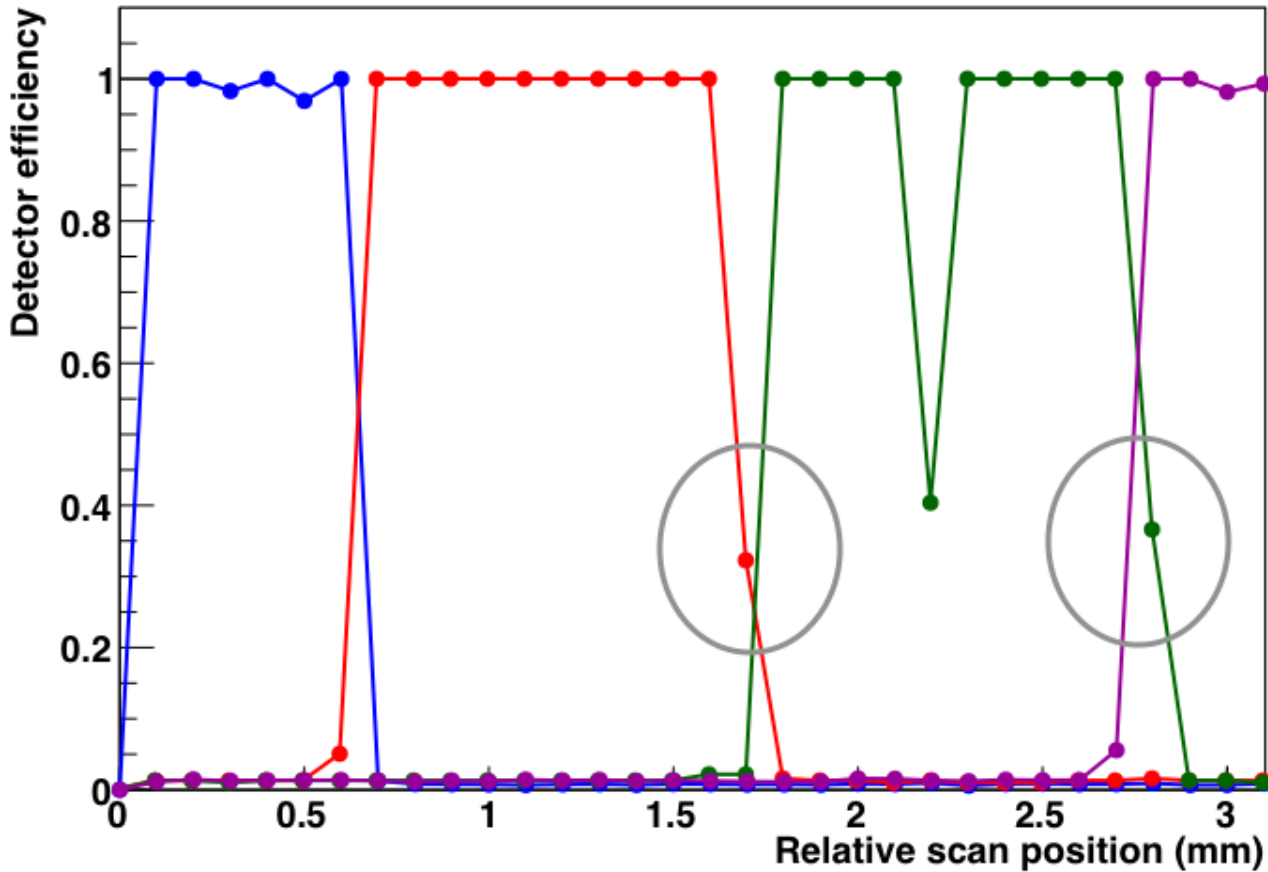
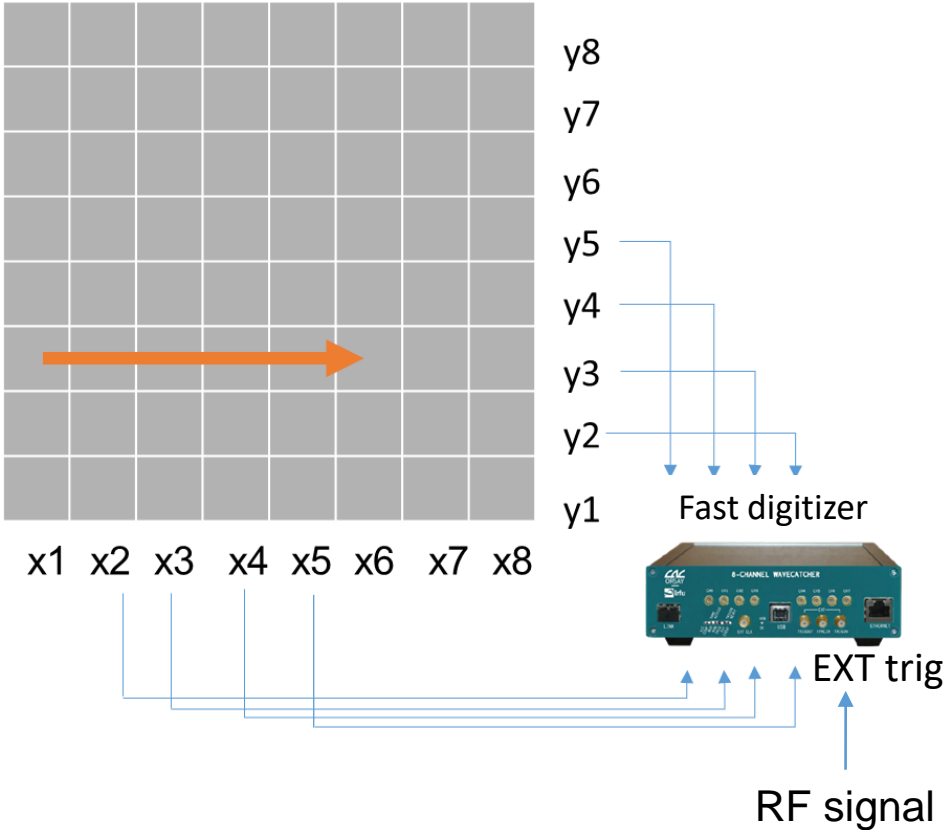

## Conclusions

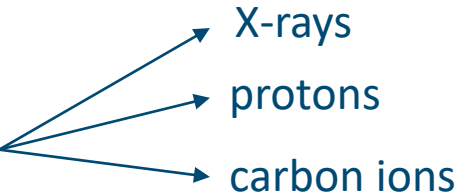
- Detectors characterized under various irradiation conditions 
- Comparison of performances obtained with different crystal qualities (mono, poly and DOI)
- Time resolution in good agreement with project specifications
- First strip sensors : satisfactory results

## Perspectives

- Analysis to assess single proton detection efficiency is ongoing
- Assembling of a 4-diamond hodoscope demonstrator
- Both custom integrated and discrete electronics are currently developed and tested at LPSC
- Characterization with protons and carbon ions
- Integration to the CLaRyS  $\mu$ TCA data acquisition system

Thank you for your kind attention

Acknowledgements to supporting institutions:

