

Towards a beam-tagging diamond hodoscope for online ion range monitoring



S. Curtoni, G. Bosson, J. Bouvier, J. Collot, D. Dauvergne, JY. Hostachy,
L. Gallin-Martel, ML. Gallin-Martel, A. Ghimouz, J. Livingstone,
S. Marcatili, JF. Muraz, F.E. Rarbi, O. Rossetto, M. Yamouni



F. Haddad, C. Koumeir



V. Métivier, N. Servagent



E. Testa



JM. Létang

Ion range uncertainties

Ideal treatment plan

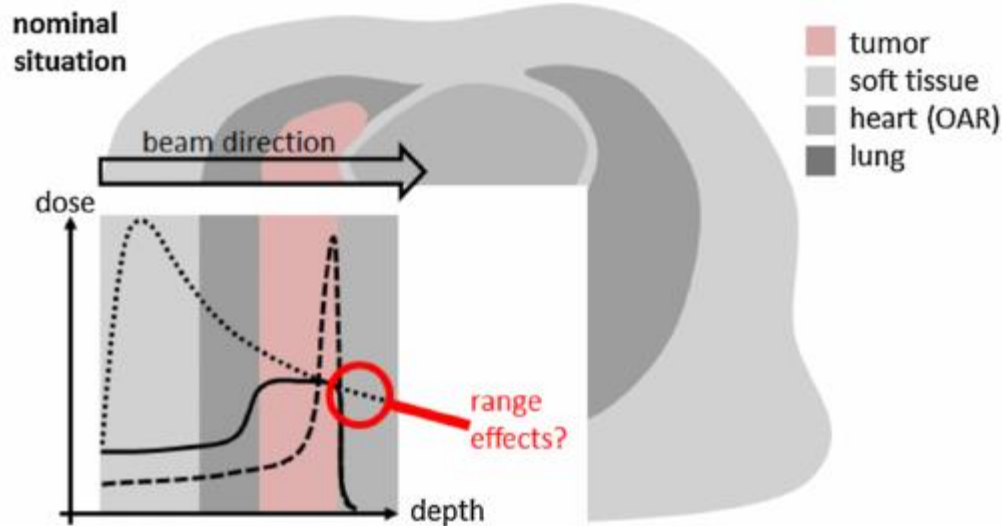

Effect of tissues heterogeneities

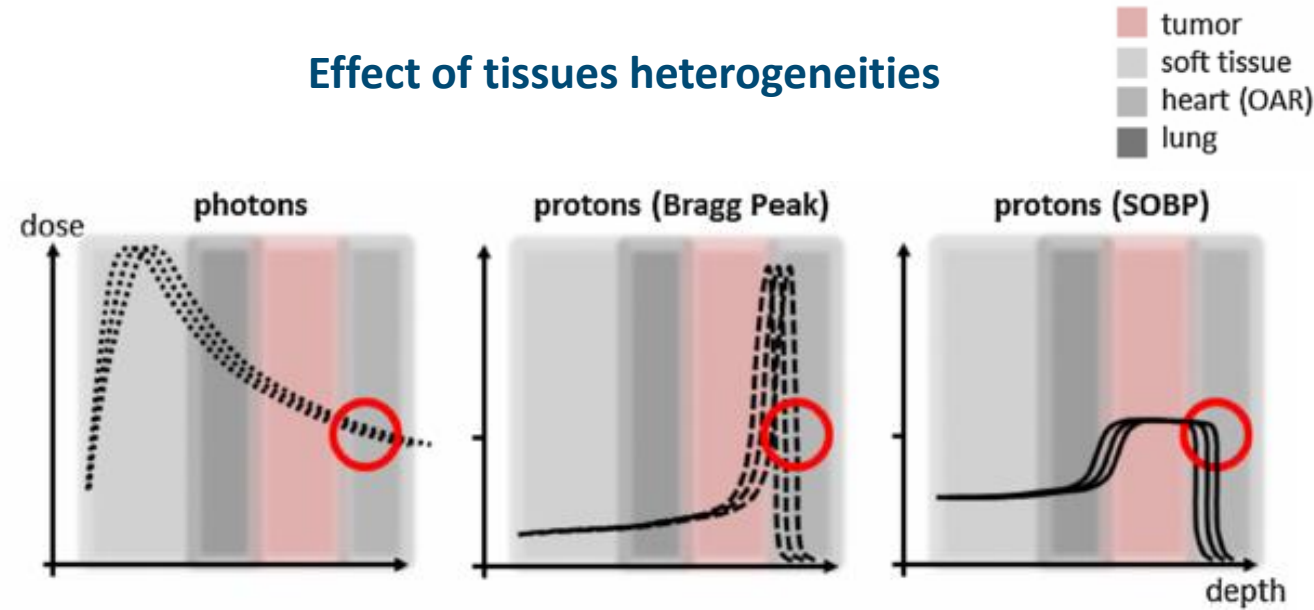

Knopf and Lomax, Phys. Med. Biol. 58 (2013) R131–R160

Uncertainties

- Treatment planning
- Patient positioning
- Organ motion
- Morphological evolution of tumor volume through treatment



Security margins on actual range (ex : 1 cm for 20 cm prescribed range)



Need for an online ion range monitoring system

Production of secondary particles

Geant4 simulation

160 MeV protons
in water target

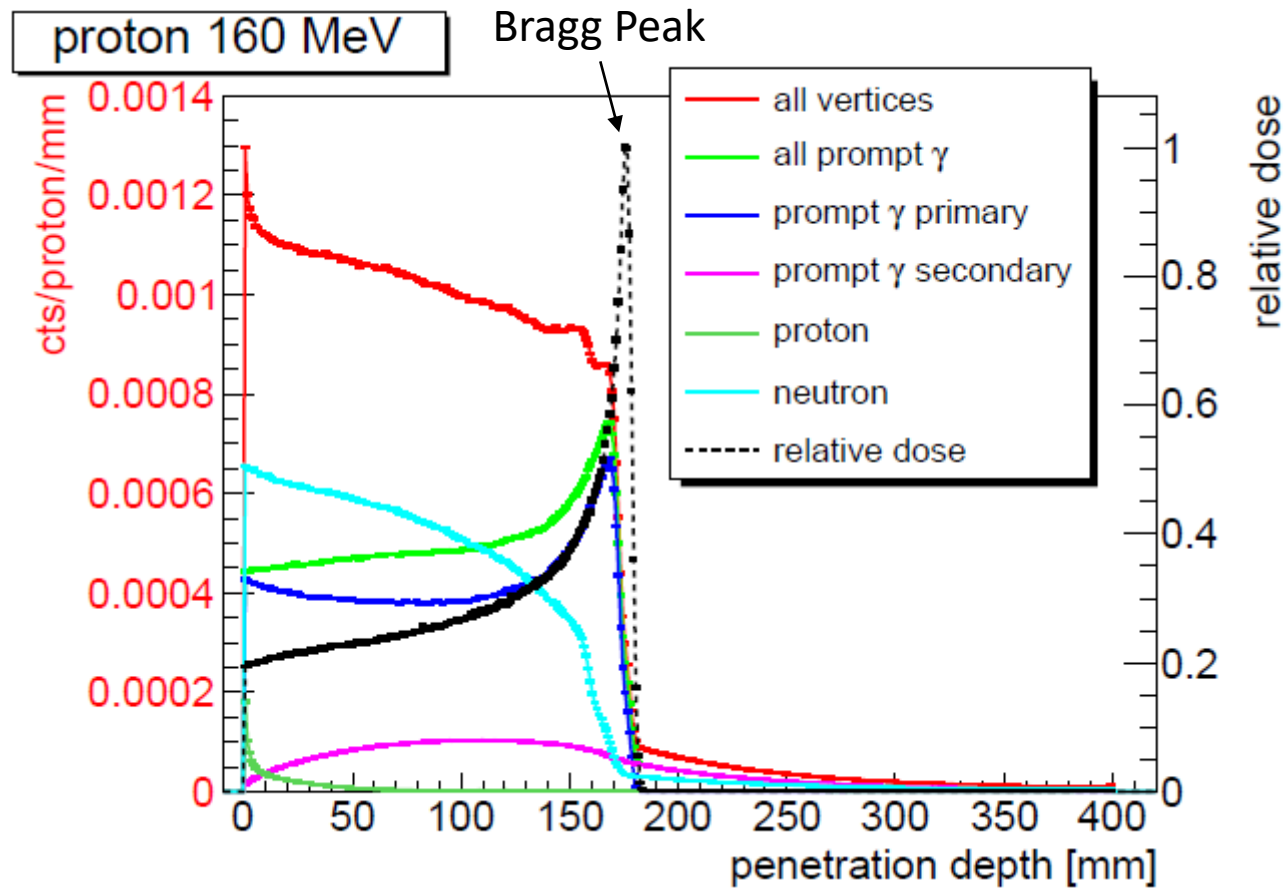

Krimmer et al., Nucl. Instr. Meth. A, **878** (2017) 58-73

Production of secondary particles

Geant4 simulation

160 MeV protons
in water target

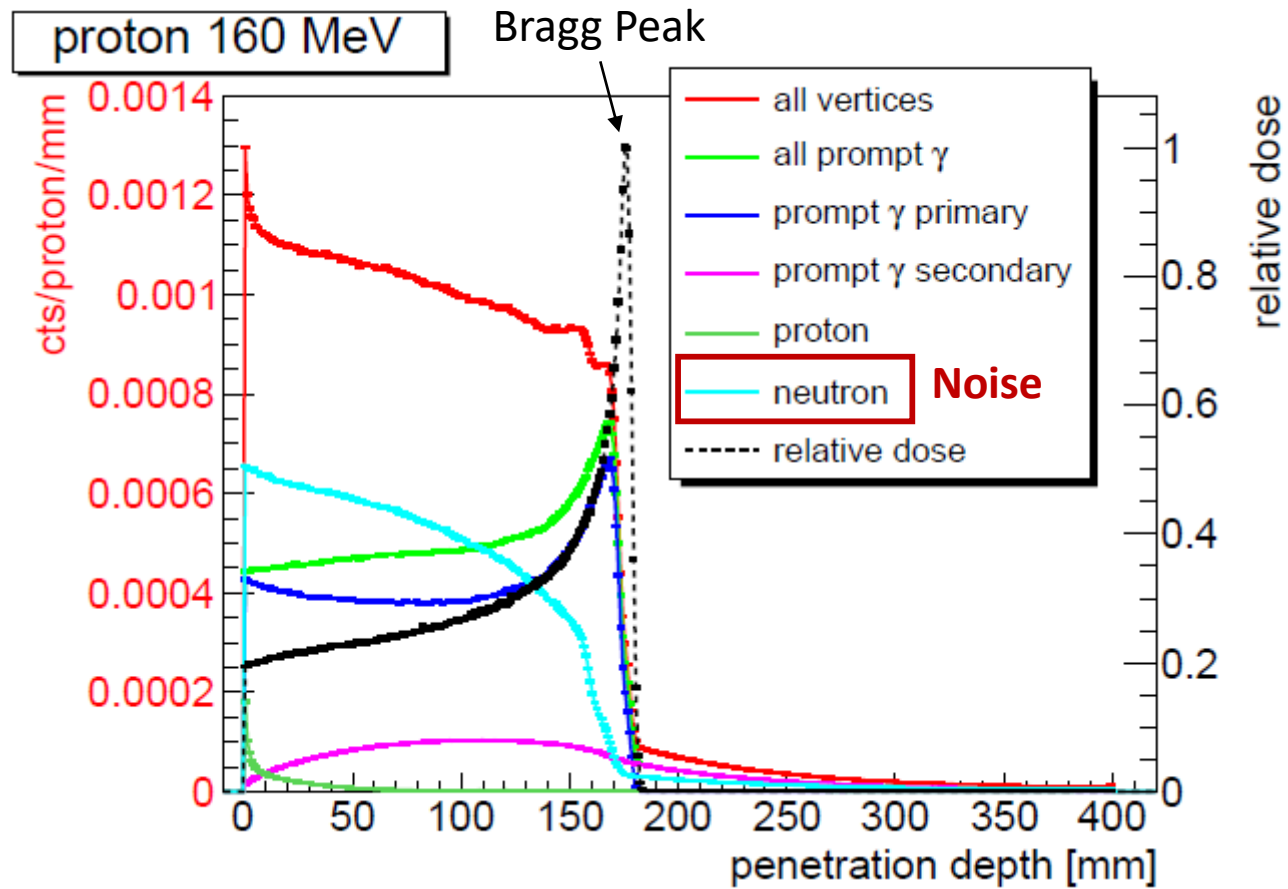

Krimmer et al., Nucl. Instr. Meth. A, **878** (2017) 58-73

Production of secondary particles

Geant4 simulation

160 MeV protons
in water target

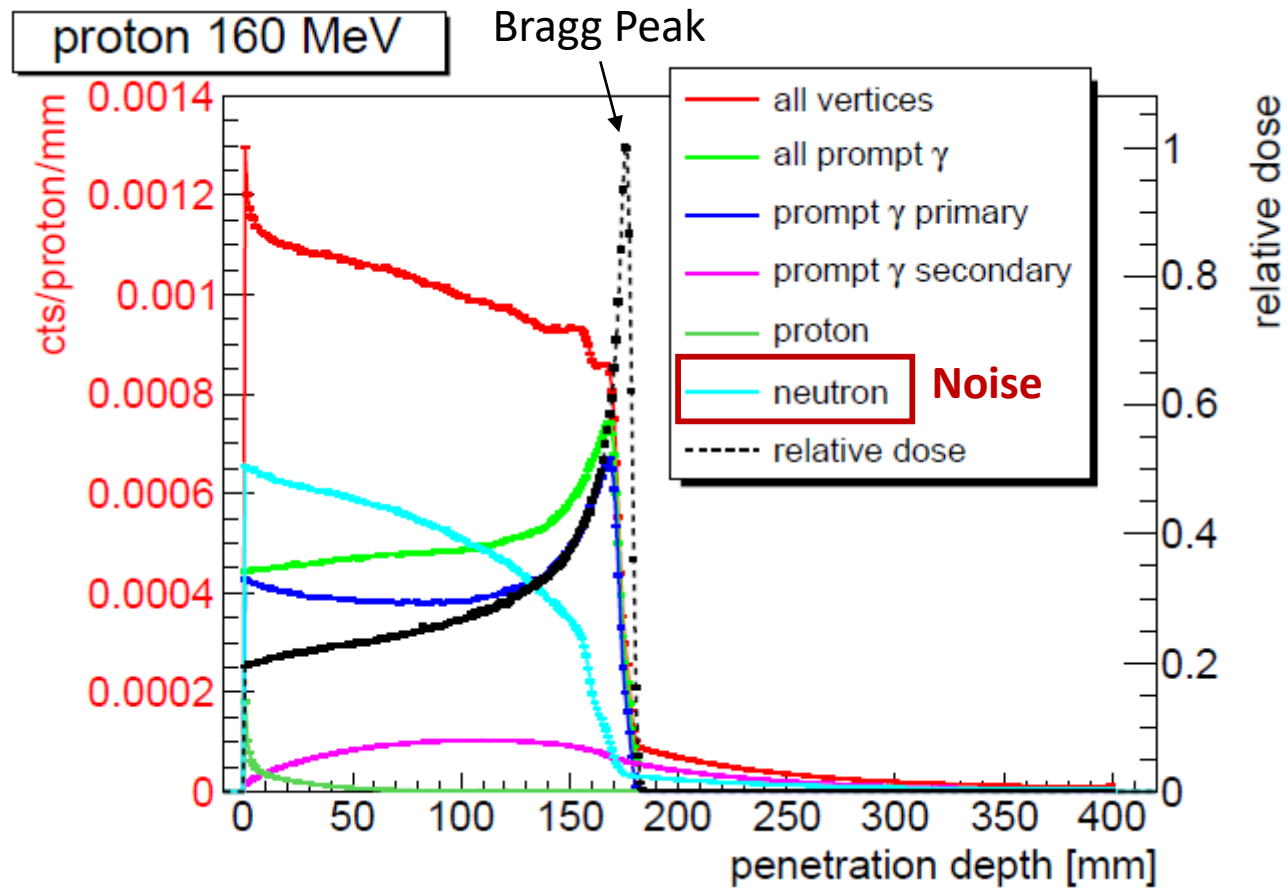

Krimmer et al., Nucl. Instr. Meth. A, **878** (2017) 58-73

CLaRyS collaboration

CLaRyS: Contrôle en Ligne de l'hadronthérapie par détection de Rayonnements Secondaires

4 laboratories: LPSC, IPNL, CPPM, CREATIS Lyon

Prompt-gamma detection devices

Time-of-Flight resolved Prompt-Gamma Imaging

Multi-slit collimated camera (1D)

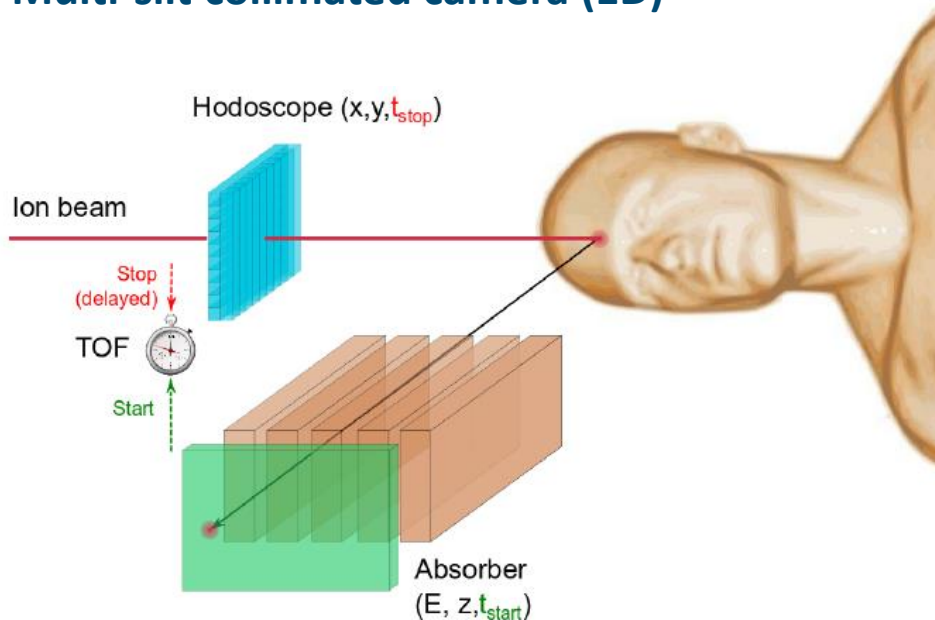

Compton camera (2D or 3D)

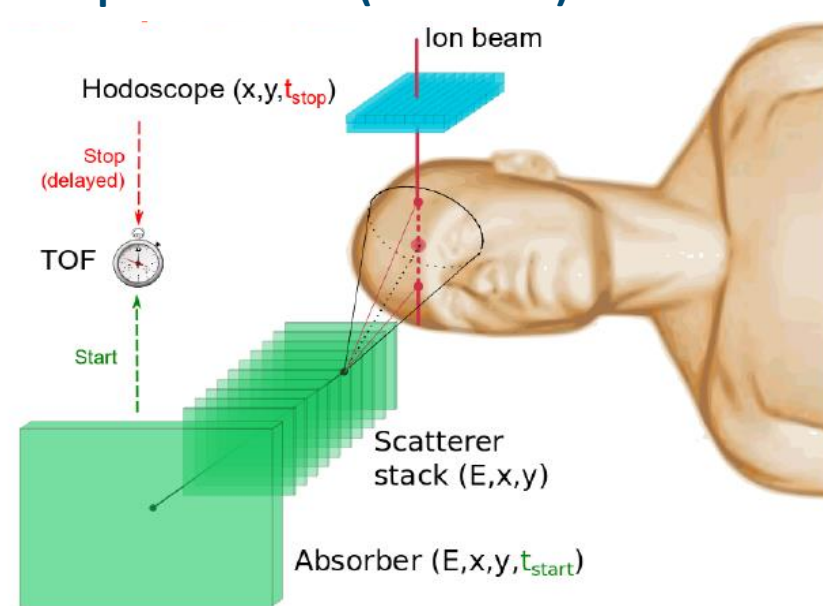

Hodoscope : neutron-induced background reduction & transverse position

Prompt-gamma detection devices

Time-of-Flight resolved Prompt-Gamma Imaging

Multi-slit collimated camera (1D)

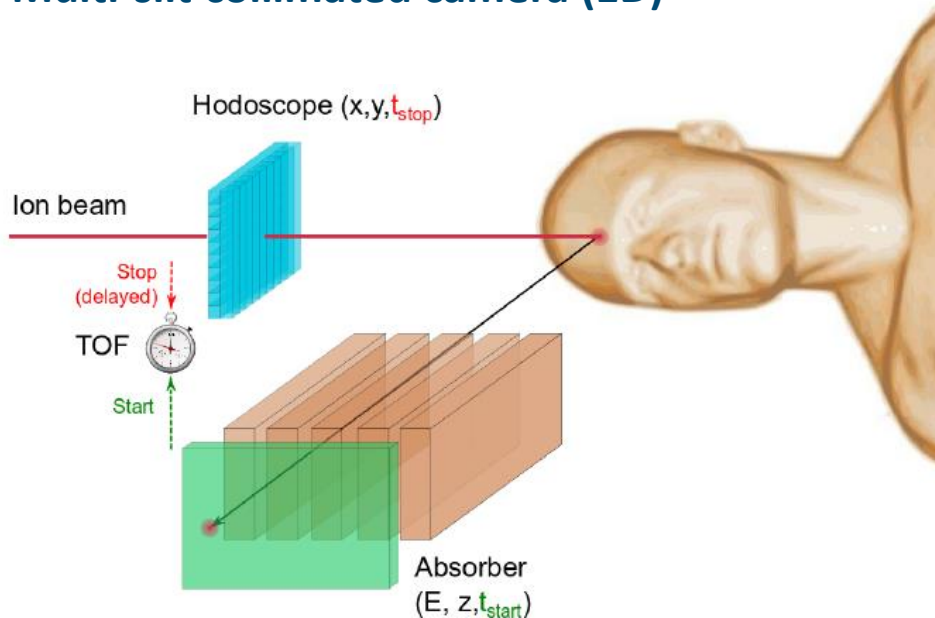

Hodoscope : neutron-induced background reduction & transverse position

CLaRyS-Ultra-Fast Timing goal : 100 ps resolution

Compton camera (2D ou 3D)

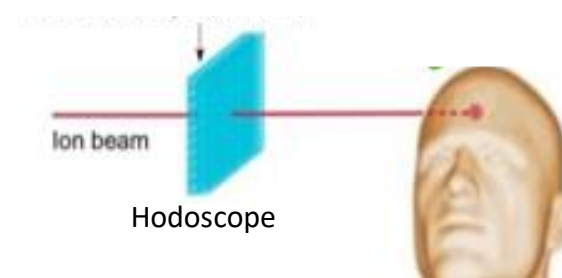
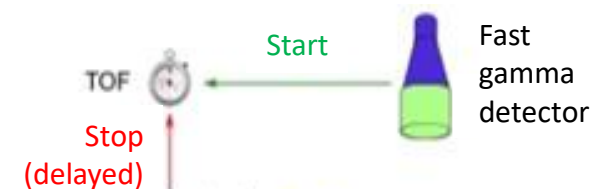
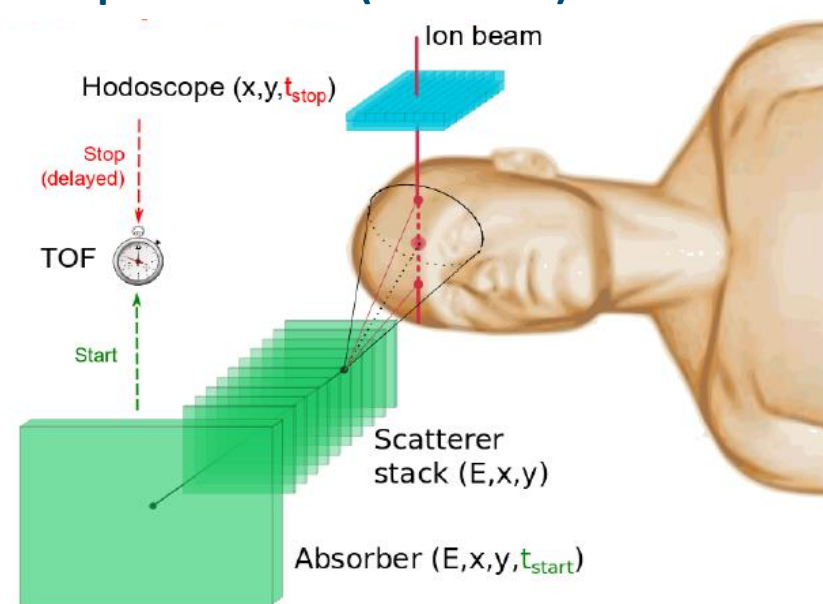

Prompt-gamma detection devices

Time-of-Flight resolved Prompt-Gamma Imaging

Multi-slit collimated camera (1D)

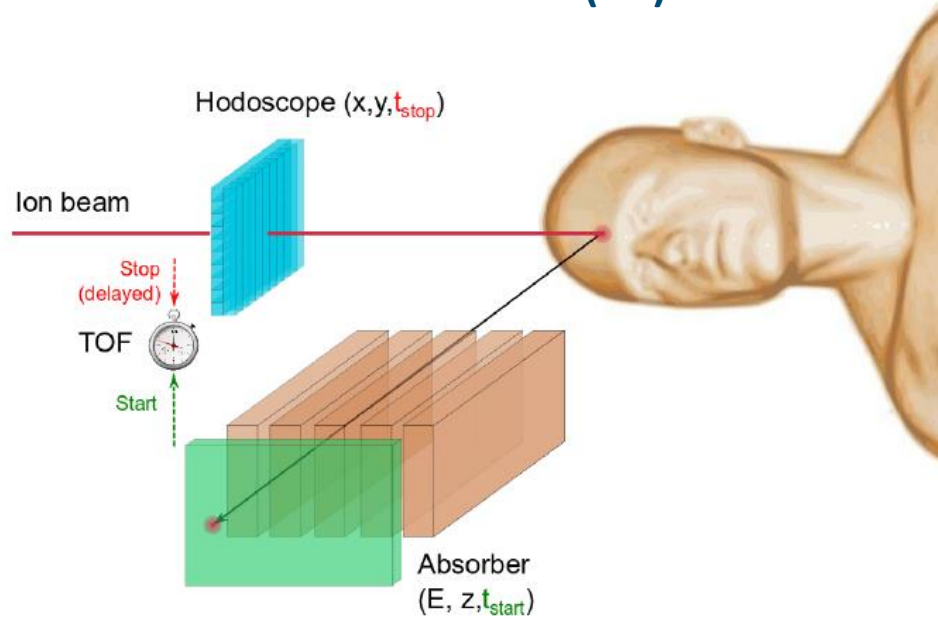

Hodoscope : neutron-induced background reduction & transverse position

CLaRyS-Ultra-Fast Timing goal : 100 ps resolution

→ Prompt-Gamma Timing

Compton camera (2D ou 3D)

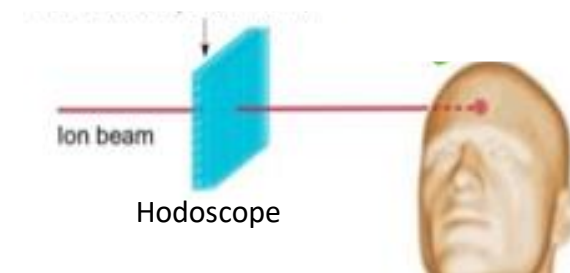
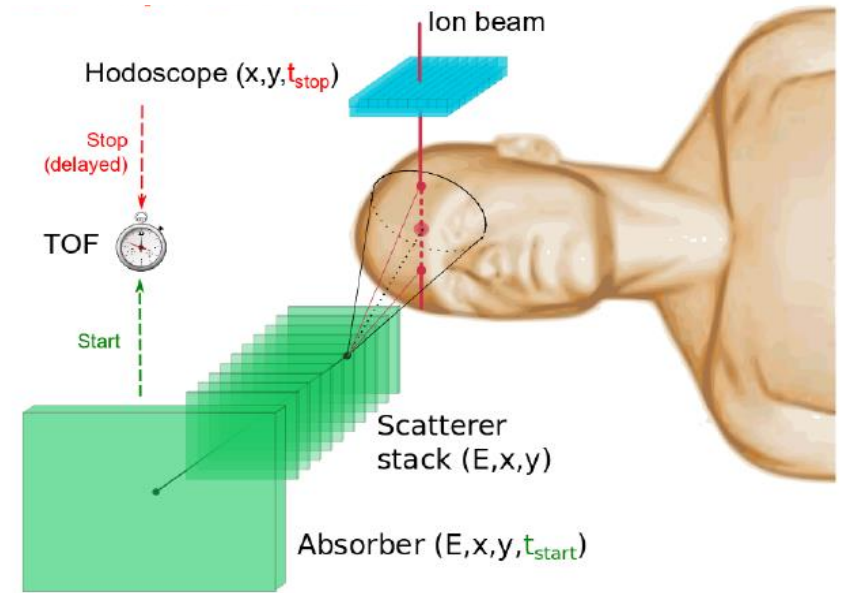

Development of a beam hodoscope

IPNL : Scintillating fiber hodoscope

- $\sigma_t \sim 1 \text{ ns} \rightarrow$ background rejection
- Photomultipliers (512 channels)
- Sensitive area: $12.8 \times 12.8 \text{ cm}^2$
- Currently under tests at Centre Antoine Lacassagne (Nice)

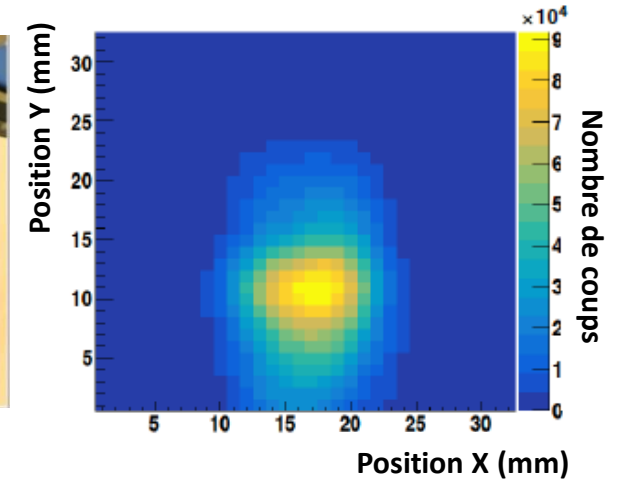

Mattia Fontana's Thesis, Univ. Lyon (2018)

Development of a beam hodoscope

IPNL : Scintillating fiber hodoscope

- $\sigma_t \sim 1 \text{ ns}$ → background rejection
- Photomultipliers (512 channels)
- Sensitive area: $12.8 \times 12.8 \text{ cm}^2$
- Currently under tests at Centre Antoine Lacassagne (Nice)

Strong interest in developing a new hodoscope with:

- Excellent time resolution
→ Prompt-Gamma Timing is foreseen
- Radiation hardness
- High count rate

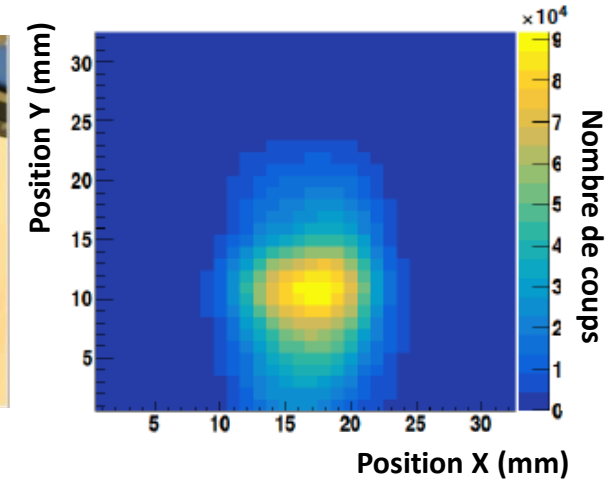

Mattia Fontana's Thesis, Univ. Lyon (2018)

Development of a beam hodoscope

IPNL : Scintillating fiber hodoscope

- $\sigma_t \sim 1 \text{ ns}$ \rightarrow background rejection
- Photomultipliers (512 channels)
- Sensitive area: $12.8 \times 12.8 \text{ cm}^2$
- Currently under tests at Centre Antoine Lacassagne (Nice)

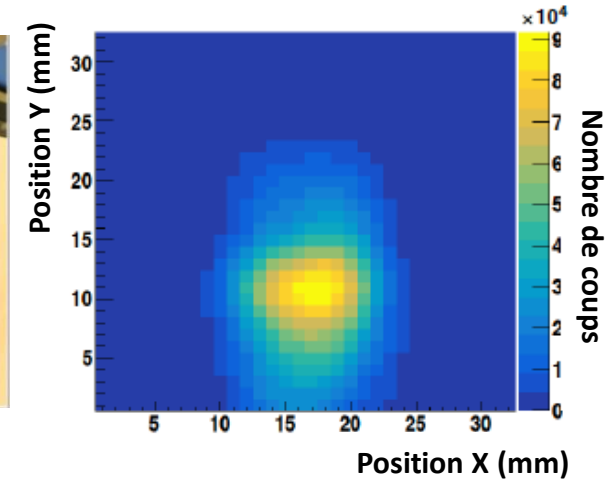

Mattia Fontana's Thesis, Univ. Lyon (2018)

Strong interest in developing a new hodoscope with:

- Excellent time resolution
 \rightarrow Prompt-Gamma Timing is foreseen
- Radiation hardness
- High count rate



Synthetic diamond

Diamond : an intrinsic semi-conductor

Specifications at 300 K

	Diamond	Silicon
Resistivity ($\Omega.m$)	$> 10^{13}$	$2.3 \cdot 10^7$
Gap (eV)	5.5	1.1
e ⁻ /h pair creation energy (eV)	13.1	3.6
Threshold displacement energy (eV)	43	25
Charge carrier mobilities ($cm^2.V^{-1}.s^{-1}$)	> 2000	800 – 1400
Thermal conductivity ($W.cm^{-1}.K^{-1}$)	18	2



- **Very low leakage currents**
- **Low noise**
- **Radiation hard**
- **Very fast**
- **Room temperature operation**

Electronic grade diamonds Chemical Vapor Deposition (CVD)

- Single-crystal (mono)
- Polycrystalline (poly)
- Diamond On Iridium (DOI)

Synthetic diamond as radiation detector

Solid-state ionization chamber

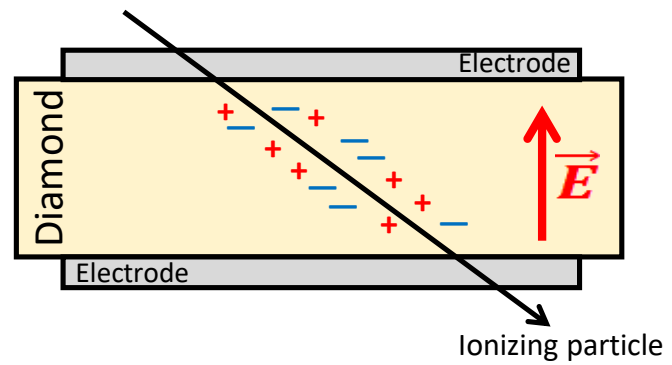

Synthetic diamond as radiation detector

Solid-state ionization chamber

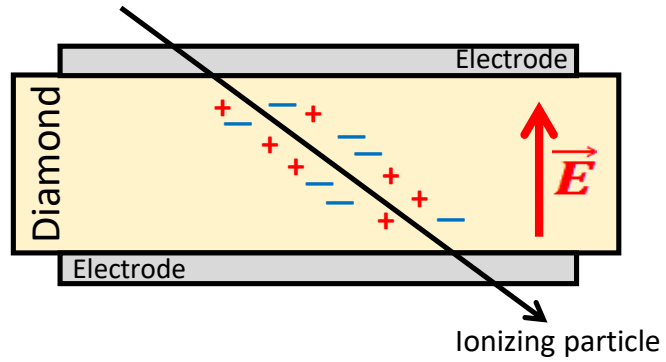

Detector assembly



50Ω-adapted printed circuit board

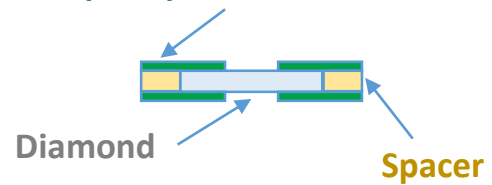

Synthetic diamond as radiation detector

Solid-state ionization chamber

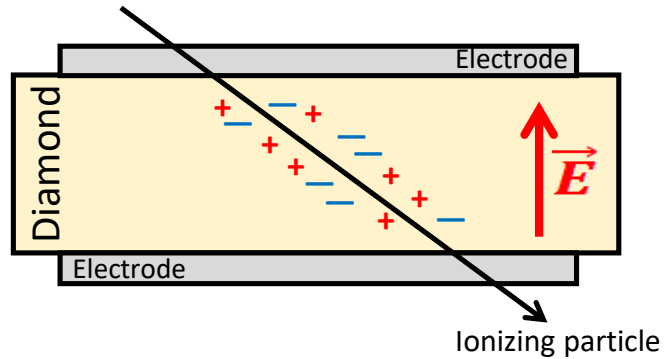

Detector assembly

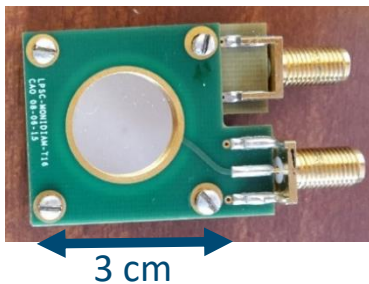
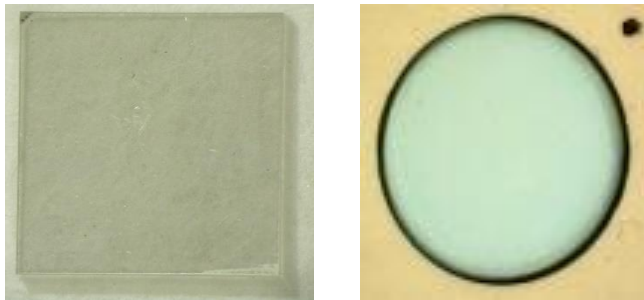

50Ω-adapted printed circuit board

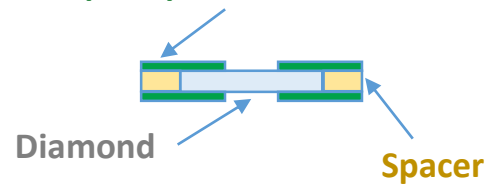

Our project (LPSC) : Diamond hodoscope

Specifications:

- $\sigma_t \sim 100 \text{ ps}$
- Count rate $\sim 10 \text{ MHz/voie}$
- Spatial resolution $\sim 1 \text{ mm}$
- Radiation hard

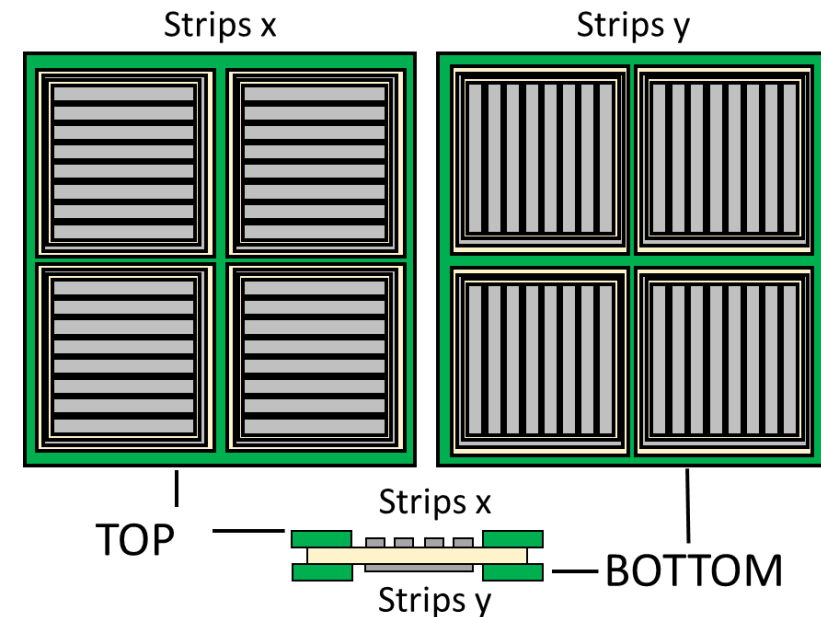

Strip detectors

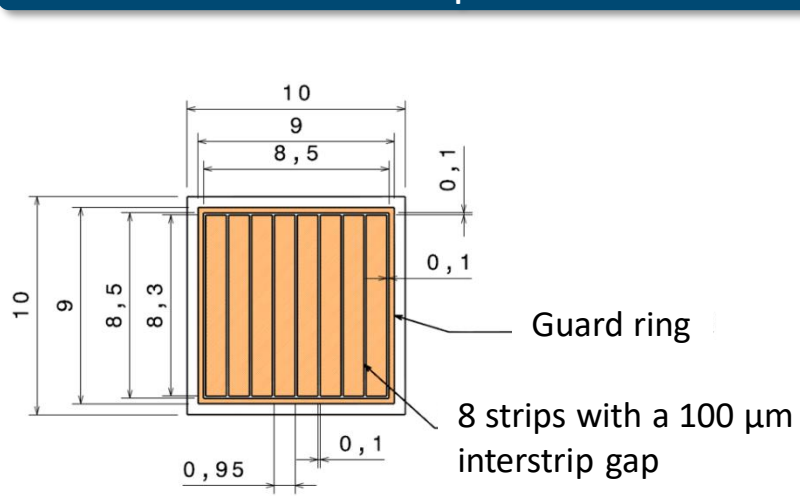

1 cm² poly

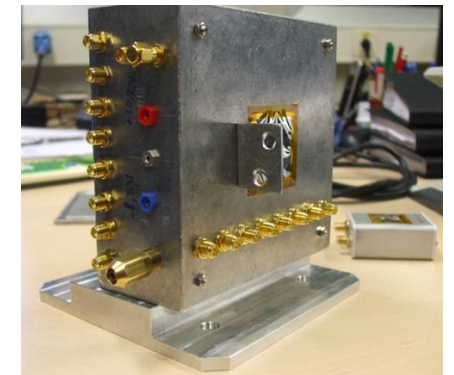
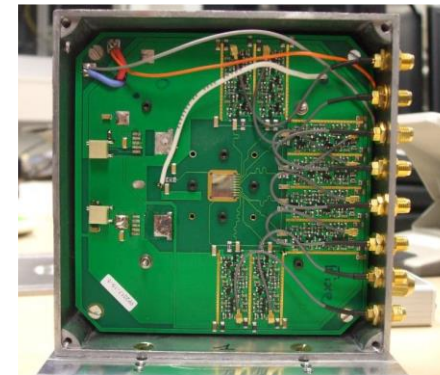
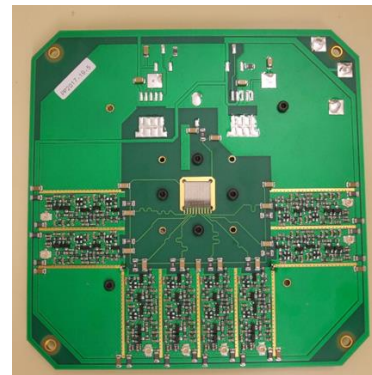
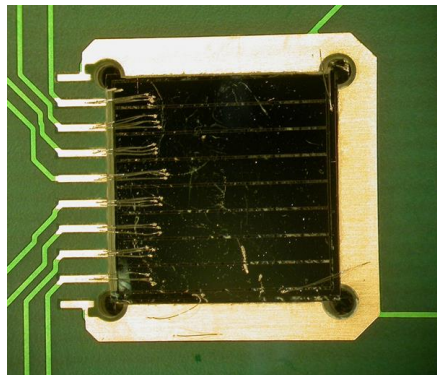
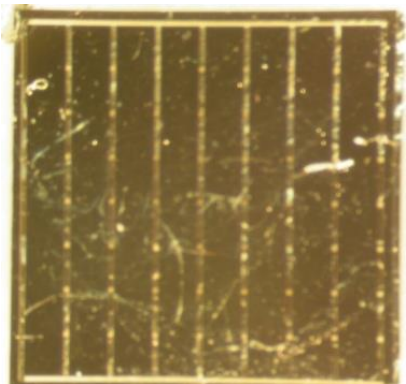
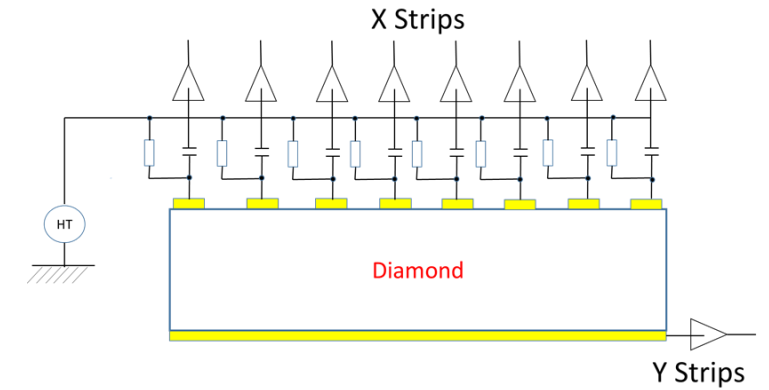
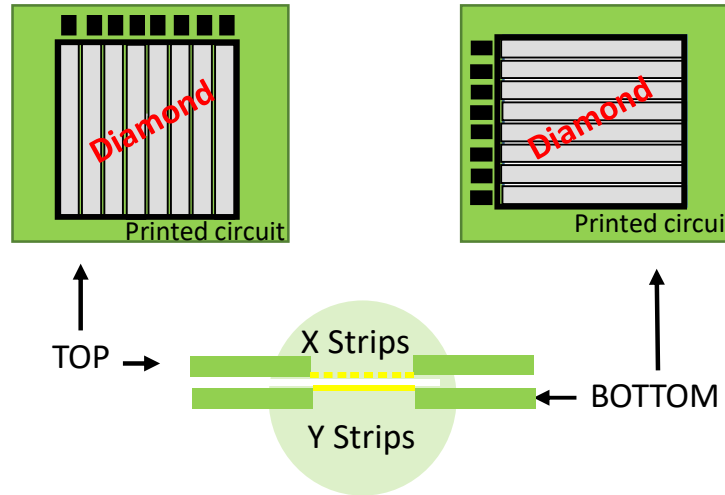

NANOFAB plateform @ Néel Insitute, Grenoble

- Strips by UV lithography
- Wire bonding

LPSC Grenoble

- Printed Circuit Boards
- Discrete current preamplifiers
- Mounting and assembling

Time-of-Flight resolution

Time resolution assessment

- Digitization of signals
- Normalized threshold discrimination
- Fitting

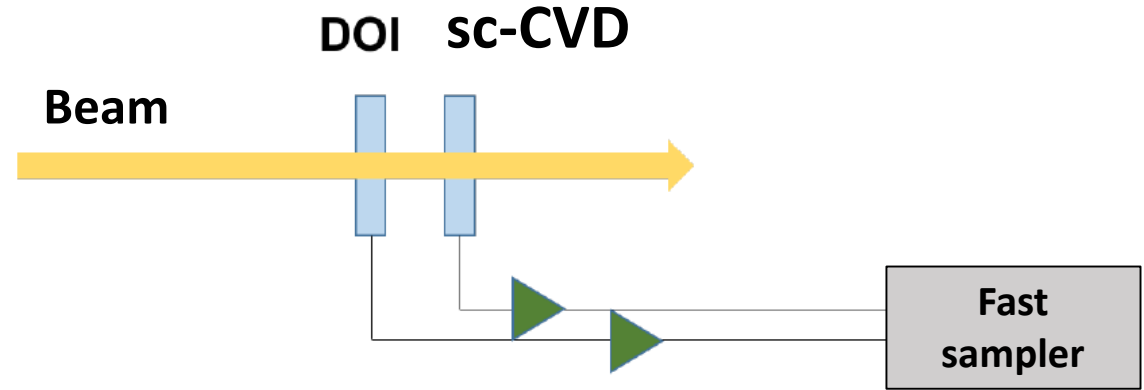

95 MeV/u ^{12}C ions @ GANIL

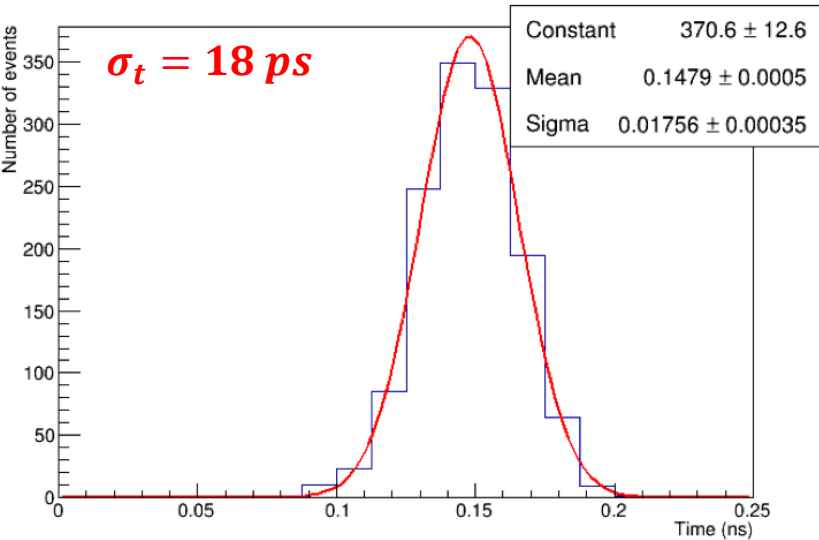

$\Delta E = 25 \text{ MeV}$ (300 μm diamond)

68 MeV protons @ ARRONAX

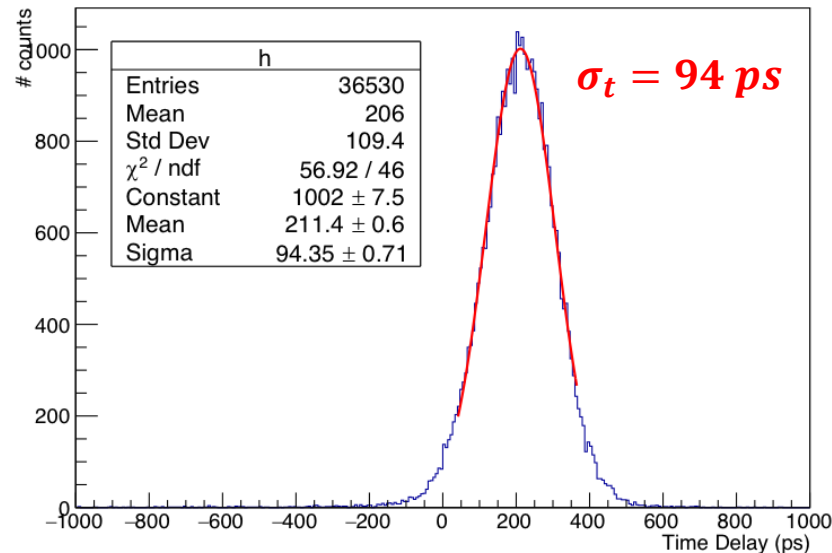

$\Delta E = 1 \text{ MeV}$ (300 μm diamond)

8.5 keV photons @ ESRF

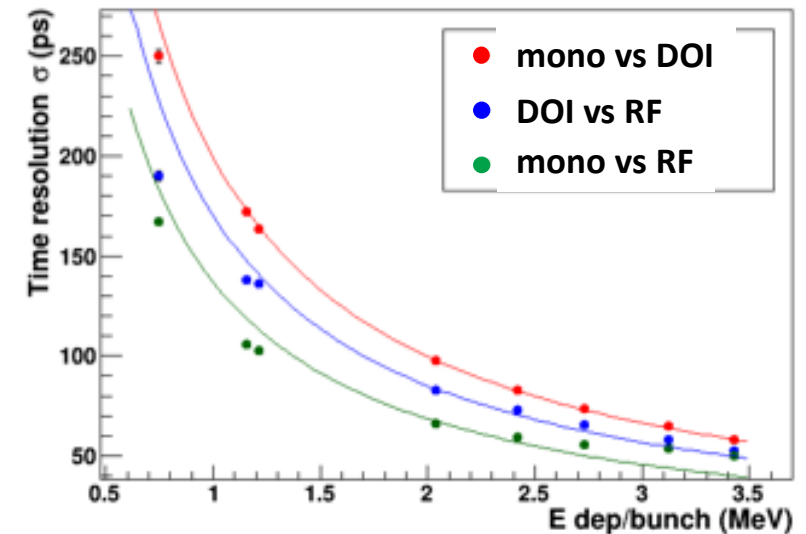

Specific detection efficiency

Pulsed beam - 68 MeV protons
 $\Delta E = 2 \text{ MeV}$ (2 protons in 300 μm diamond)

- Event filtering (amplitude and Time-of-Flight)
- Opposite faces signal summation:
 \rightarrow Signal-to-noise ratio $\times \sqrt{2}$
- Offline absolute threshold-based scanning

$$\varepsilon = \frac{N_{\text{triple}}}{N_{\text{double}}} \left(1 - \frac{N_{\text{random}}}{N_{\text{double}}} \right)$$

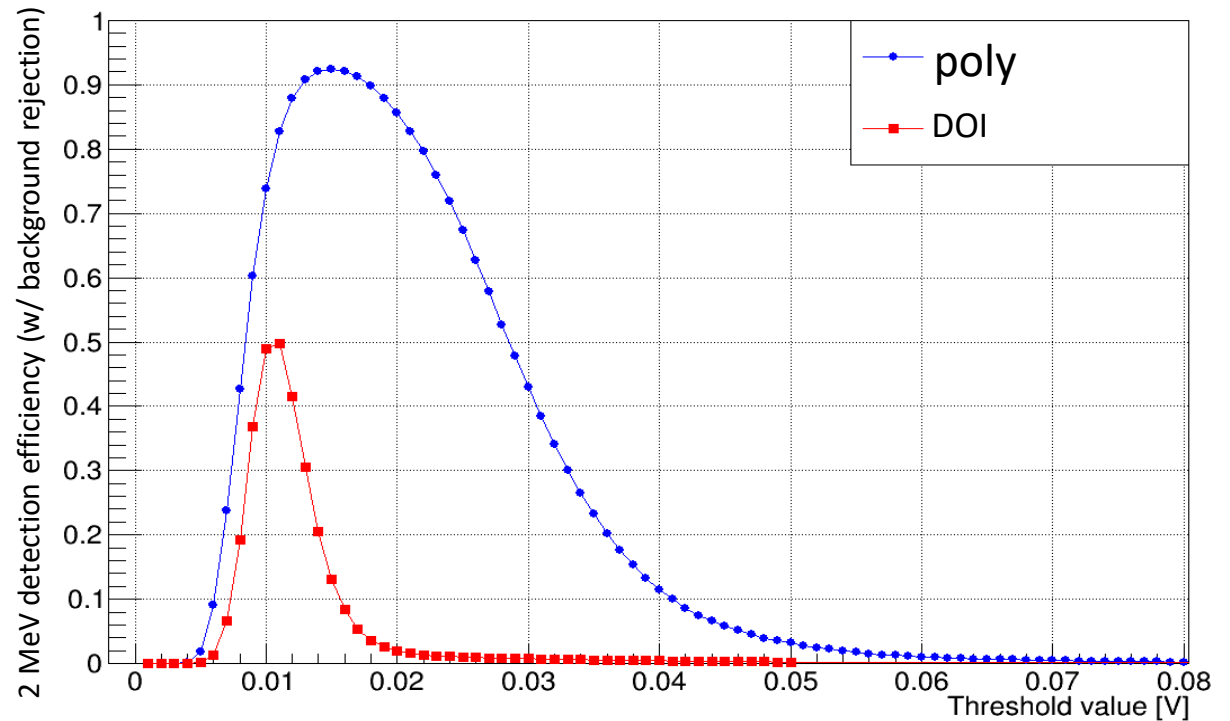
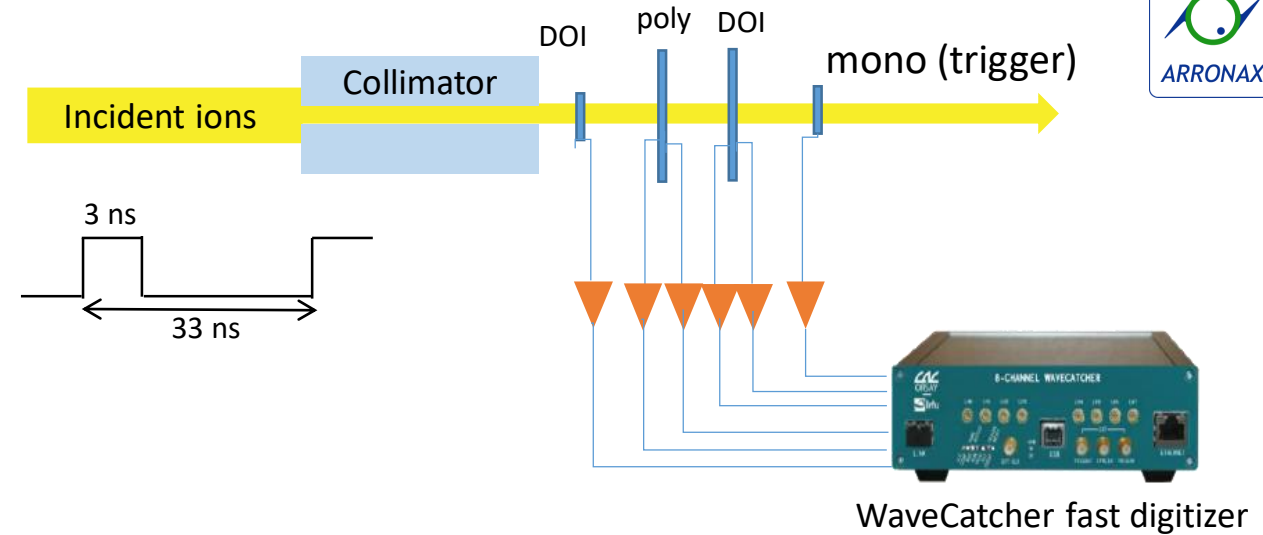

High beam current response

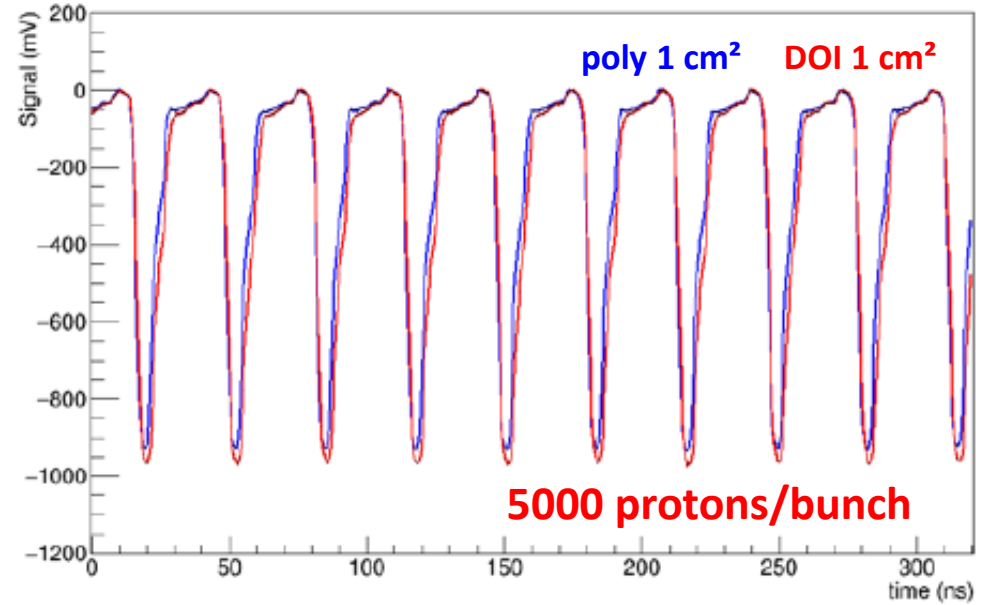
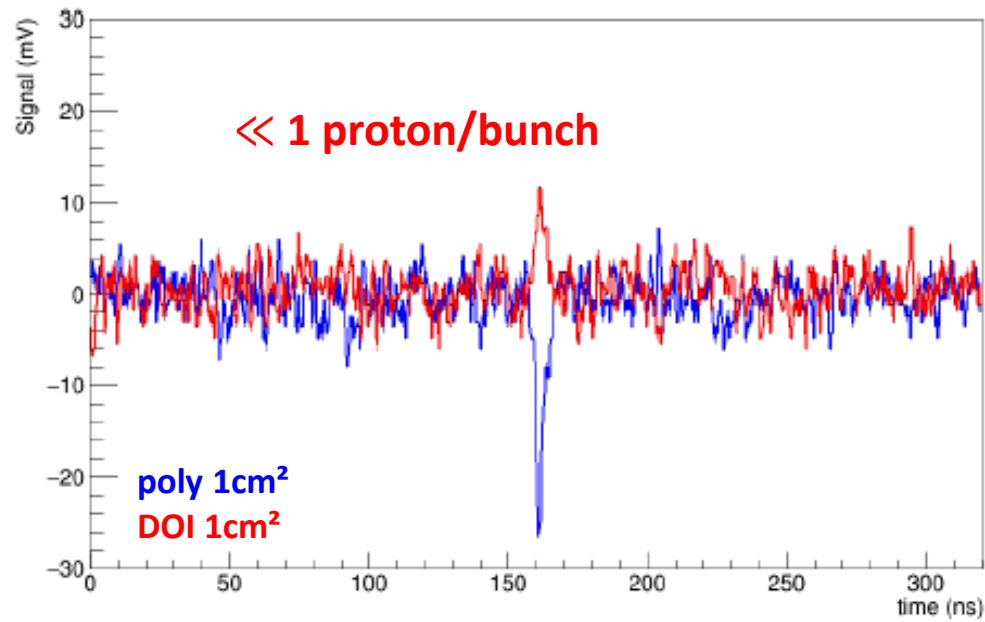
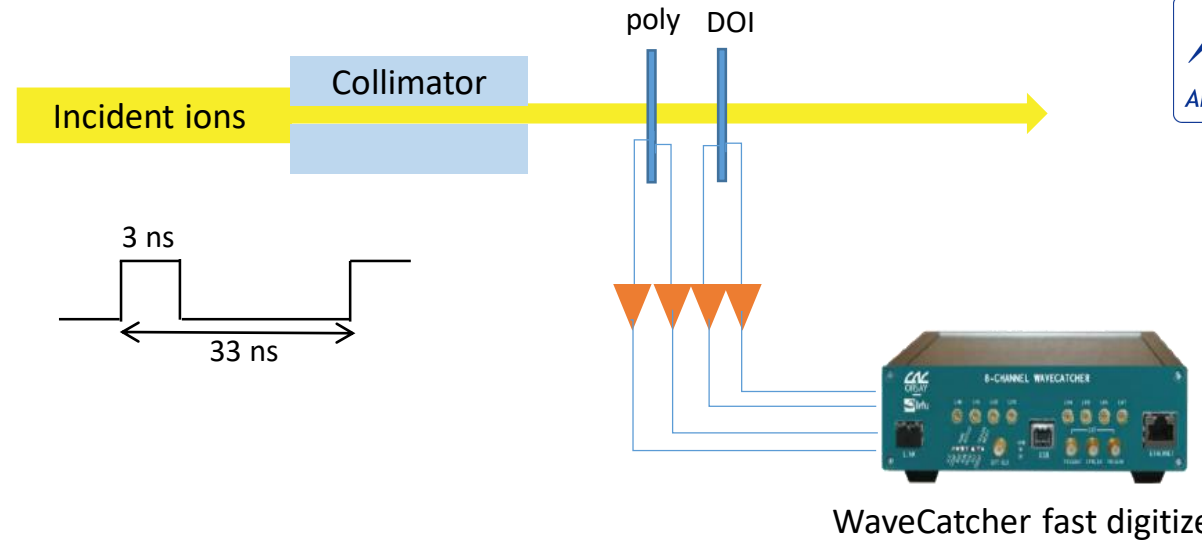

Characterization with X-ray micro-beam



Pulsed X-ray micro-beam (8.5 keV)

~1500 photons / pulse

\varnothing spot : 1 μm

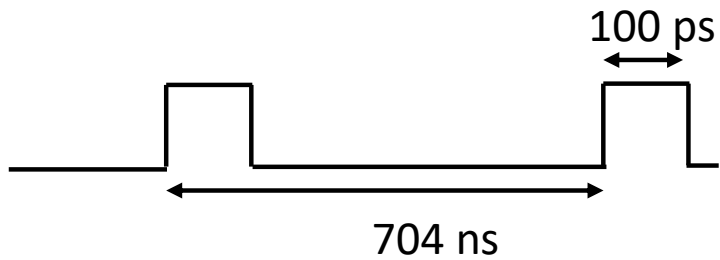

- Current mode: Surface scanning
- Pulse mode: Strip detectors performance

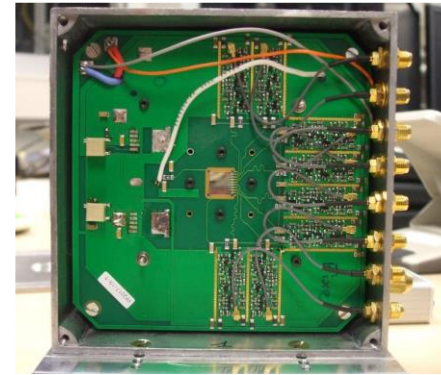

1 cm² poly

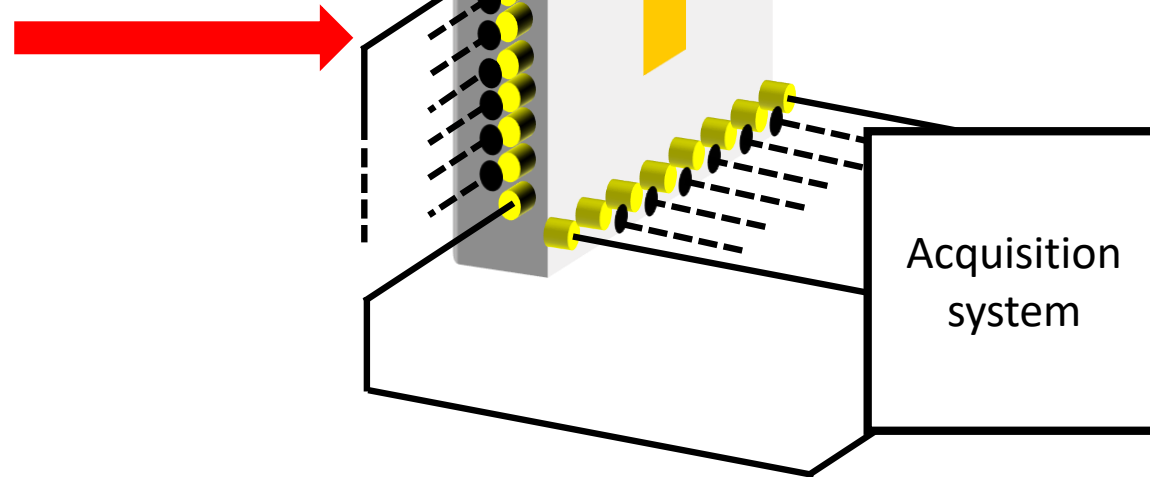
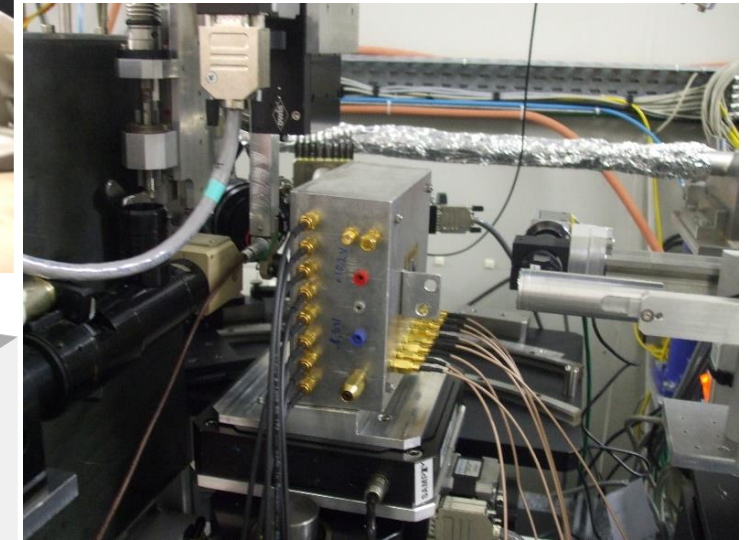

Strip detector time resolution

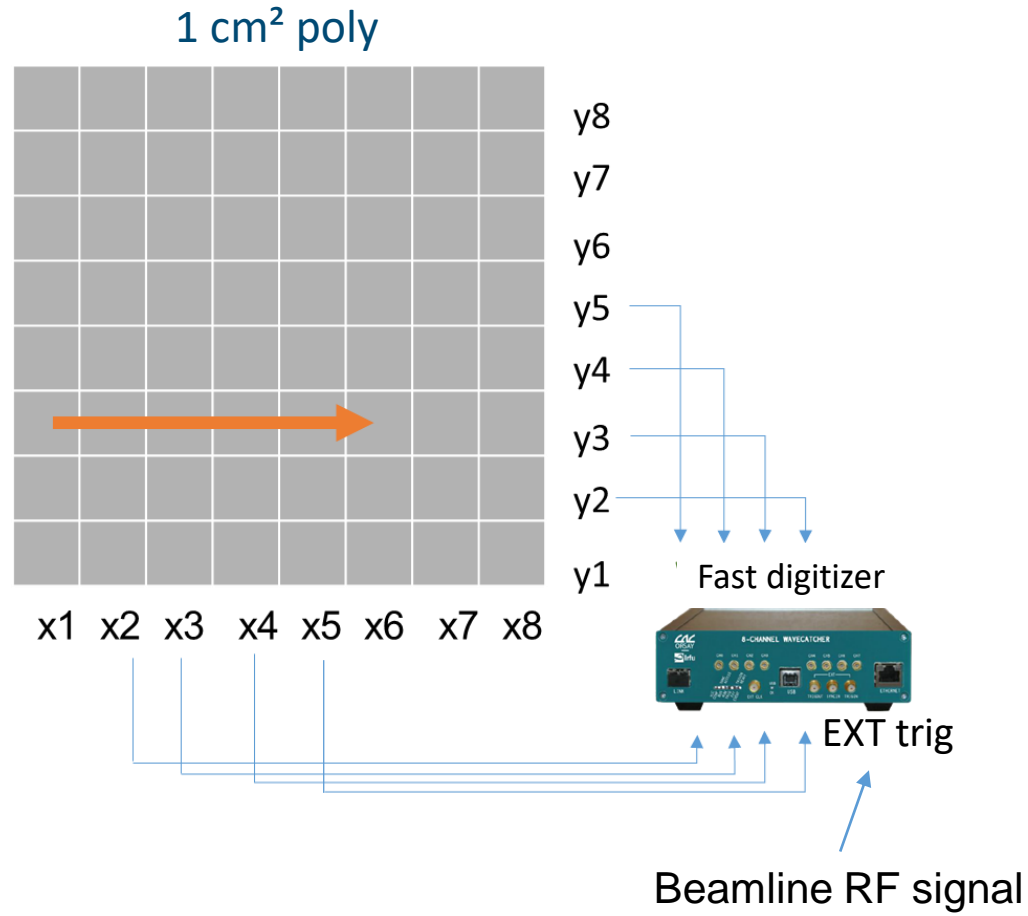

Intrinsic time resolution (rms)

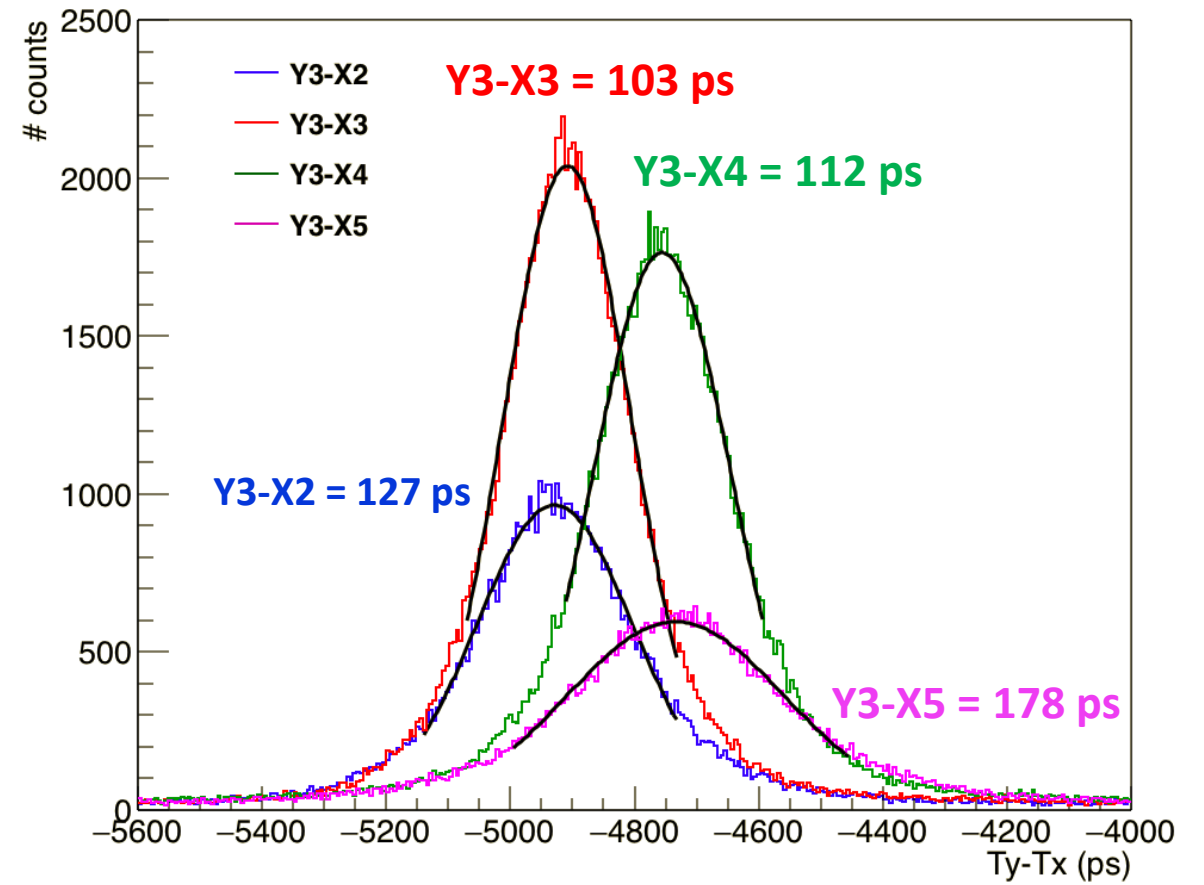

Prompt Gamma Timing @ ARRONAX

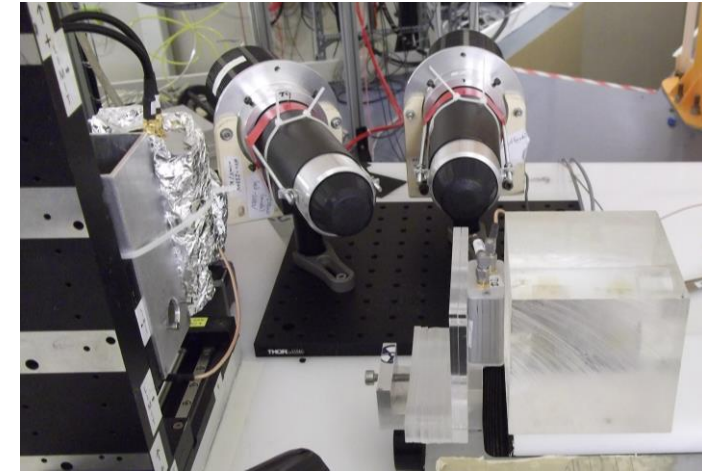
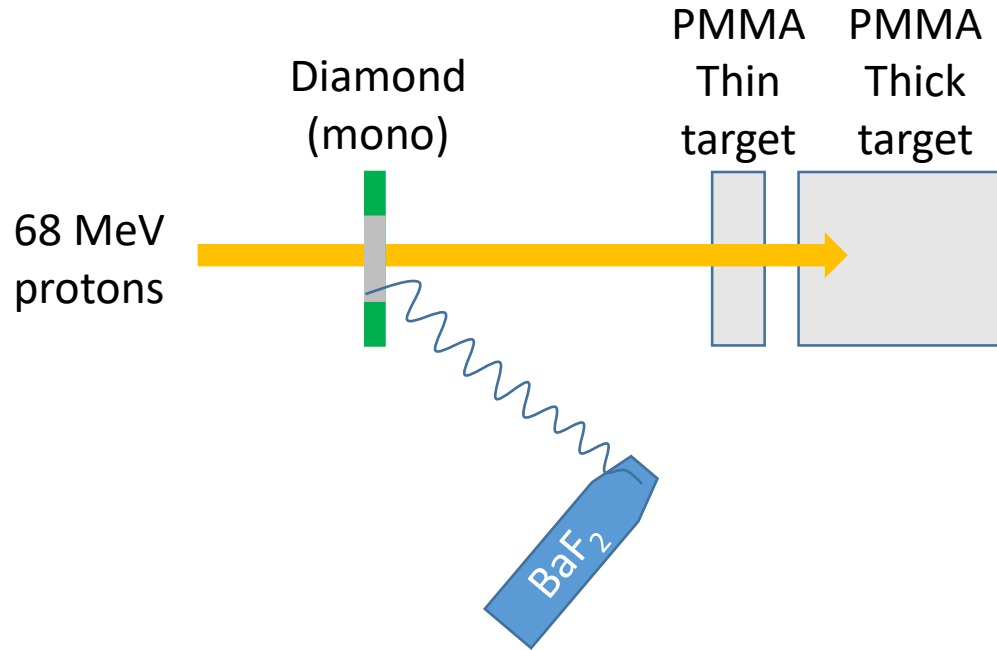

Diamond vs BaF₂ Time-of-Flight resolution

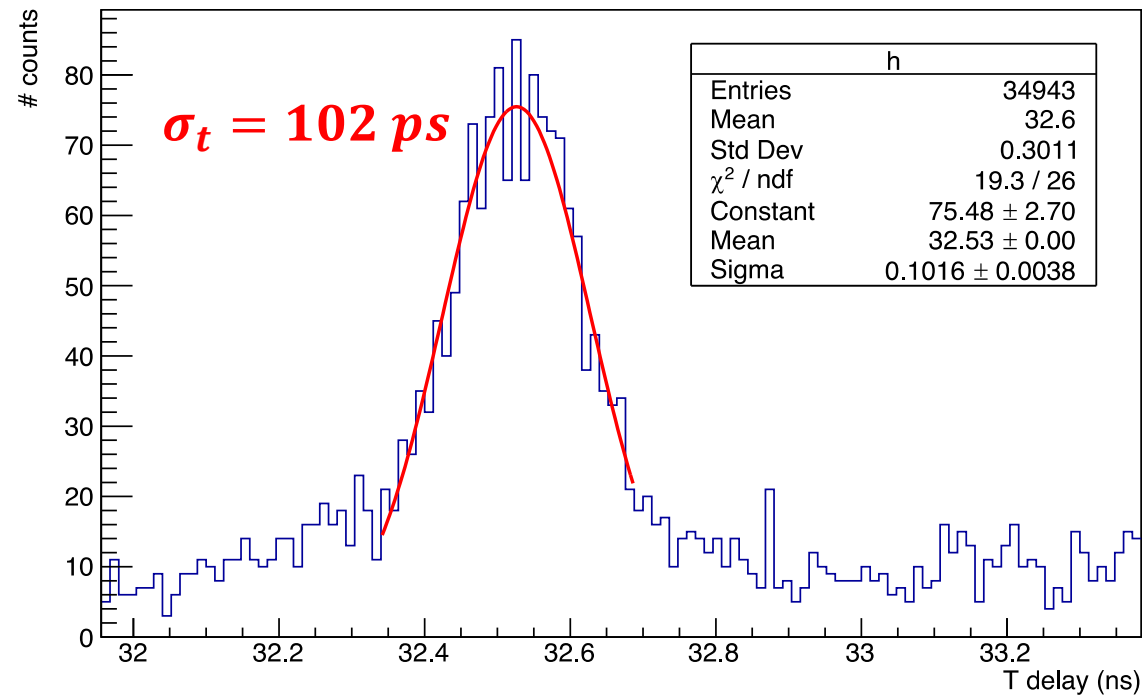

Conclusions

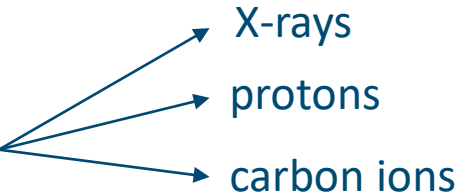
- Detectors characterized under various irradiation conditions 
- Comparison of performances obtained with different crystal qualities (mono, poly and DOI)
- Time resolution in good agreement with project specifications
- First strip sensors : satisfactory results

Perspectives

- Analysis to assess single proton detection efficiency is ongoing
- Assembling of a 4-diamond hodoscope demonstrator
- Both custom integrated and discrete electronics are currently developed and tested at LPSC
- Characterization with protons and carbon ions
- Integration to the CLaRyS μ TCA data acquisition system

Thank you for your kind attention

This work has been financially supported by:



Chemical Vapor Deposition

Plasma reactor

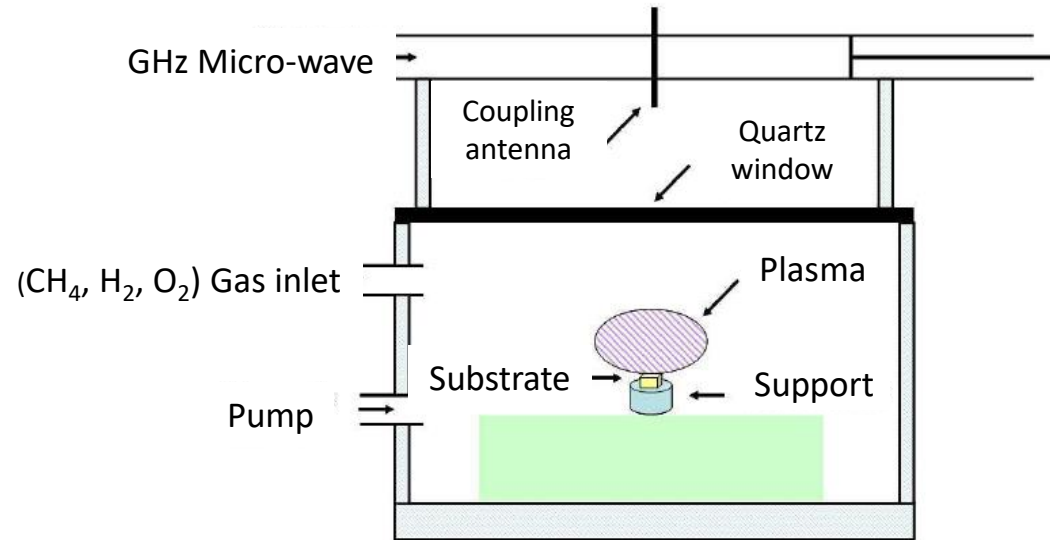

[F Marsolat PhD thesis, CEA-LIST 2013]

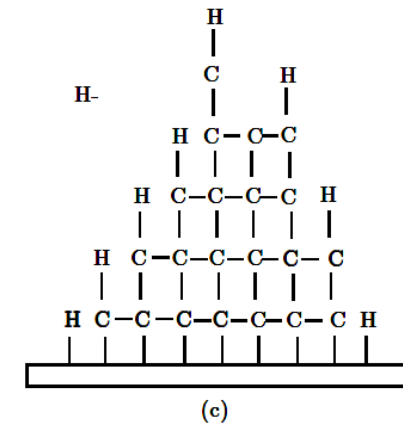
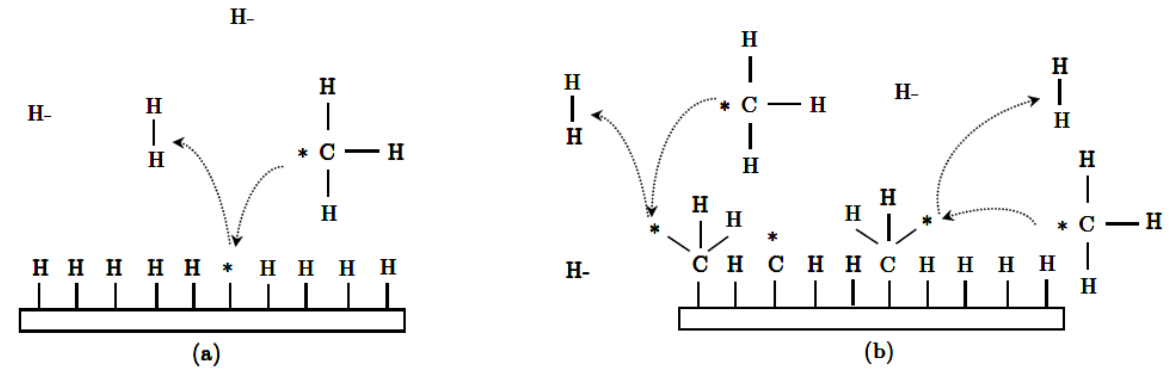

[D Tromson, PhD thesis, Univ. Paris 7 2000]

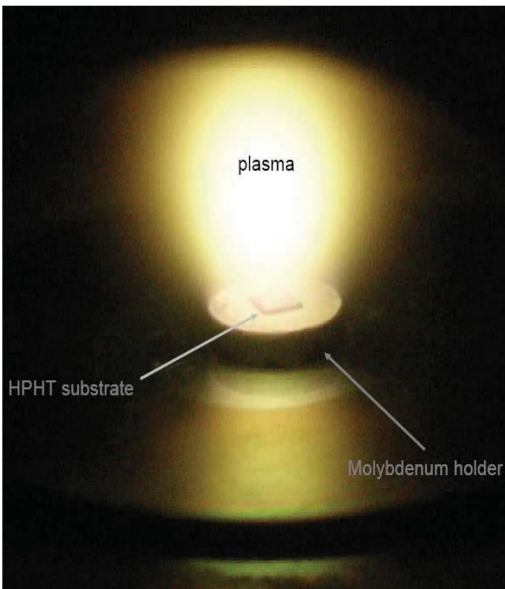

[M Pomorski, PhD thesis, Univ. Frankfurt 2008]

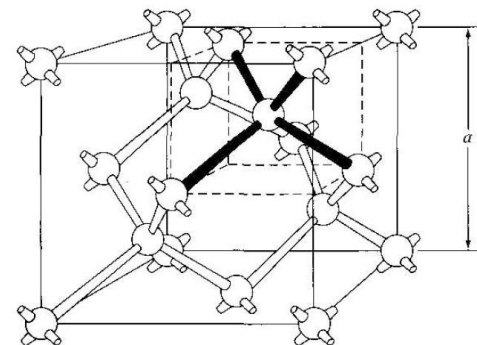



[M Pomorski, PhD thesis, Univ. Frankfurt 2008]

Different crystal qualities

2 growth processes:

- High Pressure High Temperature (boron and nitrogen contamination)
- **Chemical Vapor Deposition (CVD)**

	Single crystal (mono)	Polycrystalline (poly)	Heteroepitaxy on Iridium (DOI)
Max size.	4.5 x 4.5 mm ²	20 x 20 mm ²	10 x 10 mm ²
Fast response	+++	++	++
Sensitivity	++	+	?
Homogeneity	++	?	?
Availability			
Price	€€€	€	€€

Chemical Vapor Deposition

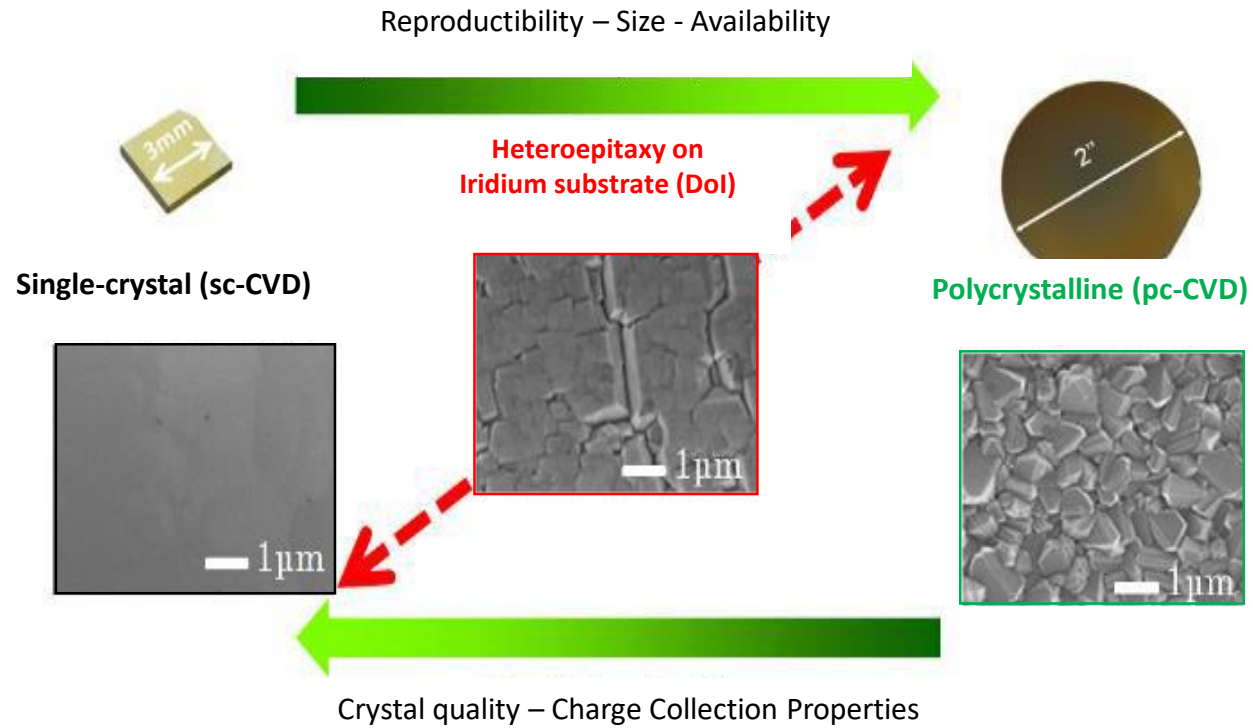

[N Vaissière PhD thesis, CEA-LIST 2014]

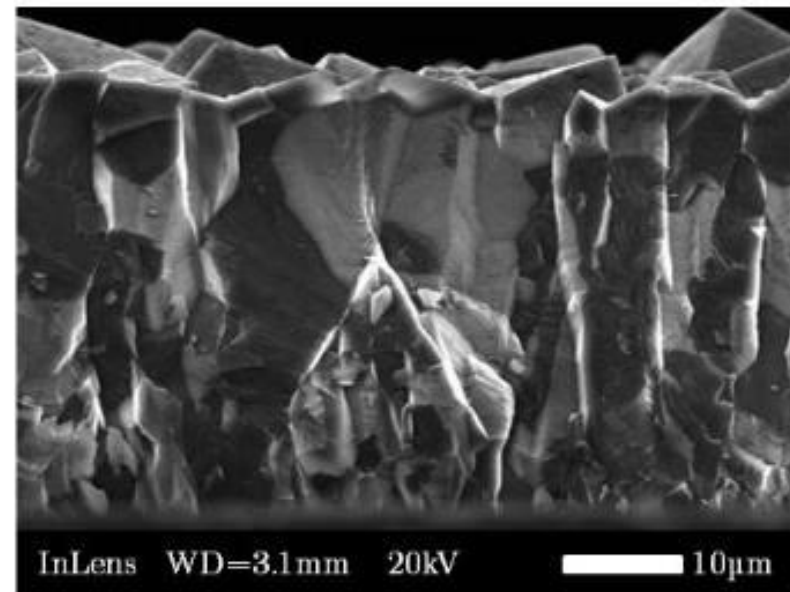

[N Vaissière PhD thesis, CEA-LIST 2014]

Normalised threshold discrimination

Leading edge threshold

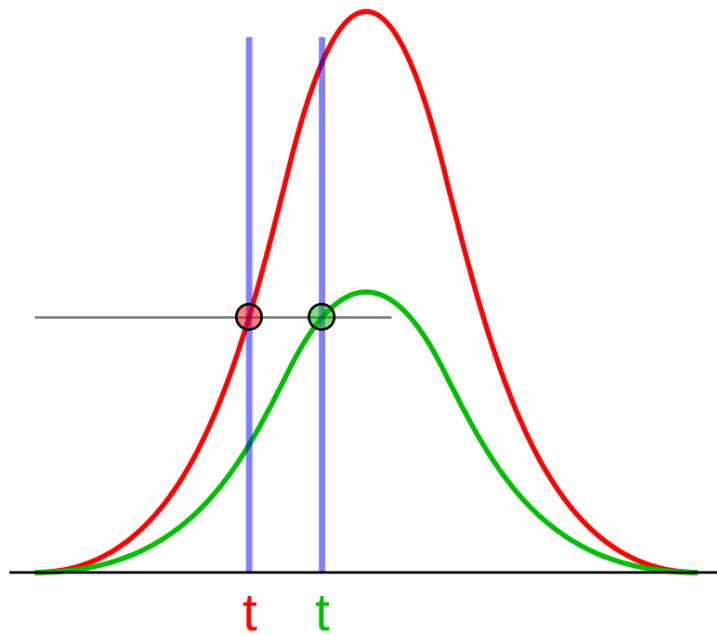

Normalised threshold

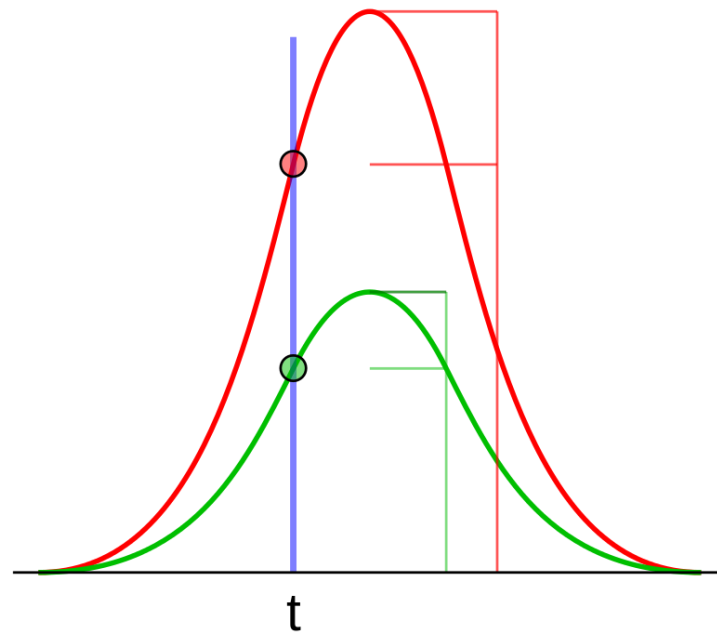

Limits the walk effect

Caractérisation en laboratoire

Source $\alpha = {}^{241}\text{Am}$ (~ 5.5 MeV, 6.38 kBq)

\leftrightarrow 14 μm dans diamant (\ll épaisseur)

➔ Polarisation sélectionne le porteur de charges étudié

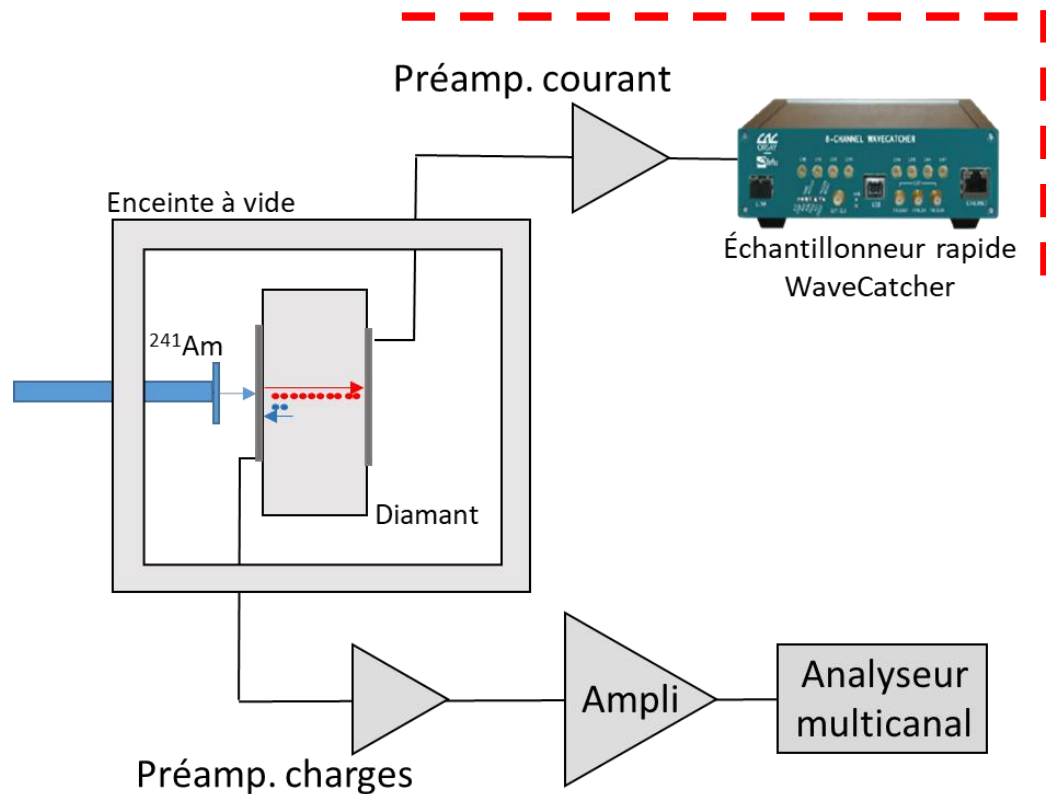

Electronique rapide

Conserve la forme originelle du signal généré dans le diamant

- Analyse de forme \rightarrow qualité de l'échantillon
- Propriétés porteurs de charges (vitesses de dérive, mobilités, temps de vie effectif...)

Caractérisation en laboratoire

Source $\alpha = {}^{241}\text{Am}$ (~ 5.5 MeV, 6.38 kBq)

$\leftrightarrow 14 \mu\text{m}$ dans diamant (\ll épaisseur)

➔ Polarisation sélectionne le porteur de charges étudié

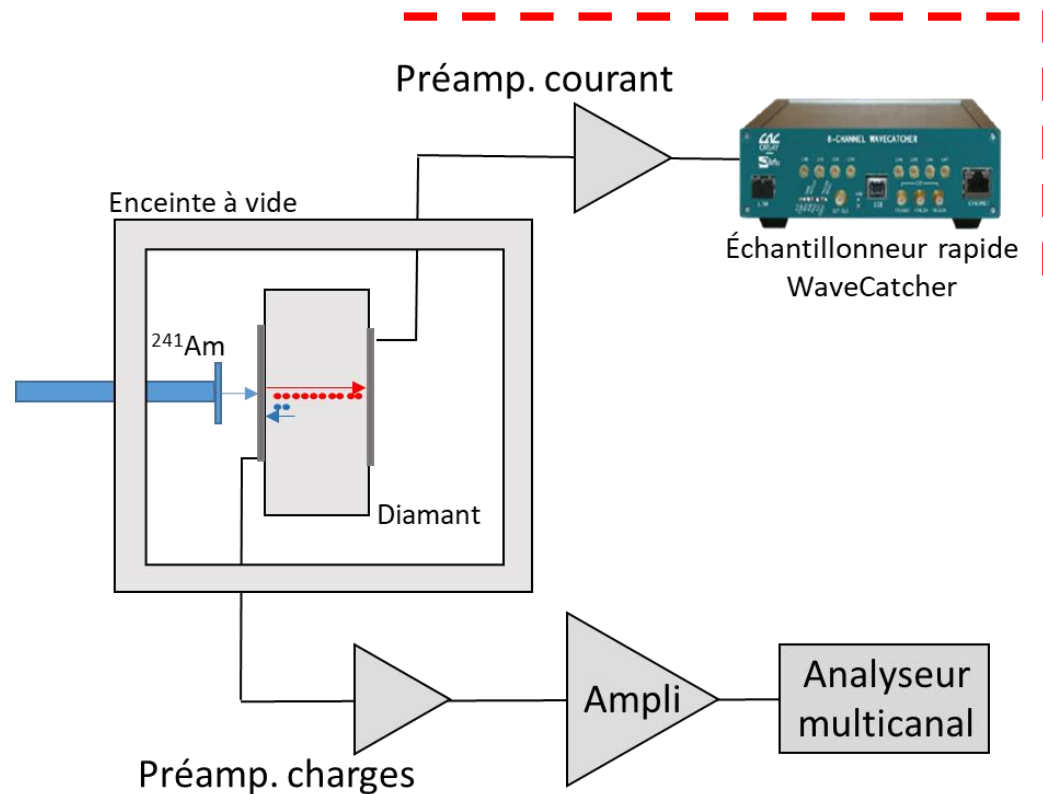

Electronique rapide

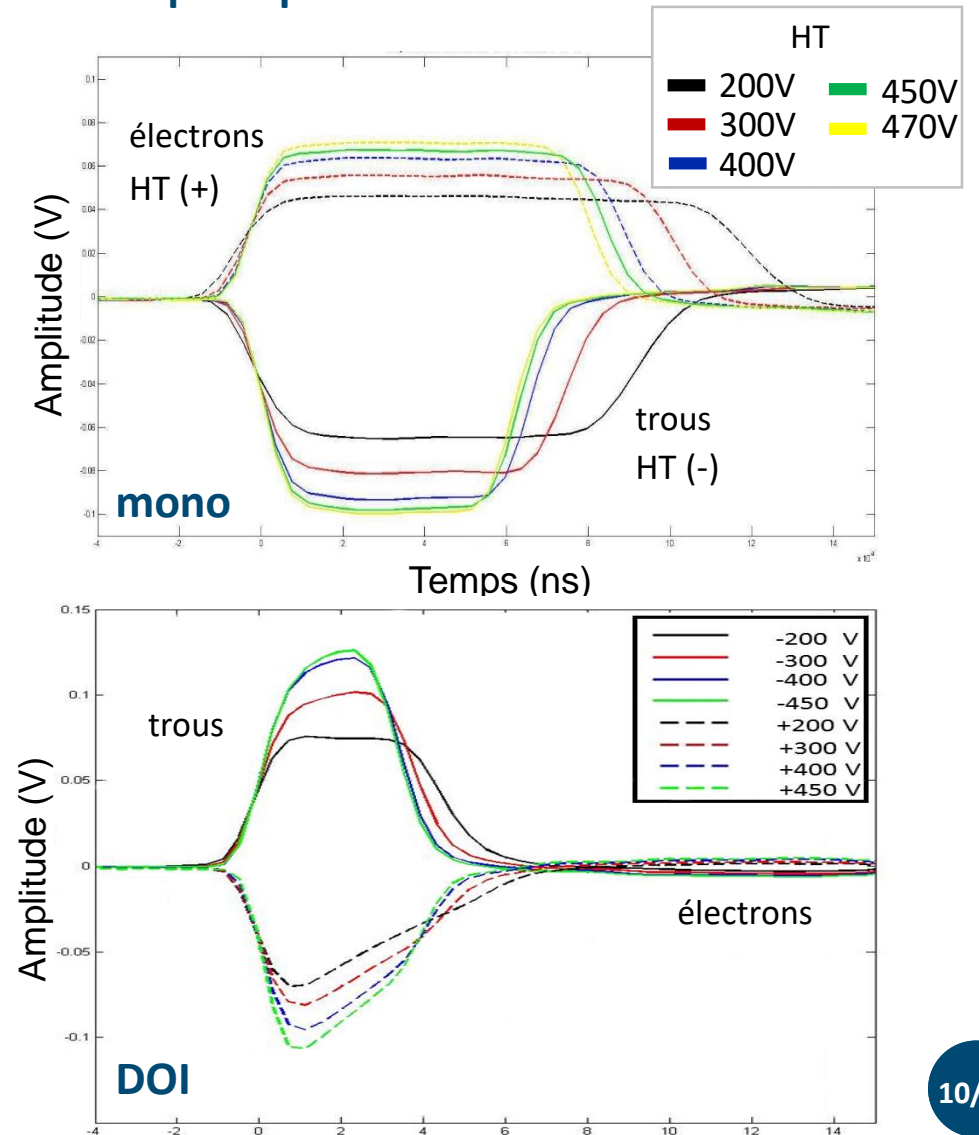

Caractérisation en laboratoire

Source $\alpha = {}^{241}\text{Am}$ (~ 5.5 MeV, 6.38 kBq)

$\leftrightarrow 14 \mu\text{m}$ dans diamant (\ll épaisseur)

➔ Polarisation sélectionne le porteur de charges étudié

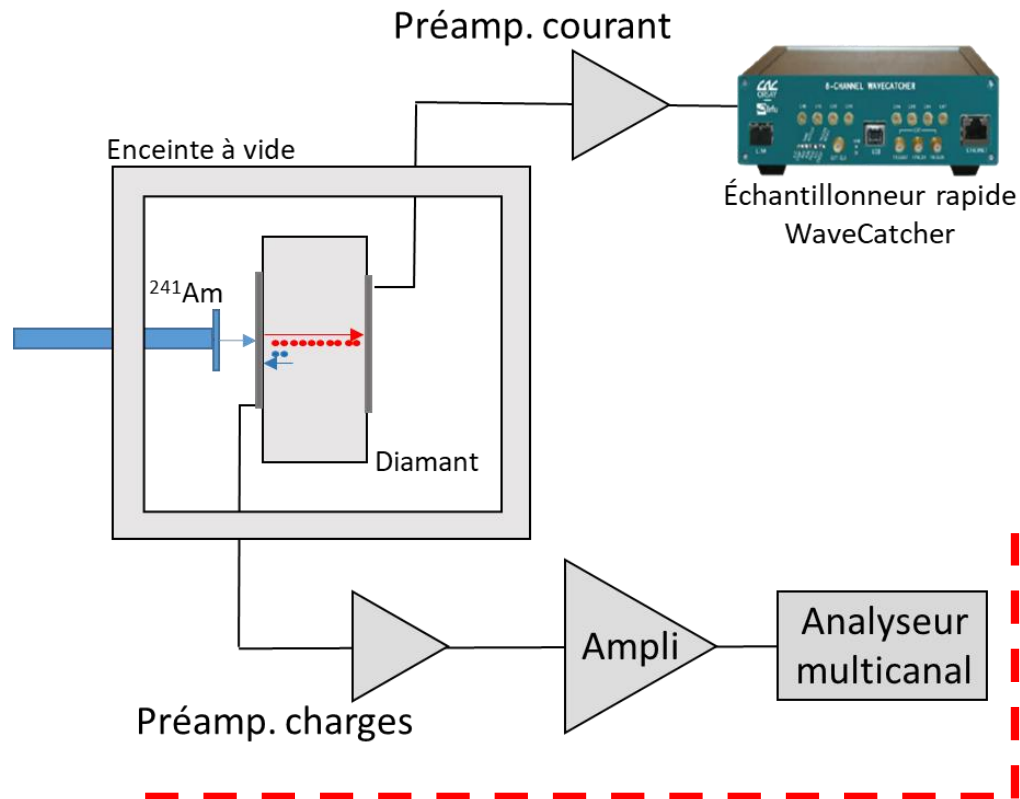

Electronique de spectroscopie

Intègre/filtre le signal

→ Augmente le rapport Signal/Bruit

- Résolution en énergie
- Efficacité de Collection de Charges (CCE)

$$CCE = Q_{collectée} / Q_{générée}$$

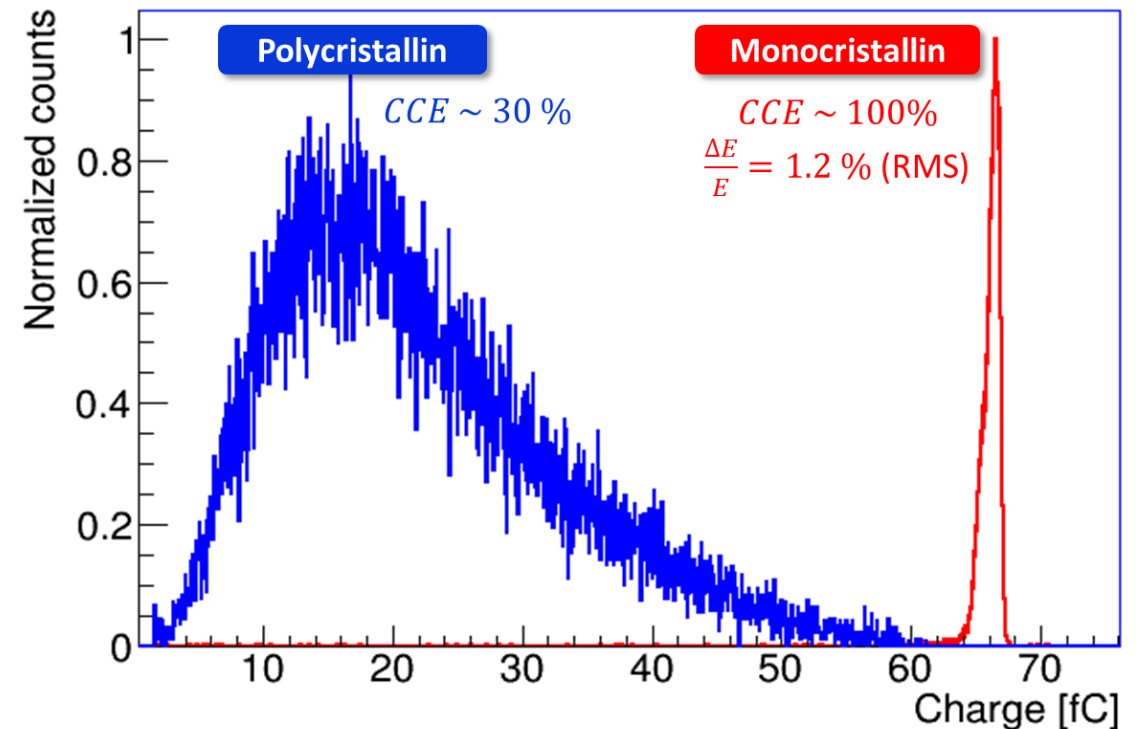

Current mode response

X-ray induced current mapping

DOI

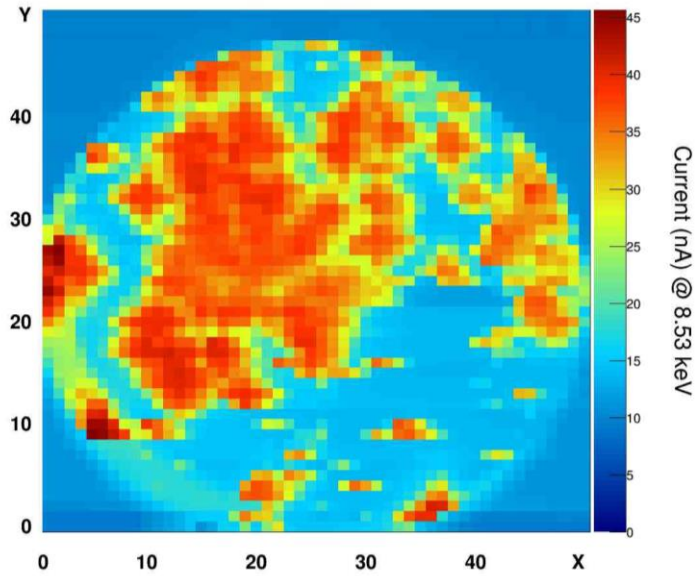

mono

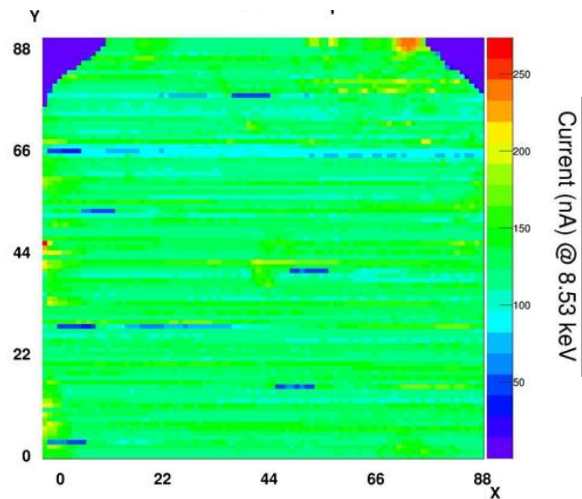

8.5 keV X-rays

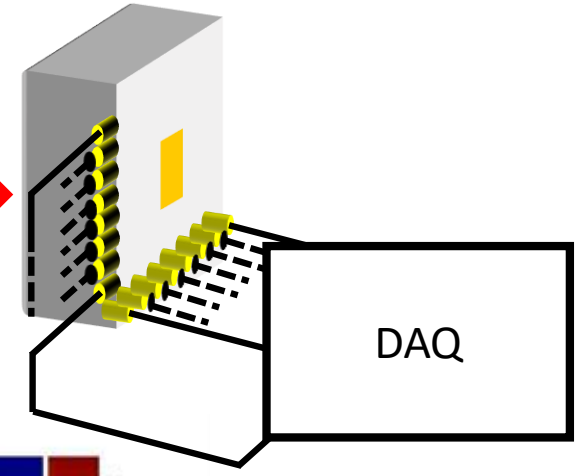

poly (stripped 1cm²)

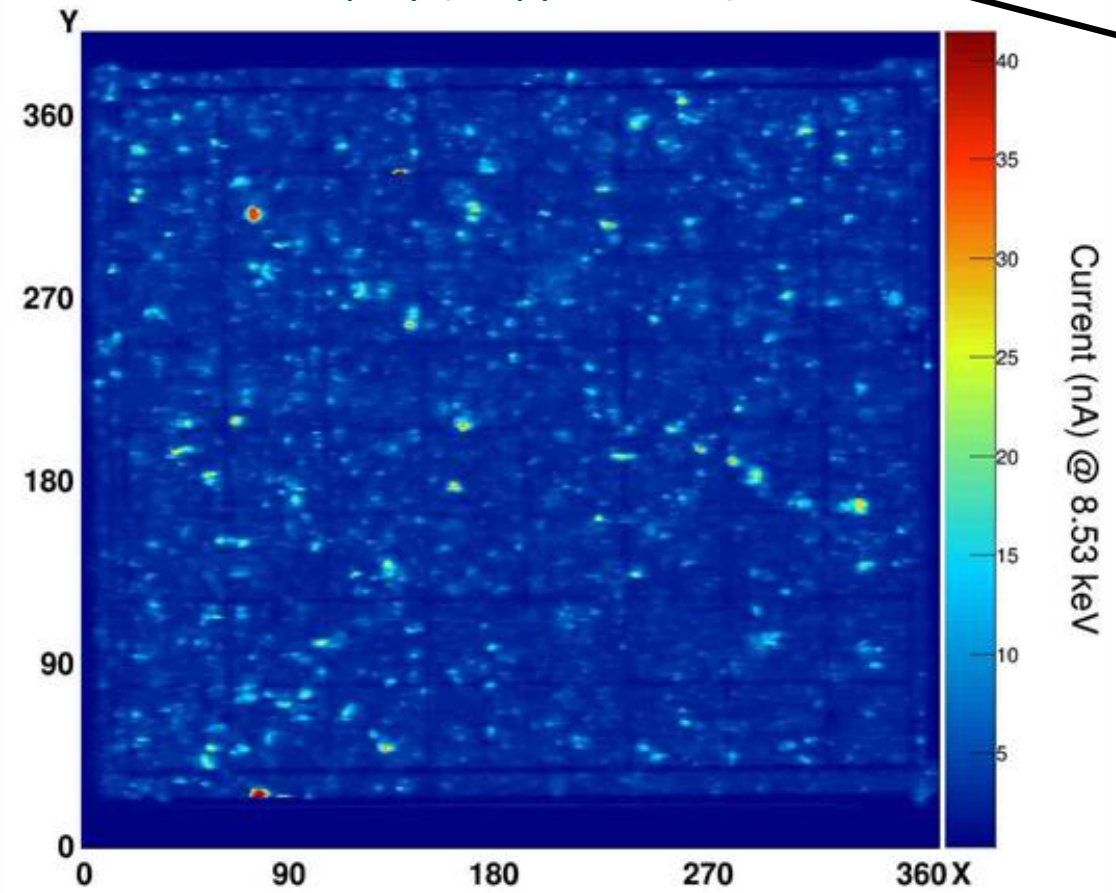

Strip detector detection efficiency

Detection efficiency
(with respect to the
beamline RF signal)

- Y3-X2
- Y3-X3
- Y3-X4
- Y3-X5

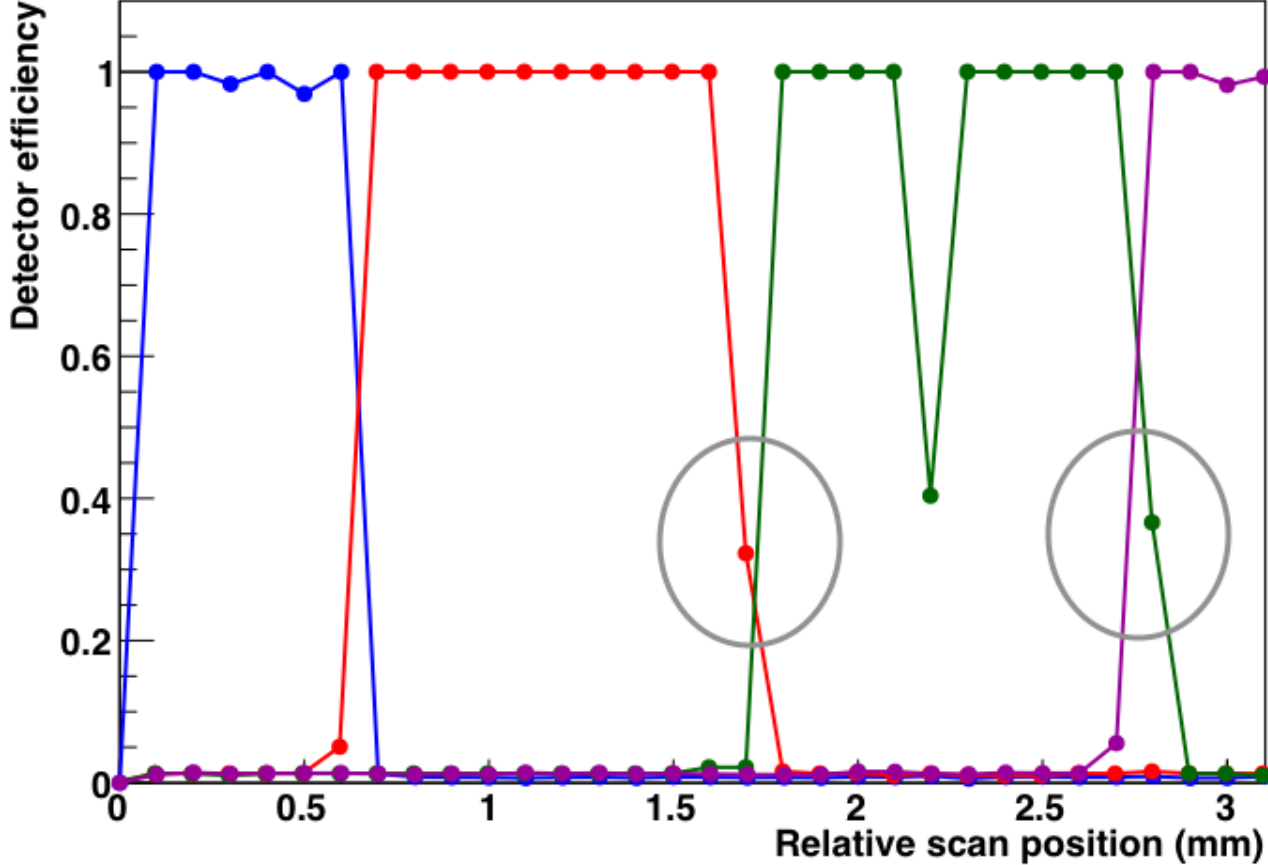
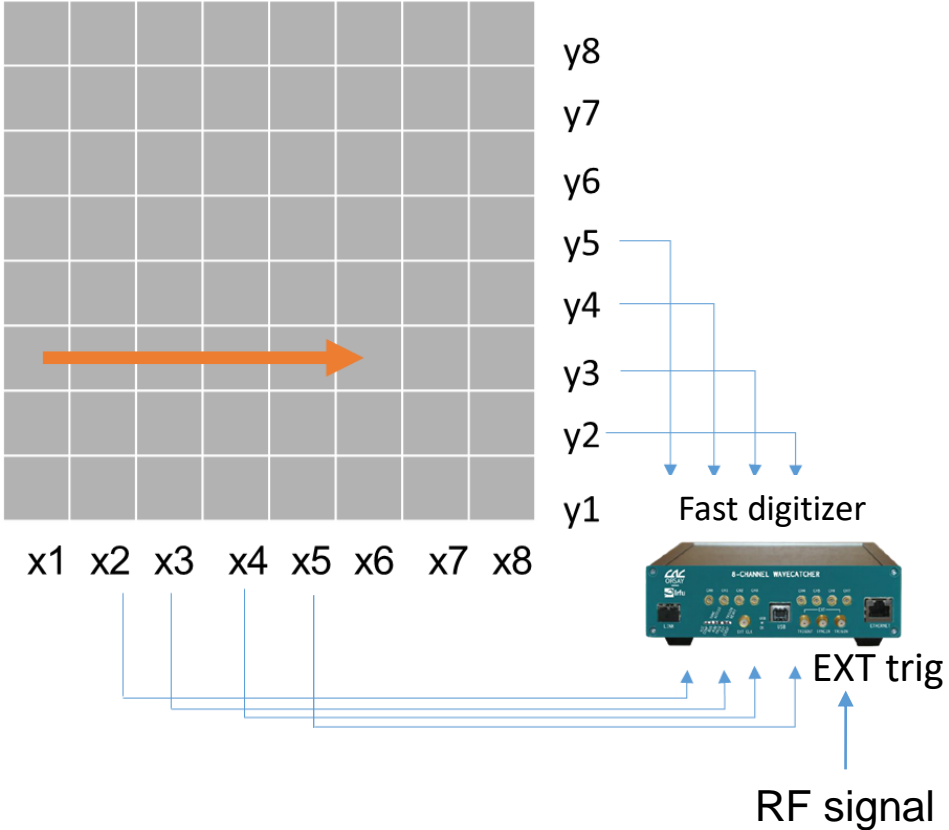

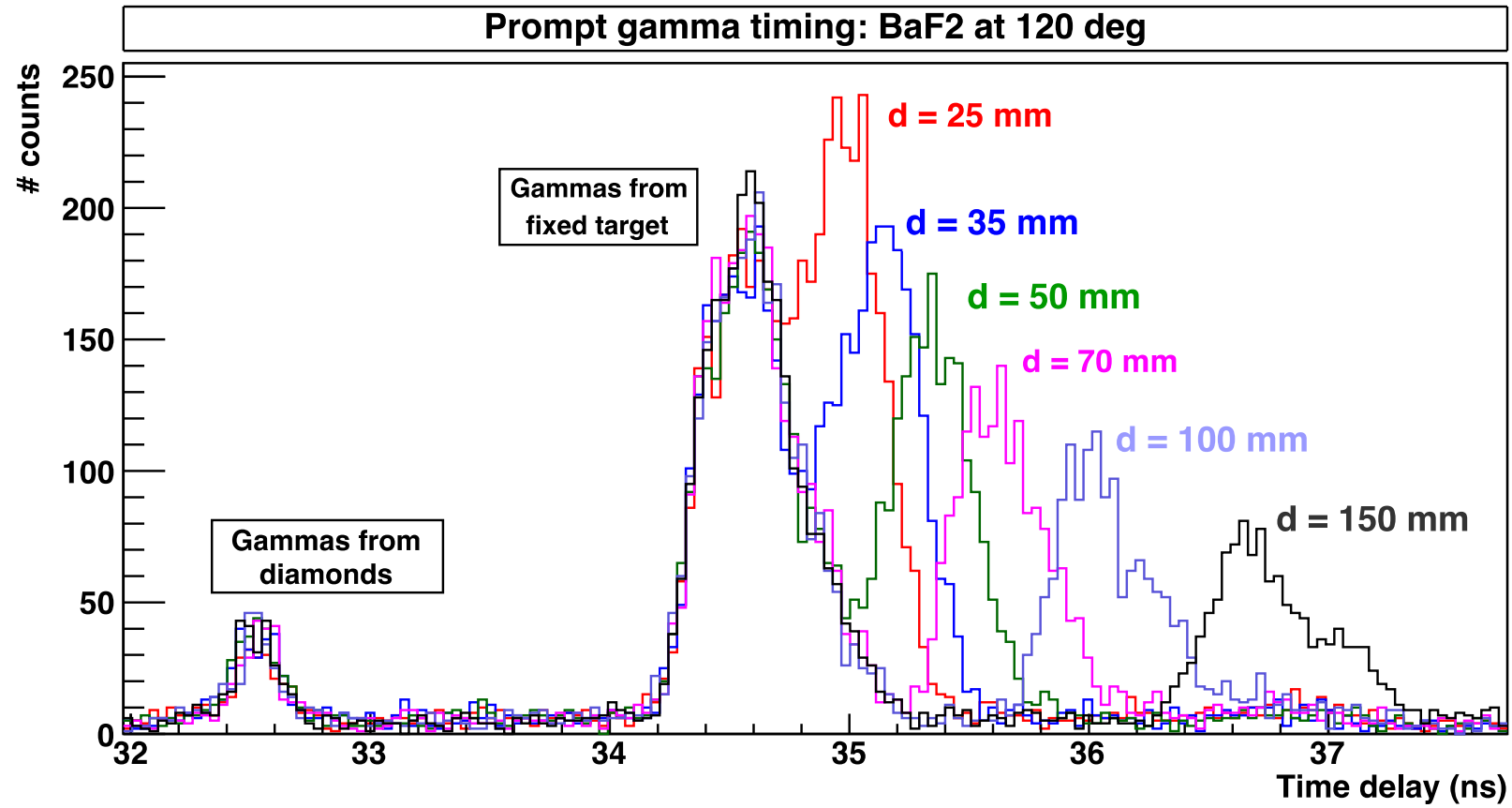

Développements en électronique

G. BOSSON, J. BOUVIER, L. GALLIN-MARTEL, A. GHIMOUZ, C. HOARAU, F. RARBI, O. ROSSETTO

- Conception de circuits intégrés spécifiques (ASIC)

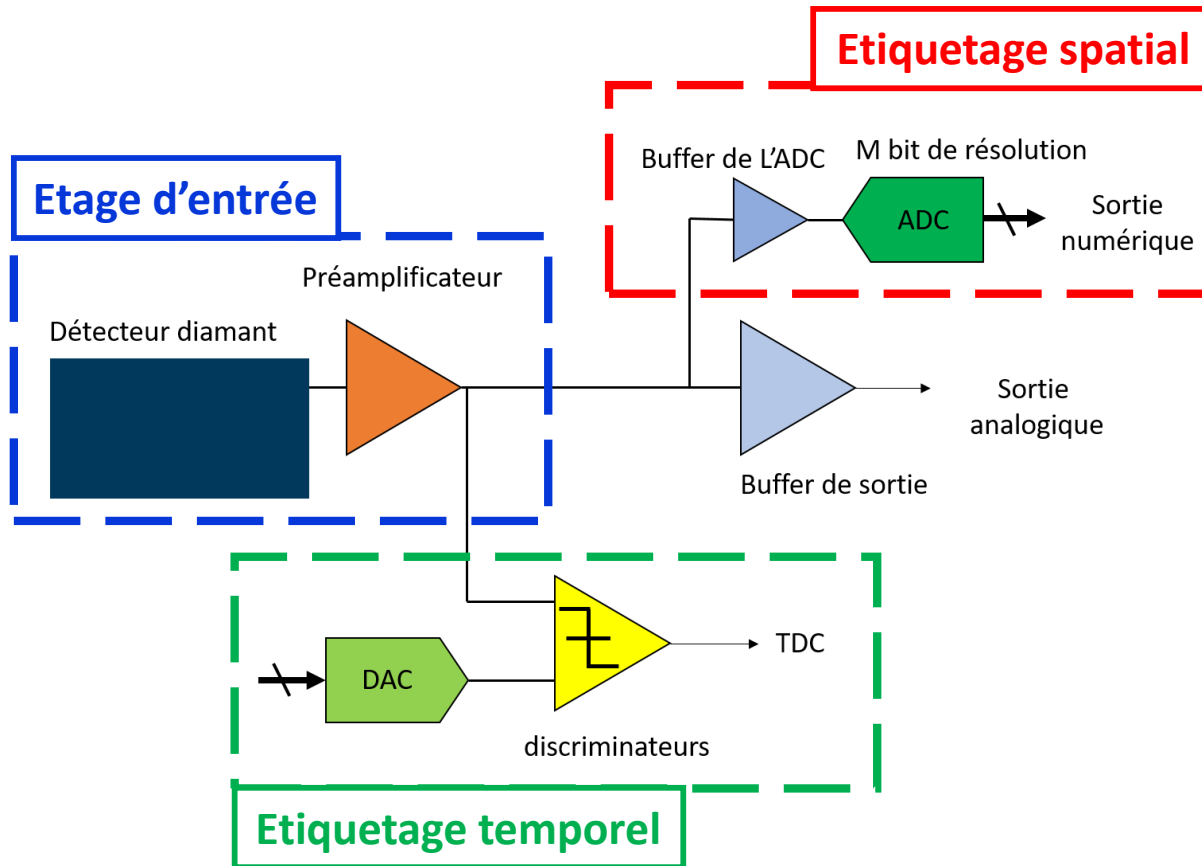

ASIC 8 voies

- Technologie CMOS 130 nm (CERN)
- Résistant aux radiations
- Soumis en Décembre 2018

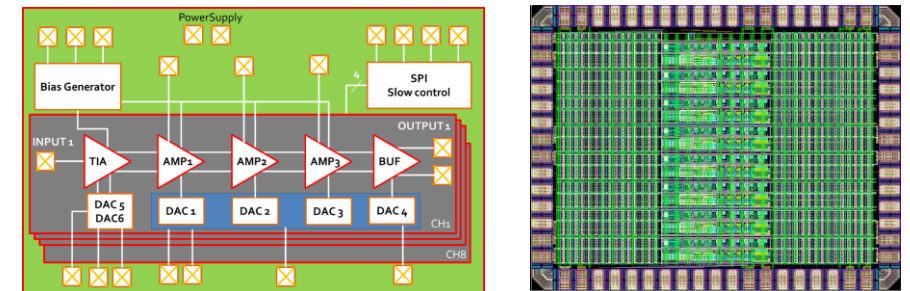

Préamplificateurs courant discrets

- En boîtier ou monté sur carte
- Solution alternative

