



HAL
open science

Evaluation of loss effect on optimum operation of variable speed micro-hydropower energy conversion systems

Hossein Iman-Eini, David Frey, Seddik Bacha, Cedric Boudinet, Jean-Luc Schanen

► To cite this version:

Hossein Iman-Eini, David Frey, Seddik Bacha, Cedric Boudinet, Jean-Luc Schanen. Evaluation of loss effect on optimum operation of variable speed micro-hydropower energy conversion systems. *Revista Brasileira de Economia*, 2019, 131, pp.1022–1034. 10.1016/j.renene.2018.07.122 . hal-02350916

HAL Id: hal-02350916

<https://hal.science/hal-02350916>

Submitted on 19 Oct 2020

HAL is a multi-disciplinary open access archive for the deposit and dissemination of scientific research documents, whether they are published or not. The documents may come from teaching and research institutions in France or abroad, or from public or private research centers.

L'archive ouverte pluridisciplinaire **HAL**, est destinée au dépôt et à la diffusion de documents scientifiques de niveau recherche, publiés ou non, émanant des établissements d'enseignement et de recherche français ou étrangers, des laboratoires publics ou privés.

Evaluation of Loss Effect on Optimum Operation of Variable Speed Micro-hydropower Energy Conversion Systems

Hossein Iman-Eini¹, David Frey², Seddik Bacha², Cedric Boudinet², and Jean-Luc Schanen²

¹School of Electrical and Computer Engineering, College of Engineering, University of Tehran, Tehran, Iran

²Grenoble Electrical Engineering Laboratory, Grenoble Alpes University, 38402 Grenoble, France

Corresponding author e-mail address: imaneini@ut.ac.ir

Abstract- This paper evaluates the effect of converter and generator losses on the maximum power point (MPP) of variable speed micro-hydropower energy conversion systems. As a case study, a semi-Kaplan micro-hydropower turbine with a permanent magnet (PM) generator and a back-to-back full converter is considered. Using the analytical model, different loss terms, such as converter losses, PM generator losses and mechanical losses are calculated at different shaft speeds. Then, the curves of turbine power and injected power to the grid are extracted as a function of turbine speed. It is shown that the maximum attainable power of the variable-speed hydropower system does not correspond to the MPP of hydraulic turbine. In other words, to get the maximum power from the whole hydropower system, it is necessary to consider power losses of the electric generator and power electronic interface between the turbine and the grid. These power losses can change the power-speed characteristics or MPP location of the hydropower system. According to this fact, the conventional MPP tracking (MPPT) algorithms which try to track the MPP of hydraulic turbines fail to extract the maximum power. Hence, a modified perturb and observe (P&O) MPP tracking algorithm is proposed for the variable speed hydropower systems to increase their efficiency. The modified tracking algorithm finds the "optimum MPP" automatically and without the extra calculations. Also, the injected power to the grid is increased 3.7% when the modified algorithm is applied to the studied case study. Finally, the validity of theoretical claims is verified by experimental tests on a 5 kW hardware prototype.

Keywords- Full converter, Loss calculations, Micro-hydropower, MPPT algorithm, Permanent magnet synchronous generator, Variable speed hydropower system

1- Introduction

Hydropower is one of the earliest and most commonly used renewable sources of electricity in the human life. It represents more than 16% of the global electricity generation [1], and is the largest global renewable energy source [2]. This source of energy can be converted to electricity via the hydraulic turbine and electric generator. The size of hydraulic turbine may vary from several kW to hundreds of MW, where the term micro-hydropower is used for the turbines with a capacity lower than 100 kW [3]. In micro-hydropower stations, the plant is usually installed in a run-of-river manner with a small reservoir or no reservoir and the water head is low. Such hydropower stations represent an environmentally friendly solution, since they do not interfere with the rivers flows [4].

The early hydropower stations were of fixed speed type. This kind of stations suffers from two main problems: 1-inability to produce power in the whole range of water head and 2-low efficiency in partial generation or under off-design operating condition [5]. Some references have focused on the hydraulic design and flow characteristics optimization of hydraulic machineries to increase efficiency and reduce energy loss. In [6], unsteady cavitation flows under off-design conditions and their impacts on the efficiency and the operational stability are studied. In [7], a systematic investigation into the influence of tip clearance size on energy performance and pressure fluctuation for a mixed-flow hydraulic machine is conducted. Ref. [8] evaluates the role of blade rotational angle in the energy performance and pressure fluctuation of the mixed-flow hydraulic machine through an experimental measurement and numerical simulation.

By recent advances in the power electronics, the variable speed operation can be employed for the hydropower systems similar to modern wind turbine energy conversion systems (WTECs). This technology allows

48 controlling the turbine speed in a wide range of water flows and water heads. It has higher efficiency than
49 alternative approaches and lower operating costs. Moreover, it can help to improve dynamic stability of the
50 turbine at off-design condition [9]. The cavitation effect can be mitigated and the drive train can be simplified
51 more. Also, by the increase of total generated power, the income of hydropower station increases [10].

52 The literature review shows that two approaches have been developed for variable speed hydropower and
53 WTEC stations, which are Doubly-Fed Induction Generator (DFIG) and Full Power Converter (FPC) back-to-back
54 connection with synchronous generator [11]. The main goal in these approaches is to adjust the turbine speed in a
55 wide range of operating conditions to achieve the maximum efficiency. To find the optimum operating speed,
56 there are two general approaches: indirect and direct approaches [12]. In indirect approaches, the optimum
57 operating point is estimated according to the data of sensors and existing characteristic curves of hydraulic
58 turbines in lookup tables. For example, reference [13] measures water head and water flow on-line to determine
59 the appropriate turbine blade positions according to hill-diagrams of Kaplan turbine. Also, reference [14] employs
60 a direct power control approach to directly control the injected power to the grid without the speed control loop.
61 This method, however, needs data of water flow, shaft speed and turbine dimensions to estimate the reference
62 power by mathematical models. In brief, necessity to some expensive sensors and inability to adapt the control
63 system to changes of hydraulic system are main drawbacks of the indirect approach [12].

64 On the other side, direct methods are based on searching algorithms and are generally independent from the
65 turbine parameters and do not need expensive sensors. These approaches have been well developed for wind
66 energy systems and are categorized as tip speed ratio (TSR) control, optimal torque (OT) control, power signal
67 feedback (PSF) control, perturb and observe (P&O) control, artificial intelligent methods, and hybrid control
68 techniques [15-20]. In all of these methods, the controller is designed to track the MPP of turbine and to get the
69 maximum power in a wide range of operating conditions. In contrast to WTECs, a few papers have been presented
70 in the field of variable speed hydropower systems to track the MPP of water turbine [21-23]. Reference [21]
71 introduces an adaptive P&O algorithm for micro hydropower systems. It employs an adaptive coefficient K which
72 increases in the tracking phase and decreases once the MPP is reached. This idea allows reducing the mechanical
73 shaft vibrations. The performance of adaptive P&O algorithm has been improved in [22] by adding an active
74 disturbance rejection control to the MPPT loop. A modified phasor extremum seeking control has also been
75 proposed in [23] as an MPPT tool for micro hydropower plants. This method has the advantage of fast convergence
76 to the extremum (or the peak power point) compared to previous algorithms.

77 All above methods try to find the MPP of hydraulic turbines in a short time and with the minimum stress on the
78 mechanical parts to extract the maximum power. But, as it is shown in this paper, the maximum attainable power of
79 the variable-speed hydropower system does not correspond to the MPP of hydraulic turbine. In other words, to
80 get the maximum power from the whole hydropower system, it is necessary to consider power losses of the
81 electric generator and power electronic interface between the turbine and the grid. In fact, these power losses can
82 change the power-speed characteristics or MPP of the hydropower system. Hence, to discriminate the MPP of the
83 hydraulic turbine from the MPP of the whole system, the term "optimum MPP" is used for the latter and is
84 investigated in detail in this paper.

85 According to literature review, some references such as [24-27] have mentioned the shift of MPP in wind
86 energy conversion systems. Reference [24] has considered a 20 KW wind turbine connected to a permanent
87 magnet synchronous generator (PMSG), where the stator terminals are connected to a diode rectifier and a 3-
88 phase voltage source inverter. This reference calculates PMSG losses with considering a constant flux density for
89 the machine (in all operating points) and evaluates the loss effect on the optimum MPP. The loss model, however,
90 is simple and it does not consider the converters losses and the effect of harmonic terms (caused by diode
91 rectifier) on machine losses. Reference [25] has used a similar topology as [24] but it replaces the synchronous
92 machine with an air-cored PMSG. It proposes an equivalent circuit for the loss calculation of air-cored PMSG. But,
93 same as [24], the converters losses are not considered and the loading effect on the flux density is not evaluated.
94 Reference [26] has presented a hybrid tracking algorithm to track the MPP efficiently. Using some experiments, it
95 shows that the MPP of whole system must be tracked instead of MPP of wind turbine to achieve higher efficiency.
96 This reference, however, does not provide any theoretical justification for its claim. The author of [27] has
97 proposed an interesting maximum efficiency point tracking method for a variable speed small hydropower plant
98 which employs two control loops: one as water level governor and one as an adaptive load controller to find the

99 optimal operation point of the system and to maximize the system efficiency. In [27], the generated active power
 100 at the grid side is used to find the optimum operating point and to maximize the total efficiency. But, there is no
 101 analysis about the effect of different loss terms on the optimum operating point of the system.

102 In this paper, due to lack of knowledge about the impact of internal system losses on the MPP of a variable-
 103 speed micro hydropower system, a complete theoretical analysis is presented for the calculation of different loss
 104 terms at various speeds. As a case study, a semi-Kaplan turbine coupled to a PM synchronous generator is
 105 considered. The micro-hydropower system is connected to the grid by a back-to-back power electronic unit and
 106 the variable-speed control is applied to the turbine. Different loss terms as a function of shaft speed are calculated
 107 and demonstrated to show their impacts on the MPP of total system. It is proved that the MPP of whole system
 108 does not correspond to the MPP of the hydraulic turbine. Also, a modified MPP tracking algorithm is proposed to
 109 extract the maximum power of the whole system. The experimental results are provided to verify the validity of
 110 analytical achievements.

112 2. Structure of micro-hydropower generation system

113 The studied hydropower generation system in this paper has three main parts: micro-hydropower turbine,
 114 synchronous generator, and power electronic unit between the generator and the grid which are explained in the
 115 following subsections.

117 2.1. Micro-Hydropower turbine

118 In this paper, a propeller (or semi-kaplan) turbine with fixed blades and fixed guide vanes is considered. This
 119 kind of turbine is a reaction turbo-machine and has a similar operating principle to standard wind turbines. As it is
 120 shown in Fig.1, the turbine is a vertical axis machine which is fed by a penstock linked usually to a reservoir which
 121 is supplied by an upstream canal. This configuration is suitable for run-of-river and low head power generation
 122 stations.

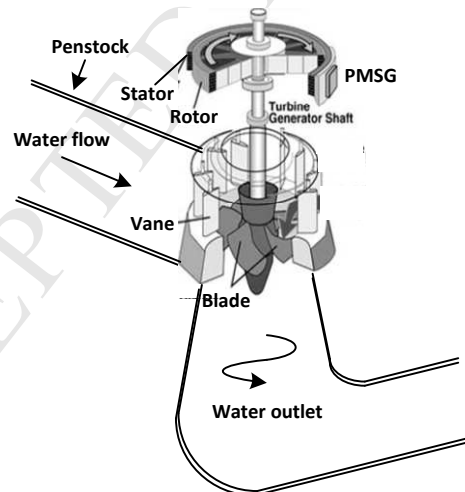

123
 124 Fig.1. Schematic of semi-Kaplan turbine with fixed guide vanes and fixed blades
 125

126 The turbine converts the available energy of the water to mechanical power. The available hydraulic power
 127 depends on the water flow rate (discharge) and water head which is given by [21]:

$$128 P_h = \rho g H Q \quad (1)$$

129 where ρ is the specific density of water (kg/m^3), g is the acceleration due to gravity (9.8 m/s^2), H is the net water
 130 head (m) and Q is the water flow rate (m^3/s). The extractable mechanical power P_T is related to the hydraulic
 power by the following equation:

$$P_T = \eta_h P_h = \eta_h \rho g H Q \quad (2)$$

131 being η_h the hydraulic turbine efficiency. Since the turbine will be operated over a wide range of rotor speeds, an
 132 accurate model which precisely reflects the behavior of hydraulic system at different operating conditions is
 133 needed [28]. The accurate models can be obtained from the so-called efficiency hill charts. These charts are usually
 134 given by manufactures or can be obtained by experimental tests on a scaled down system. The hill charts
 135 represent constant efficiency curves as a function of flow rate Q and rotational speed ω_m at different water heads
 136 H . For simplicity, it is possible to consider the water head fixed and to model the system in a 2D plane [21]. Then,
 137 to achieve the optimal operation, the control system should compensate the effect of water head variations in
 138 reality and looks for the MPP. This goal can be achieved by MPP tracking (MPPT) algorithms which are
 139 independent of system parameters and do not need water flow and water head sensors, such as P&O algorithm.

140 In this paper, the efficiency curves for the utilized semi-Kaplan turbine are modeled based on the approach in
 141 [21, 28]. According to [28], the efficiency curve of a fixed-head propeller (or semi-Kaplan) turbine at steady state
 142 condition can be modeled by the following formula:

$$\eta_h(\lambda, Q) = 0.5 \left[\left(\frac{90}{\lambda_i} + Q + 0.78 \right) e^{-\frac{50}{\lambda_i}} \right] (3.33Q) \quad (3)$$

$$\frac{1}{\lambda_i} = \left[\frac{1}{(\lambda + 0.089)} - 0.035 \right], \text{ and } \lambda = \frac{RA\omega_m}{Q}$$

143 where R is the radius of turbine (m), A is the area swept by the rotor blades (m^2), and ω_m is the shaft speed (rad/s).
 144 The validity of (3) has been verified in [28] by different experimental measurements and curve fittings. Again it is
 145 point out that (3) is valid for fixed-head propeller turbines and the effect of water head variations will be
 146 compensated by the control system.

147 Fig.2 demonstrates the steady-state power-speed curves according to (2) and (3) for a turbine with a fixed head
 148 of $H=1m$ and the radius of $R=0.27m$. These curves are illustrated at different water flow rates and corresponding to
 149 each curve there is a unique MPP. The existing control techniques try to track these MPPs when the water flow
 150 rate or water head changes [28].

151
152
153

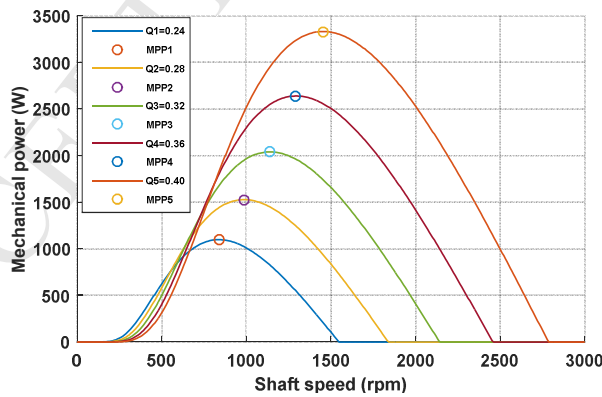

154 Fig.2. Semi-Kaplan turbine power-speed curves at different water flow rates and fixed head of $H=1m$
 155
156
157

158 2.2. Drive train and power electronic interface

159 As it is seen in Fig.1, the turbine shaft is connected to the generator shaft with a rigid coupling. Then, with the
 160 turning of hydraulic turbine, the mechanical power is generated and the mechanical torque is transferred to the
 161 generator shaft. Hence, the turbine torque can be given by

$$T_T = \frac{P_T}{\omega_m} = \frac{\eta_h P_h}{\omega_m} \quad (4)$$

162 On the other side, the synchronous generator generates the electromagnetic torque T_{em} and the motion
163 equation can be written as [29]

$$T_T - T_{em} = J \frac{d\omega_m}{dt} + B\omega_m \quad (5)$$

164 where J is the total moment inertia of the turbine-generator coupling and B represents the rotational viscous
165 coefficient.

166 The block diagram of power electronic interface is illustrated in Fig.3. As it is seen, a back-to-back full converter
167 is employed and the generated electric power is transferred via it. In this structure, the machine side converter is
168 responsible for the speed control of hydraulic turbine and the grid side converter regulates the dc bus voltage and
169 controls the injected currents to the grid.
170

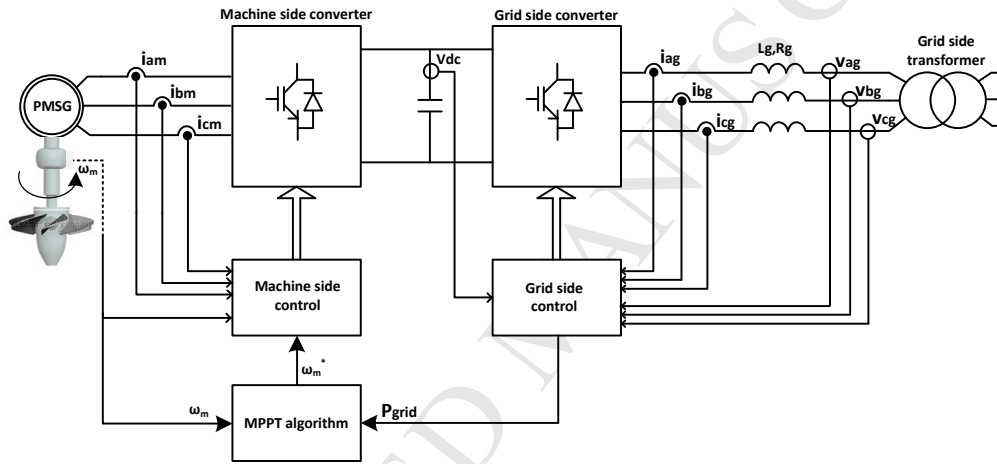

171
172 Fig.3. Block diagram of the micro hydro-power system and power electronic interface
173

174 2.3. Control of machine side and grid side converters

175 The machine side converter is controlled by the vector control theory. This theory is widely used in the control
176 of electrical machines and three-phase power electronic systems [29]. In this analysis, the three-phase variables
177 are converted to vectors with orthogonal d-q axis terms in a synchronous rotating d-q axis system and
178 consequently reduce the system order and simplify the calculations. In the following, the vector control of PMSM
179 is obtained by fixing the rotor magnet axis (λ_m) to the direct axis (d-axis) of stator winding. In other words, the
180 rotor flux is assumed to be concentrated along the stator d-axis while there is zero flux along the q-axis. Moreover,
181 the rotor reference frame is considered for modeling which means that the equivalent d- and q-axis stator
182 windings are transformed to the reference frame that is revolving at rotor speed ω_r . Using these assumptions, the
183 stator d- and q-axis voltage equations and the torque equation can be written as [29]:

$$\begin{cases} u_d = (R_s i_d + L_d \frac{di_d}{dt}) - \omega_r L_q i_q \\ u_q = (R_s i_q + L_q \frac{di_q}{dt}) + \omega_r L_d i_d + \omega_r \lambda_m \end{cases} \quad (6)$$

$$T_{em} = \frac{3}{2} P_n (\lambda_m i_q + (L_d - L_q) i_d i_q) \quad (7)$$

184 where (U_d, U_q) and (i_d, i_q) represent stator voltage and current variables in d-q axis system, L_d and L_q are called d-
 185 and q-axis inductances, respectively. P_n is the number of pole pairs, T_{em} is the electromagnetic torque, and ω_r is the
 186 electrical rotor speed and is equal to $P_n\omega_m$. In this paper, $i_d=0$ control is employed to achieve a linear relation
 187 between the electromagnetic torque and the q-axis current. The reference of q-axis current i_q^* will be defined by
 188 the speed regulator, where the speed reference is determined by the upstream MPPT controller.

189 The function of grid side controller is to control the dc bus voltage and to control the injected current to the
 190 grid. Using a 3-phase PLL, the phase of grid voltage is determined and a current with the desired power factor (in
 191 this paper, unity power factor) is injected.

192

193 3. Calculation of different loss terms

194 In this part, different loss terms, including the mechanical loss, the generator loss, converters losses and the
 195 filter loss are calculated at steady state condition. The final goal is to obtain the loss terms at different operating
 196 points of the turbine. In other words, similar to power-speed curves in Fig.2, the power loss curves will be
 197 calculated in "n" distinct operating points (or speeds). In this paper, the "kth" operating point (or speed) is defined
 198 by:

$$\omega_{m,k} = \omega_{m,k-1} + \Delta\omega_m, \quad k = 1, 2, \dots, n \quad (8)$$

199 where, $\Delta\omega_m$ is a fixed value, e.g., 1 rad/s, and determines the amount of speed change in each step. In the provided
 200 algorithm for power loss calculations, the operating speed will be increased from zero to the maximum value and
 201 the generator phase current ($|I_s|$, where $|I_s| = |i_{q,k}|$) and the grid phase current ($I_{g,k}$) will be calculated to estimate
 202 the loss terms. Noting to (5), (7), and neglecting the friction losses, one can obtain the generator q-axis current at
 203 steady-state as:

$$i_{q,k} = \frac{T_{em}}{1.5P_n\lambda_m} \cong \frac{T_T}{1.5P_n\lambda_m} \cong \frac{P_{T,k}}{1.5P_n\lambda_m\omega_{m,k}} \quad (9)$$

204 where, $i_{q,k}$ represents the stator q-axis current at $\omega_{m,k}$ and $P_{T,k}$ is the corresponding turbine power at $\omega_{m,k}$. (9) is
 205 valid for $i_d=0$ control and also for the case that synchronous generators with surface mounted permanent magnets
 206 are utilized. For calculation of the grid phase current, first the injected power to the grid is determined by

$$P_{grid,k} = P_{T,k} - P_{Loss,k} \quad (10)$$

207 where, $P_{Loss,k}$ represents the total system losses at $\omega_{m,k}$. Since the loss curve is a continues function of speed, it is
 208 possible to approximate the power loss term at $\omega_{m,k}$ with the total loss term at $\omega_{m,k-1}$ (which is known from the
 209 previous iteration of the proposed loss calculation algorithm in Fig.4) if the step size $\Delta\omega_m$ is small enough. So, (10)
 210 can be rewritten as

$$P_{grid,k} \approx P_{T,k} - P_{Loss,k-1} \quad (11)$$

211

212 In the following parts, the procedure of power loss calculation is explained in detail. Assuming that the grid side
 213 voltage is balanced and the injected current to the grid is sinusoidal with unity power factor, the rms of injected
 214 current to the grid is obtained as

$$I_{g,k} = \frac{P_{grid,k}}{3V_g} = \frac{P_{T,k} - P_{Loss,k-1}}{3V_g} \quad (12)$$

215 where $I_{g,k}$ is the rms value of phase current at $\omega_{m,k}$ and V_g represents the rms value of grid voltage. In the following
 216 subsections, different loss terms are calculated based on the estimated current variables in (9) and (12).

217

218 3.1. PM generator losses

219 The losses in a PMSG include winding loss, core loss and permanent magnet loss, where the permanent magnet
 220 loss is neglected because the air gap field usually rotates in synchronous with the rotor, and the magnets do not

221 experience a time varying field [30]. Winding loss is related to internal resistances of stator windings and can be
 222 determined by

$$P_{W,k} = \frac{3}{2} R_s |I_s|^2 = \frac{3}{2} R_s (i_{d,k}^2 + i_{q,k}^2) = \frac{3}{2} R_s |i_{q,k}|^2 \quad (13)$$

223 where, $|I_s|$ is the amplitude of stator phase current and R_s is the equivalent resistance of one phase and depends
 224 on winding temperature. Moreover, due to skin effect, the ac current which passes through the winding will see a
 225 lower conductor area and a greater resistance. Considering both temperature and skin effect, R_s can be estimated
 226 by

$$R_s = R_{dc} (1 + \alpha(T - 20)) \cdot (1 + y_s) \quad (14)$$

227 where, R_{dc} is the winding dc resistance at 20°C, α is the temperature coefficient of resistance for copper
 228 ($\alpha=0.004041$), T is the temperature of winding at operating condition, and y_s is the skin effect factor and can be
 229 determined according to the procedure explained in IEC 60287-1-1 standard [31].

230 Core loss estimation can be performed by empirical models such as Steinmetz-Model or more physical based
 231 models such as the Berotti-Model which shows the total core losses as a combination of hysteresis, eddy current,
 232 and excess losses, i.e.,

$$P_{core} = (k_h f B^h + k_{ed} f^2 B^2 + k_{ex} f^{1.5} B^{1.5}) \cdot W_{core} \quad (15)$$

233 where f is the magnetization frequency, B is the peak value of the magnetic flux density, W_{core} represents the core
 234 weight, and the rest parameters are material specific parameters which can be identified either by referring to
 235 lamination material datasheet or doing some measurements and using polynomial curve fitting [32]. It is worth
 236 mentioning that the average flux density is not equal in different parts of the stator. So one may use the finite
 237 element model (FEM) tool to obtain the average flux density at different parts of the stator and to apply (15) for
 238 power loss calculation at each part [33]. Some other references have proposed a method for estimation of average
 239 flux density at the stator tooth and yoke, i.e., B_t and B_j , according to the dimensional and design parameters of the
 240 machine and eliminated the necessity for FEM tool [34]. The average flux density in the tooth and yoke can be
 241 derived from d- and q-axis flux linkages as [34]

$$B_{td,q} = \frac{\lambda_{d,q}}{S_{tc}} \rightarrow B_t = \sqrt{B_{td}^2 + B_{tq}^2} \quad (16)$$

$$B_{jd,q} = \frac{\lambda_{d,q}}{S_{jc}} \rightarrow B_j = \sqrt{B_{jd}^2 + B_{jq}^2} \quad (17)$$

242 Where, S_{tc} and S_{jc} represent the equivalent areas of stator tooth and stator yoke, respectively. The procedure of
 243 finding the equivalent S_{tc} and S_{jc} have been explained in [34]. In addition, flux linkages can be calculated as

$$\begin{cases} \lambda_d = L_d i_{d,k} + \lambda_m \\ \lambda_q = L_q i_{q,k} \end{cases} \quad (18)$$

244 Then, the total machine losses at the shaft speed $\omega_{m,k}$ can be written as

$$P_{mach,k} = P_{W,k} + P_{core,k} \quad (19)$$

245

246 3.2. Mechanical loss

247 Mechanical loss has different terms, including coupling, bearing and windage loss. Coupling loss is related to
 248 the loss of mechanical coupling between the turbine and generator shaft. Bearing loss is a mechanical friction
 249 between the rotor and the bearing and the windage loss is related to the friction between the rotor and the air.
 250 The expression of total mechanical loss at the operating speed $\omega_{m,k}$ can be given by [35]:

$$P_{mech,k} = k_b \omega_{m,k} + k_w \omega_{m,k}^2 \quad (20)$$

251 where, k_b and k_w are loss parameters which depend on the rotor weight, length, shape, and shaft diameter. To
 252 determine these two parameters, one can apply a no load test on the set of turbine and generator and then to
 253 measure the power loss as a function of speed. The obtained loss-speed curve under no load condition is a sum of
 254 core loss and mechanical loss [36]. Then, the value of core loss can be calculated from (15) and subtracted from
 255 the total loss. The obtained curve can be fitted to the formula of (20), and therefore, the mechanical loss
 256 parameters, i.e., k_b and k_w are determined.

257

258 3.3. Machine side converter loss

259 Machine side converter is a three phase voltage source converter which is utilized for control of turbine speed.
 260 In fact, the employed controllers for the control of i_d and i_q will generate the stator d- and q-axis voltages. Then,
 261 the PWM modulator will synthesize the abc voltages from dq components.

262 The loss terms in the machine side converter include conduction and switching losses of the power switches
 263 and diodes. Reference [37] explains the mechanism of power loss calculation in a voltage source inverter and a
 264 similar method with some modifications is utilized in this paper. According to [37], the average conduction losses
 265 for a power switch $P_{con,s}$ and a diode $P_{con,d}$ in a period can be estimated by,

$$P_{con,s} = \left(\frac{1}{8} + \frac{M}{3\pi}\right)r_{ce} |I_s|^2 + \left(\frac{1}{2\pi} + \frac{M}{8} \cos \theta\right)V_{ceo} |I_s| \quad (21)$$

$$P_{con,d} = \left(\frac{1}{8} - \frac{M}{3\pi}\right)r_d |I_s|^2 + \left(\frac{1}{2\pi} - \frac{M}{8} \cos \theta\right)V_{Fo} |I_s| \quad (22)$$

266

267 In (21) and (22), the i-v characteristics of the switch and diode have been approximated by linear equations of
 268 $V_{ce} = V_{ceo} + r_{ce} I_c$ and $V_d = V_{Fo} + r_d I_c$. Moreover, $|I_s|$ is the amplitude of stator current (or generator phase current)
 269 and is obtained from $|I_s| = \sqrt{i_{d,k}^2 + i_{q,k}^2}$. θ is the phase difference between stator current and voltage, i.e.,
 270 $\theta = \angle(u_d + j u_q) - \angle(i_d + j i_q)$ and M represents the modulation index of the converter, which is approximated by

$$M_1 = (2\sqrt{u_d^2 + u_q^2})/V_{dc} \quad (23)$$

271 where subscript 1 is used for the machine side converter and the variables u_d and u_q are determined from (6). In all
 272 above equations, the calculations are done at steady-state condition and the derivative terms are set to zero.

273 Switching energy losses of power switches (IGBTs in this paper) contain turn-on and turn-off losses, i.e.,
 274 $E_{sw} = E_{on} + E_{off}$, and for the diodes is equal to reverse recovery losses, i.e., $E_{sw} = E_{rr}$. The semiconductor manufacturers
 275 usually give the curves of turn-on, turn-off and reverse recovery losses as a function of current at a specific
 276 operating voltage and junction temperature. For each of these terms, the corresponding curve can be
 277 approximated by a second order polynomial. For example, E_{on} curve can be approximated by

$$E_{on} = a_1 I_c^2 + a_2 I_c + a_3 \quad (24)$$

278 where, I_c is the device current at the switching instant, and a_1 , a_2 , and a_3 are coefficients of second order
 279 polynomial and are obtained from curve fitting procedure. The dependency of switching energy on the supply
 280 voltage V_{cc} and chip temperature can also be considered by

$$E_{sw} = E_{swref} \cdot \left(\frac{V_{cc}}{V_{ccref}}\right)^{K_v} \cdot (1 + TC_{sw} (T_j - T_{jref})) \quad (25)$$

281 Where K_v is the exponent of voltage dependency (IGBT ~1.2...1.4; Diode ~0.6) and TC_{sw} is temperature coefficient of
 282 switching losses (IGBT ~0.003; Diode ~ 0.005 ...0.006) [38]. In (25), the subscript *ref* is related to nominal test
 283 conditions which are known in the device datasheet. Noting to (24), (25) and assuming that the machine current is
 284 sinusoidal, i.e., $I_s = |I_s| \sin \alpha$, the corresponding average turn-on loss term in a fundamental cycle can be obtained as

$$E_{on(av)} = \frac{1}{2\pi} \int_0^{\pi} E_{on} d\alpha = \left(\frac{a_1 |I_s|^2}{4} + \frac{a_2 |I_s|}{\pi} + \frac{a_3}{2} \right) \cdot \left(\frac{V_{cc}}{V_{ccref}} \right)^{K_v} \times (1 + TC_{sw} (T_j - T_{jref})) \quad (26)$$

285 Also, for calculation of turn-off and reverser recovery losses, a similar method can be employed. Considering all
286 loss terms, the total machine side converter loss $P_{c1,k}$ at $\omega_{m,k}$ can be given by

$$P_{c1,k} = 6 \cdot (P_{con,s} + P_{con,d} + f_1 \cdot (E_{on} + E_{off} + E_{rr})) \quad (27)$$

287 where, f_1 represents the switching frequency of the machine side converter.

288 3.4. Grid side converter loss

289 Calculation of power loss in the grid side inverter is similar to the machine side converter and the same
290 formulas are applied. In this case, the phase current is estimated by (12) and the modulation index for the grid side
291 converter is determined by

$$M_2 = (2\sqrt{2} \sqrt{(V_g + R_f I_{g,k})^2 + (L_f \omega I_{g,k})^2}) / V_{dc} \quad (28)$$

292 where, R_f and L_f represent the resistance and inductance value of grid side filter. The rest procedure for loss
293 calculation is same as subsection 3.3. So the total grid side converter loss $P_{c2,k}$ at operating speed $\omega_{m,k}$ is expressed
294 by

$$P_{c2,k} = 6 \cdot (P_{con,s} + P_{con,d} + f_2 \cdot (E_{on} + E_{off} + E_{rr})) \quad (29)$$

295 where, f_2 represents the switching frequency of the grid side converter.

296 3.5. Grid side filter loss

297 At the grid side, an inductive filter is utilized to filter the ac current and to keep the harmonic current lower
298 than standard limits. This filter will lead to some copper and core losses which should be accounted in the total
299 loss calculation. The copper loss can be obtained from (13) by knowing the filter resistance and the correction of
300 resistance value from (14). Moreover, the core loss can be estimated by (15) with knowing the core material and
301 thickness of utilized laminations in the inductors. So, the total loss of the filter $P_{filter,k}$ at operating speed $\omega_{m,k}$ can
302 be given by

$$P_{filter,k} = 3R_f I_{g,k}^2 + P_{core_filt,k} \quad (30)$$

303

304 4. Evaluation of loss effect on the MPP of hydropower system

305 The given flowchart in Fig.4 shows the procedure for calculation of different loss terms in a variable-speed
306 hydropower system. Here, it is assumed that the water flow rate and water head are constant and the turbine
307 torque is calculated from (4). In the proposed flowchart, the shaft speed is increased from zero to the maximum
308 value (according to (8)) and the corresponding generator phase current and the grid phase current are estimated
309 from (9) and (12). Then, based on equations (13) to (30), different loss terms are calculated at the operating speed
310 $\omega_{m,k}$. The total loss of the hydropower system is then determined by

$$P_{loss,k} = P_{mach,k} + P_{mech,k} + P_{c1,k} + P_{c2,k} + P_{filter,k} \quad (31)$$

311 After calculation of different loss terms at $\omega_{m,k}$ and verifying that the maximum speed has not reached, the
312 temperature variables are estimated and the temperature dependent parameters are updated. Then, the above
313 procedure is repeated for the next operating point (or shaft speed).

314 Using the proposed flowchart in Fig.4, one can obtain the curves of turbine power and injected power to the
315 grid (as a function of shaft speed) and then evaluate the impact of different loss terms on the MPP of hydropower
316 system. For example, for a 5-kW micro-hydropower system with the parameters given in Table I, the above
317 procedure is performed and the corresponding curves, including the turbine power, total system loss, and the
318 injected power to the grid are derived and shown in Fig.5. It is worth mentioning that the variation of temperature
319 variables in Fig.5 has been ignored.

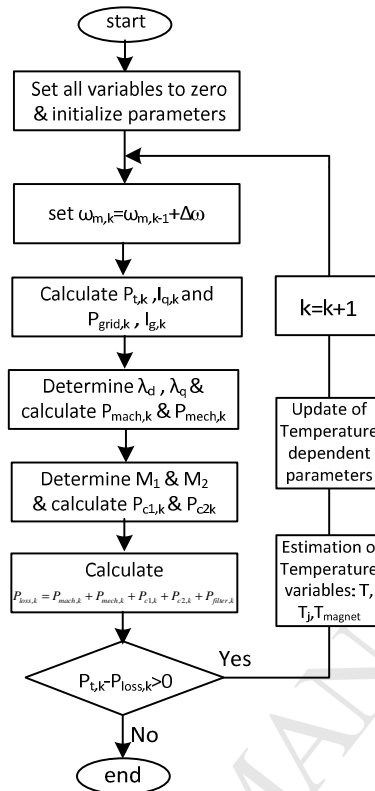

Fig.4. Flowchart of power loss estimation in the micro hydro-power system

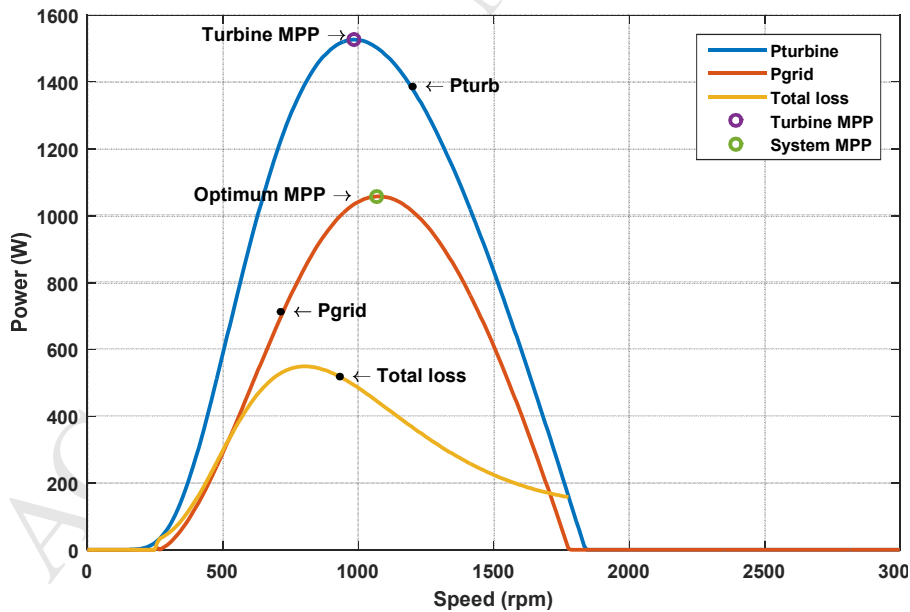

Fig.5. Calculated turbine power, injected power to the grid, and total system loss at $Q=0.28 \text{ m}^3/\text{s}$ and $H=1 \text{ m}$

From Fig.5, one can see that the MPP of whole hydropower system is shifted to the right when it is compared to the MPP of the hydraulic turbine. For instance, at $Q=0.28 \text{ m}^3/\text{s}$, the MPP location is shifted from 983 to 1069 rpm. In addition, the injected power to the grid increases from 1033 to 1057 W, when the new MPP is considered. Other important variables at the MPPs of Fig.5 are given in Table I.

329 Table I. Values of important variables at the “Turbine MPP” and the “optimum MPP” (H=1 m and Q=0.28 m³/s)

	Turbine MPP	Optimum MPP
Turbine power (W)	1526	1500
Injected power to grid (W)	1033	1057
Mechanical speed (rpm)	983	1069
Turbine torque (N.m)	14.8	13.4

330

331 Fig.6 shows the loss distribution among different components of the hydropower system at Q=0.28 m³/s and
 332 H=1 m. According to Fig.6, the PMSG and the machine side converter have the highest impact on the total loss. In
 333 addition, the maximum loss in the PMSG and the machine side converter correspond to the point of maximum
 334 torque, where the stator current has the greatest value. On the other side, the maximum loss in the grid side
 335 converter corresponds to the point of optimum MPP, where the injected current to the grid has the maximum
 336 value. It is worth noting that the grid side filter has negligible losses and is not demonstrated in Fig.6.

337

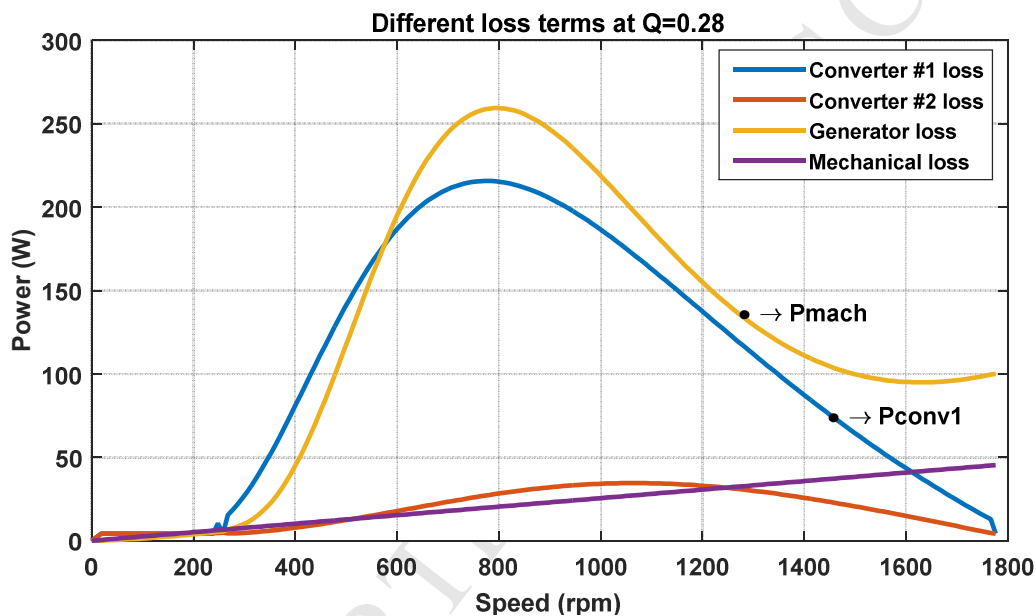

338

339 Fig.6. Different loss terms of the micro hydro-power system at Q=0.28 m³/s and H=1 m

340

341 5. Experimental Verification

342 To verify the validity and accuracy of obtained results in Section 3 and 4, some real-time simulations are carried
 343 out on a 5-kW hardware prototype with the parameters given in Table II. In the experimental investigations, a dc
 344 machine is utilized to emulate the behavior of micro hydro turbine (Fig.7.a) by a closed loop control on the
 345 armature current.

346 For the control and emulation of hydropower system, the D-SPACE system is employed which allows the real-
 347 time simulation and rapid prototyping [39]. Using this facility, all the control system can be designed in
 348 Matlab/Simulink environment and the variables can be watched and adjusted during real-time simulations. For
 349 measuring the shaft speed and electrical angle, an incremental encoder has been employed on the machine shaft.
 350 In addition, the power electronic interface is selected same as the one in Fig.3 and vector control is employed for
 351 the control of machine side and grid side converters.

352

353

354

355

Table II. Parameters of the micro-hydropower system utilized in analytical and experimental verifications

Turbine	Type		Semi-Kaplan	
	Radius of turbine		R	0.271 m
	Area swept by turbine blades		A	0.23 m ²
	Water head		H	1 m
PMSG	Number of pole pairs		P_n	4
	Stator phase resistance		$R_{s,dc}$	0.1 Ω
	d-axis inductance		L_d	0.85 mH
	q-axis inductance		L_q	0.95 mH
	Magnet flux		λ_m	0.1 Wb
	Core loss parameters	Hysteresis	K_h	$1.526e^{-5}$
		Eddy current	K_{ed}	$8.5067e^{-7}$
Excess		k_{ex}	0.003	
Weight		W_{core}	15 Kg	
Turbine+PMSG parameters	Bearing	k_b	0.2437	
	Windage	K_w	$1.22e^{-6}$	
	Moment of inertia	J	0.0048 Kg.m ²	
Power electronic interface	Dc bus voltage		V_{dc}	400 V
	Dc link capacitor		C_{dc}	2.2 mF
	Output filter inductance		L_f	7 mH
	Output filter resistance		$R_{f,dc}$	65 m Ω
	Phase rms voltage		V_a	137 V
	Switching frequency		f_{sw}	10 kHz
	Power switch type		SKM 50 GB 123 D	
	Switch conduction loss parameters		r_{ce}	28 m Ω
			V_{ceo}	1.7 V
	Diode conduction loss parameters		r_d	22 m Ω
			V_{fo}	1.2 V
	Switch turn on loss parameters E_{on}		a_1	0.0004747
			a_2	0.1518
			a_3	0.1197
	Switch turn off loss parameters E_{off}		a_1	-0.0007585
			a_2	0.1429
			a_3	0.1249
	Diode reverse recovery loss parameters E_{rr}		a_1	-0.0005622
			a_2	0.07038
			a_3	-0.003097

356

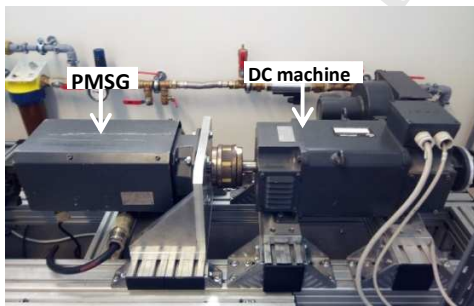

(a)

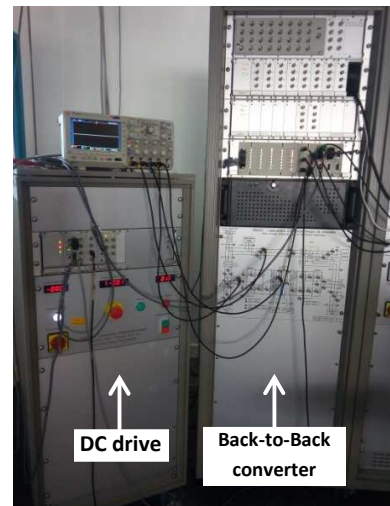

(b)

357

Fig.7.Utilized test-bench for emulation of hydropower system, (a) dc machine and PMSG coupling, (b) dc drive

358

and back-to-back full converter system

5.1. Evaluation of loss model and the MPP location

To compare the data of analytical model and the experimental results, the experimental data is extracted for a similar operating condition as the analytical model. To do this, the rotor speed is increased from zero to the maximum value and the corresponding turbine torque (based on already defined power-speed curves in Fig.2) is generated by the dc machine and transferred to PMSG. Then, the corresponding turbine power $P_{\text{turb-exp}}$ and the injected power to the grid $P_{\text{grid-exp}}$ are measured at different operating speeds.

The corresponding data from calculation model and experiments for water flows $Q=0.28$ and $Q=0.36$ m^3/s have been derived and demonstrated in Fig.8.a and 8.b, respectively. In these figures, the data of calculation model are shown by solid lines and the experimental data are shown by “+” symbol.

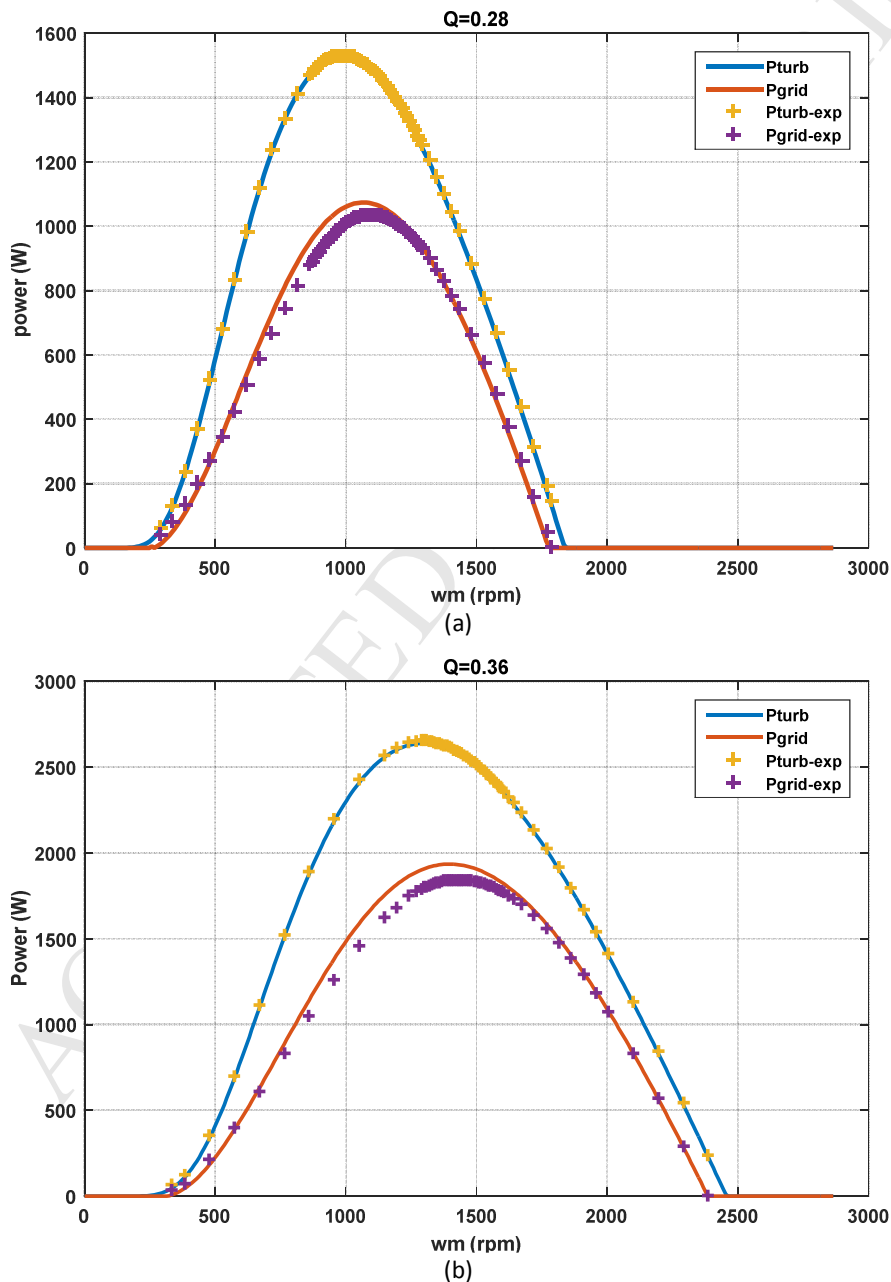

Fig.8. Turbine power and injected power to the grid based on calculation model (P_{turb} , P_{grid}) and the experimental measurements ($P_{\text{turb-exp}}$, $P_{\text{grid-exp}}$) at: (a) $Q=0.28$ m^3/s , (b) $Q=0.36$ m^3/s

369 To verify the error between the analytical model and the experimental results, the percent error formula in (32)
 370 is utilized:

$$\% \text{ Error} = \left| \frac{X_{\text{experimental}} - X_{\text{model}}}{X_{\text{model}}} \right| \times 100 \quad (32)$$

371 Using (32), one can calculate the percent error between a theoretical variable (data of model) and measured value
 372 in practice. According to (32), the percent error of turbine output power P_{turb} as a function of shaft speed has been
 373 calculated and demonstrated in Fig.9.a and Fig.9.b for water flows $Q=0.28$ and $Q=0.36 \text{ m}^3/\text{s}$, respectively.

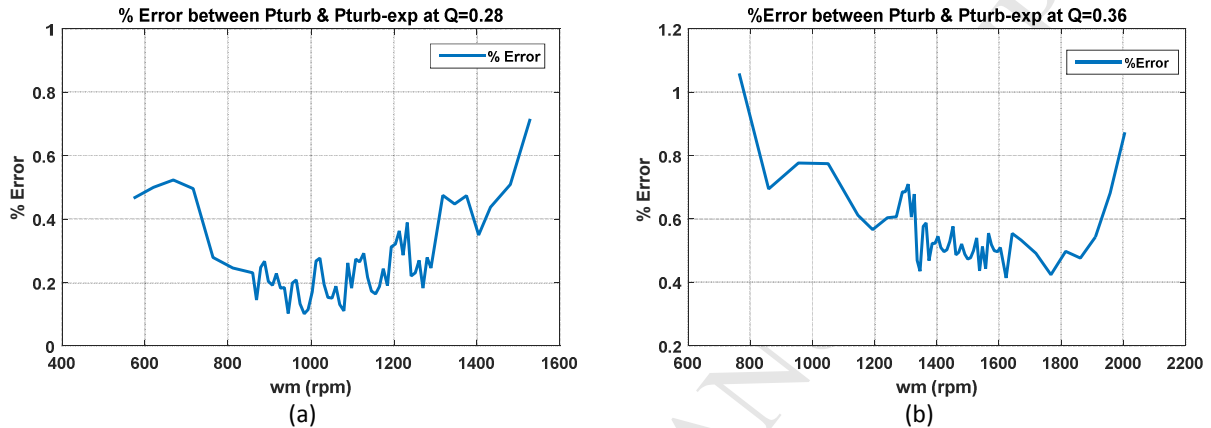

Fig.9. Percent error of the turbine output power P_{turb} and $P_{\text{turb-exp}}$ as a function of shaft speed at (a) $Q=0.28$, (b) $Q=0.36 \text{ m}^3/\text{s}$

374 As it is seen from Fig.9.a and Fig.9.b, the error is less than 1% in a wide range of operating speeds. Hence, it is
 375 concluded that there is a good agreement between the P_{turb} curve and the measured one $P_{\text{turb-exp}}$ which confirms
 376 the correct modeling of the hydro turbine in practice. Hence, in continue, one can trust on the measured data for
 377 the injected power to the grid (or $P_{\text{grid-exp}}$) and compare it with the theoretical one.

378 The comparison between the theoretical P_{grid} curve and the measured data $P_{\text{grid-exp}}$ confirms that the presented
 379 loss modeling in sections 3 and 4 is in good agreement with the experimental results. The very small difference
 380 around the peak power point (left side of MPP) is because of neglecting the variation of temperature variables in
 381 the power loss calculations. Same as theoretical results, it is evident that the MPP of whole system does not
 382 correspond to the MPP of hydraulic turbine. This result confirms that for obtaining the maximum power of the
 383 hydropower system, one has to track the MPP of whole system instead of turbine MPP.

385

386 5.2. Modified P&O tracking algorithm

387 In practice, to find the "optimum MPP" of the hydropower system, one can employ the standard P&O
 388 algorithm with some modifications. Fig.10.a and 10.b show the block diagram of standard P&O algorithm and the
 389 modified algorithm in this paper, respectively. As it is seen from Fig.10.a, in the conventional P&O, the shaft speed
 390 is perturbed and the turbine power is observed, while in the modified P&O in Fig.10.b, the shaft speed is perturbed
 391 and the injected power to the grid is observed. This technique is very simple and just needs a sensor for measuring
 392 the shaft speed. Moreover, the value of "injected power to the grid" P_{grid} is estimated from the existing data for
 393 the grid side controller and no extra sensor is needed.

394 One should note that in Fig.10, the variable "step" is the amount of speed change in each iteration of
 395 algorithm. In this paper, the value of "step" changes as a function of $|\Delta P/\Delta \omega|$. This strategy helps reducing the
 396 mechanical perturbations, especially at steady-state.

397

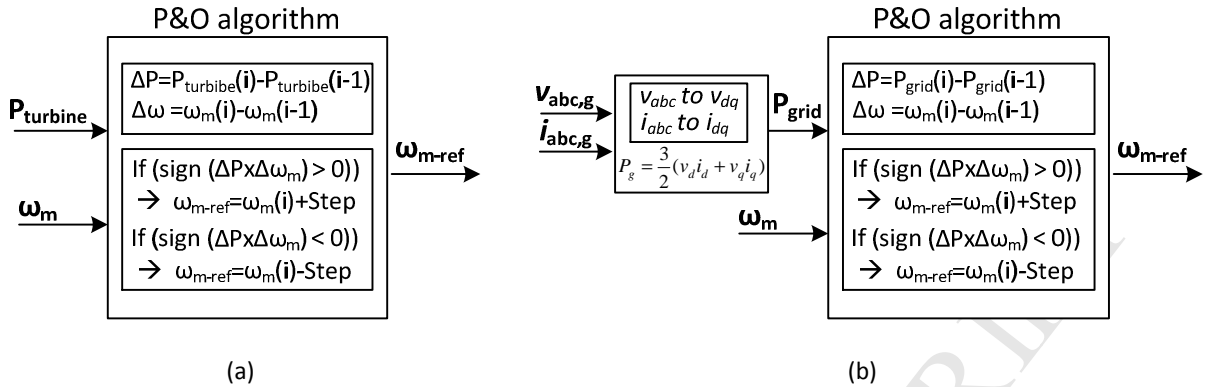

Fig.10 Block diagram of P&O algorithm, (a) Conventional approach, (b) Proposed approach

398

399 For finding the “optimum MPP” in Fig.10.b, there is no need to perform analytical calculations presented in
 400 sections 3 and 4. The modified P&O tracking algorithm can find the “optimum MPP” automatically and without the
 401 analytical calculations.

402 The following experiment verifies the behavior of proposed P&O algorithm. In this investigation, first the
 403 conventional P&O algorithm (which tracks the MPP of hydraulic turbine) is applied and then the modified P&O
 404 algorithm (which tracks the MPP of whole system) is applied. The obtained result for the condition of $Q=0.28 \text{ m}^3/\text{s}$
 405 and $H=1\text{m}$ is shown in Fig.11.

406

407

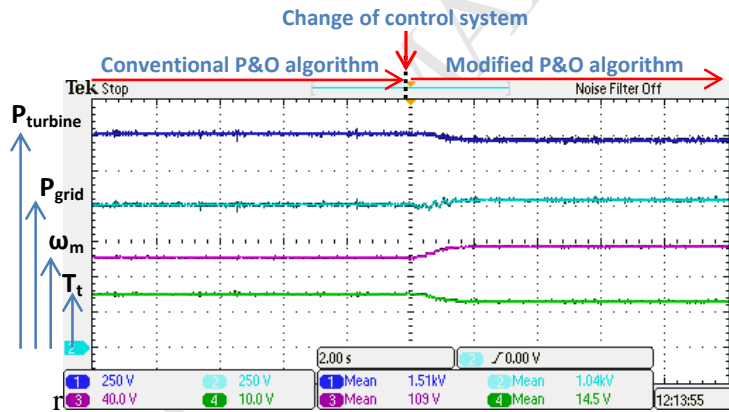

408

Fig.11. Waveforms of turbine power, output power, shaft speed, and turbine torque with the conventional P&O
 algorithm (left half side) and with the modified P&O algorithm (right half side)

411

412 Fig.11 shows the turbine power, injected power to the grid, mechanical speed (rad/s), and turbine torque from
 413 top to bottom, respectively. The obtained steady-state data around the MPP for the conventional P&O and the
 414 modified P&O algorithm are given in Table III.

415

416 Table III. Comparison of the conventional P&O and the modified P&O around the MPP based on experiments (at
 417 $Q=0.28 \text{ m}^3/\text{s}$ and $H=1 \text{ m}$)

	Conventional P&O	Modified P&O
Turbine power (W)	1530	1480
Injected power to grid (W)	993	1030
Mechanical speed (rpm)	978	1086
Turbine torque (N.m)	14.9	13.2

418

419 From Fig.11 and the given results in Table III, it is seen that after applying the modified P&O algorithm, the
 420 turbine output power reduces 2.6% while the injected power to the grid increases 3.7%. Moreover, the mechanical
 421 speed changes from 978 to 1086 rpm and the turbine torque reduces from 14.9 to 13.2 N.m at $Q=0.28 \text{ m}^3/\text{s}$. It is
 422 evident that the proposed P&O algorithm moves the operating point from the “turbine MPP” to the “optimum
 423 MPP” and consequently more electric power is injected to the grid. This result confirms the validity of proposed
 424 P&O algorithm and also the change of optimum operating point due to the system losses. Moreover, with the
 425 change of operating point, the generator loss and the converter loss reduces and the cooling condition becomes
 426 easier. Hence, the life time of system will improve due to lower losses and temperature stress on the system
 427 components.

428

429 6. Conclusions

430 In this paper, a propeller (or semi-Kaplan) turbine with fixed blades and fixed guide vanes was considered for
 431 the study. Then, it was shown that the maximum power point (MPP) of the variable-speed micro hydropower
 432 system does not correspond to the MPP of the hydraulic turbine. In fact, the mechanical and electrical losses of the
 433 drive train, PMSG and power electronic unit between the turbine and the grid, can change the location of
 434 “optimum MPP” in the hydropower system. In the studied example in this paper, the corresponding speed at the
 435 turbine MPP was 978 rpm while it changed to 1086 rpm at the “optimum MPP”. Moreover, it was shown that the
 436 conventional MPP tracking approaches which track the MPP of hydropower turbine cannot find the “optimum
 437 MPP” and extract the maximum power. To solve this problem, a modified P&O tracking algorithm was proposed in
 438 which the shaft speed was perturbed and the injected power to the grid was observed. This technique is very
 439 simple and just needs a sensor for measuring the shaft speed. Finally, the theoretical results were verified by
 440 experiments on a 5 kW hardware prototype and according to obtained results, the injected power to the grid can
 441 increase several percent when the modified P&O algorithm is employed. For example, in the studied example, the
 442 injected power to the grid increases 3.7% when the modified algorithm is applied. The proposed algorithm does
 443 not depend on system parameters and can find the “optimum MPP” in a simple way.

444

445 7. Prospective study

446 The prospective study will focus on following two objectives:

- 447 - Investigate the modelling approach for micro hydraulic turbines to reflect precisely the turbines physical
- 448 characteristics
- 449 - Investigate the variations of temperature variables in the flowchart of power loss model

450

451 Acknowledgment

452 This work has been funded by PSPC Innov’hydro project, which specifically brings together GE Renewable, EDF
 453 (Electricity of France), Grenoble INP and other key players in the hydroelectric sector, in France.

454

455

456 References

- 457 [1] Balkhair KS, Rahman KU. Sustainable and economical small-scale and low-head hydropower generation: a
 458 promising alternative potential solution for energy generation at local and regional sale. *Appl Energy* 2017;
 459 188: 378-91.
- 460 [2] Yang W, Norrlund P, Bladh J, Yang J, Lundin U. Hydraulic damping mechanism of low frequency oscillation in
 461 power systems: quantitative analysis using a nonlinear model of hydropower plants. *Appl Energy* 2018; 212:
 462 1138-52.
- 463 [3] Nababan S, Muljadi E, Blaabjerg F. An overview of power topologies for micro-hydro turbines. In international symposium
 464 on power electronics for distributed generation systems, 2012 PEDG. IEEE; 2012. p. 737-44.
- 465 [4] Gaudard L, Avanzi F, Michele CD. Seasonal aspects of the energy-water nexus: the case of a run-of-the-river
 466 hydropower plant. *Appl Energy* 2018; 210: 604-12.

- 467 [5] Joseph A, Chelliah TR. A review of power electronic converters for variable speed pumped storage plants:
 468 configurations, operational challenges, and future scopes. *IEEE J Emerg Sel Top Power Electron* 2018; 6: 103-
 469 19.
- 470 [6] Tan L, Zhu B, Cao S, Wang Y, Wang B. Numerical simulation of unsteady cavitation flow in a centrifugal
 471 pump at off-design conditions. *Proc. Inst. Mech. Eng. Part C J. Mech. Eng. Sci.* 2014, 228: 1994– 2006.
- 472 [7] Liu Y, Tan L, Hao Y, Xu Y. Energy Performance and Flow Patterns of a Mixed- Flow Pump with Different Tip
 473 Clearance Sizes. *Energies* 2017, 10: 1-15.
- 474 [8] Tan L, Yu Z, Xu Y, Liu Y, Cao S. Role of blade rotational angle on energy performance and pressure fluctuation
 475 of a mixed-flow pump. *Proc. Inst. Mech. Eng. Part A J. Power and Energy.* 2017, 231: 227-238.
- 476 [9] Trivedi C, Agnalt E, Dahlhaug O. Experimental study of a Francis turbine under variable-speed and discharge conditions,
 477 *Renew Energy* 2018; 119: 447-58.
- 478 [10] Chazarra M, Perez-Diaz JI, Garcia-Gonzalez J. Optimal joint energy and secondary regulation reserve hourly
 479 scheduling of variable speed pumped storage hydropower plants. *IEEE Trans Power Syst* 2018, 33: 103-15.
- 480 [11] Valavi M, Devillers E, Besnerais JL, Nysveen A, Nilsen R. Influence of converter topology and carrier frequency
 481 on airgap field harmonics, magnetic forces, and vibrations in converter-fed hydropower generator. To be
 482 appear in *IEEE Trans Ind Appl* 2018.
- 483 [12] Borkowski D. Maximum Efficiency point tracking (MEPT) for variable speed small hydropower plant with
 484 neural network based estimation of turbine discharge. *IEEE Trans Energy Convers* 2017; 32: 1090-98.
- 485 [13] Tessarolo A, Luise F, Raffin P, Degano M. Traditional hydropower plant revamping base on a variable-speed
 486 surface permanent-magnet high-torque-density generator. In: *International conference on clean electrical*
 487 *power, 2011 ICCEP. IEEE; 2011. p. 350-56.*
- 488 [14] Belhadji L, Bacha S, Roye D. Direct power control of variable-speed micro-hydropower plant based on
 489 propeller turbine. In: *International conference on electrical machines, 2012 ICEM. IEEE; 2012. p. 2079-84.*
- 490 [15] Abdullah MA, Yatim AH, Tan CW, Saidur R. A review of maximum power point tracking algorithms for wind energy
 491 systems. *J Renew Sustainable Energy Rev* 2012; 16: 3220-27.
- 492 [16] Mishra S, Shukla S. Comprehensive review on maximum power point tracking techniques: wind energy. In:
 493 *Communication, control and intelligent systems, 2015 CCIS. IEEE; 2015. p. 464-69.*
- 494 [17] Lee J, Kim Y. Sensorless fuzzy-logic-based maximum power point tracking control for a small-scale wind power generation
 495 systems with a switched-mode rectifier. *IET Renew Power Gen* 2016; 10:194-202.
- 496 [18] Rahmanian E, Akbari H, Sheisi H. Maximum power point tracking in grid connected wind plant by using intelligent
 497 controller and switched reluctance generator. *IEEE Trans Sustain Energy* 2017; 8:1313-20.
- 498 [19] Wei C, Zhang Z, Qiao W, Qu L. An adaptive network-based reinforcement learning method for MPPT control of PMSG
 499 wind energy conversion systems. *IEEE Trans Power Electron* 2016; 31: 7837-48.
- 500 [20] Chen J, Lin T, Wen C, Song Y. Design of a unified power controller for variable speed fixed-pitch wind energy conversion
 501 system. *IEEE Trans Ind Electron* 2016; 63: 4899-908.
- 502 [21] Belhadji L, Bacha S, Munteanu I, Rumeau A, Roye D. Adaptive MPPT applied to variable-speed microhydropower plant.
 503 *IEEE Trans Energy Convers* 2013; 28: 34-43.
- 504 [22] Guo B, Bacha S, Alamir M, Imaneini H. An anti-disturbance ADRC based MPPT for variable speed micro-
 505 hydropower plant. In: *Industrial electronics conference, 2017 IECON. IEEE; 2017. p. 1783-89.*
- 506 [23] Tourkey-Atta K, Johansson A, Cervantes MJ, Gustafsson T. Maximum power point tracking for micro hydro
 507 power plants using extremum seeking control. In: *IEEE conference on control applications, 2015 CCA. IEEE;*
 508 *2015. p. 1874-79.*
- 509 [24] Tan K, Yao TT, Islam S. Effect of loss modeling on optimum operation of wind turbine energy conversion systems. In:
 510 *International power engineering conference, 2005 IEEE, 2005. p. 1-9.*
- 511 [25] Echenique Subiabre EJP, Mueller MA. Realistic loss modelling and mismatching in an air-cored permanent magnet
 512 generator for wind energy applications. In: *IET Int. Conf. Power Electron. Machines and Drives, PEMD. IEEE; 2012. p. 1-6.*
- 513 [26] Kazmi SMR, Goto H, Guo HJ, Ichinokura O. A novel algorithm for fast and efficient speed-sensorless maximum power
 514 point tracking in wind energy conversion systems. *IEEE Trans Ind Electron* 2011, 58: 29- 36.
- 515 [27] Borkowski D. Control strategy for maximizing conversion efficiency of a small hydropower plant. *Technical*
 516 *Trans Electr Eng* 2015; 8: 15-24.
- 517 [28] Marquez JL, Molina MG, Pacas JM. Dynamic modelling, simulation and control design of an advanced micro-hydro power
 518 plant for distributed generation applications. *Int J Hydrogen Energy* 2010; 35: 5772-77.
- 519 [29] Krishnan R. *Electric Motor Drives-Modeling, Analysis, and Control.* Prentice Hall, 2001.

- 520 [30] Wang J, Atallah K, Chin R, Arshad WM, Lendenmann H. Rotor eddy-current loss in permanent-magnet brushless ac
521 machines. *IEEE Trans Magn* 2010; 46: 2701–07.
- 522 [31] IEC Standard: Electric cables-Calculation of the current rating- Current rating equations and calculation of losses. IEC
523 60287-1-1, 2006.
- 524 [32] Eggers D, Steentjes S, Hameyer K. Advanced iron-loss estimation for nonlinear material behavior. *IEEE Trans Magn* 2012;
525 48: 3021-24.
- 526 [33] Choi JY, Ko KJ, Jang SM. Experimental works and power loss calculations of surface-mounted permanent magnet
527 machines. *J Magn* 2011; 16: 64-70.
- 528 [34] Ni R, Xu D, Wang G, Ding L, Zhang G, Qu L. Maximum efficiency per ampere control of permanent-magnet synchronous
529 machines. *IEEE Trans Ind Electron* 2015, 62: 2135- 43.
- 530 [35] Inaba N, Takahashi R, Tamura J, Kimura M, Komura A, Takeda K. A derivation of simulation model of offshore wind farm
531 with losses and annual capacity factor considered. In: International conference on electrical machines and systems, 2012
532 ICEMS. IEEE; 2012. p. 1-6.
- 533 [36] Yan Y, Zhu J, Guo Y. A permanent magnet synchronous motor model with core loss. *J. Japan Society of Applied*
534 *Electromagnetics and Mechanics* 2007; 15: 147-50.
- 535 [37] Casanellas F. Losses in PWM inverters using IGBTs. In: *IEEE proceedings-electric power applications*, 1994. p. 235- 39.
- 536 [38] Semikron. Determining switching losses of Semikron IGBT modules. AN 1403 application note, 2014.
- 537 [39] Ocnasu D, Gombert C, Bacha S, Roye D, Blache F, Mekhtoub S. Real-time hybrid facility for the study of
538 distributed power generation systems. *J. Revue des Energies Renouvelables* 2008; 11: 343-50.
- 539