



**HAL**  
open science

## Dynamic force microscopy in non-contact mode

Laurent Nony

► **To cite this version:**

| Laurent Nony. Dynamic force microscopy in non-contact mode. Master. France. 2019. hal-02349039

**HAL Id: hal-02349039**

**<https://hal.science/hal-02349039v1>**

Submitted on 5 Nov 2019

**HAL** is a multi-disciplinary open access archive for the deposit and dissemination of scientific research documents, whether they are published or not. The documents may come from teaching and research institutions in France or abroad, or from public or private research centers.

L'archive ouverte pluridisciplinaire **HAL**, est destinée au dépôt et à la diffusion de documents scientifiques de niveau recherche, publiés ou non, émanant des établissements d'enseignement et de recherche français ou étrangers, des laboratoires publics ou privés.



Institut Matériaux Microélectronique Nanosciences Provence

# Dynamic force microscopy in non-contact mode

Laurent Nony  
laurent.nony@im2np.fr

Aix-Marseille Université  
CNRS, Institut Matériaux Microélectronique et Nanosciences de Provence, UMR 7334, 13397, Marseille, France

M2 Nanosciences et Nanotechnologies  
UE Nano-objects « High-resolution imaging »  
2019-2020



# Documents & references

- Many documents and references related to the lecture “High-resolution imaging” are available on the AMUBox server:

<https://amubox.univ-amu.fr/s/T678xB289tXCJas>

- The references cited in the present document are given in the above link within the folder “Dynamic force microscopy”

# Atomic Force Microscopy

- **Microscopie à Force Atomique = Atomic Force Microscopy : AFM**
- **Microscopy technique** developed in 1986 by the inventors of the Scanning Tunneling Microscope (STM, 1982 at IBM Zurich, Physics Nobel Prize) → Images of the surface of any kind of sample in real space **with atomic vertical and lateral resolution by using interaction forces between a nano-tip and the surface**

## STM

Source: *Applied Physics Letters* **40**, p178 (1982)

### Tunneling through a controllable vacuum gap

G. Binnig, H. Rohrer, Ch. Gerber, and E. Weibel  
*IBM Zurich Research Laboratory, 8803 Rüschlikon-ZH, Switzerland*

(Received 30 September 1981; accepted for publication 4 November 1981)

We report on the first successful tunneling experiment with an externally and reproducibly adjustable vacuum gap. The observation of vacuum tunneling is established by the exponential dependence of the tunneling resistance on the width of the gap. The experimental setup allows for simultaneous investigation and treatment of the tunnel electrode surfaces.

PACS numbers: 73.40.Gk

Source: *Physical Review Letters* **49**, p57 (1982)

### Surface Studies by Scanning Tunneling Microscopy

G. Binnig, H. Rohrer, Ch. Gerber, and E. Weibel  
*IBM Zurich Research Laboratory, 8803 Rüschlikon-ZH, Switzerland*

Erreur! (Received 30 April 1982)

Surface microscopy using vacuum tunneling is demonstrated for the first time. Topographic pictures of surfaces on an *atomic scale* have been obtained. Examples of resolved monoatomic steps and surface reconstructions are shown for (110) surfaces of  $\text{CaIrSn}_4$  and Au.

PACS numbers: 68.20.+t, 73.40.Gk

## AFM

Source: *Physical Review Letters* **56**, p930 (1986)

### Atomic Force Microscope

G. Binnig<sup>(a)</sup> and C. F. Quate<sup>(b)</sup>

*Edward L. Ginzton Laboratory, Stanford University, Stanford, California 94305*

and

Ch. Gerber<sup>(c)</sup>

*IBM San Jose Research Laboratory, San Jose, California 95193*

(Received 5 December 1985)

The scanning tunneling microscope is proposed as a method to measure forces as small as  $10^{-18}$  N. As one application for this concept, we introduce a new type of microscope capable of investigating surfaces of insulators on an atomic scale. The atomic force microscope is a combination of the principles of the scanning tunneling microscope and the stylus profilometer. It incorporates a probe that does not damage the surface. Our preliminary results *in air* demonstrate a lateral resolution of 30 Å and a vertical resolution less than 1 Å.

PACS numbers: 68.35.Gy



# Outlook

A. AFM in 3 steps (contact mode concept)

B. Dynamic AFM

C. Dynamic AFM in non-contact mode

# Outlook

A. AFM in 3 steps (contact mode concept)

B. Dynamic AFM

C. Dynamic AFM in non-contact mode

# A – AFM in 3 steps (contact mode concept)

1. Tip-cantilever system
2. Optical detection setup
3. Surface scanning and feedback

# A – AFM in 3 steps (contact mode concept)

1. Tip-cantilever system

2. Optical detection setup

3. Surface scanning and feedback

# A1- Tip-cantilever system

- **AFM = scanning probe technique** (nano-tip close to a surface): tip is located at the end of a micro-lever = **cantilever**

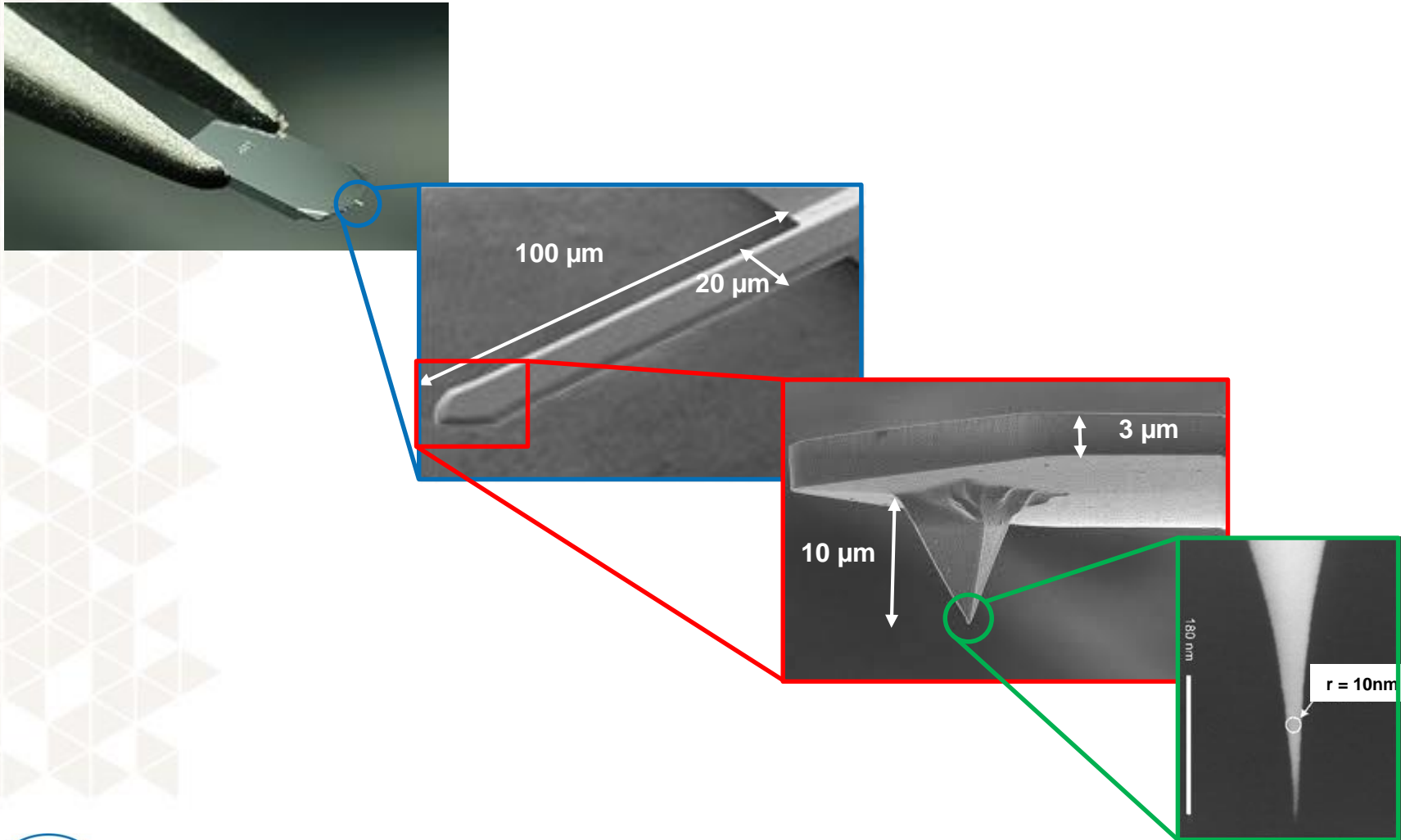

# A1- Tip-cantilever system

- **AFM = scanning probe technique** (nano-tip close to a surface): tip is located at the end of a micro-lever = **cantilever**
- **Mechanical analogy:** recessed beam
  - *Further simplification:* spring with stiffness  $k$  subject to an interaction force  $F_{int}$  with the surface, resonance frequency of the fundamental bending mode  $f_0$

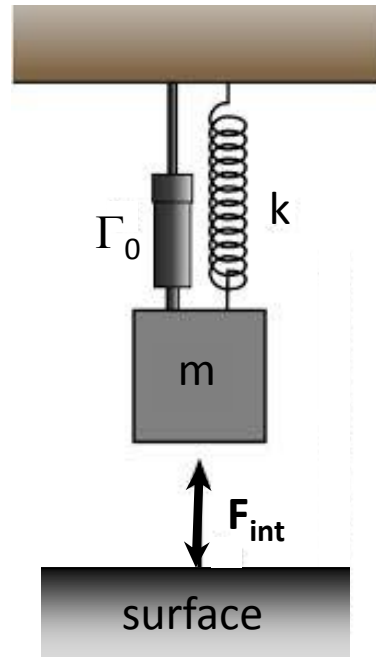

## Orders of magnitude cantilevers

Size:  $(100 \times 20 \times 3) \mu\text{m}^3$   
 Stiffness: 0.1 N/m ... 1800 N/m  
 Frequency: 10 kHz ... 1 MHz

## Orders of magnitude for tips

Aspect ratio upon resalers  
 Height:  $10 \mu\text{m}$   
 Curvature radius: 5nm (at best)

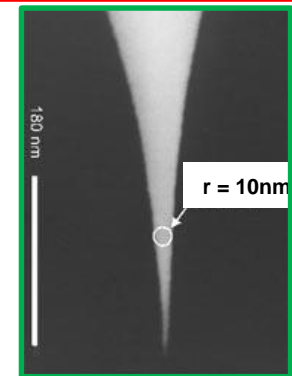
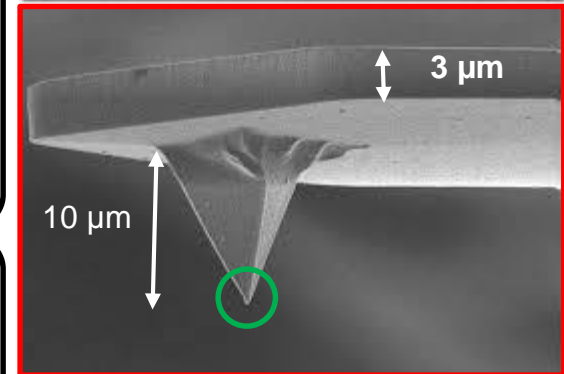
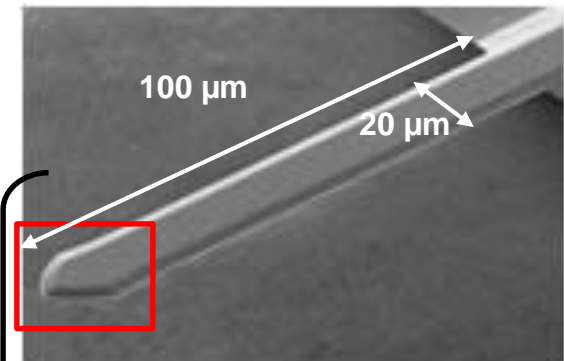

# A1- Tip-cantilever system

- **AFM = scanning probe technique** (nano-tip close to a surface): tip is located at the end of a micro-lever = **cantilever**
- **Mechanical analogy**: recessed beam
  - *Further simplification*: spring with stiffness  $k$  subject to an interaction force  $F_{\text{int}}$  with the surface, resonance frequency of the fundamental bending mode  $f_0$
- **Measure of the lever deflection by means of an optical setup**  $\Rightarrow$  **indirect measure of forces** (1 pN..1 nN):
  - **Electrostatic** (due to charges) : attractive, long-range ( $> 100$  nm)
  - **Van der Waals** (London, Debye, Keesom) : attractive, long-range ( $> 1$  nm)
  - **Chemical** (interatomic) : attractive or repulsive, short-range (few Å)
  - **Magnetic** (long-range)
- **For a detailed work on forces involved in AFM:**
  - "Scanning probe microscopy: the lab on a tip" (E.Meyer, H.J. Hug, R. Bennewitz, Springer-Verlag Berlin Heidelberg 2004)
  - "Noncontact Atomic Force Microscopy" (S.Morita, R. Wiesendanger, E. Meyer, Springer-Verlag Berlin Heidelberg 2002)
  - "Intermolecular and surface forces, 3<sup>rd</sup> edition" (J.N.Israelachvili, Elsevier 2011)

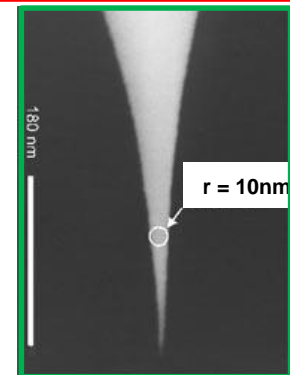
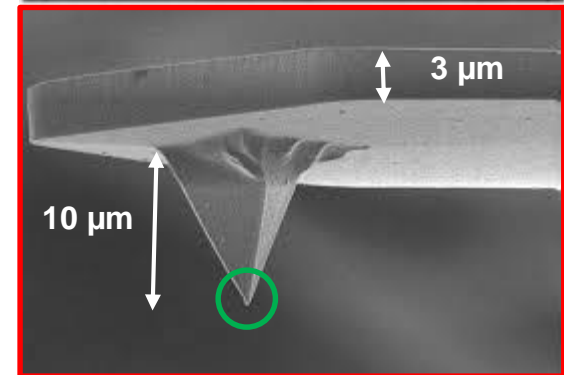
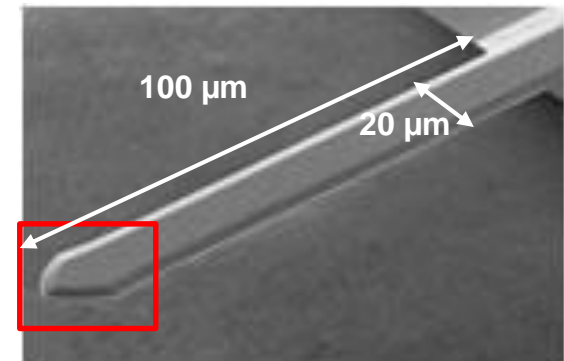



# A1- Tip-cantilever system

- Tip-surface interaction force<sup>1</sup>:

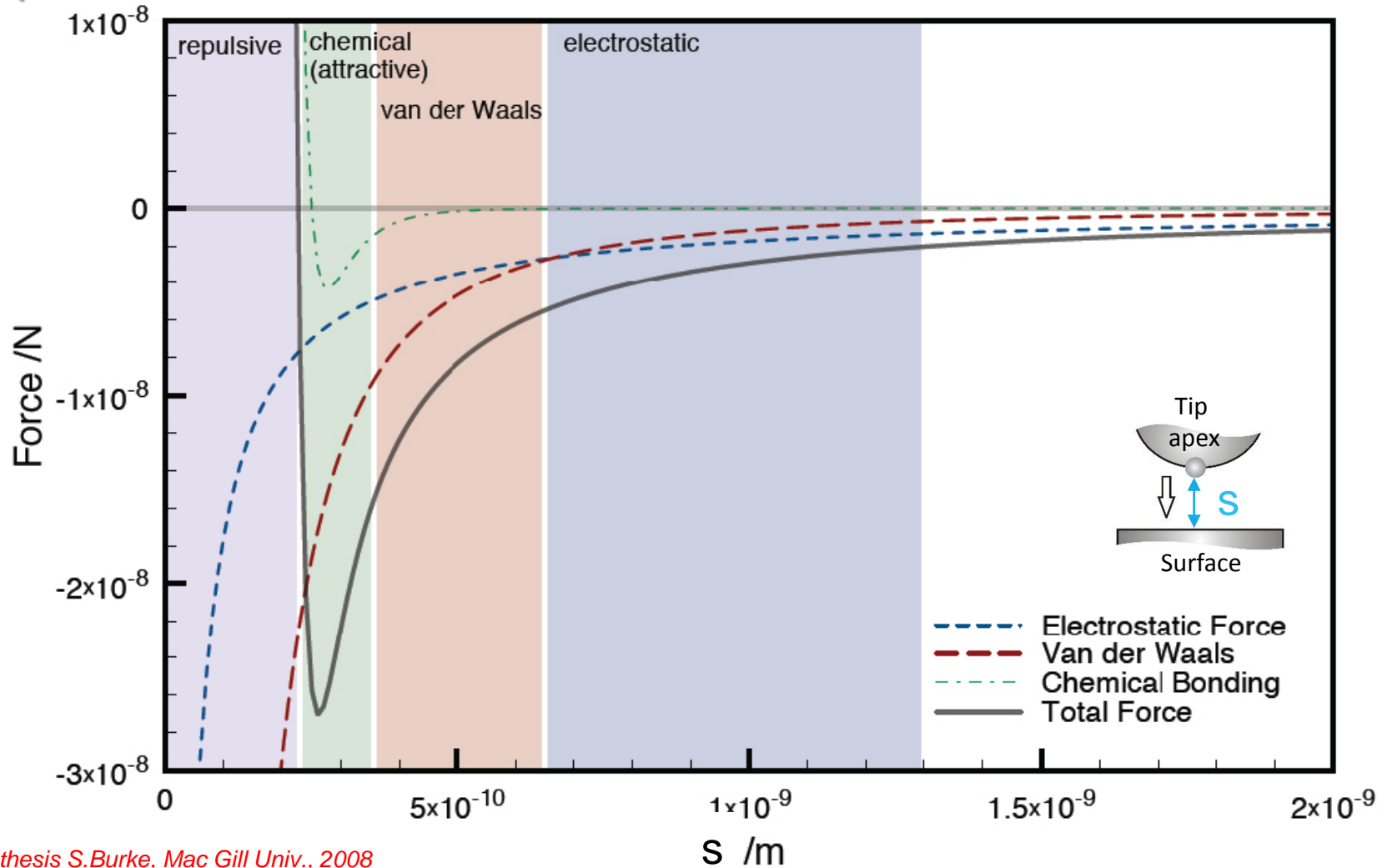

<sup>1</sup>PhD thesis S.Burke, Mac Gill Univ., 2008

# A1- Tip-cantilever system

- **AFM = scanning probe technique** (nano-tip close to a surface): tip is located at the end of a micro-lever = **cantilever**
- **Mechanical analogy:** recessed beam
  - *Further simplification:* spring with stiffness  $k$  subject to an interaction force  $F_{\text{int}}$  with the surface, resonance frequency of the fundamental bending mode  $f_0$
- **Scaling illustration:**

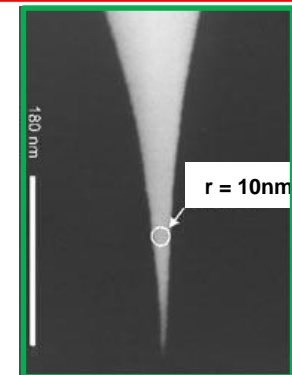
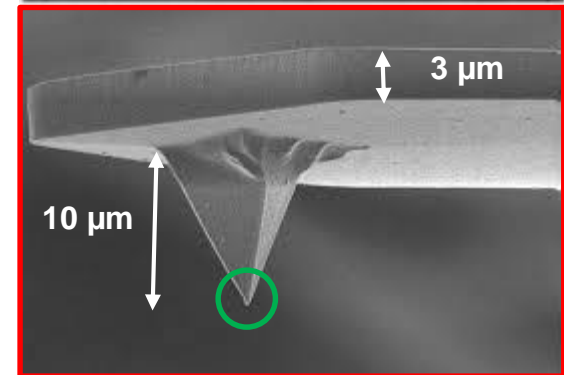
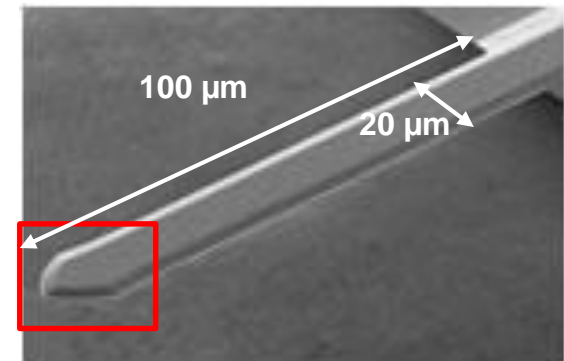
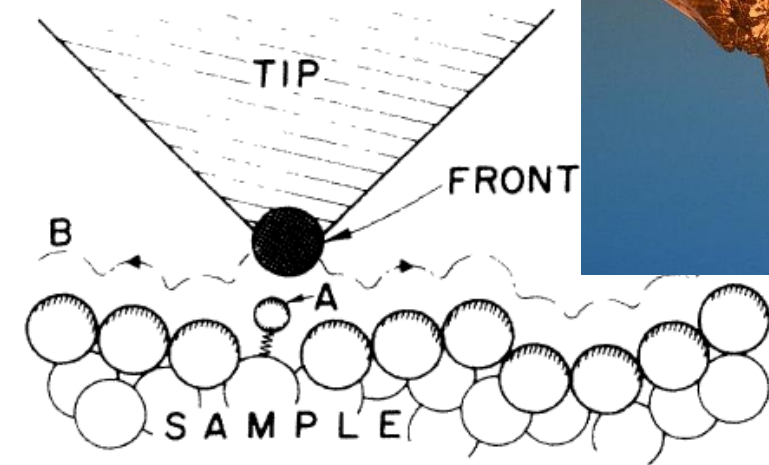

G.Binnig et al., *Phys. Rev. Lett.* **56**, p930 (1986)

# A - AFM in 3 steps (contact mode concept)

1. Tip-cantilever system

2. Optical detection setup

3. Surface scanning and feedback

# A2- Optical detection setup

## How AFM Works

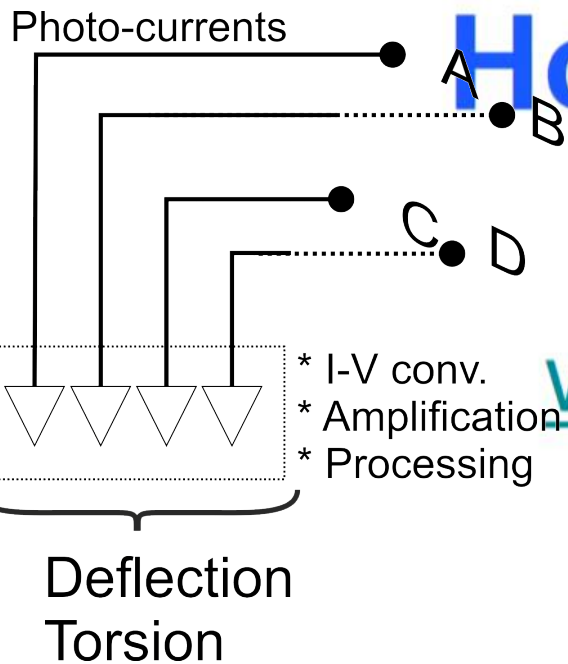

[www.ParkAFM.com](http://www.ParkAFM.com)

Park Systems, Inc.

t=35s



Institut Matériaux Microélectronique Nanosciences Provence  
UMR 7334, CNRS, Universités d'Aix-Marseille (AMU) et de Toulon (UTLN)



Aix-Marseille  
université  
Initiative d'excellence

UNIVERSITÉ  
DE TOULON

ISEN  
ALLIANCE  
INDUSTRIELLE



Association  
INSTITUTS  
CARNOT

# A2- Optical detection setup

- 4-quadrants PhotoSensitive Detector: PSD
  - 4 PN junctions side-by-side
  - 4 anodes + 1 common cathode

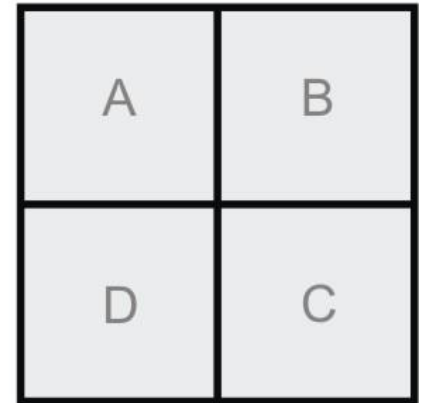
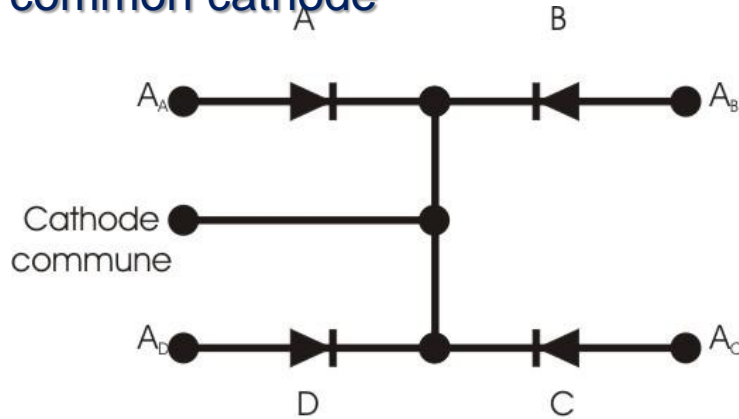

Ex.: PDB c-203 (Advanced photonix, Inc)

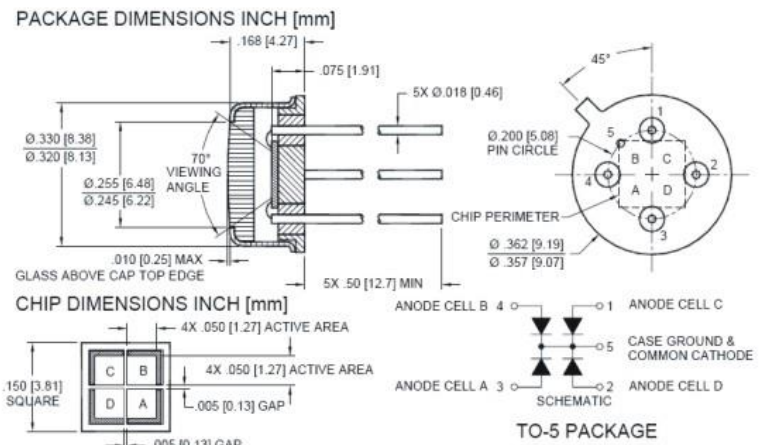

# A2- Optical detection setup

- Movement detection:

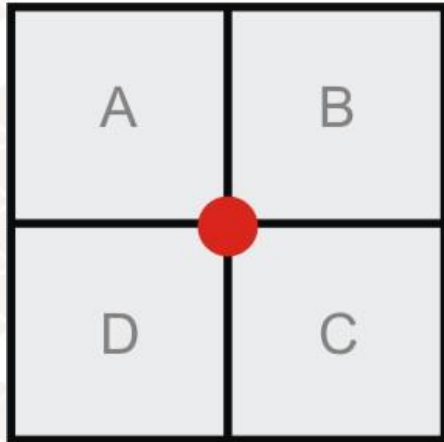

Photocourant (/quad)  
Photocourant total

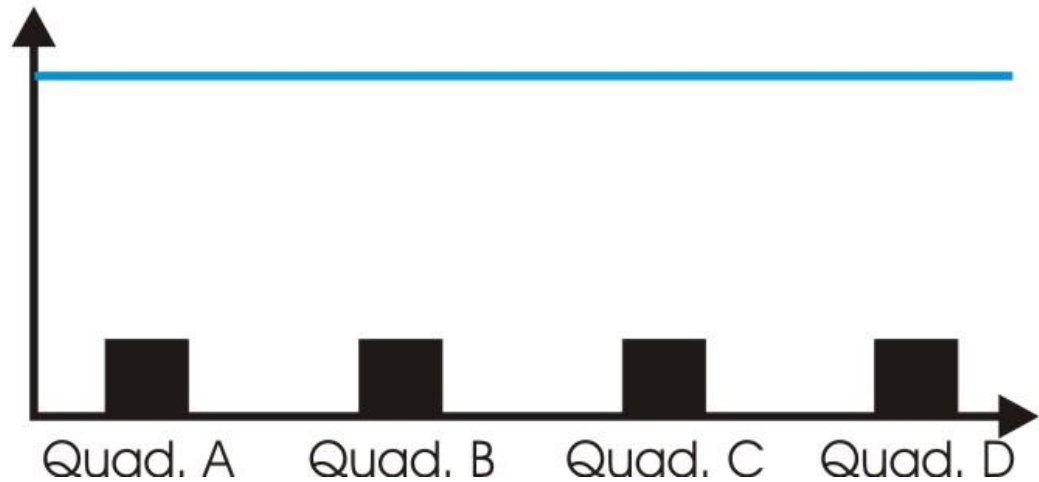



# A2- Optical detection setup

- Movement detection:

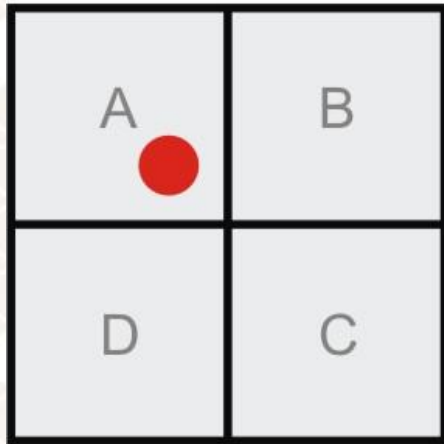

Photocourant (/quad)  
Photocourant total

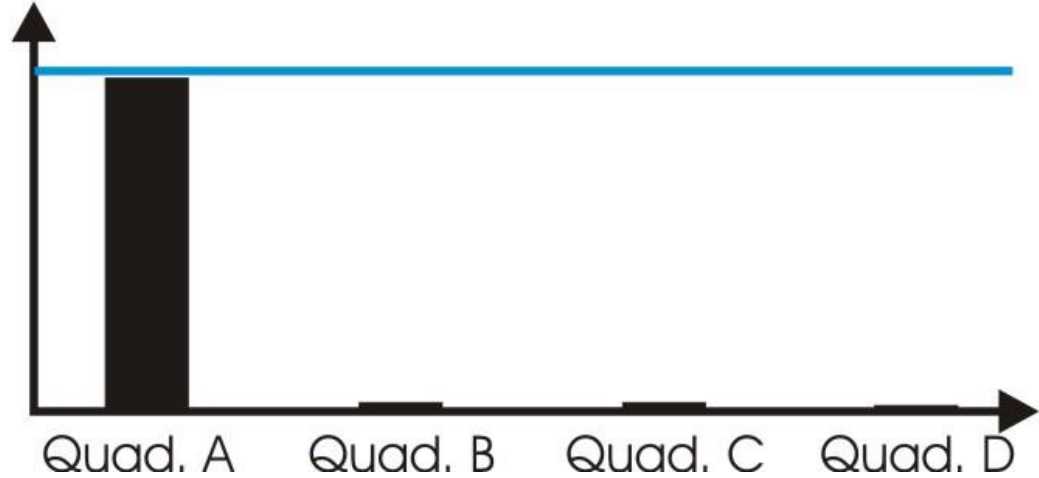



# A2- Optical detection setup

- Movement detection:

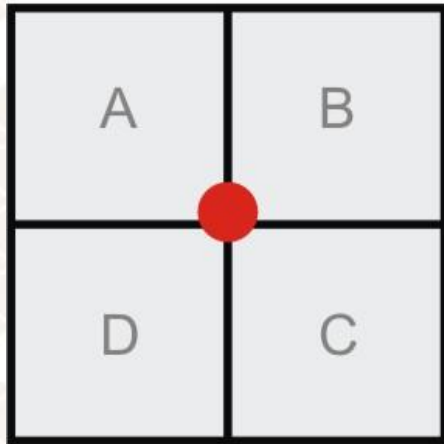

Photocourant (/quad)  
Photocourant total

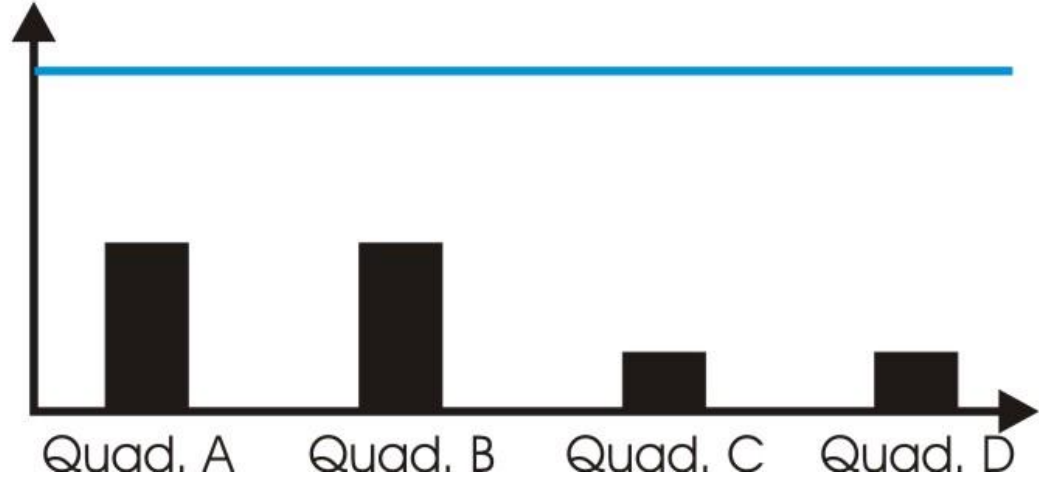

# A2- Optical detection setup

- Movement detection:

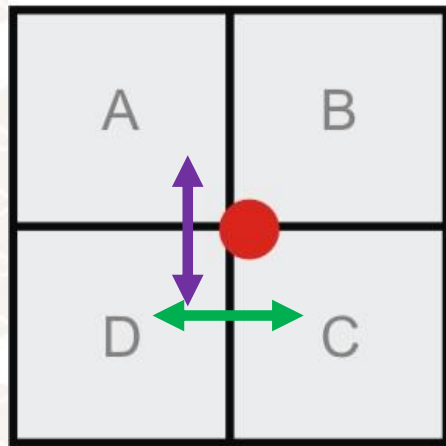

Photocourant (/quad)  
Photocourant total

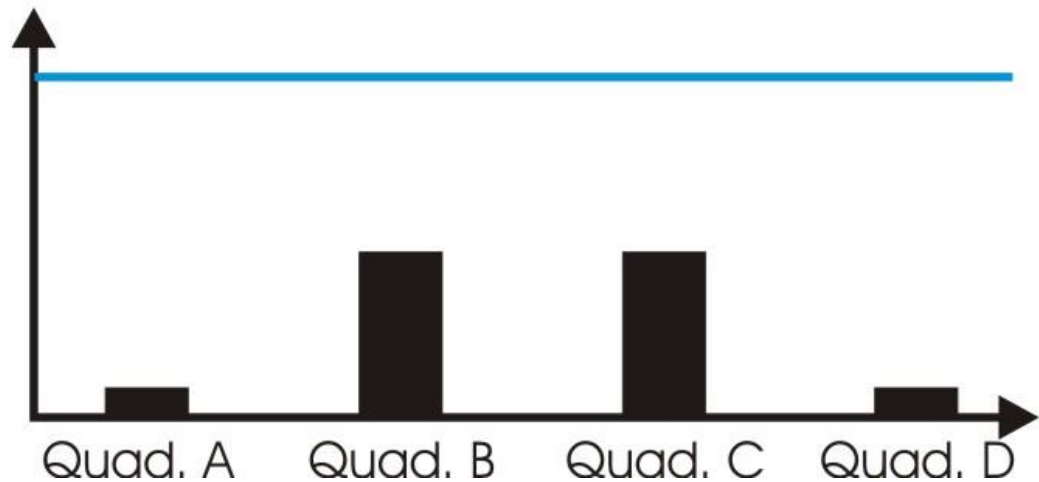

Cantilever deflection = « Normal force ( $F_N$ ) » =  $(A + B) - (C + D)$

Cantilever torsion = « Lateral force ( $F_L$ ) » =  $(A + D) - (B + C)$

# A - AFM in 3 steps (contact mode concept)

1. Tip-cantilever system

2. Optical detection setup

3. Surface scanning and feedback

# A3- Surface scanning & feedback

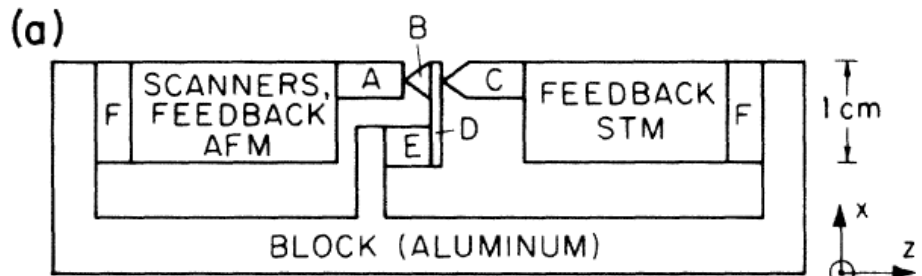
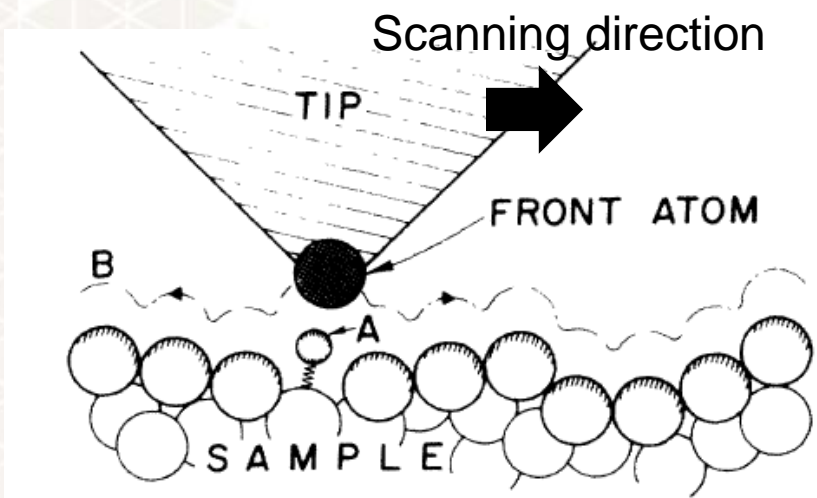

- (b)
- A: AFM SAMPLE
  - B: AFM DIAMOND TIP
  - C: STM TIP (Au)
  - D: CANTILEVER, STM SAMPLE
  - E: MODULATING PIEZO
  - F: VITON

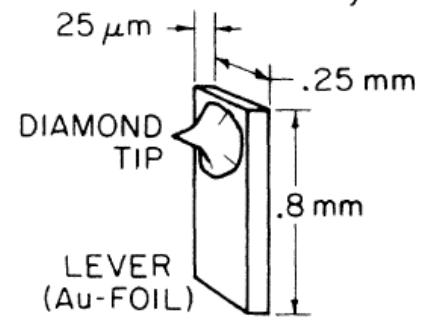

G.Binnig et al., Phys. Rev. Lett. 56, p930 (1986)

# A3- Surface scanning & feedback

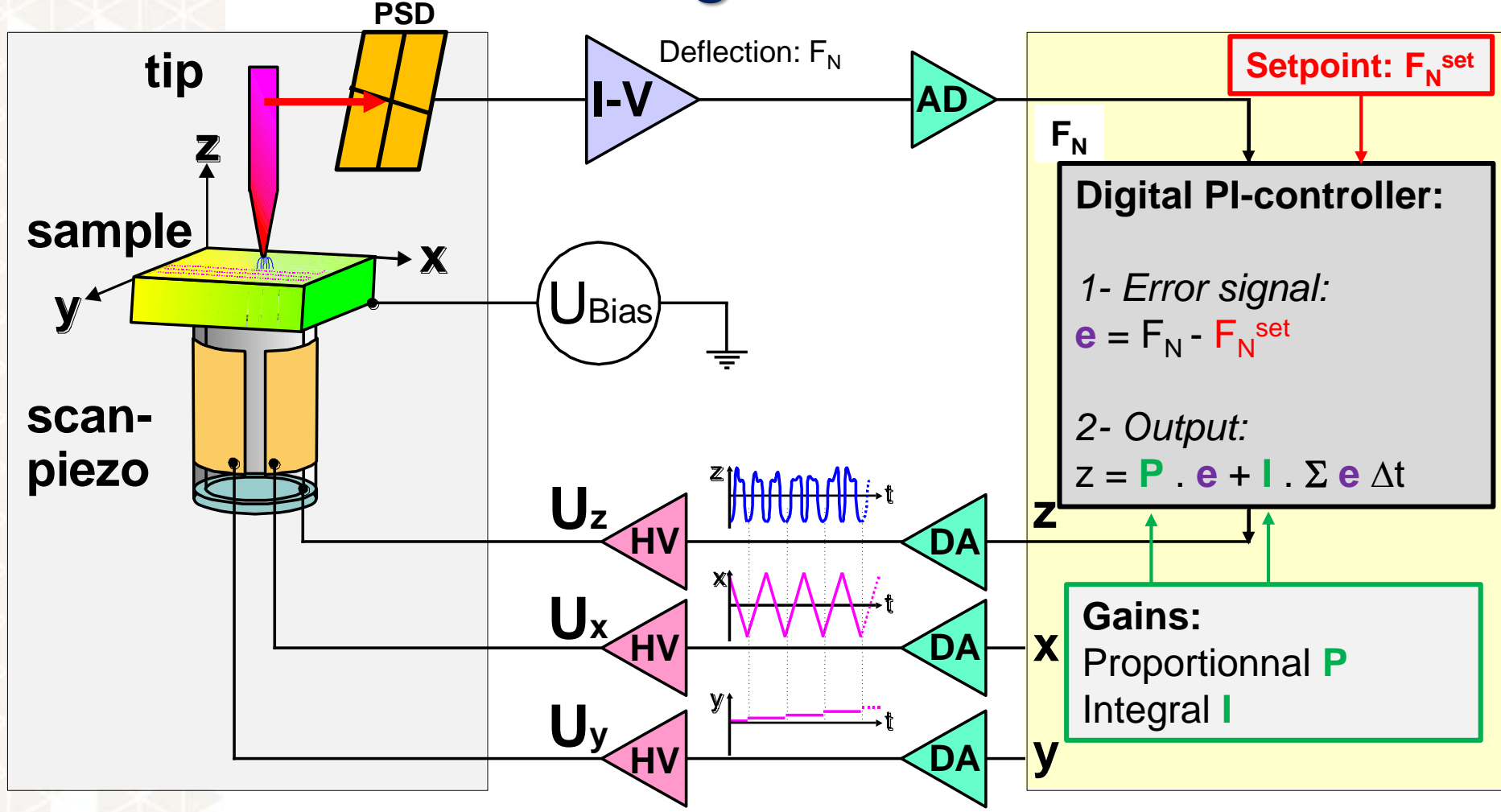

In AFM, the vertical feedback can be performed on various signals, not only on the deflection  $F_N$  (see hereafter)!

# A3- Surface scanning & feedback

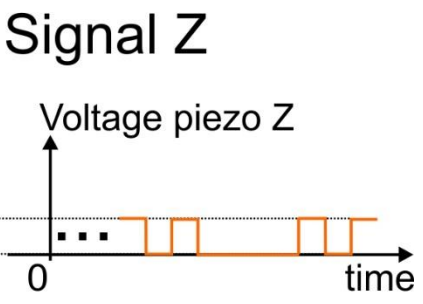
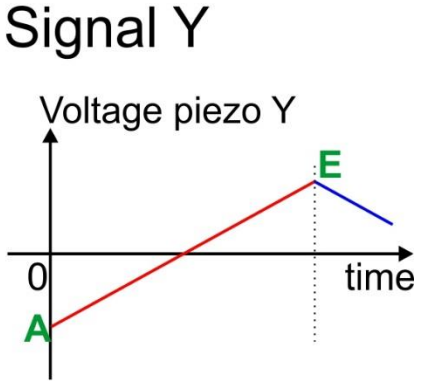
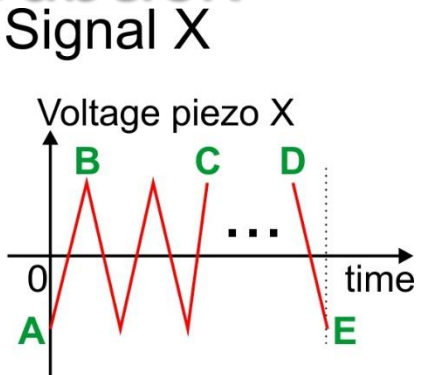
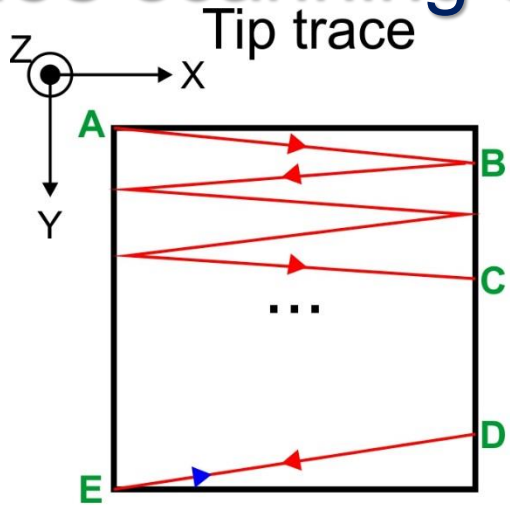

↓ *sampling*

Image:  $n \times m$  pixels  
(512x512 typ.)

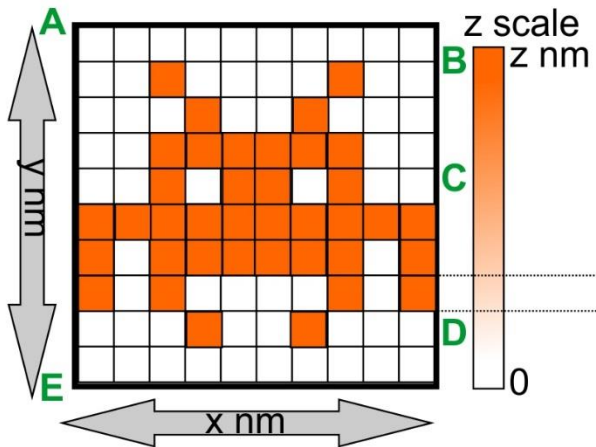

# A3- Surface scanning & feedback

## How AFM Works

[www.ParkAFM.com](http://www.ParkAFM.com)

Park Systems, Inc.



# Outlook

A. AFM in 3 steps (contact mode concept)

**B. Dynamic AFM**

C. Dynamic AFM in non-contact mode

# B – Dynamic AFM

1. Dynamic AFM specificities
2. Force sensitivity
3. Non-linear dynamics and modelization
4. Tapping mode AFM vs. non-contact AFM

# B – Dynamic AFM

## 1. Dynamic AFM specificities

2. Force sensitivity

3. Non-linear dynamics and modelization

4. Tapping mode AFM vs. non-contact AFM

# B1- Dynamic AFM specificities

## Problem:

What is the pressure that applies on a  $1 \text{ \AA}^2$  surface upon a  $1 \text{ nN}$  force?

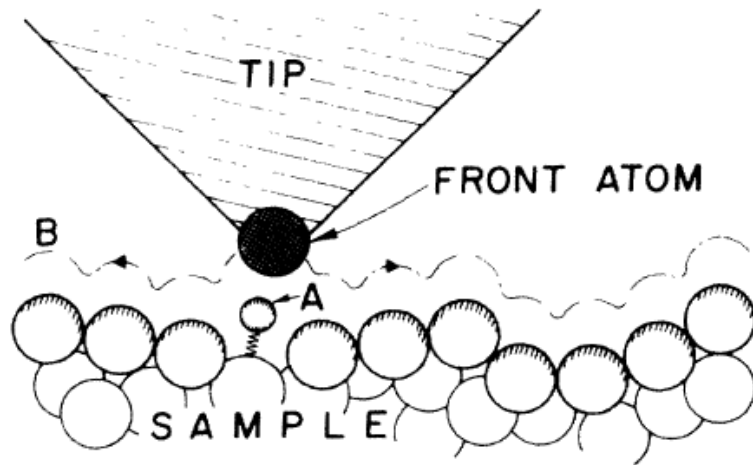

$$P = \frac{F}{s} = \frac{10^{-9} \text{ N}}{(10^{-10} \text{ m})^2} = 100 \text{ GPa}$$

*NB: Steel's Young modulus: 200 GPa*

## Consequence:

Tip and/or surface damaging.



# B1- Dynamic AFM specificities

- **Cantilever excitation at a frequency equal or close to its resonance frequency :**
  - **Advantages:**
    1. Lowering the shearing force between tip and surface
    2. Increasing force sensitivity w.r.t. the contact mode
    3. Non-contact (attractive force mapping only)
  - **Difficulties:**
    1. Understanding the cantilever non-linear dynamics
    2. Detection of the oscillation (system detection bandwidth > MHz)
    3. Complexity of the electronics scheme
    4. Origin of the image contrast ?
- **Measures with the tip-surface distance:**
  1. Oscillation frequency
  2. Oscillation amplitude
  3. Excitation amplitude
  4. Phase shift between excitation and oscillation
- **The mechanical system is strictly similar to a forced damped harmonic oscillator** (to be checked experimentally however)

Mode normal (fondamental)

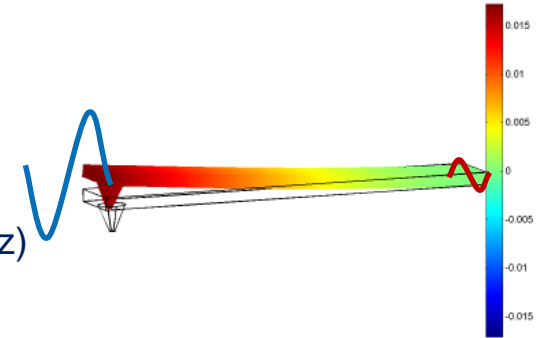

**Orders of magnitude:**

Amplitude : 50 pm ... 10 nm  
Frequency: 32 kHz ... 1 MHz

# B1- Dynamic AFM specificities

- 5 variables : Excitation amplitude, Excitation frequency, Oscillation amplitude, Phase (excitation / oscillation) and Tip-surface distance

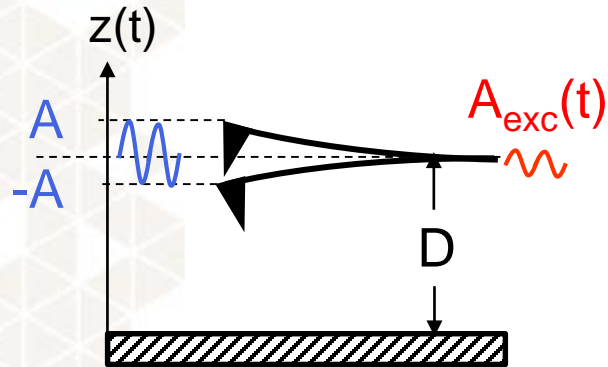

**Cantilever quality factor and intrinsic dissipation:**

$$Q = 2\pi \frac{\langle E_{stored} \rangle_T}{\langle E_{diss} \rangle_T} = \frac{2\pi f_0}{\Gamma_0}$$

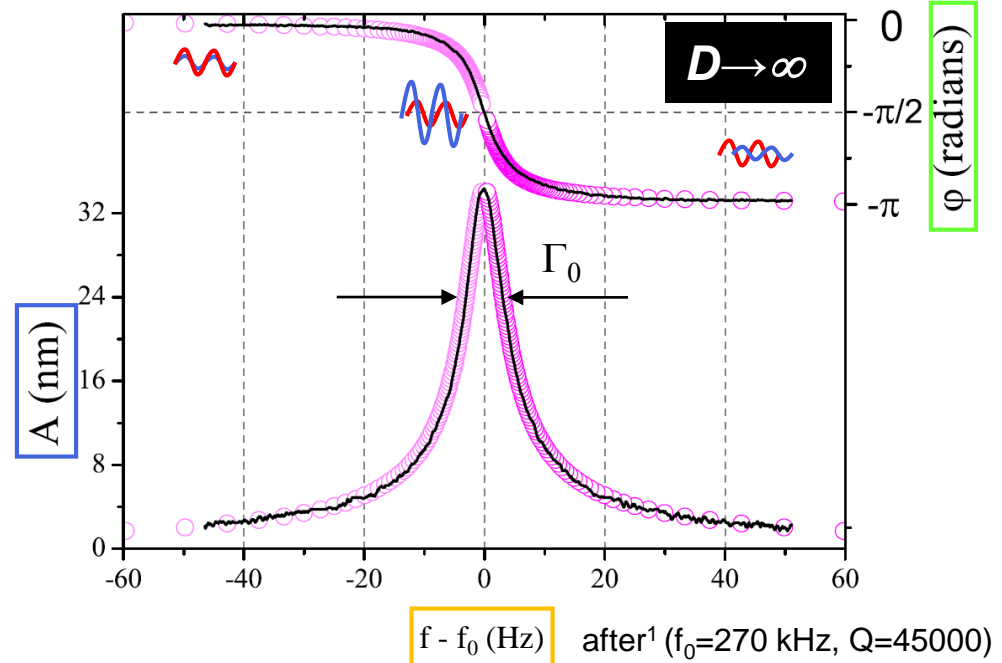

$$\left\{ \begin{array}{l} \text{Differential equation for } D \rightarrow \infty \\ \ddot{z}(t) + \frac{\omega_0}{Q} \dot{z}(t) + \omega_0^2 z(t) = \omega_0^2 A_{exc}(t) \\ \text{Harmonic solution:} \\ z(t) = A(\omega) \cos(\omega t + \varphi(\omega)) \end{array} \right.$$

$$a\left(u = \frac{\nu}{\nu_0}\right) = \frac{A(u)}{A_0} = \frac{1}{\sqrt{Q^2(1-u^2)^2 + u^2}}$$

$$\varphi(u) = \arctan\left\{\frac{u}{Q(u^2 - 1)}\right\}$$

<sup>1</sup> Polese et al., Nanotechnology **14**,1036 (2003)

# Exercice

Starting from the differential equation for the forced damped harmonic oscillator (Quality factor  $Q$ , pulsation at resonance  $\omega_0 = 2\pi\nu_0$ ):

$$\ddot{z}(t) + \frac{\omega_0}{Q} \dot{z}(t) + \omega_0^2 z(t) = \omega_0^2 A_{\text{exc}}(t)$$

with a forcing term of the form:

$$A_{\text{exc}}(t) = A_x \cos(\omega t) = \frac{A_0}{Q} \cos(\omega t)$$

and assuming a harmonic solution:

$$z(t) = A(\omega) \cos(\omega t + \varphi(\omega))$$

1- Prove that the normalized amplitude  $a(u) = A(u)/A_0$ , with  $u = \omega/\omega_0$  being the normalized frequency, and the phase of the oscillator write :

$$a\left(u = \frac{\nu}{\nu_0}\right) = \frac{A(u)}{A_0} = \frac{1}{\sqrt{Q^2(1-u^2)^2 + u^2}}$$
$$\varphi(u) = \arctan\left\{\frac{u}{Q(u^2 - 1)}\right\}$$

2- Plot these functions (with Igor Pro for instance) with  $Q = 100$ , then  $100000$ .



# B – Dynamic AFM

1. Dynamic AFM specificities
- 2. Force sensitivity**
3. Non-linear dynamics and modelization
4. Tapping mode AFM vs. non-contact AFM

# B2- Force sensitivity (for cantilevers)

- Equipartition theorem on a cantilever subject to thermal fluctuations yields a minimum detectable force :

$$F_{\min} = \sqrt{\frac{4kk_B T}{\omega_0 Q}} B$$

- Orders of magnitude:**

- $k = 30 \text{ N/m}$
- $B \sim 250 \text{ Hz}$
- $\omega_0 = 2\pi f_0 = 2\pi \cdot 150 \text{ kHz}$
- $Q = 40\,000$  (sous vide)
- $k_B T = 25 \text{ meV}$  (298 K)

$$F_{\min} \sim 60 \text{ pN}$$

- Increasing the sensitivity :**

- ✓ ↘  $k$  : risk for "jump to contact"
- ✓ ↘  $k_B T$  : not easy
- ✓ ↗  $\omega_0$  : technically demanding (detection bandwidth must be increased accordingly)
- ✓ ↗  $Q$  : depend upon the intrinsic dissipation of the material

# B2- Force sensitivity (for cantilevers)

- Tip-surface interaction force:

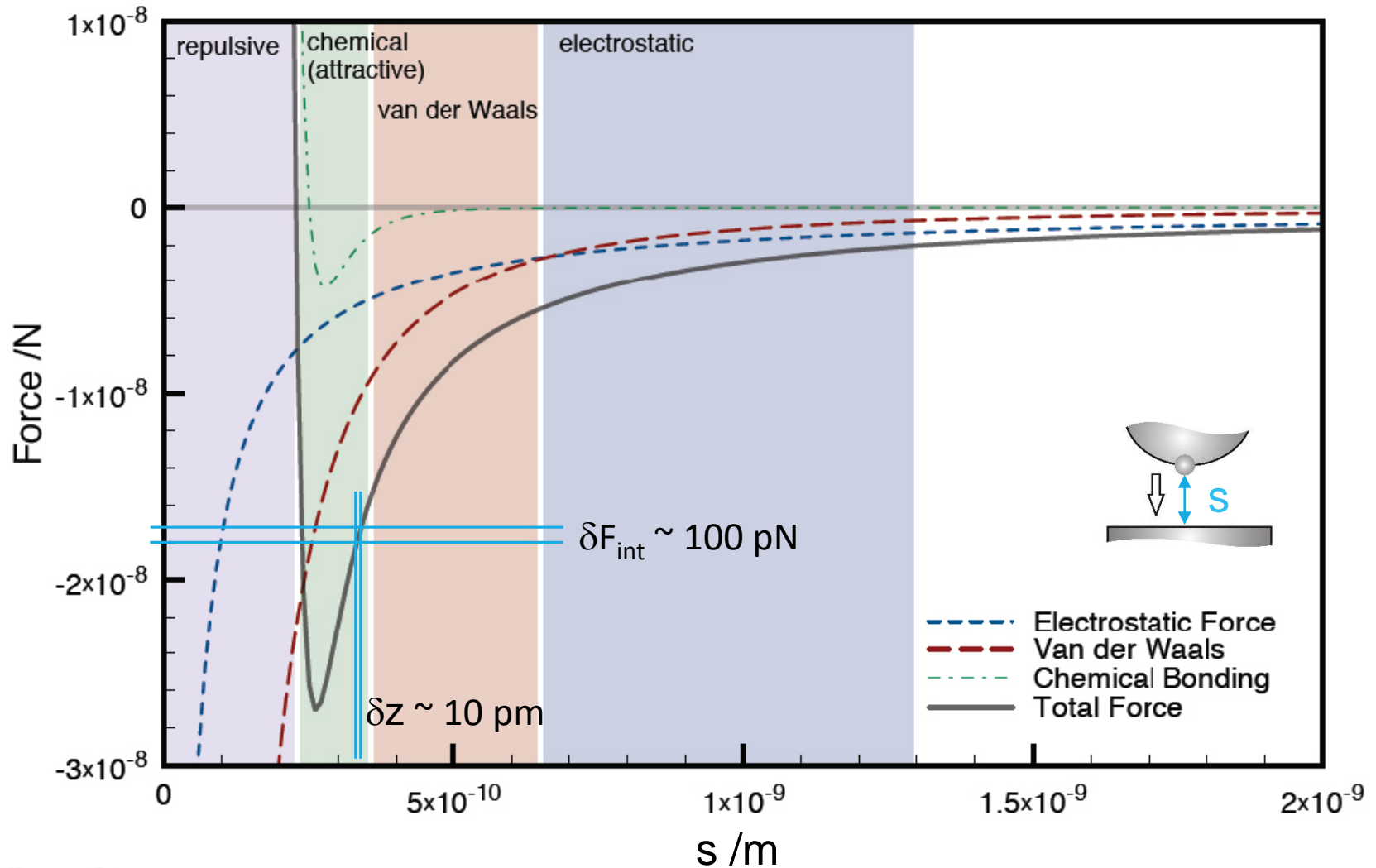



# B – Dynamic AFM

1. Dynamic AFM specificities
2. Force sensitivity
- 3. Non-linear dynamics and modelization**
4. Tapping mode AFM vs. non-contact AFM

# B3- Non-linear dynamics and modelization

- Problem:

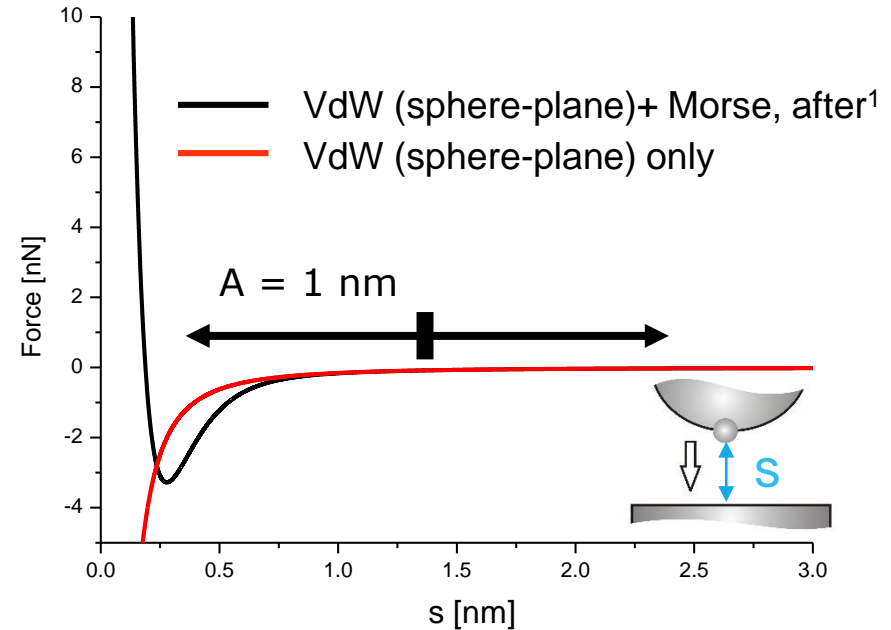
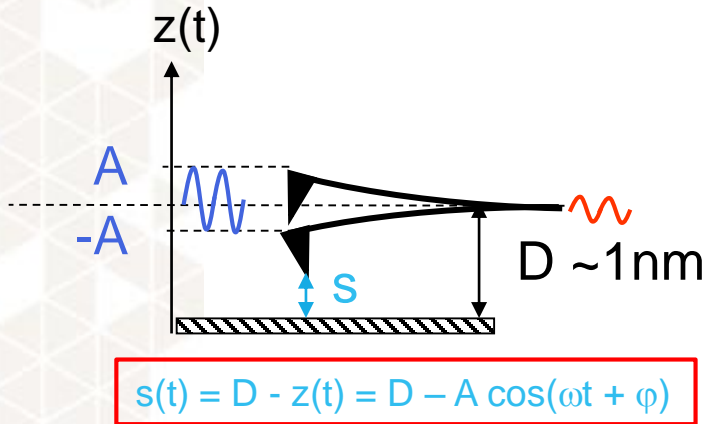

$$\ddot{z}(t) + \frac{\omega_0}{Q} \dot{z}(t) + \omega_0^2 z(t) = \omega_0^2 A_{\text{exc}}(t) + \frac{\omega_0^2 F_{\text{int}}(t)}{k_c} : F_{\text{int}} \text{ is non-linear in } z$$

$$z(t) = A(\omega) \cos(\omega t + \varphi(\omega)) : \text{non solution}$$

$$A(\omega), \varphi(\omega) \rightarrow A(\omega, D), \varphi(\omega, D)$$

<sup>1</sup>Pérez *et al.*, Phys Rev. B **58**, 10835 (1998)

# B3- Non-linear dynamics and modelization

- Experimental illustration<sup>1</sup>:

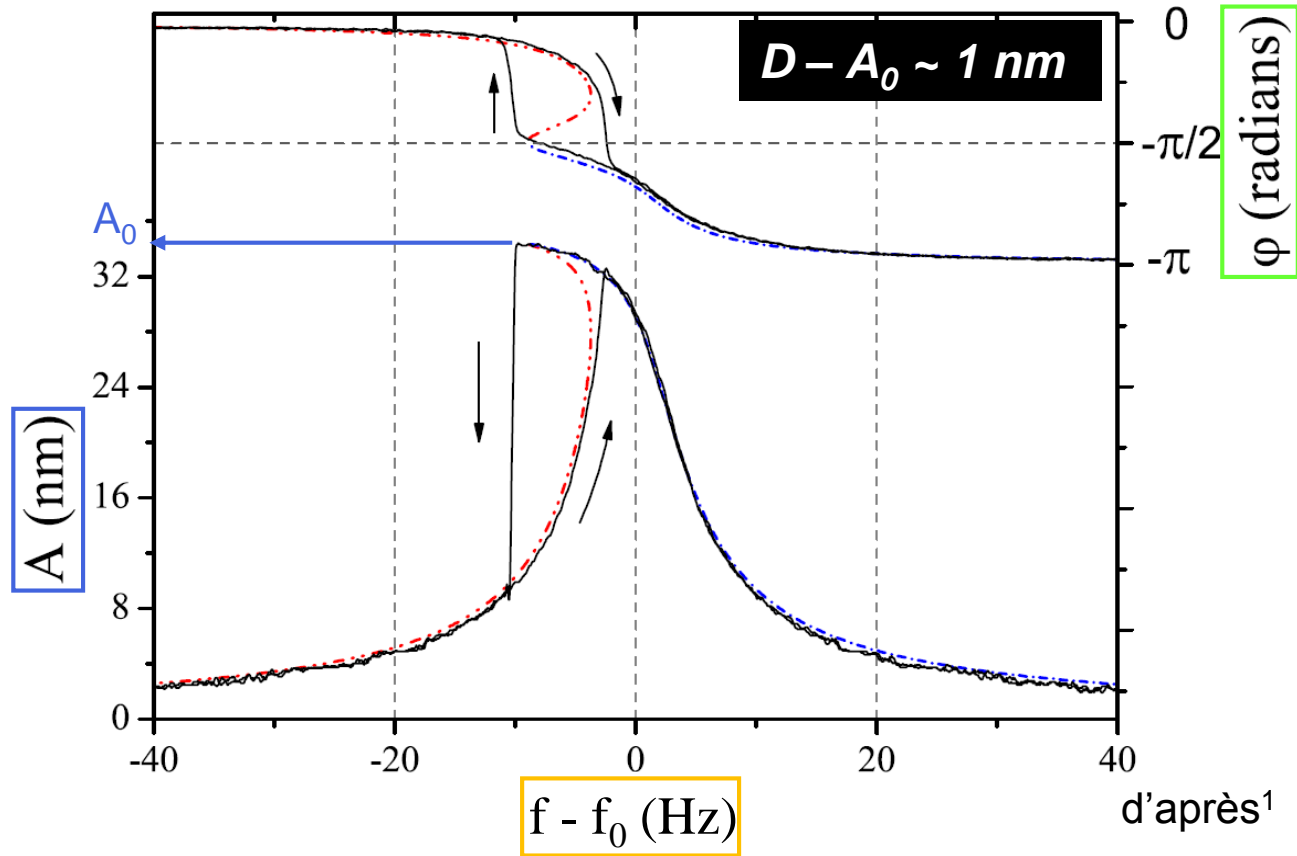

<sup>1</sup>Polesel *et al.*, Nanotechnology **14**:1036 (2003)



# B3- Non-linear dynamics and modelization

- Variational method based on the least action principle<sup>1</sup> :

$$\delta S = \delta \left[ \int_0^{1/f} L(z, \dot{z}, t) \right] = 0$$

$$L \left[ z(t), \dot{z}(t) \right] = T - V + W$$

$$= \frac{1}{2} \frac{k_c}{(2\pi f_0)^2} \dot{z}(t)^2 - \left[ \frac{1}{2} k_c z(t)^2 - z(t) k_c A_x \cos(2\pi f t) + V_c^{int}(z(t)) \right]$$

$$- \left[ \frac{\Gamma_0 k_c}{(2\pi f_0)^2} z(t) \dot{z}(t) + V_d^{int}(z(t), \dot{z}(t)) \right]$$

- Harmonic trial function:**  $z(t) = A \cos(2\pi f t + \varphi)$

$$\delta A \Leftarrow \cos(\varphi) = \frac{A}{A_x} \left( 1 - \frac{f^2}{f_0^2} \right) + \frac{2}{k_c A_x} \langle F_c \rangle$$

$$\delta \varphi \Leftarrow \sin(\varphi) = -\frac{f}{f_0} \times \frac{A}{Q A_x} - \frac{2}{k_c A_x} \langle F_d \rangle$$

Conservative & dissipative  
 coupling terms

<sup>1</sup>L.Nony *et al.* J.Chem.Phys.**111**,1610 (1999); "Analyse de la microscopie de force dynamique: application à l'étude de l'ADN", L.Nony, Thèse de l'univ. Bordeaux I (2000).

# B3- Non-linear dynamics and modelization

- Coupling terms (Fourier components of the interaction force @ f):

$$\left\{ \begin{array}{l} \langle F_{\text{int}}^c \rangle = -f \times \int_0^{1/f} \frac{\partial}{\partial A} V_{\text{int}}^c(z(t)) dt = \frac{1}{2\pi} \int_0^{2\pi} F_{\text{int}}^c(D - A \cos(u)) \cos(u) du \\ \langle F_{\text{int}}^d \rangle = -\frac{f}{A} \int_0^{1/f} \frac{\partial}{\partial \varphi} V_{\text{int}}^d(z(t); \dot{z}(t)) dt = \frac{1}{2\pi} \int_0^{2\pi} F_{\text{int}}^d(D - A \cos(u)) \sin(u) du \end{array} \right.$$

$$V_{\text{int}}^c = V_{\text{Lr}} + V_{\text{Sr}} + V_{\text{Elec}} + V_{\text{Magn}}$$

$$V_{VdW}(t) = -\frac{HR}{6(D - z(t))}$$

Long-range:

Dispersive Van der Waals

L.Nony *et al.* J.Chem.Phys.111,1610 (1999)

$$V_{Morse}(t) = -U_0 \left[ 2e^{-\frac{D-z(t)-r_e}{\lambda}} - e^{-\frac{2(D-z(t)-r_e)}{\lambda}} \right]$$

Short-range:

Morse

L.Nony *et al.*, Phys.Rev.B 74, 235409 (2006)

# B – Dynamic AFM

1. Dynamic AFM specificities
2. Force sensitivity
3. Non-linear dynamics and modelization
4. Tapping mode AFM vs. non-contact AFM

# B4- Tapping mode AFM vs. non-contact AFM:

- ❑ 5 variables : **Excitation amplitude**, **Excitation frequency**, **Oscillation amplitude**, **phase** (excitation / oscillation) and tip-surface distance
- ❑ The variables that are kept constant set the mode :

## ***Tapping*** ***(Amplitude Modulation-AFM)***

**Excitation amplitude** and  
**Excitation frequency** are constant



- *Measures* : **Oscillation amplitude** and **phase** vs. tip-surface distance
- *Probed interaction*: most generally, **attractive+repulsive interactions** (intermittent contact)

## ***non-contact AFM*** ***(nc-AFM, or Frequency Mod.-AFM<sup>1</sup>)***

**Phase** ( $=-\pi/2$  : resonance) and  
**Oscillation amplitude** are constant



- *Measures* : **Resonance frequency shift** and **excitation amplitude** required to keep the oscillation amplitude constant vs. tip-surface distance
- *Probed interaction*: most generally, **attractive interaction** (non-contact)

<sup>1</sup> T.Albrecht *et al.*, J.Appl.Phys.**69**, 668 (1991)

# Outlook

A. AFM in 3 steps (contact mode concept)

B. Dynamic AFM

C. Dynamic AFM in non-contact mode

# C – Dynamic AFM in non-contact mode

1. Introduction

2. Connection with the modelization

3. Experimental illustrations

4. Instrumentation: PLL & amplitude regulation

5. Important results & current trends

# C – Dynamic AFM in non-contact mode

## 1. Introduction

## 2. Connection with the modelization

## 3. Experimental illustrations

## 4. Instrumentation: PLL & amplitude regulation

## 5. Important results and current trends



# C1- Introduction

- Method developed<sup>1</sup> in 1991
- Concept:

Phase ( $= -\pi/2$  : resonance) and oscillation amplitude are constant

Measures : resonance frequency shift and excitation amplitude required to keep the oscillation amplitude constant (*DISSIPATION image*) vs. tip-surface distance

z feedback (*TOPOGRAPHY image*): performed to maintain  $\Delta f = \tilde{f}_0 - f_0$  constant (equivalent to tunneling current in STM)

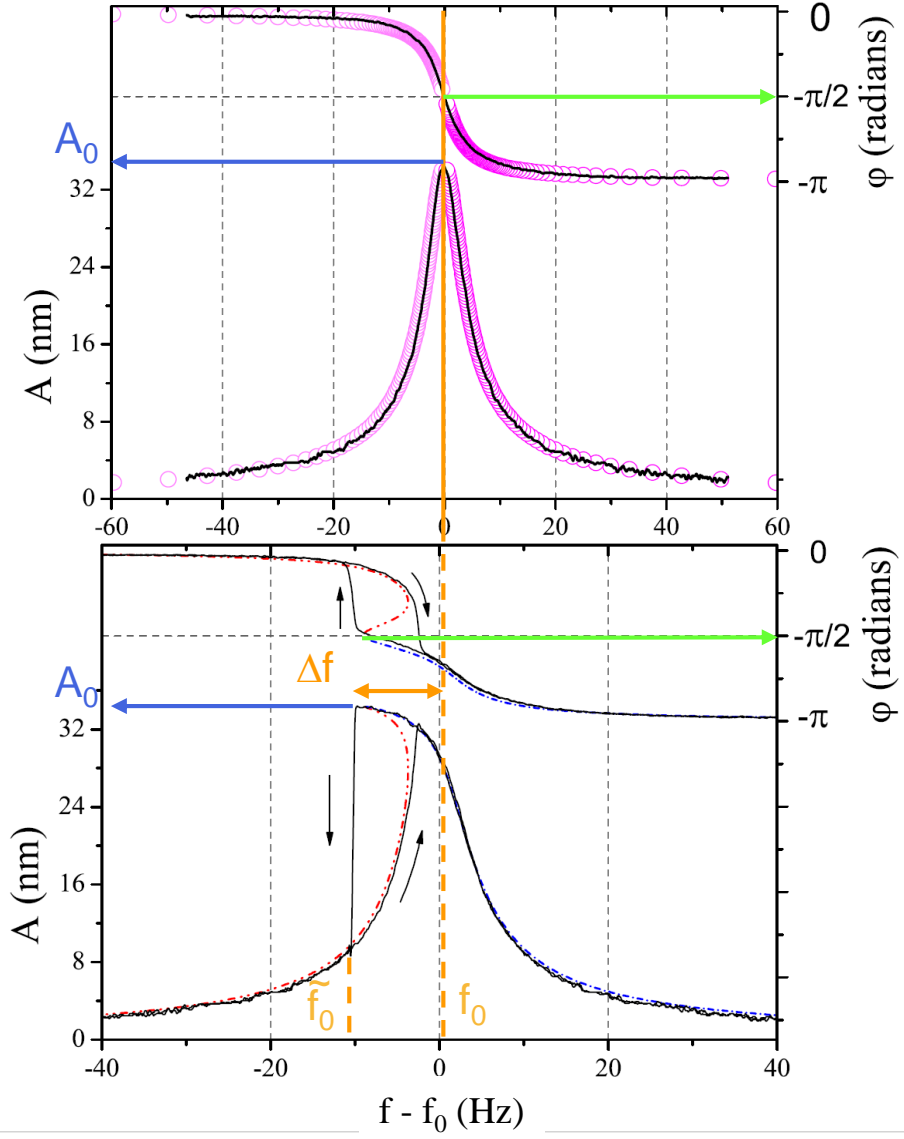

<sup>1</sup> T.Albrecht *et al.*, J.Appl.Phys.69, 668 (1991)

# C – Dynamic AFM in non-contact mode

1. Introduction

**2. Connection with the modelization**

3. Experimental illustrations

4. Instrumentation: PLL & amplitude feedback

5. Important results and current trends

# C2- Connection with the modelization (1):

- Oscillation amplitude and **phase** ( $=-\pi/2$ ) are fixed: Solving the system  $\{\cos(\varphi), \sin(\varphi)\}$  w.r.t. **A** and  **$\varphi$** . **Normalized frequency shift** :

$$\frac{\Delta f}{f_0} = -\frac{1}{2\pi k_c A} \int_0^{2\pi} F_{\text{int}}^c(D + A \cos(u)) \cos(u) du$$

F.Giessibl (1997, 2000); U.Dürig (1999); L.Nony (1999, 2006)

- Conservative interaction force (Attractive = non-contact)** :

$$F_{\text{int}}^c(z) = -\frac{\partial}{\partial z} V_{\text{int}}^c(z) \text{ with } \begin{cases} V_{VdW}(t) = -\frac{HR}{6(D-z(t))} \\ V_{Morse}(t) = -U_0 \left[ 2e^{-\frac{D-z(t)-r_c}{\lambda}} - e^{-\frac{2(D-z(t)-r_c)}{\lambda}} \right] \end{cases}$$

- Hence the analytic expression for  **$\Delta f$** :

$$\frac{\Delta f}{f_0} = -\frac{1}{k_c A} \left[ \frac{HRA}{6(D^2 - A^2)^{3/2}} + \frac{2U_0}{\lambda} (Y_{1,1/\lambda} - Y_{1,2/\lambda}) \right].$$

Long-range

Short-range

# C2- Connection with the modelization (1):

- $\Delta f$  as function of the tip-surface distance:

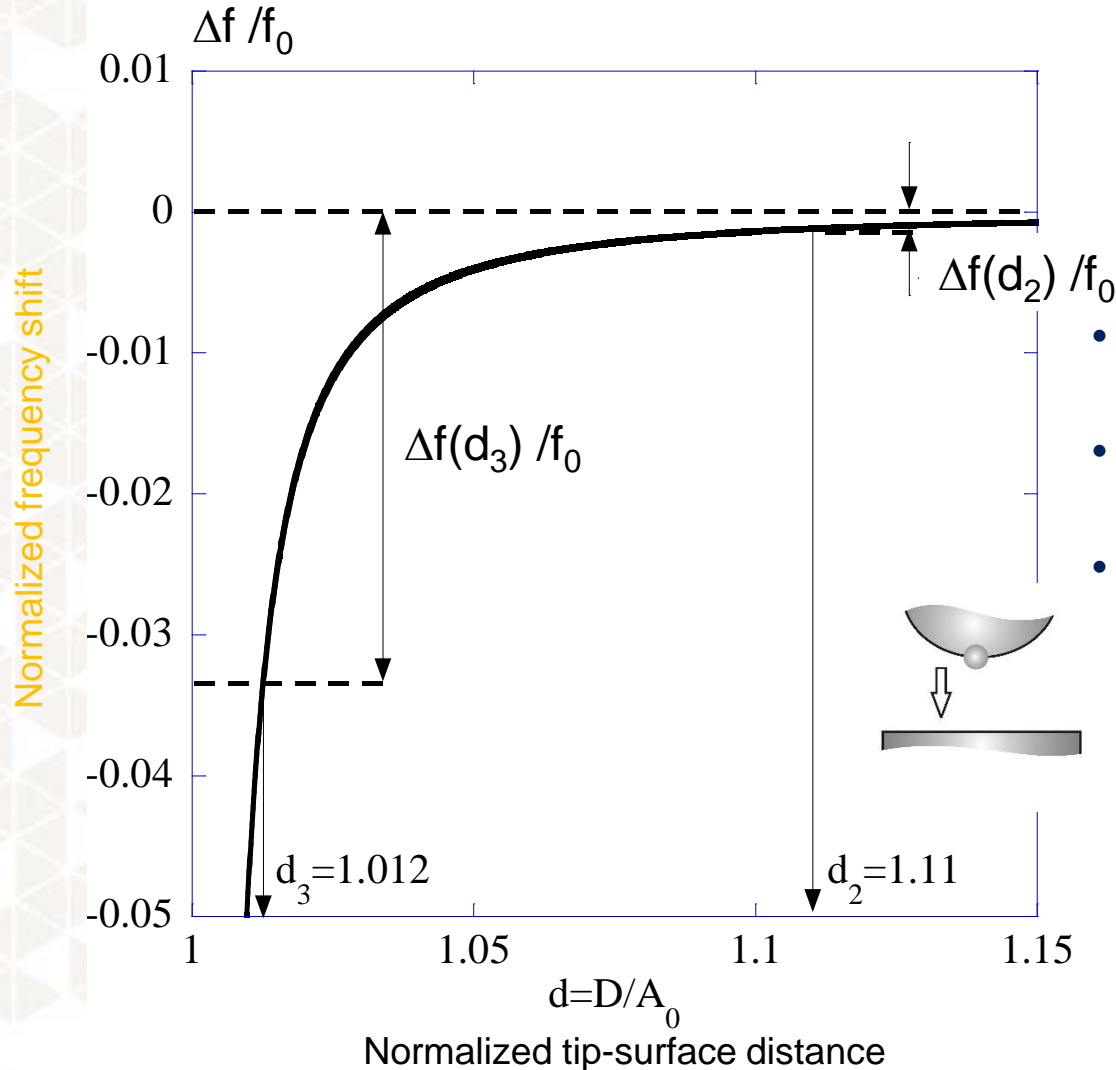

- Rapid change of  $\Delta f$  with the distance
- Similar to tunneling current in STM
- $\Delta f$  always negative with an attractive interaction force (= non-contact situation)

### Orders of magnitude:

$$A_0 = 5 \text{ nm}$$

$$f_0 = 150 \text{ kHz}$$

$$k = 30 \text{ N/m}$$

$$\Delta f(D_2 = 5.55 \text{ nm}) = -150 \text{ Hz}$$

$$\Delta f(D_3 = 5.06 \text{ nm}) = -4800 \text{ Hz!}$$

# Exercice

- The calculation of the frequency shift can be simplified upon linearization of the interaction force by assuming small oscillation amplitudes ( $A \sim 50 \text{ pm} \ll D$ ).

$$F_{\text{int}}(t) = F_{\text{int}}(s(t)) = F_{\text{int}}(D - z(t)) \simeq \left. \frac{\partial F_{\text{int}}(s)}{\partial s} \right|_{s_{\text{min}}=D-A_0} s(t)$$

- In this case, reconsider the differential equation of motion of the cantilever and prove that the shifted resonance frequency then writes :

$$\tilde{f}_0 = f_0 \sqrt{1 - \frac{1}{k} \left. \frac{\partial F_{\text{int}}}{\partial s} \right|_{s_{\text{min}}}}$$

- Deduce out of this the linearized formula for the frequency shift :

$$\frac{\tilde{f}_0 - f_0}{f_0} = \frac{\Delta f}{f_0} = -\frac{1}{2k} \left. \frac{\partial F_{\text{int}}}{\partial s} \right|_{s_{\text{min}}}$$

# C2- Connection with the modelization (2):

- Vertical sensitivity in the short-range regime (order of magnitude):

$$\delta z / \delta \Delta f \sim 10 \text{ pm} / \text{Hz}$$

- The experimental control on  $\Delta f$  is better than 0,1 Hz (around  $f_0 \sim 150$  kHz), **i.e. 1 pm vertical resolution !**
- This is what is achieved at low temperature (liquid Helium : 4K).
- At room temperature, the noise level of the instrument (z, amplitude detection...) exceeds that value. The resolution onset then is rather 10 pm.
- This sensitivity is enough to achieve atomic resolution at room temperature**

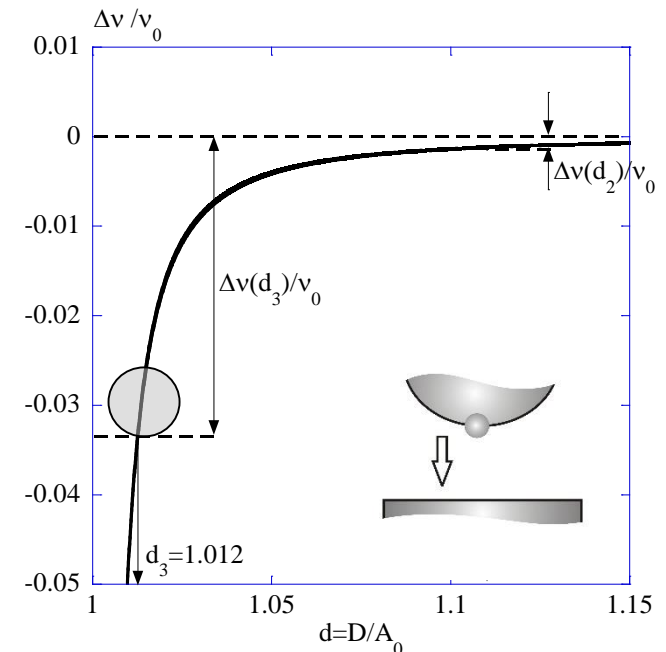



# C – Dynamic AFM in non-contact mode

1. Introduction

2. Connection with the modelization

**3. Experimental illustrations**

4. Instrumentation: PLL & amplitude feedback

5. Important results and current trends



# C3- Experimental illustrations

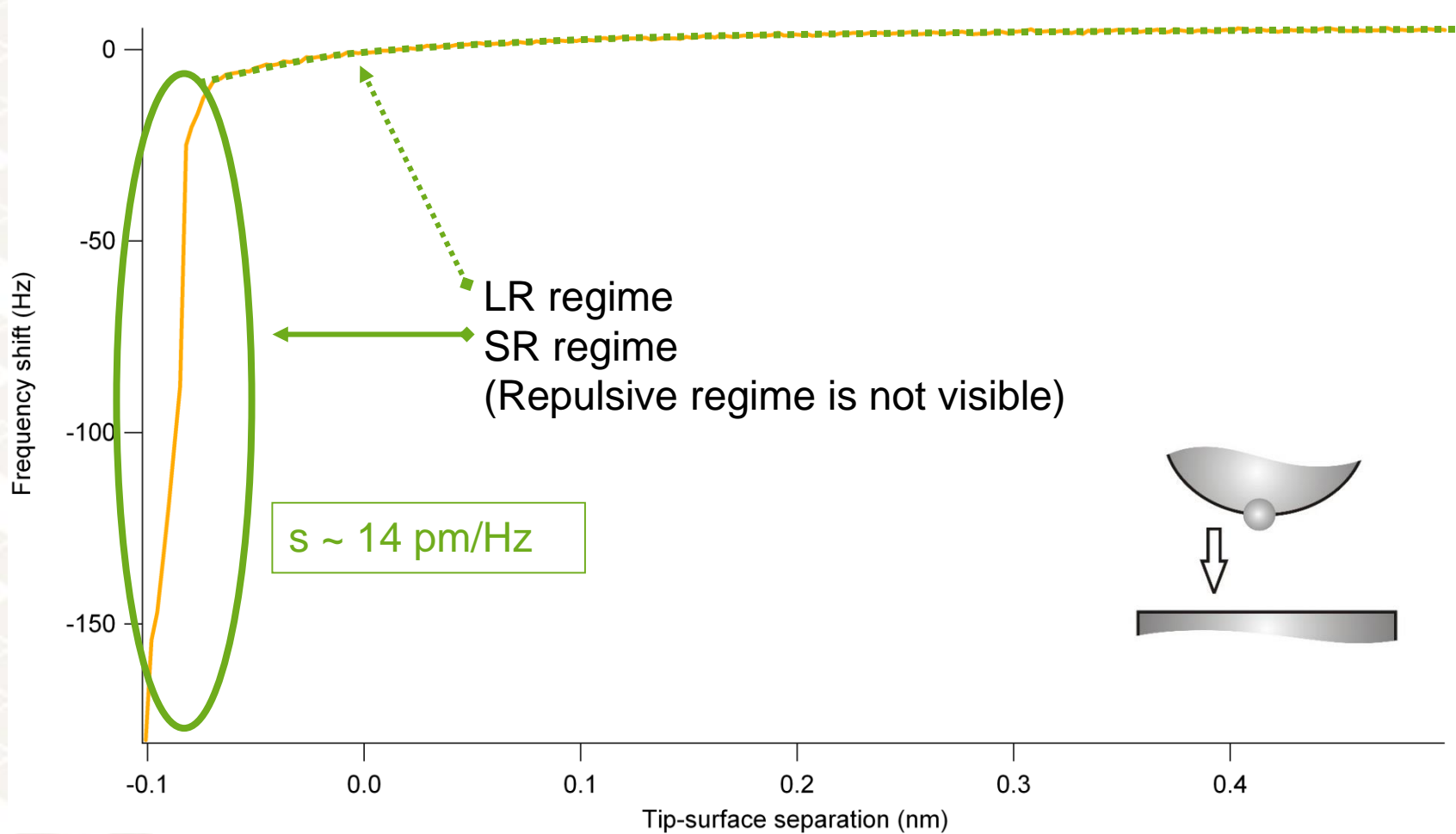

# C3- Experimental illustrations

**CaF<sub>2</sub>**

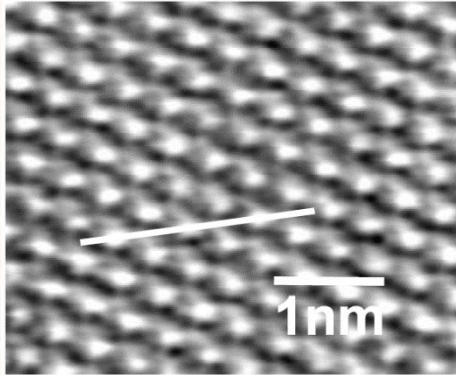

C. Barth *et al.*  
J. Phys.: Condens. Matter **13**, 2061(2001)

**NaCl islands on  
Cu(111)**

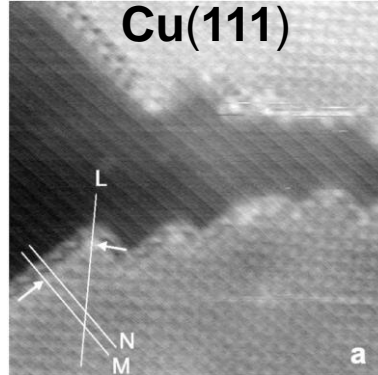

R. Bennewitz *et al.*  
Phys. Rev. B **13**, 2061 (2001)

**KBr + e<sup>-</sup>**

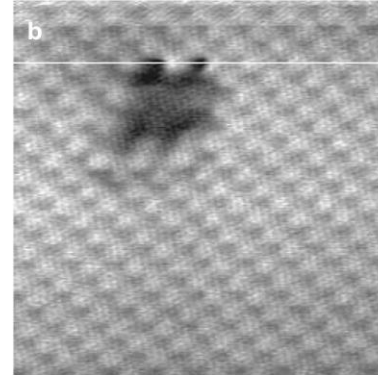

R. Bennewitz *et al.*  
Surf. Sci. **474**, L197 (2001)

**Cu(100)**

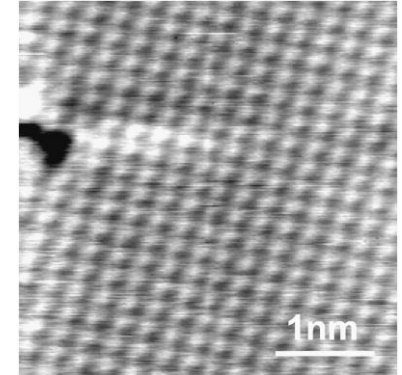

C. Loppacher *et al.*  
Phys. Rev. B **62**, 16944 (2000)

**NiO(100) @7K**

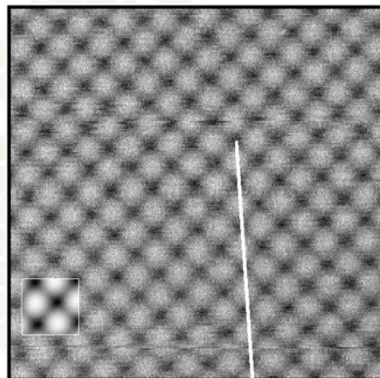

R. Hoffmann *et al.*  
Phys. Rev. B **67**, 085402 (2003)

**InAs(110) @14K**

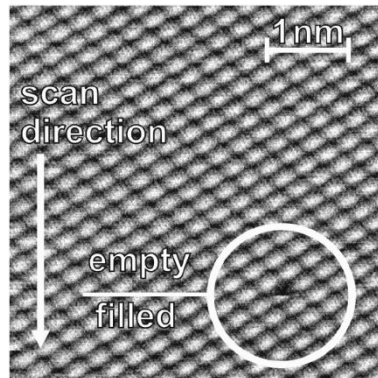

A. Schwarz *et al.*  
Phys. Rev. B **61**, 2837 (2000)

**Si(111)7x7 @RT & 7K**

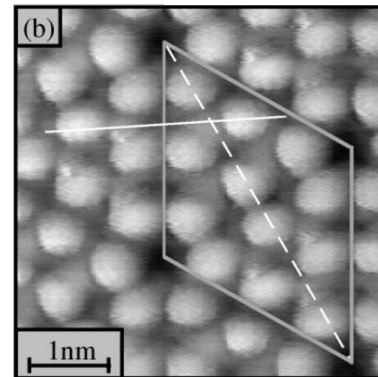

M. Lantz *et al.*  
Phys. Rev. Lett. **84**, 2642 (2000)

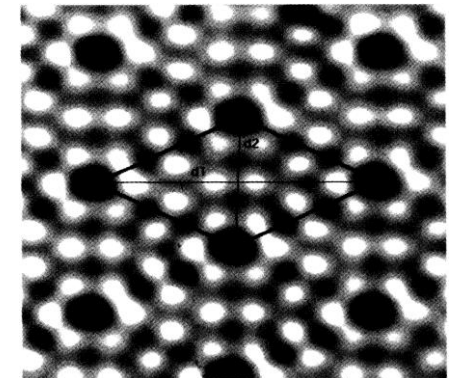

F. Giessibl  
Science **267**, 68 (1995)

# C – Dynamic AFM in non-contact mode

1. Introduction

2. Connection with the modelization

3. Experimental illustrations

**4. Instrumentation: PLL & amplitude feedback**

5. Important results and current trends

# C4- Instrumentation: PLL & amplitude feedback

- Phase Locked Loop (PLL):
- ✓ A PLL ensures the detection of  $\Delta f$  w.r.t. a reference frequency which is fixed equal to the **resonance frequency of the free cantilever**  $f_0$ , therefore matching the phase condition  $\varphi = -\pi/2$

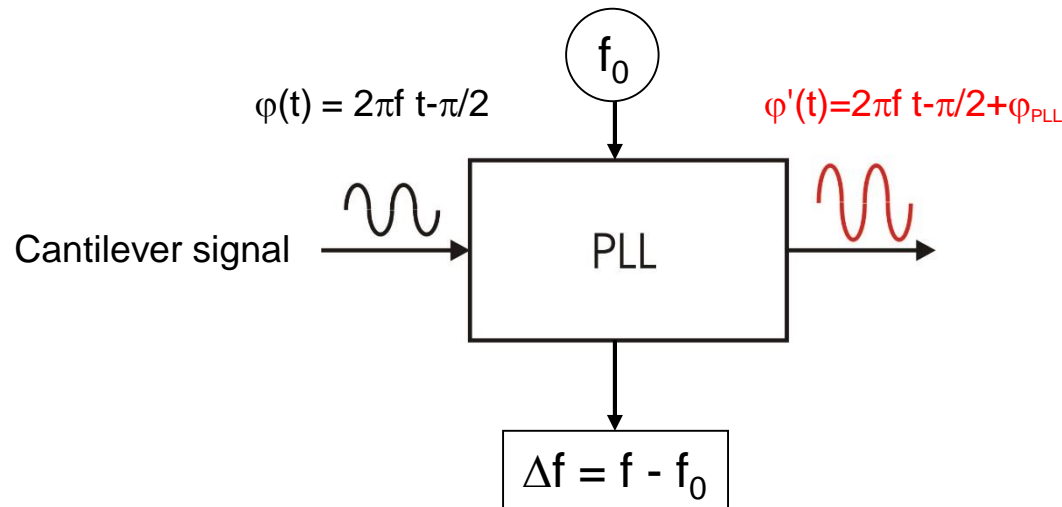

- ✓ **Frequency demodulation around  $f_0$ !**
- ✓ In this excitation scheme of the cantilever, there are no bifurcations structures as seen in AM-AFM. Qualitatively, the interpretation of the frequency shift can be made out of the linear approach, but it is to be reminded that the measured shift is the one that derives from the non-linear approach...

# C4- Instrumentation: PLL & amplitude feedback

- Principle for the retention of the excitation at resonance:

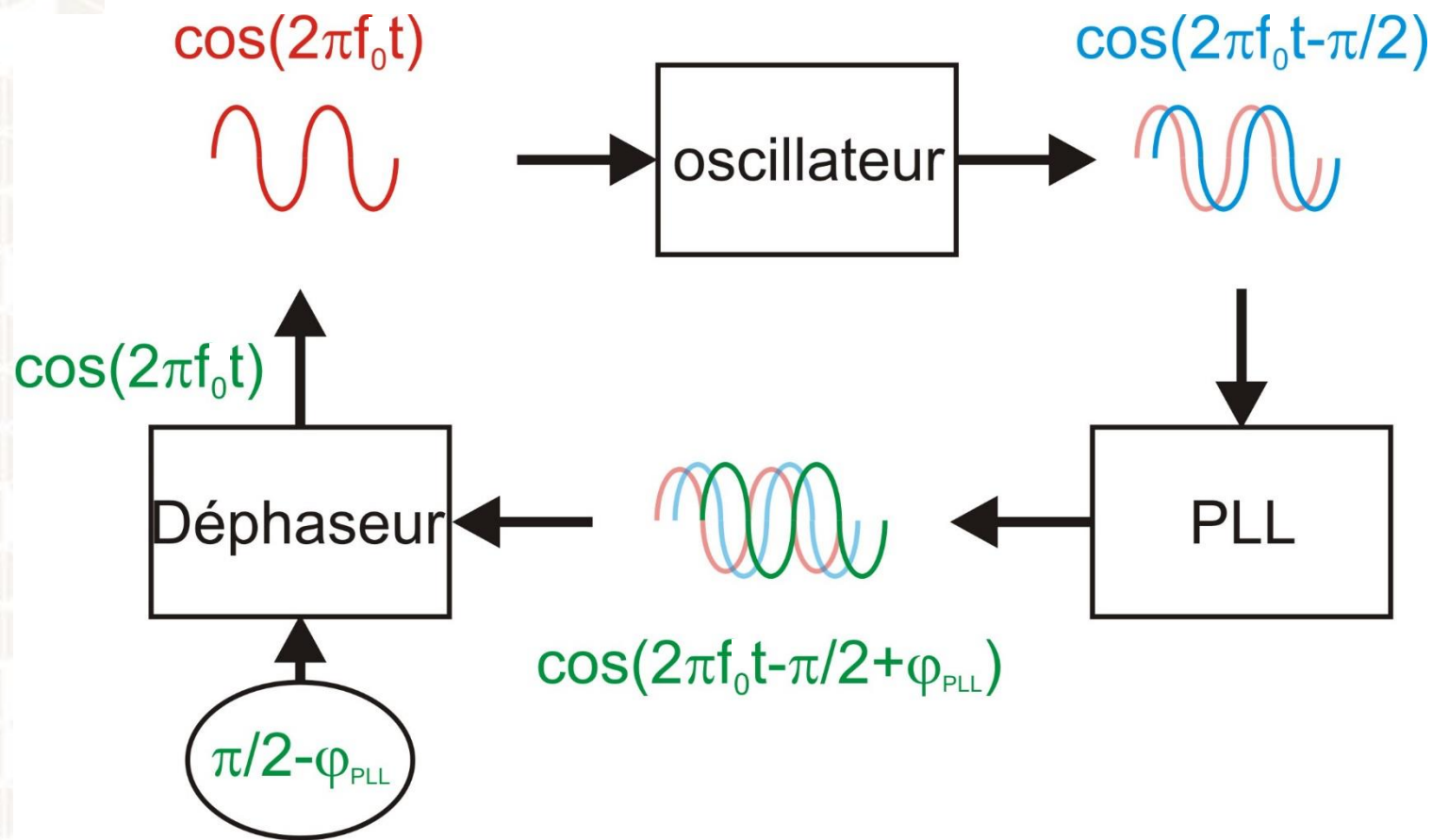



# C4- Instrumentation: PLL & amplitude feedback

- Principle for the retention of the oscillation amplitude :

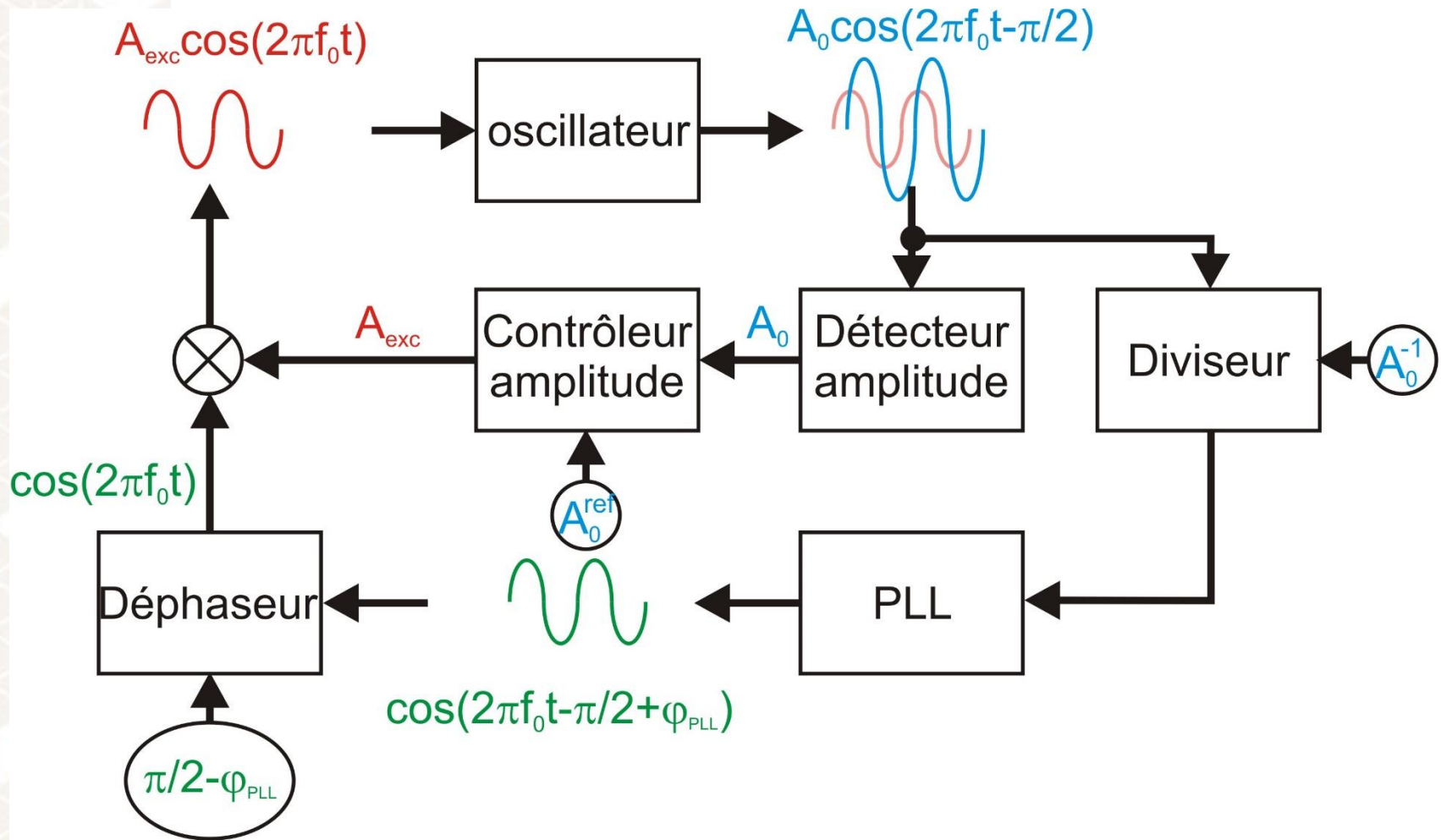

# C4- Instrumentation: PLL & amplitude feedback

- Overview of the control electronics “PLL-excitation”<sup>1</sup> type

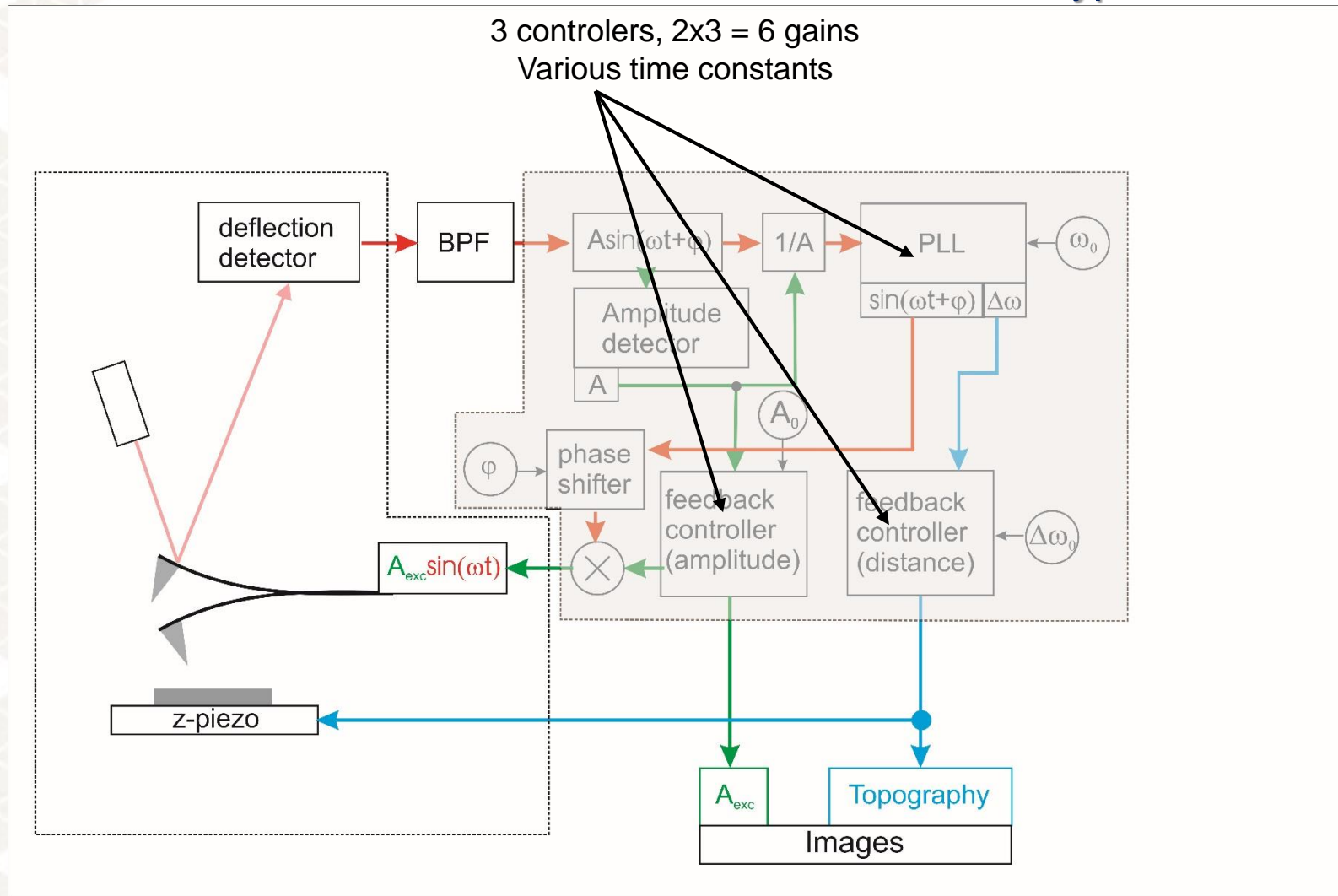

<sup>1</sup>Ch. Loppacher Appl. Phys. A 66, 215 (1998); L. Nony et al., Phys. Rev. B 74, 235439 (2006)



# Summary

# nc-AFM: keypoints

- Demodulation technic of the frequency of the cantilever around a central frequency which is the resonance frequency of the free cantilever:

$$\Delta f = \tilde{f}_0 - f_0$$

- The oscillation amplitude and the phase are kept constant : resonance values
- True non-contact method :
  - Attractive interaction regime with the surface
  - $\Delta f < 0$
- Very large z sensitivity upon accurate detection of  $\Delta f$ , which allows for large vertical and lateral contrasts (atomic resolution)

# C – Dynamic AFM in non-contact mode

1. Introduction

2. Connection with the modelization

3. Experimental illustrations

4. Instrumentation: PLL & amplitude feedback

5. Important results and current trends

# C5- Important results : high-resolution imaging of surfaces

**CaF<sub>2</sub>**

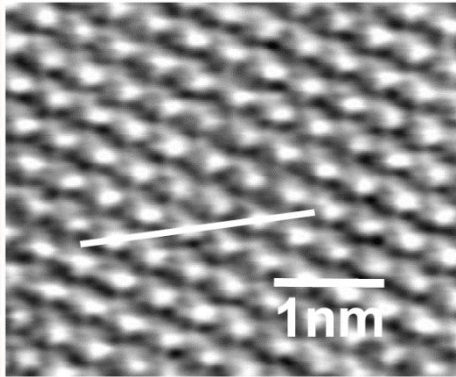

C. Barth *et al.*  
J. Phys.: Condens. Matter **13**, 2061(2001)

**NaCl islands on Cu(111)**

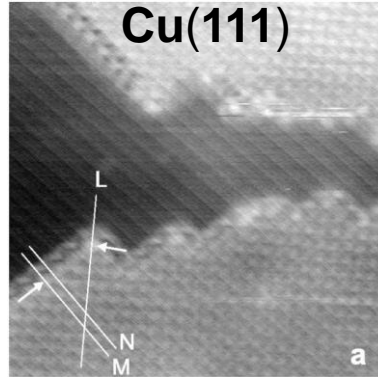

R. Bennewitz *et al.*  
Phys. Rev. B **13**, 2061 (2001)

**KBr + e<sup>-</sup>**

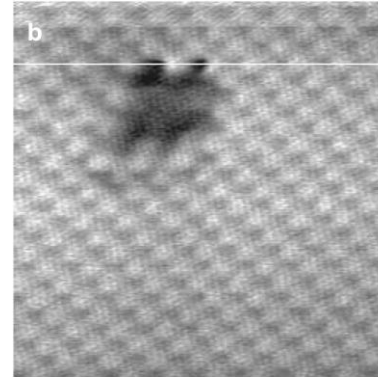

R. Bennewitz *et al.*  
Surf. Sci. **474**, L197 (2001)

**Cu(100)**

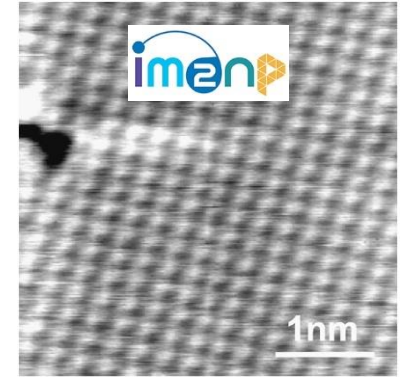

C. Loppacher *et al.*  
Phys. Rev. B **62**, 16944 (2000)

**NiO(100) @7K**

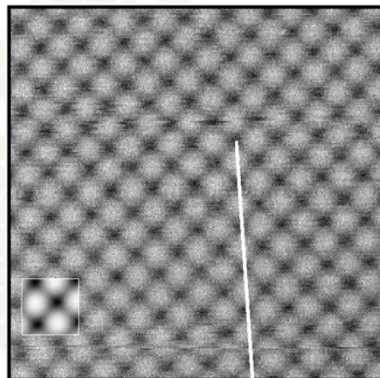

R. Hoffmann *et al.*  
Phys. Rev. B **67**, 085402 (2003)

**InAs(110) @14K**

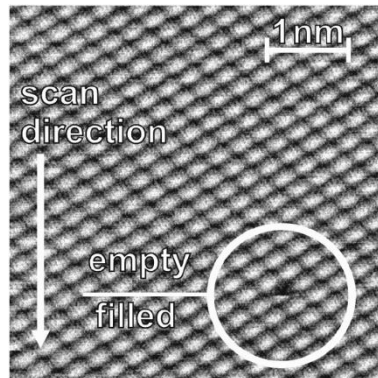

A. Schwarz *et al.*  
Phys. Rev. B **61**, 2837 (2000)

**Si(111)7x7 @RT & 7K**

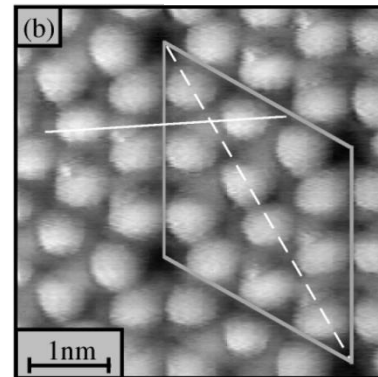

M. Lantz *et al.*  
Phys. Rev. Lett. **84**, 2642 (2000)

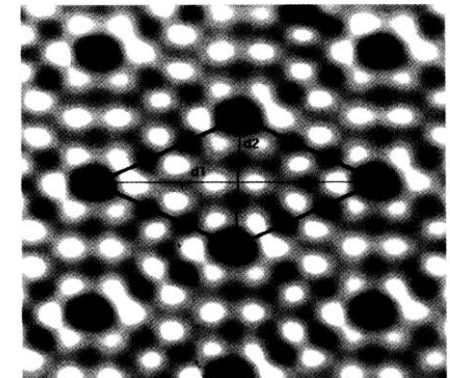

F. Giessibl  
Science **267**, 68 (1995)



# C5- Important results : high-resolution imaging of molecular assemblies adsorbed on surfaces

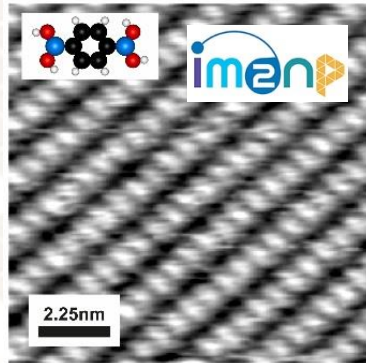

R. Pawlak *et al.*  
*J. Phys. Chem. C* **114**, 9290–9295 (2010)

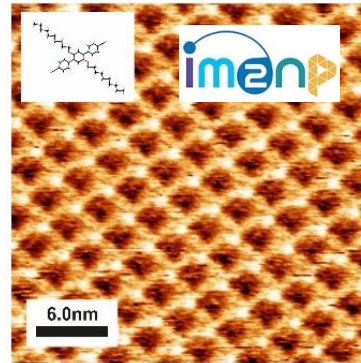

A. Amrous *et al.*  
*Adv. Mater. Interfaces* **1400414** (2014)

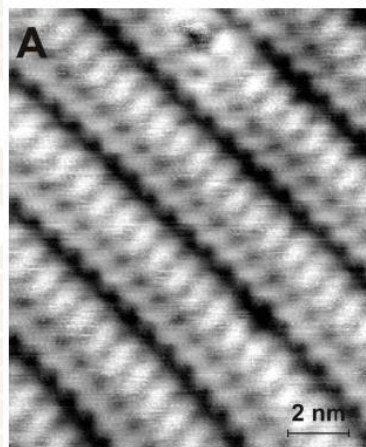

S. Maier *et al.*  
*Small* **4**, 1115–1118 (2008)

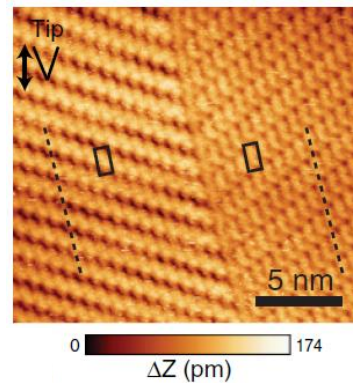

S. Kawai *et al.*  
*Phys. Rev. B* **84**, 085429 (2011)

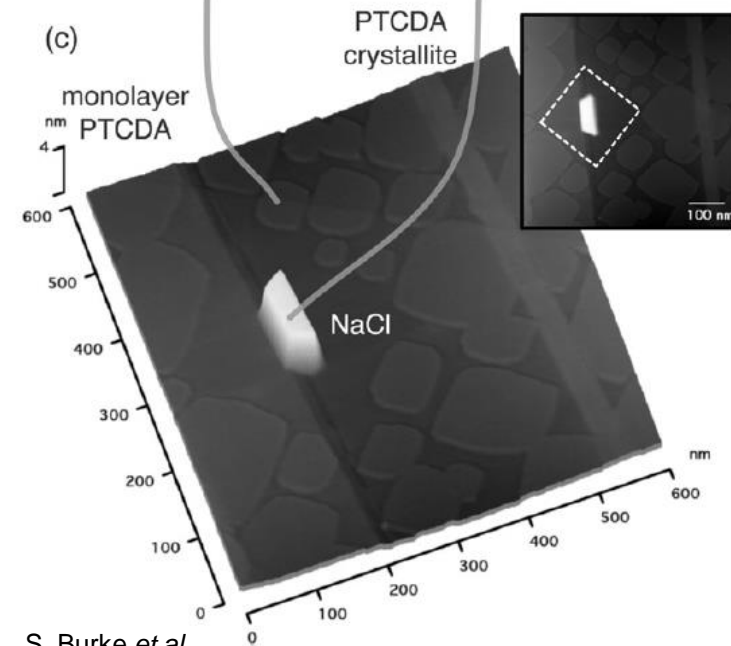
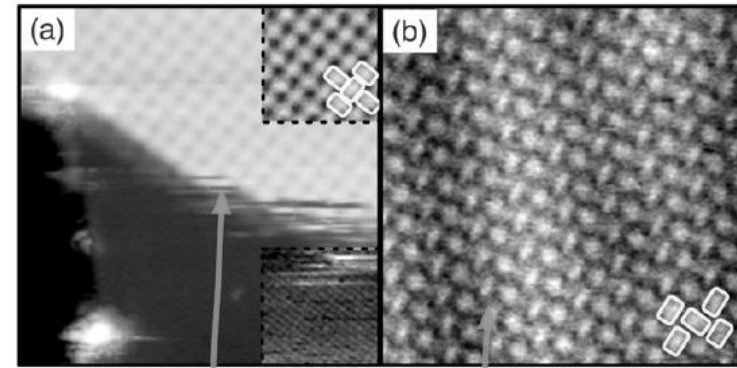

S. Burke *et al.*  
*J. Phys.: Condens. Matter* **21**, 423101 (2009)

# C5- Important results : chemical identification at the atomic scale

Atomic resolution imaging and force versus distance measurements on KBr (0 0 1) using low temperature scanning force microscopy

R. Hoffmann\*, M.A. Lantz<sup>1</sup>, H.J. Hug, P.J.A. van Schendel, P. Kappenberger, S. Martin, A. Baratoff, H.-J. Güntherodt

Applied Surface Science 188 (2002) 238–244

VOLUME 92, NUMBER 14

PHYSICAL REVIEW LETTERS

week ending  
9 APRIL 2004

## Sublattice Identification in Scanning Force Microscopy on Alkali Halide Surfaces

R. Hoffmann,<sup>1,2,\*</sup> L. N. Kantorovich,<sup>3</sup> A. Baratoff,<sup>1</sup> H. J. Hug,<sup>1,4</sup> and H.-J. Güntherodt<sup>1</sup>

<sup>1</sup>National Center of Competence in Research on Nanoscale Science, Institute of Physics, University of Basel, Klingelbergstrasse 82, CH-4056 Basel, Switzerland

<sup>2</sup>Physikalisches Institut, Universität Karlsruhe, 76128 Karlsruhe, Germany

<sup>3</sup>Department of Physics, School of Physical Sciences and Engineering, King's College London, London WC2R 2LS, United Kingdom

<sup>4</sup>Swiss Federal Laboratory for Materials Testing and Research, CH-8600 Dübendorf, Switzerland  
(Received 17 March 2003; published 9 April 2004)

nature

Vol 446 | 1 March 2007 | doi:10.1038/nature05530

LETTERS

## Chemical identification of individual surface atoms by atomic force microscopy

Yoshiaki Sugimoto<sup>1</sup>, Pablo Pou<sup>2</sup>, Masayuki Abe<sup>1,3</sup>, Pavel Jelinek<sup>4</sup>, Rubén Pérez<sup>2</sup>, Seizo Morita<sup>1</sup> & Óscar Custance<sup>1</sup>

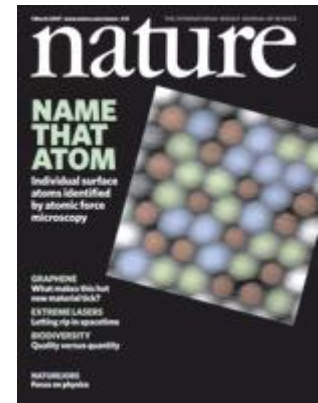

Y. Sugimoto *et al.*  
Nature **446**, 64 (2007)

# C5- Important results : manipulations of atoms, molecules and nano-objects

VOLUME 90, NUMBER 17

PHYSICAL REVIEW LETTERS

week ending  
2 MAY 2003

## Mechanical Vertical Manipulation of Selected Single Atoms by Soft Nanoindentation Using Near Contact Atomic Force Microscopy

Noriaki Oyabu,<sup>1</sup> Óscar Custance,<sup>2,\*</sup> Insook Yi,<sup>2</sup> Yasuhiro Sugawara,<sup>1,2</sup> and Seizo Morita<sup>1,2</sup>

<sup>1</sup>Graduate School of Engineering, Osaka University, 2-1 Yamada-Oka, Suita, 565-0871, Japan

<sup>2</sup>Handai Frontier Research Center (FRC), 2-1 Yamada-Oka, Suita, 565-0871, Japan

(Received 27 December 2002; published 2 May 2003)

4K

PRL 98, 106104 (2007)

PHYSICAL REVIEW LETTERS

week ending  
9 MARCH 2007

## Mechanism for Room-Temperature Single-Atom Lateral Manipulations on Semiconductors using Dynamic Force Microscopy

Yoshiaki Sugimoto,<sup>1</sup> Pavel Jelinek,<sup>2</sup> Pablo Pou,<sup>3</sup> Masayuki Abe,<sup>1,4</sup> Seizo Morita,<sup>1</sup> Ruben Perez,<sup>3</sup> and Oscar Custance<sup>1</sup>

RT

VOLUME 90, NUMBER 6

PHYSICAL REVIEW LETTERS

week ending  
14 FEBRUARY 2003

## Direct Determination of the Energy Required to Operate a Single Molecule Switch

Ch. Loppacher,<sup>1,\*</sup> M. Guggisberg,<sup>1</sup> O. Pfeiffer,<sup>1</sup> E. Meyer,<sup>1</sup> M. Bammerlin,<sup>2</sup> R. Lüthi,<sup>2</sup> R. Schlittler,<sup>2</sup>  
J. K. Gimzewski,<sup>2,†</sup> H. Tang,<sup>3</sup> and C. Joachim<sup>3</sup>

<sup>1</sup>Institute of Physics, University of Basel, Klingelbergstrasse 82, CH-4056 Basel, Switzerland

<sup>2</sup>IBM Research Division, Zurich Research Laboratory, CH-8803 Rüschlikon, Switzerland

<sup>3</sup>CEMES/CNRS, 29, rue Jeanne Marvig, 31055-Toulouse Cedex, France

(Received 11 October 2002; published 14 February 2003)



# C5- Current trends :

- Small amplitudes (50 pm, sensitivity to the SR-regime) : piezoelectric probes (tuning fork, "qPlus" Omicron, "Colibri" Specs). Usually used at low temperature:  
→ imaging + spectroscopy: quantitative interpretation (forces, charges...)
- Time resolution: high-frequency cantilevers or higher harmonics...
- High-resolution in Kelvin Probe Force Microscopy (KPFM): quantitative interpretation of the contrast...
- Time-resolved KPFM by pump-probe methods...

# C5- Current trends: quartz tuning fork<sup>1</sup>

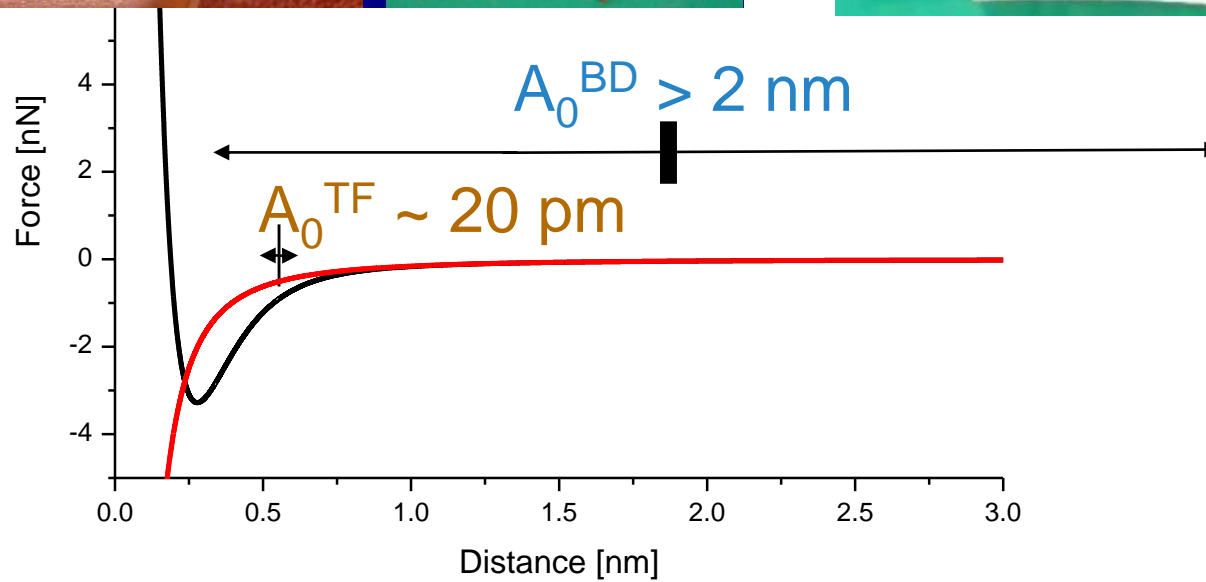
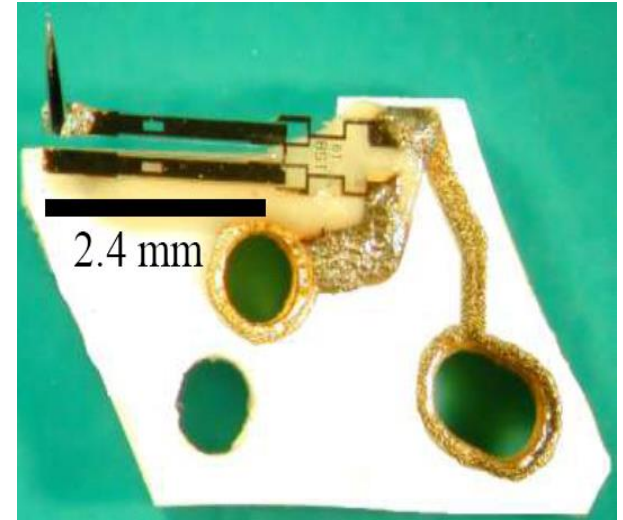
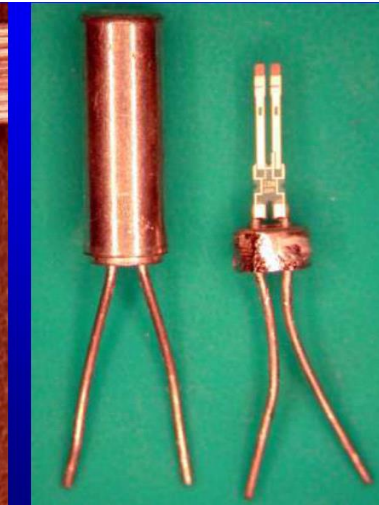

<sup>1</sup>F.Giessibl, Appl.PhysLett. 2000; Science 1995

# C5- Current trends: quartz tuning fork

## Measuring the Charge State of an Adatom with Noncontact Atomic Force Microscopy

Leo Gross,<sup>1\*</sup> Fabian Mohn,<sup>1</sup> Peter Liljeroth,<sup>1,2</sup> Jascha Repp,<sup>1,3</sup> Franz J. Giessibl,<sup>3</sup> Gerhard Meyer<sup>1</sup>  
 12 JUNE 2009 VOL 324 SCIENCE

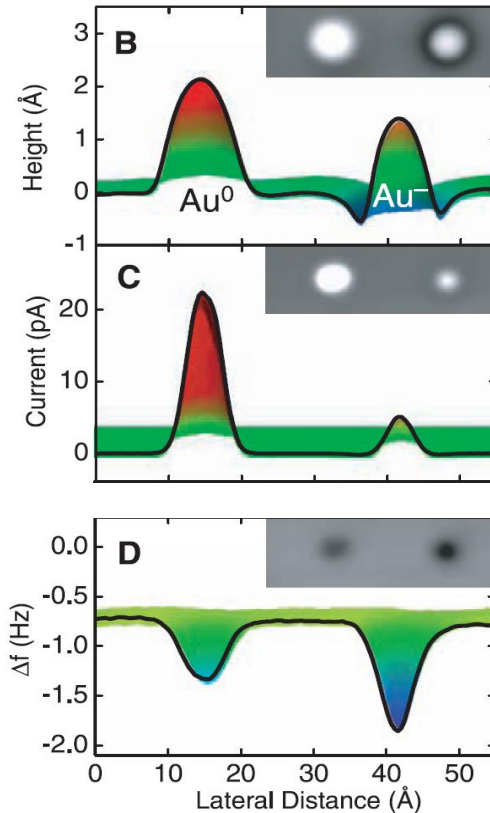
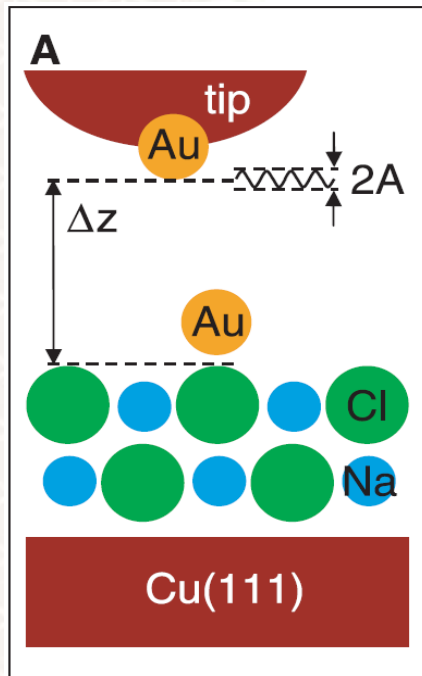

**Topographic sensitivity to the charge state on the atomic scale**

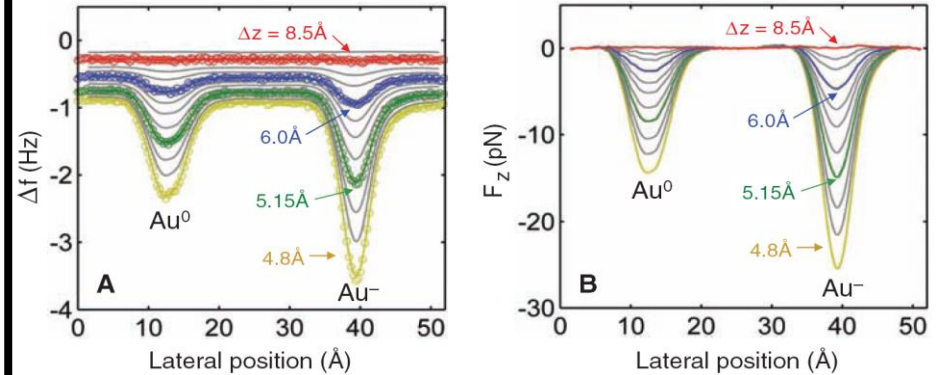

**Spectroscopic sensitivity to the charge state on the atomic scale**

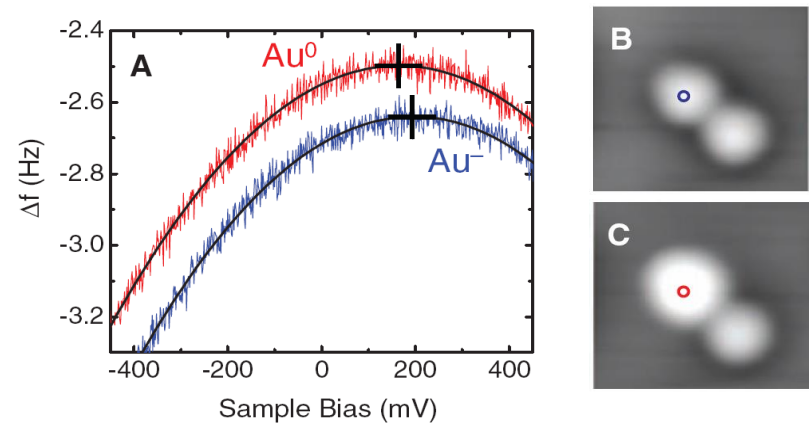

# C5- Current trends: quartz tuning fork

## The Chemical Structure of a Molecule Resolved by Atomic Force Microscopy

Leo Gross,<sup>1\*</sup> Fabian Mohn,<sup>1</sup> Nikolaj Moll,<sup>1</sup> Peter Liljeroth,<sup>1,2</sup> Gerhard Meyer<sup>1</sup>

28 AUGUST 2009 VOL 325 SCIENCE

### Pentacene / Cu(111)

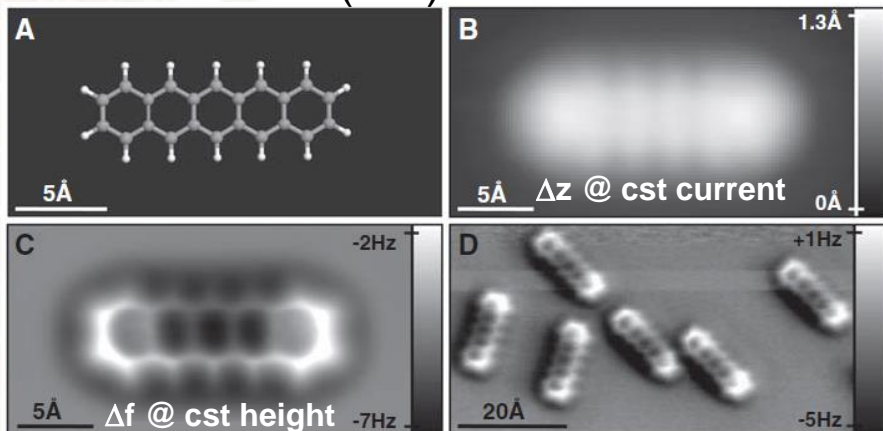

### Pentacene / 2ML NaCl(001) / Cu(111)

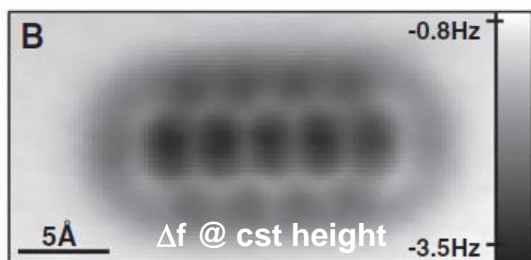

## Organic structure determination using atomic-resolution scanning probe microscopy

Leo Gross<sup>1\*</sup>, Fabian Mohn<sup>1</sup>, Nikolaj Moll<sup>1</sup>, Gerhard Meyer<sup>1</sup>, Rainer Ebel<sup>2</sup>, Wael M. Abdel-Mageed<sup>2,3</sup> and Marcel Jaspars<sup>2</sup>

nature  
chemistry

ARTICLES

PUBLISHED ONLINE: 1 AUGUST 2010 | DOI: 10.1038/NCHEM.765

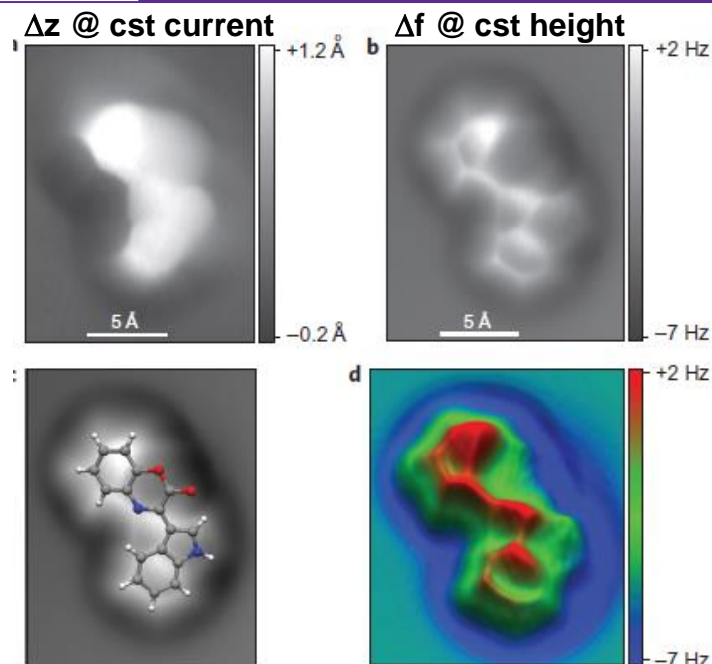





Institut **M**atériaux **M**icroélectronique **N**anosciences **P**rovence

# Thanks for your attention

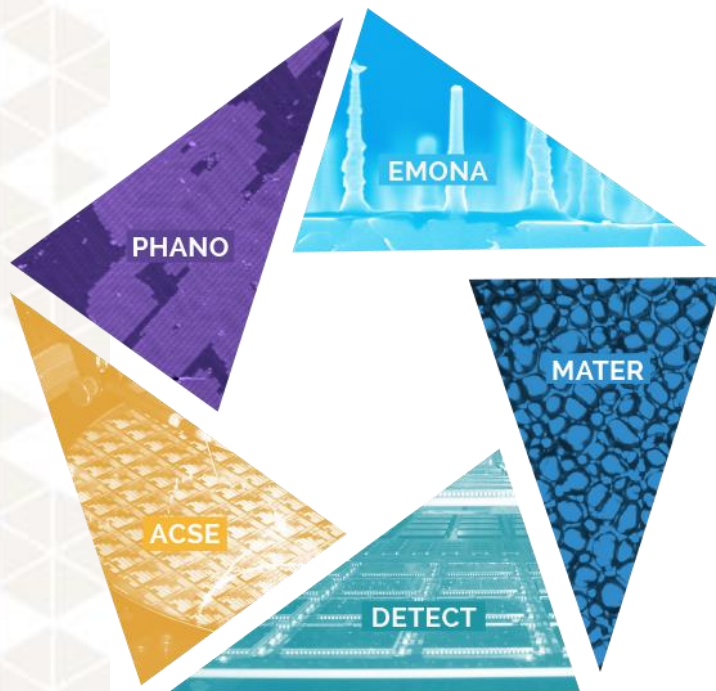

**Relier le fondamental  
aux applications  
dans nos domaines  
d'expertise**

[www.im2np.fr](http://www.im2np.fr)

