



HAL
open science

Neural Mechanisms of Reflex Reversal in Coxo-Basipodite Depressor Motor Neurons of the Crayfish

Daniel Cattaert, Didier Le Ray

► **To cite this version:**

Daniel Cattaert, Didier Le Ray. Neural Mechanisms of Reflex Reversal in Coxo-Basipodite Depressor Motor Neurons of the Crayfish. *Journal of Neurophysiology*, 1997, 77, <10.1152/jn.1997.77.4.1963>. <hal-02347375>

HAL Id: hal-02347375

<https://hal.science/hal-02347375v1>

Submitted on 7 Nov 2019

HAL is a multi-disciplinary open access archive for the deposit and dissemination of scientific research documents, whether they are published or not. The documents may come from teaching and research institutions in France or abroad, or from public or private research centers.

L'archive ouverte pluridisciplinaire **HAL**, est destinée au dépôt et à la diffusion de documents scientifiques de niveau recherche, publiés ou non, émanant des établissements d'enseignement et de recherche français ou étrangers, des laboratoires publics ou privés.



HAL Authorization

NEURAL MECHANISMS OF REFLEX REVERSAL IN COXO-
BASIPODITE DEPRESSOR MOTOR NEURONS OF THE CRAYFISH.

Didier LE RAY, and Daniel CATTART

Laboratoire de Neurobiologie et Mouvements, CNRS, 31 chemin Joseph
Aiguier, Marseille, France.

Running title: Reflex reversal in crayfish

Correspondence: D. LE RAY, Laboratoire Neurobiologie et Mouvements,
CNRS, 31 chemin Joseph Aiguier, 13402 Marseille cedex 20, FRANCE.

Tel: +33 - 04 91 16 43 45.

Fax: +33 - 04 91 77 50 84

E-mail: leray@lnf.cnrs-mrs.fr

SUMMARY AND CONCLUSIONS

- 1- In the crayfish, the coxo-basipodite chordotonal organ (CBCO) senses the vertical movements of the limb. The *in vitro* preparation of the 5th thoracic ganglion, with the CBCO attached by its sensory nerve, was used to investigate the synaptic connections made by CBCO afferent neurons with basal limb motor neurons (MNs). In tonically active *in vitro* preparation, stretching movements of the CBCO (corresponding to downward movements of the leg) results in the activation of levator MNs, whereas releasing the CBCO results in the activation of depressor (Dep) MNs. These reflexes oppose the imposed movement and are therefore termed resistance reflexes. By contrast during fictive locomotion, the reflexes are reversed and are termed assistance reflexes.
- 2- Intracellular recordings from all twelve Dep MNs were performed in single experiments in which steps and ramps were applied to the CBCO. These experiments allowed us to characterize three types of Dep MNs according to their response to CBCO imposed movements : 1) 8 of the 12 Dep MNs are resistance MNs that are depolarized during releasing of the CBCO and are monosynaptically connected to release sensitive CBCO neurons; 2) one (aDep) is an assistance MN that is depolarized during stretching of the CBCO and is monosynaptically connected to velocity coding stretch sensitive CBCO neurons (but not position coding CBCO neurons); 3) in our experimental conditions, three Dep MNs do not display any response to CBCO stretching or releasing.
- 3- Assistance reflex interneurons (ARINs) were also recorded in this study, which are involved in polysynaptic assistance reflexes recorded from depressor MNs. During low velocity ($0.05 \text{ mm}\cdot\text{s}^{-1}$) ramp stretching movements imposed on the CBCO, ARINs display compound EPSPs. During high velocity ($0.25 \text{ mm}\cdot\text{s}^{-1}$) ramp stretching movements imposed to the CBCO a mixed excitatory and inhibitory response is recorded in ARINs.

- 4- Whereas a single MN generally receives monosynaptic EPSPs from 3 to 6 CBCO neurons (mean: 4), ARINs receive monosynaptic EPSPs from up to eight CBCO neurons. Moreover, only velocity-coding stretch sensitive CBCO neurons seem to connect ARINs as in the case of the aDep. In addition, ARINs receive disynaptic inhibitory phasic inputs from stretch sensitive CBCO afferents.
- 5- Injection of a depolarizing current pulse into ARINs elicits a two phase electrical response consisting of a fast transient voltage-dependent depolarization, and the classical capacitive response. The transient occurs for current intensities higher than +3 nA. Its peak amplitude increases and its time to peak decreases with increasing current intensity.
- 6- ARINs are likely to be directly connected to Dep MNs. The synaptic delay between these nonspiking ARINs and Dep MNs is short (2 ms) and constant. Moreover, the amplitude of the EPSP increases with increased current pulse intensity injected in ARIN. The maximum amplitude EPSP may reach 5 mV.
- 7- The dual sensory control (excitatory and inhibitory) makes it likely that ARIN represents a key element in reflex reversal control.

INTRODUCTION

In walking animals, sensory receptors are involved in the adaptation of posture and ongoing movements to external perturbations. In Vertebrates, the neural circuitry underlying stretch reflex and more complex spinal reflexes, has been extensively studied. Integration of sensory information is subject to considerable modification when involved in centrally programmed movements such as locomotion in both Vertebrates (Forssberg et al. 1976; Grillner 1975; Rossignol et al. 1981, 1988), and invertebrates (Bässler 1986).

However, compared to the complex organization of Vertebrate sensory-motor pathways, Arthropods are good models to study sensory-motor interactions, due to the reduced number of neurons involved. Therefore, a lot of studies on sensory-motor control have been carried out on insects (Bässler 1993; Burrows 1992) and on crustaceans (Bush 1962; Cannone and Bush 1980; Cattaert et al. 1992; El Manira et al. 1991a,b; Wiens and Gerstein 1976). In Arthropods, chordotonal organs are a principal source of proprioceptive information from limb joints (Mill 1976). They mediate intrajoint resistance reflexes where stretch or release of the receptor excites the motor neurons (MNs) innervating muscles that resist the movement of the joint (Bush 1965). The resistance reflex is a negative feedback reflex, as is the vertebrate stretch reflex, mediated by direct connections between primary sensory afferents and MNs (El Manira et al. 1991a; Skorupski and Hustert 1991). Stretch receptors are also involved in the control of rhythmic motor patterns (Clarac 1991) by providing phasic inputs to the central motor network.

The *in vitro* preparation of the thoracic ganglia of the crayfish provides a good model to study sensory-motor interactions, involved in motor control of leg movements. Generally, this preparation produces a spontaneous tonic motor activity, in which the "classical" resistance reflexes are elicited in response to stretch and release of the coxo-basipodite

chordotonal organ (CBCO). The CBCO is an elastic strand in which about 40 sensory cells are inserted. The CBCO neurons can be divided into two groups: 20 stretch-sensitive and 20 release-sensitive cells, the axons of which compose the CBCO nerve and project to the ipsilateral thoracic hemiganglion. The CB joint allows upward and downward movements of the leg and is controlled by levator (Lev) and depressor (Dep) MNs (El Manira et al. 1991a). Within the hemiganglion, sensory afferent terminals from the CBCO connect with Lev and Dep MNs (20 and 12 neurons respectively: Bévengut et al. 1996). These connections are responsible for reflex responses: Stretching the CBCO activates Lev MNs while releasing the CBCO activates Dep MNs. However, as is the case for other receptors, these negative feedback reflexes vary in a phase-dependent way during centrally programmed rhythmic activities (El Manira et al. 1991b; Skorupski et al. 1992). The reflex may even reverse in sign, so that the reflex assists the ongoing movement. This "assistance reflex" has been described in many species (Bässler 1976; DiCaprio and Clarac 1981; Forssberg et al. 1975; Rossignol and Drew 1986; Skorupski and Sillar 1986). The neural mechanisms underlying the phase-dependent modulation and reversal of reflexes during voluntary movements remain unclear in any species.

Nevertheless, this requires that the central network is able to select the suitable sensory inputs and direct them towards the appropriate MNs. At least three levels in the reflex pathway have to be considered in the analysis of this phenomenon. The first level concerns the sensory input that can be blocked by presynaptic inhibition (Baev and Kostyuk 1982; Boyan 1988; Cattaert et al. 1992; Eccles et al. 1962; Kennedy et al. 1974). This blockade of sensory inflow is essential to block the monosynaptic pathway from primary afferents to MNs. However, at least some sensory inputs may be not blocked by presynaptic inhibition in order to allow the polysynaptic assistance reflex. The blockade may be limited to some particular primary afferents or some branches of each. The inputs not subjected to presynaptic inhibition

would use alternative interneuronal pathways, which represent the second level. This second level has been analyzed in different preparations (Jankowska et al. 1967; Reichert and Rowell 1985; Sillar and Roberts 1988). A third level concerns the MN pool itself where gating could take place (Lund et al. 1981).

In this study, we focused on the Dep MN pool, because of its accessibility and its small number of well localized neurons, to investigate the last two levels. We have established a wiring diagram based upon systematic intracellular recordings from all twelve Dep MNs. The Dep MN pool appears to be constituted of three types of MNs with respect to their direct connections with CBCO afferents: resistance unit, assistance unit and not connected to CBCO. Assistance reflex interneurons (ARINs) are also described which are involved in the disynaptic assistance reflex pathway. These INs are recruited by velocity sensitive CBCO afferents. Our results indicate that the recruitment of the disynaptic reflex pathway is controlled by inhibitory sensory inputs that prevent ARIN from activating assistance reflexes in quiescent central network. Finally, both pathways coexist and MN reflex responses observed during locomotion may be the result of a centrally modulated balance between assisting and resisting influences.

METHODS

Results are based on 83 intracellular recordings from MNs and INs (24 experiments) that were performed on adult male and female crayfish, *Procambarus clarkii* and *Pacifastacus leniusculus*. Animals were maintained in aquarium at 17-18°C and fed once a week.

The *in vitro* preparation consisted of the last three thoracic ganglia, the two first abdominal ganglia and the motor nerves innervating the two proximal joints of the 5th leg (the two sets of

antagonistic motor nerves Promotor/Remotor and Levator/Depressor, Fig. 1A). The CBCO was dissected out together with its sensory nerve, which encodes the vertical movements of the leg. The preparation was pinned down dorsal side up in a Sylgard-covered Petri dish and superfused with oxygenated crayfish saline (NaCl: 195 mM, KCl: 5 mM, CaCl₂: 13 mM, MgCl₂: 2 mM). In some experiments, divalent cation concentration was raised (CaCl₂: 34 mM, MgCl₂: 6.4 mM) with the sodium concentration reduced accordingly. Saline solutions were buffered with 3 mM HEPES and pH adjusted at 7.7 at 15°C. In some experiments (n=5), oxotremorine 10⁻⁵ M (oxo) was added in normal saline in order to induce fictive walking activity. However, since this study aimed to describe the wiring of the sensory-motor pathway, and due to the great variability of neuronal discharge induced by oxo, all intracellular responses presented have been recorded in the absence of oxo.

Monopolar extracellular recordings and nerve stimulations were performed using platinum pin electrodes contacting the nerves, isolated from the bath with Vaseline, and directed to a 4-channel differential AC amplifier (A-M System). Single and paired intracellular recordings from MNs and INs were made with thin-walled glass micro-electrodes filled with a potassium chloride solution (3M) and having a 25-30 MΩ resistance. The signals were amplified by an Axoclamp 2B (Axon Instruments). Intracellular current pulses, delivered through the recording micro-electrodes, and nerve stimulations were controlled by an eight channel digital stimulator (A.M.P.I). A home-made electro-mechanical puller was coupled to the distal end of the CBCO strand attached to provide mechanical stimuli. These were characterized by cyclic stretch-release of the CBCO strand, according to a sinusoidal or a ramp protocol (i.e. succession of ramps and steps which permitted separation of movement- and position-related responses). Sinusoidal and ramp stimulations were performed from the most relaxed position of the CBCO strand. Total movement amplitude was one third of the most relaxed CBCO strand length (i.e. 1 - 1.8 mm). All signals (physiological recordings and

movement control voltage traces) were monitored on an 8-channel oscilloscope, a 4-channel digital oscilloscope (Yokogawa DL 1200) and stored on DAT tapes (BioLogics digital tape recorder) and digitized on PC-based computer through an A/D interface (Cambridge Electronic Device, CED 1401PLUS). Intracellular and extracellular recordings were digitized at 5-10 kHz and written to disk. Signals were analyzed using the CED programs SPIKE2 for spike sorting and SIGAVG for spike triggered averaging.

Dep MNs were identified after penetration with a micro-electrode by the following procedure: i) The antidromic spike evoked by electrical stimulation of its axon in the identified nerve could be recorded by the micro-electrode. ii) There was a one to one correlation between MN intracellular spikes and motor nerve extracellular spikes during spontaneous activity. iii) Intracellular injection of depolarizing current into the MN evoked orthodromic spikes correlated one to one with extracellular spikes recorded in the corresponding motor nerve.

ARINs were identified by the following criteria: i) Electrical stimulation of any motor or sensory nerve of the leg never evoked any antidromic spikes in the intracellular recording. ii) Injection of depolarizing current into the ARIN evoked an excitatory response of Dep MNs, recorded extracellularly from the Dep motor nerve and/or intracellularly from Dep MN. iii) Stretching movement applied to the CBCO strand evoked a dual depolarizing and hyperpolarizing response in the intracellularly recorded ARIN. Intracellular recordings from ARINs were performed in 6 experiments. However, paired recordings from ARIN and Dep MN were difficult to perform and only two successful experiments were used in this study.

RESULTS

CBCO-induced reflex activities.

In quiescent preparations superfused with normal saline, we observed that the motor nerves exhibited low frequency tonic discharge. During sinusoidal stimulation of the CBCO strand (Fig. 1B), Dep and Lev nerves produced a resistance reflex response: stretching the CBCO strand (that is analogous to the depression of the leg) elicited the activation of one to three distinct units in the Lev nerve in a given burst whereas releasing the CBCO strand (that mimics upward leg movements) induced the firing of two to four units in the Dep nerve.

In preparations superfused with oxo, the global activity of the preparation is increased, MNs and INs being more excitable (Cattaert et al. 1995). The antagonistic Lev and Dep nerves fire bursts of action potential in rhythmical alternation. In these conditions, a similar stimulation of the CBCO (Fig. 1C) elicited an assistance reflex, characterized by the Dep MNs being excited during stretching of the CBCO strand, and Lev MNs being activated during releasing of the CBCO strand. On the Lev neurogram, two units (one with a large extracellular spike and one with a smaller spike) were added to the three units observed in the tonic preparation, and fired with a higher frequency during the releasing phase of the CBCO mechanical stimulation. In the Dep nerve, eight different units fired at high frequency during stretching of the CBCO strand (three large amplitude units and one medium amplitude unit were added to the four units that were observed in the tonic preparation). The total number of MN units activated in assistance reflex is however variable (generally 3-5 Lev and 4-9 Dep MNs), depending upon the state of the preparation. Thus, oxo not only induced rhythmic activity, but also caused the reversal of the reflex response. In the Dep MN pool, this consisted of (i) a reversal of the reflex response of individual units that, in quiescent preparation, were activated by movements in a resistance manner and (ii) the appearance of an assistance reflex response in units previously silent.

Evidence for a monosynaptic assistance reflex.

Each hemi-ganglion has been previously reported to contain 12 distinct Dep MNs that can be identified according to the size and shape of their extracellular action potential, and their conduction velocity (Bévengut et al. 1996). Fig. 2 shows intracellular recordings of these 12 MNs that were impaled successively in the same experiment. Mechanical stimulation of the CBCO elicited two types of responses from the Dep MNs in a quiescent preparation: either a resistance reflex (n=8) or an assistance reflex (n=1); 3 Dep MNs didn't respond to the mechanical stimulation applied to the CBCO. The resistance reflex observed in 8 MNs was characterized by membrane potential depolarizations of 0.5 to 4 mV, resulting of the summation of excitatory post-synaptic potentials (EPSPs) during the release of the CBCO strand. Generally, the MNs that received the larger EPSPs were responsible for resistance responses recorded extracellularly. However, in some quiet preparations, most of the MNs were hyperpolarized and their membrane potential kept under threshold for spiking (Fig. 2A) Even though each of these 8 MNs displayed a different response to CBCO strand release, there was nevertheless a clear correlation between movement phases and membrane potential depolarizations (see vertical dotted lines in Fig. 2A). Traces in Fig. 4B were obtained by averaging the Dep MN responses to all stretching or releasing ramps from 4 cycles of CBCO mechanical stimulation. In each case, starting membrane potentials were offset. The 8 resistance MNs exhibited depolarizations (mean values from 0.4 to 1.4 mV) during the release of the CBCO strand (*right column* in Fig. 2B). Each compound EPSP could be related to release sensitive CBCO afferent (according to the protocol used in Fig. 5A). Moreover, it is noticeable that most of the resistance Dep MNs received weak phasic depolarizing inputs

(0.05 to 0.3 mV) during the stretching movements applied to the CBCO strand (*left column* in Fig. 2B). However, these weak assistance responses disappeared in the presence of high divalent cation concentration; therefore, these depolarizations had a polysynaptic origin (Berry and Pentreath 1976).

Finally, one of the Dep MN was characterized by an assistance reflex response to the stimulation of the chordotonal organ: depolarizations (from 1.2 to 3 mV) were observed during stretching of the CBCO strand (*bottom trace* in Fig. 2A). The averaged trace in Fig. 2B shows a mean value of 1.5 mV. When perfusing the preparation with high Ca^{++} and high Mg^{++} , the CBCO stimulation was still capable of producing the assistance reflex response in this Dep MN (*upper trace* in Fig. 3A), whereas in the other Dep MNs, only the resistance response was maintained (*middle trace* on Fig. 3A). Therefore, the EPSPs observed in the « assistance » Dep MN (aDep MN) were elicited by monosynaptic connections from a mean of 4 stretch-sensitive CBCO afferents (number calculated according to the protocol used in Fig. 5A). This aDep MN displayed up to 10 mV depolarizations in response to CBCO stretching movements whereas no significant variation of its membrane potential was observed during the other phases of imposed movement.

The response of the a Dep MN was speed-dependent, as shown on Fig. 3B. When continuous ramp stimuli (without any steps) were applied, the aDep MN exhibited membrane potential depolarizations (about 4.5 mV) due to summations of EPSPs during stretching movements. A five fold increase of the stretch velocity resulted in a two fold increase of the stretch-induced depolarization ($\Delta V_2 = 12$ mV against $\Delta V_1 = 4.7$ mV, ΔV_1 and ΔV_2 being measured for an equal amplitude of movements). It appeared then that the amplitude of the depolarizing response was closely related to the speed of the movement.

Interneurone mediating polysynaptic assistance response.

We have investigated a possible mechanism by which Dep MNs may switch from a resistance reflex to an assistance reflex in response to CBCO stimulation during fictive locomotion, namely an interneuronal stage fulfilling two criteria:

- (i) it receives excitation from stretch-sensitive CBCO afferents;
- (ii) it is excitatory to Dep MNs.

Such an assistance reflex interneuron (ARIN) has been found in 6 preparations in the neuropilar region of Dep MNs, in a slightly more ventral position. Its main features and its relations with one post-synaptic Dep MN are illustrated in Figs. 4 to 8. To date, our results suggest that there may be only one such ARIN per MN pool in the hemi-ganglion.

In a quiescent preparation perfused with normal saline, the ARIN responded in an opposite way to resistance Dep MNs. ARIN exhibited subthreshold depolarizing events during stretch movements applied to the CBCO (Fig. 4A). Insert 4B presents average traces (n = 36 ramps) of both neuron reflex responses. ARIN received weak hyperpolarizing influences during the release of the CBCO strand while the Dep MN responded by a large depolarization (*upper traces*). In contrast, during the stretch of the CBCO strand (*lower traces*), the Dep MN exhibited a very weak depolarization (< 0.1 mV) while ARIN exhibited a large depolarizing response (the mean amplitude of which decreased along the ramp). By increasing the velocity of the mechanical stimulation applied to the CBCO (Fig. 4C), the responses of both neurons were emphasized. ARIN especially exhibited a compound hyperpolarization (summation of inhibitory post-synaptic potentials) upon termination of each of the small successive high velocity stretching movements. This observation suggests that the compound IPSP recorded in ARIN originates from velocity sensitive CBCO afferents, responding during and immediately following stretch movements. Fig. 4 insert D shows averaged traces obtained from 36 high

velocity ramps. It appears that the hyperpolarization of ARIN during release movements increased with the velocity of the release ramp as did the depolarizing resistance response of Dep MN (*upper traces*, Fig. 4D cf. B). The increase in stimulus velocity unmasked the hyperpolarizing influence that ARIN received during the stretching phase (*lower traces*, Fig. 4C, D) which may explain the declining depolarization recorded during slow stretch movements (Fig. 4 insert B, *lower traces*). The Dep MN also exhibited with this stretch velocity a greater depolarizing response (1 or 2 mV), which appeared with a greater latency than its release-related response, suggesting a polysynaptic origin. The presence of both responses suggests that the MN reflex response to CBCO stimulation is the result of the balance between monosynaptic and polysynaptic inputs.

In order to characterize the sensory units connected to each intracellularly recorded neuron, we analyzed the extracellular action potentials recorded from the CBCO nerve during slow stepwise movements (presented in Fig. 4A) imposed on the CBCO strand (Fig. 5A and 5B from the same preparation). From three to six CBCO afferents (mean: 4; n=71), active during CBCO release, evoked a time locked EPSP (delays from 4 to 6 ms, amplitudes from 7 to 12 mV) in Dep MNs (Fig. 5A). The ARIN was found to receive excitatory inputs from about eight stretch sensitive CBCO units that evoked EPSPs having a 6 to 14 mV amplitude with a 2.5 to 7 ms delay (Fig. 5B). The delays are consistent with conduction delays observed by El Manira et al. (1991a). The stability (amplitude and delay) of each EPSP evoked in ARIN and Dep MN makes it likely that they were monosynaptic. However, large differences exist between CBCO units that elicit an EPSP in the Dep MN or in the ARIN: some display large amplitude extracellular spikes, while others display very small extracellular spikes. Moreover, the large range of delays between sensory extracellular spikes and EPSPs recorded from the ARIN and Dep MN, which are not correlated to the amplitude of extracellular spikes, would

indicate a large heterogeneity in diameters, and hence conduction velocities of CBCO fibers that connect with the ARIN or Dep MNs.

The temporal occurrence of each of the EPSPs produced in both post-synaptic neurons was analyzed by triggering on all the CBCO nerve extracellular spikes eliciting a response in the impaled neurons, irrespective of spike size and EPSP latency. This procedure allowed us to measure the amplitude of individual EPSPs. As shown on Figs. 6A and B, the EPSPs induced by the CBCO units were larger during the movement phases of the CBCO stimulation (respectively releasing movements for the Dep MN and stretching movements for the ARIN). This corroborates the results illustrated in Fig. 4A and suggests that the larger EPSPs are locked more closely to movement sensitive than to position sensitive afferents.

Characterization of ARIN response to injection of depolarizing currents.

Although nonspiking in the conventional sense, depolarization of ARIN nevertheless revealed active membrane properties: As shown on Fig. 7A, injection of increasing depolarizing current pulses (+1 to +22 nA by steps of 1 nA, duration 35 ms) caused a biphasic variation of ARIN membrane potential. An early transient phase of depolarization developed for current intensities above +3 nA and peaked 15.1 ms (+4 nA stimulation) to 3.5 ms (stimulation above +15 nA) after the pulse onset. The time to peak of this transient phase decreased with increasing current (see graph 1 on Fig. 7B). The second depolarizing phase, that developed from the lowest currents, is the commonly observed passive response due to capacitive charge of the membrane (no reliable value could be measured from +16 nA). The membrane potential of this second phase varied in nearly the same parabolic manner for positive currents as that of the transient phase (see graph 2 of Fig. 7B).

Although the second depolarizing phase is commonly observed, the first, transient phase, is unusual and is likely to be different from a simple Na^+ spike since (i) it is a graded depolarizing response, and (ii) its time to peak decreases with increasing currents.

Synaptic relation between ARIN and Dep MNs.

Since ARINs are not spiking neurons (positive current injection never triggered any spike in the ARIN, Fig. 7A), the synaptic relation between ARINs and Dep MNs was studied with the following protocol (Fig. 8A): positive current pulses which were injected intracellularly into the ARIN elicited EPSPs in the post-synaptic Dep MN. Fig. 8B1 presents an overdraw of the averaged EPSP recorded for each current pulse intensity. The post-synaptic EPSP developed gradually for intensities of current pulses above +4 nA and reached its maximum value (about 5 mV) with current intensities above +15 nA. The amplitude of the MN EPSP as a function of the peak of the ARIN transient shows a sigmoidal relation (see graph 2 on Fig. 8B). The EPSP appeared for transient amplitudes above 2.8 mV and was maximum for transient amplitudes larger than 26 mV. As the current pulse intensity increased, the latency of the MN EPSP decreased from 9 to 5.4 ms as shown on Fig. 8B1. The synaptic delay between the two cells is expressed in graph 3 on Fig. 8B: the relation between the time to peak of the transient in ARIN and the latency of the EPSP development is linear ($y = ax + b$, with $a = 1.08 \pm 0.05$, and $b = 1.67 \pm 0.03$ being the synaptic delay) indicating a constant delay. The fitting of linear regression is excellent ($r = 0.99$) in the whole range of current intensities and gives a 1.67 ms synaptic delay.

DISCUSSION

The monosynaptic assistance reflex.

In many different preparations, negative feedback responses (resistance reflex) have been demonstrated to be mediated largely by monosynaptic sensory-motor pathways. In Vertebrates, the direct connection that Ia afferents have with homonymous MNs produces the "stretch reflex" which opposes to the imposed movement that provoked it (Henneman and Mendell 1981). In invertebrates resistance reflexes are also mediated by monosynaptic connections between sensory afferents and MNs, as shown in the crayfish walking system (El Manira et al. 1991a) as well as in the locust flight network (Burrows 1975). Here we provide evidence for a monosynaptic sensory-motor assisting pathway to the Dep MN pool (Fig. 3), in the walking network of crayfish. Our experiments showed the existence of different MN reflex responses to the same CBCO stimulation. In the fifth thoracic ganglion of the crayfish, the characterization of all the monosynaptic reflex responses of a specific pool of MNs to a complex movement could be performed due to the small number of neurons (only 12 Dep MNs - Fig. 2). Generally, the response observed was the "classical" resistance reflex but it was always possible to identify one Dep MN that presented a non-typical monosynaptic assisting response to the CBCO stimulation. Previous studies on the fourth thoracic ganglion have described such a positive feedback reflex involving TCMRO and remotor MNs (Skorupski 1992). The T-fiber of the TCMRO, an muscle receptor organ that controls the antero-posterior movements of the leg, connects monosynaptically with promotor MNs to elicit a resistance reflex response during the stretch of the organ. It has been shown that this stretch sensitive fiber was also able to excite directly a specific pool of remotor MNs, evoking then a

monosynaptic assistance response. The functional significance of this connection remains uncertain. Nevertheless, at least two non-exclusive hypotheses can be proposed:

- (1) MN pools are heterogeneous and could be considered as sets of more or less independently driven MNs. Within a pool, each set could be activated or inactivated by the central network, depending upon the required behavioral situation. Such differential aminergic control of MN sets has recently been demonstrated to exist in the promotor and remotor MN pools of the crayfish (Skorupski 1996). In this view, assistance and resistance MNs would not be simultaneously active.
- (2) In rhythmic walking activity, the recruitment of the different MNs in a given MN pool is generally progressive. The units of small spike amplitude being activated before the larger ones, the transition from resistance to assistance, or assistance to resistance, could also be considered as being a part of this pattern of activity of the MN pool. For example during stance, mainly resistance reflexes occur whereas during swing, assistance reflexes are involved. This phase-dependent reflex reversal has been described in many vertebrate and invertebrate preparations (Rossignol et al. 1981, 1988; Skorupski and Sillar 1986).

The active transient depolarization in ARIN.

Injection of a depolarizing current in ARIN elicited an active transient depolarization which was graded with current intensity. Such an active transient response has already been described in the T-fiber of the TCMRO where, as in our model, this "spikelike transient" was sometimes sufficient to produce an EPSP in the promotor MNs (Skorupski 1992). In the same way, active depolarizing transients have been shown in the lobster stomatogastric ganglion (Graubard 1978), in the crab T-fiber (Blight and Llinás 1981) and in the locust nonspiking INs

(Laurent 1990). The nature of the conductances underlying the graded spikes described was clarified neither in these preparations nor in ours. According to Blight and Llinás (1981), it may be due to a calcium current, although Bush (1981), in the same preparation, suggested a TTX-sensitive sodium current was involved. The physiological role of this graded active depolarization is unclear. We can assume it may operate in a "pre-integration" of the sensory signals by the IN, functioning as an amplifier of the amplitude and/or the duration of the sensory EPSP.

Involvement of ARIN in the polysynaptic sensory-motor pathway.

Our experiments aimed at a better characterization of the MN reflex responses to the CBCO mechanical stimulation. We found 3 to 6 (average 4) sensory afferents connecting with one Dep MN ($n > 70$ Dep MNs) with some heterogeneity in the nature of those CBCO afferents (movement/position selectivity and conduction velocity). Concerning the INs, it appears that only movement sensitive afferents connect to ARINs (Fig. 6B). It also appears that a greater number of afferents control ARIN: 8 monosynaptic excitatory CBCO afferents (Fig. 5B) and at least 1 inhibitory (probably disynaptic) influence from release-coding CBCO afferents responsible for compound IPSPs (Fig. 4C, D). This finding is in agreement with El Manira et al. (1991a): these authors showed that electrical stimulation of the CBCO nerve elicited a short latency EPSP for weak intensities (1.3 V), followed by a long latency EPSP (or IPSP) for higher intensities (4 V). The increase of intensity recruited more CBCO afferents and we can suppose that this number (for 4 V) was sufficient to activate the polysynaptic sensory pathways. Then, there may be a convergence of the sensory inputs to a small number of

ARINs (perhaps only one per group of MNs), and subsequently, a divergence to the MNs involved in the expected assistance reflex activity.

The real connectivity, especially the number of ARINs and related postsynaptic MNs, remains to be determined. According to Bässler (1993), a single nonspiking IN is able to excite one pool of MNs (for example the Dep pool) and inhibit another antagonistic pool (the Lev one). Another possibility would be the existence of two INs, one excitatory, the other inhibitory on the same pool of MNs (Burrows et al. 1988). The systematic investigation of the CBCO units connecting both kinds of neurons (Fig. 5) allowed us to measure the latency of appearance of the sensory EPSPs in Dep MNs and ARINs. It appeared that latencies in both neurons were quite similar, and compatible with a monosynaptic connection in both cases. Moreover, the synaptic delay (about 2 ms) calculated between ARIN and the postsynaptic motor neuron (Fig. 8) is consistent with the timing of the polysynaptic part of the response observed by El Manira et al. (1991a). Therefore, we may assume that ARIN can be the only link between the CBCO afferents and the motor neurons in the polysynaptic reflex pathway; it may therefore be a disynaptic pathway.

CBCO inhibitory input to ARIN.

We have demonstrated that ARINs were activated by movement coding CBCO neurons (Figs. 4, 6). Moreover, the amplitude of the compound EPSP is velocity sensitive: the faster the movement, the larger the EPSP. However, the response observed during fast movement is also more variable and may be partly masked by IPSPs. These characteristics explain why the average traces (Fig. 4D cf. B) do not reflect the velocity-dependence observed in raw data (Fig. 4C cf. A). It is striking that the IPSP only became evident with the faster movements studied. This inhibitory connection limits the amount of depolarization induced by

the summation of unitary EPSPs. It is noticeable that for slow movements imposed to the CBCO strand, EPSPs do not summate much with each other, so that the amplitude of the response does not exceed 10 mV. By contrast, during faster movements, summation would actually occur and depolarization would reach more than 20 mV. In reality, due to the IPSP, this response is limited to 10-15 mV (see inserts B and D in Fig. 4). This velocity sensitive inhibition could play at least two roles:

- (1) IPSPs could represent a gain control mechanism that limits the efficacy of the assistance (positive feedback) reflex that otherwise could result in an "explosive-like" reaction.
- (2) IPSPs could be mediated by assistance reflex controlling INs (ARCINs) controlled by both the central locomotor network and velocity coding CBCO afferents. Such central control could therefore work in parallel with presynaptic control of primary afferents, in such a way that monosynaptic resistance reflexes or polysynaptic assistance reflexes are selected.

Phase-dependent modulation of reflex transmission.

From all these data, and those from previous work on presynaptic inhibition of primary afferents in this preparation (Cattaert et al. 1992), we can propose a more complete organization for the sensory-motor reflex network controlling the coxo-basipodite joint of the leg. Fig. 9 presents a schema of this organization concerning exclusively the Dep MN reflex activities. Both cases, quiescent and active preparation, are presented. In the first case (Fig. 9A), the central pattern generator (CPG) is not rhythmic and some of its outputs tonically excite (\oplus) the ARCIN responsible for the inhibition (-) of ARIN (Fig. 4A and C). In that case, upward movement of the leg would activate release sensitive CBCO fibers that stimulate monosynaptically most of the Dep MNs (Fig. 9A1); the Dep reflex expressed in the

preparation would be a resistance response. However, downward movement of the leg would activate stretch sensitive afferents that stimulate the aDep MN, resulting in a weak assisting influence in the Dep activity (Fig. 9A2); at the same time, the concomitant activation of ARCIN by stretch sensitive CBCO fibers and tonic outputs from the CPG would result in a strong inhibition (---) of the ARIN, and subsequently of the polysynaptic transmission of the stretch signal (Fig. 9A2). In contrast, when the CPG is rhythmically active (Fig. 9B), the central inhibition of ARIN through ARCIN is supposed to be removed. During the swing phase (Fig. 9B1), the CBCO strand is released by upward movement of the leg but Dep MNs stay silent, due to presynaptic inhibition (Cattaert et al. 1992). During the stance phase, Dep MNs are centrally activated. The CBCO strand is stretched during downward movement of the leg and ARIN transmits efficiently the stretch inputs to the Dep MNs, which therefore respond in the same way as the aDep MN. The Dep response expressed in the preparation would be a strong assistance reflex.

Our model for the control of reflex activities in the crayfish walking system is comparable to those described in the locust (Burrows et al. 1988) or in the stick insect (Bässler 1993). Nevertheless, it is interesting to remark that in the crayfish, the interneuronal level seems to be specialized in the reversal of the reflex activities: the monosynaptic sensory-motor connections elicit resistance reflexes while the interneuronal pathway, when permitted by the CPG, participates in the expression of assisting reflex responses in the motor nerves. It appears therefore that the reflexes expressed by the preparation are the result of a CPG-controlled balance between resistance and assistance patterns (as is suggested by Fig. 4). These results indicate that the CPG not only recruits sets of MNs, but also controls the sensory-motor pathways in such a way as to adapt them to the prevailing motor behavior.

Acknowledgments: This study was supported by the EEC contract number CT930190 and CNRS. We thank Dr. J. Y. Barthe , Dr. P. Skorupski and Dr. L. Vinay for helpful discussions and improving the manuscript. We are grateful to Dr. F. Clarac for constructive comments and laboratory facilities.

REFERENCES

- BAEV, K. V., AND KOSTYUK, P. G. Polarization of primary afferent terminals of lumbosacral cord elicited by the activity of spinal locomotor generator. *Neuroscience* 7: 1401-1409, 1982.
- BÄSSLER, U. Reversal of a reflex to a single motoneuron in the stick insect *Carausius morosus*. *Biol. Cybern.* 24: 47-49, 1976.
- BÄSSLER, U. Afferent control of walking in the stick insect *Cuniculina impigra*. II. Reflex reversal and the release of the swing phase in the restrained foreleg. *J. Comp. Physiol.* 158: 351-361, 1986.
- BÄSSLER, U. The femur-tibia control system of stick insect - a model system for the study of the neural basis of joint control. *Br. Res. Rev.* 18: 207-226, 1993.
- BERRY, M. S., AND PENTREATH, V. W. Criteria for distinguishing between monosynaptic and polysynaptic transmission. *Brain Res.* 150: 1-20, 1976.
- BÉVENGUT, M., CATTART, D., AND CLARAC, F. Synaptic connections of the common inhibitory motoneurone within the fifth thoracic ganglion of crayfish. *J. Comp. Physiol.* 178: 337-350, 1996.
- BLIGHT, A. R., AND LLINÁS, R. R. The non-impulsive stretch-receptor complex of a crab: a study of depolarization-release coupling at a tonic sensorimotor synapse. *Phil. Trans. R. Soc. Lond. B* 290: 219-276, 1981.
- BOYAN, G. S. Presynaptic inhibition of identified wind-sensitive afferents in the cercal system of the locust. *J. Neurosci.* 8: 2748-2757, 1988.
- BURROWS, M. Monosynaptic connections between wing stretch receptors and flight motoneurons in the locust. *J. Exp. Biol.* 62: 189-219, 1975.
- BURROWS, M. Local circuits for the control of leg movements in an insect. *TINS* 15: 226-232, 1992.
- BURROWS, M., LAURENT, G. J., AND FIELD, L. H. Proprioceptive inputs to nonspiking local interneurons contribute to local reflexes of a locust hindleg. *J. Neurosci.* 8: 3085-3093, 1988.
- BUSH, B. M. H. Proprioceptive reflexes in the legs of *Carcinus maenas*. *J. Exp. Biol.* 39: 89-105, 1962.
- BUSH, B. M. H. Leg reflexes from chordotonal organ in the crab *Carcinus maenas*. *Comp. Bioch. Physiol.* 15: 567-587, 1965.
- BUSH, B. M. H. Non-impulsive stretch receptors in crustaceans. In: *Neurons without impulses*, edited by A. Roberts, and B. M. H. Bush, Cambridge: Cambridge U. P., 1981, p.147-176.

CANNONE, A. J., and BUSH, B. M. H. Reflexes mediated by non-impulsive afferent neurons of the thoracic-coxal muscle receptor organ in the crab *Carcinus maenas*. I. Receptor potentials and promotor motorneuron responses. *J. Exp. Biol.* 86: 275-303, 1980.

CATTAERT, D., EL MANIRA, A., AND CLARAC, F. Direct evidence for presynaptic inhibitory mechanisms in crayfish sensory afferents. *J. Neurophysiol.* 67: 610-624, 1992.

CATTAERT, D., PEARLSTEIN, E., AND CLARAC, F. Cholinergic control of the walking network in the crayfish *Procambarus clarkii*. *J. Physiol. (Paris)* 89: 209-220, 1995.

CLARAC, F. How do sensory and motor signals interact during locomotion? In: *Motor control: Concepts and Issues* edited by D. R. Humphrey and H. J. Freund. New York: Wiley, 1991, p. 199-221.

DICAPRIO, R. A., AND CLARAC, F. Reversal of a walking leg reflex elicited by a muscle receptor. *J. Exp. Biol.* 90: 197-203, 1981.

ECCLES, J. C., SCHMIDT, R. F., AND WILLIS, W. D. Presynaptic inhibition of the spinal monosynaptic reflex pathway. *J. Physiol. Lond.* 161: 282-297, 1962.

EL MANIRA, A., CATTAERT, D., AND CLARAC, F. Monosynaptic connections mediate resistance reflex in crayfish (*Procambarus clarkii*) walking legs. *J. Comp. Physiol.* 168: 337-349, 1991a.

EL MANIRA, A., DICAPRIO, R. A., CATTAERT, D., AND CLARAC, F. Monosynaptic interjoint reflexes and their central modulation during fictive locomotion in crayfish. *Eur. J. Neurosci.* 3: 1219-1231, 1991b.

FORSSBERG, H., GRILLNER, S., AND ROSSIGNOL, S. Phase dependent reflex reversal during walking in chronic spinal cats. *Brain Res.* 85: 103-107, 1975.

FORSSBERG, H., GRILLNER, S., ROSSIGNOL, S., AND WALLEN, P. Phasic control of reflexes during locomotion in vertebrates. In: *Neural control of Locomotion*, edited by R. M. Hermann, S. Grillner, P. S. G. Stein, and D. G. Stuart. New York: Plenum, 1976, p. 519-538.

GRAUBARD, K. Synaptic transmission without action potential: input-output properties of a non-spiking presynaptic neuron. *J. Neurophysiol.* 41: 1014-1025, 1978.

GRILLNER, S. Locomotion in vertebrates. Central mechanisms and reflex interaction. *Physiol. Rev.* 55: 147-304, 1975.

HENNEMAN, E., AND MENDELL, L. M. Functional organization of motoneuron pool and its input. In: *Handbook of physiology, Vol. 2, Sect. I, The Nervous System, Motor Control, Part 1*, edited by V. B. Brooks. American Physiological Society, Bethesda, MD, 1981, p. 423-507.

JANKOWSKA, E., JUKES, M. G. M., LUND, S., AND LUNBERG, A. The effect of DOPA on the spinal cord. 6. Half centre organization of interneurons transmitting effects from the flexor reflex afferents. *Acta Physiol. Scand.* 70: 389-402, 1967.

KENNEDY, D., CALABRESE, R. L., AND WINE, J. J. Presynaptic inhibition: primary afferent depolarization in crayfish neurones. *Science Wash. DC* 186: 451-454, 1974.

LAURENT, G. Voltage-dependent nonlinearities in the membrane of locust nonspiking local interneurons, and their significance for synaptic integration. *J. Neurosci.* 10: 2268-2280, 1990.

LUND, J. P., ROSSIGNOL, S., AND MURAKAMI, T. Interaction between the jaw-opening reflex and mastication. *Can. J. Physiol. Pharmacol.* 59: 683-690, 1981.

MILL, P. J. *Structure and function of Proprioceptors in the Invertebrates*, edited by Chapman and Hall. London, 1976.

REICHERT, H., AND ROWELL, C. H. F. Integration of nonphaselocked exteroceptive information in the control of rhythmic flight in the locust. *J. Neurophysiol.* 53: 1201-1218, 1985.

ROSSIGNOL, S., AND DREW, T. Phasic modulation of reflexes during rhythmic activity. In: *Neurobiology of Vertebrate Locomotion*, edited by S. Grillner, H. Forssberg, P. S. G. Stein, and D. Stuart. London: Macmillan, 1986, p. 517-534.

ROSSIGNOL, S., JULIEN, C., GAUTHIER, L., AND LUND, J. P. State-dependent response during locomotion. In: *Muscle Receptors and Movement*, edited by A. Taylor and A. Prochazka. London: Macmillan, 1981, p. 389-403.

ROSSIGNOL, S., LUND, J. P., AND DREW, T. The role of sensory inputs in regulating patterns of rhythmical movements in higher vertebrates. In: *Neural Control of Rhythmic Movements in Vertebrates*, edited by A. H. Cohen, S. Rossignol, S. Grillner, New York: John Wiley & Sons, 1988, p. 201-283.

SILLAR, K. T., AND ROBERTS, A. A. A neuronal mechanism for sensory gating during locomotion in a vertebrate. *Nature Lond.* 331: 262-265, 1988.

SKORUPSKI, P. Synaptic connections between nonspiking afferent neurons and motor neurons underlying phase-dependent reflexes in crayfish. *J. Neurophysiol.* 67: 664-679, 1992.

SKORUPSKI, P. Octopamine induces steady state reflex reversal in crayfish thoracic ganglia. *J. Neurophysiol.* 76: 93-108, 1996.

SKORUPSKI, P., AND HUSTERT, R. Reflex pathways responsive to depression of the locust coxotrochanteral joint. *J. Exp. Biol.* 158: 599-605, 1991.

SKORUPSKI, P., RAWAT, B. M., AND BUSH, B. M. H. Heterogeneity and central modulation of feedback reflexes in crayfish motor pool. *J. Neurophysiol.* 67: 648-663, 1992.

SKORUPSKI, P., AND SILLAR, K. T. Phase-dependent reversal of reflexes mediated by the thoracocoxal muscle receptor organ in the crayfish *Pacifastacus leniusculus*. *J. Neurophysiol.* 55: 689-695, 1986.

WIENS, J. J., and GERSTEIN, G. L. Reflex pathway of the crayfish claw. *J. Comp. Physiol.* 107: 309-326, 1976.

LEGENDS

Fig. 1: Intrajoint reflex patterns in quiescent and rhythmic preparations.

A: Schematic drawing of the *in vitro* preparation, consisting in the 3rd, 4th and 5th thoracic ganglia (G3, G4 and G5), motor nerves innervating proximal muscles (Pro: promotor; Rem: remotor; Lev: levator; Dep: depressor), and the CBCO (coxo-basipodite chordotonal organ) sensory nerve (CB n). A mechanical puller controls movements (length changes) of the CBCO strand. The 5th ganglion is desheathed to permit intracellular recordings from neurons (ME 1, ME 2).

B: In a quiescent preparation, sinusoidal movements applied to the CBCO strand induced relatively stable joint reflexes in the Lev and Dep motor nerves (Lev n, Dep n). This is a resistance reflex pattern in which Lev motor neurons (MNs) are activated during CBCO strand stretching (which mimics downward movements of the leg), while Dep MNs are activated during the CBCO release (which mimics upward movements of the leg).

C: When rhythmic activity (fictive locomotion) was induced by superfusing the preparation with oxotremorine (10^{-5} M), application of sinusoidal movement to the CBCO elicited an intrajoint reflex corresponding to an assistance reflex pattern: Lev MNs bursted during CBCO release and Dep MNs during CBCO stretch.

Fig. 2: Responses of each of the 12 Dep MNs to ramp stimulation of the CBCO in quiescent preparation.

A: The stimulation applied to the CBCO (*top trace*) was composed of stretch (downward) and release (upward) movements, each made of a succession of small ramps: The following traces show the intracellular recordings of all 12 Dep MNs of the left 5th hemi-ganglion (all 12 recordings were performed in the same experiment, though not in the order in which they are presented). The 3 first neurons did not show any response to the CBCO stimulation. 8 Dep

MNs presented a resistance reflex characterized by depolarizations of their membrane potential (0.5 to 4 mV) during each release movements of the CBCO (broken vertical lines: each compound EPSP could be correlated with release sensitive sensory action potentials). Only one Dep MN (*bottom trace*) produced depolarizations (2 mV) during the CBCO stretching, eliciting an assistance reflex. B: Averaged traces from each Dep MN obtained from a total of 48 stepwise ramps, in 4 successive cycles of movement over the full length range. The resistance Dep MNs exhibited depolarizations during the release phases (*right column*). In contrast, the assistance Dep MN only exhibited depolarization during the stretch of the CBCO (*left column*).

Fig. 3: The monosynaptic assistance reflex.

A: In saline containing elevated levels ($2.5 \times$ normal) of divalent cations Ca^{2+} and Mg^{2+} , the assistance reflex response persisted in the single assistance Dep MN (*top trace*). This response consisted in a compound EPSP (3 to 10 mV) during each stretching movement of the CBCO (MVT). The resistance reflex of the 8 resistance Dep MNs (represented here by one only: *middle trace*) was not affected by the high divalent cation saline.

B: Velocity-dependence of the Dep MN assistance response. Release of the CBCO produced a depolarization whose amplitude increased with increasing velocity of the movement: about 12 mV (ΔV_2) for the higher speed ($0.25 \text{ mm}\cdot\text{s}^{-1}$) against about 5 mV (ΔV_1) for the lower speed ($0.05 \text{ mm}\cdot\text{s}^{-1}$); the values were measured for the same amplitude of movement.

Fig. 4: "Assistance reflex interneuron" (ARIN).

A: Paired intracellular recordings made from a Dep MN and an ARIN. In response to the CBCO release, the Dep MN (*top trace*) displayed a resistance reflex. During stretching movements, ARIN (*middle trace*) produced depolarizing responses (9 to 13 mV). B: Average traces of both phases obtained from 36 ramps. *Top traces*, response of both neurons to the CBCO release: Dep MN was depolarized while ARIN was weakly hyperpolarized. *Lower*

traces, response of both neurons to CBCO stretch: Dep MN was weakly depolarized while ARIN exhibited a large depolarizing response. C: When the movement velocity was increased (5 times the velocity in A), the Dep MN reflex response remained unchanged, although each compound EPSP duration decreased as did the ramp duration in the releasing movements. By contrast, the ARIN response changed: in addition to the depolarizations (about 14 mV), ARIN exhibited hyperpolarizations (about 10 mV) at the end of each stretching movement. D: Average traces of the response of both neurons obtained from 36 high velocity ramps. The increase in velocity increased the ARIN hyperpolarizing responses evoked by the release of the CBCO (*upper traces*) and unmasked hyperpolarizations at the end of stretching ramps (*lower traces*). The Dep MN exhibited a large depolarizing response to the CBCO release and a weak depolarization during the CBCO stretch. This second response appeared with a greater latency than the release-related one.

Fig. 5: Monosynaptic CBCO inputs to Dep MN and ARIN.

A: Four distinct release sensitive CBCO units (extracellular recordings, *bottom traces*) were found to produce an invariant monosynaptic EPSP (intracellular recordings, *upper traces*) in a Dep MN. B: During stretch, eight different CBCO units connected to ARIN and produced EPSPs of constant amplitude and delay. In both cases, the superimposed traces show the constancy of each EPSP. Data for A and B from the preparation with low velocity movement of Fig. 4A.

Fig. 6: Dep MN and ARIN sensory EPSPs occurred during movements of the CBCO.

A: Amplitude of EPSPs recorded in a Dep MN and triggered by CBCO extracellular action potentials represented as a function of time. B: same analysis performed on ARIN. The bottom traces (MVT) show the corresponding CBCO mechanical stimulations. In both cases, bursts of large EPSPs started with the onset of ramp movements (dotted lines). Data for A and B from the same experiment as Figs. 4A and 5.

Fig. 7: Electrical properties of ARIN.

A: Injection of increasing depolarizing current pulses (35 ms at 2 Hz, in 1 nA steps from +1 to +22 nA) elicited a two phase electrical response in the interneuron. First, a graded transient "spikelike" depolarization occurred ($\Delta V1$) for current intensities higher than +3 nA. Second, a classical electrical rectification developed ($\Delta V2$). B: The time to peak (B1) and amplitude (B2) of the transient depolarization varied in an intensity-dependent way.

Fig. 8: Evidence for connection of ARIN with postsynaptic Dep MN.

A: Experimental protocol: A depolarizing current pulse injected into ARIN elicited an early transient which evoked an EPSP in the Dep MN. B: Quantitative study of the synaptic relation. B1: MN EPSPs related to the graded "spikelike" transients (similar to that in Fig. 7A) were also graded; B2: plot of the EPSP amplitude as a function of the transient peak amplitude (the relation was of sigmoidal-type, the maximum EPSP amplitude being reached with about a 25 mV transient peak); B3: EPSP latency as a function of transient peak latency; the relation was linear ($R=0.99$) and gave a synaptic delay (intercept) of 1.67 ± 0.03 ms.

Fig. 9: Functional schema of the sensory-motor network that controls the Dep MN reflexes.

A: When the preparation produces a tonic pattern, the CPG activates tonically the ARCIN which inhibits the ARIN. During the release of the CBCO strand (A1), the resistance reflex is normally produced. During the CBCO stretch (A2), ARIN is inhibited by the ARCIN activated by both the CPG and the stretch sensitive CBCO afferents; ARIN inhibition prevents polysynaptic Dep assistance response. However the monosynaptic pathway (through aDep MN) should still result in a weak assisting influence. B: In contrast, when the CPG is active (i.e. when the preparation shows rhythmic activity), the CPG tonic activation of ARCIN does not occur but the CPG activates the PADI (B1). In these conditions, during the swing phase the CBCO is released, the PADI strongly inhibits the afferent signals and consequently the Dep MN resistance reflex. During the stance phase, the stretch sensitive CBCO afferents are

activated (B2) and excite ARIN. A strong polysynaptic Dep MN assistance reflex therefore occurs in addition to the monosynaptic one.

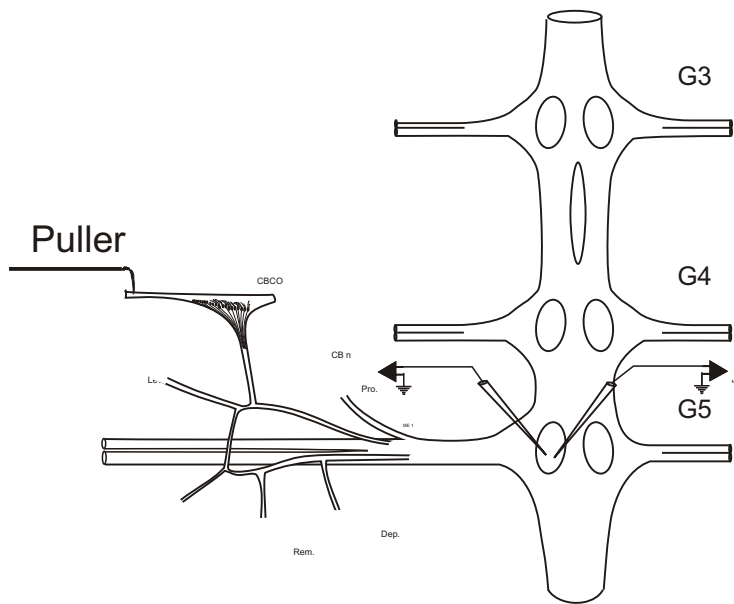
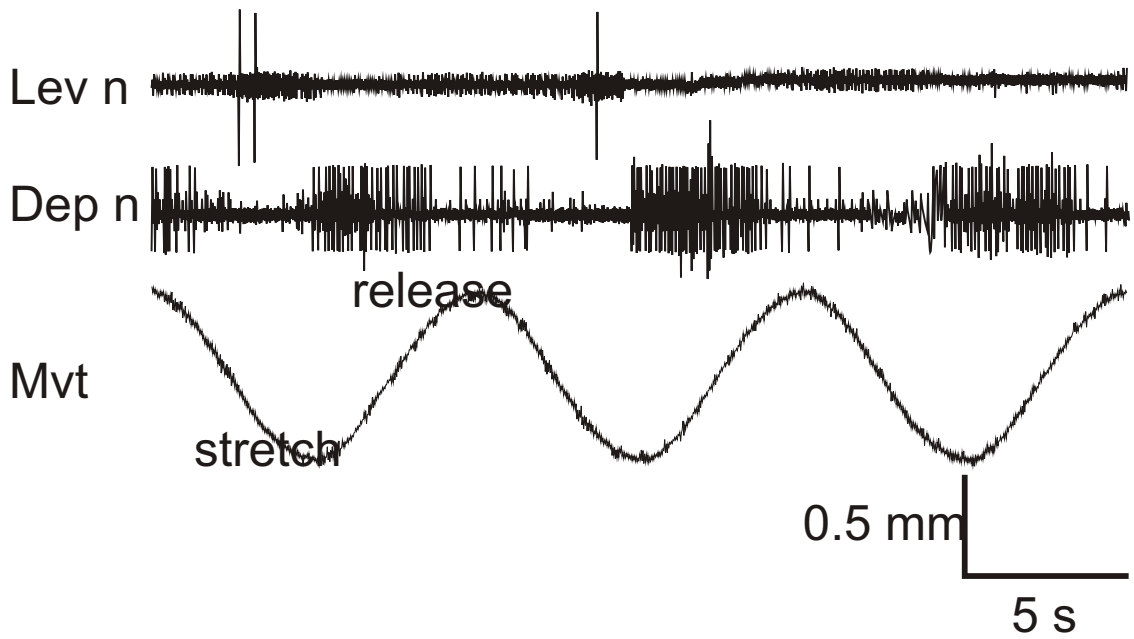
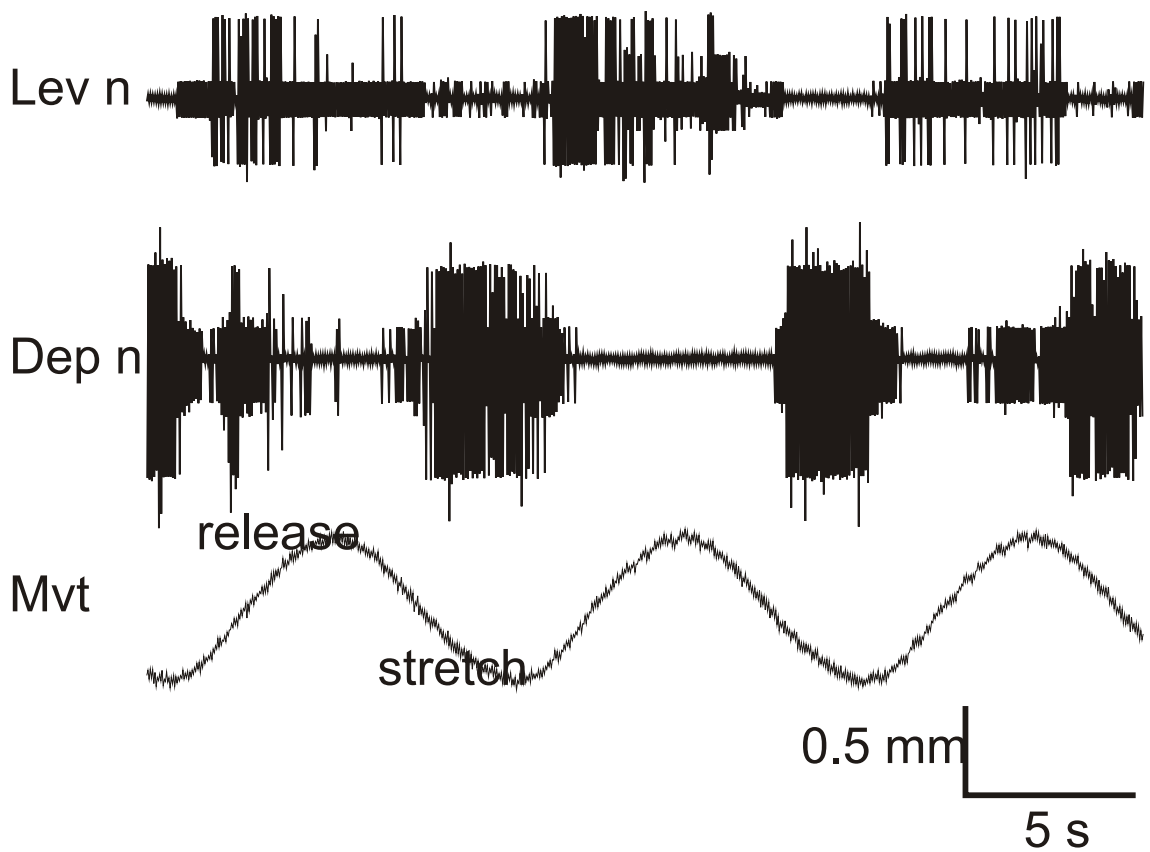
A**B****C**

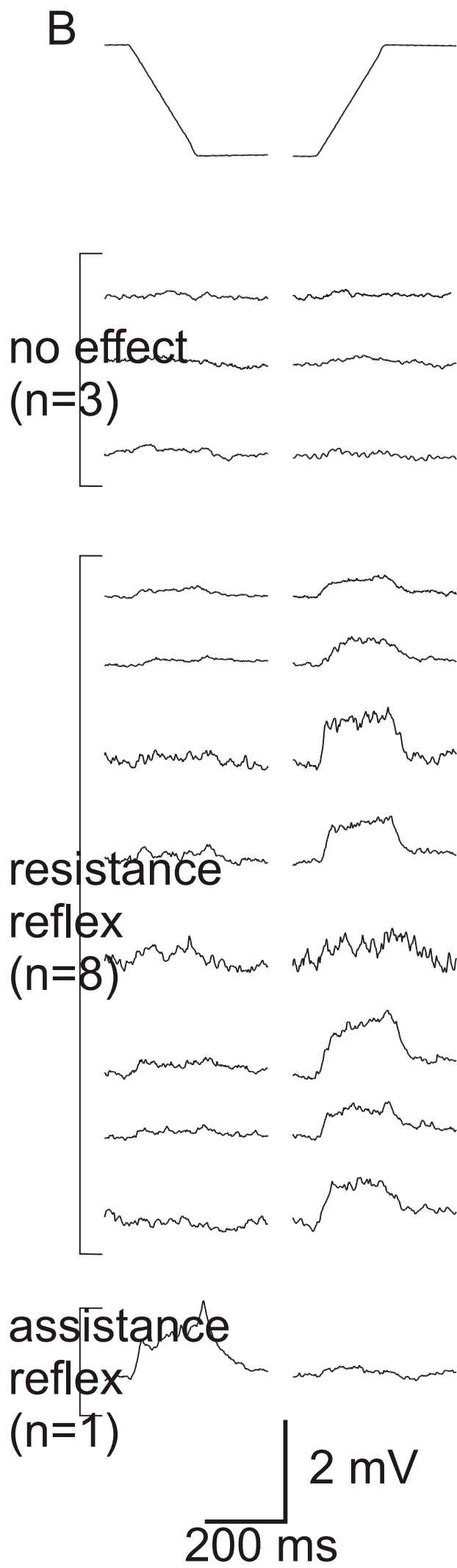
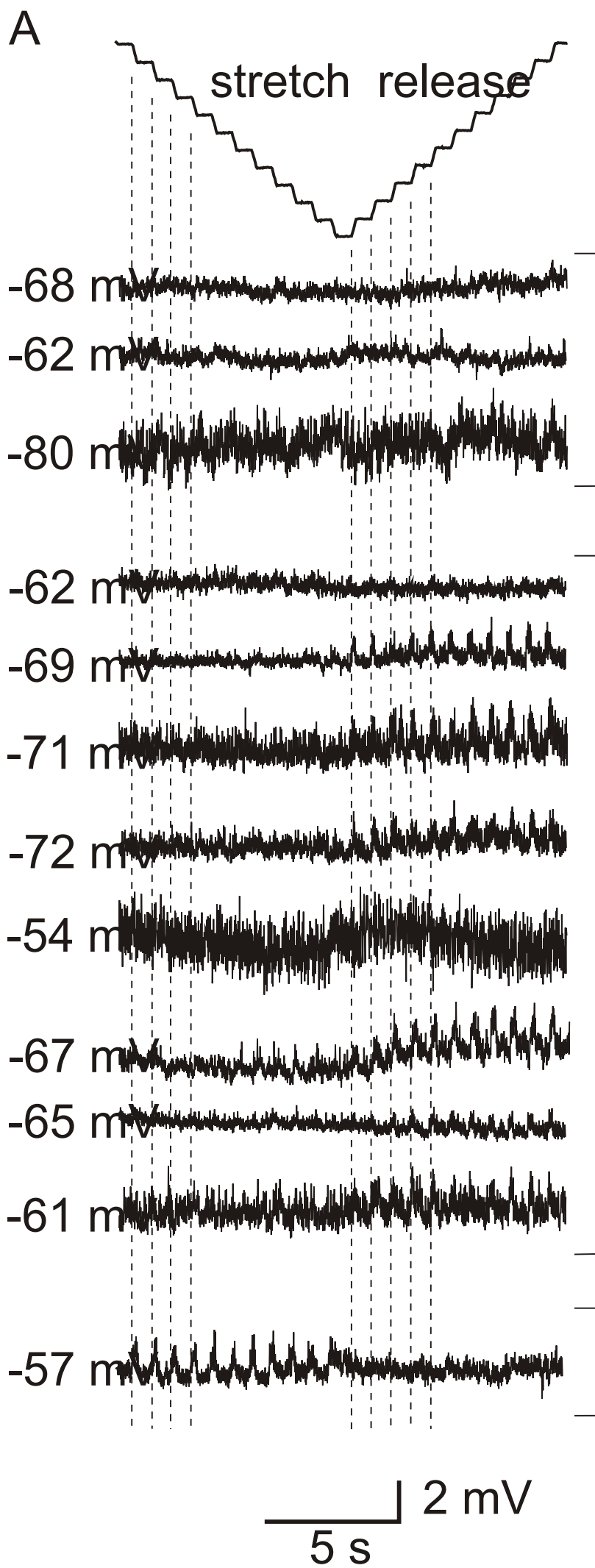

A

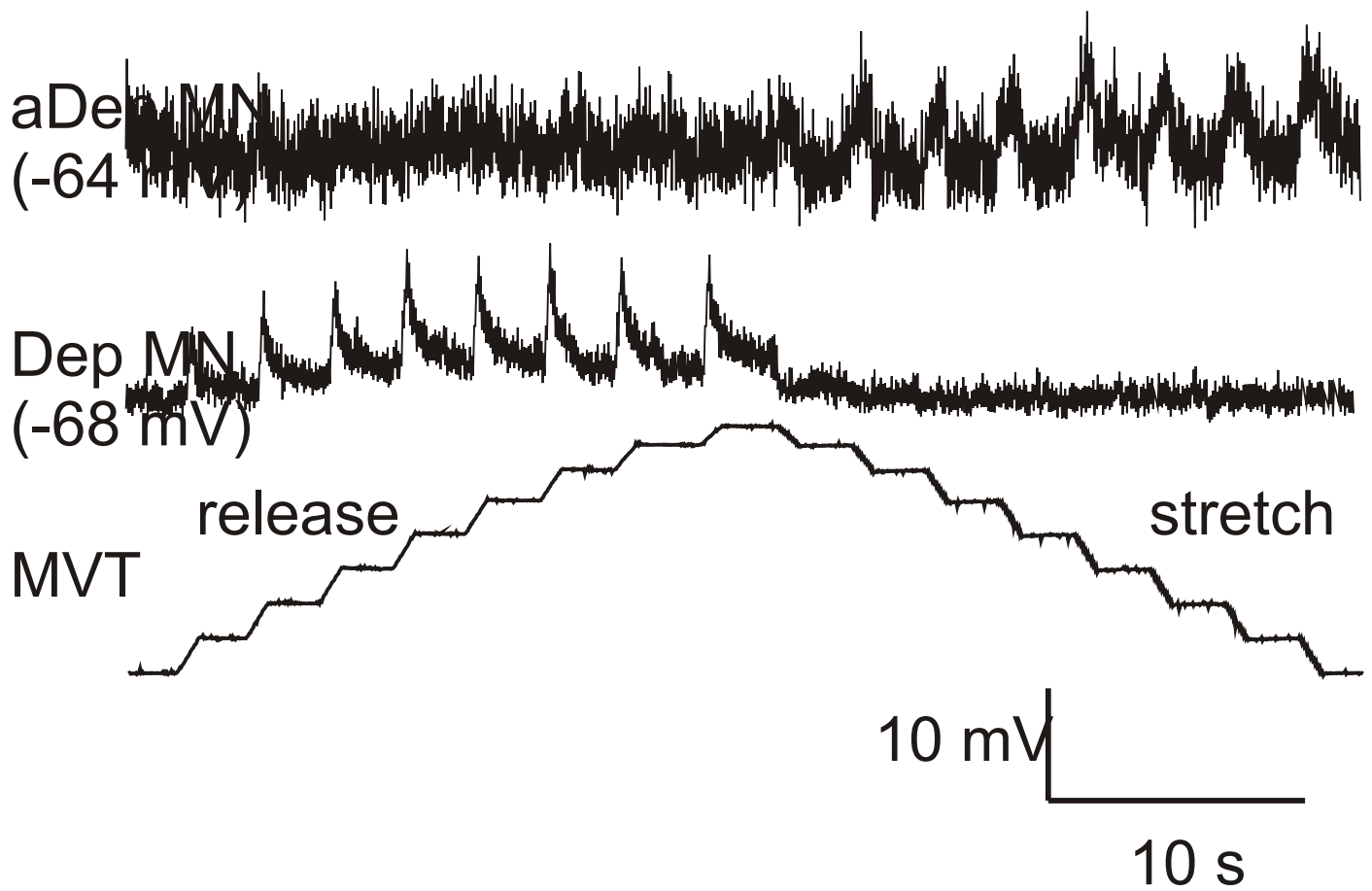

B

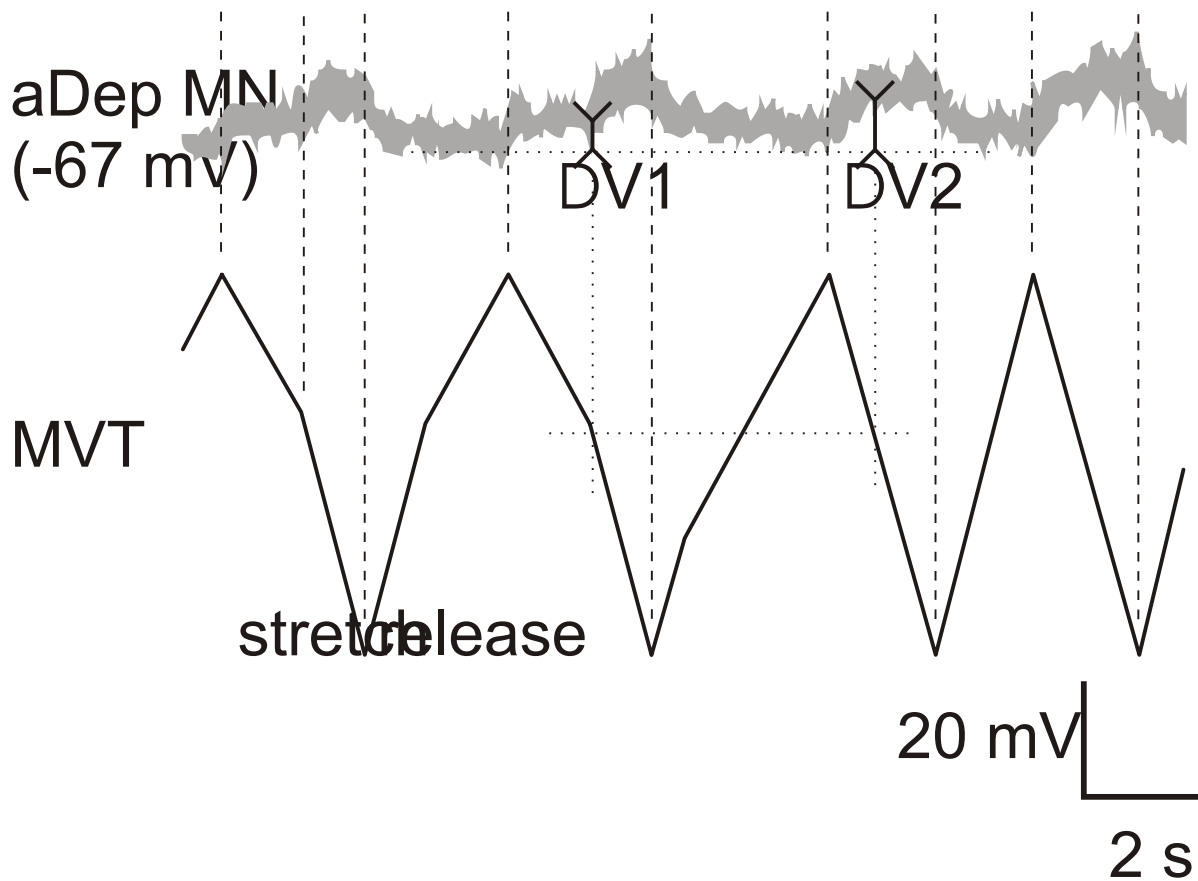

A

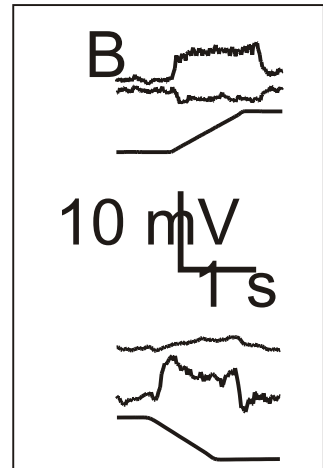
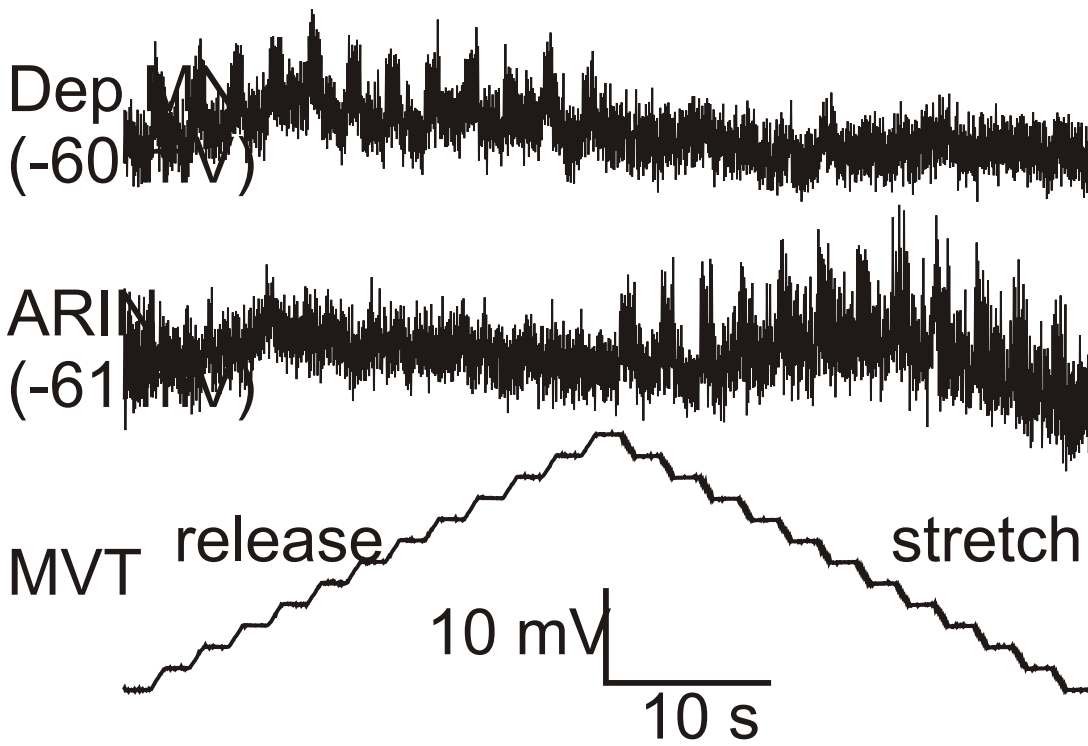

C

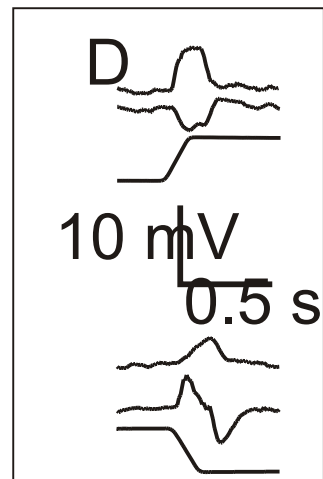
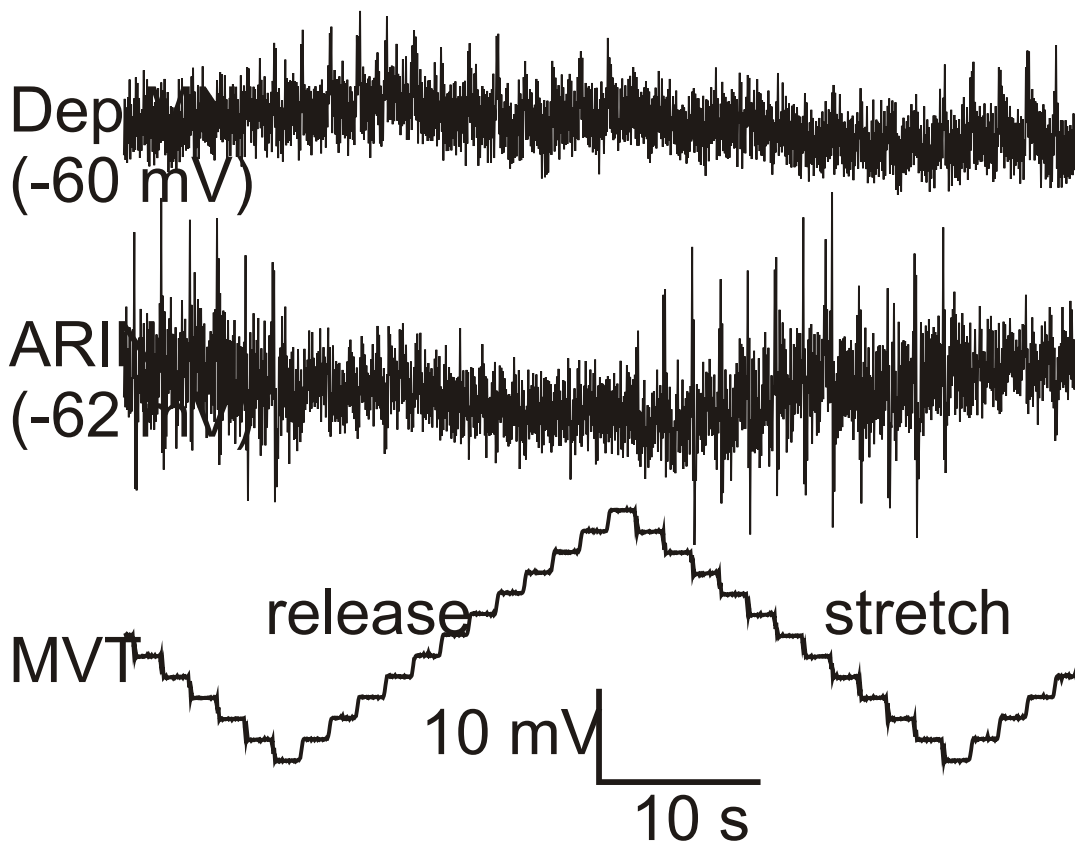

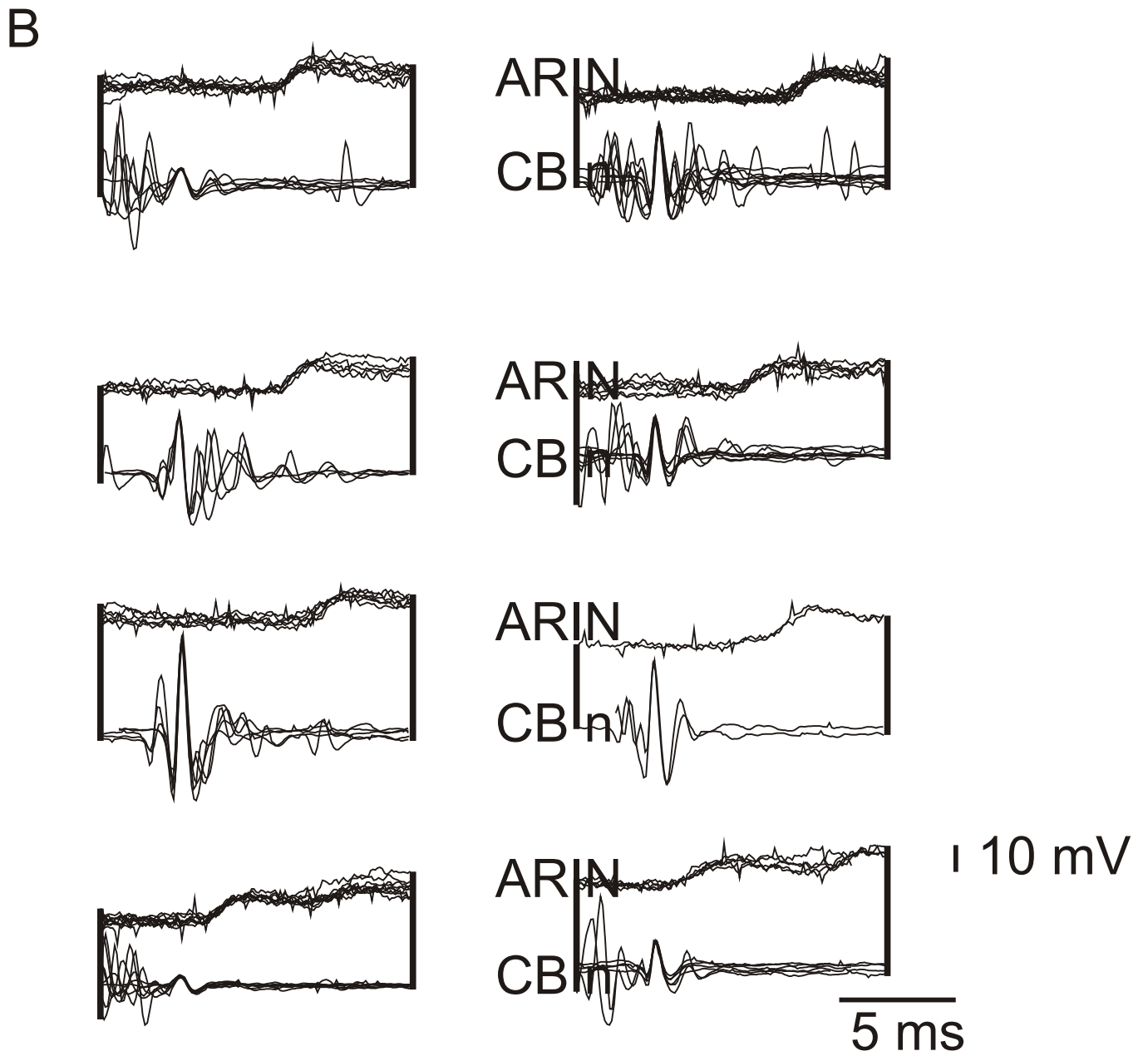
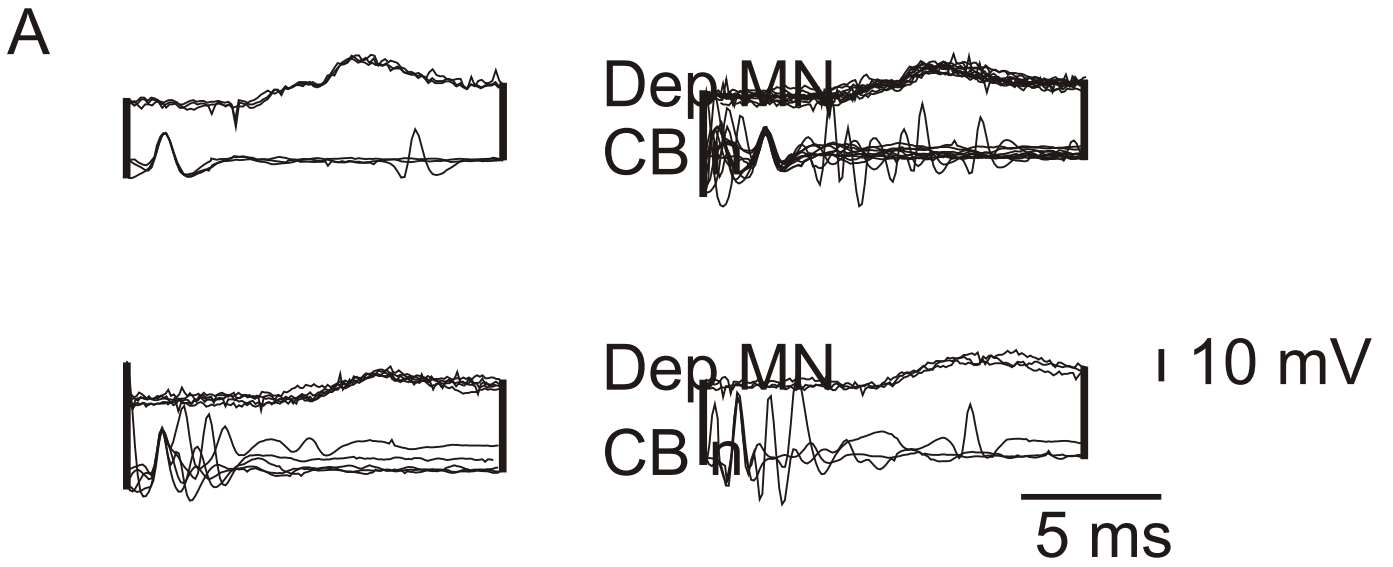

A

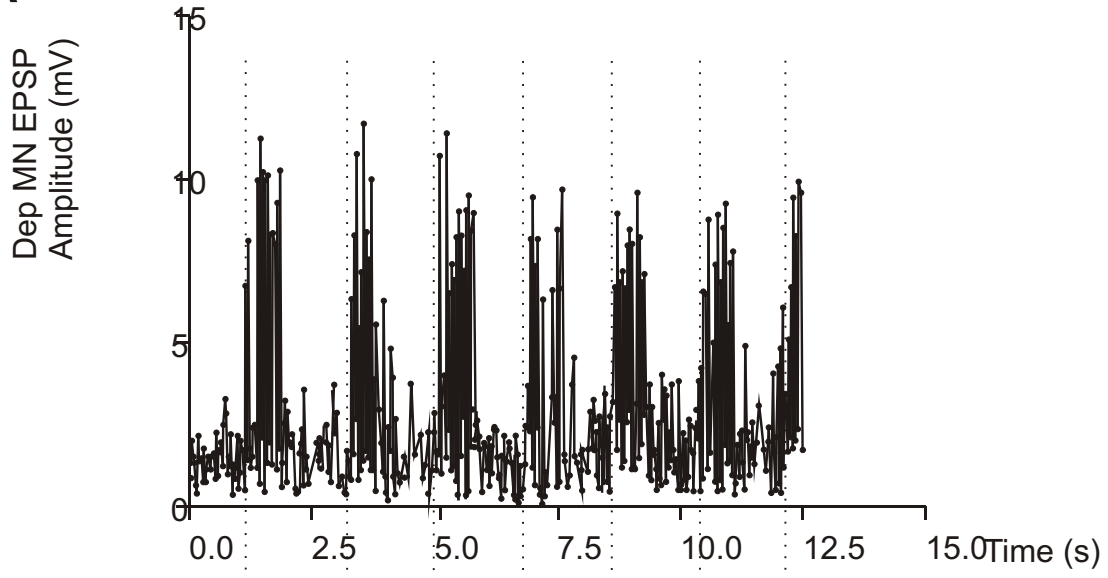

MVT

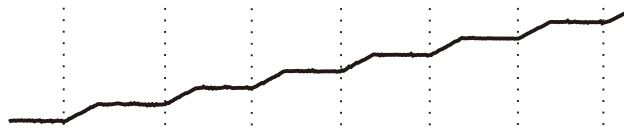

B

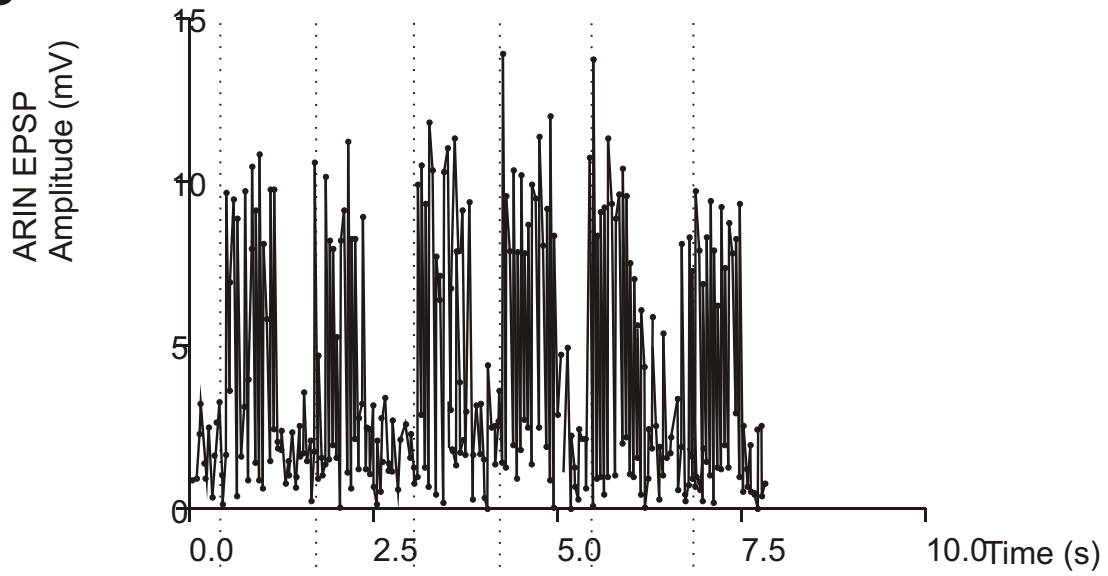

MVT

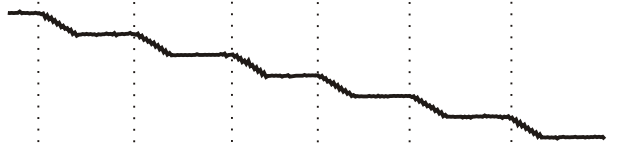

A

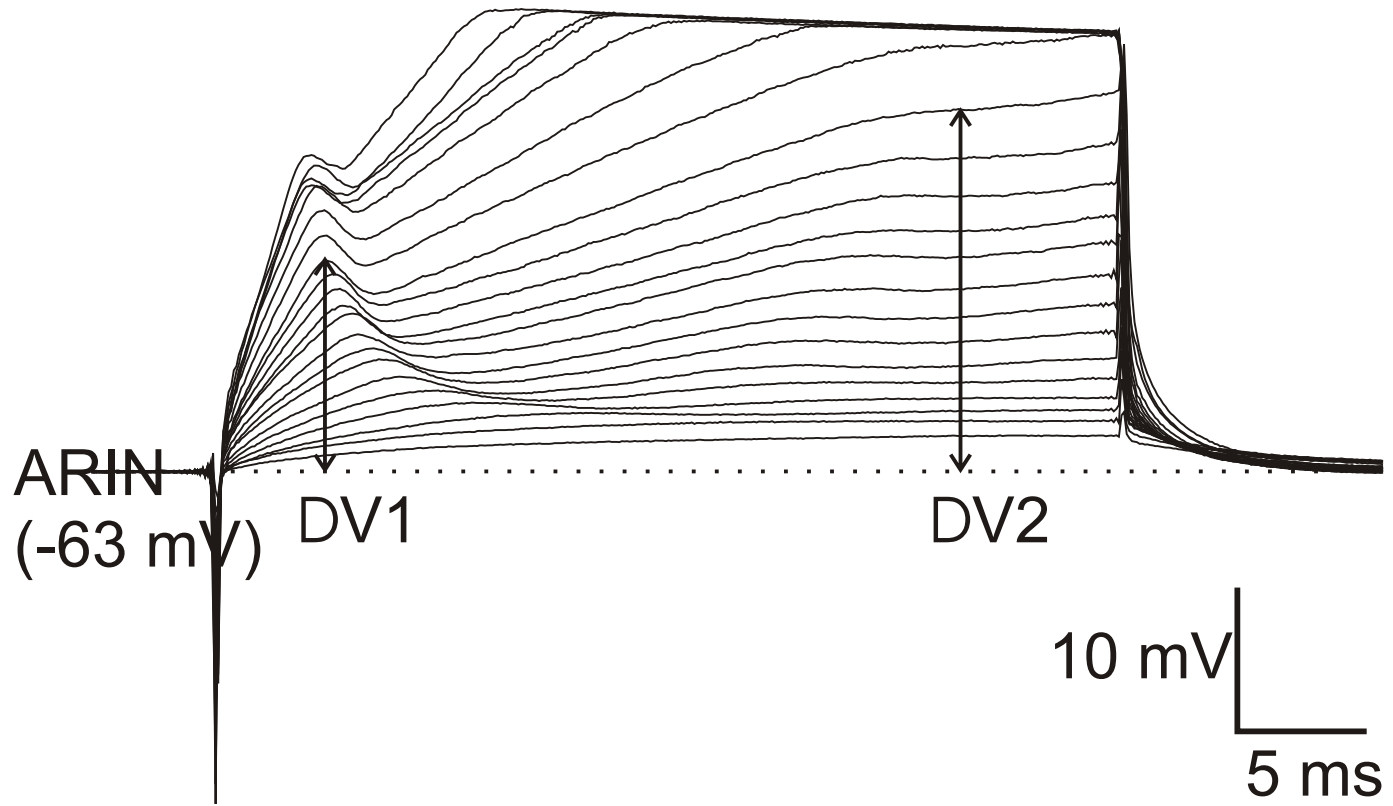

B

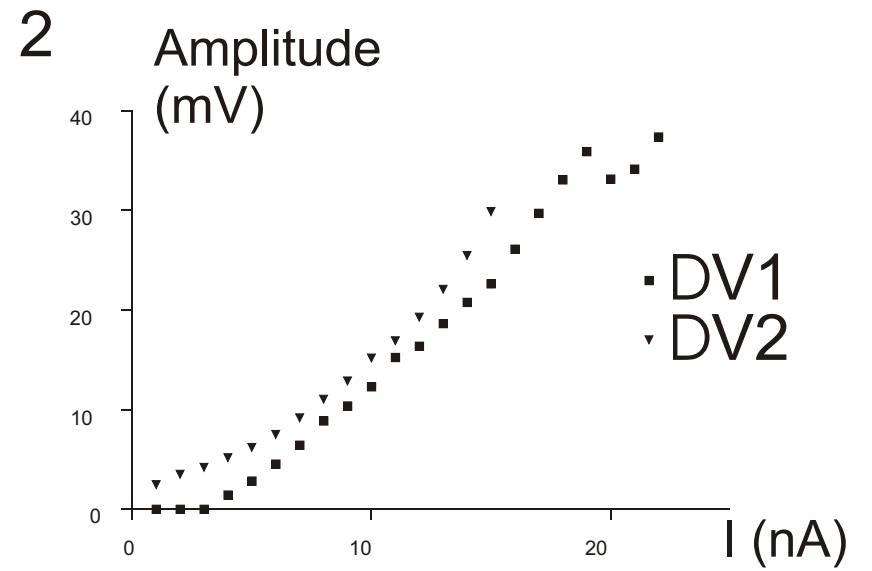
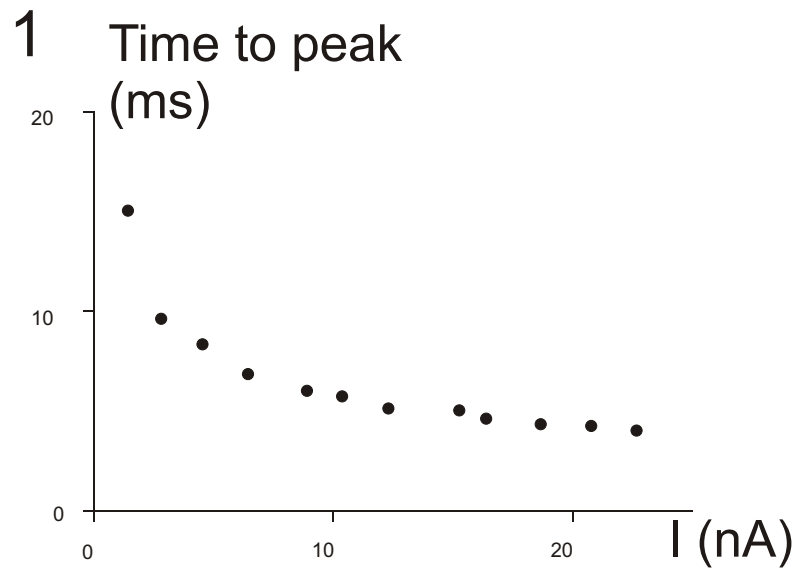

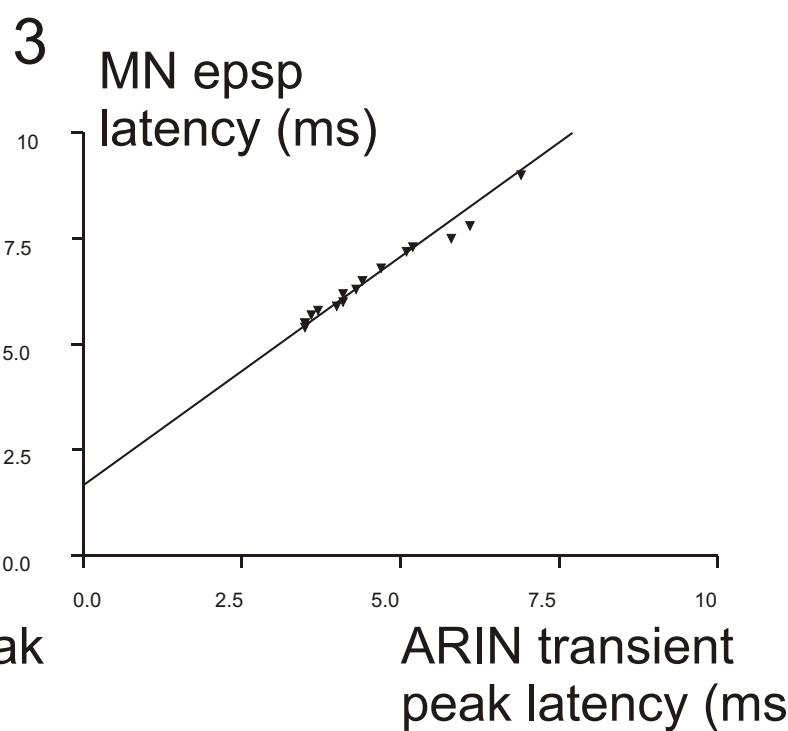
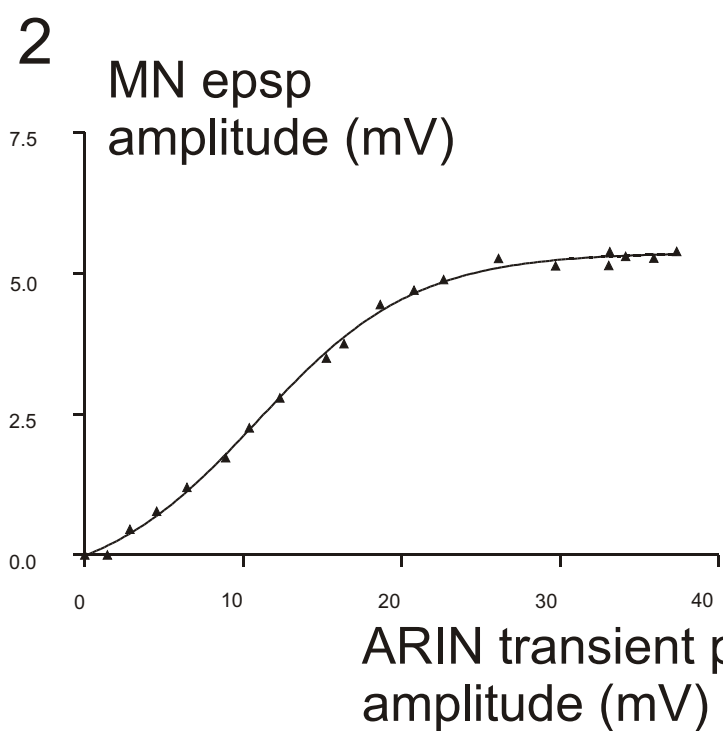
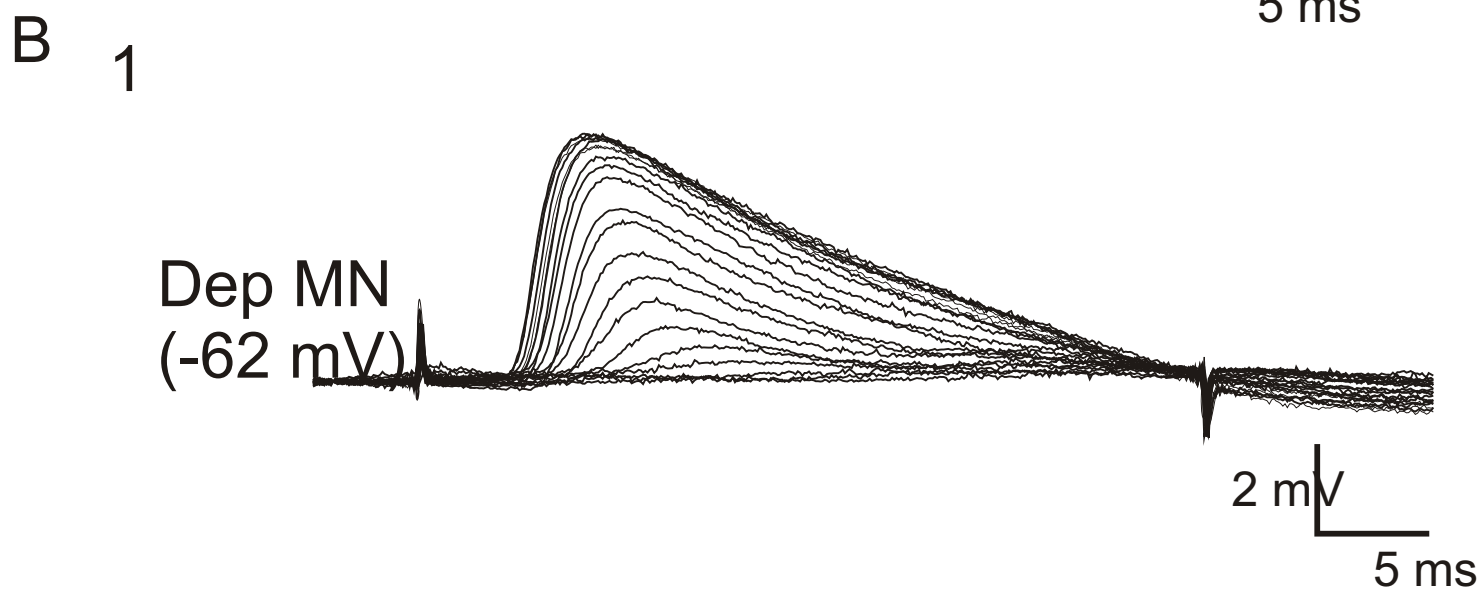
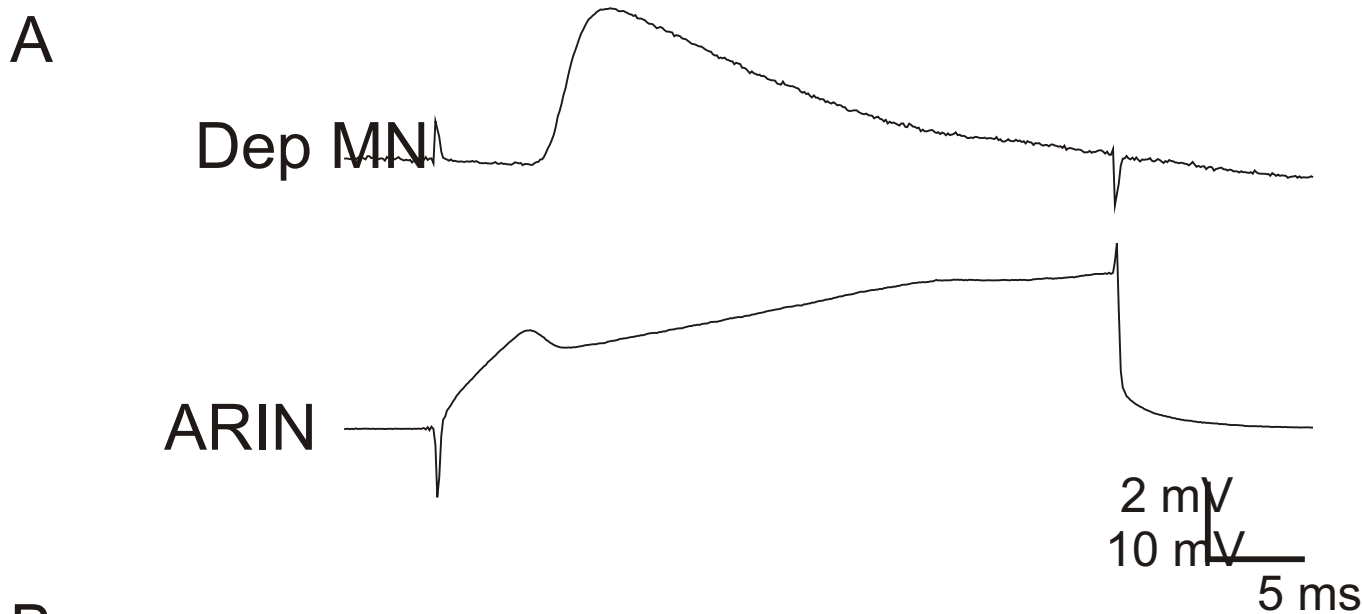

A

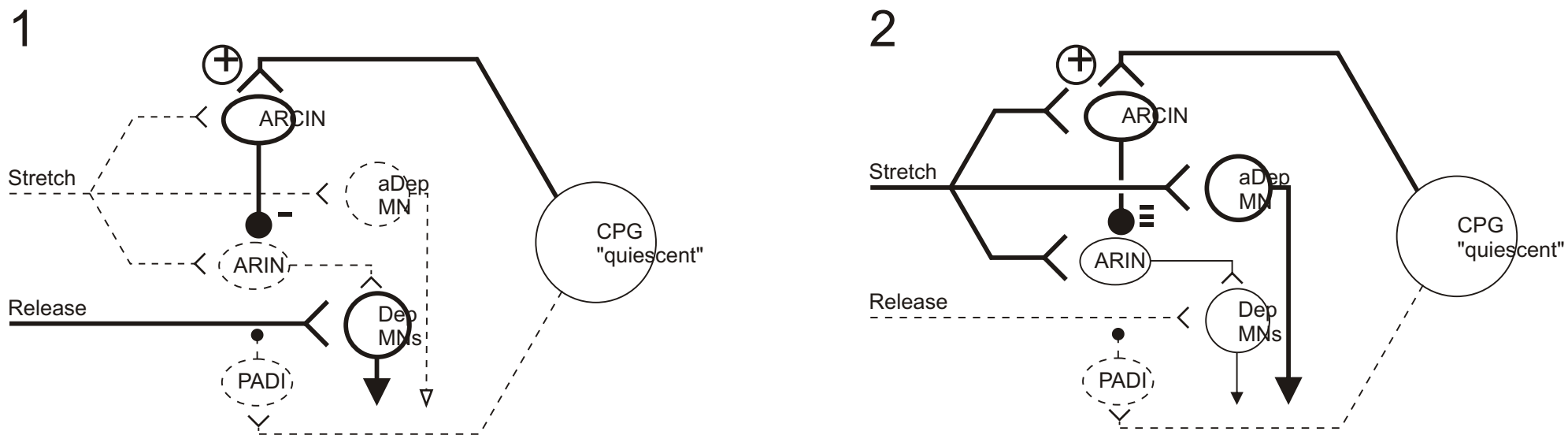

B

