

Mechanical properties of chains with bistable (two-state) units

Stefano Giordano

IEMN UMR CNRS 8520

Laboratoire International Associé LIA LICs/LEMAC

Université de Lille, Centrale Lille

Avenue Poincaré, BP 60069, 59652, Villeneuve d'Ascq, France



GDR MePhy

Mécanique et Physique des Systèmes Complexes (GDR 3588 mixte INSIS/INP)

Atelier changements d'échelle, le 5 juin 2018

Contents

- Introduction of the isometric or Helmholtz ensemble and the isotensional or Gibbs ensemble and their relation with real experiments.
- The equivalence of the ensembles in the thermodynamic limit (very long polymer chains): a theorem and some Monte-Carlo simulations.
- The force-extension overstretching regime: the understanding of the *plateau-like* response and the *saw-tooth* like response.
- The chain of bistable elements (domains) as a model to interpret the overstretching regimes observed.
- The spin variables method to study bistability and multistability in polymer systems.
- Generalizations to finite stiffness and Ising interaction (cooperativity)
 - Perspective and conclusions



Statistical mechanics of (macromolecular) chains with bistable (two-state) units

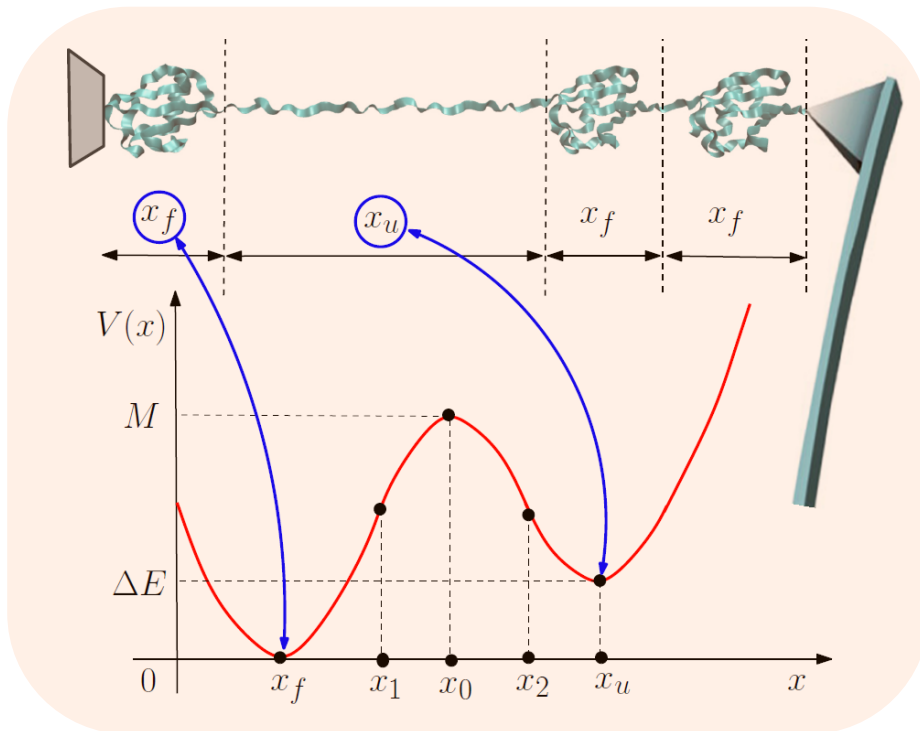

- ✓ Elementary model for plasticity (with hysteresis and/or martensitic transformations)

(Ericksen, 1975; Müller and Villaggio, 1977; Fedelich and Zanzotto 1992; Puglisi and Truskinovsky, 2000...)

- ✓ Conformational transitions in macromolecules observed by force-spectroscopy methodologies

(Strick et al., 2003; Ritort, 2006...)

Polymer chain statistical mechanics

Free polymer: the first monomer is clamped while the others are free to fluctuate

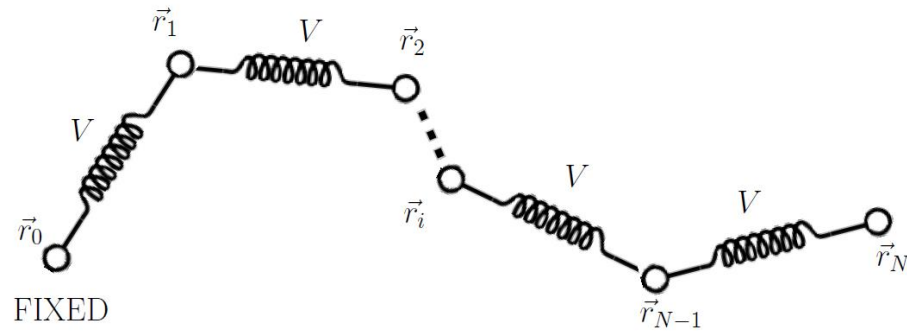

$$h_0(\vec{r}_1, \dots, \vec{r}_N, \vec{p}_1, \dots, \vec{p}_N) = \sum_{i=1}^N \frac{\vec{p}_i \cdot \vec{p}_i}{2m} + \mathcal{U}(\vec{r}_1, \dots, \vec{r}_N)$$

Hamiltonian of the system with arbitrary interactions (FJC, WLC...)

$$\rho(q, p) = \frac{1}{Z} e^{-\frac{h_0(q,p)}{k_B T}}$$

Probability density in the phase space (Boltzmann/Gibbs distribution), where Z is the classical partition function

Stretching of the chain



Isometric conditions (Helmholtz ensemble)

Isotensional conditions (Gibbs ensemble)

Helmholtz ensemble: isometric conditions

$$h(\vec{r}_1, \dots, \vec{r}_{N-1}, \vec{p}_1, \dots, \vec{p}_{N-1}, \vec{r}) = h_0(\vec{r}_1, \dots, \vec{r}_{N-1}, \vec{r}_N = \vec{r}, \vec{p}_1, \dots, \vec{p}_{N-1}, \vec{p}_N = 0)$$

Helmholtz

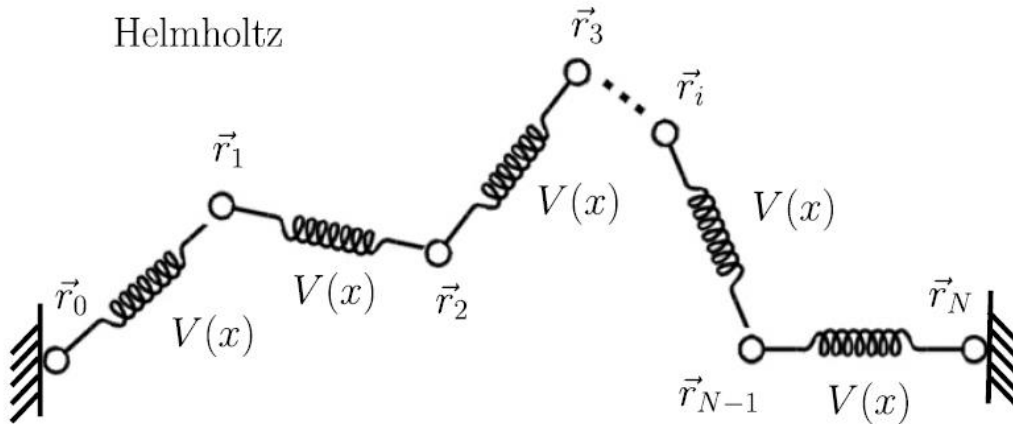

$$Z_{\vec{r}}(\vec{r}, T) = \iint_{\Gamma_{N-1}} e^{-\frac{h(q,p,\vec{r})}{k_B T}} dq dp,$$

$$\rho_{\vec{r}}(q, p; \vec{r}, T) = \frac{1}{Z_{\vec{r}}(\vec{r}, T)} e^{-\frac{h(q,p,\vec{r})}{k_B T}}$$

$$\langle \vec{f} \rangle = \left\langle \frac{\partial h}{\partial \vec{r}} \right\rangle$$



$$\langle \vec{f}(\vec{r}, T) \rangle = -k_B T \frac{\partial}{\partial \vec{r}} \log Z_{\vec{r}} = \frac{\partial F(\vec{r}, T)}{\partial \vec{r}}$$

$$F(\vec{r}, T) = -k_B T \log Z_{\vec{r}}$$

**Helmholtz free
energy**

Gibbs ensemble: isotensional conditions

$$\tilde{h}(\vec{r}_1, \dots, \vec{r}_N, \vec{p}_1, \dots, \vec{p}_N, \vec{f}) = h_0(\vec{r}_1, \dots, \vec{r}_N, \vec{p}_1, \dots, \vec{p}_N) - \vec{f} \cdot \vec{r}_N$$

Gibbs

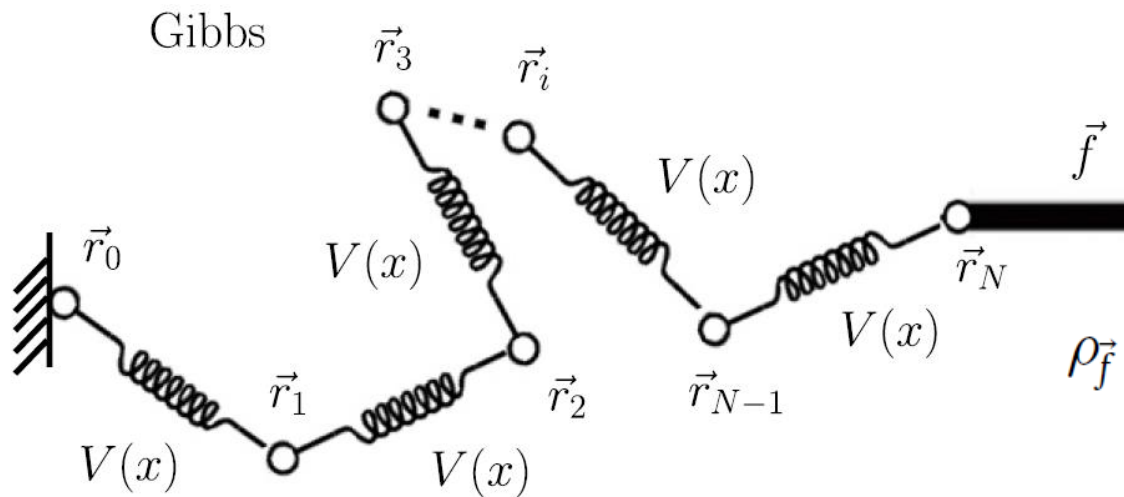

$$Z_{\vec{f}}(\vec{f}, T) = \iint_{\Gamma_N} e^{-\frac{\tilde{h}(q,p,\vec{f})}{k_B T}} dq dp,$$

$$\rho_{\vec{f}}(q, p; \vec{f}, T) = \frac{1}{Z_{\vec{f}}(\vec{f}, T)} e^{-\frac{\tilde{h}(q,p,\vec{f})}{k_B T}}$$

$$\langle \vec{r} \rangle = - \left\langle \frac{\partial \tilde{h}}{\partial \vec{f}} \right\rangle \longrightarrow \langle \vec{r}(\vec{f}, T) \rangle = k_B T \frac{\partial}{\partial \vec{f}} \log Z_{\vec{f}} = - \frac{\partial G(\vec{f}, T)}{\partial \vec{f}}$$

$$G(\vec{f}, T) = -k_B T \log Z_{\vec{f}}$$

Gibbs free energy

JCP 137, 244907 (2012)

JCP 136, 154906 (2012)

Force-spectroscopy methods (Neuman and Nagy, 2008)

Magnetic tweezers

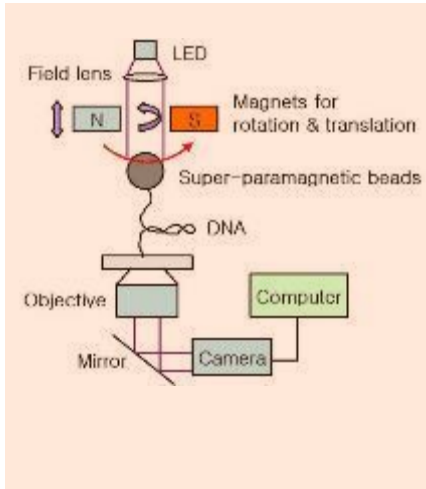

Optical tweezers

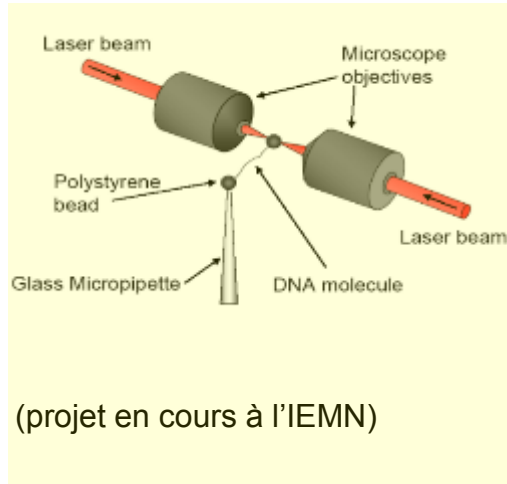

Atomic force microscope

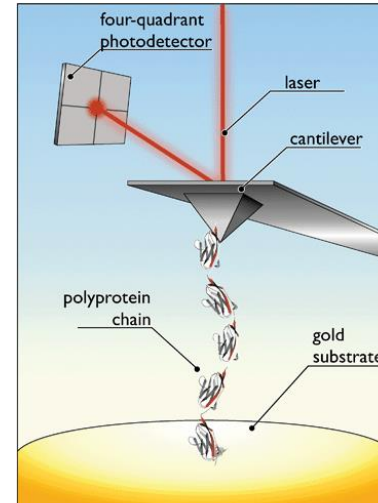

MEMS

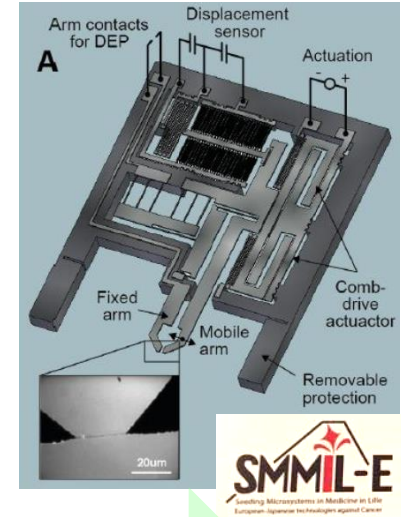

Devices with variable stiffness k_c ($10^{-5} - 10^4$ pN·nm $^{-1}$)

Equivalent Stiffness k_c

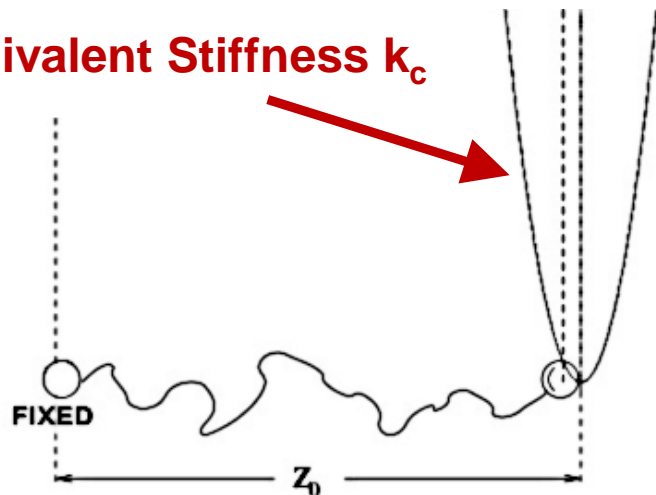

Soft cantilever → Gibbs ensemble

Hard cantilever → Helmholtz ensemble

Comparison between Helmholtz and Gibbs ensembles

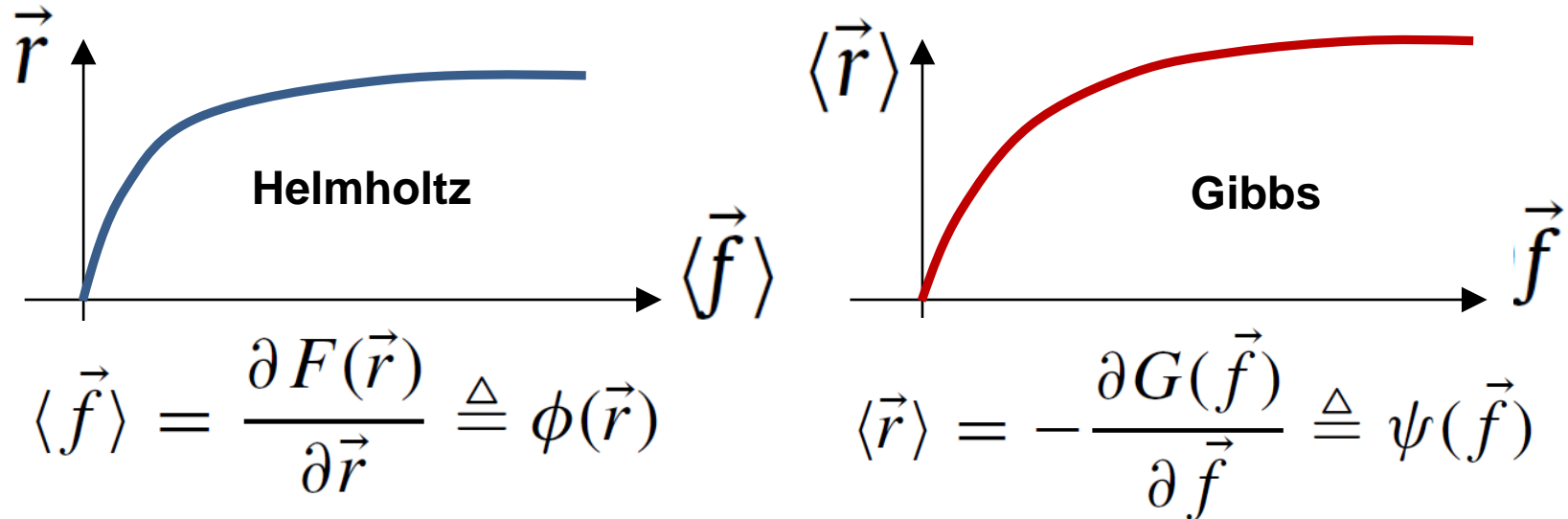

Is it always true that $\phi = \psi^{-1}$ or $\psi = \phi^{-1}$?

If we compare the Helmholtz and Gibbs partition functions we have:

$$Z_{\vec{f}}(\vec{f}, T) = (2\pi mk_B T)^{\frac{3}{2}} \int_{\mathfrak{R}^3} Z_{\vec{r}}(\vec{r}, T) e^{\frac{\vec{f} \cdot \vec{r}}{k_B T}} d\vec{r} \quad \text{(Laplace transform)}$$

Or, in terms of Gibbs and Helmholtz free energies:

$$e^{-\frac{G(\vec{f}, T)}{k_B T}} = (2\pi m k_B T)^{\frac{3}{2}} \int_{\mathfrak{R}^3} e^{-\frac{F(\vec{r}', T)}{k_B T}} e^{\frac{\vec{f} \cdot \vec{r}'}{k_B T}} d\vec{r}'$$

Theorem (Physica A 395, 2014, 154–170)

For a polymer model described by a continuous pairing interaction between neighboring monomers (with convergent partition functions) we have $\phi = \psi^{-1}$ in the limit of $N \rightarrow \infty$ (equivalence between ensembles)

(It can be generalized to more general interactions: 3-body, WLC)

(Legendre transforms)

$$N \rightarrow \infty \quad \longrightarrow \quad \left\{ \begin{array}{l} G(\phi(\vec{r})) = F(\vec{r}) - \phi(\vec{r}) \cdot \vec{r} \\ F(\psi(\vec{f})) = G(\vec{f}) + \vec{f} \cdot \psi(\vec{f}) \end{array} \right.$$

FJC

$$r = Nl\mathcal{L}\left(\frac{lf}{k_B T}\right) \quad (\mathbf{G})$$

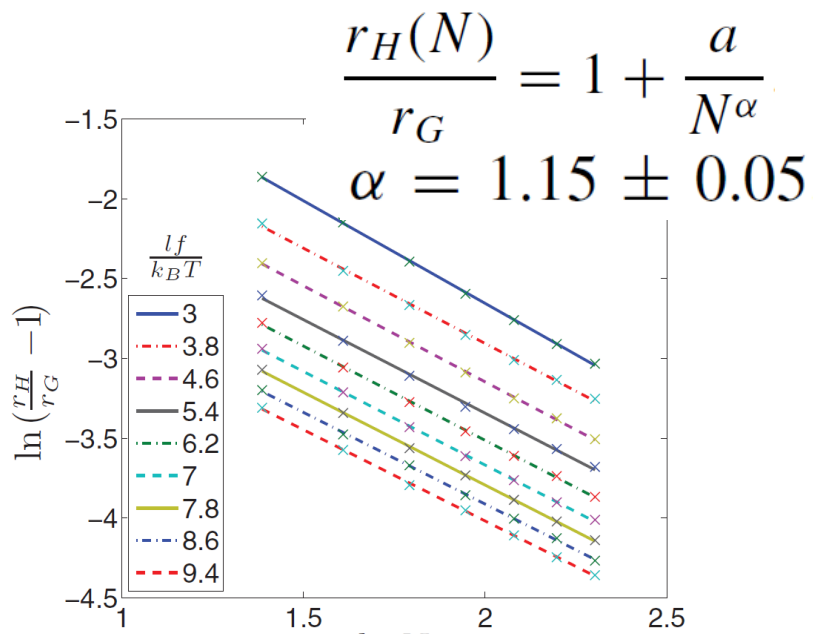
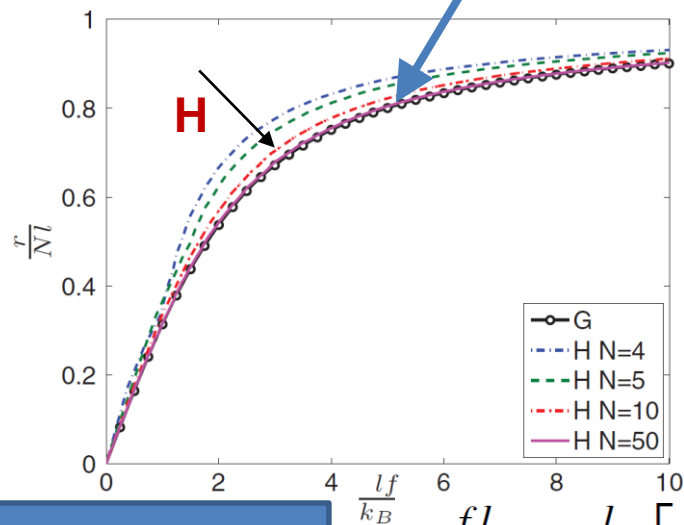

WLC

$$\frac{fl}{k_B T} = \frac{l}{L_p} \left[\frac{1}{4(1-\zeta)^2} - \frac{1}{4} + \zeta \right]$$

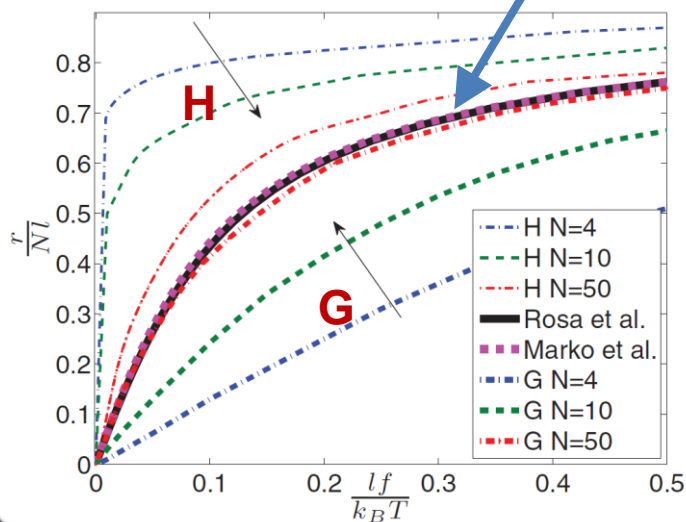

$\kappa = 10k_B T$
(bending)

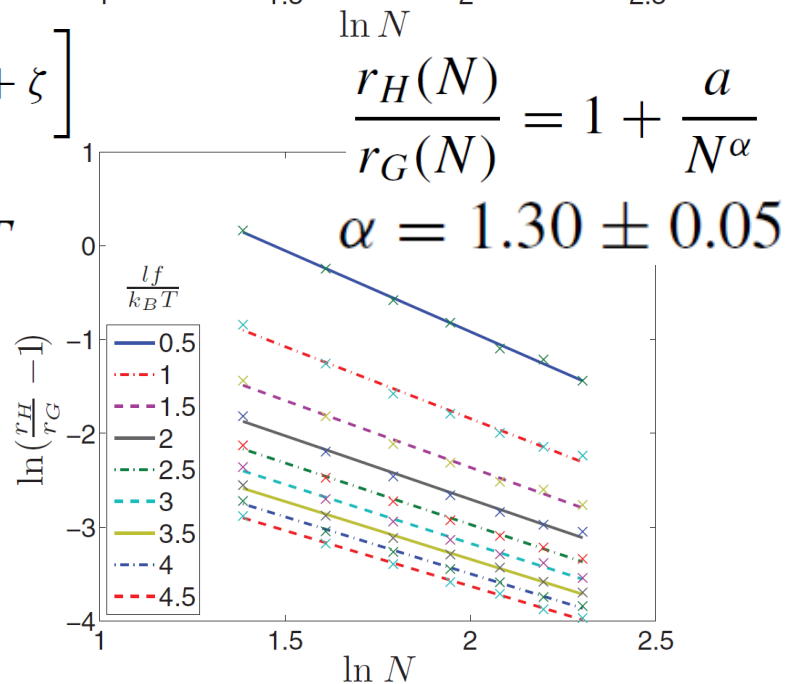

iemn

Institut d'Electronique, de Microelectronique et de Nanotechnologie
UMR CNRS 0520

J. Chem. Phys. 136, 154906 (2012)

Comments

- We have proved the equivalence between Helmholtz and Gibbs ensembles in the thermodynamic limit for a chain with continuous pairing interactions (and more general schemes with 3-body potentials, WLC...);
- The convergence for high values of N is described by a power law with specific exponents;
- The differences between the Helmholtz and Gibbs force-extension responses are however negligible for $N > 50/100$ monomers (for FJC or WLC);
- Therefore, the differences are not relevant for long chains as DNA (during entropic and enthalpic stretching);
- Nevertheless, the analysis of different ensembles is useful for the understanding of experiments in the overstretching regime, where conformational transitions occur.

Overstretching experiments (COOPERATIVE RESPONSE)

DNA (Nature 421, 423, 2003)

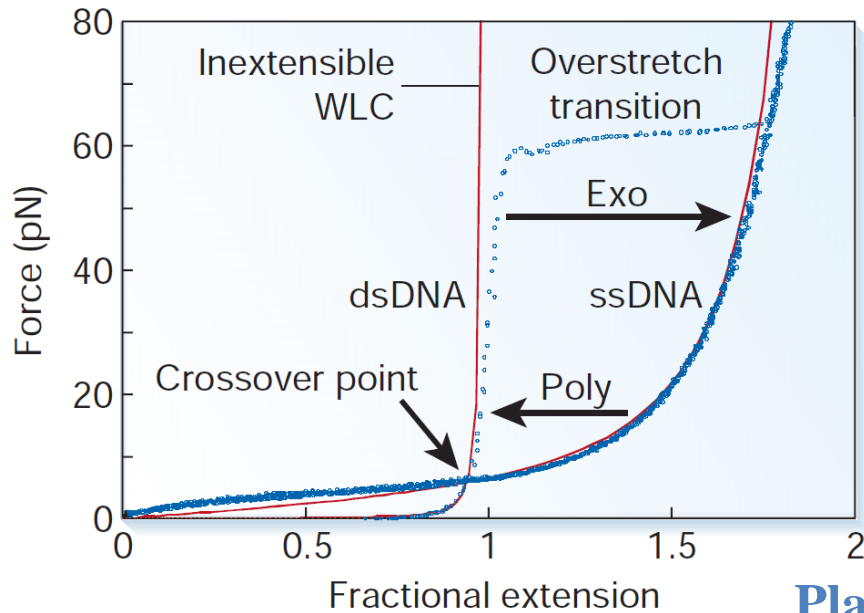

Dextran (polysaccharide)

(PRL 81, 4764, 1998)

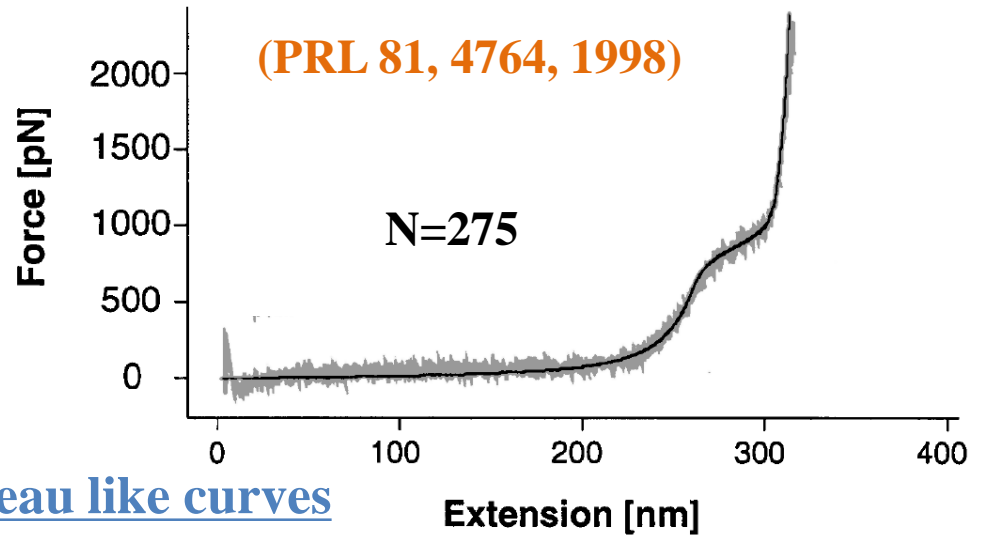

Plateau like curves

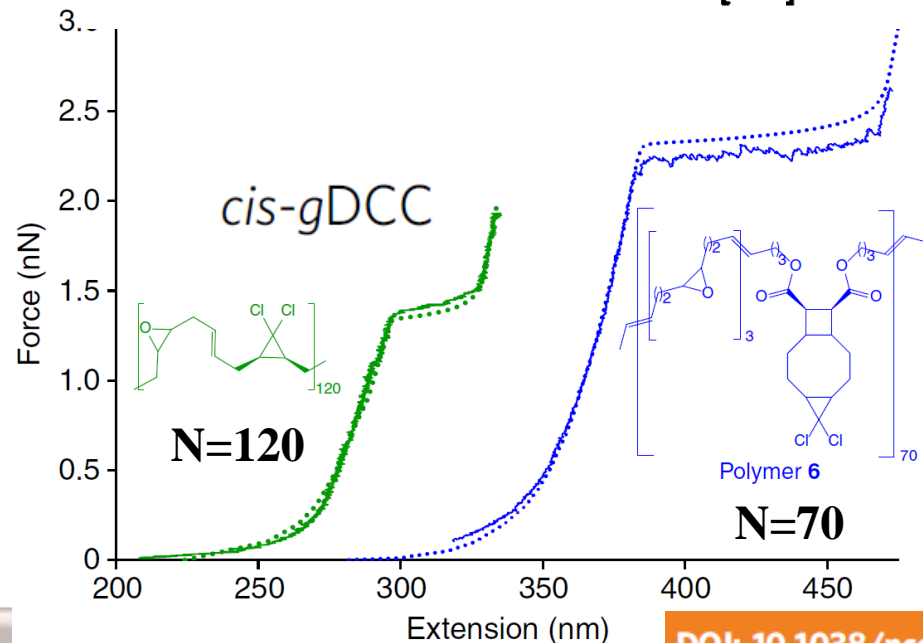
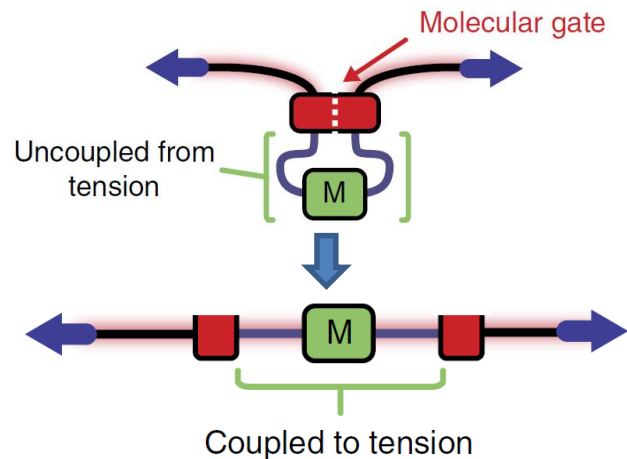

Overstretching experiments (NON-COOPERATIVE RESPONSE)

Human tenascin-C, N=7

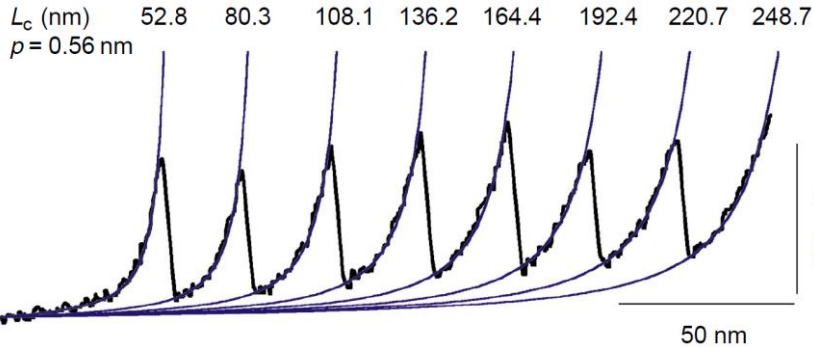

Cytoskeletal protein spectrin, N=6

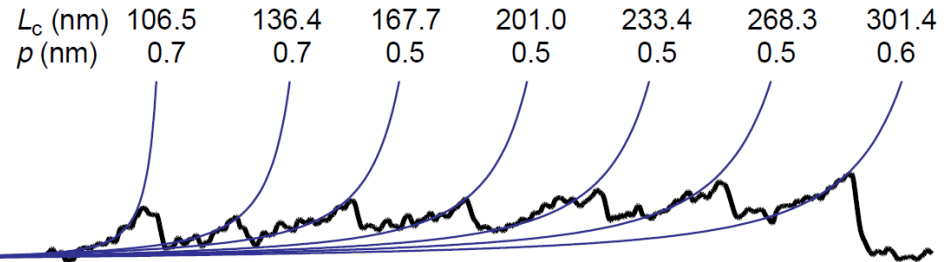

Protein I27₁₂, N=12

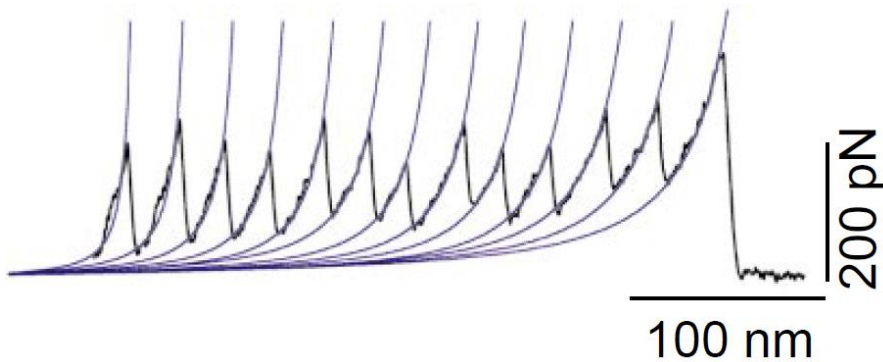

Sawtooth like curves

Titin, N=6 Ig domains

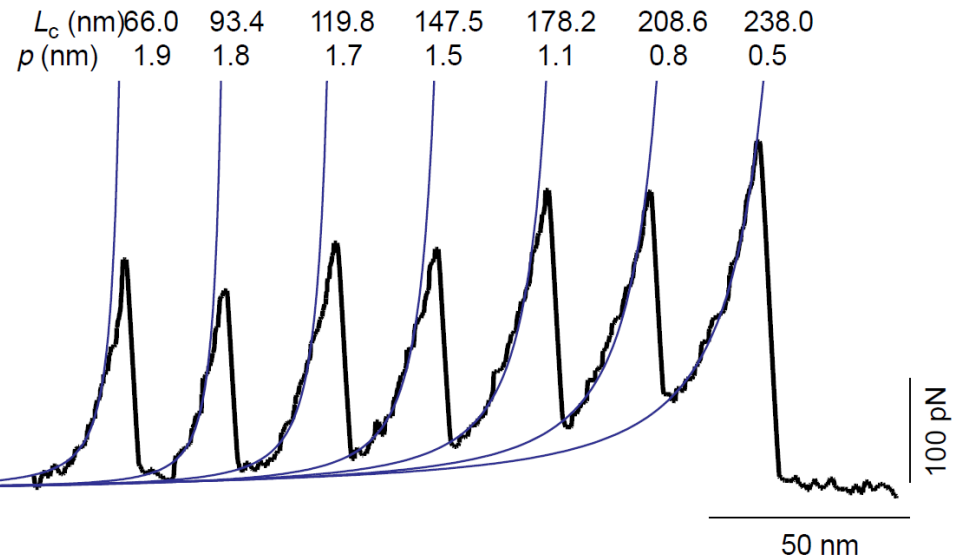

Chain with bistable elements

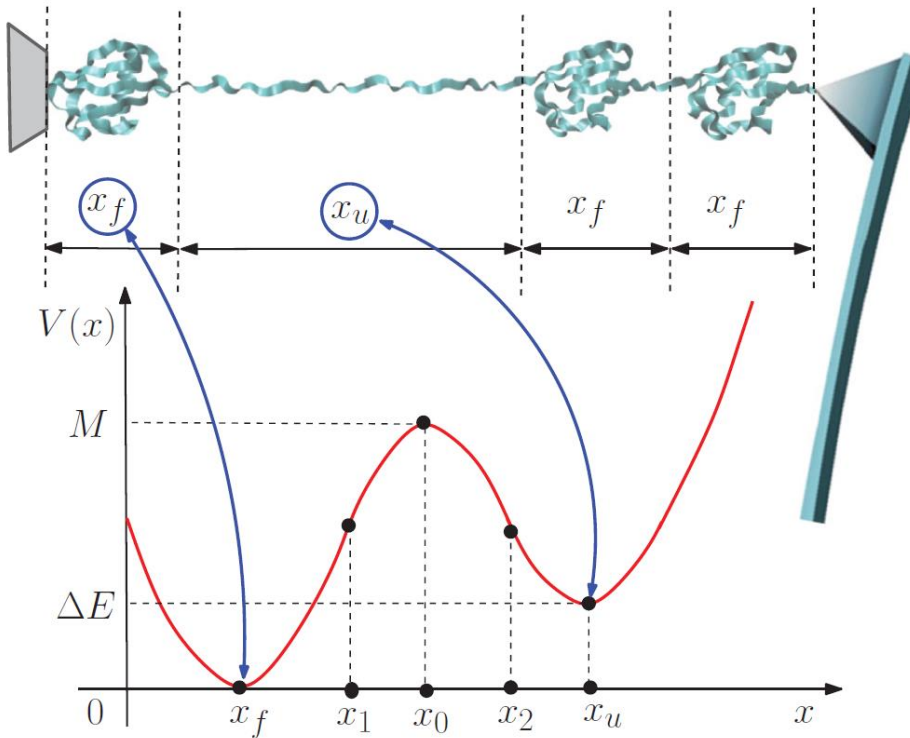

Potential energy function with an energy barrier M and two minima separated by an energy difference ΔE . Folded and unfolded domain lengths are x_f and x_u , respectively.

PHYSICAL REVIEW E **87**, 032705 (2013)

Pairing interaction potential:

$$V(x) = \begin{cases} \frac{1}{2}k(x - x_f)^2 & 0 < x < x_1 \\ -\frac{1}{2}k(x - x_0)^2 + M & x_1 < x < x_2 \\ \frac{1}{2}k(x - x_u)^2 + \Delta E & x > x_2. \end{cases}$$

Parameters:

$$\delta = x_u - x_f$$

$$x_0 = \frac{x_u + x_f}{2} + 2 \frac{\Delta E}{k\delta},$$

$$M = \frac{k}{4} \left[\frac{\delta}{2} + 2 \frac{\Delta E}{k\delta} \right]^2,$$

$$x_1 = x_f + \frac{\delta}{4} + \frac{\Delta E}{k\delta},$$

$$x_2 = x_u - \frac{\delta}{4} + \frac{\Delta E}{k\delta}.$$

Gibbs ensemble for a chain with bistable elements

Analytical **expression** for the Gibbs partition function:

$$Z_{\vec{f}}(\vec{f}, T) = \left(\frac{2\pi m}{\beta}\right)^{3N/2} \left(\frac{2\pi}{\beta \|\vec{f}\|}\right)^N \times \left[\Pi(\beta k, \beta \|\vec{f}\|, x_f, 0, x_1) + e^{-\beta M} \Pi(-\beta k, \beta \|\vec{f}\|, x_0, x_1, x_2) + e^{-\beta \Delta E} \Pi(\beta k, \beta \|\vec{f}\|, x_u, x_2, +\infty) \right]^N$$

PHYSICAL REVIEW E **87**, 032705 (2013)

where: $\Pi(\alpha, \gamma, x_0, a, b) = 2 \int_a^b x e^{-\frac{\alpha}{2}(x-x_0)^2} \sinh(\gamma x) dx$

$$\langle \vec{r}(\vec{f}, T) \rangle = k_B T \frac{\partial}{\partial \vec{f}} \log Z_{\vec{f}} = - \frac{\partial G(\vec{f}, T)}{\partial \vec{f}}$$

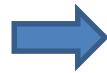

- The force plateau appears for $f = \Delta E / \delta$, where $\delta = x_u - x_f$.
- Unfortunately, the analytical approach cannot be used with the Helmholtz ensemble → Montecarlo

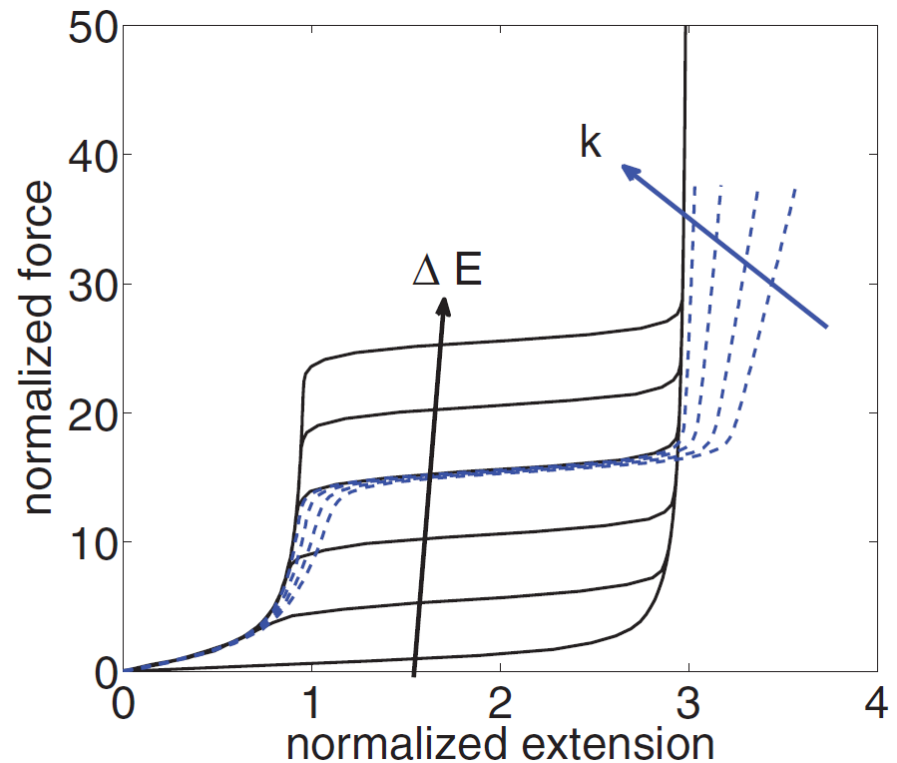

Ensemble comparisons with bistable elements

cantilever stiffness $\rightarrow 0$ (Gibbs ensemble)

conformational change occur **simultaneously**
for all the domains at a given threshold
force (cooperativity)

different results
for the **same polymer chain**

cantilever stiffness $\rightarrow \infty$ (Helmholtz ensemble)

conformational change **not simultaneously**
typical 'sawtooth' pattern: conformational
transformation of the domain geometry

but in practice, real experiments
always fall inbetween
these two ideal extremes!

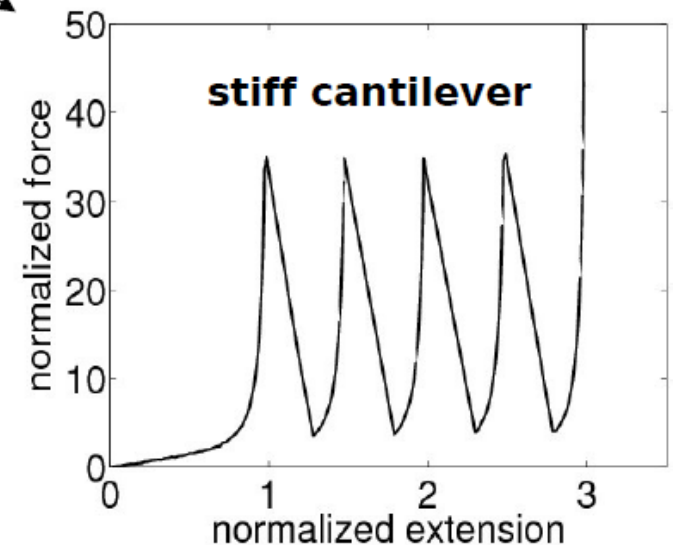
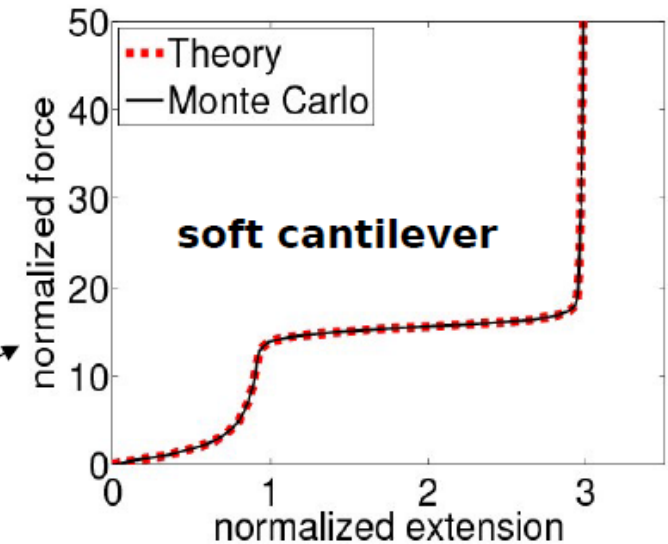

$N=4$



Overstretching regime, intermediate cases: not Gibbs nor Helmholtz

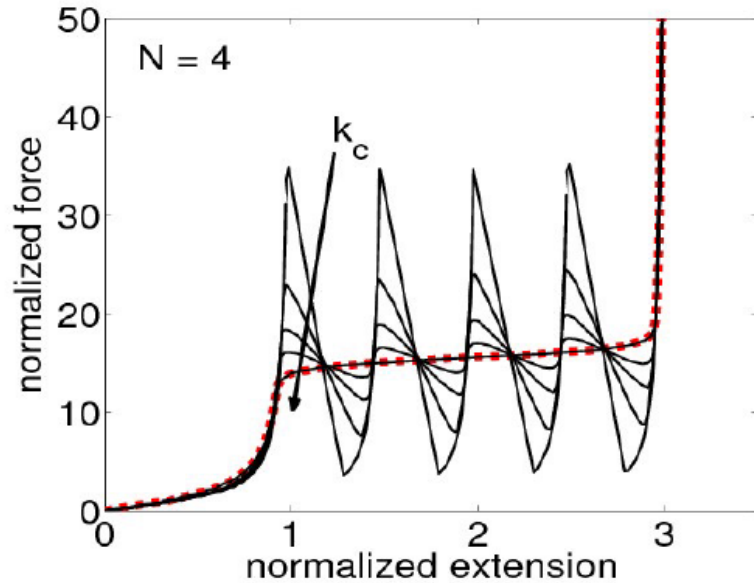

same polymers length
the transition from
the 'sawtooth' response
to the 'plateau'
is recovered for
decreasing values of the
cantilever stiffness k_c

the typical 'sawtooth'
pattern (titin) and the
'plateau' or kink (dextran),
have a **common origin** in
the **size-dependence** of the
polymer response to the
external force

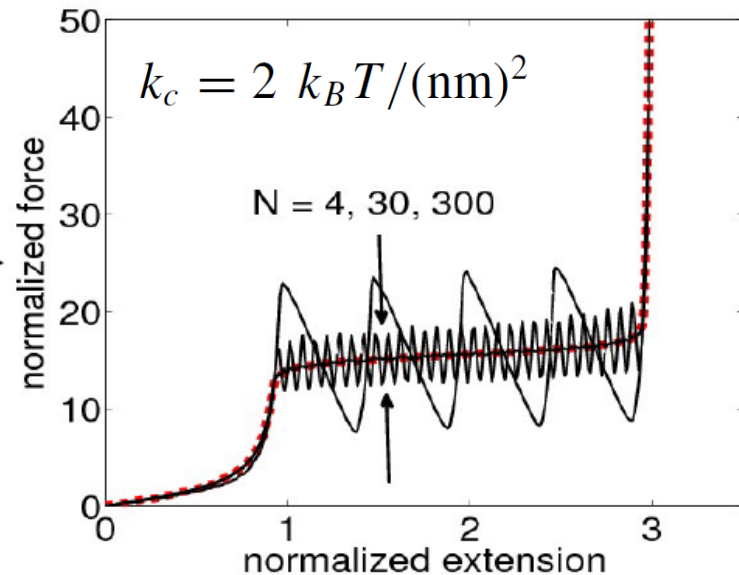

PHYSICAL REVIEW E 87, 032705 (2013)

Spin variables approach for multistable systems

We introduce a quadratic curve approximating each potential well of the multi-basin energy landscape of a unit of the chain.

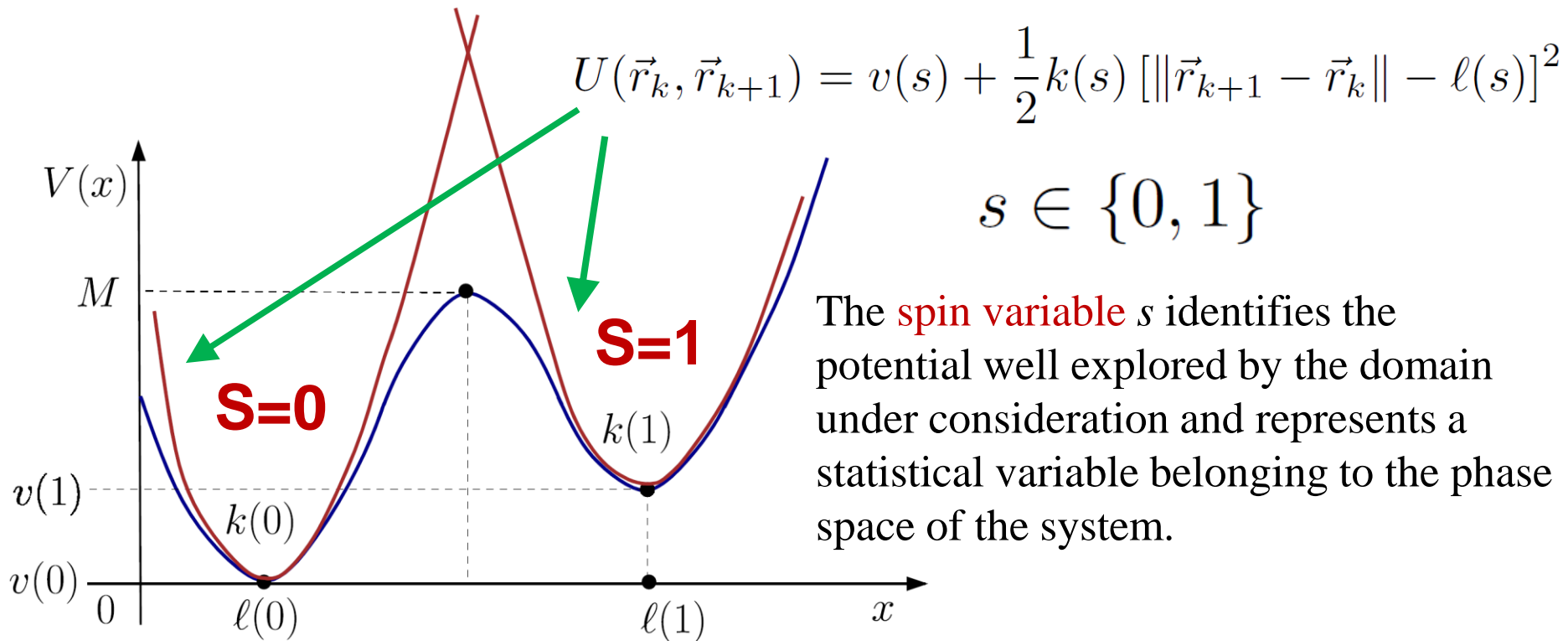

$$H = \sum_{i=1}^N \frac{\vec{p}_i \cdot \vec{p}_i}{2m} + \sum_{i=1}^N v(s_i) + \sum_{i=1}^N \frac{1}{2} k(s_i) [||\vec{r}_{k+1} - \vec{r}_k|| - \ell(s_i)]^2 - \vec{f} \cdot \vec{r}_N$$

Hamiltonian in the Gibbs ensembles

Calculation of the partition function in the Gibbs ensemble

$$Z_G = \sum_{s_1 \in \{0,1\}} \dots \sum_{s_N \in \{0,1\}} \int_{\mathbb{R}^{3N}} \int_{\mathbb{R}^{3N}} e^{-\frac{H(\vec{p}, \vec{q}, \vec{s})}{k_B T}} d\vec{p} d\vec{q}$$

or, equivalently, by considering the complete expression for the Hamiltonian:

$$Z_G = const. \times \left\{ \sum_{s \in \{0,1\}} \int_{\mathbb{R}^3} \exp \left[-\frac{v(s)}{k_B T} - \frac{k(s)}{2k_B T} \left[\|\vec{\xi}\| - \ell(s) \right]^2 + \frac{\vec{f} \cdot \vec{\xi}}{k_B T} \right] d\vec{\xi} \right\}^N$$

Because of the isotropy of the spring-like interactions, we have:

$$\begin{aligned} \vec{f} &= (0, 0, f), & d\vec{\xi} &= \xi^2 \sin \vartheta d\xi d\varphi d\vartheta \\ \|\vec{\xi}\| &= \xi, & \vec{f} \cdot \vec{\xi} &= f\xi \cos \vartheta \end{aligned}$$

$$Z_G = const. \times \left\{ \sum_{s \in \{0,1\}} e^{-\frac{v(s)}{k_B T}} \int_0^\infty \exp \left[-\frac{k(s)}{2k_B T} [\xi - \ell(s)]^2 \right] \frac{\sinh \left(\frac{f\xi}{k_B T} \right)}{\frac{f\xi}{k_B T}} \xi^2 d\xi \right\}^N$$

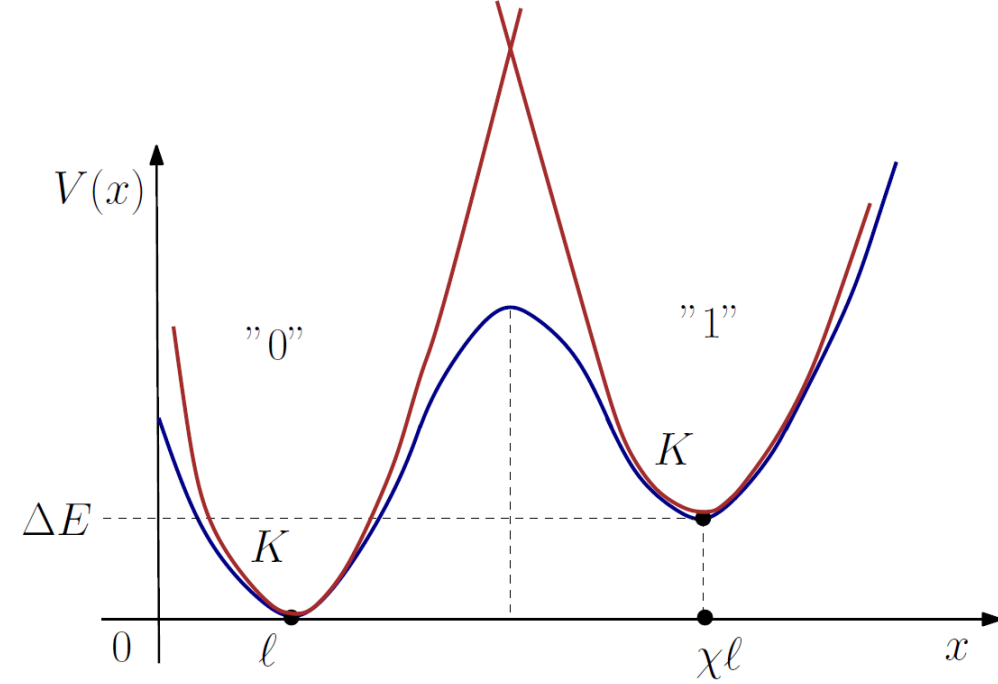

We define χ as the ratio between the unfolded and folded length of each domain and we consider each spring characterized by the stiffness K . Moreover, the energy difference between the stable states is ΔE .

$$s = 0 \Rightarrow v(0) = 0, \quad \ell(0) = l, \quad k(0) = K$$

$$s = 1 \Rightarrow v(1) = \Delta E, \quad \ell(1) = \chi l, \quad k(1) = K$$

$$Z_G = \text{const.} \times \left\{ \int_0^\infty \exp \left[-\frac{K}{2k_B T} [\xi - l]^2 \right] \frac{\sinh \left(\frac{f\xi}{k_B T} \right)}{\frac{f\xi}{k_B T}} \xi^2 d\xi \right. \\ \left. + e^{-\frac{\Delta E}{k_B T}} \int_0^\infty \exp \left[-\frac{K}{2k_B T} [\xi - \chi l]^2 \right] \frac{\sinh \left(\frac{f\xi}{k_B T} \right)}{\frac{f\xi}{k_B T}} \xi^2 d\xi \right\}^N$$

Bistable freely jointed chain under Gibbs conditions

In order to define a bistable freely jointed chain we assume that $K \rightarrow \infty$ (it means that the domain length is ℓ or $\chi\ell$) and by using the Delta representation

$$\sqrt{\frac{\alpha}{\pi}} e^{-\alpha x^2} \xrightarrow{\alpha \rightarrow \infty} \delta(x)$$

we obtain:

$$Z_G = \text{const.} \times \left\{ \frac{\sinh y}{y} + \chi e^{-\frac{\Delta E}{k_B T}} \frac{\sinh \chi y}{y} \right\}^N \quad \text{(BFJC)}$$

which is a direct generalization of classical freely jointed chain partition function

$$Z_G = \text{const.} \times \left\{ \frac{\sinh y}{y} \right\}^N \quad \text{(FJC)}$$

$$y = \frac{\ell f}{k_B T}$$

$$\langle r \rangle = k_B T \frac{\partial \log Z_G}{\partial f} = N \ell \frac{\mathcal{L}(y) + \chi^2 e^{-\frac{\Delta E}{k_B T}} \mathcal{L}(\chi y) \frac{\sinh \chi y}{\sinh y}}{1 + \chi e^{-\frac{\Delta E}{k_B T}} \frac{\sinh \chi y}{\sinh y}}$$

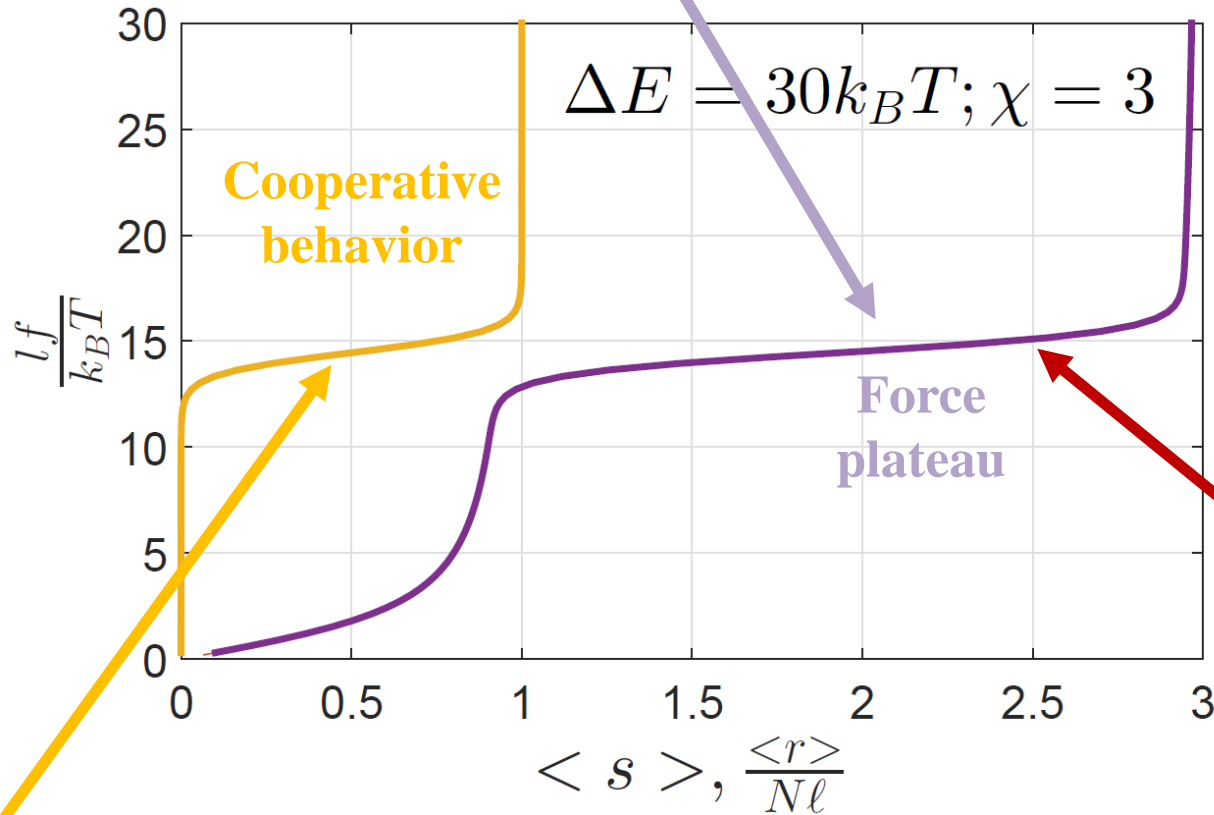

Langevin function:

$$\mathcal{L}(y) = \coth y - \frac{1}{y}$$

$$f^* = \frac{\Delta E}{(\chi - 1)\ell}$$

$$\langle s \rangle = \frac{1}{N} \left\langle \sum_{i=1}^N s_i \right\rangle = -k_B T \frac{\partial \log Z_G}{N \partial \Delta E} = \frac{\chi e^{-\frac{\Delta E}{k_B T}} \frac{\sinh \chi y}{\sinh y}}{1 + \chi e^{-\frac{\Delta E}{k_B T}} \frac{\sinh \chi y}{\sinh y}}$$

If we look at the obtained results:

$$\langle r \rangle = N\ell \frac{\mathcal{L}(y) + \chi^2 e^{-\frac{\Delta E}{k_B T}} \mathcal{L}(\chi y) \frac{\sinh \chi y}{\sinh y}}{1 + \chi e^{-\frac{\Delta E}{k_B T}} \frac{\sinh \chi y}{\sinh y}}$$

$$\langle s \rangle = \frac{\chi e^{-\frac{\Delta E}{k_B T}} \frac{\sinh \chi y}{\sinh y}}{1 + \chi e^{-\frac{\Delta E}{k_B T}} \frac{\sinh \chi y}{\sinh y}}$$

we can write:

$$\langle r \rangle = N \left[(1 - \langle s \rangle) \ell \mathcal{L}(y) + \langle s \rangle \chi \ell \mathcal{L}(\chi y) \right]$$

which is a linear combination of $N\ell\mathcal{L}(y)$ and $N\chi\ell\mathcal{L}(\chi y)$ (two freely jointed chain models), weighted by the average value of the spin variable.

Bistable freely jointed chain under Helmholtz conditions

The three-dimensional Laplace transform between the Gibbs and Helmholtz partition functions can be written in scalar form for radially symmetric functions:

$$Z_H(r) = \int_{-\infty}^{+\infty} Z_G(i\eta) \frac{\eta}{r} \sin \frac{\eta r}{k_B T} d\eta$$

(BFJC)

$$Z_H(r) = \int_{-\infty}^{+\infty} \left\{ \frac{\sin y}{y} + \chi\phi \frac{\sin \chi y}{y} \right\}^N \frac{y}{r} \sin \frac{ry}{\ell} dy$$

which is a direct generalization of the classical Rayleigh-Polya integral describing the freely jointed chain partition function:

$$Z_H(r) = \int_{-\infty}^{+\infty} \left\{ \frac{\sin y}{y} \right\}^N \frac{y}{r} \sin \frac{ry}{\ell} dy$$

(FJC)

Calculation of the partition function in the Helmholtz ensemble

The analysis of the integral through the complex variables method allows the exact calculation in the following form:

$$Z_H(r) = \frac{\pi}{r 2^{(N-1)} (N-2)!} \sum_{k=0}^N \sum_{p=0}^{N-k} \sum_{q=0}^k \binom{N}{k} \binom{N-k}{p} \binom{k}{q} (-1)^{p+q} \alpha^k (-\Lambda)^{N-2} \mathbf{1}(\Lambda)$$

where:

Soft Matter 13, 6877-6893 (2017)

$$\alpha = \chi e^{-\frac{\Delta E}{k_B T}} \quad \text{and} \quad \Lambda = k - N + 2p - \chi k + 2\chi q - \frac{r}{\ell}$$

and we can determine the average values of **force** and **spin**

$$\langle f \rangle = -k_B T \frac{\partial \log Z_H}{\partial r}$$

$$\langle s \rangle = \frac{1}{N} \left\langle \sum_{i=1}^N s_i \right\rangle = -k_B T \frac{\partial \log Z_H}{N \partial \Delta E}$$

f (Gibbs)

$$\langle f \rangle = -k_B T \frac{\partial \log Z_H}{\partial r}$$

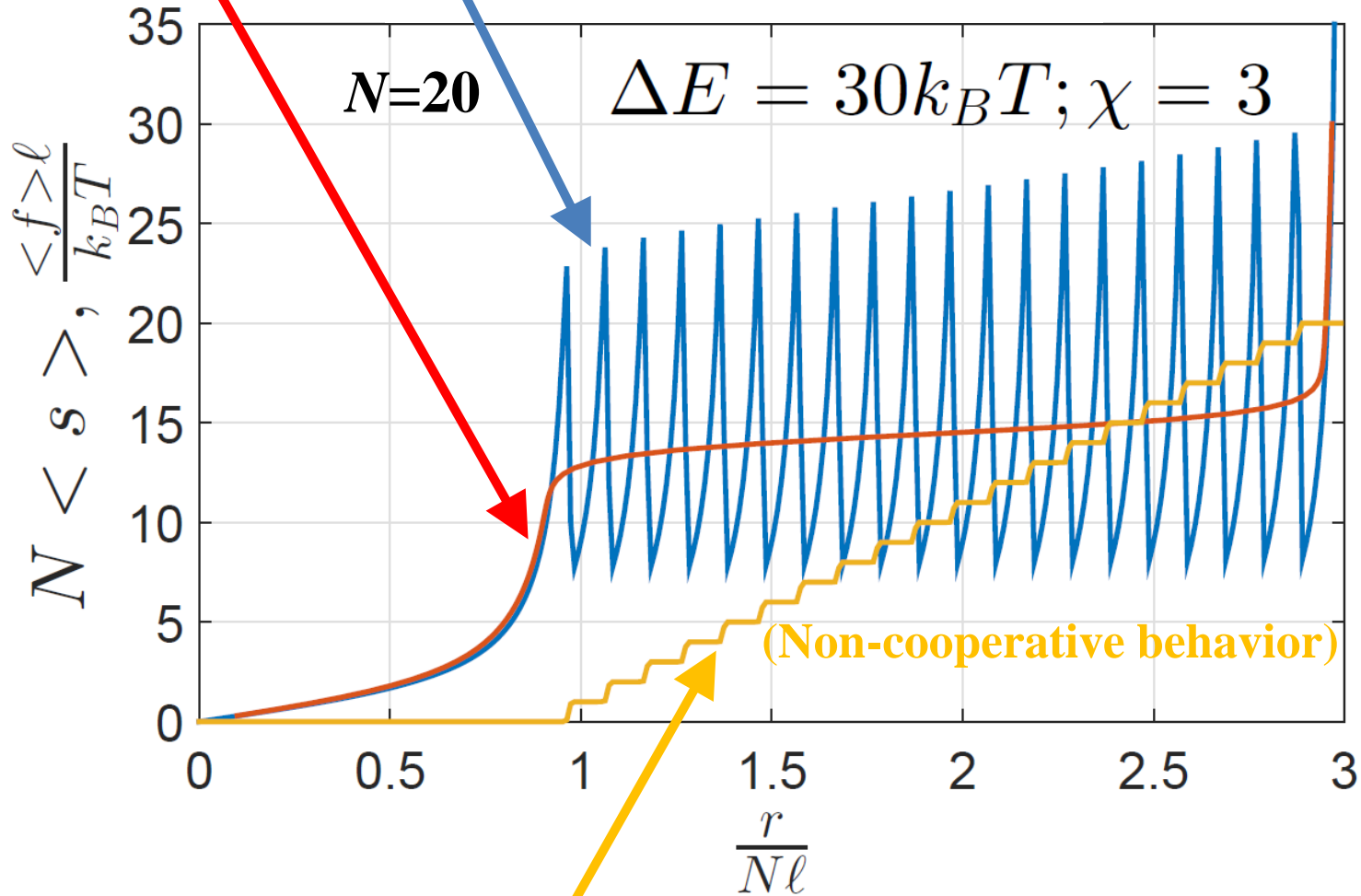

$$N \langle s \rangle = \left\langle \sum_{i=1}^N s_i \right\rangle = -k_B T \frac{\partial \log Z_H}{\partial \Delta E}$$

Equivalence of the ensembles in the thermodynamic limits

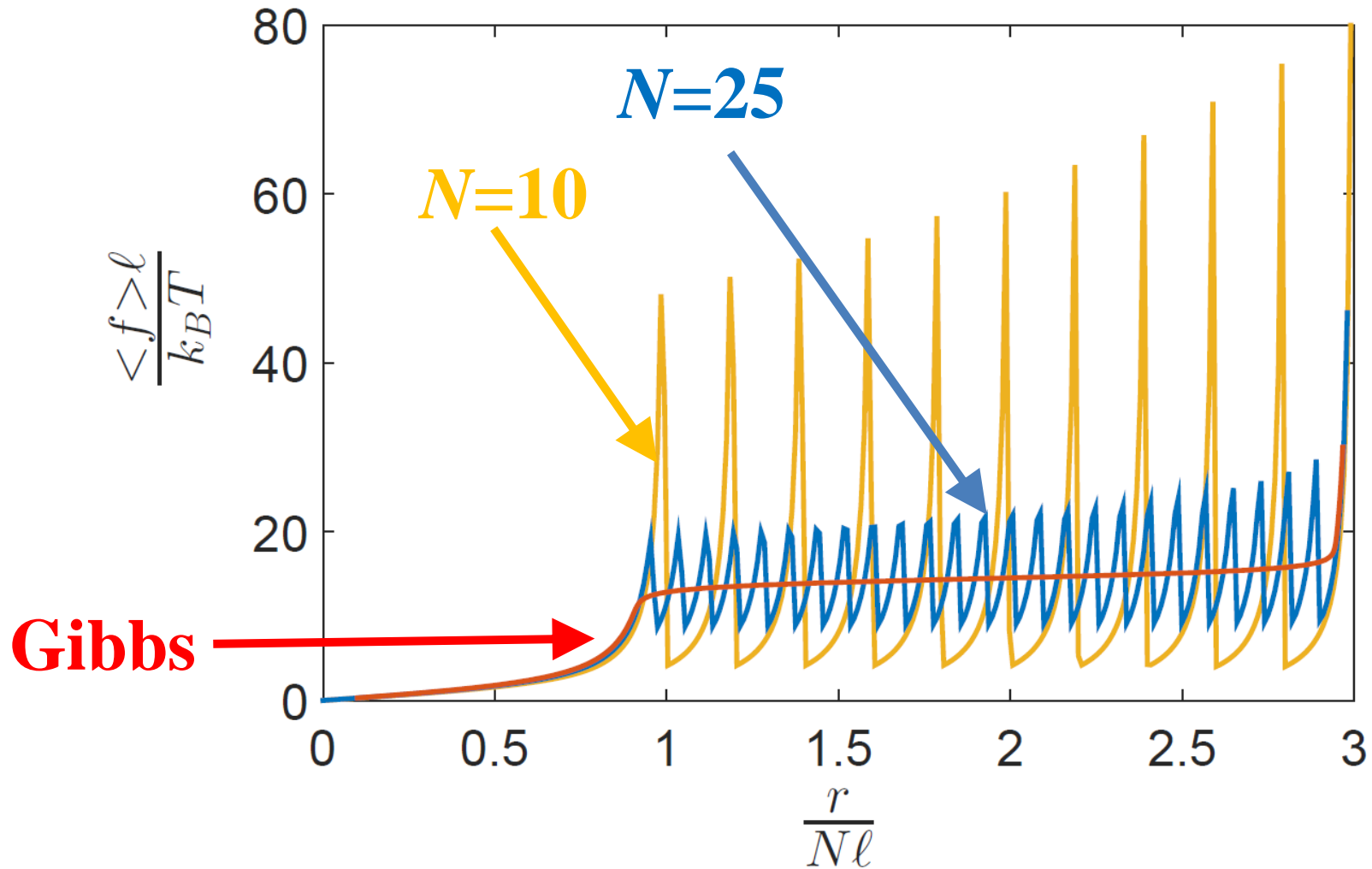

Soft Matter 13, 6877-6893 (2017)

Continuum Mechanics and Thermodynamics 30, 459 (2018)

Critical behavior

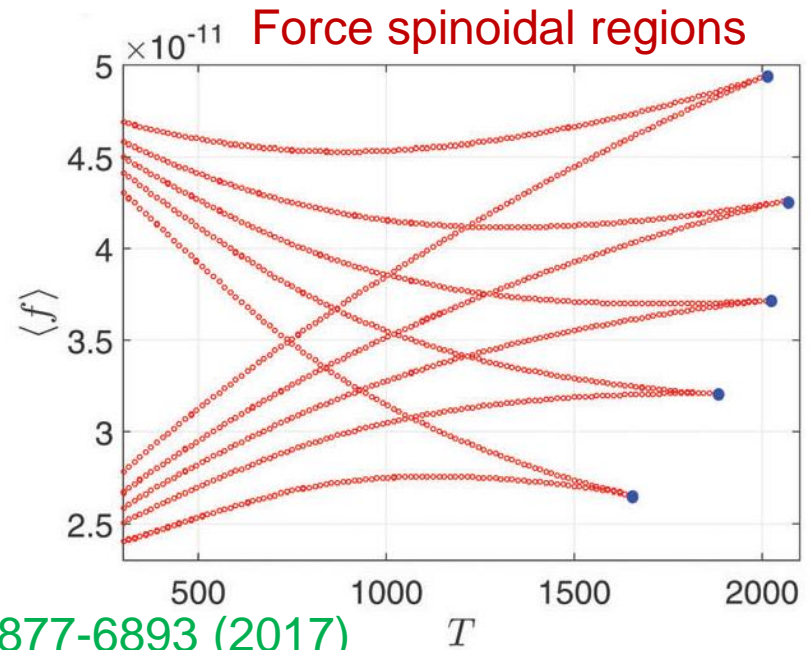
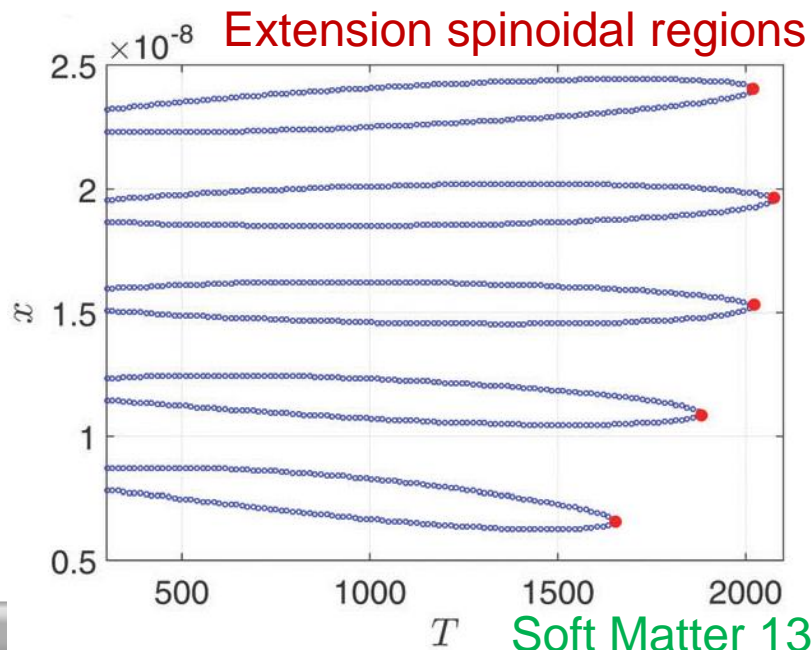
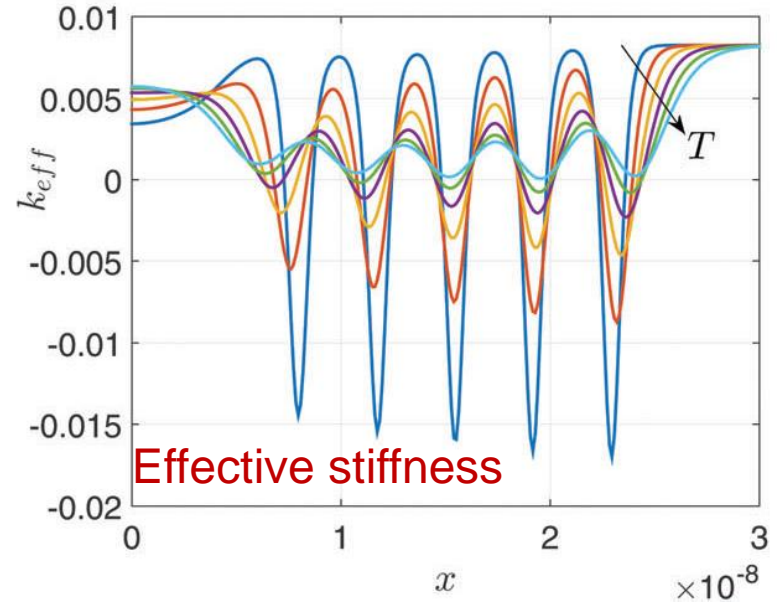
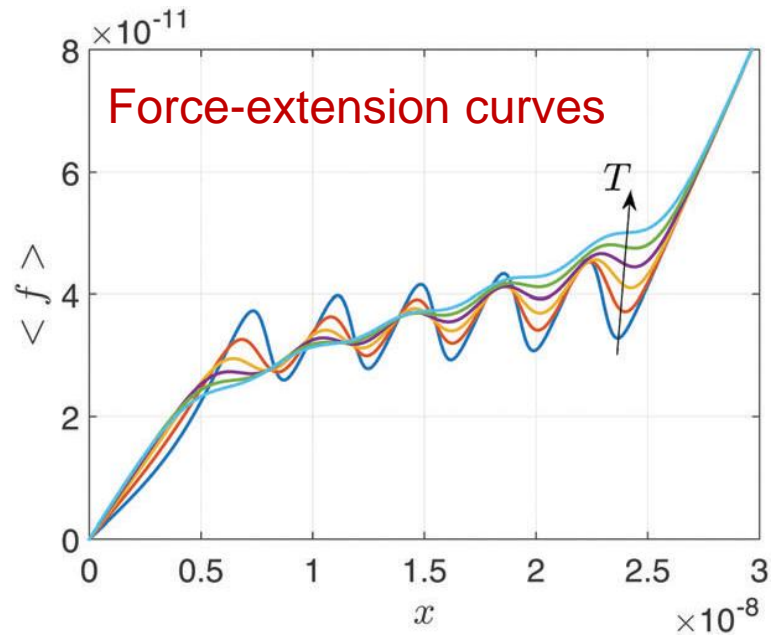

Two-state freely jointed chains with extensible units

a) Gibbs ensemble

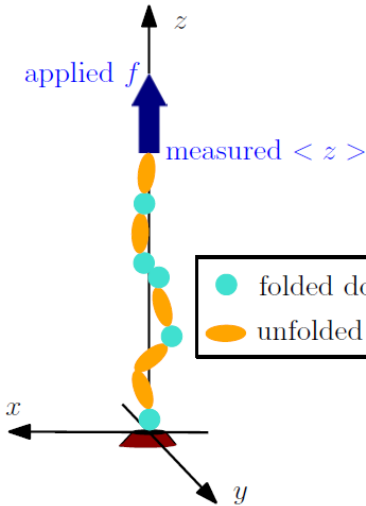

b) Helmholtz ensemble

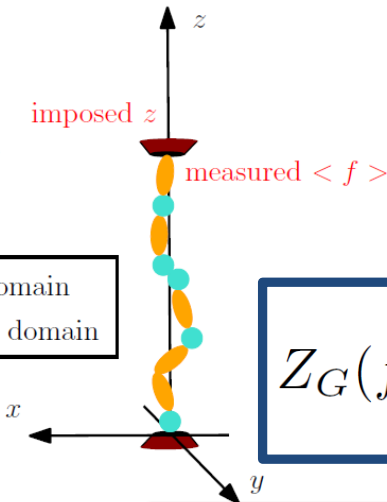

Dimensionless extensibility

$$\alpha = \frac{K_B T}{k \ell^2}$$

Dimensionless force

$$y = \frac{\ell f}{k_B T}$$

$$Z_G(f) = \left(\frac{\sinh y}{y} + \phi \chi \frac{\sinh \chi y}{y} \right)^N \exp \left(\frac{N \alpha y^2}{2} \right)$$

$$Z_H(r) = -\frac{1}{2r} \sum_{k=0}^N \sum_{p=0}^{N-k} \sum_{q=0}^k \binom{N}{k} \binom{N-k}{p} \binom{k}{q} (-1)^{p+q} \\ \times (\chi \phi)^k \left[\sqrt{\pi} \left(\frac{N \alpha}{2} \right)^{\frac{N-2}{2}} e^{-\frac{\Lambda^2}{2N \alpha}} H_{-N+1} \left(\frac{\Lambda}{\sqrt{2N \alpha}} \right) \right. \\ \left. + \mathbf{1}(\Lambda) \sum_{h=0}^{\lfloor \frac{N}{2} - 1 \rfloor} \frac{(-1)^{N-1} \pi \left(\frac{\Lambda}{2} \right)^{N-2}}{h!(N-2-2h)!} \left(\frac{N \alpha}{2 \Lambda^2} \right)^h \right],$$

$$\Lambda = k - N + 2p - \chi k + 2\chi q - \frac{r}{\ell}$$

$$k = 0.4 j \text{ N/m}, \forall j = 1, \dots, 6$$

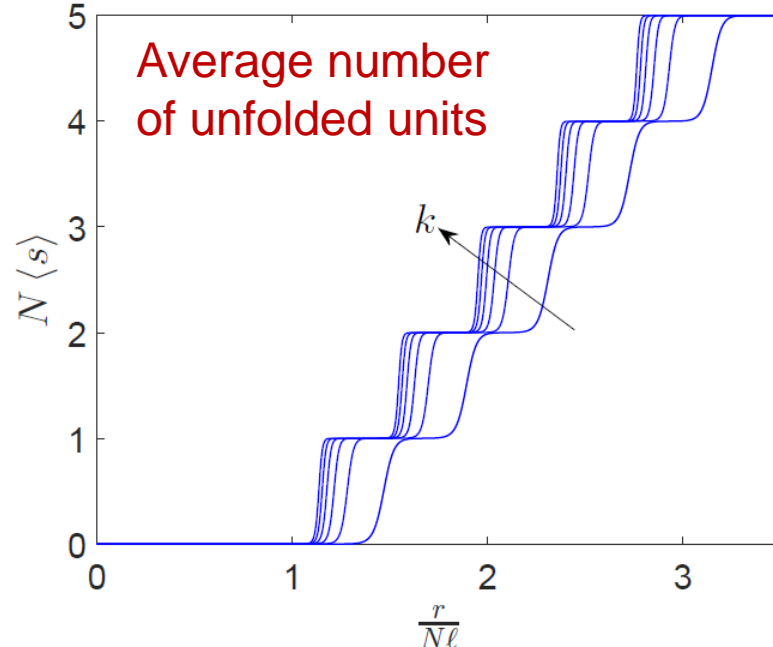
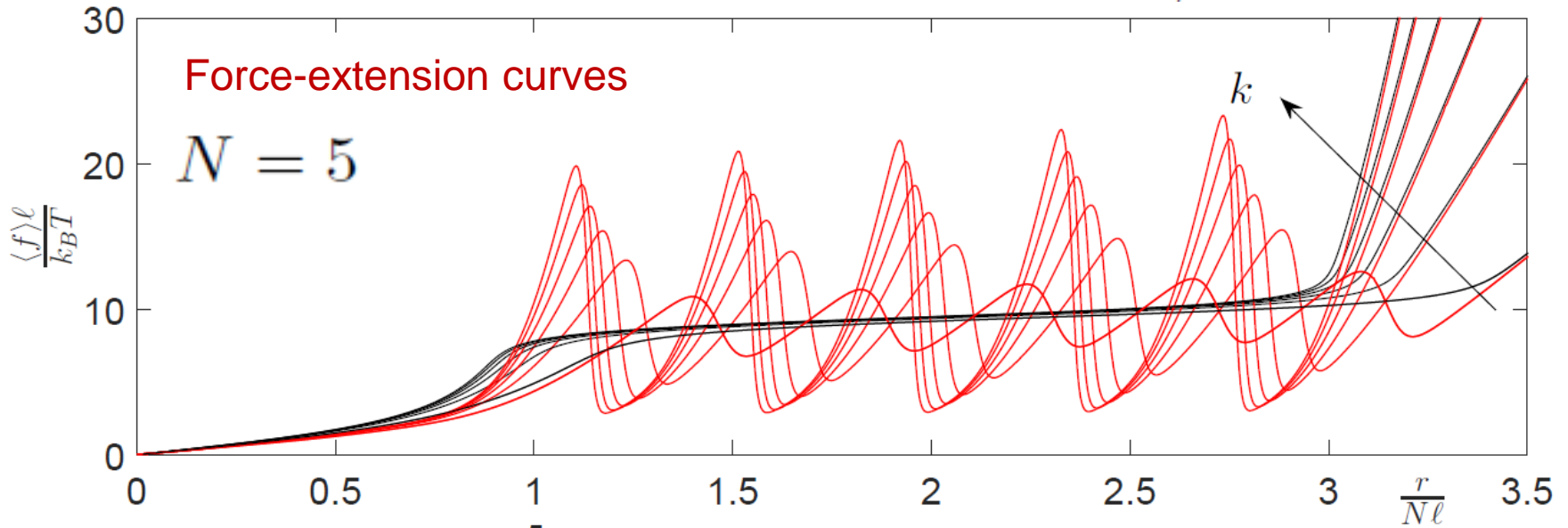

(JCP submitted)

The interactions among the units

Ising potential energy ($s_i = -1, +1$; $\lambda > 0$ ou $\lambda < 0$):

$$U_{tot} = -\lambda \sum_{i=1}^{N-1} s_i s_{i+1} - \vec{f} \cdot \vec{r}_N + \sum_{i=1}^N \left\{ v(s_i) + \frac{1}{2} k(s_i) \left[\|\vec{r}_i - \vec{r}_{i-1}\| - \ell(s_i) \right]^2 \right\}$$

(coupling between elasticity and units folded-unfolded states)

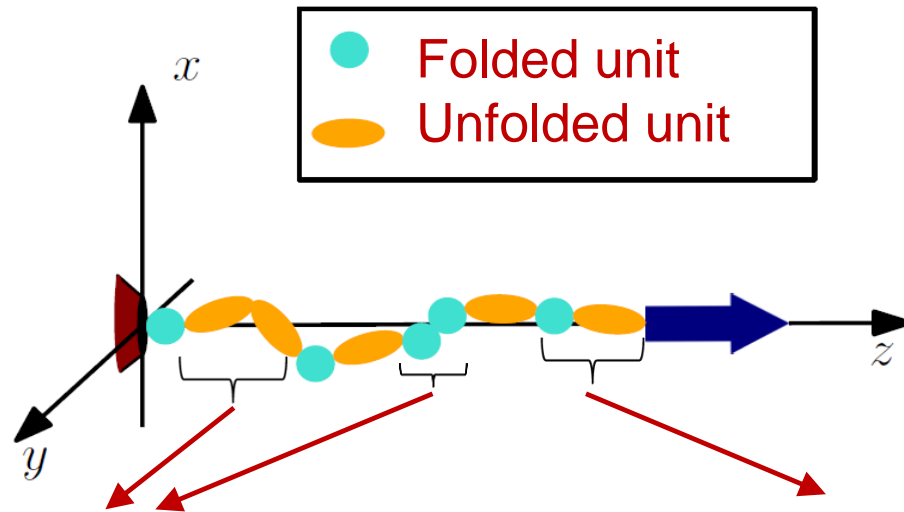

Positive interaction ($\lambda > 0$),
analogy with *ferromagnetism*

Negative interaction ($\lambda < 0$)
analogy with *antiferromagnetism*

(PRE submitted)

Gibbs ensemble

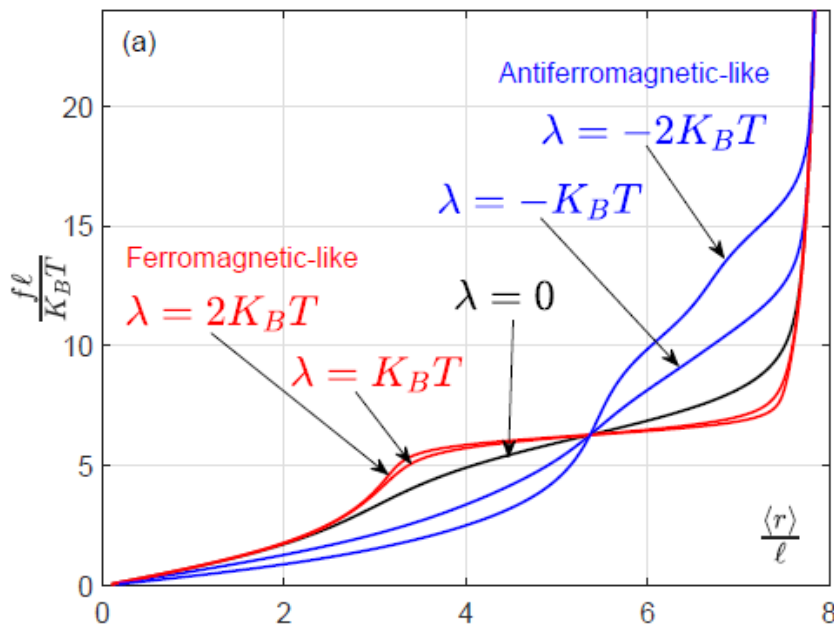
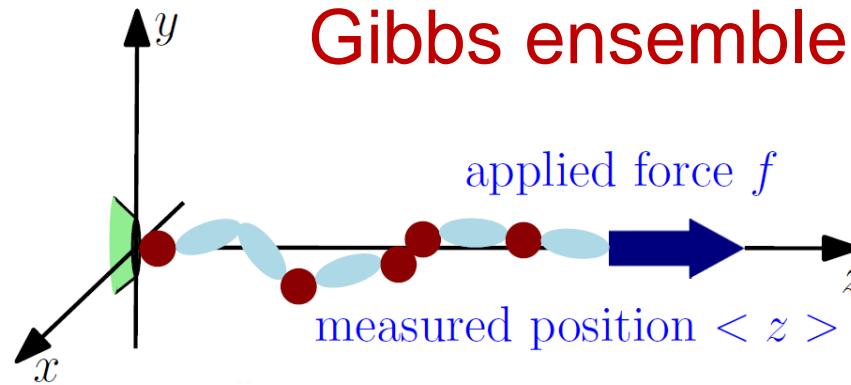

Force-extension curves

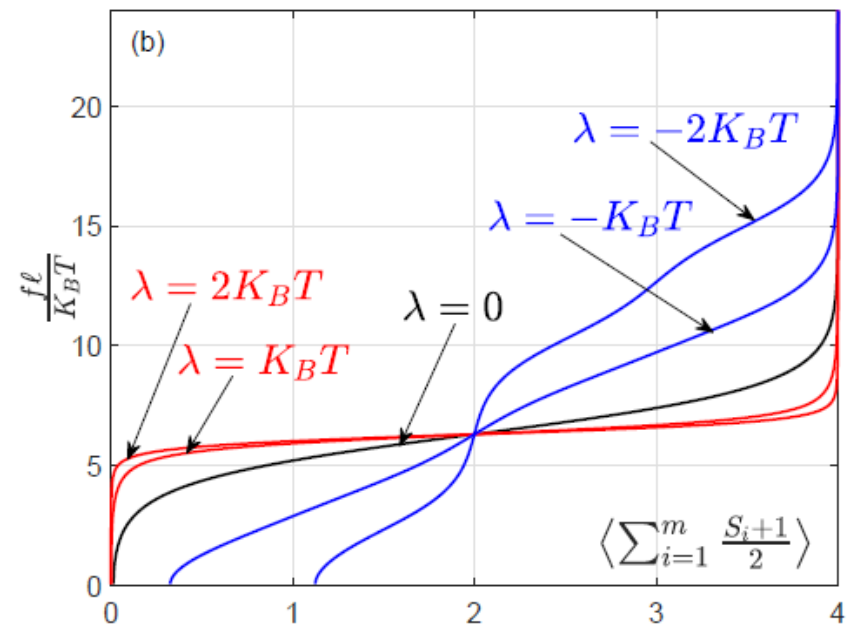

Average number of unfolded units

Helmholtz ensemble

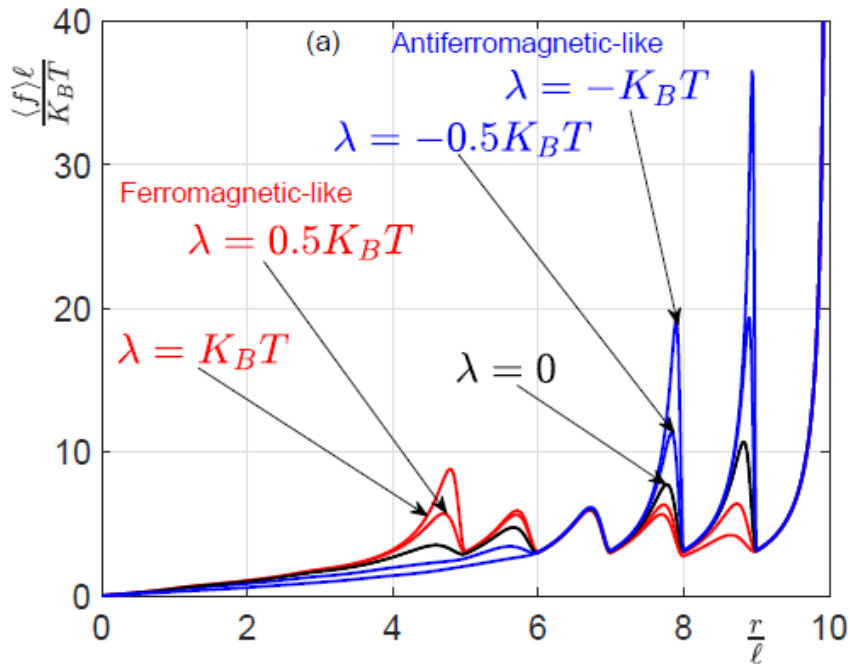
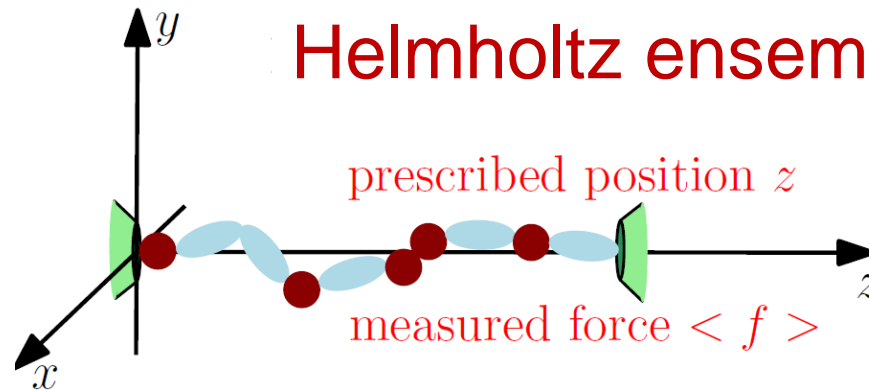

Force-extension curves

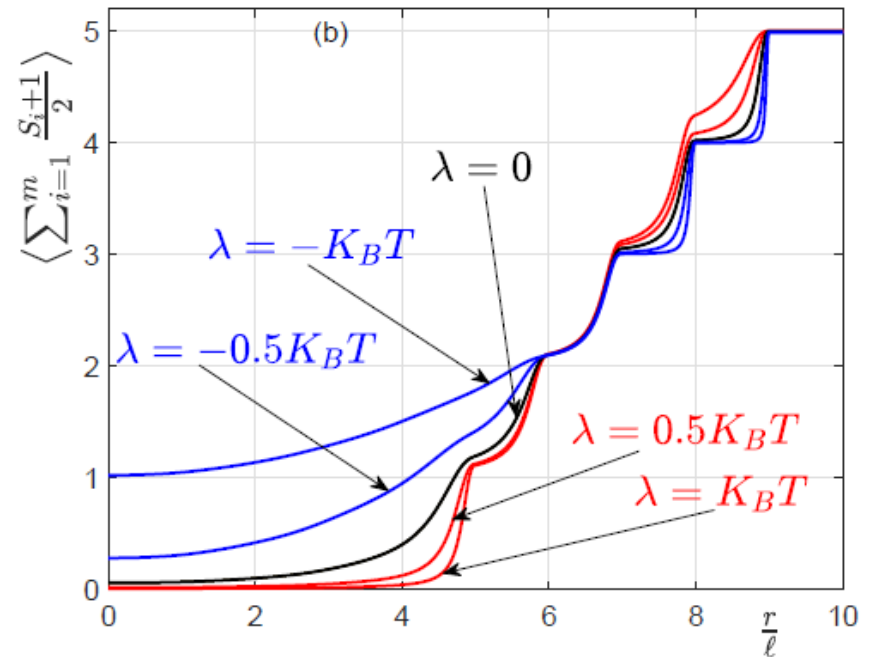

Average number of unfolded units

Perspective: heterogeneity of the chain

Heterogeneous units
with respects to:

- Unit length
- Unit stiffness
- Energy jump

(*topologic et energetic
heterogeneity*)

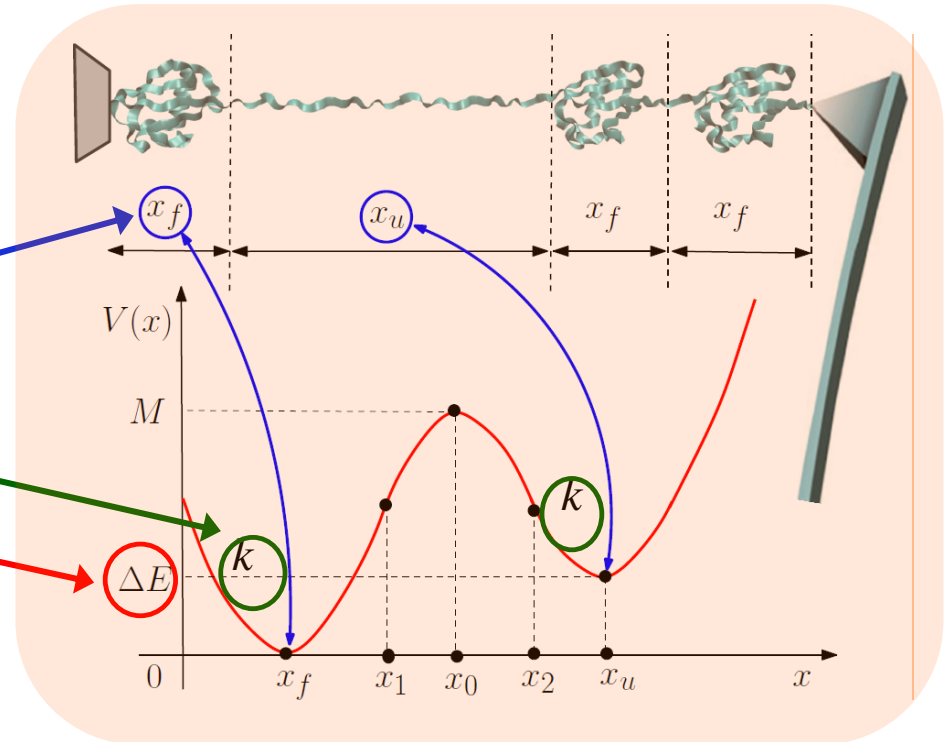

Without heterogeneity

- ✓ Same unfolding probability for the units;
- ✓ We cannot have an unfolding pathway.

Perspective: heterogeneity of the chain

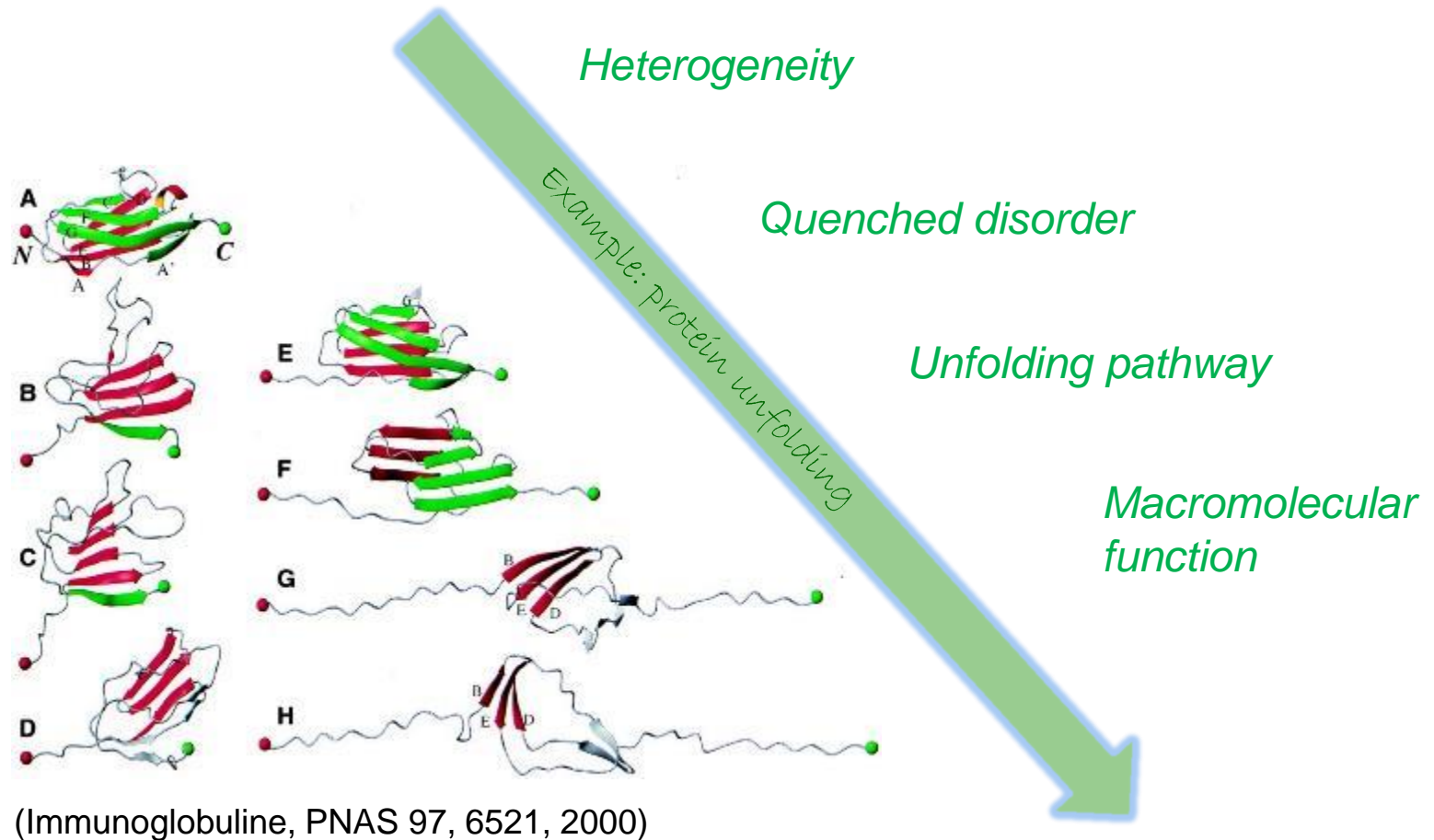

Perspective: unfolding dynamics

Constant pulling velocity of the tethered chain

Force peaks histograms

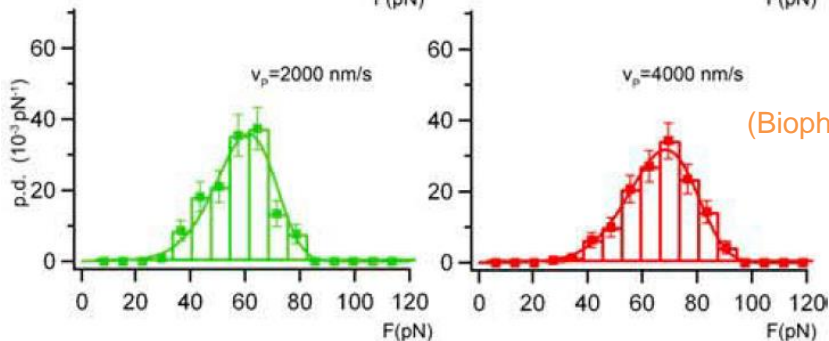
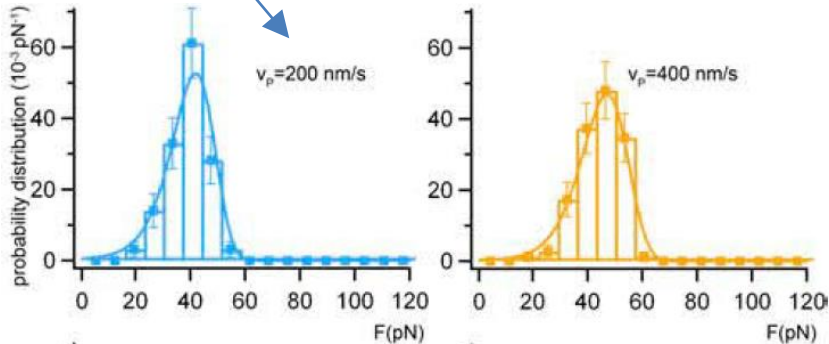
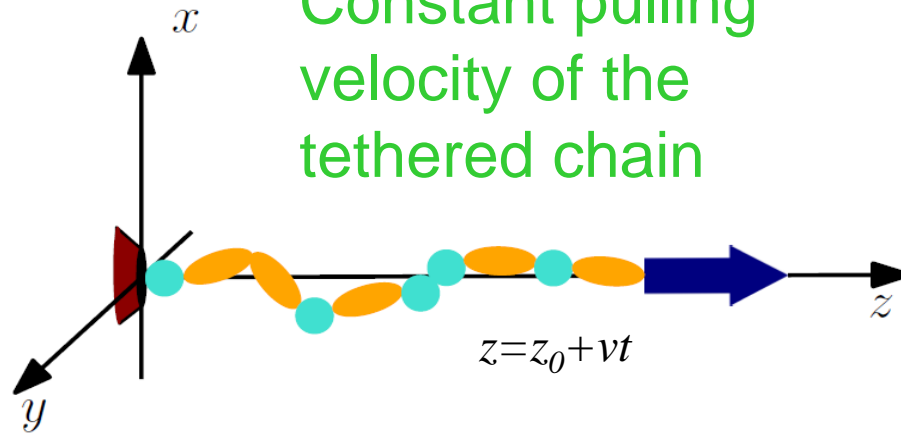

(Biophys. J. 90, L33, 2006)

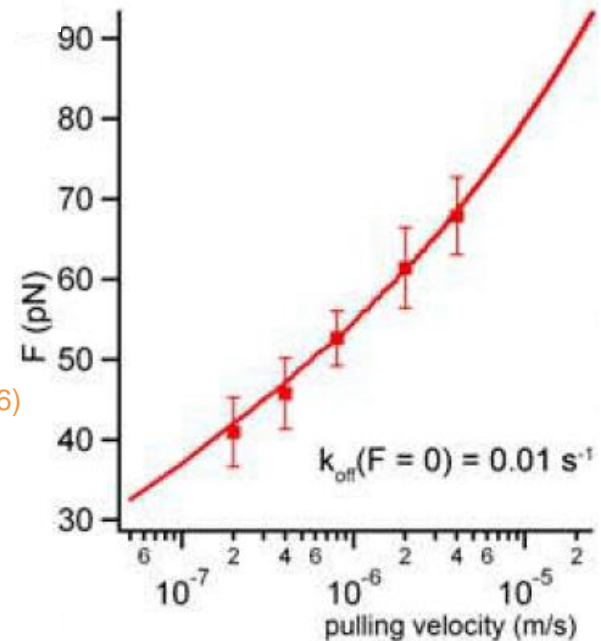

Perspective: unfolding dynamics

Exploiting the spin variable approach to

decoupling the characteristic times

mechanical

induced by energy barriers

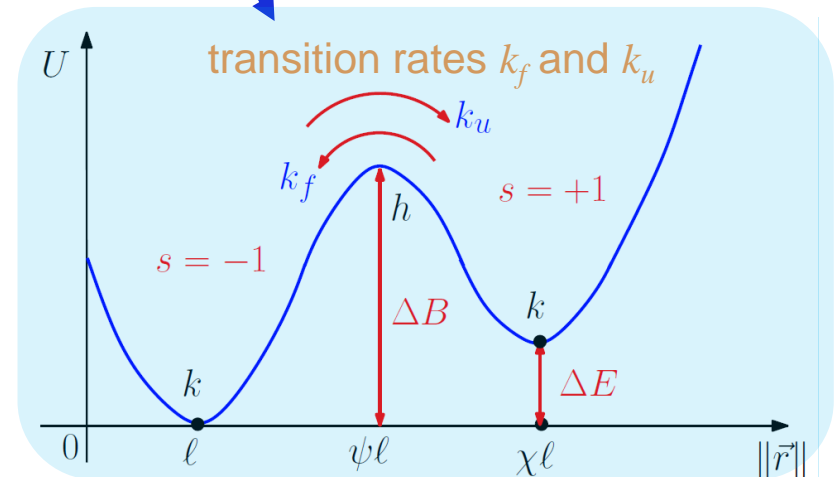
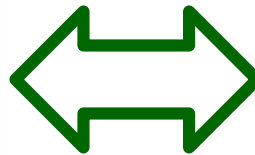
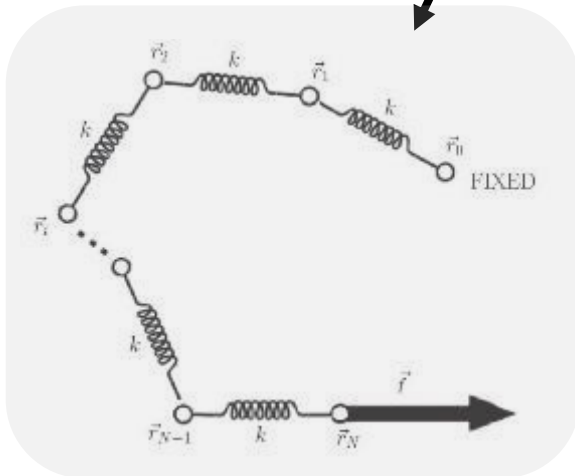

Conclusion

- The rescaling (multiscale) methods for the **nanomechanics of macromolecules** strongly depend on the applied **boundary conditions** (imposed force or prescribed extension);
- This is important for the **thermodynamic of small systems**, which are far from the thermodynamic limit (small number of unit in the chains);
- The **spin variable approach** allows the analysis of the system within both the **Gibbs and Helmholtz ensembles**, giving results in qualitative agreement with experiments;
- Moreover, it can be adopted to develop several generalization concerning **finite stiffness** and **Ising interactions** (already implemented) or **heterogeneity** and **dynamics** (work on progress);
- Interactions and heterogeneity will help the understanding of **cooperativity and folding pathways** in complex macromolecules (such as proteins).

THANK YOU FOR YOUR ATTENTION !

Main publications:

JCP 137, 244907 (2012)

JCP 136, 154906 (2012)

PRE 87, 032705 (2013)

Phys. A: Stat. Mech. Appl. 395, 154 (2014)

PRL 113, 255501 (2014)

EPJE 38, 44 (2015)

Eur. J. Mech. - A/Sol. 60, 145 (2016)

Annalen der Physik 528, 381 (2016)

Microsystems & Nanoengineering 2, 16062 (2016)

Soft Matter 13, 6877-6893 (2017)

Continuum Mechanics and Thermodynamics 30, 459 (2018)