

Force-extension response of macromolecular chains with bistable units

Manon Benedito¹, Stefano Giordano

¹ manon.oliveira-benedito@centralelille.fr

JPN, 27 juin 2019, Polytech'Lille

Contents

- Context
- Force spectroscopy
- Bistable chains
- Spin variable
- Gibbs and Helmholtz ensembles
- Generalizations of the theory:
 1. Extensibility
 2. Interactions
 3. Heterogeneity
- Perspectives and conclusion

Context

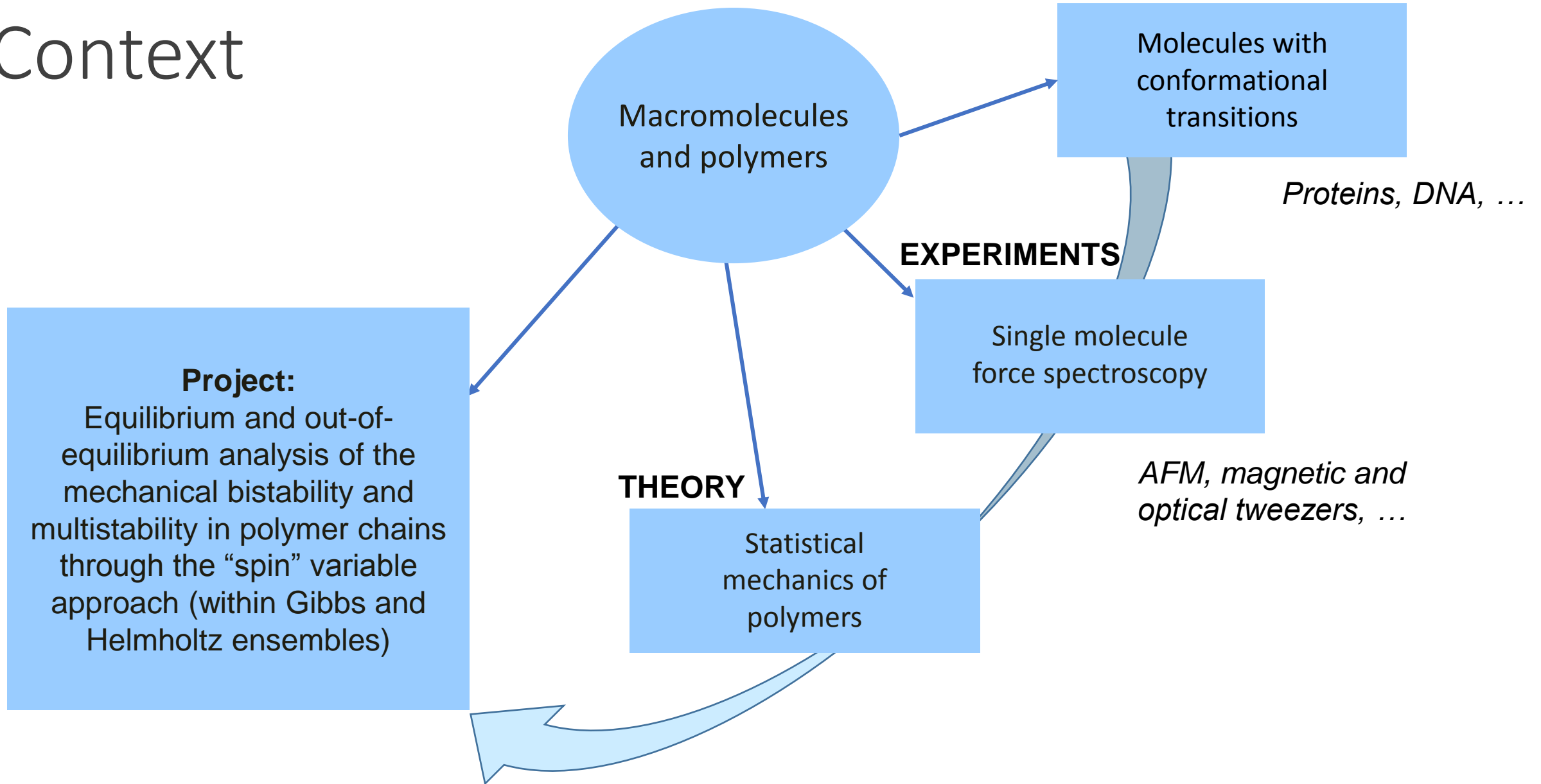

Force spectroscopy

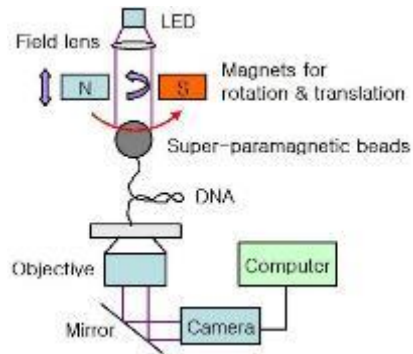

Magnetic tweezers

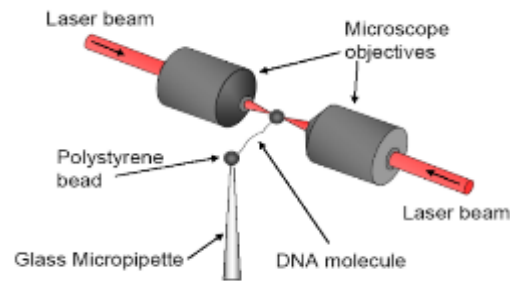

Optical tweezers

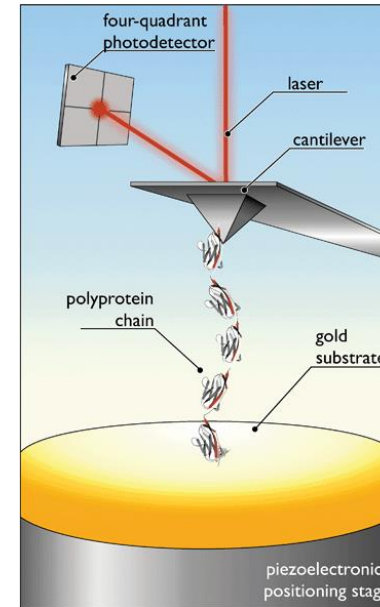

Atomic force microscope

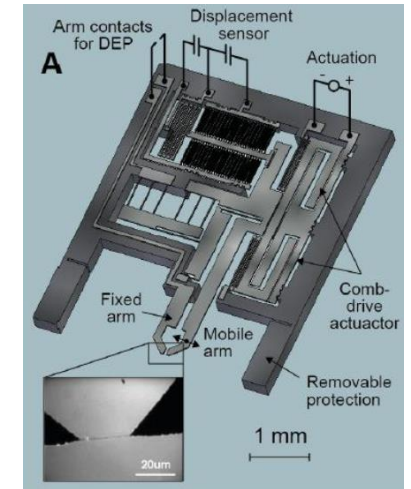

MEMS

Devices with variable stiffness k_c : $10^{-5} \text{ pN.nm}^{-1} - 10^4 \text{ pN.nm}^{-1}$

Soft devices

Hard devices

Bistable chains

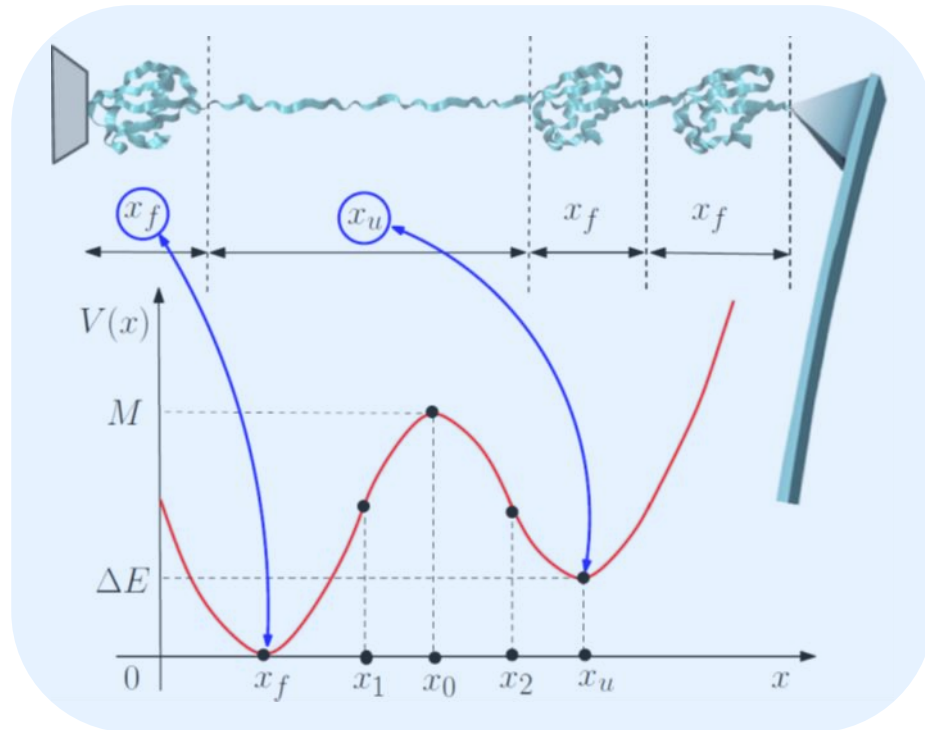

- Conformational transitions in macromolecules observed by force-spectroscopy methodologies.

(Strick et al., 2003 ; Ritort, 2006...)

- Two potential wells corresponding to two stable states : folded (native) and unfolded.

Spin variable

The spin variable s

- identifies the **potential well explored** by the domain under consideration ;
- is a discrete variable ;
- represents a **statistical variable** belonging to the phase space of the system.

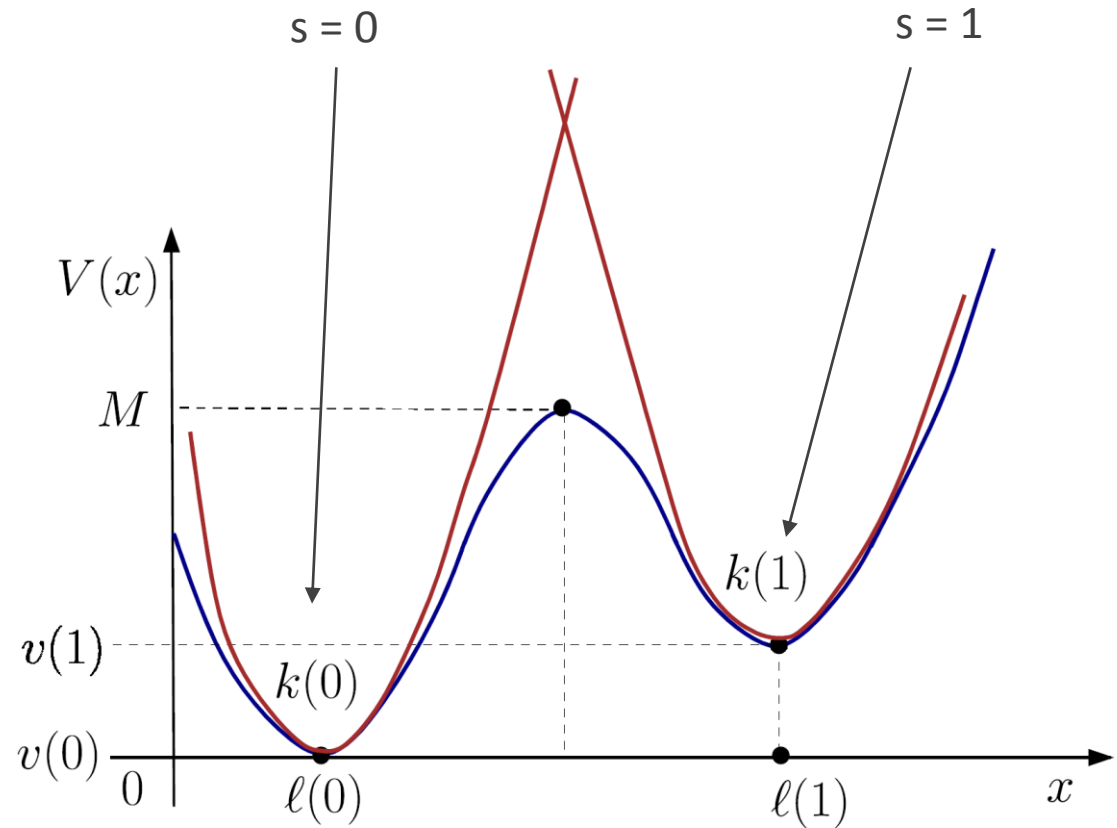

Giordano, Soft Matter **13**, 6877-6893 (2017)

Bistable behavior

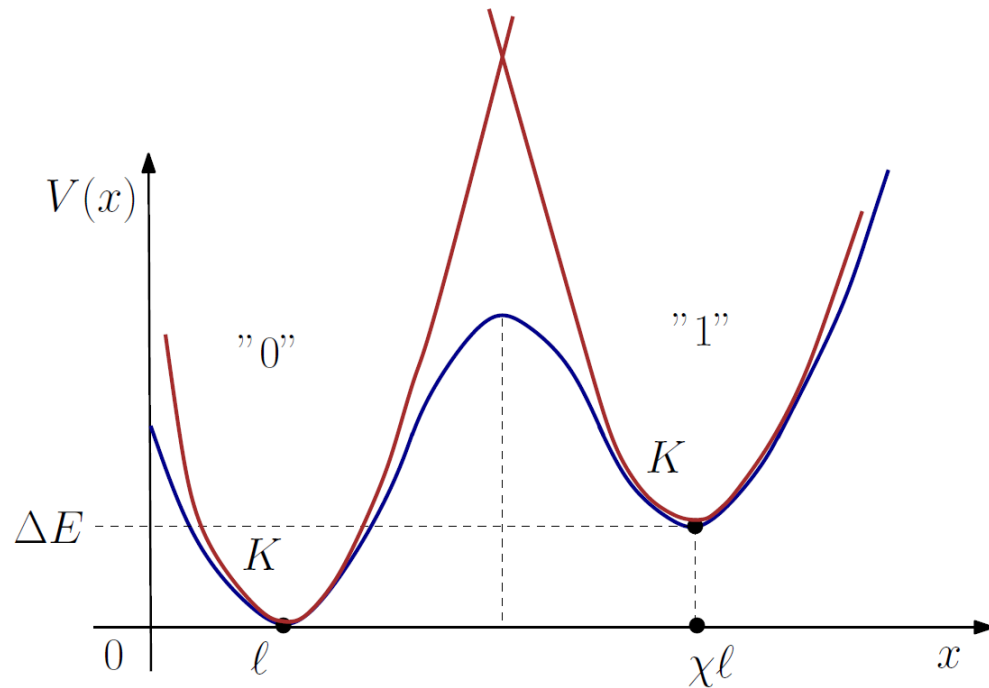

$$s = 0 \rightarrow \begin{aligned} V(0) &= 0; \\ x(0) &= \ell; \\ k(0) &= K. \end{aligned}$$

$$s = 1 \rightarrow \begin{aligned} V(1) &= \Delta E; \\ x(1) &= \chi\ell; \\ k(1) &= K. \end{aligned}$$

We define

- χ the ratio between the unfolded and folded lengths of each domain ;
- K the stiffness characterizing each spring ;
- ΔE the energy difference between the stable states.

Hamiltonian function

Free polymer: the first monomer unit is fixed, but the others are free to fluctuate.

(3D model)

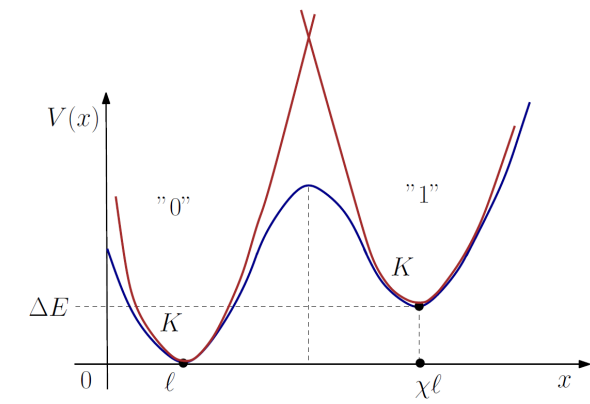

Bistable behavior

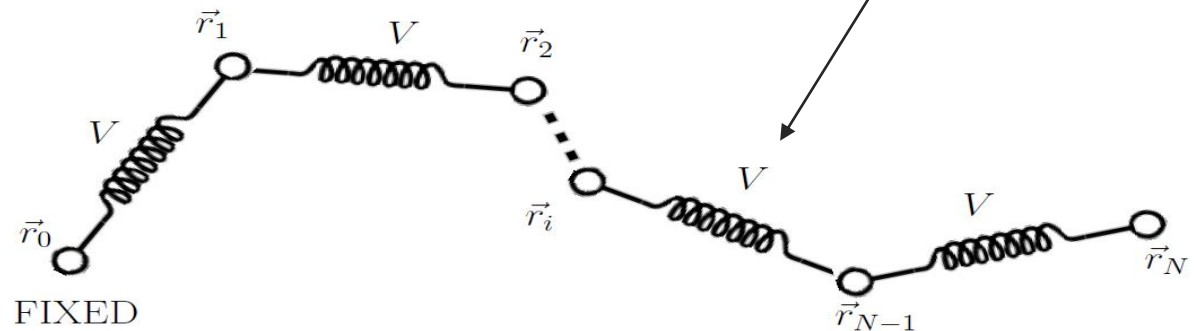

$$H = \sum_{i=1}^N \frac{\vec{p}_i \cdot \vec{p}_i}{2M} + U(\vec{r}_1, \dots, \vec{r}_N, S_1, \dots, S_N)$$

Hamiltonian of the system,
with arbitrary interactions.

Gibbs and Helmholtz ensembles

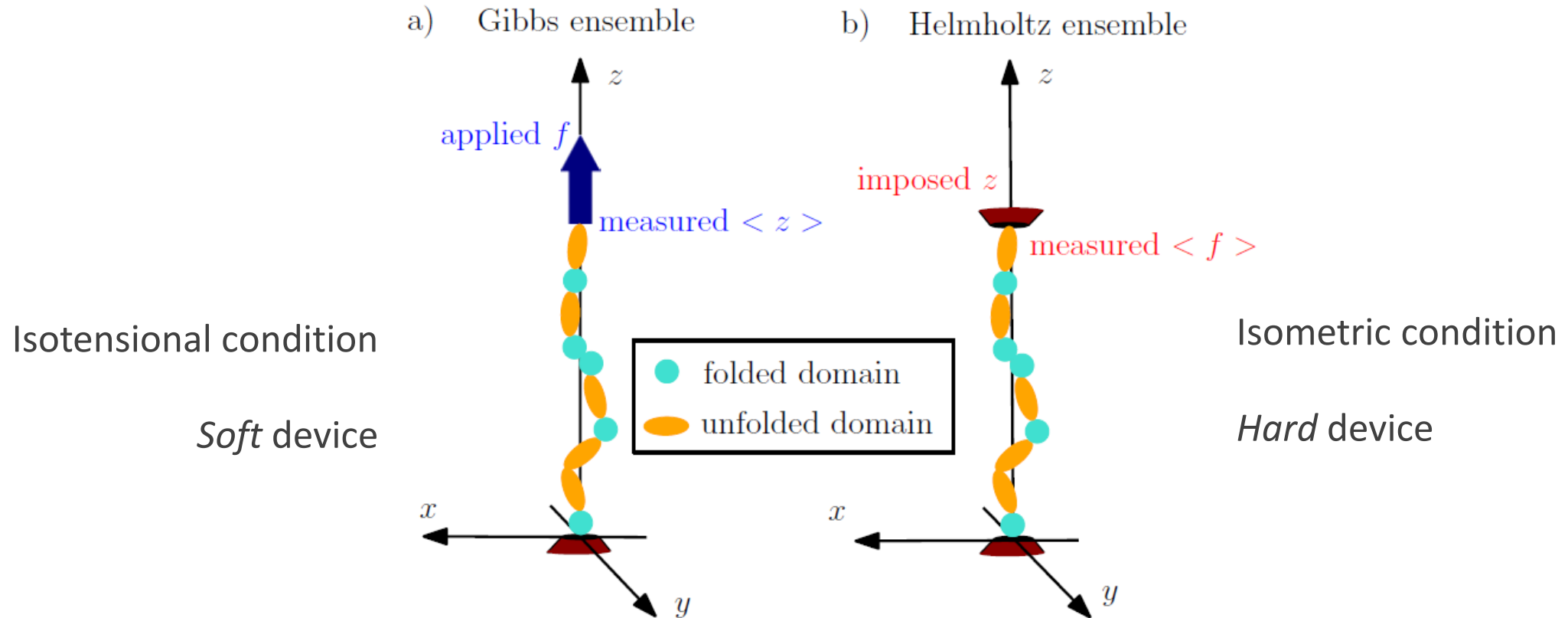

Benedito et al., *Inventions* **4**, 19 (2019)

Stretching of the chain

Gibbs ensemble

Plateau curve

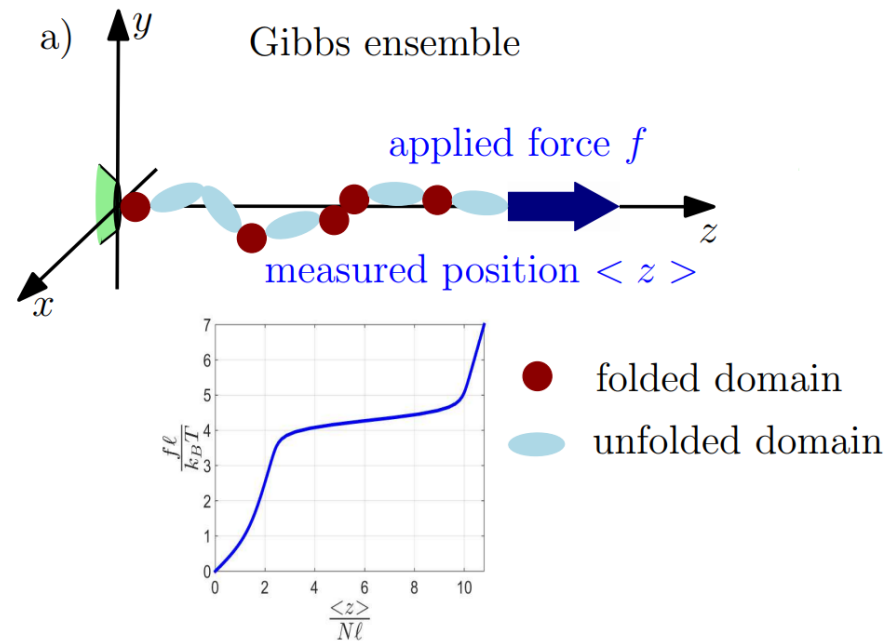

Dextran, $N=275$

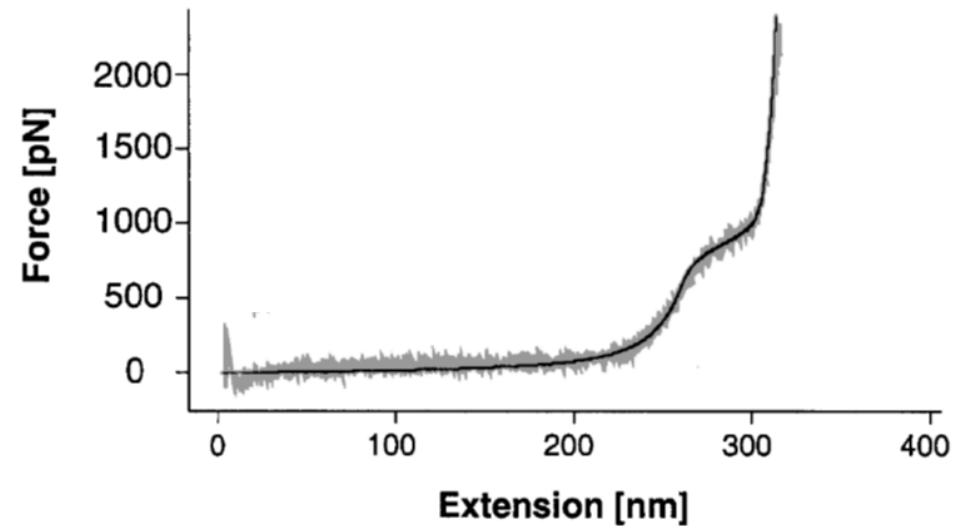

Rief et al., PRL **81**, 4764 (1998)

Gibbs partition function

We consider a bistable freely-jointed chain model

$$Z_G = \sum_{s_1 \in \{0,1\}} \dots \sum_{s_N \in \{0,1\}} \int_{\mathfrak{R}^{3N}} \int_{\mathfrak{R}^{3N}} e^{-\frac{H(\vec{p}, \vec{q}, \vec{s})}{k_B T}} d\vec{p} d\vec{q}$$

After straightforward calculations, we obtain

$$Z_G = \text{const.} \times \left\{ \frac{\sinh y}{y} + \chi e^{-\frac{\Delta E}{k_B T}} \frac{\sinh \chi y}{y} \right\}^N$$

Results: Gibbs ensemble

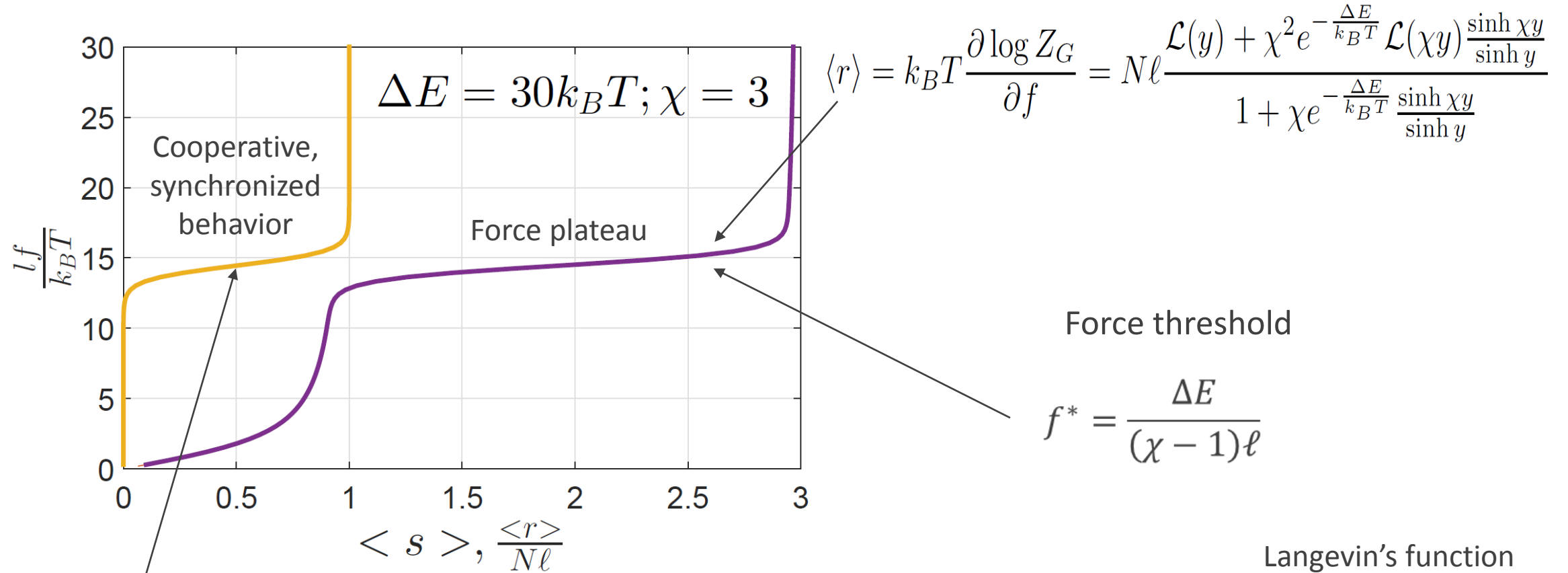

$$\langle s \rangle = \frac{1}{N} \left\langle \sum_{i=1}^N s_i \right\rangle = -k_B T \frac{\partial \log Z_G}{N \partial \Delta E} = \frac{\chi e^{-\frac{\Delta E}{k_B T}} \frac{\sinh \chi y}{\sinh y}}{1 + \chi e^{-\frac{\Delta E}{k_B T}} \frac{\sinh \chi y}{\sinh y}}$$

Helmholtz ensemble

Sawtooth-like curve

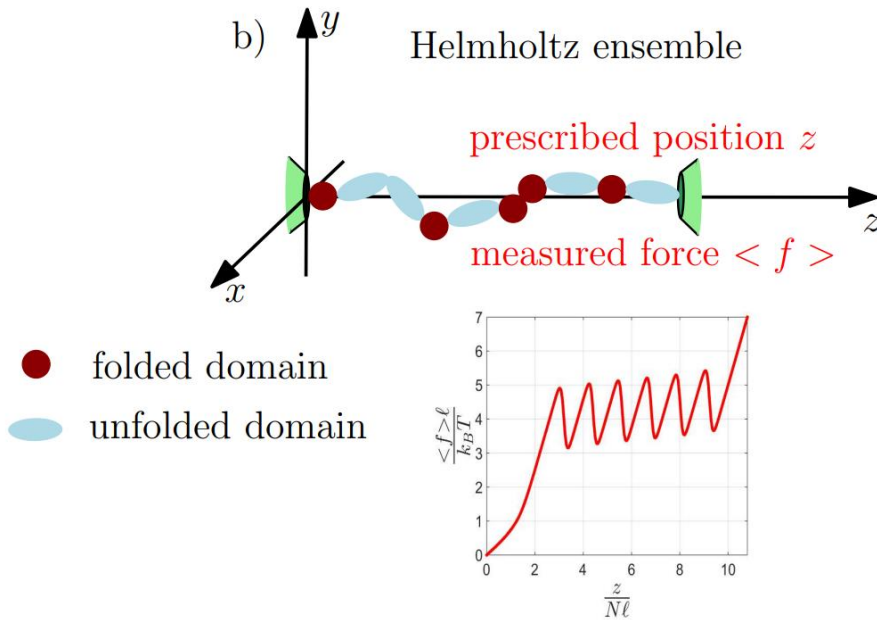

Titin, $N=6$

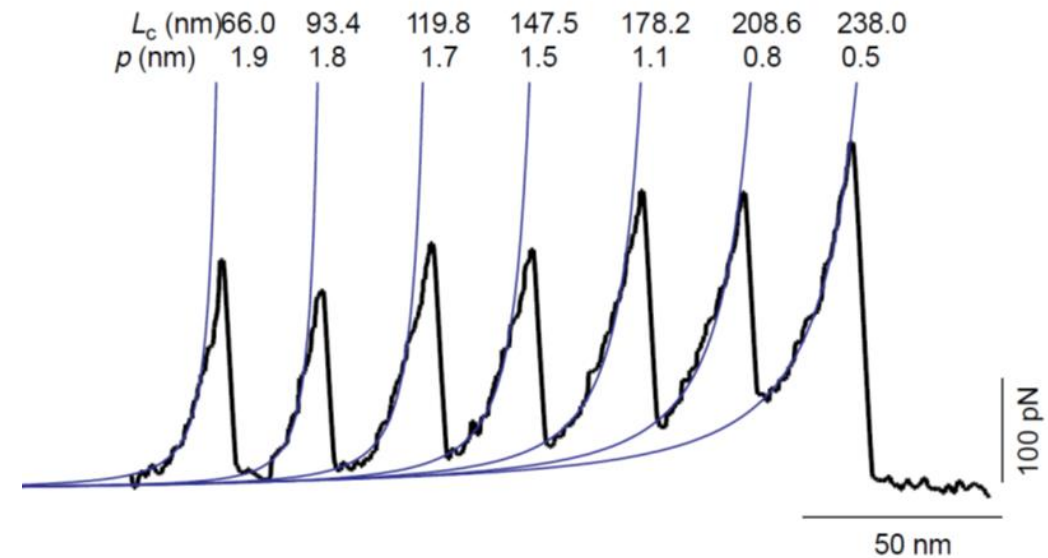

Fisher et al., TIBS **24**, p. 379–384 (1999)

Helmholtz partition function

The **three-dimensional Laplace transform** between the Gibbs and Helmholtz partition functions can be written in scalar form for radially symmetric functions

$$Z_H(r) = \int_{-\infty}^{+\infty} Z_G(i\eta) \frac{\eta}{r} \sin \frac{\eta r}{k_B T} d\eta$$

The analysis of the integral through **the complex variables method** allows the exact calculation in the following form

$$Z_H(r) = \frac{\pi}{r 2^{(N-1)} (N-2)!} \sum_{k=0}^N \sum_{p=0}^{N-k} \sum_{q=0}^k \binom{N}{k} \binom{N-k}{p} \binom{k}{q} (-1)^{p+q} \alpha^k (-\Lambda)^{N-2} \mathbf{1}(\Lambda)$$

Where $\alpha = \chi e^{-\frac{\Delta E}{k_B T}}$ and $\Lambda = k - N + 2p - \chi k + 2\chi q - \frac{r}{\ell}$

Results: Helmholtz ensemble

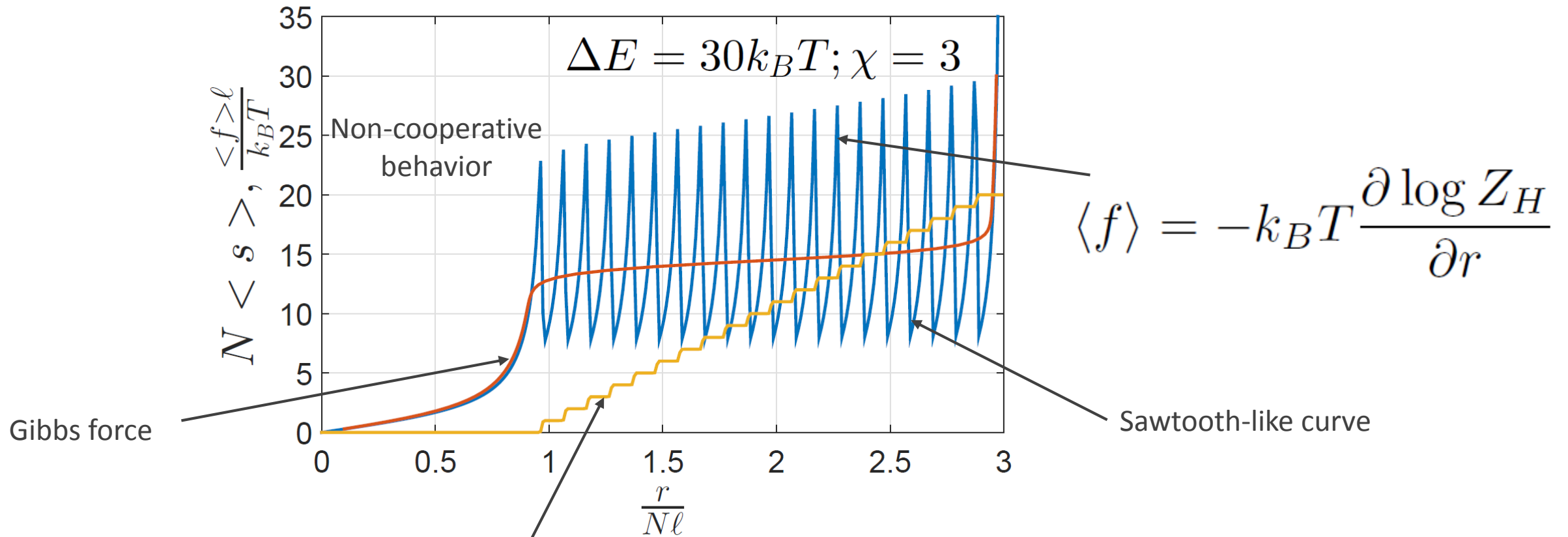

$$N \langle s \rangle = \left\langle \sum_{i=1}^N s_i \right\rangle = -k_B T \frac{\partial \log Z_H}{\partial \Delta E}$$

1st generalization: extensibility

Dimensionless extensibility

$$\alpha = \frac{K_B T}{k \ell^2}$$

Dimensionless force

$$y = \frac{\ell f}{k_B T}$$

Gibbs partition function

$$Z_G(f) = \left(\frac{\sinh y}{y} + \phi \chi \frac{\sinh \chi y}{y} \right)^N \exp \left(\frac{N \alpha y^2}{2} \right)$$

Helmholtz partition function

$$\begin{aligned} Z_H(r) = & -\frac{1}{2r} \sum_{k=0}^N \sum_{p=0}^{N-k} \sum_{q=0}^k \binom{N}{k} \binom{N-k}{p} \binom{k}{q} (-1)^{p+q} \\ & \times (\chi \phi)^k \left[\sqrt{\pi} \left(\frac{N\alpha}{2} \right)^{\frac{N-2}{2}} e^{-\frac{\Lambda^2}{2N\alpha}} H_{-N+1} \left(\frac{\Lambda}{\sqrt{2N\alpha}} \right) \right. \\ & \left. + \mathbf{1}(\Lambda) \sum_{h=0}^{[\frac{N}{2}-1]} \frac{(-1)^{N-1} \pi \left(\frac{\Lambda}{2} \right)^{N-2}}{h!(N-2-2h)!} \left(\frac{N\alpha}{2\Lambda^2} \right)^h \right] \end{aligned}$$

Index lambda

$$\Lambda = k - N + 2p - \chi k + 2\chi q - \frac{r}{\ell}$$

1st generalization: extensibility

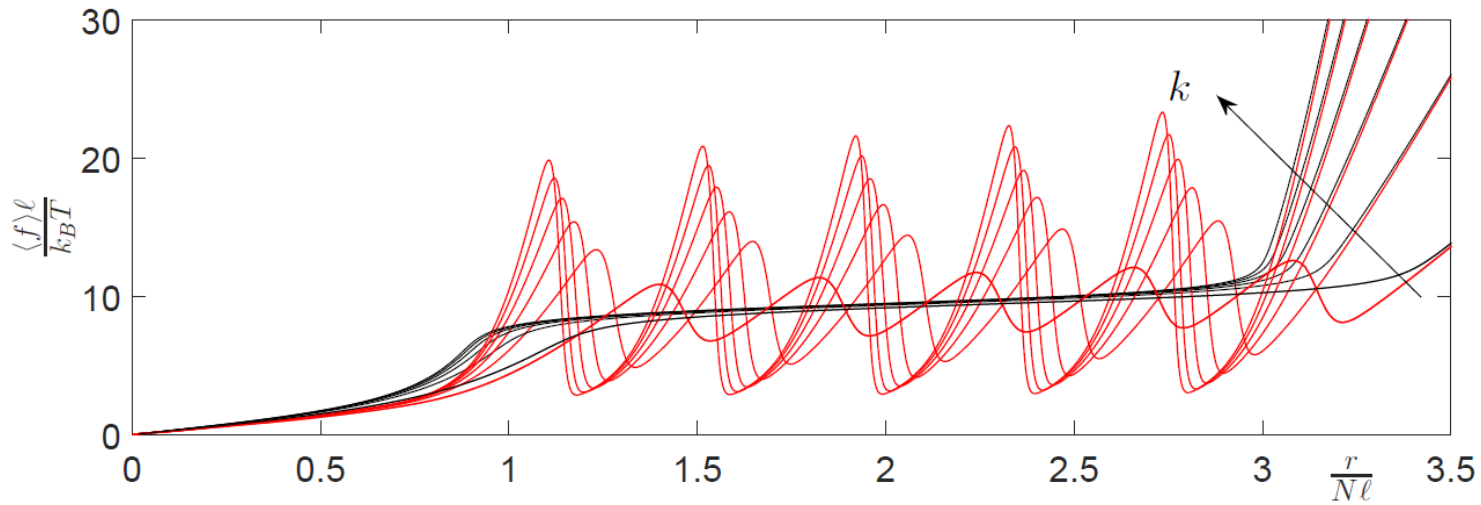

Force-extension curves

$$k = 0.4 j \text{ N/m}, \forall j = 1, \dots, 6$$

$$\ell = 0.5 \times 10^{-9} \text{ m}, T = 300 \text{ K}, \chi = 3, \Delta E = 20 k_B T = 8.28 \times 10^{-20} \text{ J}$$

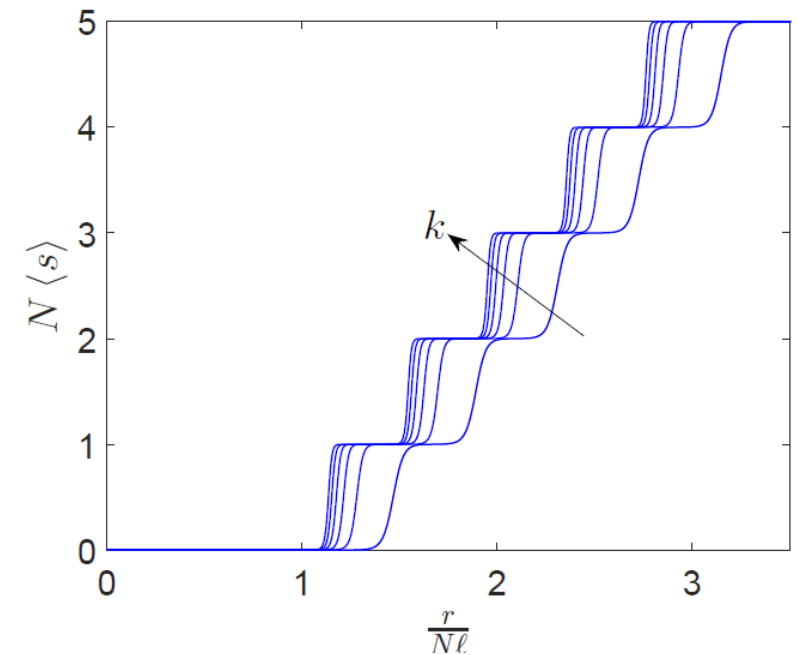

Average number of unfolded domains

Benedito et al., J. Chem. Phys. **149**, 054901 (2018)

2nd generalization: interactions

Ising potential energy ($s_i = -1, +1$; $\lambda > 0$ ou $\lambda < 0$)

Ising interaction

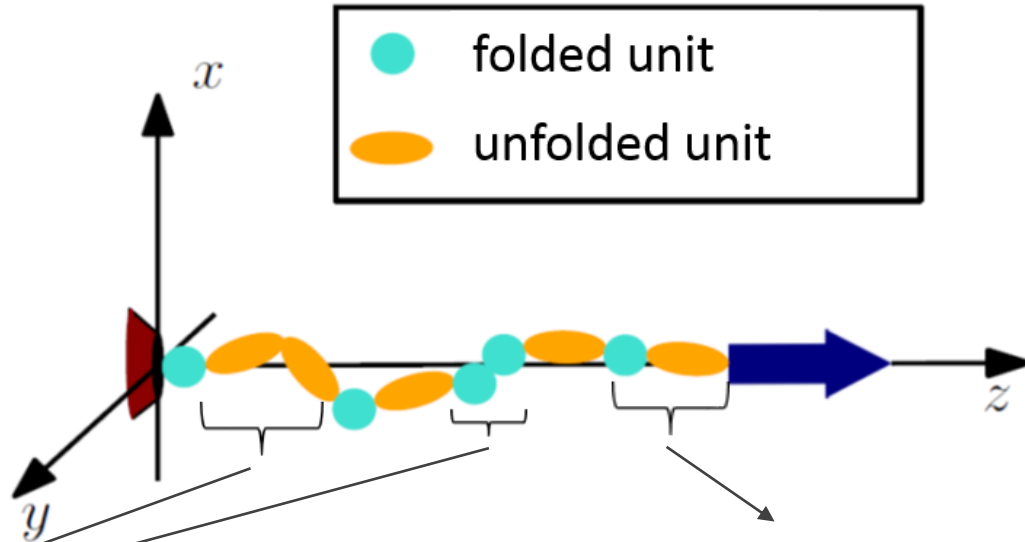

Positive (ferromagnetic) interaction: $\lambda > 0$

Negative (antiferromagnetic) interaction: $\lambda < 0$

$$U_{tot} = -\lambda \sum_{i=1}^{N-1} s_i s_{i+1} - \vec{f} \cdot \vec{r}_N + \sum_{i=1}^N \left\{ v(s_i) + \frac{1}{2} k(s_i) \left[\|\vec{r}_i - \vec{r}_{i-1}\| - \ell(s_i) \right]^2 \right\}$$

2nd generalization: interactions in the Gibbs ensemble

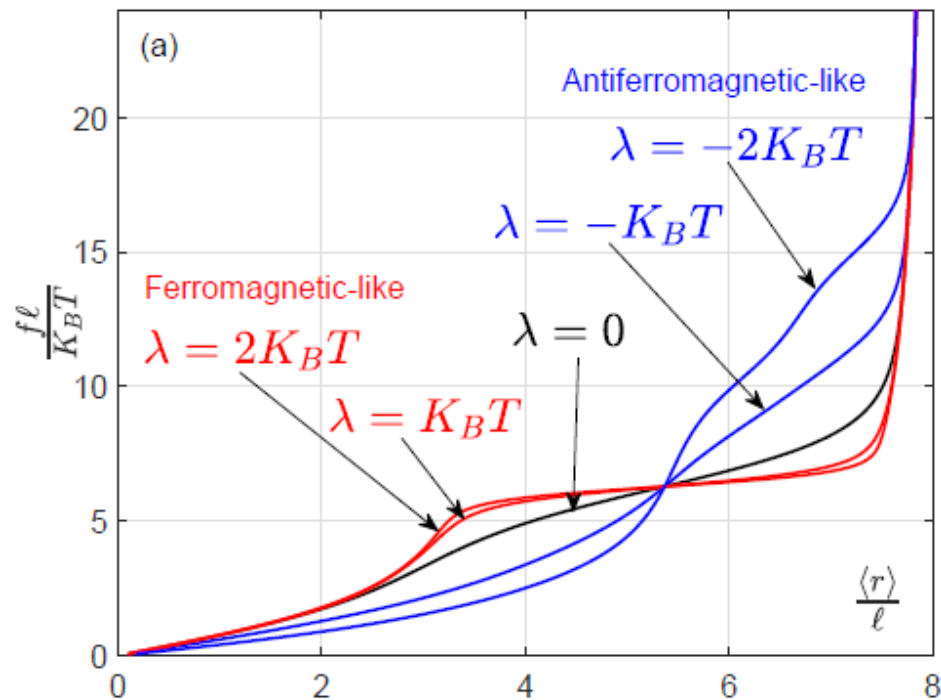

Force-extension curves

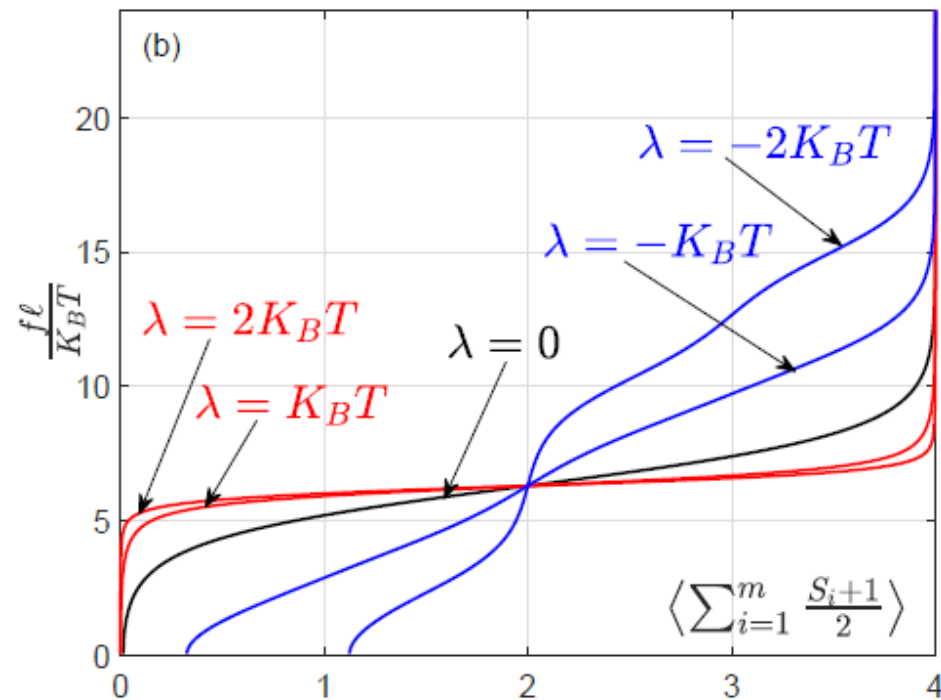

Average number of unfolded units

2nd generalization: interactions in the Helmholtz ensemble

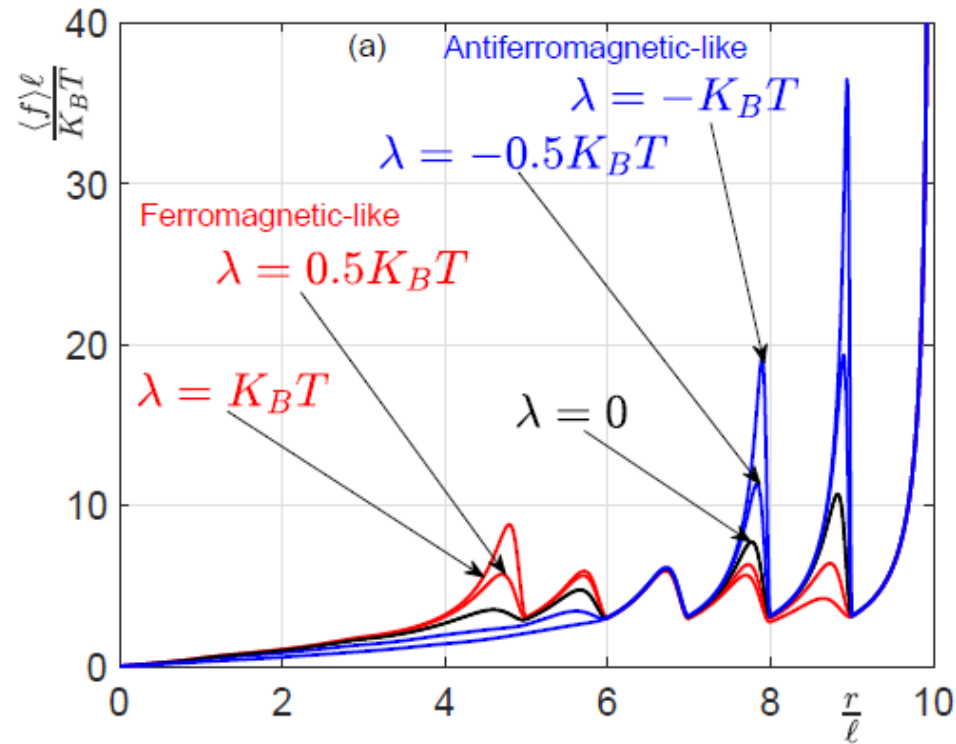

Force-extension curves

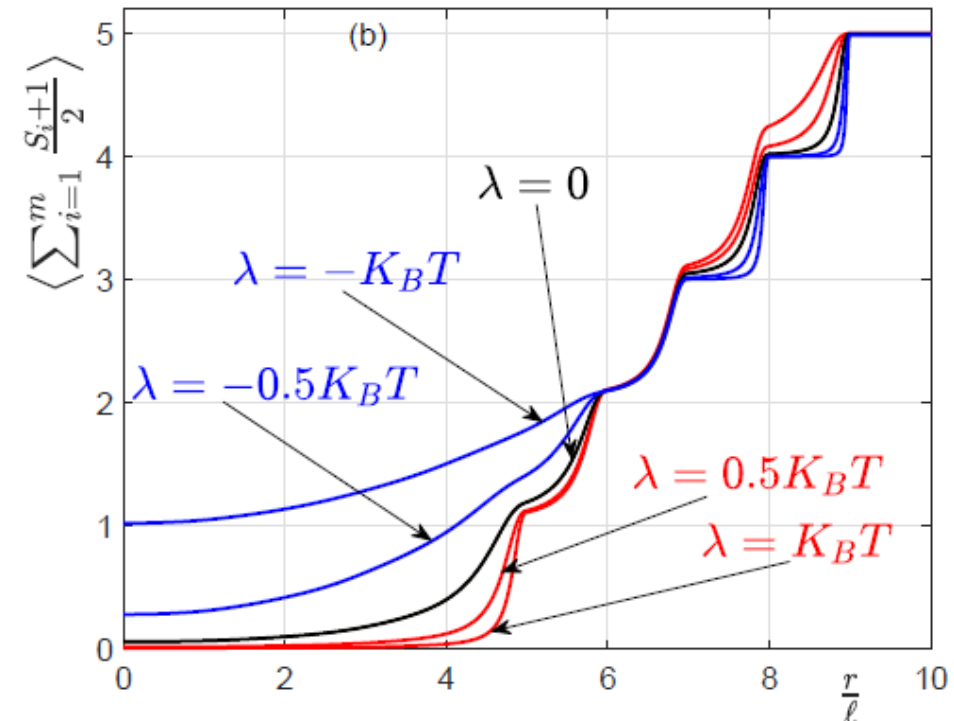

Average number of unfolded units

Benedito et al., Physical Review E **98**, 052146 (2018)

3rd generalization: heterogeneity

Heterogeneous units with respect to:

- units length
- units stiffness
- energy jump

This allows to find the **unfolding pathway**,
what is impossible if all units are homogeneous.

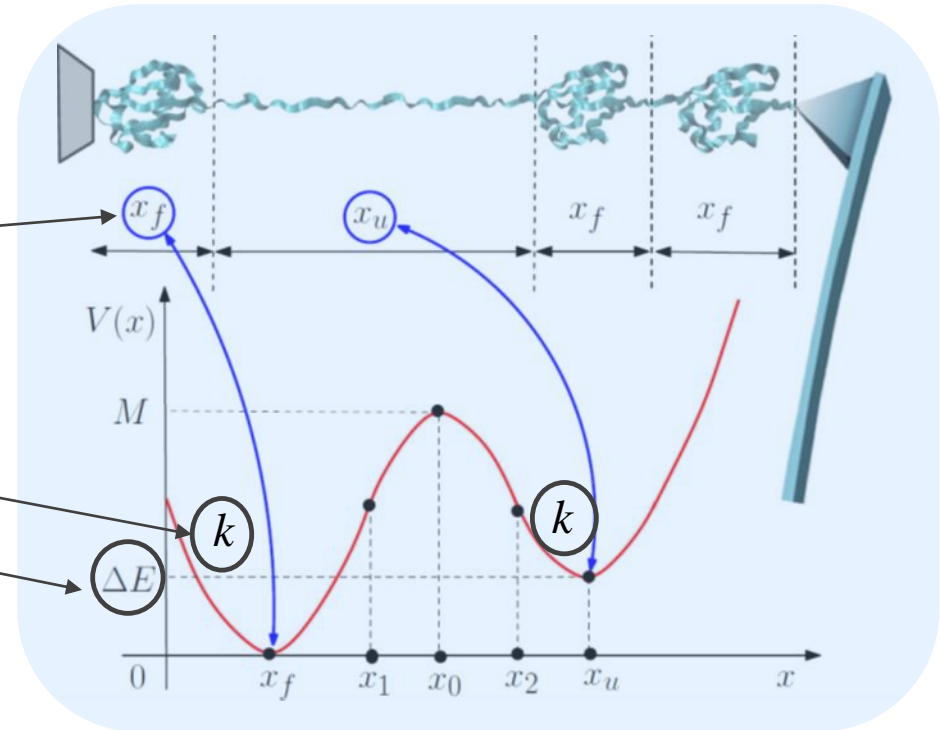

3rd generalization: heterogeneity

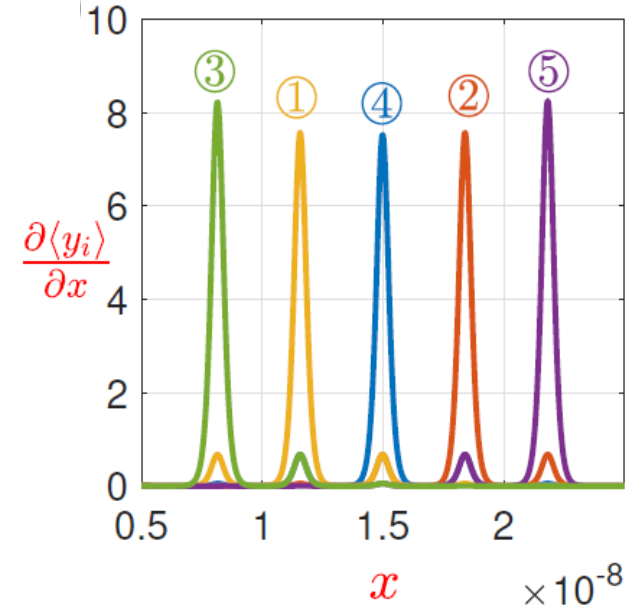
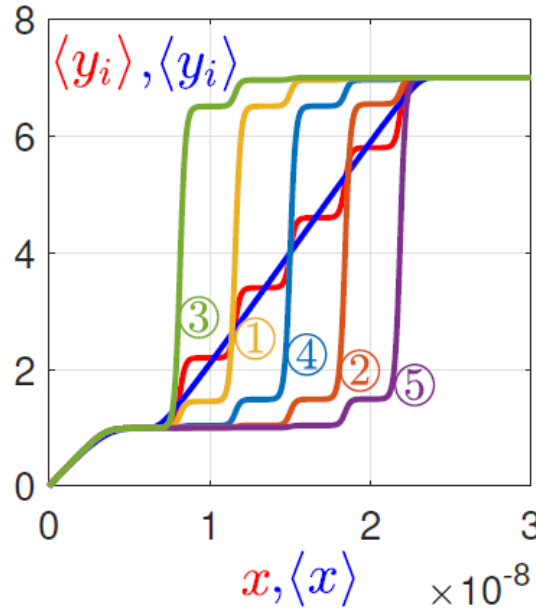
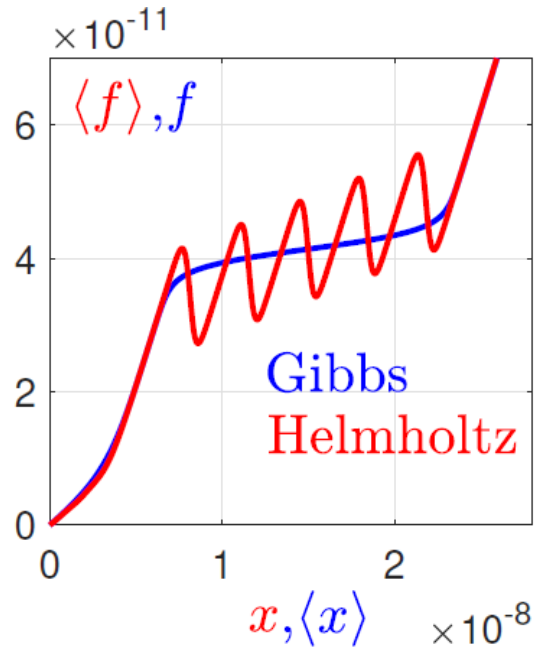

$$\Delta E_1 = 27,5K_B T, \Delta E_2 = 32,5K_B T, \Delta E_3 = 25K_B T, \Delta E_4 = 30K_B T, \Delta E_5 = 35K_B T$$

Physics Letters A submitted

Perspectives and conclusion

Dynamics of unfolding processes

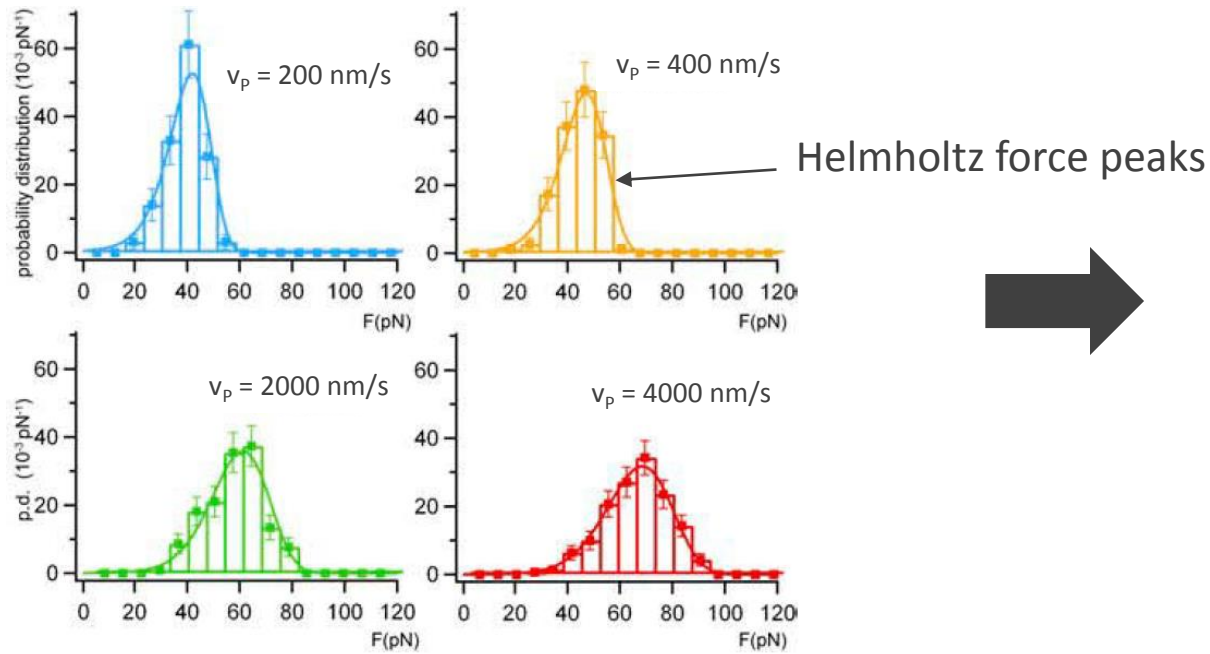

Biophys. J. **90**, L33 (2006)

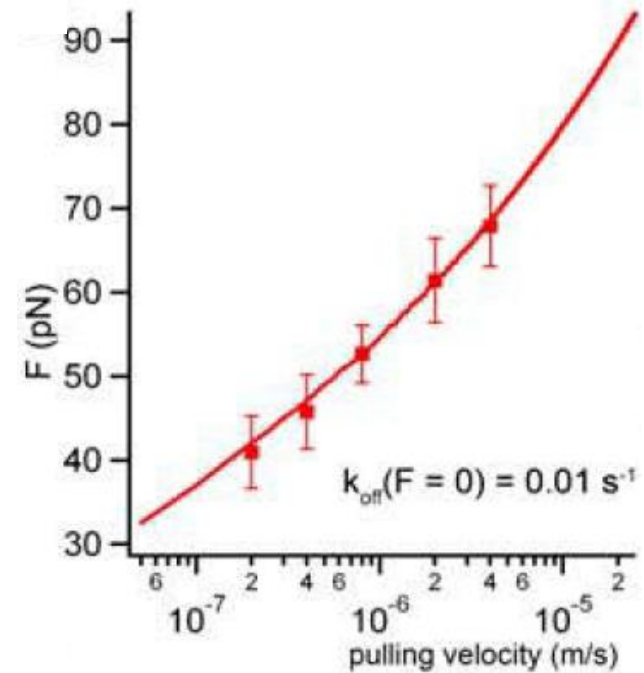

Finally, the statistical mechanics of bistable chains based on the spin variable approach allowed to reproduce and interpret complex behaviors observed in real macromolecules of biological origin.

Thank you for your attention !