



HAL
open science

Tolerance of Japanese knotweed s.l. to soil artificial polymetallic pollution: early metabolic responses and performance during vegetative multiplication

Serge Michalet, Soraya Rouifed, Thomas Pellassa-Simon, Manon Fusade-Boyer, Guillaume Meiffren, Sylvie Nazaret, Florence Piola

► To cite this version:

Serge Michalet, Soraya Rouifed, Thomas Pellassa-Simon, Manon Fusade-Boyer, Guillaume Meiffren, et al.. Tolerance of Japanese knotweed s.l. to soil artificial polymetallic pollution: early metabolic responses and performance during vegetative multiplication. *Environmental Science and Pollution Research*, 2017, 24 (26), pp.20897-20907. 10.1007/s11356-017-9716-8. hal-02335548

HAL Id: hal-02335548

<https://hal.science/hal-02335548v1>

Submitted on 23 Feb 2021

HAL is a multi-disciplinary open access archive for the deposit and dissemination of scientific research documents, whether they are published or not. The documents may come from teaching and research institutions in France or abroad, or from public or private research centers.

L'archive ouverte pluridisciplinaire **HAL**, est destinée au dépôt et à la diffusion de documents scientifiques de niveau recherche, publiés ou non, émanant des établissements d'enseignement et de recherche français ou étrangers, des laboratoires publics ou privés.

Tolerance of Japanese knotweed s.l. to soil artificial polymetallic pollution: early metabolic responses and performance during vegetative multiplication

Serge Michalet, Soraya Rouifed, Thomas Pellassa-Simon, Manon Fusade-Boyer, Guillaume Meiffren, Sylvie Nazaret, Florence Piola

► To cite this version:

Serge Michalet, Soraya Rouifed, Thomas Pellassa-Simon, Manon Fusade-Boyer, Guillaume Meiffren, et al.. Tolerance of Japanese knotweed s.l. to soil artificial polymetallic pollution: early metabolic responses and performance during vegetative multiplication. Environmental Science and Pollution Research, Springer Verlag, 2017, 24 (26), pp.20897-20907. 10.1007/s11356-017-9716-8 . hal-02335548

HAL Id: hal-02335548

<https://hal.archives-ouvertes.fr/hal-02335548>

Submitted on 23 Feb 2021

HAL is a multi-disciplinary open access archive for the deposit and dissemination of scientific research documents, whether they are published or not. The documents may come from teaching and research institutions in France or abroad, or from public or private research centers.

L'archive ouverte pluridisciplinaire **HAL**, est destinée au dépôt et à la diffusion de documents scientifiques de niveau recherche, publiés ou non, émanant des établissements d'enseignement et de recherche français ou étrangers, des laboratoires publics ou privés.

Environmental Science and Pollution Research

Tolerance of Japanese Knotweed s.l. to soil artificial polymetallic pollution: early metabolic responses and performance during vegetative multiplication --Manuscript Draft--

Manuscript Number:	ESPR-D-16-05798R2
Full Title:	Tolerance of Japanese Knotweed s.l. to soil artificial polymetallic pollution: early metabolic responses and performance during vegetative multiplication
Article Type:	Research Article
Corresponding Author:	Serge Michalet Universite Claude Bernard Lyon 1 FRANCE
Corresponding Author Secondary Information:	
Corresponding Author's Institution:	Universite Claude Bernard Lyon 1
Corresponding Author's Secondary Institution:	
First Author:	Serge Michalet
First Author Secondary Information:	
Order of Authors:	Serge Michalet Soraya Rouifed, PhD Thomas Pelassa-Simon, Master 1 Manon Fusade-Boyer, IUT Guillaume Meiffren, Master 2 Sylvie Nazaret, PhD, HDR Florence Piola, PhD
Order of Authors Secondary Information:	
Funding Information:	
Abstract:	<p>The expansion of invasive Japanese Knotweed s.l. is of particular concern because of its aptitudes to rapidly colonize diverse environments, especially anthropized habitats generally characterized by their pollution with heavy metals. Whether the presence of heavy metals impacts the performance traits of this plant is a central question to better understand its invasive properties, though no controlled approach to assess these effects were yet reported.</p> <p>In this aim, we undertook greenhouse experiments where rhizome fragments of Japanese Knotweed s.l. (<i>Fallopia japonica</i> and <i>Fallopia x bohemica</i>) were grown during 1 and 3 months, in soil pot artificially polluted or not with heavy metals added in mixture (Cd, Cr, Pb, Zn). Our results showed that (i) the presence of heavy metals delayed rhizome regeneration and induced lowered plant part weights but did not affect plant height after three months; (ii) the effect of metals on the metabolic profiles of belowground part extracts was only detectable after 1 month and not after 3 months of growth, though, it was possible to highlight the effect of metals independently of time and genotype for root extracts, and torosachryson seemed to be the most induced compound; (iii) the hybrid genotype tested was able to accumulate relatively high concentrations of metals, over or close to the highest reported ones for this plant for Cr, Cd and Zn, whereas Pb was not accumulated.</p> <p>These findings evidence that the presence of heavy metals in soil has a low impact on <i>Fallopia</i> spp. overall performance traits during rhizome regeneration, and has a rather stimulating effect on plant growth depending on pollution level.</p>
Response to Reviewers:	Reviewer #1: Dear Sirs, Thank you for resubmitting the manuscript for the second revision. In the new version

	<p>the Authors took into account the most of suggestion, however, in my opinion this report cannot be acceptable at this moment, because of the lack of some important data. The manuscript is dedicated to two invasive species of the Fallopia genus (Fallopia japonica and the hybrid - Fallopia x bohemica). In this study the results connected with heavy metals content in investigated plants are incomplete. The author did not shown the concentration of heavy metals in both species. In my opinion the heavy metals in Fallopia japonica should be done. It is important, because both taxa belongs to the most invasive plants in Europe. Therefore, I recommended to fill in the missing results.</p> <p>Analysis were undertaken (in the same laboratory as for F. x bohemica) and showed that overall, F. japonica accumulate metals in the same ranges of what was found with F. x bohemica, though differences exist: In highly polluted conditions (M3 treatment) F. japonica accumulated more metals than the hybrid for all the metal tested tested in the study and in all plant parts except for Cd concentration in roots which was greater for F. x bohemica. It is also interesting to notice that, except for Zn, F. japonica accumulated very limited amounts of metals compared to F. x bohemica in the control M0 condition. Though, its translocation factor varies not much in the presence of high metal concentrations (from 3 to 5 for Cd and from 2 to 3 for Zn in M0 and M3 conditions respectively) compared to F. x bohemica for which the translocation factors of these two metals were even inverted with metal contamination (from 0,5 to 3 for Zn and from 0,1 to 1 for Cd).</p> <p>According to this, modifications were made in the manuscript in the Material and Methods (lines 176-180), Results (lines 275-283) and Discussion (lines 311-314) of the revised manuscript. Figure 7 was also modified.</p>
Additional Information:	
Question	Response
§Are you submitting to a Special Issue?	No

[Click here to view linked References](#)

1 **Tolerance of Japanese Knotweed *s.l.* to soil artificial polymetallic pollution: early**
2 **metabolic responses and performance during vegetative multiplication**

3
4
5
6
7 4 Serge Michalet ^a, Rouifed Soraya ^b, Pellassa-Simon Thomas ^a, Fusade-Boyer Manon ^b, Meiffren
8
9 5 Guillaume ^a, Nazaret Sylvie ^a & Piola Florence ^b

10
11
12
13
14 7 ^a Université de Lyon, Université Claude Bernard Lyon1, CNRS, UMR 5557, INRA, UMR
15
16 8 1418, Ecologie Microbienne, F-69622, Villeurbanne, France.

17
18
19 9 ^b Université de Lyon, Université Claude Bernard Lyon 1, ENTPE, CNRS, UMR 5023 LEHNA,
20
21 10 F-69622, Villeurbanne, France.

22
23
24 11
25
26 12
27
28
29 13 * **Corresponding author:** serge.michalet@univ-lyon1.fr

30
31 14
32
33
34 15 **Key-words:** Metallic trace elements, *Fallopia* spp. (syn. *Reynoutria* spp.), Plant performance
35
36 16 traits, Metabolite profiling, Plant secondary metabolites.

37
38
39 17
40
41 18 **Abstract**

42
43 19 The expansion of invasive Japanese Knotweed *s.l.* is of particular concern because of its
44
45 20 aptitudes to rapidly colonize diverse environments, especially anthropized habitats generally
46
47 21 characterized by their pollution with heavy metals. Whether the presence of heavy metals
48
49 22 impacts the performance traits of this plant is a central question to better understand its invasive
50
51 23 properties, though no controlled approach to assess these effects were yet reported.

52
53
54 24 In this aim, we undertook greenhouse experiments where rhizome fragments of Japanese
55
56 25 Knotweed *s.l.* (*Fallopia japonica* and *Fallopia x bohemica*) were grown during 1 and 3 months,
57
58
59
60
61
62
63
64
65

26 in soil pot artificially polluted or not with heavy metals added in mixture (Cd, Cr, Pb, Zn). Our
27 results showed that (i) the presence of heavy metals delayed rhizome regeneration and induced
28 lowered plant part weights but did not affect plant height after three months; (ii) the effect of
29 metals on the metabolic profiles of belowground part extracts was only detectable after 1 month
30 and not after 3 months of growth, though, it was possible to highlight the effect of metals
31 independently of time and genotype for root extracts, and torosachryson seemed to be the most
32 induced compound; (iii) the hybrid genotype tested was able to accumulate relatively high
33 concentrations of metals, over or close to the highest reported ones for this plant for Cr, Cd and
34 Zn, whereas Pb was not accumulated.
35 These findings evidence that the presence of heavy metals in soil has a low impact on *Fallopia*
36 spp. overall performance traits during rhizome regeneration, and has a rather stimulating effect
37 on plant growth depending on pollution level.

39 **Introduction**

40 The increased prevalence of heavy metals in the environment, which is largely due to the
41 intensification of anthropogenic activities, is of particular concern because it affects living
42 organisms at the whole ecosystem level. Concerning plants, two main adaptive strategy may be
43 used to cope with an excess of heavy metals (Baker, 1981) : (i) *exclusion* which is the most
44 common strategy used, where metal concentration in shoots remains low and constant while
45 external concentration is varying, or (ii) *accumulation* where metal is more translocated in
46 shoots than in roots, with the distinction between *indicators* that concentrate metals at levels
47 close to that of soil and *hyperaccumulators* which are able to accumulate metals at very high
48 levels (van der Ent et al. 2013; 2015).
49 In order to assess the effects of heavy metals on plants and better understand the molecular
50 mechanisms involved in plant tolerance to metal stress, omics tools have been used to

1
2
3
4
5
6
7
8
9
10
11
12
13
14
15
16
17
18
19
20
21
22
23
24
25
26
27
28
29
30
31
32
33
34
35
36
37
38
39
40
41
42
43
44
45
46
47
48
49
50
51
52
53
54
55
56
57
58
59
60
61
62
63
64
65
66
67
68
69
70
71
72
73
74
75

characterize stress-induced metabolites, phytohormones, transcription factors or proteins (Singh et al. 2016), as well as key genes acquired during plant evolution conferring hypertolerance (Hanikenne and Nouet, 2011). Among the metabolic changes occurring during metal exposure, plant secondary metabolites like polyphenols have been quite less studied compared to primary ones or plant hormones for example, at least qualitatively, and only an induction of polyphenol biosynthesis of metal exposed plants has been reported in a few studies, as recently reviewed by Singh et al. (2016). Though, these compounds are well-known free-radical scavengers that protect cells from oxidative stress, they also possess strong metal chelating properties, especially polymers like tannins, and they also act as molecular signals involved in many plant biotic interactions from symbiosis establishment and insect visual attraction to disease resistance (Cheynier et al. 2013). This implies that the metal-induced changes in plant polyphenol biosynthesis also probably affects plant biotic interactions, especially in the root system which is directly exposed to metal toxicity and play a major role in shaping rhizosphere microbial communities through root exudation (*e.g.* Michalet et al. 2013). Some authors hypothesised that this modulation of root exudates composition under contaminant exposure might select for microbes that confer plant tolerance to the stress and is referred to as the “plant call for support” theory (Thijs et al. 2016). Indeed plant-associated microbes are believed to play a great role in plant adaptation to metallic stress and this area of research has recently taken much attention, since it could be a way to drastically improve phytoremediation (Rajkumar et al. 2012; Thijs et al. 2016). Plant-microbiome interactions are also described as important drivers for the establishment of weed and invasive species (Trognitz et al. 2016). Whether invasive plant species are positively influenced by soil metal pollution, at least for those that are able to grow on metalliferous area, remains an open question that has not yet been clearly examined in the literature. Indeed, metal-polluted environments like urban or industrial settings are disturbed habitats where contaminants exert a strong selective pressure

1 76 which render them more prompt to biological invasions (*i.e.* the so-called “empty niche” theory,
2 77 as early stated by Elton in 1958).
3
4 78 A well-known invasive species able to grow on metal polluted soil is the plants belonging to
5
6 79 the genus *Fallopia* (syn. *Reynoutria*, Polygonaceae) which includes two Asian herbaceous
7
8 80 perennial polyploid species (*F. japonica* and *F. sachalinensis*) and their interspecific hybrid *F.*
9
10 81 *x bohemica*, forming a polyploid complex of species, generally referred to as Japanese
11
12 82 Knotweed *s.l.* (Bailey et al. 2009). Because of their high performance traits (Bailey et al. 2009)
13
14 83 leading to dominance in the community, these species impact ecosystem functioning
15
16 84 (Dassonville et al. 2011) and pose severe socio-economical issue in Europe and North America
17
18 85 as no conventional method to efficiently control their expansion is currently known. Actually,
19
20 86 the annual cost to control Japanese Knotweed is estimated to be of more than 1.5 billion £/year
21
22 87 only for Great Britain, representing one third of the total annual cost for alien weed management
23
24 88 (Williams et al. 2010). Their capacity to tolerate abiotic stress (Rouified et al. 2012) and their
25
26 89 strong competitive aptitudes allow them to rapidly colonize various environments. They mainly
27
28 90 spread by rhizome (or stem) regeneration through vegetative reproduction, though the hybrid
29
30 91 is also able to produce seeds and back-crosses with parental species (Bailey et al. 2009,
31
32 92 Soltysiak and Brej, 2012; Groeneveld et al. 2014; Gaskin et al. 2014). The later (*F. japonica*
33
34 93 and *F. sachalinensis*) are native to Eastern Asia including volcanic areas presenting very high
35
36 94 metallic trace elements concentrations in soil: actually more than 90 and 9000 mg/kg of Cd and
37
38 95 Zn were respectively found in metalliferous site of Japan where these species naturally grow
39
40 96 (Nishizono et al. 1989). This may in part explain why they are mainly found in anthropized
41
42 97 environments like railroads or industrial and urban areas, and that these disturbed habitats seem
43
44 98 to promote specifically their expansion (Soltysiak and Brej, 2012; Soltysiak and Brej, 2014).
45
46 99 Japanese knotweed *s.l.* are able to accumulate metallic trace elements and the ability to
47
48 100 concentrate toxic metals in plant parts of these species has been extensively studied, but
49
50
51
52
53
54
55
56
57
58
59
60
61
62
63
64
65

101 exclusively from field measurements (*e.g.* Soltysiak et al. 2011; Rahmonov et al. 2014; Širka
102 et al. 2016). Most of these studies reported higher amounts of metals accumulated in
103 underground parts of the plant but no clear correlations between a rather accumulated type of
104 metal or relationships between soil concentrations and plant metal accumulation could be made
105 from these studies due to the variability of the published values.
106 Facing this, controlled studies need to be developed in order to better understand the impact of
107 the presence of metals in soils on Japanese Knotweed *s.l.* performance traits, especially during
108 vegetative propagation. In this aim we undertook greenhouse experiments, where rhizome
109 fragments of genotypes of Japanese Knotweed *s.l.* were grown during one and three months
110 respectively, in soil pot artificially polluted or not with heavy metals in mixture (Cd, Cr, Pb,
111 Zn) at three different concentrations from faintly polluted to highly polluted soils respectively.
112 These metals were chosen because they are among the main pollutants generated by anthropic
113 activities and are often found in urban soils, and also because two of them are essential trace
114 elements (Cr and Zn), whereas the two others are toxic to most organisms (Cd, Pb). To assess
115 if performance traits were impacted, the growth kinetic as well as final plant part dry weights
116 were recorded. A metabolic profiling approach on belowground plant parts (roots and rhizomes
117 separately) and based on UV-absorbing compounds was also achieved in order to target more
118 specifically phenolic and other aromatic compounds that might be induced during metal stress.

119 120 **Materials and Methods**

121 *Greenhouse experiments settings*

122 Two independent microcosm experiments of one month and three months respectively were
123 conducted in greenhouse. For the one month experiment which occurred between February and
124 March 2014, a loamy Luvisol (WRB, 2006) continuously cropped with maize and collected at
125 La Côte Saint-André (Isère, France) possessing the following characteristics: sand 37.5%; loam

126 42.7%; clay 19.8%; OM 2.23%; pH 6.4; CEC: 8.79 cmol.kg⁻¹ and exempt of heavy metal
1
2 127 pollution, was sieved (2 mm mesh size) and rehydrated to its field capacity (28% m/v) by adding
3
4 128 either Ultra-Pure water (UP) (control, M0) or a solution containing Cd, Cr, Pb and Zn (added
5
6
7 129 as chloride salts) at concentrations close to common recognized soil pollution threshold (M2
8
9
10 130 treatment; Baize et al. 2007), ten times lower (M1 treatment) or ten times higher (M3 treatment)
11
12 131 and summarized in **Table 1**. Then 200 g of moistened soil were placed into 0.3 L plastic pots
13
14 132 and rhizome fragments of 2 genotypes of Japanese Knotweed *s.l.* (*F. x bohemica* or *F. japonica*)
15
16
17 133 were planted. These rhizome fragments were obtained from individuals morphologically
18
19 134 identified (F. Piola, personal communication) using leaf shape and size (Bailey et al. 2009) and
20
21
22 135 collected from the field on the riverbanks of the Suran river (Ain, France) for *F. x bohemica*
23
24 136 and on the riverbanks of the Valencizes river (Rhône, France) for *F. japonica* and that were
25
26
27 137 acclimated for more than a year to greenhouse conditions in order to avoid any “mother effect”.
28
29 138 For each treatment, five budding rhizome fragments from each genotype were cut into pieces
30
31
32 139 (average weight of 0.7 ± 0.1 g), planted in soil and grown in greenhouse (13h day 22°C/11h
33
34 140 night 18°C) with light intensity of about 8-10 klux. Soil moisture was manually controlled by
35
36 141 adding water every three days. For the three months experiment which occurred between
37
38
39 142 January and March 2015, the same procedure was repeated but with modifications concerning
40
41 143 the amount of soil added in pots (600 g in order to allow the plant to grow for three months;
42
43
44 144 0.75 L pots). Metal concentrations were also modified because of the absence of regeneration
45
46 145 of rhizome for the initial M3 dose chosen in the one month experiment, and in order to keep
47
48
49 146 roughly an order of magnitude of difference between each treatment. Concentrations were
50
51 147 approximatively divided by two for M1 and M2 treatments and by three for M3 treatment
52
53 148 (**Table 1**).

54
55
56 149 ***Growth traits***

57
58
59
60
61
62
63
64
65

150 For the three months experiment, during growth, the height of each plant was notified three
1
2 151 times a week by measuring the distance between topsoil and the highest photosynthetic part of
3
4 152 the plant. At the time of collection, plants were carefully excavated from soil, and roots were
5
6
7 153 rinsed with tap water. Aboveground parts (stems + leaves) were separated from belowground
8
9
10 154 parts (rhizome + roots) and both were immediately frozen in liquid nitrogen and freeze-dried
11
12 155 before being weighed.

14 156 *Metabolite profiling of belowground parts*

16
17 157 For both experiments, after freeze-drying fine roots were separated from rhizomes, and about
18
19 158 100 mg of each were grounded (TissueLyserII® - Qiagen; F= 300/sec., 3 min.) and sonicated
20
21
22 159 with a 1 mL mixture of MeOH-H₂O (1:1) for 15 minutes. After the supernatant was removed,
23
24 160 the remaining powder was sonicated with 1 mL MeOH and both supernatants were pooled and
25
26 161 concentrated under vacuum (Speedvac® – Labenco) before being dissolved at 10 mg/mL in
27
28
29 162 MeOH 80% and stored at -20°C before analysis.

30
31 163 Samples were analysed by UHPLC-DAD ESI-QTOF (Agilent 1290 infinity linked with Agilent
32
33
34 164 QTOF 6530), using poroshell 120 EC-18 column (2.7 µm, 3.0 x 100 mm, Agilent) with a
35
36 165 gradient of 0.1% formic acid in water (A) and acetonitrile (B) as follows: 1% of B from 0 to
37
38
39 166 1.5 min, and growing with a linear gradient to 15% of B at 8 min ; 60% of B at 14 minutes and
40
41 167 100% of B at 16 min for 1 min. All solvents were LC-MS grade (Optima). The flow rate was
42
43
44 168 adjusted at 1.2 mL/min and the injection volume was 2 µL. UV spectra were recorded between
45
46 169 190 and 600 nm. The ESI source was optimized as follows: positive ionization mode, scan
47
48
49 170 spectra from m/z 100 to 2000, capillary voltage 3.5 kV, fragmentor 120 V, fixed collision-
50
51 171 induced dissociation (CID) energy at 20 eV. Nitrogen was used as the nebulizing gas with a
52
53 172 flow rate of 12 L/min and a temperature of 310°C at 40 psi.

54
55
56 173 Compounds were identified by analysis of their UV, HRMS and MS/MS spectra using
57
58 174 MassHunter Qualitative Analysis (Agilent Technologies, USA)

175 ***Heavy metal contents in plants and soil***

1
2 176 Metal content in soil (three biological replicates of *F. x bohemica* rhizosphere soil) was
3
4
5 177 analysed by ICP-MS at the CRPG of Vandoeuvre-les-Nancy and metal content in plant parts
6
7 178 was analysed by ICP-MS (and ICP-radial for Zn) by USRAVE (INRA-Centre de Bordeaux ;
8
9
10 179 CoFrac-certification n°1-1838). Three replicates of both *F. x bohemica* and *F. japonica*
11
12 180 growing in M0- and M3-treatments were analysed
13

14 181 ***Statistical analysis***

16
17 182 ***Growth traits***

18
19 183 Individual plant heights measured during the three months experiment were analysed with a
20
21
22 184 dose/response model (package drc, Knezevic et al. 2007). Data obtained from both genotypes
23
24 185 tested were pooled because they did not differ significantly.
25

26 186 Concerning plant part dry weights, differences between treatments, genotypes and the
27
28
29 187 interaction between the two factors were analysed using variance analysis (ANOVA) on
30
31 188 RStudio software (version 3.2.2).
32

33
34 189 ***Metabolite profiling***

35
36 190 Peak areas were normalised by using relative values, *i.e.* percentages of each compound in the
37
38
39 191 chromatogram. PCA (Principal Component Analyses) were performed using R studio software
40
41 192 with “ade4” package. The compounds showing variations in their proportion between
42
43
44 193 treatments were analysed using ANOVA, followed by a Tukey-HSD test. All tests were done
45
46 194 in respect with the rules of normality and homoscedasticity assumptions.
47

48
49
50 195 For the one month experiment, 26 samples were analysed giving 80 peaks for rhizome extracts
51
52 196 and 114 peaks for root extracts, whereas for the three months experiment, 42 samples were
53
54 197 analysed with 107 peaks for rhizome extracts and 101 peaks for root extracts.
55

56
57
58 198 In order to compare the one month and three months experiments together, all extracts obtained
59
60 199 during both experiments from the different biological replicates were pooled according to time
61
62

200 of collection, treatment and genotype (giving 14 pooled extracts for roots and rhizome
201 respectively) and analysed with the same procedure of chromatography and data treatment (62
202 peaks analysed). As metal levels of both experiments were of the same order of magnitude data
203 were pooled in one single matrix.

205 **Results**

206 *Growth traits*

207 Plant height in function of time and treatment is presented in **Figure 1**. Data obtained for both
208 genotypes were analysed together because their response did not differ significantly. Pairwise
209 comparison of parameters of the Log logistic model between treatments showed that
210 concentration of metals affected growth of plants during time: the higher the concentration of
211 metals, the later the plants reached 50% of their maximal height. Plants in M0 and in M1
212 treatments reached half of their height in 19 days. Plants in M2 treatment reached half of their
213 height 6 days later (25 days, $p < 0.001$), and plants in M3 treatment needed further 5 days (30
214 days, $p < 0.001$). However, plants treated with M2 concentration reached the highest height (11.6
215 cm), not significantly different from plants with M3 concentration (10.9 cm, $p = 0.155$), but
216 significantly higher than plants in M0 and M1 concentrations (10.3 cm, $p < 0.001$ and 10.4cm,
217 $p < 0.001$, respectively).

218 *F. x bohemica* had significantly higher aboveground ($F = 4.76$, $p = 0.035$) and belowground ($F =$
219 5.32 , $p = 0.026$) weights than *F. japonica* after 3 months of growth. However, the genotype
220 did not influence the response of plants to the metal treatment (interactions genotype x
221 treatment non significant). Control plants (M0) showed significantly higher aboveground ($F =$
222 2.95 , $p = 0.044$) and belowground ($F = 5.86$, $p = 0.002$) weights, but treatment affected
223 differently aerial and underground parts: plants treated with M1 concentration showed the

224 lowest aboveground weight whereas plants treated with M2 and M3 concentrations showed the
1
2 225 lowest belowground weight.

3 4 226 *Metabolite profiling of belowground parts*

5
6
7 227 PCA based on metabolic profiles obtained from rhizome and root extracts after one and three
8
9 228 months of growth (**Fig. 3** & **Fig. 4** respectively) allowed in each case to distinguish both
10
11 229 genotypes tested along axis 1, except for root extracts at 3 months for which this distinction
12
13 230 was made along axis 2 (**Fig. 3A, 3C** & **Fig. 4A, 4C**). The effect of metal treatments was
14
15 231 detectable for both plant parts after one month of growth since M2-treated plants were relatively
16
17 232 well separated from M0-treated plants along axis 2, and this was especially true for roots (**Fig.**
18
19 233 **3B, 3D**). Since the M3 treatment chosen in the one month experiment was too toxic to allow
20
21 234 rhizome regeneration, no data could have been obtained from this group which is then lacking
22
23 235 in the PCA. After three months of growth, it was not possible to distinguish any of the metal
24
25 236 treated groups from the control (**Fig. 4B, 4D**).

26
27 237 In order to better characterize the effect of metal pollution on plant belowground metabolites,
28
29 238 biological replicate extracts of both plant parts were pooled according to time, genotype and
30
31 239 metal treatment, leading to 14 new pooled samples which underwent the same chromatographic
32
33 240 analysis and data treatment procedure (**Fig. 5**). This allowed for both plant parts to distinguish
34
35 241 the effect of time which was mainly explained by axis 1 (**Fig. 5A, 5D**), from that of genotype
36
37 242 which was mainly explained by axis 2 (**Fig. 5B, 5E**). It was also possible to discriminate metal
38
39 243 treated groups along axis 3 but this was only the case for root extracts (**Fig. 5F**) and not for
40
41 244 rhizome extracts (**Fig. 5C**), even when considering lower eigen values.

42
43 245 One of the compound for which the proportions were the most increased with metal
44
45 246 concentrations and strictly explaining axis 3, was identified as torosachryson, a
46
47 247 dihydroanthracenone derivative, by comparing its UV, HRMS and MSMS spectra with
48
49 248 literature data (**Fig. 6**). Other anthracene derivatives including anthraquinone and dianthrone
50
51
52
53
54
55
56
57
58
59
60
61
62
63
64
65

249 were also found to be increased in their proportions in root extracts at one and three months
1
2 250 (data not shown).
3

4 251 ***Heavy metal contents in soil and plant parts of F. x bohemica***

6
7 252 The content of metallic trace elements in M3-treated soil after the three months experiment was
8
9 253 relatively close to the theoretical concentrations expected (i.e. resulting from the artificial
10
11 254 contamination of soil experimented in this study) for Cd (7.2 ± 0.5 mg/kg vs 5.5 mg/kg in
12
13 255 theory), Cr (332.0 ± 39.2 mg/kg vs 440.0 mg/kg in theory) and Zn (923.7 ± 70.5 mg/kg vs 880.0
14
15 256 mg/kg in theory), whereas for Pb, the measured concentration was approximatively divided by
16
17 257 three compared to its theoretical concentration (95.9 ± 8.3 mg/kg vs 295.0 mg/kg in theory)
18
19 258 (**Fig. 7** and **Table 1**).
20
21

22
23
24 259 The control soil M0 that received no metallic treatment showed low heavy metal concentrations
25
26 260 as expected, in the range of what is naturally found for this type of soil, and could thus be
27
28
29 261 considered as non-polluted.
30

31 262 *F. x bohemica* accumulated metals even if no artificial pollution was added (i.e. M0-treatment;
32
33
34 263 **Fig. 7A-D-left**), and especially in underground parts: similar contents than those found in soil
35
36 264 were actually measured for Cr and Zn (**Fig. 7B** and **7D** respectively). In contrast Cd was
37
38
39 265 accumulated approximatively five times more (**Fig. 7A**) and Pb six time less (**Fig. 7C**). These
40
41 266 metals did not seem to be translocated to aerial parts in these conditions since metal
42
43
44 267 concentrations were very low and close to the limit of quantification for Cd, Cr and Pb.

45
46 268 When artificial metallic pollution was added at the highest concentration tested (i.e. M3-
47
48
49 269 treatment; **Fig. 7A-D-right**), each metal except Pb was more accumulated in *F. x bohemica*
50
51 270 plant parts and the translocation factor ($[\text{metal}]_{\text{shoots}}/[\text{metal}]_{\text{roots}}$) of Cd was increased ten times
52
53 271 compared to control (1.0 vs 0.1; **Fig. 7A**) and six times for Zn (3.3 vs 0.5; **Fig. 7D**). The highest
54
55
56 272 concentrations of metal in *F. x bohemica* measured for this treatment were of 507.0 mg/kg for
57
58
59
60
61
62
63
64
65

273 Zn in aerial parts, and of 127.0 and 14.0 mg/kg for Cr and Cd respectively in belowground
1
2 274 parts.
3
4 275 By comparison, in the M3 condition *F. japonica* accumulated more of each metal than the
5
6
7 276 hybrid, especially Zn and Cd, for which, concentrations were as high as 833.0 and 19.5 mg/kg
8
9
10 277 respectively in aerial parts of some individuals, and of up to 244.0 mg/kg for Cr in belowground
11
12 278 parts whereas Pb was also poorly accumulated (Fig. 7A-D right).
13
14 279 It is also interesting to notice that, except for Zn, *F. japonica* accumulated very limited amounts
15
16
17 280 of metals compared to *F. x bohemica* in the control M0 condition (Fig. 7A-D left). Though, its
18
19 281 translocation factor varies not much with the presence of high concentrations of metal (from 3
20
21
22 282 to 5 for Cd and from 2 to 3 for Zn in M0 and M3 conditions respectively) compared to *F. x*
23
24 283 *bohemica*.

26 284 **Discussion**

27
28
29 285 In this study we assessed the effect of an artificial polymetallic pollution of soil on *Fallopia*
30
31 286 spp. performance, and more precisely its impact on rhizome regeneration and growth occurring
32
33
34 287 in the early stages of vegetative propagation, as well as its impact on belowground secondary
35
36 288 metabolism.

37
38
39 289 Our results showed that the presence of heavy metals in soil induced a delay for plants to reach
40
41 290 half of their maximal height, delay that was more pronounced with high metal concentrations.
42
43
44 291 Though, after three months of growth, plant final height of both genotypes was not impacted
45
46 292 by metal pollution and it was even significantly greater for M2-treated group compared to
47
48
49 293 control. This implies that plant growth speed was higher when metals were present. The
50
51 294 observed delay in rhizome regeneration induced by metallic pollution could be correlated with
52
53 295 the fact that metabolic changes in belowground parts of the plant were only observed after one
54
55
56 296 month of growth and not after three. This suggests that the delay in rhizome regeneration
57
58 297 induced by the presence of metals is due to plant investment in the production of secondary
59
60
61
62
63
64
65

298 metabolites rather than in primary metabolites needed for cell and tissue multiplications (as
299 demonstrated in the “grow or defend” theory; Herms and Mattson, 1992). It also correlates with
300 the fact that lowered plant part weights were measured in metal-treated groups. One of the plant
301 growth traits affected by metal treatment was belowground part weight which was reduced
302 when metals were added at high concentrations suggesting a toxic effect. On the other hand,
303 aerial parts were not affected by these treatments indicating that this plant shows an overall
304 good tolerance to metal stress regarding the concentrations added. The fact that aerial part
305 weight was affected with low doses of metals (i.e. M1-treatment) reveals that this plant might
306 be very sensitive to soil metal concentrations.

307 Concerning plant metal accumulation, the reported values of this study are in the range of the
308 highest published, except for Pb which was not accumulated and Cr which was found at
309 concentrations up to three times more than those reported in underground parts and up to ten
310 times in aerial parts (**Fig. 6** and **Table 2**). The fact that Cr was present at concentrations up to
311 8 times higher in soil may explain in part these results. Of particular interest is the fact that Zn
312 and Cd translocation factors were increased in the case of *F. japonica* and even inverted in the
313 case of *F. x bohemica* with Cd and Zn, when plants were exposed to high metal concentrations,
314 suggesting a change in plant nutritional strategy. Although these observations are interesting
315 for the potential valorisation of this plant in phytoremediation of contaminated sites, caution
316 must be taken for the extrapolation of these results to what occurs *in situ*, since we only worked
317 on young shoots which may accumulate more than old ones, and as stressed by Van der Ent et
318 al. (2012), these types of controlled-approaches have very limited relevance in explaining what
319 occurs in natural environment although the polymetallic contamination applied in our study is
320 probably closer to what happens in urban ecosystems for example. In all cases further
321 mesocosm and field studies are required to confirm the results obtained.

322 The consequences of metal accumulation in the plant and its relative high tolerance and
1
2 323 sensitivity to polymetallic stress let us hypothesize that these traits may serve the plant to
3
4 324 rapidly colonize diversely polluted environments, where other plant species might be excluded
5
6
7 325 because of the presence of metals in soils. Herbivory may also be limited because of metal
8
9
10 326 accumulation in plant aerial parts which may have a repellent effect on predators (especially
11
12 327 young shoots that may be more prompt to herbivory attacks; Price 1991). The molecular
13
14 328 mechanisms involved in metal tolerance remain to be elucidated, though the metabolic profiling
15
16
17 329 approach undertook in this study might bring some clue about the secondary metabolites
18
19 330 directly or indirectly involved in metal tolerance. Torosachryson was identified as one of the
20
21
22 331 compound for which the relative proportions were the most increased in roots with metal
23
24 332 concentrations, this independently of plant age or genotype. To our knowledge this is the first
25
26
27 333 report of this compound in this genus. It has been described to be involved in anthraquinone
28
29 334 biosynthesis (Abdel-Rahman et al. 2013), compounds that are well known in *Fallopia* spp.
30
31
32 335 (Piola et al. 2013), and that have also been characterized with higher relative proportions in
33
34 336 metal-treated plant roots in this study (data not shown). The exact role of torosachryson in
35
36 337 metal tolerance and/or accumulation is still to be elucidated but from the results of our study, it
37
38
39 338 seems to be well involved directly or indirectly in plant adaptation to metallic stress. Following
40
41 339 the “plant call for support theory” emitted by Thijs et al. (2016), this compound could have an
42
43
44 340 impact on the selection of rhizosphere microbes possessing the ability to improve plant
45
46 341 tolerance to metallic stress. Further experiments including field studies should be conducted in
47
48
49 342 order to confirm these findings, for example the correlation between torosachryson content in
50
51 343 roots and heavy metal content in plant or soil collected *in situ* could be interesting to analyse.
52
53
54 344 The production of torosachryson by fungal strain has also been reported (Gill, 2003; Müller et
55
56 345 al. 2004) leading to the hypothesis that this compound might be produced by fungal endophytes.
57
58 346 The presence of such associated microbes has recently been shown in this plant through the
59
60
61
62
63
64
65

1 347 identification of Dark Septates Endophytes (DSE) microsclerotia colonizing roots (Gucwa-
2 348 Przepióra et al. 2016). These fungal endophytes, which are characterized by their melanised
3
4 349 and septate hyphae, are frequent associated root endophytes of herbaceous plants. They have
5
6
7 350 been described as important determinants influencing plant tolerance to heavy metal stress
8
9
10 351 because they are able to tolerate high concentration of metallic trace elements, notably through
11
12 352 the increase of melanin which enables to decrease metal toxicity (Ban et al. 2012). Whether
13
14 353 these micro-organisms play a role in *Fallopia* adaptation to heavy metal stress remains to be
15
16
17 354 confirmed, but the findings of our study in the light of recent literature on the subject let us
18
19 355 suggest that it is the case.
20

21 356

24 357 **Conclusion**

26 358 To conclude, our findings evidenced that the presence of toxic metals in soil had a low impact
27
28
29 359 on Japanese Knotweed *s.l.* overall performance traits during vegetative propagation, and had a
30
31 360 rather stimulating effect on plant growth depending on pollution level:

34 361 - the presence of metal in soil induced a change in plant belowground secondary metabolism
35
36 362 which only occurs at early stages of plant vegetative propagation and this might be correlated
37
38
39 363 with the observed metal-induced delay in rhizome regeneration and with lowered plant part
40
41 364 weights under metal stress.

44 365 - on the other hand the fact that plant final height was not affected (or even increased at some
45
46 366 concentrations), and that plant metal accumulation and nutritional strategies were modified
47
48
49 367 depending on metal concentrations in soil, might suggest that this plant is very sensitive to the
50
51 368 presence of metal in soil and that it may explain, at least in part, its capacity to rapidly colonize
52
53 369 anthropized metal-polluted environments. All these results need to be confirmed with further
54
55
56 370 *in situ* studies and/or controlled mesocosm studies using naturally polluted soils.

58 371

372 **Acknowledgements**

1
2 373 This study was funded by Initiative Structurante EC2CO (Ecosphère Continentale et Cotière) -

3
4 374 ECODYN (Ecotoxicologie, Ecodynamique des contaminants) and FR3728 BioEnviS

5
6
7 375 (Université Claude Bernard Lyon1).

8
9 376 We also thank the ‘Serre et chambres climatiques’ platform (Université Claude Bernard Lyon1,

10
11
12 377 FR3728) and Elise Lacroix for her help with plant culture.

13
14 378

15
16
17 379 **References**

18
19 380

20
21 381 Abdel-Rahman IAM, Beuerle T, Ernst L, Abdel-Baky AM, Desoky EEDK, Ahmed AS,

22
23
24 382 Beerhues L (2013) *In vitro* formation of the anthranoid scaffold by cell-free extract from yeast-

25
26 383 extract-treated *Cassia bicapsularis* cell cultures. *Phytochem* 88:15-24

27
28
29 384

30
31 385 Bailey JP, Bimova K, Mandak B (2009) Asexual spread versus sexual reproduction and

32
33
34 386 evolution in Japanese Knotweed *s.l.* sets the stage for the “Battle of the Clones”. *Biol Invasions*

35
36 387 11:1189-1203

37
38
39 388

40
41 389 Baize D, Deslais W, Saby NPA, Bispo A, Feix I (2007) Analyses totales et pseudo-totales

42
43
44 390 d’éléments en trace dans les sols. Principaux résultats et enseignement d’une collecte nationale.

45
46 391 *Etude et Gestion des Sols* 13:180-200

47
48
49 392

50
51 393 Baker AJM (1981) Accumulators and excluders – strategy in the response of plants to heavy

52
53 394 metals. *J Plant Nutr* 3:643-654

54
55
56 395

57
58
59
60
61
62
63
64
65

396 Ban Y, Tang M, Chen H, Xu Z, Zhang H, Yang Y (2012) The response of Dark Septate
1
2 397 Endophytes (DSE) to heavy metals in pure culture. PLoS One 7(10):e47968
3
4 398
5
6
7 399 Cheynier V, Comte G, Davies KM, Lattanzio V, Martens S (2013) Plant phenolics: recent
8
9 400 advances on their biosynthesis, genetics, and ecophysiology. Plant Physiol Biochem 72:1-20
10
11 401
12
13
14 402 Dassonville N, Guillaumaud N, Piola F, Meerts P, Poly F (2011) Niche construction by the
15
16 403 invasive Asian knotweeds (species complex *Fallopia*): impact on activity, abundance and
17
18 404 community structure of denitrifiers and nitrifiers. Biol Invasions 13:1115-1133
19
20
21 405
22
23
24 406 Elton, C.S. (1958).The ecology of invasions of animals and plants. Methuen, London
25
26 407
27
28
29 408 Gaskin JF, Schwarzländer M, Grevstad FS, Haverhals MA, Bouchier RS, Miller TW (2014)
30
31 409 Extreme differences in population structure and genetic diversity for three invasive congeners:
32
33 410 knotweeds in western North America. Biol Invasions 16:2127
34
35
36 411
37
38
39 412 Gill M (2003) Pigments of fungi (Macromycetes). Nat Prod Rep 20:615-639
40
41 413
42
43
44 414 Groeneveld E, Belzile F, Lavoie C (2014) Sexual reproduction of Japanese Knotweed (*Fallopia*
45
46 415 *japonica* S.L.) at its northern distribution limit: new evidence of the effect of climate warming
47
48 416 on an invasive species. Am J Bot 101:459-466
49
50
51 417
52
53
54 418 Gucwa-Przepióra E, Chmura D, Sokolowska K (2016) AM and DSE colonization of invasive
55
56 419 plants in urban habitat: a study of Upper Silesia (southern Poland). J Plant Res 129:603-614
57
58 420
59
60
61
62
63
64
65

421 Hanikenne M, Nouet C (2011) Metal hyperaccumulation and hypertolerance: a model for plant
1
2 422 evolutionary genomics. *Curr Opin Plant Biol* 14:252-259
3
4
5 423
6
7 424 Herms DA, Mattson WJ (1992) The dilemma of plant: to grow or defend. *Q Rev Biol* 67:283-
8
9
10 425 334
11
12 426
13
14 427 Knezevic SZ, Streibig JC, Ritz C (2007) Utilizing R software package for dose-response
15
16
17 428 studies: The concept and data analysis. *Weed Technol* 21:840-848
18
19 429
20
21
22 430 Michalet S, Rohr J, Warshan D, Bardon C, Roggy J-C, Domenach A-M, Czarnes S, Pommier
23
24 431 T, Combourieu B, Guillaumaud N, Bellvert F, Comte G, Poly F (2013) Phytochemical analysis
25
26
27 432 of mature tree root exudates in situ and their role in shaping soil microbial communities in
28
29 433 relation to tree N-acquisition strategy. *Plant Physiol Biochem* 72:169-177
30
31 434
32
33
34 435 Müller M, Lamottke K, Löw E, Magor-Veenstra E, Steglich W (2000) Stereoselective total
35
36 436 syntheses of atrochryson, torosachryson and related 3,4-dihydroanthracen-1(2H)-ones. *J*
37
38
39 437 *Chem Soc Perkin Trans 1* 15:2483-2489
40
41 438
42
43
44 439 Müller M, Lamottke K, Steglich W, Busemann S, Reichert M, Bringmann G, Spiteller P (2004)
45
46 440 Biosynthesis and stereochemistry of phlegmacin-type fungal pigments. *Eur J Org Chem*
47
48 441 23:4850-4855
49
50
51 442
52
53 443 Nishizono H, Kubota K, Suzuki S, Ishii F (1989) Accumulation of heavy metals in cell walls
54
55
56 444 of *Polygonum cuspidatum* roots from metalliferous habitats. *Plant Cell Physiol* 30:595-598
57
58 445
59
60
61
62
63
64
65

- 446 Piola F, Bellvert F, Meiffren G, Rouifed S, Walker V, Comte G, Bertrand C (2013) Invasive
1
2 447 *Fallopia × Bohemica* interspecific hybrids display different patterns in secondary metabolites.
3
4
5 448 *Ecoscience* 20:230-239
6
7 449
8
9
10 450 Price PW (1991) The plant vigor hypothesis and herbivore attack. *Oikos* 62:244-251
11
12 451
13
14 452 Rajkumar M, Sandhya S, Prasad MNV, Freitas H (2012) Perspectives of plant-associated
15
16 453 microbes in heavy metal phytoremediation. *Biotechnol Adv* 30:1562-1574
17
18
19 454
20
21 455 Singh S, Parihar P, Singh R, Singh VP, Prasad SM (2016) Heavy metal tolerance in plants: role
22
23
24 456 of transcriptomics, proteomics, metabolomics, and ionomics. *Front Plant Sci* 6:1143
25
26 457
27
28
29 458 Širka VH, Jakovljević K, Mihailović N, Jovanović S (2016) Heavy metal accumulation in
30
31 459 invasive *Reynoutria x bohemica* Chrtek & Chrtkova in polluted areas. *Environ Earth Sci* 75:951
32
33
34 460
35
36 461 Sołtysiak J, Berchová-Bímová K, Vach M, Brej T (2011) Heavy metals content in the *Fallopia*
37
38 462 genus in Central European Cities - study from Wrocław and Prague. *Acta Botanica Silesiaca*
39
40
41 463 7:209-218
42
43
44 464
45
46 465 Sołtysiak J, Brej T (2012) Characteristics that make the *Fallopia* genus (Polygonaceae) highly
47
48 466 invasive. *Ecological Questions* 16:23-27
49
50
51 467
52
53 468 Sołtysiak J, Brej T (2014) Invasion of *Fallopia* genus plants in Urban Environment. *Pol J*
54
55 469 *Environ Stud* 23:449-458
56
57
58 470
59
60
61
62
63
64
65

471 Rahmonov O, Czylok A, Orczewska A, Majgier L, Parusel T (2014) Chemical composition of
1
2 472 the leaves of *Reynoutria japonica* Houtt. and soil features in polluted areas. Cent Eur J Biol
3
4 473 9:320-330
5
6
7 474
8
9 475 Rouifed S, Byczek C, Laffray D, Piola, F (2012) Invasive Knotweeds are highly tolerant to salt
10
11
12 476 stress. Environ. Manage 50:1027-1034
13
14 477
15
16 478 Van der Ent A, Baker AJM, Reeves RD, Pollard AJ, Schat H (2012) Hyperaccumulators of
17
18
19 479 metal and metalloid trace elements: facts and fiction. Plant Soil 362:319
20
21
22 480
23
24 481 Van der Ent A, Baker AJM, Reeves RD, Pollard AJ, Schat H (2015) Commentary: toward a
25
26
27 482 more physiologically and evolutionary relevant definition of metal hyperaccumulation in
28
29 483 plants. Front Plant Sci 6:554
30
31 484
32
33 485 Williams F, Eschen R, Harris A, Djeddour D, Pratt C, Shaw RS, Varia S, Lamontagne-Godwin
34
35
36 486 J, Thomas SE, Murphy ST (2010) The economic cost of invasive non-native species on Great
37
38
39 487 Britain. CABI Publishing, Wallingford
40
41 488
42

43
44 489 **Table legends:**

45
46 490 **Table 1.** Theoretical metal concentration achieved in soil (in mg/kg) after artificial pollution in
47
48 491 function of treatment
49

50
51 492
52
53 493 **Table 2.** Highest reported values of heavy metal concentrations (in mg/kg) in soil and plant
54
55
56 494 parts of *Fallopia* spp. Reference literature in which values were published is indicated:
57

58 495 ^aRahmonov et al. 2014; ^bSoltysiak et al. 2011; ^cŠirka et al. 2016.
59
60
61
62
63
64
65

496

1

2 **Figure legends:**

3

4 **Figure 1.** Evolution of mean height (cm) of plant individuals during time (days after
5 plantation), displayed in function of metal treatment for the three months experiment. Small
6 figures represent raw data (○ M0, Δ M1, + M2, x M3) and curves were calculated with the
7 model.
8

9 **Figure 2.** Plant aboveground (**A**) and belowground (**B**) dry weights in function of metal
10 treatment (mean ± S.E.). Statistically significant changes compared to control M0 are
11 highlighted (* $p \leq 0.05$, ** $p \leq 0.01$).
12

13 **Figure 3.** Principal Component Analyses (PCA) of rhizome (**A, B**) and root (**C, D**) extracts
14 obtained after 1 month of growth and based on UV-absorbing compound chromatographic
15 profiles integrated at 280 nm and expressed as relative peak areas. Genotypes (**A, C**) and metal
16 treatments (**B, D**) are displayed following PC1 and PC2: for rhizome extracts PC1=24.4% and
17 PC2=20.3% (N=26 samples; 80 peaks) and for root extracts PC1=33.4% and PC2=15.4%
18 (N=26 samples; 114 peaks).
19

20 **Figure 4.** Principal Component Analyses (PCA) of rhizome (**A, B**) and root (**C, D**) extracts
21 obtained after 3 months of growth and based on UV-absorbing compound chromatographic
22 profiles integrated at 280 nm and expressed as relative peak areas. Genotypes (**B, C**) and metal
23 treatments (**B, D**) are displayed following PC1 and PC2: for rhizome extracts PC1=27.9% and
24 PC2=17.6% (N=45 samples; 107 peaks) and for root extracts PC1=23.9% and PC2=15.2%
25 (N=45 samples; 101 peaks).
26

27 **Figure 5.** Principal Component Analyses (PCA) of rhizome (**A, B**) and root (**C, D**) pooled
28 extracts and based on UV-absorbing compound chromatographic profiles integrated at 280 nm
29 and expressed as relative peak areas. Duration of experiment (**A, D**) and genotypes (**B, E**) are
30 displayed following PC1 and PC2, whereas metal treatments (**C, F**) are displayed following
31

521 PC1 and PC3: for rhizome extracts PC1=26.0%, PC2=17.3% and PC3=6.9% (N=14 samples;
1
2 522 64 peaks) and for root extracts PC1=20.6%, PC2=12.6% and PC3=9.1%. (N=14 samples; 62
3
4
5 523 peaks).

6
7 524 **Figure 6:** Molecular structure of torosachryson (A), its experimental UV spectra (B) which is
8
9
10 525 similar to what was described by Müller et al. (2000) for the compound (R)-[methoxy-
11
12 526 ¹³C]torosachryson (R)-2, and its experimental HRMS (*m/z*: [M+H]⁺ calc. for C₁₆H₁₇O₅:
13
14 527 289.1076, found 289,1074; match score 98%) and MSMS spectra in positive mode (C). The
15
16
17 528 later was identical to the data presented by Abdel-Rahman et al. (2013) in which a
18
19 529 fragmentation pattern is also proposed for this molecule, pattern confirmed by HRMS data of
20
21
22 530 this study.

23
24 531 **Figure 7:** Heavy metal content (Cd: A; Cr: B; Pb: C; Zn: D; in mg/kg) in soil and plant parts
25
26 532 of *F. japonica* (Fj) and *F. x bohemica* (Fxb) grown in M0- and M3-treated groups (mean ± S.D.
27
28
29 533 of 3 biological replicates in each case). BP: belowground parts; AP: aboveground parts.
30
31
32
33
34
35
36
37
38
39
40
41
42
43
44
45
46
47
48
49
50
51
52
53
54
55
56
57
58
59
60
61
62
63
64
65

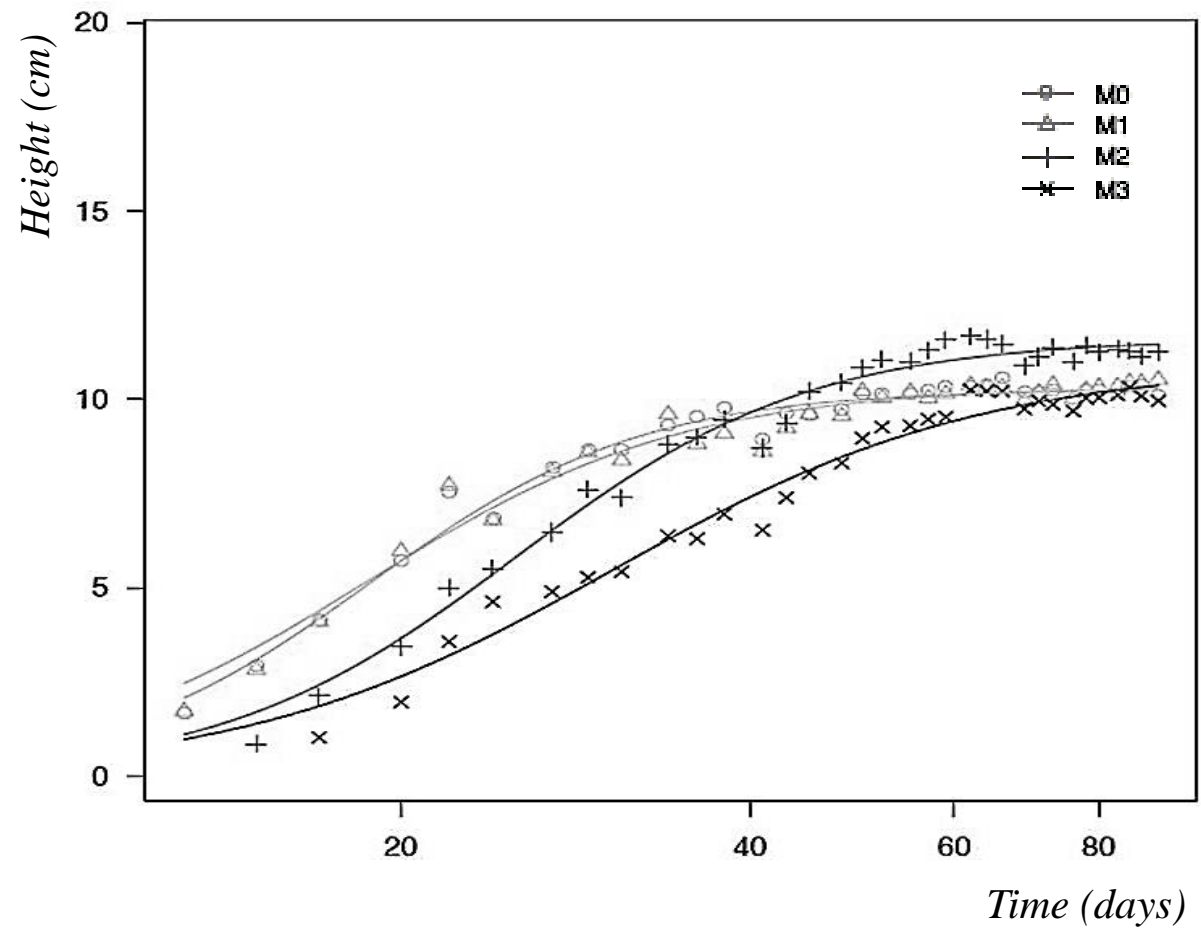

Figure 1

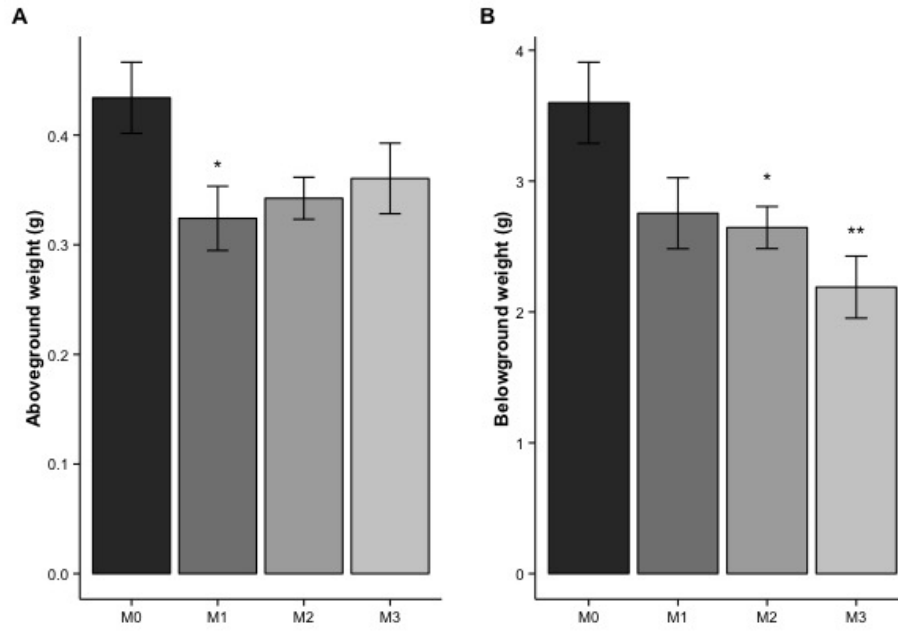

Figure 2

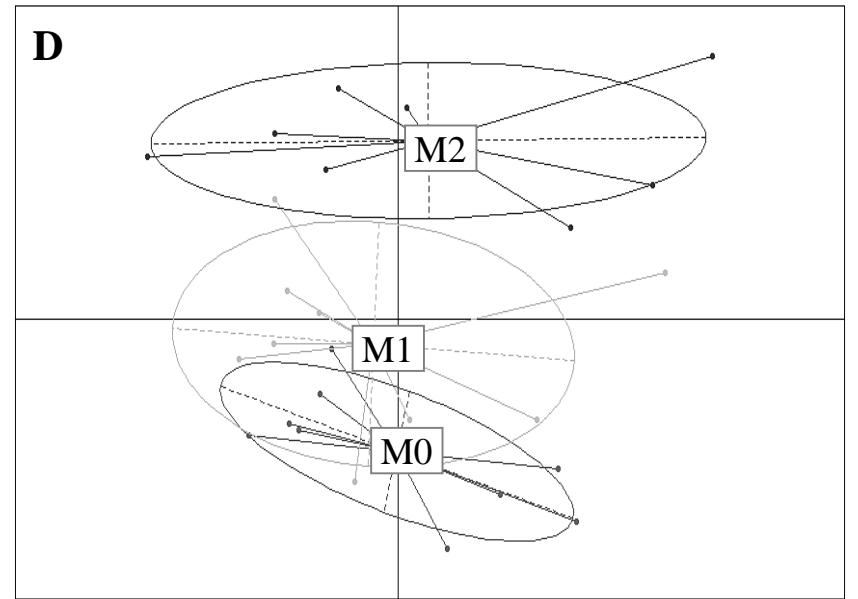
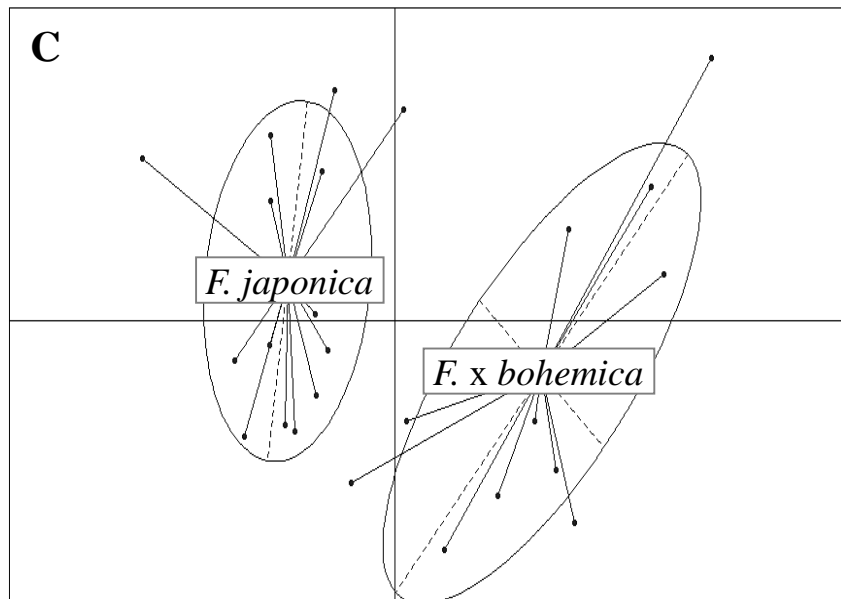
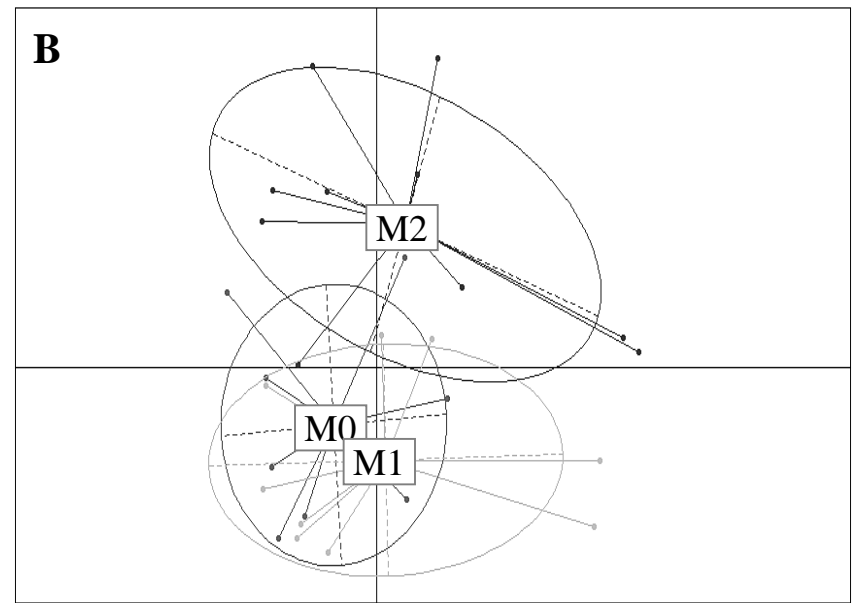
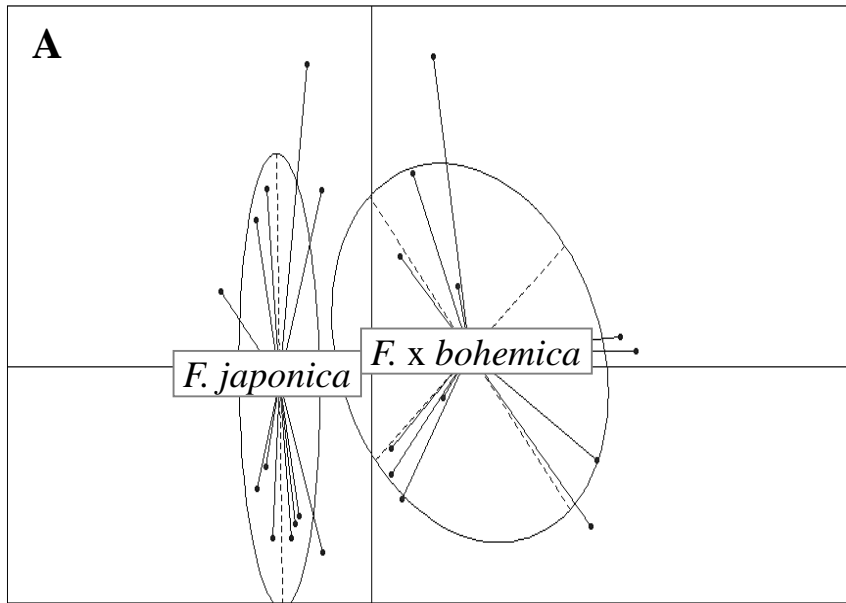

Figure 3

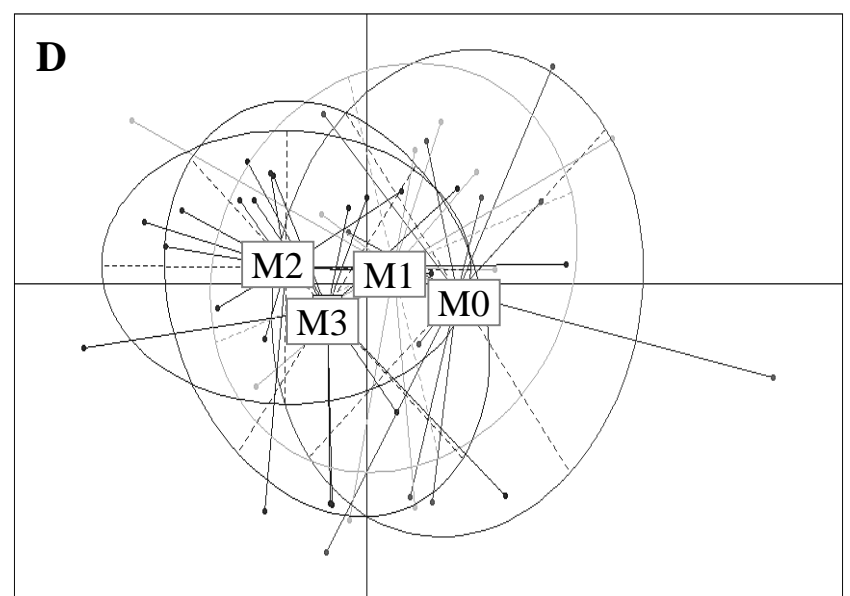
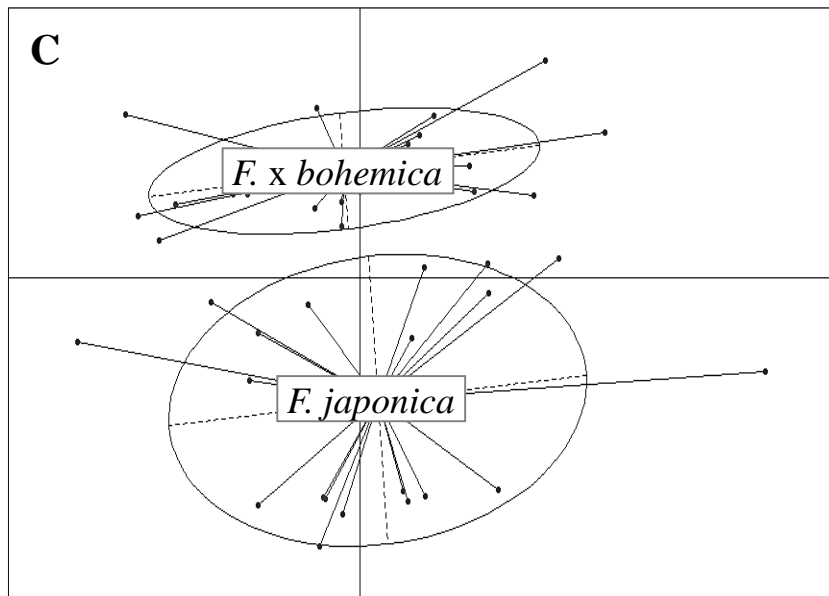
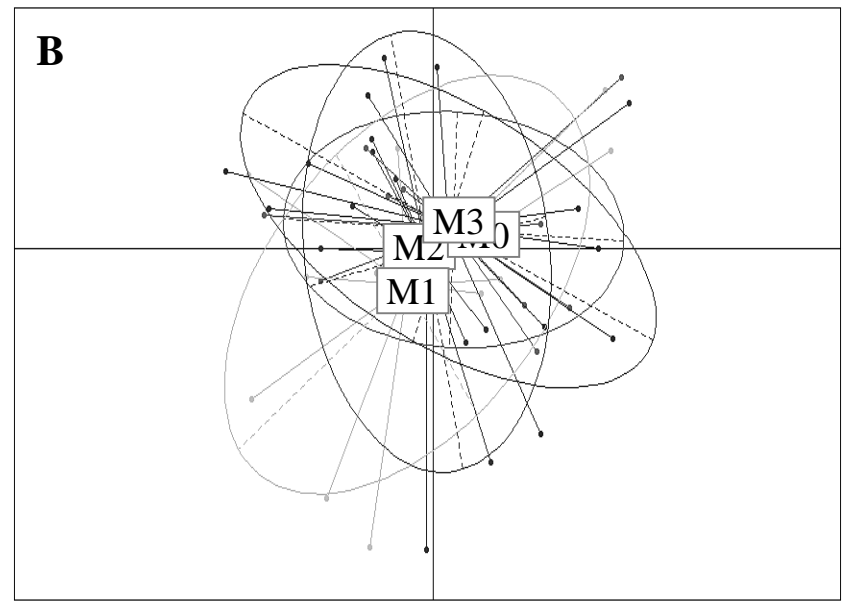
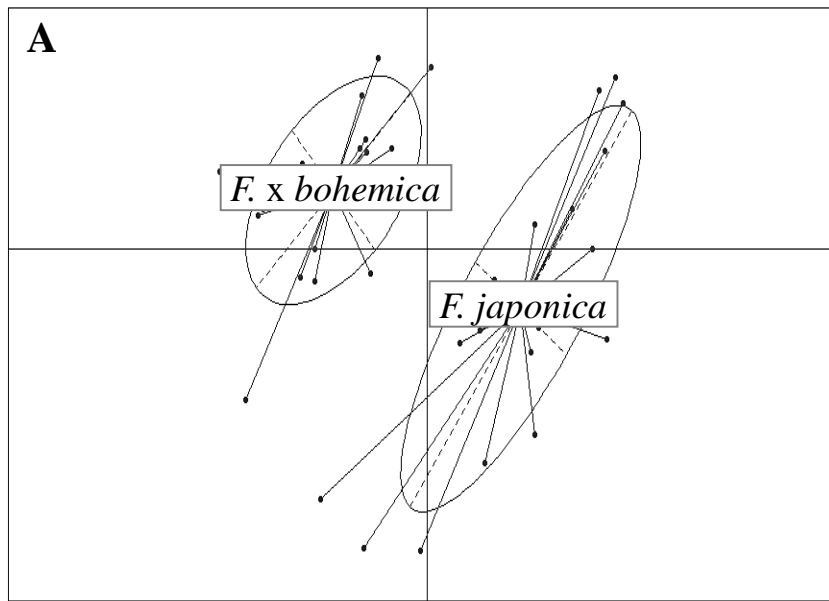

Figure 4

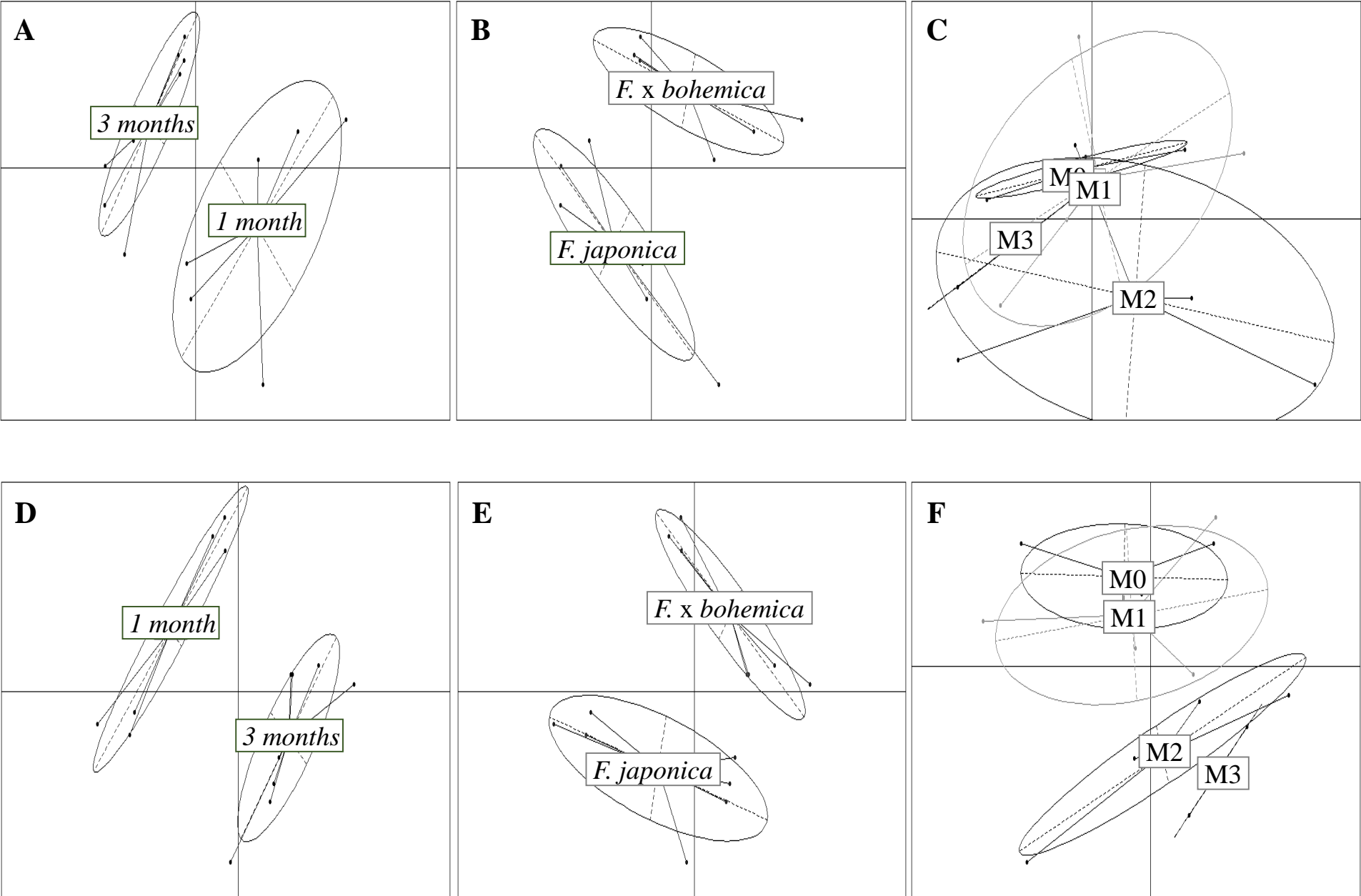

Figure 5

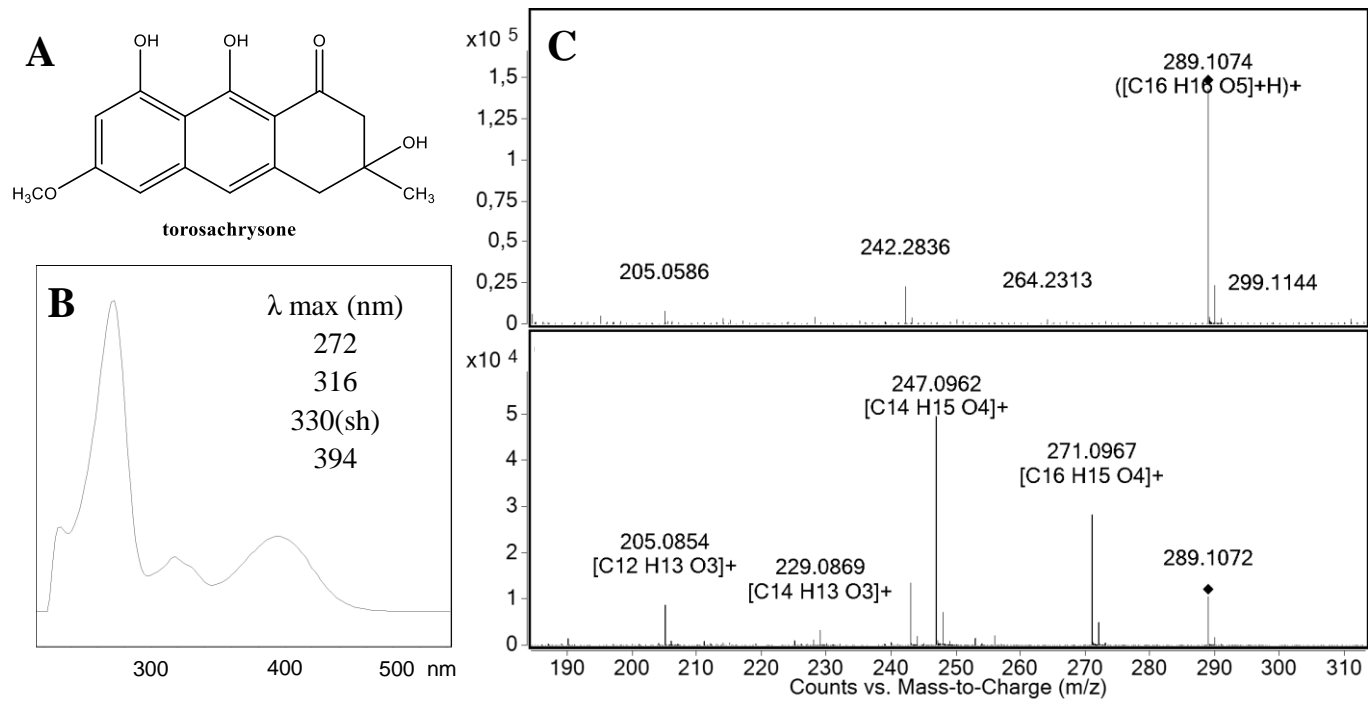

Figure 6

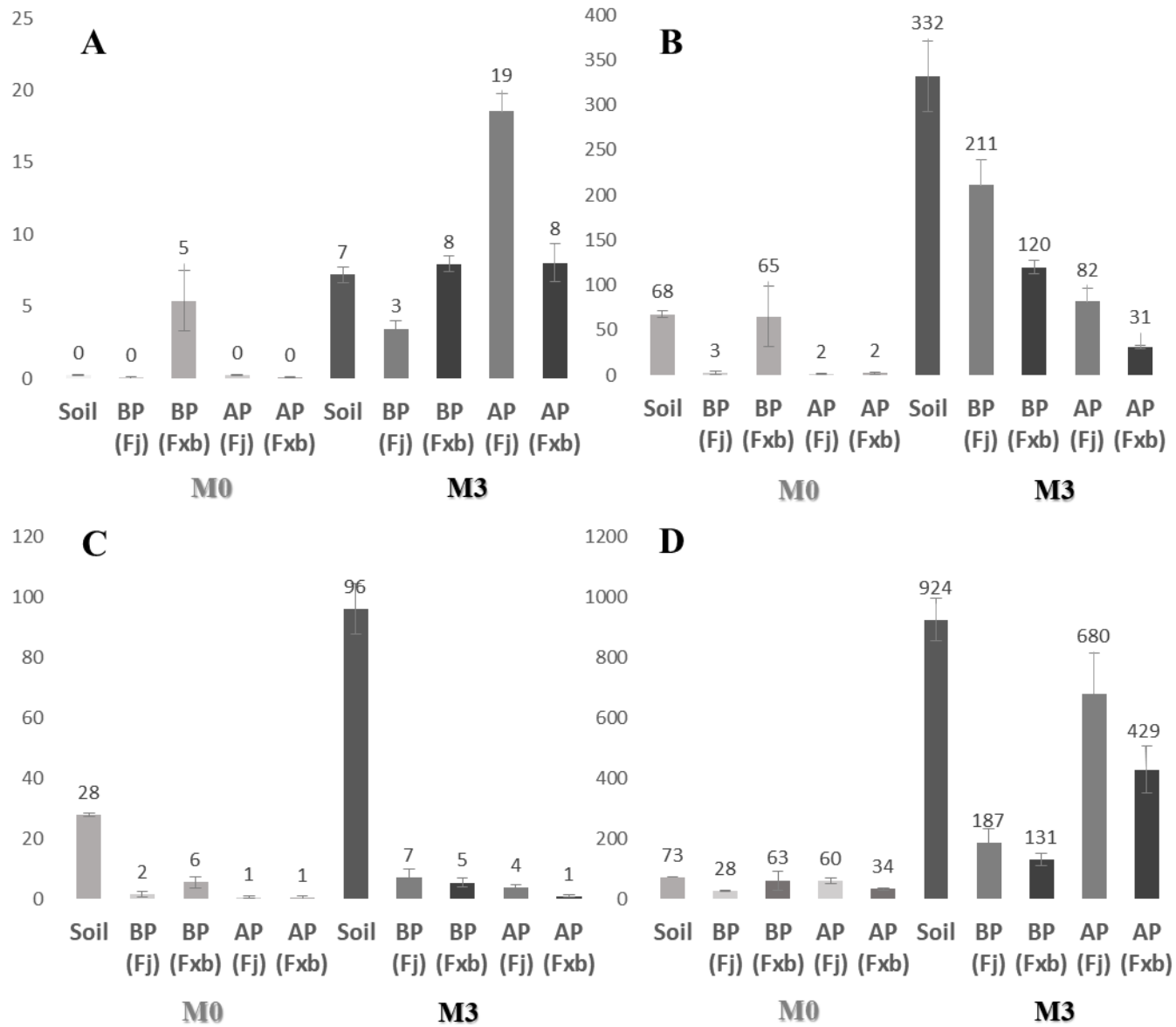

Figure 7

Metals	Non polluted (M0)	Polluted +/- (M1)		Polluted + (M2)		Polluted ++ (M3)	
		1 month	3 months	1 month	3 months	1 month	3 months
		Cd	0	0.2	0.1	2	1
Cr	0	15	9	150	90	1500	440
Pb	0	10	6	100	60	1000	295
Zn	0	30	18	300	180	3000	880

Table 1

Metals	Soil	Underground parts	Aerial parts
Cd	6.7 ^a	19.7 ^b	6.7 ^b
Cr	59.8 ^b	40.9 ^b	2.7 ^c
Pb	203.0 ^b	27.3 ^b	10.7 ^c
Zn	2623.0 ^b	357.0 ^b	541.7 ^a

Table 2



[Click here to access/download](#)

Supplementary Material

[Michalet_et_al_second revision_with corrections.docx](#)

