



HAL
open science

A small closed convex projective 4-manifold via Dehn filling

Gye-Seon Lee, Ludovic Marquis, Stefano Riolo

► **To cite this version:**

Gye-Seon Lee, Ludovic Marquis, Stefano Riolo. A small closed convex projective 4-manifold via Dehn filling. 2019. hal-02334154v1

HAL Id: hal-02334154

<https://hal.science/hal-02334154v1>

Preprint submitted on 25 Oct 2019 (v1), last revised 9 Apr 2021 (v3)

HAL is a multi-disciplinary open access archive for the deposit and dissemination of scientific research documents, whether they are published or not. The documents may come from teaching and research institutions in France or abroad, or from public or private research centers.

L'archive ouverte pluridisciplinaire **HAL**, est destinée au dépôt et à la diffusion de documents scientifiques de niveau recherche, publiés ou non, émanant des établissements d'enseignement et de recherche français ou étrangers, des laboratoires publics ou privés.

A SMALL CLOSED CONVEX PROJECTIVE 4-MANIFOLD VIA DEHN FILLING

GYE-SEON LEE, LUDOVIC MARQUIS, AND STEFANO RIOLO

ABSTRACT. In order to obtain a closed orientable convex projective four-manifold with small positive Euler characteristic, we build an explicit example of convex projective Dehn filling of a cusped hyperbolic four-manifold through a continuous path of projective cone-manifolds.

1. INTRODUCTION

Convex projective manifolds form an interesting class of aspherical manifolds, including complete hyperbolic manifolds. We refer to [Ben08, Mar14, CLM18] and [Mar18] for surveys on convex projective manifolds and hyperbolic 4-manifolds, respectively. This class of geometric manifolds has been studied notably in the context of deformations of geometric structures on manifolds or orbifolds (see the survey [CLM18] and the references therein), or for its link to dynamical systems through the notion of Anosov representation [Ben04, DGK18, DGK17] (see [Lab06, GW12] for the notion of Anosov representation).

A *convex projective n -manifold* is the quotient Ω/Γ of a properly convex¹ domain Ω in the real projective space \mathbb{RP}^n by a subgroup Γ of the projective linear group $\mathrm{PGL}_{n+1}(\mathbb{R})$ acting freely and properly discontinuously on Ω . A *convex projective n -orbifold* is defined similarly without requiring the action of Γ to be free. If Ω is endowed with its Hilbert metric, then Γ acts on Ω by isometry, and the manifold (or orbifold) Ω/Γ inherits a complete Finsler metric (see [Ver05] for an introduction to Hilbert geometry). In the case that Ω is an open ellipsoid, it is isometric to the hyperbolic space \mathbb{H}^n ,² and the quotient Ω/Γ is said to be *hyperbolic*. A *convex projective* (resp. *complete hyperbolic*) *structure* on a manifold M is a diffeomorphism between M and a convex projective (resp. hyperbolic) manifold Ω/Γ . A non-compact complete hyperbolic manifold of finite volume will be said to be *cusped*.

The goal of this paper is to prove the following:

2010 *Mathematics Subject Classification.* 22E40, 53A20, 53C15, 57M50, 57N16, 57S30.

Key words and phrases. Real projective structure, Hyperbolic 4-manifold, Dehn filling, Euler characteristic, Cone-manifold, Hilbert geometry.

¹A subset Ω of \mathbb{RP}^n is *properly convex* if its closure $\overline{\Omega}$ is contained and convex in some affine chart.

²This is in fact the projective model of the hyperbolic space, also known as the Beltrami–Cayley–Klein model.

Theorem A. *There exists a closed orientable indecomposable³ convex projective 4-manifold X containing 10 disjoint totally geodesic 2-tori $\Sigma = T_1 \sqcup \dots \sqcup T_{10} \subset X$ such that:*

- (1) *The complement $M = X \setminus \Sigma$ admits a complete finite-volume hyperbolic structure.*
- (2) *The Euler characteristic of X (and of M) is 12.*
- (3) *The hyperbolic manifold M has a maximal cusp section in which each filling curve has length 6.*
- (4) *The fundamental group $\pi_1 X$ is relatively hyperbolic with respect to the collection of rank-2 abelian subgroups $\{\pi_1 T_i, \pi_1 T'_i\}_i$, where $\{T'_1, \dots, T'_{10}\}$ is another collection of disjoint, totally geodesic, 2-tori such that each T_i is transverse to each T'_j .*
- (5) *The hyperbolic structure σ_0 on M and the convex projective structure $\sigma_{2\pi}$ on X arise as limits of an analytic path $\theta \mapsto \sigma_\theta$ of projective cone-manifold structures on X , singular along Σ with cone angle $\theta \in (0, 2\pi)$.*
- (6) *For each integer $m \geq 1$, the cone-manifold structure $\sigma_{2\pi/m}$ is induced by a convex projective orbifold Ω_m/Γ_m . For $m \geq 2$, the group Γ_m is relatively hyperbolic with respect to the collection of rank-2 abelian subgroups $\{\pi_1 T_i\}_i$.*

The hyperbolic manifold M has 10 cusps, each with section a 3-torus. A *filling curve* is a closed geodesic in a cusp section of M (with respect to the induced flat metric) that bounds a disc in X .

Cone-manifolds and Dehn filling. Projective cone-manifolds are singular projective manifolds generalising the more familiar hyperbolic cone-manifolds (see Definition 2.1). The convex projective 4-manifold X of Theorem A is obtained from the cusped hyperbolic 4-manifold M (with torus cusps) by “projective Dehn filling”. This is in analogy with Thurston’s hyperbolic Dehn filling [Thu79], where $\theta \mapsto \sigma_\theta$ is a path of hyperbolic cone-manifold structures on a 3-manifold X , singular along a link $\Sigma \subset X$. In both (hyperbolic and projective) cases, as the cone angle θ approaches 2π , the projective cone-manifold structure becomes non-singular, and we get a convex projective structure on X . On the other extreme of the path, as θ tends to 0, the singular locus Σ is drilled away, giving rise to the cusps of the hyperbolic manifold M .

The projective cone-manifold structures σ_θ of Theorem A are singular along the tori Σ , and induce (non-singular) projective structures⁴ on both $M = X \setminus \Sigma$ and Σ . The path $\theta \mapsto \sigma_\theta$ is *analytic*, meaning that for each $\theta \in (0, 2\pi)$, it is possible to choose a holonomy representation $\rho_\theta \in \text{Hom}(\pi_1 M, \text{PGL}_5 \mathbb{R})$ of the projective structure $\sigma_\theta|_M$ so that the function $\theta \mapsto \rho_\theta(\gamma)$ is analytic for all $\gamma \in \pi_1 M$. Each torus $T_i \subset \Sigma$ has a meridian $\gamma_i \in \pi_1 M$ whose holonomy $\rho_\theta(\gamma_i) \in \text{PGL}_5 \mathbb{R}$ is conjugate to a (projective) rotation of angle θ . In addition, the sequence of representations $\{\rho_{2\pi/m}\}_m$ converges algebraically to ρ_0 as $m \rightarrow \infty$, and the sequence of convex sets $\{\overline{\Omega_m}\}_m$ converges to $\overline{\mathbb{H}^4} \subset \mathbb{R}\mathbb{P}^4$ in the Hausdorff topology [CLM16, Section 12].

³A properly convex domain Ω of $\mathbb{R}\mathbb{P}^n$ is *indecomposable* if it is not a convex hull of lower-dimensional domains. A convex projective manifold or orbifold Ω/Γ is *indecomposable* if Ω is indecomposable.

⁴A (real) projective structure on an n -manifold is a $(\text{PGL}_{n+1} \mathbb{R}, \mathbb{R}\mathbb{P}^n)$ -structure.

New features of the result. Theorem A is shown by an explicit construction. It seems that, at the time of writing this paper, the literature misses concrete examples of closed indecomposable convex projective n -manifolds, $n \geq 4$, which do not admit a hyperbolic structure. For the moment, we know only two techniques to obtain such manifolds:

- (1) torsion-free subgroups of some discrete projective reflection groups using Vinberg’s theory [Vin71], as shown by Benoist [Ben06a, Ben06b] and Choi and the first two authors [CLM16, CLM];
- (2) some Gromov–Thurston manifolds, as shown by Kapovich [Kap07].

(There is a clear distinction between the manifolds constructed in [Ben06b, Kap07] and the ones in [Ben06a, CLM16, CLM], including our X : the fundamental groups of the former are Gromov-hyperbolic, but those of the latter are not.)

In contrast with Theorem A, the Selberg lemma has an important role to guarantee the existence of such manifolds in all these cases. In particular, very little is known about the topology of closed convex projective manifolds. Note that our X falls in the first class of examples.

The Euler characteristic of a closed even-dimensional manifold can be seen as a rough measure of its topological complexity. Note that a well-known conjecture states that closed aspherical 4-manifolds have Euler characteristic $\chi \geq 0$, and this is certainly true in the hyperbolic case by the Gauß–Bonnet theorem. Our manifold X has $\chi(X) = 12$, and appears to be the closed orientable indecomposable convex projective 4-manifold with the smallest known Euler characteristic (to the best of our knowledge). In the hyperbolic case, the smallest known value of χ is 16 [CM05, Lon08].

Theorem A is an effective version, in dimension four, of a result by Choi and the first two authors [CLM16, Theorem B]. Let us first recall their construction, called “convex projective generalised Dehn filling”. They build a sequence of discrete projective reflection groups $\{\Gamma_m\}_{m \geq m_0}$ of $\mathrm{PGL}_{n+1}\mathbb{R}$, each acting cocompactly on a properly convex domain $\Omega_m \subset \mathbb{R}\mathbb{P}^n$ of dimension $n = 4, 5$ or 6 , whose limit as $m \rightarrow \infty$ is a discrete hyperbolic reflection group $\Gamma_\infty < \mathrm{Isom}(\mathbb{H}^n)$ of finite covolume. The group Γ_m has as fundamental domain a compact Coxeter polytope P_m whose combinatorics does not depend on m . The hyperbolic Coxeter polytope P_∞ , instead, is combinatorially obtained from P_m by substituting a ridge with an ideal vertex. In other words, the cusp of the hyperbolic orbifold $\mathbb{H}^n/\Gamma_\infty$ is “projectively filled”. By applying a refined version of Selberg’s lemma ([MRS13, Theorem 3.1], see below) to Γ_∞ , they get a statement similar to Theorem A(6). The difference is that $X = \Omega_{m_0}/\Gamma'_{m_0}$ is “only” an orbifold (where Γ'_{m_0} is a finite-index subgroup of Γ_{m_0}). To promote X to a manifold, one should then apply again the Selberg lemma, this time to Γ'_{m_0} . Thus, our improvement is two-fold: we found an X with small Euler characteristic, and a continuous (rather than discrete) family of cone-manifolds.

Another interesting feature of X is the relative hyperbolicity of $\pi_1 X$. Indeed, Gromov and Thurston [BH96, And06]⁵ have shown that the fundamental group of a Dehn filling

⁵A proof of the Gromov–Thurston 2π theorem was given by Bleiler and Hodgson [BH96] in the context of 3-manifolds, and the same proof holds in any dimension, as explained in [And06, Section 2.1].

of a hyperbolic manifold with torus cusps is relatively hyperbolic with respect to the subgroups associated to the inserted tori, provided that the filling curves are longer than 2π (see also [Osi07, GM08, FM10] for the geometric group theoretic generalisation of that statement). The fundamental group of X is not relatively hyperbolic with respect to the subgroups associated to the inserted tori by Theorem A(4).⁶ There is no contradiction with the Gromov–Thurston 2π -theorem by Theorem A(3).

Divisible convex domains. Recall that a properly convex domain Ω of \mathbb{RP}^n is *divisible* (by Γ) if there exists a discrete subgroup Γ of $\mathrm{PGL}_{n+1}\mathbb{R}$ acting cocompactly on Ω . A theorem of Benoist [Ben04] implies that the indecomposable divisible convex domains $\Omega_m \subset \mathbb{RP}^4$ of Theorem A(6) are not strictly convex⁷ because the groups Γ_m of Theorem A(6) are not Gromov-hyperbolic.

There are very few currently known constructions of inhomogeneous indecomposable divisible non-strictly convex domains. For a complete historical account, we refer the reader to the introduction of [CLM16]. Here we mention only its essentials.

The first construction of such domains is due to Benoist [Ben06a], and has been extended in [Mar10, BDL18, CLM]. In those constructions the compact quotient Ω/Γ is homeomorphic to the union along the boundaries of finitely many submanifolds, each admitting a complete finite-volume hyperbolic structure on its interior. As a result, if Ω is of dimension n , then Γ is relatively hyperbolic with respect to a collection of virtually abelian subgroups of rank $n - 1$.

In [CLM16], a different construction of inhomogeneous indecomposable divisible non-strictly convex domains is given by convex projective generalised Dehn filling. In contrast with the previous examples, these are relatively hyperbolic with respect to a collection of virtually abelian subgroups of rank $n - 2$. The divisible (by Γ_m) domains $\Omega_m \subset \mathbb{RP}^4$ of Theorem A(6) are new examples of this kind.

We point out that at the time of writing there is no example of inhomogeneous indecomposable divisible non-strictly convex domain of dimension n , for any $n \geq 8$.

We stress that such domains, to all appearances, are linked to the geometrisation problem, i.e. putting a (G, X) -structure on a manifold. So far, almost all manifolds geometrised through this process are either obtained by gluing cusped hyperbolic manifolds, or by Dehn filling of a cusped hyperbolic manifold. Here, the goal is to do so with a small manifold and using cone-manifolds. It is especially important that we do not use Selberg’s lemma.

Dehn filling hyperbolic manifolds. Let us say that a closed manifold X is a *filling* of a manifold M if there exists a codimension-2 submanifold $\Sigma \subset X$ such that the complement $X \setminus \Sigma$ is diffeomorphic to M . Note that the manifold M is diffeomorphic to the interior of a compact manifold \overline{M} whose boundary $\partial\overline{M}$ fibres in circles over Σ . Given M , we obtain a

⁶It is relatively hyperbolic with respect to a larger family of abelian groups.

⁷A subset Ω of \mathbb{RP}^n is *strictly convex* if it is properly convex and its boundary does not contain any non-trivial projective line segment.

filling by attaching to \overline{M} the total space of a D^2 -bundle $E \rightarrow \Sigma$ through a diffeomorphism $\partial\overline{M} \rightarrow \partial E$. This operation is commonly called a *Dehn filling* of M . Any cusped hyperbolic manifold M has a finite covering M' with torus cusps [MRS13, Theorem 3.1]. In other words, $\partial\overline{M}'$ consists of $(n-1)$ -tori. The manifold M' has typically infinitely many fillings up to diffeomorphism.

Thurston's hyperbolic Dehn filling theorem states that every filling of a cusped hyperbolic 3-manifold with torus cusps, except for finitely many fillings on each cusp, admits a hyperbolic structure. In dimension $n \geq 4$, a filling of a cusped hyperbolic n -manifold with torus cusps is expected not to admit any hyperbolic structure,⁸ but Theorem A(1) and [CLM16, Theorem B] show that some fillings of some cusped hyperbolic n -manifolds admit a convex projective structure. This leads to the following:

Question 1.1. *Which filling of a cusped hyperbolic manifold of dimension $n \geq 4$ (with torus cusps) admits a convex projective structure?*

It is worth mentioning that almost all fillings of any cusped hyperbolic manifold with torus cusps admit a complete Riemannian metric of non-positive sectional curvature by the Gromov–Thurston 2π theorem [BH96, And06], and an Einstein metric of negative scalar curvature by work of Anderson [And06] and Bamler [Bam12]. Both, in some sense, extend Thurston's 3-dimensional theorem to higher dimension (compare also with [Sch89, FM10, FM11]). But those theorems cannot be applied to the manifold X of Theorem A, since the filling curves are too short.

Let us also note that there is an opportune version of hyperbolic Dehn filling in dimension 4: one can sometimes fill some cusps of a hyperbolic 4-manifold and get another cusped hyperbolic 4-manifold, at the expense of drilling some totally geodesic surfaces [MR18, LMRY].

Projective flexibility. Thurston's hyperbolic Dehn filling theorem essentially relies on the flexibility of the complete hyperbolic structure of cusped hyperbolic 3-manifolds. The local rigidity theorem of Garland and Raghunathan [GR70] (see also [BG04]), on the other hand, says that the holonomy representation ρ of any cusped hyperbolic manifold M of dimension $n \geq 4$ has a neighbourhood in $\text{Hom}(\pi_1 M, \text{Isom}(\mathbb{H}^n))$ consisting of conjugates of ρ . Now, Theorem A(5) shows that the hyperbolic structure σ_0 on the 4-manifold M is *projectively flexible*, i.e. the conjugacy class of the holonomy representation ρ_0 of σ_0

$$[\rho_0] \in \text{Hom}(\pi_1 M, \text{PGL}_5(\mathbb{R})) / \text{PGL}_5(\mathbb{R})$$

is not an isolated point. To avoid confusion with the terminology, we mention that in this definition of flexibility there is no restriction on the holonomy of the peripheral subgroups of $\pi_1 M$. For instance, all cusped hyperbolic 3-manifolds are projectively flexible by the hyperbolic Dehn filling theorem. It is thus natural to ask the following question, which is a priori different from Question 1.1.

⁸All but finitely many fillings do not admit a hyperbolic structure.

Question 1.2. *Which cusped hyperbolic 4-manifold is projectively flexible? Is every cusped hyperbolic 4-manifold finitely covered by a projectively flexible one?*⁹

We note that some cusped hyperbolic 4-orbifolds, for example the Coxeter pyramid $[6, 3, 3, 3, \infty]$, are not projectively flexible [Vin71, Proposition 20].

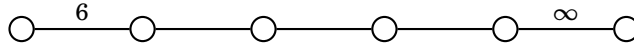

FIGURE 1. The Coxeter diagram of the pyramid $[6, 3, 3, 3, \infty]$ (see Section 2.3 for the basic terminology on Coxeter groups). The associated cusped hyperbolic 4-orbifold is projectively rigid.

On the proof. As already said, the proof of Theorem A is constructive. We begin with the ideal hyperbolic rectified 4-simplex $R \subset \mathbb{H}^4$, which is a Coxeter polytope. By applying the techniques introduced in [CLM16], we perform a “convex projective generalised Dehn filling” to R : the hyperbolic structure on the orbifold R is deformed to projective structures which extend to structures of “mirror polytope” (see Section 2.2) on the bitruncated 4-simplex Q (see Section 2.5). Note that Q minus some ridges is stratum-preserving homeomorphic to R . This will be translated into the fact that X minus some tori is diffeomorphic to M .

We build the hyperbolic manifold M as an orbifold covering of R , by exploiting a construction by Kolpakov and Slavich [KS16]. By lifting the deformation from R to M , we get the path $\theta \mapsto \sigma_\theta$. The manifold X covers a Coxeter orbifold based on the bitruncated 4-simplex Q .

Since there exist cusped hyperbolic 4-manifolds M_0 tessellated by copies of R with $\chi(M_0) < 12$ [KS16, Sla17, RS19b, KRR18], one could wonder why not to build a smaller convex projective manifold X by Dehn filling such an M_0 . A first obstruction is topological: a cusp section of those M_0 does not always fibre in circles. Even when all cusp sections of such an M_0 do fibre in circles then M_0 does not cover R , but covers the quotient of R by its symmetry group. The latter is the Coxeter pyramid $[6, 3, 3, 3, \infty]$ [RS19b, Lemma 2.2], which is projectively rigid, so our technique does not apply in these cases.

Structure of the paper. In Section 2 we introduce some basic concepts of projective cone-manifolds, mirror polytopes and the truncation process of the 4-simplex, and in Section 3 we prove Theorem A.

Acknowledgements. We would like to thank Caterina Campagnolo, Roberto Frigerio and Marco Moraschini for interesting discussions. Part of this work was done when the second and third authors visited the mathematics department of Heidelberg university, which we thank for the hospitality.

⁹Similar considerations were done by Cooper, Long and Thistlethwaite [CLT07] for closed hyperbolic 3-manifolds.

G.L. was supported by the European Research Council under ERC-Consolidator Grant 614733 and by DFG grant LE 3901/1-1 within the Priority Programme SPP 2026 “Geometry at Infinity”, and he acknowledges support from U.S. National Science Foundation grants DMS 1107452, 1107263, 1107367 “RNMS: Geometric structures And Representation varieties” (the GEAR Network). L.M. acknowledges the Centre Henri Lebesgue for his support. S.R. was supported by the Mathematics Department of the University of Pisa (research fellowship “Deformazioni di strutture iperboliche in dimensione quattro”), and by the Swiss National Science Foundation (project no. PP00P2-170560).

2. PRELIMINARIES

In this section we introduce some preliminary notions and fix some notation.

2.1. Projective cone-manifolds. Riemannian (G, X) cone-manifolds were introduced by Thurston [Thu98] (see also [McM17]). If the geometry (G, X) locally embeds in real projective geometry $(\mathrm{PGL}_{n+1}\mathbb{R}, \mathbb{RP}^n)$ (such as the constant-curvature geometries), a (G, X) cone-manifold can be thought as a projective cone-manifold. Hyperbolic cone-manifolds of dimension 3 appear in the proofs of Thurston’s hyperbolic Dehn filling theorem [Thu79] (see also [Mar16, Chapter 15]) and of the orbifold theorem [CHK00, BLP05]. Projective cone-manifolds were introduced by Danciger [Dan11, Dan13] in the context of geometric transition from hyperbolic to Anti-de Sitter 3-dimensional structures. Quite recently, some higher-dimensional cone-manifolds are used, in particular, in dimension 4: for hyperbolic Dehn filling or degeneration [MR18, LMRY], and in the projective context of AdS-hyperbolic transition [RS19a].

We now define projective cone-manifolds “with cone angles along link singularities”. Our definition is in the spirit of Barbot–Bonsante–Schlenker [BBS11].

Let $\mathbb{S}^n = (\mathbb{R}^{n+1} \setminus \{0\}) / \mathbb{R}_{>0}$ be the projective sphere and $\mathbb{S}: \mathbb{R}^{n+1} \setminus \{0\} \rightarrow \mathbb{S}^n$ the canonical projection. With a little abuse of notation, we embed the projective spheres \mathbb{S}^{n-2} and \mathbb{S}^1 into \mathbb{S}^n , $n \geq 2$, as follows:

$$\mathbb{S}^{n-2} = \mathbb{S}(\{(x_1, \dots, x_{n-1}, 0, 0)\}) \subset \mathbb{S}^n \quad \text{and} \quad \mathbb{S}^1 = \mathbb{S}(\{(0, \dots, 0, x_n, x_{n+1})\}) \subset \mathbb{S}^n.$$

Given an open subset $U \subset \mathbb{S}^1$, we define

$$\mathbb{S}^{n-2} * U = \bigcup_{p \in \mathbb{S}^{n-2}} \bigcup_{q \in U} [p, -p]_q \subset \mathbb{S}^n,$$

where $[p, -p]_q \subset \mathbb{S}^n$ denotes the half circle containing q with endpoints p and its antipode $-p$. For example, $\mathbb{S}^{n-2} * \mathbb{S}^1 = \mathbb{S}^n$.

A *projective circle* is a closed connected $(\mathrm{SL}_2\mathbb{R}, \mathbb{S}^1)$ -manifold. Let C be a projective circle. We may think of C as

$$C = \left(\coprod_{\alpha} U_{\alpha} \right) / \sim$$

with a collection of open subsets $\{U_{\alpha}\}_{\alpha}$ of \mathbb{S}^1 and the relation $x \sim g_{\alpha\beta}(x)$ for all $x \in U_{\alpha\beta} \subset U_{\alpha}$ and $g_{\alpha\beta}(x) \in U_{\beta\alpha} \subset U_{\beta}$ given by transition functions $g_{\alpha\beta}: U_{\alpha\beta} \rightarrow U_{\beta\alpha}$ in $\mathrm{SL}_2\mathbb{R}$. By

extending $g_{\alpha\beta} \in \mathrm{SL}_2\mathbb{R}$ to $\hat{g}_{\alpha\beta} = \begin{pmatrix} \mathrm{Id} & 0 \\ 0 & g_{\alpha\beta} \end{pmatrix} \in \mathrm{SL}_{n+1}\mathbb{R}$ (thus fixing $\mathbb{S}^{n-2} \subset \mathbb{S}^n$ pointwise), we can define

$$\mathbb{S}^{n-2} * C = \left(\coprod_{\alpha} \mathbb{S}^{n-2} * U_{\alpha} \right) / \sim$$

with the relation $x \sim \hat{g}_{\alpha\beta}(x)$ for all $x \in \mathbb{S}^{n-2} * U_{\alpha\beta}$.

This space will be the local model for our cone-manifolds. By canonically embedding \mathbb{S}^{n-2} and C into $\mathbb{S}^{n-2} * C$, we have that the couple $(\mathbb{S}^{n-2} * C, \mathbb{S}^{n-2})$ is homeomorphic to $(\mathbb{S}^n, \mathbb{S}^{n-2})$. Moreover, the sphere $\mathbb{S}^{n-2} * C$ is stratified in two projective manifolds:

- the *singular locus* \mathbb{S}^{n-2} , and
- the *regular locus* $(\mathbb{S}^{n-2} * C) \setminus \mathbb{S}^{n-2}$.

The holonomy of a meridian¹⁰ of the singular locus in the regular locus is the holonomy of a generator of $\pi_1 C$.

We now add the extra requirement that $C = C_{\theta}$ is an *elliptic circle*, i.e. that the holonomy representation ρ of C sends a generator γ of $\pi_1 C$ to an elliptic element $\rho(\gamma) \in \mathrm{SL}_2\mathbb{R}$. Passing to the universal covering $\widetilde{\mathbb{S}^1}$ of \mathbb{S}^1 and the covering group $\widetilde{\mathrm{SL}_2\mathbb{R}}$ of $\mathrm{SL}_2\mathbb{R}$ which acts on $\widetilde{\mathbb{S}^1}$, we lift ρ to a representation $\tilde{\rho}: \pi_1 C \rightarrow \widetilde{\mathrm{SL}_2\mathbb{R}}$. To the element $\tilde{\rho}(\gamma) \in \widetilde{\mathrm{SL}_2\mathbb{R}}$ is naturally associated a unique real number $\theta > 0$ which characterises the elliptic circle C_{θ} . Note that $\rho(\gamma)$ is conjugate to $\begin{pmatrix} \cos\theta & -\sin\theta \\ \sin\theta & \cos\theta \end{pmatrix}$ (see [Gol18, Section 5.4]).

Definition 2.1. Let X be an n -manifold and $\Sigma \subset X$ a codimension-2 submanifold. A *projective cone-manifold structure* on X , singular along Σ with cone angles, is an atlas for X whose each chart has values into some $\mathbb{S}^{n-2} * C_{\theta}$ and sends the points of Σ to the singular locus \mathbb{S}^{n-2} , and whose transition functions restrict to isomorphisms of projective manifolds on each stratum.

The *regular locus* of the cone-manifold X is the complement $X \setminus \Sigma$, while Σ is the *singular locus*. Both are (non-singular) projective manifolds. To each connected component Σ_i of Σ is associated a cone angle $\theta_i > 0$.

Remark 2.2. A projective cone-manifold X with all cone angles $\theta = 2\pi$ is simply a projective manifold with a totally geodesic codimension-2 submanifold $\Sigma \subset X$. Here, by *totally geodesic*, we mean that the preimage of Σ under the universal covering of X is locally mapped to codimension-2 projective subspaces of $\mathbb{R}\mathbb{P}^n$. If moreover X is a convex projective (and so Finsler) manifold, then Σ is totally geodesic in the usual sense.

2.2. Mirror polytopes. We now introduce the main objects for our proof of Theorem A: mirror polytopes. Roughly speaking, a mirror polytope is a polytope in the projective sphere, together with a choice of a projective reflection along each of the supporting hyperplanes of the facets (satisfying some extra conditions). We refer to [CLM16, Vin71] for further details.

¹⁰Let N be a manifold and $S \subset N$ a connected submanifold of codimension 2. We call *meridian* of S an element $\gamma \in \pi_1(N \setminus S)$ that is represented by a curve which is freely homotopic in $N \setminus S$ to the boundary of a fibre of a tubular neighbourhood of S in N .

The natural projection of $\mathbb{R}^{n+1} \setminus \{0\}$ onto \mathbb{S}^n is denoted by \mathbb{S} , and for every subset U of \mathbb{R}^{n+1} , $\mathbb{S}(U)$ denotes $\mathbb{S}(U \setminus \{0\})$ for the simplicity of the notation. A subset P of \mathbb{S}^n is *convex* if there exists a convex cone¹¹ U of \mathbb{R}^{n+1} such that $P = \mathbb{S}(U)$, and moreover a convex subset P is *properly convex* if its closure \overline{P} does not contain a pair of antipodal points. A *projective n -polytope* is a properly convex subset P of \mathbb{S}^n such that P has a non-empty interior and

$$P = \bigcap_{i=1}^N \mathbb{S}(\{v \in \mathbb{R}^{n+1} \mid \alpha_i(v) \leq 0\})$$

where α_i , $i = 1, \dots, N$, are linear forms on \mathbb{R}^{n+1} . We always assume that the set of linear forms is *minimal*, i.e. none of the half-spaces $\mathbb{S}(\{v \in \mathbb{R}^{n+1} \mid \alpha_i(v) \leq 0\})$ contains the intersection of all the others. A *facet* (resp. *ridge*) of a polytope is a face of codimension 1 (resp. 2).

A *projective reflection* is an element of $\mathrm{SL}_{n+1}^{\pm} \mathbb{R}$ of order 2 which is the identity on a hyperplane. Each reflection σ can be written as:

$$\sigma = \mathrm{Id} - \alpha \otimes b$$

where α is a linear form on \mathbb{R}^{n+1} and b is a vector in \mathbb{R}^{n+1} such that $\alpha(b) = 2$. The projective hyperplane $\mathbb{S}(\ker(\alpha))$ is called the *support* of σ . A *projective rotation* is an element of $\mathrm{SL}_{n+1} \mathbb{R}$ which is the identity on a subspace H of codimension 2 and which is conjugate to a matrix $\begin{pmatrix} \cos \theta & -\sin \theta \\ \sin \theta & \cos \theta \end{pmatrix}$ on \mathbb{R}^{n+1}/H with $0 < \theta < 2\pi$. The real number θ is called the *angle* of rotation.

A *mirror polytope* is a pair of a projective polytope P of \mathbb{S}^n and a finite number of reflections $(\sigma_s = \mathrm{Id} - \alpha_s \otimes b_s)_{s \in S}$ with $\alpha_s(b_s) = 2$ such that:

- The index set S consists of all the facets of P .
- For each facet $s \in S$, the support of σ_s is the supporting hyperplane of s .
- For every pair of distinct facets s, t of P , $\alpha_s(b_t)$ and $\alpha_t(b_s)$ are either both negative or both zero.

Note that $\alpha_s(b_t)\alpha_t(b_s) = 4\cos^2\theta$ for some $\theta \in (0, \pi/2]$ if and only if the product $\sigma_s\sigma_t$ is a rotation of angle 2θ . The *dihedral angle* of a ridge $s \cap t$ of a mirror polytope is θ if $\sigma_s\sigma_t$ is a rotation of angle 2θ , and 0 otherwise. A *Coxeter polytope* is a mirror polytope whose dihedral angles are submultiples of π , i.e. each dihedral angle is π/m for some integer $m \geq 2$ or $m = \infty$.

Remark 2.3. The complement of the (closed) ridges of a mirror polytope P inherits a structure of projective orbifold, which extends to the faces f of P such that the stabiliser of f is a finite group.

For any number $N \in \mathbb{N}$, we set $[[N]] := \{1, \dots, N\}$. An $N \times N$ matrix $A = (A_{ij})_{i,j \in [[N]]}$ is said to be *Cartan* if (i) $A_{ii} = 2$ for all $i \in [[N]]$, (ii) $A_{ij} \leq 0$ and (iii) $A_{ij} = 0 \Leftrightarrow A_{ji} = 0$, for all $i \neq j$. A Cartan matrix A is *irreducible* if it is not the direct sum of smaller matrices (after any simultaneous permutation of rows and columns). Every Cartan matrix A is obviously the direct sum of irreducible matrices $A'_1 \oplus \dots \oplus A'_k$. Each irreducible matrix A'_i ,

¹¹By a *cone*, we mean a subset of \mathbb{R}^{n+1} which is invariant under multiplication by positive scalars.

$i = 1, \dots, k$, is called a *component* of A . If $x = (x_1, \dots, x_N)$ and $y = (y_1, \dots, y_N) \in \mathbb{R}^N$, we write $x > y$ if $x_i > y_i$ for all $i \in \llbracket N \rrbracket$, and $x \geq y$ if $x_i \geq y_i$ for all $i \in \llbracket N \rrbracket$.

Proposition 2.4 (Vinberg [Vin71, Theorem 3]). *If A is an irreducible Cartan matrix of size $N \times N$, then exactly one of the following holds:*

- ((P)) (i) *The matrix A is nonsingular, and (ii) for every $x \in \mathbb{R}^N$, if $Ax \geq 0$, then $x > 0$ or $x = 0$.*
- ((Z)) (i) *The rank of A is $N - 1$, (ii) there exists a vector $y \in \mathbb{R}^N$ such that $y > 0$ and $Ay = 0$, and (iii) for every $x \in \mathbb{R}^N$, if $Ax \geq 0$, then $Ax = 0$.*
- ((N)) (i) *There exists a vector $y \in \mathbb{R}^N$ such that $y > 0$ and $Ay < 0$, and (ii) for every $x \in \mathbb{R}^N$, if $Ax \geq 0$ and $x \geq 0$, then $x = 0$.*

We say that A is of *positive, zero or negative type* if ((P)), ((Z)) or ((N)) holds, respectively.

A Cartan matrix A is of *positive* (resp. *zero*) type if every component of A is of positive (resp. zero) type. The *Cartan matrix* of a mirror polytope P is the matrix $A_P = (\alpha_s(b_t))_{s,t \in S}$. Note that the Cartan matrix of P is well-defined up to conjugation by a positive diagonal matrix because the reflections σ_s of P determine the couples $(\alpha_s, b_s)_{s \in S}$ up to $\alpha_s \mapsto \lambda_s \alpha_s$ and $b_s \mapsto \lambda_s^{-1} b_s$ for $\lambda_s > 0$. Two Cartan matrices A and B are said to be *equivalent* to each other if $A = DBD^{-1}$ for some positive diagonal matrix D . We will make essential use of the following:

Theorem 2.5. [Vin71, Corollary 1] *Let A be a Cartan matrix of size $N \times N$. If A is irreducible, of negative type and of rank $n + 1$, then there exists a mirror polytope P of S^n with N facets (unique up to the action of $\mathrm{SL}_{n+1}^{\pm}(\mathbb{R})$) such that $A_P = A$.*

Remark 2.6. Theorem 2.5 is not explicitly stated in [Vin71, Corollary 1] for non-Coxeter polytopes, but it follows from Propositions 13 and 15 of [Vin71] that the consequent Corollary 1 of [Vin71] is valid not only for Coxeter polytopes, but also for mirror polytopes.

To understand the combinatorics¹² of a mirror polytope P with facets $(s)_{s \in S}$, we introduce the poset $\sigma(P) \subset 2^S$ partially ordered by inclusion, which is dual¹³ to the face poset of P :

$$\sigma(P) := \{T \subset S \mid T = \sigma(f) \text{ for some face } f \text{ of } P\},$$

where $\sigma(f) := \{s \in S \mid f \subset s\}$. For any subset $T \subset S$, we denote by A_T the restriction of the Cartan matrix A of P to $T \times T$.

Theorem 2.7. [Vin71, Theorems 4 and 7] *Let P be a mirror n -polytope with facets $(s)_{s \in S}$ and with irreducible Cartan matrix A of negative type. Let T be a subset of S . Then:*

- (1) *If A_T is of positive type and $\sharp T = k$, then $T \in \sigma(P)$ and its corresponding face $\cap_{s \in T} s$ is of dimension $n - k$.*
- (2) *If A_T is of zero type and of rank $n - 1$, then $T \in \sigma(P)$ and the face $\cap_{s \in T} s$ is of dimension 0, i.e. a vertex of P .*

¹²The *combinatorics* (or *face poset*) of a polytope is the poset of its faces partially ordered by inclusion.

¹³Two posets \mathcal{P}_1 and \mathcal{P}_2 are said to be *dual* to each other provided there exists an order-reversing isomorphism between \mathcal{P}_1 and \mathcal{P}_2 .

Remark 2.8. Theorem 2.7 is not explicitly stated in [Vin71, Theorems 4 and 7], but it is obtained by applying [Vin71, Theorem 4] as in the proof of [Vin71, Theorem 7].

Remark 2.9. Theorem 2.7(1) tells us that for any mirror polytope P with facets $(s)_{s \in S}$ and reflections $(\sigma_s = \text{Id} - \alpha_s \otimes b_s)_{s \in S}$, if $\alpha_s(b_t)\alpha_t(b_s) < 4$, then the intersection $s \cap t$ is a face of codimension 2, i.e. a ridge of P .

2.3. Coxeter groups. A *Coxeter matrix* $M = (M_{st})_{s,t \in S}$ on a finite set S is a symmetric matrix with the entries $M_{st} \in \{1, 2, \dots, m, \dots, \infty\}$ such that the diagonal entries $M_{ss} = 1$ and the others $M_{st} \neq 1$. To any Coxeter matrix $M = (M_{st})_{s,t \in S}$ is associated a *Coxeter group* $W_{S,M}$ given by a presentation $\langle S \mid (st)^{M_{st}} = 1 \text{ for } M_{st} \neq \infty \rangle$. We denote the Coxeter group $W_{S,M}$ also simply by W, W_S or W_M . The *rank* of W_S is the cardinality $\#S$ of S .

The *Coxeter diagram* of $W_{S,M}$ is a labelled graph \mathcal{G}_W such that (i) the set of nodes (i.e. vertices) of \mathcal{G}_W is the set S , (ii) two nodes $s, t \in S$ are connected by an edge \overline{st} of \mathcal{G}_W if and only if $M_{st} \in \{3, \dots, m, \dots, \infty\}$, and (iii) the edge \overline{st} is labelled by M_{st} if and only if $M_{st} > 3$. A Coxeter group W is *irreducible* if the Coxeter diagram \mathcal{G}_W is connected.

An irreducible Coxeter group W is *spherical* (resp. *affine*) if it is finite (resp. infinite and virtually abelian). For a Coxeter group W (not necessarily irreducible), each connected component of the Coxeter diagram \mathcal{G}_W corresponds to a Coxeter group, called a *component* of W . A Coxeter group W is *spherical* (resp. *affine*) if each component of W is spherical (resp. affine). We sometimes refer to Appendix A for the list of all the irreducible spherical and irreducible affine Coxeter diagrams.

For each $T \subset S$, the subgroup W' of W generated by T is called a *standard subgroup* of W . It is well-known that W' identifies with the Coxeter group W_{T,M_T} , where M_T is the restriction of M to $T \times T$. A subset $T \subset S$ is said to be “*something*” if the Coxeter group W_T is “*something*”. For example, the word “*something*” can be replaced by “*spherical*”, “*affine*” and so on. Two subsets $T, U \subset S$ are *orthogonal* if $M_{tu} = 2$ for every $t \in T$ and every $u \in U$. This relationship is denoted by $T \perp U$.

2.4. A theorem of Tits and Vinberg. Let P be a Coxeter polytope with the set of facets S and the set of reflections $(\sigma_s = \text{Id} - \alpha_s \otimes b_s)_{s \in S}$. The *Coxeter group* W_P of P is the Coxeter group $W_{S,M}$ associated to a Coxeter matrix $M = (M_{st})_{s,t \in S}$ satisfying that $\alpha_s(b_t)\alpha_t(b_s) \geq 4$ if $M_{st} = \infty$ and $\alpha_s(b_t)\alpha_t(b_s) = 4 \cos^2(\pi/M_{st})$ otherwise. For a proper face f of P (i.e. $f \neq \emptyset, P$), we write $S_f = \{s \in S \mid f \subset s\}$ and $W_f := W_{S_f}$.

Theorem 2.10 (Tits [Bou81, Chapter V] for Tits simplex, and Vinberg [Vin71]). *Let P be a Coxeter polytope of S^n with Coxeter group W_P and let Γ_P be the subgroup of $\text{SL}_{n+1}^{\pm} \mathbb{R}$ generated by the reflections $(\sigma_s)_{s \in S}$. Then:*

- (1) *The homomorphism $\sigma: W_P \rightarrow \Gamma_P \subset \text{SL}_{n+1}^{\pm} \mathbb{R}$ defined by $\sigma(s) = \sigma_s$ is an isomorphism.*
- (2) *The Γ_P -orbit of P is a convex subset \mathcal{C}_P of S^n , and $\gamma \text{Int}(P) \cap \text{Int}(P) = \emptyset$ for all non-trivial $\gamma \in \Gamma_P$, where $\text{Int}(P)$ denotes the interior of P .*
- (3) *The group Γ_P acts properly discontinuously on the interior Ω_P of \mathcal{C}_P .*
- (4) *An open proper face f of P lies in Ω_P if and only if the Coxeter group W_f is spherical.*

Theorem 2.10 tells us that Ω_P is a convex domain of \mathbb{S}^n and Ω_P/Γ_P is a convex projective Coxeter orbifold.

2.5. Operation on a simplex. We first introduce three uniform¹⁴ Euclidean 4-polytopes via truncation, rectification and bitruncation of the 4-simplex, and then we describe the ideal hyperbolic rectified 4-simplex.

Roughly speaking, by truncation, rectification and bitruncation of a regular polytope $P \subset \mathbb{R}^n$ we mean cutting uniformly P at every vertex with a hyperplane orthogonal to the line joining the vertex to the barycentre. This operation is nicely described in the classical book of Coxeter [Cox73, Section 8.1]. Combinatorially, by collapsing some ridges of the bitruncated P to vertices, one gets the rectified P . For example, a truncated (resp. rectified, resp. bitruncated) 3-simplex is a truncated tetrahedron (resp. an octahedron, resp. a truncated tetrahedron) in Figure 2.

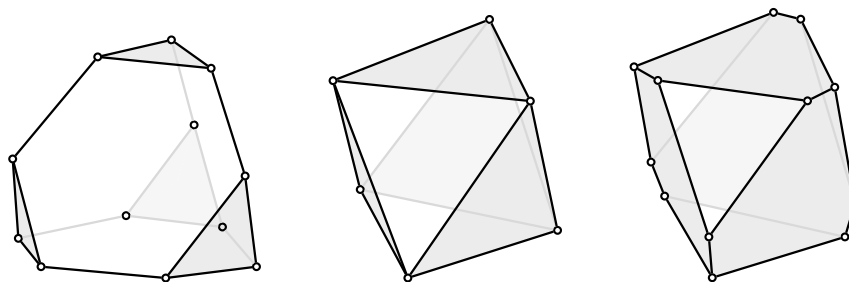

FIGURE 2. The truncated (left), rectified (middle), and bitruncated (right) 3-simplex.

We now explain in detail this operation for the 4-simplex. Consider a regular 4-simplex $\Delta \subset \mathbb{R}^4$ with barycentre the origin and vertices v_1, \dots, v_5 . We denote by F_i the facet of Δ opposite to v_i and by H_i the closed half-space containing the origin with $F_i \subset \partial H_i$. Then $\Delta = H_1 \cap \dots \cap H_5$.

Let $c := |v_i|$ and fix a positive parameter $s \leq c$. We denote by H'_i the closed half-space (depending on s) containing the origin such that $\partial H'_i$ is orthogonal to v_i and $sv_i \in \partial H'_i$, and we set

$$Q_s = H_1 \cap \dots \cap H_5 \cap H'_1 \cap \dots \cap H'_5.$$

Note that $Q_c = \Delta$ is the original simplex. There exist some numbers $0 < a < b < c$ such that the combinatorics of the 4-polytope Q_s is constant for s in (a, b) and (b, c) , and changes at $s = a, b$ and c . The polytope Q_s (depicted in Figure 3) is called:

- a *truncated 4-simplex* for $s \in (b, c)$,
- a *rectified 4-simplex* for $s = b$,
- a *bitruncated 4-simplex* for $s \in (a, b)$.

¹⁴A polytope P of dimension $n \geq 3$ (in the Euclidean space) is *uniform* if it is a vertex-transitive polytope with uniform facets. A *uniform polygon* is a regular polygon. By *vertex-transitive*, we mean that the symmetry group of P acts transitively on the set of vertices of P .

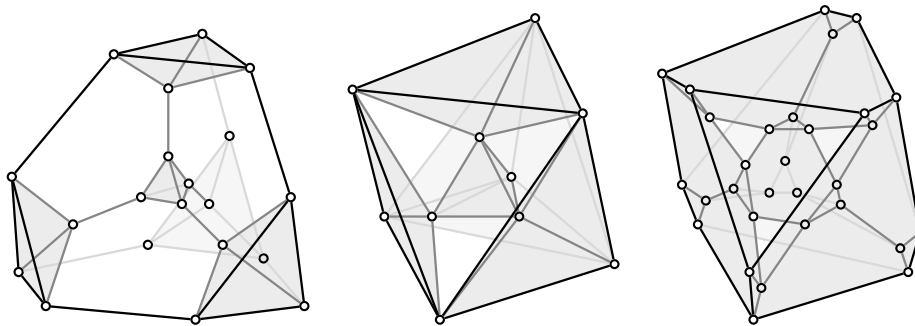

FIGURE 3. The Schlegel diagrams of the truncated (left), rectified (middle), and bitruncated (right) 4-simplex.

The rectified simplex Q_b is in fact the convex hull of the midpoints of the edges of the regular simplex $\Delta = Q_c$, while Q_a is another regular simplex. For all $s \in [a, c]$, the polytope Q_s is uniform.

2.6. The combinatorics of the rectified and bitruncated 4-simplices. We are particularly interested in the rectified and bitruncated 4-simplex, and thus fix $s \in (a, b]$ and describe the combinatorics of Q_s .

The link of a vertex of the rectified (resp. bitruncated) 4-simplex is a triangular prism (resp. a tetrahedron) as in Figure 4. Each vertex of Q_s is the intersection of facets $F'_{i_1} \cap F'_{i_2} \cap F_{i_3} \cap F_{i_4} \cap F_{i_5}$ for all distinct i_1, \dots, i_5 (resp. $F'_{i_1} \cap F'_{i_2} \cap F_{i_3} \cap F_{i_4}$ for all distinct i_1, \dots, i_4), where F_i and F'_i denote the facets of Q_s whose supporting hyperplanes are ∂H_i and $\partial H'_i$, respectively. The 10 facets of Q_s are divided into 5 octahedra (resp. truncated tetrahedra) $F_i \subset \partial H_i$, and 5 tetrahedra (resp. truncated tetrahedra) $F'_i \subset \partial H'_i$. For all $i \neq j$, the ridge $F_i \cap F_j$ is a triangle, $F'_i \cap F'_j$ is a vertex (resp. triangle), and $F_i \cap F'_j$ is a triangle (resp. hexagon), while $F_i \cap F'_i = \emptyset$.

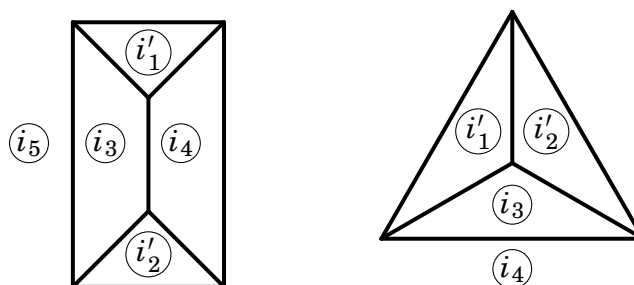

FIGURE 4. The vertex link of the rectified (left) and bitruncated (right) 4-simplex Q_s . A facet of the link labelled by i (resp i') corresponds to the facet F_i (resp. F'_i) of the 4-polytope Q_s .

The following is a simple observation, but it will be useful later to prove Theorem A (more precisely, Proposition 3.1).

Lemma 2.11. *Relabel each facet F'_i of Q_s with $F_{i'}$, and let $S := \{1', \dots, 5', 1, \dots, 5\}$.*

- (1) In the case that Q_s is the rectified 4-simplex, i.e. $s = b$, each vertex of Q_s corresponds to a subset $\{i', j', k, l, m\} \subset S$ with $\#\{i, j, k, l, m\} = 5$ and each edge of Q_s corresponds to a subset $\{i', j, k\} \subset S$ with $\#\{i, j, k\} = 3$.
- (2) In the case that Q_s is the bitruncated 4-simplex, i.e. $a < s < b$, each vertex of Q_s corresponds to a subset $\{i', j', k, l\} \subset S$ with $\#\{i, j, k, l\} = 4$.

2.7. The ideal hyperbolic rectified 4-simplex. Every vertex-transitive polytope $Q \subset \mathbb{R}^n$ can be realised as an ideal hyperbolic n -polytope, obtained by interpreting the ball in which Q is inscribed as a projective model of the hyperbolic n -space \mathbb{H}^n . What is nice about the rectified simplex of low dimension $n \leq 4$ (only)¹⁵ is that its regular ideal hyperbolic realisation $R \subset \mathbb{H}^n$ is a Coxeter polytope. For instance, the polytope R of dimension 3 is a right-angled hyperbolic octahedron.

Let $R \subset \mathbb{H}^4$ be the regular ideal rectified 4-simplex. The facets of R are regular ideal Coxeter 3-polytopes: five right-angled octahedra F_i and five $\pi/3$ -angled tetrahedra F'_i . The horospherical link of any (ideal) vertex of R is a Euclidean right triangular prism with equilateral bases (see the left of Figure 6). Thus, for all $i \neq j$ the dihedral angle at a ridge $F_i \cap F_j$ (resp. $F_i \perp F'_j$) is $\pi/3$ (resp. $\pi/2$), while F'_i and F'_j are parallel, i.e. the facet F'_i is tangent to F'_j at infinity.

Remark 2.12. The bitruncated 4-simplex is “combinatorially” a “filling” of the ideal rectified 4-simplex in the sense that the latter is obtained from the former by removing the triangular ridges $F'_i \cap F'_j$ for $i \neq j$. We call such triangles the *filling ridges* of the bitruncated 4-simplex.

3. THE PROOF OF THEOREM A

In this section, we prove Theorem A. In Section 3.1, we perform convex projective generalised Dehn filling to the ideal hyperbolic rectified 4-simplex $R \subset \mathbb{H}^4$, and build mirror polytopes P_α combinatorially equivalent¹⁶ to the bitruncated 4-simplex. In Section 3.2, we show that the Coxeter group $W_p = W_{P_{\pi/p}}$ of the Coxeter polytope $P_{\pi/p}$ is relatively hyperbolic. In Sections 3.3 and 3.4, we construct the cusped hyperbolic 4-manifold M , by gluing some copies of R , and a filling X of M , respectively. Finally, in Section 3.5, we give X a structure of projective cone-manifold induced by P_α , and finish the proof of Theorem A.

3.1. Deforming the rectified 4-simplex. In this subsection, we obtain a family of projective structures on the orbifold \mathcal{O}_R associated to the ideal hyperbolic rectified 4-simplex R by deforming its original complete hyperbolic structure.

Accordingly, the composition of two projective reflections along the facets F'_i and F'_j of \mathcal{O}_R , $i \neq j$, (recall the notation from Section 2.5) will deform to be conjugate to a projective

¹⁵The link of the regular ideal hyperbolic rectified n -simplex is a Euclidean right simplicial $(n-1)$ -prism with regular $(n-2)$ -simplicial bases, and the dihedral angle of the Euclidean regular $(n-2)$ -simplex is $\arccos(1/(n-2))$.

¹⁶Two polytopes Q and Q' are *combinatorially equivalent* to each other if the face poset of Q is isomorphic to the face poset of Q' .

rotation of angle $2\alpha > 0$. At the original hyperbolic structure on \mathcal{O}_R , the facets F'_i and F'_j are parallel, i.e. $\alpha = 0$. But, at the deformed projective structure on \mathcal{O}_R , new ridges $F'_i \cap F'_j$ can be added to \mathcal{O}_R to form a mirror polytope P_α that is combinatorially equivalent to a bitruncated 4-simplex, where α is the dihedral angle of the ridge $F'_i \cap F'_j$. So, the goal is to prove the following:

Proposition 3.1. *There exists a path $(0, \pi/3] \ni \alpha \mapsto P_\alpha$ of mirror polytopes with the combinatorics of a bitruncated 4-simplex and dihedral angles:*

- α at the filling ridges $F'_i \cap F'_j$,
- $\pi/2$ at the ridges $F_i \cap F'_j$, and
- $\pi/3$ at the ridges $F_i \cap F_j$.

Moreover, the limit P_0 is the ideal hyperbolic rectified 4-simplex R .

Before proving Proposition 3.1, we begin with some auxiliary lemmas. First, let

$$t_3 = \frac{1}{2} \left(11 + 9\sqrt{2} - 3\sqrt{31 + 22\sqrt{2}} \right) \approx 0.0422$$

and for $t \in [t_3, 1]$,

$$f(t) = \frac{t(t+2)^3(2t+1)^3}{(t^2+t+1)^2(t^2+7t+1)^2}, \quad h(t) = 2 + \frac{1}{t} + \frac{t(t+2)^4}{(t^2+t+1)(t^2+7t+1)},$$

$$g_p(t) = \frac{2t^p(t+2)^p(2t+1)^{3-p}}{(t^2+t+1)(t^2+7t+1)} \quad \text{and} \quad \bar{g}_p(t) = \frac{4f(t)}{g_p(t)}, \quad \text{where } p = 0, 1, 2, 3.$$

The number t_3 is the unique positive solution less than 1 satisfying the equation $f(t_3) = 1/4 = \cos^2(\pi/3)$. Since t_3 is positive, it is easy to check:

Lemma 3.2. *The functions f, h, g_p and $\bar{g}_p : [t_3, 1] \rightarrow \mathbb{R}$ are well-defined and positive.*

Given $t \in [t_3, 1]$, we now consider the matrix

$$C_t = \left(\begin{array}{ccccc|ccccc} 2 & -\bar{g}_0(t) & -\bar{g}_1(t) & -\bar{g}_2(t) & -\bar{g}_3(t) & -h(t) & 0 & 0 & 0 & 0 \\ -g_0(t) & 2 & -\bar{g}_0(t) & -\bar{g}_1(t) & -\bar{g}_2(t) & 0 & -h(t) & 0 & 0 & 0 \\ -g_1(t) & -g_0(t) & 2 & -\bar{g}_0(t) & -\bar{g}_1(t) & 0 & 0 & -h(t) & 0 & 0 \\ -g_2(t) & -g_1(t) & -g_0(t) & 2 & -\bar{g}_0(t) & 0 & 0 & 0 & -h(t) & 0 \\ -g_3(t) & -g_2(t) & -g_1(t) & -g_0(t) & 2 & 0 & 0 & 0 & 0 & -h(t) \\ \hline -2 & 0 & 0 & 0 & 0 & 2 & -1/t & -1/t & -1/t & -1/t \\ 0 & -2 & 0 & 0 & 0 & -t & 2 & -1/t & -1/t & -1/t \\ 0 & 0 & -2 & 0 & 0 & -t & -t & 2 & -1/t & -1/t \\ 0 & 0 & 0 & -2 & 0 & -t & -t & -t & 2 & -1/t \\ 0 & 0 & 0 & 0 & -2 & -t & -t & -t & -t & 2 \end{array} \right).$$

Lemma 3.3. *For every $t \in [t_3, 1]$, the matrix C_t is an irreducible Cartan matrix of negative type and of rank 5.*

Proof. It easily follows from Lemma 3.2 that C_t is an irreducible Cartan matrix. Let us call and order the indices of C_t as $S := \{1', \dots, 5', 1, \dots, 5\}$. A simple computation reveals

that the characteristic polynomial $\det(x\text{Id}-C_t)$ of C_t is divided by x^5 , and the determinant of the restriction $(C_t)_T$ of C_t to $T \times T$ with $T = \{1, 2, 3, 4, 5\} \subset S$ is

$$-(t^3 + 10t^2 + 41t + 41/t + 10/t^2 + 1/t^3 + 58) < 0.$$

As a result, the rank of C_t is exactly 5, which is less than $9 = 10 - 1$, hence the irreducible Cartan matrix C_t is of negative type by Proposition 2.4. \square

Lemma 3.4. *There exists a monotonically decreasing analytic function $\alpha : [t_3, 1] \rightarrow \mathbb{R}$ satisfying*

$$\cos^2 \alpha(t) = f(t), \quad \alpha(t_3) = \frac{\pi}{3}, \quad \alpha(1) = 0.$$

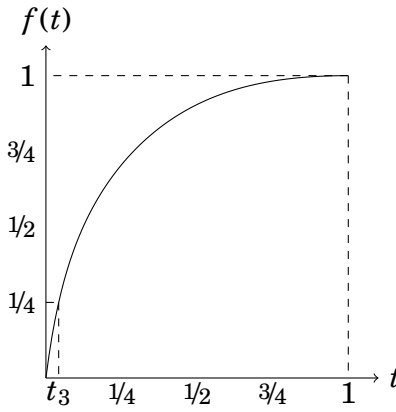

FIGURE 5. The graph of $f(t)$ over the interval $[0, 1]$

Proof. Since the derivative f' of f :

$$f'(t) = -\frac{2(t-1)(t+1)(t+2)^2(2t+1)^2(t^4+2t^3+21t^2+2t+1)}{(t^2+t+1)^3(t^2+7t+1)^3}$$

is positive for all $t \in [t_3, 1)$ and is zero for $t = 1$, the function $f : [t_3, 1] \rightarrow \mathbb{R}$ is monotonically increasing with $f(t_3) = 1/4$ and $f(1) = 1$ (see Figure 5). The lemma now follows easily. \square

We are finally ready to prove Proposition 3.1 by applying Theorems 2.5 and 2.7. For the reader's convenience, we recall here part of the combinatorics of the truncated, rectified and bitruncated 4-simplex (see Table 1), which is described in Sections 2.5, 2.6 and 2.7. The symbols i, j are two distinct indices in $\{1, \dots, 5\}$. Table 1 contains also information on the dihedral angles of the mirror polytope P_α , $\alpha \in [0, \pi/3]$, that we will discover. See also Figure 6 for a geometric picture of the vertex link of the mirror polytope P_α .

Proof of Proposition 3.1. We again call the indices of C_t as $S := \{1', \dots, 5', 1, \dots, 5\}$. Lemmas 3.3 and 3.4 together with Theorem 2.5 imply that there exists a path $[0, \pi/3] \ni \alpha \mapsto P_\alpha$ of mirror polytopes with facets $(s)_{s \in S}$ and with Cartan matrix C_t .

We consider two cases separately: (i) $\alpha \in (0, \pi/3]$ and (ii) $\alpha = 0$.

	truncated 4-simplex	rectified 4-simplex	bitruncated 4-simplex
F_i	truncated tetrahedron	octahedron	truncated tetrahedron
F'_j	tetrahedron	tetrahedron	truncated tetrahedron
$F_i \cap F_j$	hexagon	triangle, angle $\frac{\pi}{3}$	triangle, angle $\frac{\pi}{3}$
$F_i \cap F'_i$	\emptyset	\emptyset	\emptyset
$F_i \cap F'_j$	triangle	triangle, angle $\frac{\pi}{2}$	hexagon, angle $\frac{\pi}{2}$
$F'_i \cap F'_j$	\emptyset	vertex, angle 0	triangle, angle $\alpha \in (0, \frac{\pi}{3}]$

TABLE 1. Combinatorics of the truncated, rectified and bitruncated 4-simplex, plus the additional information on the dihedral angles of the mirror polytope P_α .

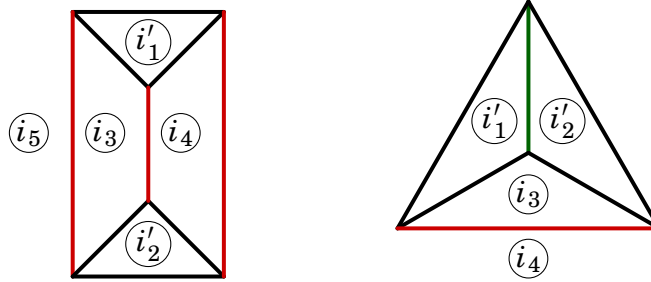

FIGURE 6. The vertex links of a mirror polytope P_α are also mirror polytopes: (i) a right triangular prism with equilateral bases for the (ideal) rectified 4-simplex P_0 (left), and (ii) a tetrahedron for the bitruncated 4-simplex P_α , $\alpha \in (0, \frac{\pi}{3}]$ (right). The edges of dihedral angle $\pi/2$ (resp. $\pi/3$, resp. α) are drawn in black (resp. red, resp. green).

In the case (i), equivalently, $t \in [t_3, 1)$, by Remark 2.9 (or Theorem 2.7(1)), the intersections $F'_i \cap F'_j$, $F_i \cap F'_j$ and $F_i \cap F_j$, $F_i \neq F_j$, are ridges of P_α and their dihedral angles are α , $\pi/2$ and $\pi/3$, respectively, because for example

$$(C_t)_{i'j'}(C_t)_{j'i'} = g_p(t)\bar{g}_p(t) = 4f(t) = 4\cos^2 \alpha < 4.$$

We now claim that P_α is combinatorially equivalent to the bitruncated 4-simplex. For every subset $T = \{i', j', k, l\} \subset S$ with $\#\{i, j, k, l\} = 4$, the submatrix $(C_t)_T$ is the direct sum $(C_t)_{\{i', j'\}} \oplus (C_t)_{\{k, l\}}$ of matrices of positive type, hence $T \in \sigma(P_\alpha)$ ¹⁷ and $\bigcap_{S \in T} S$ is a vertex of P_α by Theorem 2.7(1). That is, if \mathcal{V} denotes the set of all subsets $\{i', j', k, l\} \subset S$ with $\#\{i, j, k, l\} = 4$, then $\mathcal{V} \subset \sigma(P_\alpha)$. Let \mathcal{F} be the subposet of 2^S defined by:

$$\mathcal{F} := \{T' \subset 2^S \mid T' \subset T \text{ for some } T \in \mathcal{V}\}.$$

As in the previous argument, Theorem 2.7(1) implies that \mathcal{F} is a subposet of $\sigma(P_\alpha)$. We know, in addition, from Lemma 2.11(2) and Figure 4 that the poset \mathcal{F} is dual to the face poset of the bitruncated 4-simplex. It is a well-known fact (e.g. [BP15, Exercise 1.1.20]) that if two polytopes Q and Q' are of same dimension and the face poset of Q' is a subposet of the face poset of Q , then Q is combinatorial equivalent to Q' . As a result, the polytope P_α is combinatorially equivalent to the bitruncated 4-simplex, as claimed.

¹⁷See Section 2.2 for the definition of $\sigma(P)$.

In the case (ii), equivalently, $t = 1$, we claim that P_0 is combinatorially equivalent to the rectified 4-simplex. For every subset $U = \{i', j', k, l, m\} \subset S$ with $\#\{i, j, k, l, m\} = 5$, the submatrix $(C_1)_U$ is the direct sum $(C_1)_{\{i', j'\}} \oplus (C_1)_{\{k, l, m\}}$ of matrices of zero type and the rank of $(C_1)_U$ is 3, hence $U \in \sigma(P_0)$ and $\cap_{s \in U} s$ is a vertex of P_0 by Theorem 2.7(2). Furthermore, for every subset $U' = \{i', j, k\} \subset S$ with $\#\{i, j, k\} = 3$, the submatrix $(C_1)_{U'}$ is of positive type, hence $U' \in \sigma(P_0)$ and $\cap_{s \in U'} s$ is an edge of P_0 by Theorem 2.7(1). Then, as in the proof of case (i), using Lemma 2.11(1) and Figure 4, we may conclude that the polytope P_0 is combinatorially equivalent to the rectified 4-simplex, as claimed. Finally, a simple computation shows that the Cartan matrix C_1 is equivalent to a symmetric matrix of signature (4, 1), and therefore the polytope P_0 (without vertices) may be identified with the ideal hyperbolic rectified 4-simplex R . \square

Remark 3.5. The symmetry group of the mirror polytope P_α , $\alpha \in [0, \pi/3]$, is of order ≥ 5 . For, if we set $\hat{Q} = \begin{pmatrix} Q & 0 \\ 0 & Q \end{pmatrix}$ with

$$Q = \begin{pmatrix} 0 & 0 & 0 & 0 & 1 \\ 1 & 0 & 0 & 0 & 0 \\ 0 & 1 & 0 & 0 & 0 \\ 0 & 0 & 1 & 0 & 0 \\ 0 & 0 & 0 & 1 & 0 \end{pmatrix},$$

then \hat{Q} is a permutation matrix of order 5 and $\hat{Q}C_t\hat{Q}^{-1}$ is equivalent to C_t .

Remark 3.6. A (bit more complicated) computation reveals that the deformation space of projective structures on the orbifold \mathcal{O}_R associated to the ideal hyperbolic rectified 4-simplex R is six-dimensional. In other words, one can find a six-parameter family of Cartan matrices (of rank 5) which correspond to projective structures on \mathcal{O}_R . But, we choose a particular one-parameter family of Cartan matrices having symmetry as described in Remark 3.5 in order to simplify the computation.

We end the subsection with the following.

Corollary 3.7. *For every integer $p \geq 3$, the mirror polytope $P_{\pi/p}$ with reflections $(\sigma_s)_{s \in S}$ is a Coxeter polytope. Moreover, if Γ_p denotes the subgroup of $\mathrm{SL}_5^\pm \mathbb{R}$ generated by $(\sigma_s)_{s \in S}$, then the Γ_p -orbit of $P_{\pi/p}$ is a convex domain Ω_p of \mathbb{S}^4 , i.e. it is divisible by Γ_p .*

Proof. It is obvious that the mirror polytope $P_{\pi/p}$ is a Coxeter polytope. Let σ_i (resp. σ'_i) be the projective reflection along the facet F_i (resp. F'_i) of $P_{\pi/p}$. For any subset $T = \{i', j', k, l\} \subset S$ with $\#\{i, j, k, l\} = 4$, the standard subgroup W_T of the Coxeter group W_S of $P_{\pi/p}$ is isomorphic to $D_p \times D_3$, where D_m is the dihedral group of order $2m$, hence it is a finite group. In the proof of Proposition 3.1, we show that every vertex of $P_{\pi/p}$ corresponds to a subset $\{i', j', k, l\} \subset S$ with $\#\{i, j, k, l\} = 4$, so by Theorem 2.10, the Γ_p -orbit of $P_{\pi/p}$ is a divisible convex domain of \mathbb{S}^4 . \square

3.2. The Coxeter group W_p . The goal of this subsection is to show that the Coxeter group W_p of $P_{\pi/p}$ is relatively hyperbolic with respect to a collection of virtually abelian subgroups of rank 2. To do so, we need to analyse the Coxeter diagram of W_p in Figure 7,

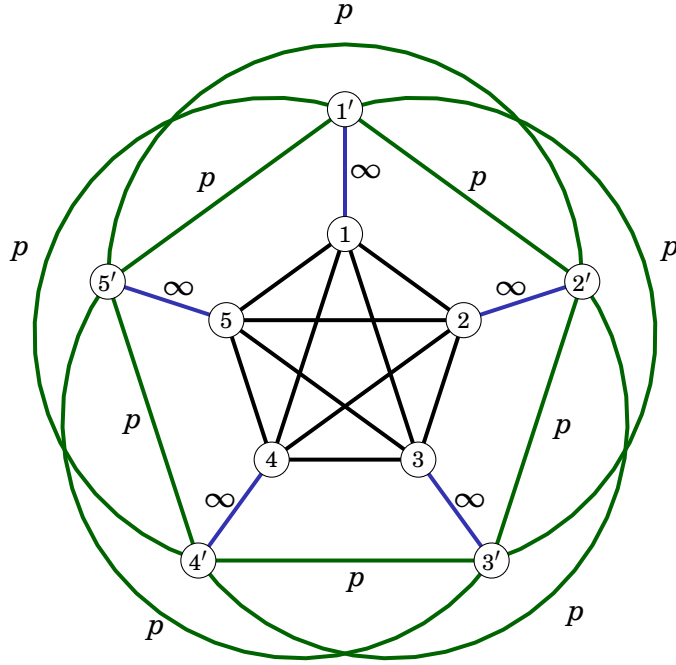

FIGURE 7. The Coxeter diagram of the Coxeter group W_p of $P_{\pi/p}$

and to use Theorem 3.8 together with the (complete) list of the irreducible spherical and affine Coxeter groups in Appendix A.

Theorem 3.8 (Moussong [Mou88] and Caprace [Cap09, Cap15]). *Let W_S be a Coxeter group, and let \mathcal{T} be a collection of subsets of S . Then the group W_S is relatively hyperbolic with respect to $\{W_T \mid T \in \mathcal{T}\}$ if and only if the following hold:*

- (1) *For every irreducible affine subset $U \subset S$ of rank ≥ 3 , there exists $T \in \mathcal{T}$ such that $U \subset T$.*
- (2) *For every pair of irreducible non-spherical subsets S_1, S_2 of S with $S_1 \perp S_2$, there exists $T \in \mathcal{T}$ such that $S_1 \cup S_2 \subset T$.*
- (3) *For every pair $T, T' \in \mathcal{T}$ with $T \neq T'$, the intersection $T \cap T'$ is spherical.*
- (4) *For every $T \in \mathcal{T}$ and every irreducible non-spherical subset $U \subset T$, we have $U^\perp \subset T$, where $U^\perp := \{s \in S \mid s \perp U\}$.*

We denote by \mathcal{T}_p the following collection of subsets of $S = \{1', \dots, 5', 1, \dots, 5\}$:

- In the case of $p \geq 4$, the collection \mathcal{T}_p consists of all subsets $\{i', j', k, l, m\}$ of S with $\#\{i, j, k, l, m\} = 5$, so the cardinality of \mathcal{T}_p , $p \geq 4$, is 10.
- In the case of $p = 3$, the collection \mathcal{T}_3 consists of all subsets $\{i', j', k, l, m\}$ and $\{i', j', k', l, m\}$ of S with $\#\{i, j, k, l, m\} = 5$, so the cardinality of \mathcal{T}_3 is 20.

For each $U \in \mathcal{T}_p$, the standard subgroup $(W_p)_U$ of W_p is isomorphic to $\tilde{A}_2 \times I_2(p)$ (see Appendix A), hence it is virtually isomorphic to \mathbb{Z}^2 .

Proposition 3.9. *The Coxeter group W_p is relatively hyperbolic with respect to \mathcal{T}_p , in particular, a collection of virtually abelian subgroups of rank 2.*

Proof. We only prove it for the case $p = 3$; the argument is similar for other cases $p \geq 4$. Thanks to Theorem 3.8, we just need to carefully analyse the Coxeter diagram of W_p in Figure 7, using the list of irreducible spherical and affine Coxeter groups in Appendix A.

First, the condition (1) holds because all irreducible affine subsets $U \subset S$ of rank ≥ 3 are $\{i', j', k'\}$ and $\{i, j, k\}$ with $\#\{i, j, k\} = 3$. Second, the condition (2) holds because there does not exist a pair of irreducible non-spherical subsets S_1, S_2 of S with $S_1 \perp S_2$. Third, the condition (3) holds because for every pair $T, T' \in \mathcal{T}_3$ with $T \neq T'$, the intersection $T \cap T'$ is a subset of $\{i', j', k, l\}$ with $\#\{i, j, k, l\} = 4$. Finally, the condition (4) holds because for every $T \in \mathcal{T}_3$, there exists only one irreducible non-spherical subset $U \subset T$, which is either $\{i', j', k'\}$ or $\{i, j, k\}$ with $\#\{i, j, k\} = 3$, and $T = U \cup U^\perp$. \square

Remark 3.10. The Coxeter group W_p of $P_{\pi/p}$ is in fact a finite-index subgroup of the following Coxeter group \hat{W}_p :



It is easier to verify the conditions (1) – (4) of Theorem 3.8 for the Coxeter group \hat{W}_p .

3.3. The cusped hyperbolic manifold. In this subsection, we build the cusped hyperbolic manifold M of Theorem A. A reader who is not familiar with hyperbolic manifolds (with totally geodesic boundary) could consult [Mar16, Chapter 3].

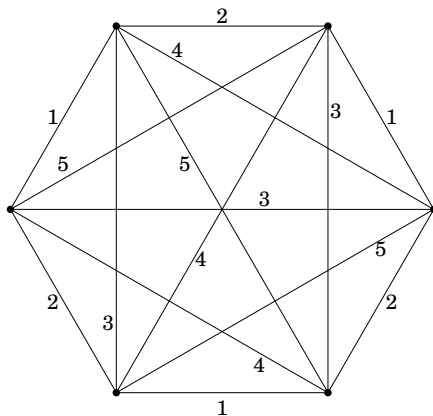

FIGURE 8. The edge-labelled complete graph K_6

We first recall the construction of a building block B by Kolpakov and Slavich [KS16]. Consider the complete graph K_6 on 6 vertices with its edges labelled by numbers in $\{1, \dots, 5\}$ so that adjacent edges have distinct labels (see Figure 8). For each vertex of K_6 , take a copy of the ideal hyperbolic rectified 4-simplex $R \subset \mathbb{H}^4$, described in Section 2.7. If two vertices of K_6 are connected by an edge of label $i \in \{1, \dots, 5\}$, then we glue together the facets F_i of the two corresponding copies of R using the identity as a gluing map.

Proposition 3.11 ([KS16, Section 3]). *Let B be the building block constructed above.*

- *The space B is a non-orientable, complete, finite-volume hyperbolic 4-manifold with non-compact totally geodesic boundary.*
- *The boundary ∂B of B has exactly 5 connected components $\partial_1, \dots, \partial_5$, each tessellated by the facets F'_i of the copies of R in B .*
- *The hyperbolic manifold B has exactly 10 cusps C_{ij} , $i < j \in \{1, \dots, 5\}$. Each cusp section S_{ij} is diffeomorphic to $K \times [0, 1]$, where K denotes the Klein bottle. One boundary component of S_{ij} is contained in ∂_i , and the other in ∂_j .*

Now, consider again the edge-labelled graph K_6 in Figure 8. For each vertex of K_6 , take a copy of B . If two vertices of K_6 are joined by an edge of label $i \in \{1, \dots, 5\}$, then we glue together the boundary components ∂_i of the two corresponding copies of B using the identity as a gluing map. Let us call M' the resulting cusped hyperbolic manifold (without boundary), and M its orientable double cover.

Proposition 3.12. *The orientable hyperbolic 4-manifold M has exactly 10 cusps, each with section diffeomorphic to the 3-torus.*

Proof. We obtain the cusps of M' by gluing together the cusps of the copies of B , and the gluing maps are induced by the identity. Hence, each cusp section of M' must be diffeomorphic to $K \times \mathbb{S}^1$. By construction, for each pair $i < j \in \{1, \dots, 5\}$, the simple cycle (of length 6) in the graph K_6 with edges labelled alternately by i and j corresponds to a cusp of M' , thus M' has exactly 10 cusps. Since the cusps of M' are non-orientable, each cusp section of M is the orientable double covering of a cusp section of M' . In particular, M has precisely 10 cusps, each with 3-torus section. \square

Remark 3.13. The natural map $M \rightarrow \mathcal{O}_R$ is an orbifold covering of degree $6 \cdot 6 \cdot 2 = 72$, where \mathcal{O}_R denotes the orbifold associated to R .

3.4. Topology of the filling. In this subsection, we build the manifold X of Theorem A topologically. The desired (singular) geometric structures on X will be given in the next subsection.

Let $Q \subset \mathbb{R}^4$ be a bitruncated 4-simplex. We define X in the same way as the manifold M (see Section 3.3), but substituting the ideal rectified simplex R with the bitruncated simplex Q .

Proposition 3.14. *The space X is a closed, orientable, smooth 4-manifold, containing 10 pairwise disjoint embedded 2-tori whose complement is diffeomorphic to the cusped hyperbolic manifold M .*

Proof. To prove that the polyhedral complex X is a smooth manifold, it suffices to show that the link of each vertex is homeomorphic to the 3-sphere. Recall that the polytope Q is vertex transitive. The vertex link L of Q is the tetrahedron in the right of Figure 4.

When we glue the first 6 copies of Q to form B , for each vertex of Q , 6 copies of L are glued cyclically around one edge, to form a polyhedral complex L' homeomorphic to the closed 3-disc D^3 . Thus, B is a 4-manifold with boundary. Note that R is homeomorphic

to the complement $Q \setminus \bigcup_{i < j} F'_i \cap F'_j$ of the filling ridges; in particular, B is non-orientable (recall Proposition 3.11). When we glue 6 copies of B to get X' , for each vertex of the complex, 6 copies of L' are glued cyclically around a circle $C \subset \partial L'$. The resulting polyhedral complex is clearly homeomorphic to the 3-sphere, so X' is a manifold. Its orientation cover X is thus a manifold.

Now, the cusped hyperbolic manifold M is diffeomorphic to the interior of a compact manifold \overline{M} with boundary $\partial \overline{M}$ consisting of 10 3-tori (recall Proposition 3.12). Let $\Sigma \subset X$ be the union of the copies of the filling ridges of P . Clearly, M is diffeomorphic to $X \setminus \Sigma$. Moreover, $\partial \overline{M}$ is diffeomorphic to the boundary of a regular neighbourhood of Σ in X . Thus, Σ consists of 10 2-tori. \square

We conclude the subsection with some additional information about X .

Remark 3.15. The 4-manifold X has Euler characteristic $\chi(X) = 12$. Indeed, \mathcal{O}_R has orbifold Euler characteristic $\chi^{\text{orb}}(\mathcal{O}_R) = \frac{1}{6}$ [KS16, Appendix 1], and the covering $M \rightarrow \mathcal{O}_R$ has degree 72 (recall Remark 3.13), so $\chi(M) = 12$. Since $\chi(\partial \overline{M}) = 0$ and $\chi(\Sigma) = 0$, we have $\chi(X) = \chi(M) = 12$.

Remark 3.16. The 4-manifold X is a “6-filling” of M , meaning that M has a maximal (disconnected) cusp section S such that each filling curve in S has length 6. The reason is that the maximal, and maximally symmetric, (disconnected) horo-section $S_R \subset \mathbb{H}^4$ of the ideal hyperbolic rectified 4-simplex R is such that the 10 Euclidean prisms $S_R \cap R$ have all edges of length 1 [KS16, Section 3.2]. Each of the filling curves of X is made of 6 copies of the height of such prism. Since $6 < 2\pi$, one cannot apply directly the Gromov-Thurston 2π Theorem to conclude, for instance, that X is aspherical. We will see later that, being convex projective, X is in fact aspherical.

3.5. Cone-manifold structures on the filling. We now conclude the proof of Theorem A. Let $\Sigma \subset X$ be the union of the copies of the filling ridges $F'_i \cap F'_j$. We first show item (5), giving a path of structures of projective cone-manifold on X with the desired properties.

In Proposition 3.1, we built a path of structures $(0, \frac{\pi}{3}] \ni \alpha \mapsto P_\alpha$ of mirror polytope on the bitruncated simplex Q . Since the manifold X is built by pairing the facets of some copies of Q through the map induced by the identity, for each α we have a well defined projective structure on the complement in X of the ridges of the copies of Q . Indeed, the projective structures of the copies of $P_\alpha \setminus \bigcup(\text{ridges})$ match well via the projective reflections associated to the facets of P_α . We want to show that this projective structure extends to a projective structure on $X \setminus \Sigma$, and on the whole X as projective cone-manifold structures with cone angle $\theta = 6 \cdot \alpha$ along Σ .

The link L of a vertex of P_α is a mirror tetrahedron. Its non-right dihedral angles are α and $\frac{\pi}{3}$ along its two opposite edges $\{i'_1, i'_2\}$ and $\{i_3, i_4\}$, respectively (see Figure 6–right). Recall now Section 2.1 about projective cone-manifolds. Some copies of L are glued together in X to form a 3-sphere, which we now show to be the projective cone 3-manifold $\mathbb{S}^1 * C_\theta$, where $\theta = 6 \cdot \alpha$.

Recall that the manifold X is built in three steps. At the first step (when gluing 6 copies of Q to build the block B), 6 copies of L are glued cyclically along its edge $\{i_3, i_4\}$. The resulting space L' is the intersection of two half-spaces of \mathbb{S}^3 with “dihedral angle”¹⁸ α . At the second step (when gluing 6 copies of B to build X'), 6 copies of L' are glued cyclically along its edge. Indeed, the cycle in the graph K_6 with edges labelled alternately by i_1 and i_2 has length 6. The resulting space is thus $\mathbb{S}^1 * C_\theta$. The third step is just the orientation double covering $X \rightarrow X'$, so the local structure of X is the same of that of X' .

The union of the copies of the filling ridge $F'_{i_1} \cap F'_{i_2}$ of Q in X is a component T of Σ (a 2-torus). The holonomy of a meridian of T in X is $(r'_{i_1} r'_{i_2})^3$, where r'_i is the projective reflection (depending on α) associated to the facet F'_i of the mirror polytope P_α .

We have shown that (X, Σ) is locally modeled on $(\mathbb{S}^2 * C_\theta, \mathbb{S}^2)$, so we have a projective cone structure σ_θ for each $\theta \in (0, 2\pi]$. Since $\mathbb{S}^2 * C_{2\pi} = \mathbb{S}^4$, the projective structure $\sigma_{2\pi}$ is non-singular, and each component of Σ is totally geodesic in X (see Remark 2.2). The associated path of projective cone-manifold structures $\theta \mapsto \sigma_\theta$ on X is analytic because the path of Cartan matrices $t \mapsto C_t$ is analytic.

We have shown item (5) of Theorem A. Clearly, item (1) follows from Propositions 3.1 and 3.12. Item (2) is shown in Remark 3.15, and item (3) in Remark 3.16.

Let us now fix an integer $p \geq 3$. By Corollary 3.7, the mirror polytope $P_{\pi/p}$ is a convex projective orbifold. If moreover $p = 3m$ (i.e. $\theta = 2\pi/m$), the natural map $X \rightarrow P_{\pi/p}$ gives to X a structure of convex projective orbifold Ω_m/Γ_m with cone structure $\sigma_{2\pi/m}$. We have thus shown the first part of item (6).

The convex projective manifold X is indecomposable. Indeed, X covers the Coxeter polytope $P_{\pi/3}$, and the Coxeter group W_3 acts strongly irreducibly on \mathbb{R}^5 because the Cartan matrix of $P_{\pi/3}$ is indecomposable (see for example [Mar17, Thm 2.18]), so does $\Gamma_1 \cong \pi_1(X)$.

Let T_1, \dots, T_{10} be the components of Σ . Being totally geodesic for each T_i , the natural map $\pi_1 T_i \rightarrow \Gamma_m$ induced by the inclusion $T_i \subset X$ is injective. For $m \geq 2$, the group Γ_m is relatively hyperbolic with respect to $\{\pi_1 T_i\}_i$. Indeed, by Proposition 3.9 the Coxeter group W_{3m} , which is the orbifold fundamental group of $P_{\pi/3m}$, is relatively hyperbolic with respect to the collection \mathcal{T}_{3m} which corresponds to the fundamental groups of the T_1, \dots, T_{10} . The proof of item (6) is complete.

It remains to show item (4). For $m = 1$ (i.e. $\alpha = \pi/3$ and $\theta = 2\pi$) there is another collection of totally geodesic tori T'_1, \dots, T'_{10} tiled by the ridges $F_i \cap F_j$. Being totally geodesic, also T'_i is π_1 -injective. This time, the group $\Gamma_1 \cong \pi_1 X$ is relatively hyperbolic with respect to $\{\pi_1 T_i, \pi_1 T'_i\}_i$. Indeed, by Proposition 3.9 the Coxeter group W_3 , which is the orbifold fundamental group of $P_{\pi/3}$, is relatively hyperbolic with respect to the collection \mathcal{T}_3 which corresponds to the fundamental groups of the T_1, \dots, T_{10} and T'_1, \dots, T'_{10} . Finally, for every $T \in \{T_1, \dots, T_{10}\}$ and $T' \in \{T'_1, \dots, T'_{10}\}$, the tori T and T' intersect transversely (sometimes

¹⁸Since to each hyperplane is associated a reflection, it makes sense to talk about the dihedral angle, even if L' is not properly convex.

$T \cap T' = \emptyset$ in X , since the ridges $F'_i \cap F'_j$ and $F_k \cap F_\ell$ do so in \mathbb{S}^4 . Also, in the universal cover Ω , the flats corresponding to T and T' intersect transversely.

The proof of Theorem A is complete.

APPENDIX A. THE SPHERICAL AND AFFINE COXETER DIAGRAMS

For the reader's convenience, we reproduce below the list of the irreducible spherical and irreducible affine Coxeter diagrams.

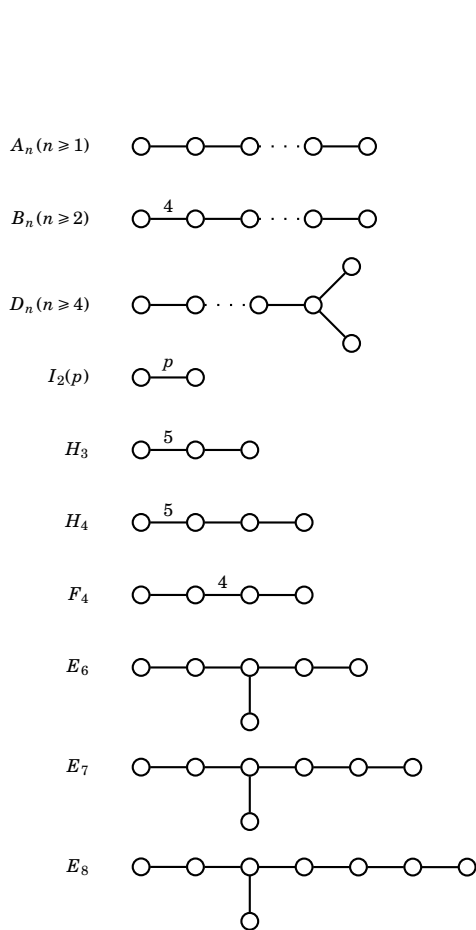

TABLE 2. The irreducible spherical Coxeter diagrams

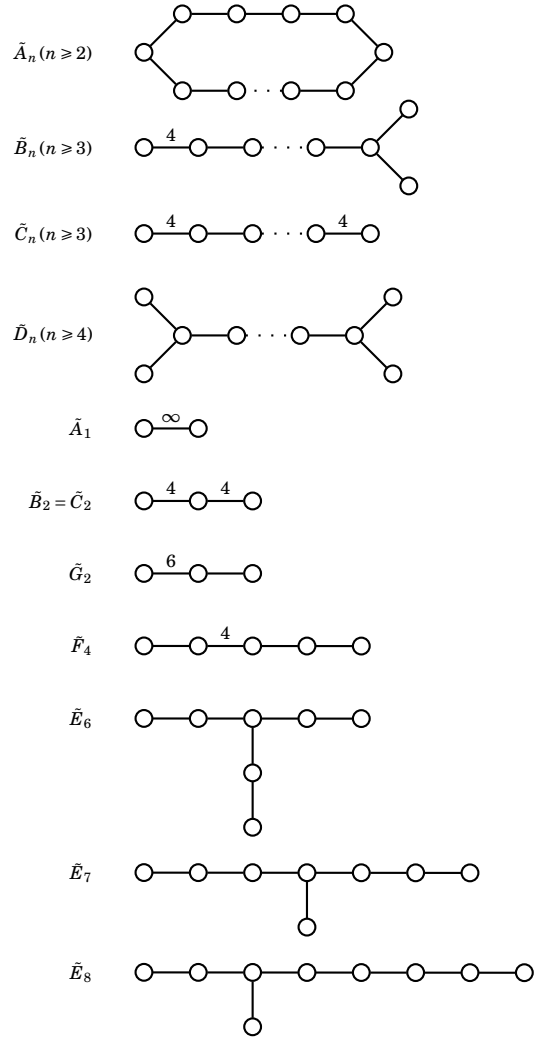

TABLE 3. The irreducible affine Coxeter diagrams

REFERENCES

- [And06] Michael Anderson. Dehn filling and Einstein metrics in higher dimensions. *J. Differential Geom.*, 73(2):219–261, 2006. [3](#), [5](#)
- [Bam12] Richard Bamler. Construction of Einstein metrics by generalized Dehn filling. *J. Eur. Math. Soc. (JEMS)*, 14(3):887–909, 2012. [5](#)
- [BBS11] Thierry Barbot, Francesco Bonsante, and Jean-Marc Schlenker. Collisions of particles in locally AdS spacetimes I. Local description and global examples. *Comm. Math. Phys.*, 308(1):147–200, 2011. [7](#)
- [BDL18] Samuel A. Ballas, Jeffrey Danciger, and Gye-Seon Lee. Convex projective structures on nonhyperbolic three-manifolds. *Geom. Topol.*, 22(3):1593–1646, 2018. [4](#)
- [Ben03] Yves Benoist. Convexes divisibles. II. *Duke Math. J.*, 120(1):97–120, 2003.
- [Ben04] Yves Benoist. Convexes divisibles. I. In *Algebraic groups and arithmetic*, page 339–374. Tata Inst. Fund. Res., Mumbai, 2004. [1](#), [4](#)
- [Ben06a] Yves Benoist. Convexes divisibles. IV. Structure du bord en dimension 3. *Invent. Math.*, 164(2):249–278, 2006. [3](#), [4](#)
- [Ben06b] Yves Benoist. Convexes hyperboliques et quasiisométries. *Geom. Dedicata*, 122:109–134, 2006. [3](#)
- [Ben08] Yves Benoist. A survey on divisible convex sets. In *Geometry, analysis and topology of discrete groups*, volume 6 of *Adv. Lect. Math. (ALM)*, pages 1–18. Int. Press, Somerville, MA, 2008. [1](#)
- [BG04] Nicolas Bergeron and Tsachik Gelander. A note on local rigidity. *Geom. Dedicata*, 107:111–131, 2004. [5](#)
- [BH96] Steven A. Bleiler and Craig D. Hodgson. Spherical space forms and Dehn filling. *Topology*, 35(3):809–833, 1996. [3](#), [5](#)
- [BLP05] Michel Boileau, Bernhard Leeb, and Joan Porti. Geometrization of 3-dimensional orbifolds. *Ann. of Math. (2)*, 162(1):195–290, 2005. [7](#)
- [Bou81] Nicolas Bourbaki. *Groupes et algèbres de Lie. Chapitre IV, V, VI*. Masson, 1981. [11](#)
- [BP15] Victor M. Buchstaber and Taras E. Panov. *Toric topology*, volume 204 of *Mathematical Surveys and Monographs*. American Mathematical Society, Providence, RI, 2015. [17](#)
- [Cap09] Pierre-Emmanuel Caprace. Buildings with isolated subspaces and relatively hyperbolic Coxeter groups. *Innov. Incidence Geom.*, 10:15–31, 2009. [19](#)
- [Cap15] Pierre-Emmanuel Caprace. Erratum to “Buildings with isolated subspaces and relatively hyperbolic Coxeter groups”. *Innov. Incidence Geom.*, 14:77–79, 2015. [19](#)
- [CHK00] Daryl Cooper, Craig D. Hodgson, and Steven P. Kerckhoff. *Three-dimensional orbifolds and cone-manifolds*, volume 5 of *MSJ Memoirs*. Mathematical Society of Japan, Tokyo, 2000. [7](#)
- [CLM] Suhyoung Choi, Gye-Seon Lee, and Ludovic Marquis. Deformation spaces of Coxeter truncation polytopes. *In preparation*. [3](#), [4](#)
- [CLM16] Suhyoung Choi, Gye-Seon Lee, and Ludovic Marquis. Convex projective generalized Dehn filling. *Les Annales de l’ENS.*, 2016. To appear, arXiv:1611.02505. [2](#), [3](#), [4](#), [5](#), [6](#), [8](#)
- [CLM18] Suhyoung Choi, Gye-Seon Lee, and Ludovic Marquis. Deformations of convex real projective structures on manifolds and orbifolds. In *Handbook of group actions (Vol. III) ALM 40*, edited by Lizhen Ji, Athanase Papadopoulos and Shing-Tung Yau. 2018. [1](#)
- [CLT07] Daryl Cooper, Darren Long, and Morwen Thistlethwaite. Flexing closed hyperbolic manifolds. *Geom. Topol.*, 11:2413–2440, 2007. [6](#)
- [CM05] Marston Conder and Colin Maclachlan. Compact hyperbolic 4-manifolds of small volume. *Proc. Amer. Math. Soc.*, 133(8):2469–2476, 2005. [3](#)
- [Cox73] Harold S. M. Coxeter. *Regular Polytopes*. Dover books on advanced mathematics. Dover Publications, 1973. [12](#)
- [Dan11] Jeffrey Danciger. *Geometric transitions: from hyperbolic to AdS geometry*. PhD thesis, Stanford University, 2011. [7](#)
- [Dan13] Jeffrey Danciger. A geometric transition from hyperbolic to anti-de Sitter geometry. *Geom. Topol.*, 17(5):3077–3134, 2013. [7](#)

- [DGK17] Jeffrey Danciger, François Guéritaud, and Fanny Kassel. Convex cocompact actions in real projective geometry. *Preprint, arXiv:1704.08711*, 2017. [1](#)
- [DGK18] Jeffrey Danciger, François Guéritaud, and Fanny Kassel. Convex cocompactness in pseudo-Riemannian hyperbolic spaces. *Geom. Dedicata*, 192:87–126, 2018. [1](#)
- [FM10] Koji Fujiwara and Jason F. Manning. CAT(0) and CAT(-1) fillings of hyperbolic manifolds. *J. Differential Geom.*, 85(2):229–269, 2010. [4](#), [5](#)
- [FM11] Koji Fujiwara and Jason F. Manning. Simplicial volume and fillings of hyperbolic manifolds. *Algebr. Geom. Topol.*, 11(4):2237–2264, 2011. [5](#)
- [GM08] Daniel Groves and Jason Fox Manning. Dehn filling in relatively hyperbolic groups. *Israel J. Math.*, 168:317–429, 2008. [4](#)
- [Gol18] William M. Goldman. Geometric structures on manifolds. *Lecture notes*, 2018. [8](#)
- [GR70] Howard Garland and Madabusi Raghunathan. Fundamental domains for lattices in \mathbb{R} -rank 1, semisimple Lie groups. *Ann. of Math. (2)*, 92:279–326, 1970. [5](#)
- [GW12] Olivier Guichard and Anna Wienhard. Anosov representations: domains of discontinuity and applications. *Invent. Math.*, 190(2):357–438, 2012. [1](#)
- [Kap07] Michael Kapovich. Convex projective structures on Gromov-Thurston manifolds. *Geom. Topol.*, 11:1777–1830, 2007. [3](#)
- [KRR18] Alexander Kolpakov, Alan Reid, and Stefano Riolo. Many cusped hyperbolic 3-manifolds do not bound geometrically. *Proc. Amer. Math. Soc.*, 2018. To appear, arXiv:1811.05509. [6](#)
- [KS16] Alexander Kolpakov and Leone Slavich. Symmetries of hyperbolic 4-manifolds. *Int. Math. Res. Not. IMRN*, (9):2677–2716, 2016. [6](#), [20](#), [21](#), [22](#)
- [Lab06] François Labourie. Anosov flows, surface groups and curves in projective space. *Invent. Math.*, 165(1):51–114, 2006. [1](#)
- [LMRY] Gye-Seon Lee, Ludovic Marquis, Stefano Riolo, and Tomoshige Yukita. Dehn filling all the cusps of a hyperbolic 4-manifold. *In preparation*. [5](#), [7](#)
- [Lon08] Colleen Long. Small volume closed hyperbolic 4-manifolds. *Bull. Lond. Math. Soc.*, 40(5):913–916, 2008. [3](#)
- [Mar10] Ludovic Marquis. Espace des modules de certains polyèdres projectifs miroirs. *Geom. Dedicata*, 147:47–86, 2010. [4](#)
- [Mar14] Ludovic Marquis. Around groups in Hilbert geometry. In *Handbook of Hilbert geometry*, volume 22 of *IRMA Lect. Math. Theor. Phys.*, pages 207–261. Eur. Math. Soc., Zürich, 2014. [1](#)
- [Mar16] Bruno Martelli. *An introduction to Geometric Topology*. CreateSpace Independent Publishing Platform, 2016. [7](#), [20](#)
- [Mar17] Ludovic Marquis. Coxeter group in Hilbert geometry. *Groups Geom. Dyn.*, 11(3):819–877, 2017. [23](#)
- [Mar18] Bruno Martelli. Hyperbolic four-manifolds. *Handbook of Group Actions*, Volume III:37–58, 2018. [1](#)
- [McM17] Curtis T. McMullen. The Gauss-Bonnet theorem for cone manifolds and volumes of moduli spaces. *Amer. J. Math.*, 139(1):261–291, 2017. [7](#)
- [Mou88] Gabor Moussong. *Hyperbolic Coxeter groups*. PhD thesis, Ohio State University, 1988. [19](#)
- [MR18] Bruno Martelli and Stefano Riolo. Hyperbolic Dehn filling in dimension four. *Geom. Topol.*, 22(3):1647–1716, 2018. [5](#), [7](#)
- [MRS13] D. B. McReynolds, Alan W. Reid, and Matthew Stover. Collisions at infinity in hyperbolic manifolds. *Math. Proc. Cambridge Philos. Soc.*, 155(3):459–463, 2013. [3](#), [5](#)
- [Osi07] Denis V. Osin. Peripheral fillings of relatively hyperbolic groups. *Invent. Math.*, 167(2):295–326, 2007. [4](#)
- [RS19a] Stefano Riolo and Andrea Seppi. Geometric transition from hyperbolic to Anti-de Sitter structures in dimension four. *Preprint, arXiv:1908.05112*, 2019. [7](#)
- [RS19b] Stefano Riolo and Leone Slavich. New hyperbolic 4-manifolds of low volume. *Algebr. Geom. Topol.*, 19(5):2653–2676, 2019. [6](#)

- [Sch89] Viktor Schroeder. A cusp closing theorem. *Proc. Amer. Math. Soc.*, 106(3):797–802, 1989. **5**
- [Sla17] Leone Slavich. The complement of the figure-eight knot geometrically bounds. *Proc. Amer. Math. Soc.*, 145(3):1275–1285, 2017. **6**
- [Thu79] William Thurston. The geometry and topology of three-manifolds. <http://library.msri.org/nonmsri/gt3m>, Electronic version 1.1, 1979. **2, 7**
- [Thu98] William Thurston. Shapes of polyhedra and triangulations of the sphere. In *The Epstein birthday schrift*, volume 1 of *Geom. Topol. Monogr.*, pages 511–549. Geom. Topol. Publ., Coventry, 1998. **7**
- [Ver05] Constantin Vernicos. Introduction aux géométries de Hilbert. In *Actes de Séminaire de Théorie Spectrale et Géométrie. Vol. 23. Année 2004–2005*. Univ. Grenoble I, 2005. **1**
- [Vey70] Jacques Vey. Sur les automorphismes affines des ouverts convexes saillants. *Ann. Scuola Norm. Sup. Pisa (3)*, 24:641–665, 1970.
- [Vin71] Èrnest Vinberg. Discrete linear groups that are generated by reflections. *Izv. Akad. Nauk SSSR Ser. Mat.*, 35:1072–1112, 1971. **3, 6, 8, 10, 11**

DEPARTMENT OF MATHEMATICS, SUNGKYUNKWAN UNIVERSITY, SUWON, SOUTH KOREA

E-mail address: gyeseonlee@skku.edu

UNIV RENNES, CNRS, IRMAR - UMR 6625, F-35000 RENNES, FRANCE

E-mail address: ludovic.marquis@univ-rennes1.fr

INSTITUT DE MATHÉMATIQUES, UNIVERSITÉ DE NEUCHÂTEL, SWITZERLAND

E-mail address: stefano.riolo@unine.ch