

Phase noise in SiGe HBT amplifiers and applications

O. Llopis, S. Gribaldo

LAAS-CNRS, 7 av. du Colonel Roche, 31077 Toulouse, FRANCE

e-mail : llopis@laas.fr

Outline :

Amplifier residual phase noise, as a tool to study nonlinear noise in transistors

- ⇒ Measurement technique
- ⇒ Specificity of the characterization of SiGe devices
- ⇒ Residual phase noise modelling of SiGe transistors

Application to the design of a two stages low phase noise SiGe amplifier

Application to the phase noise characterization and modelling of new types of microwave frequency stabilization devices : FBAR resonators and optical resonators

Introduction : noise in oscillators

What is the origin of an oscillator short term frequency fluctuation ?

- 1) phase fluctuations in the **active device** (amplifier) resulting from the baseband noise or directly from the HF noise

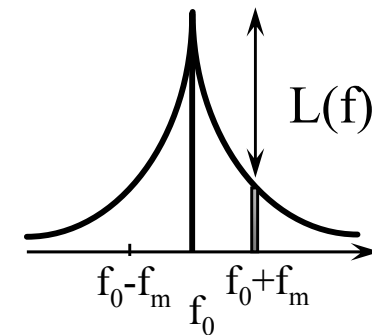

Main problem at microwave frequencies where the devices are small and often sustain high $1/f$ noise

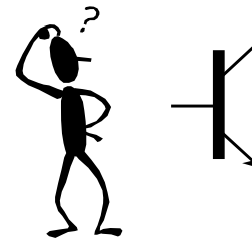

- 2) **resonator** $1/f$ noise

Not a problem in passive microwave resonators but a real problem with piezoelectric resonators

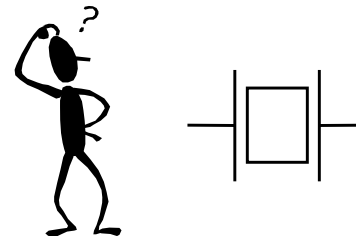

- 3) control element phase noise (ex : **varactor**)

Not too much studied – not too strong
Nonlinear noise not related to baseband noise

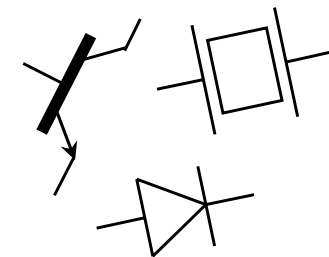
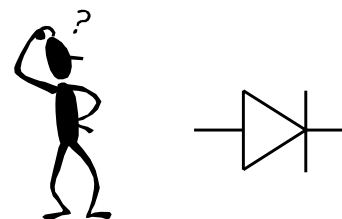

4) output **buffer** phase noise

May have an influence if active. Should be modelled in the same way as the oscillator active element

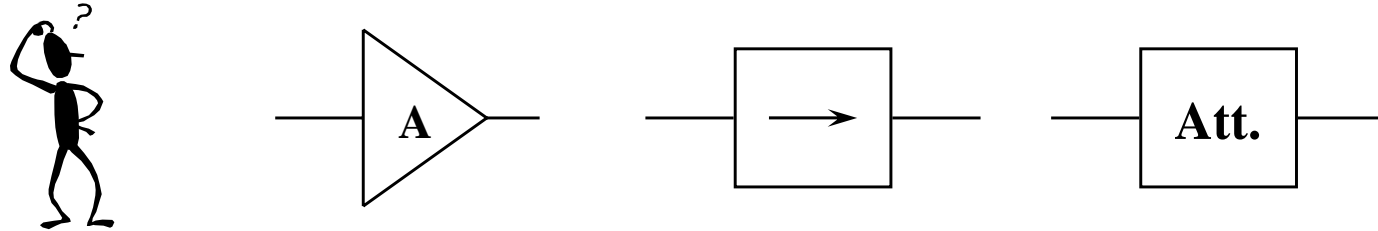

5) sensitivity to an external **mechanical perturbation** (vibration)

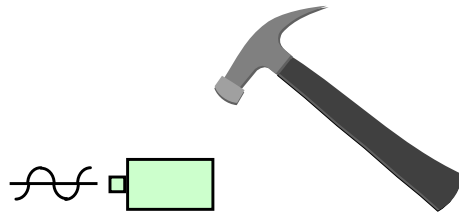

Need of a high quality mechanical embedding

6) sensitivity to an external **electrical perturbation**

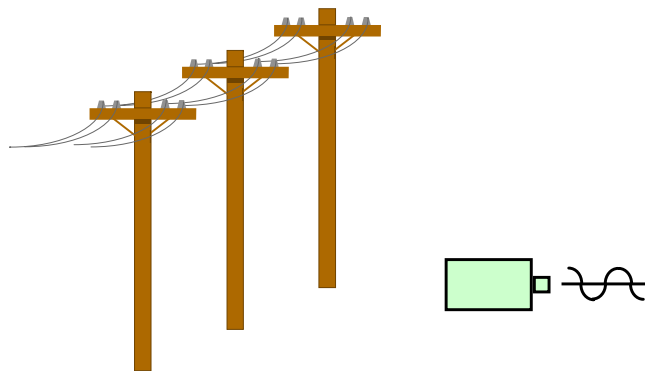

Need of a good electrical shielding

The simplified feedback oscillator model

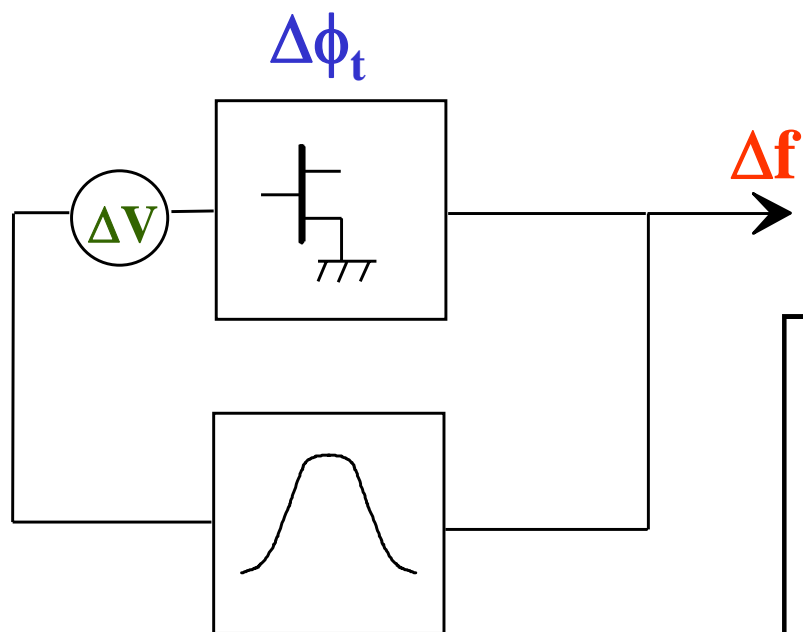

Δf = oscillator frequency noise

$\Delta\phi_t$ = transistor (open loop) phase noise

ΔV = equivalent input noise voltage (LF or HF)

$$\frac{d\phi}{df} = \frac{2Q}{f}$$

$$\Delta f = \frac{\Delta\phi_t}{\frac{d\phi}{df}} = \frac{f_0}{2Q} \Delta\phi_t$$

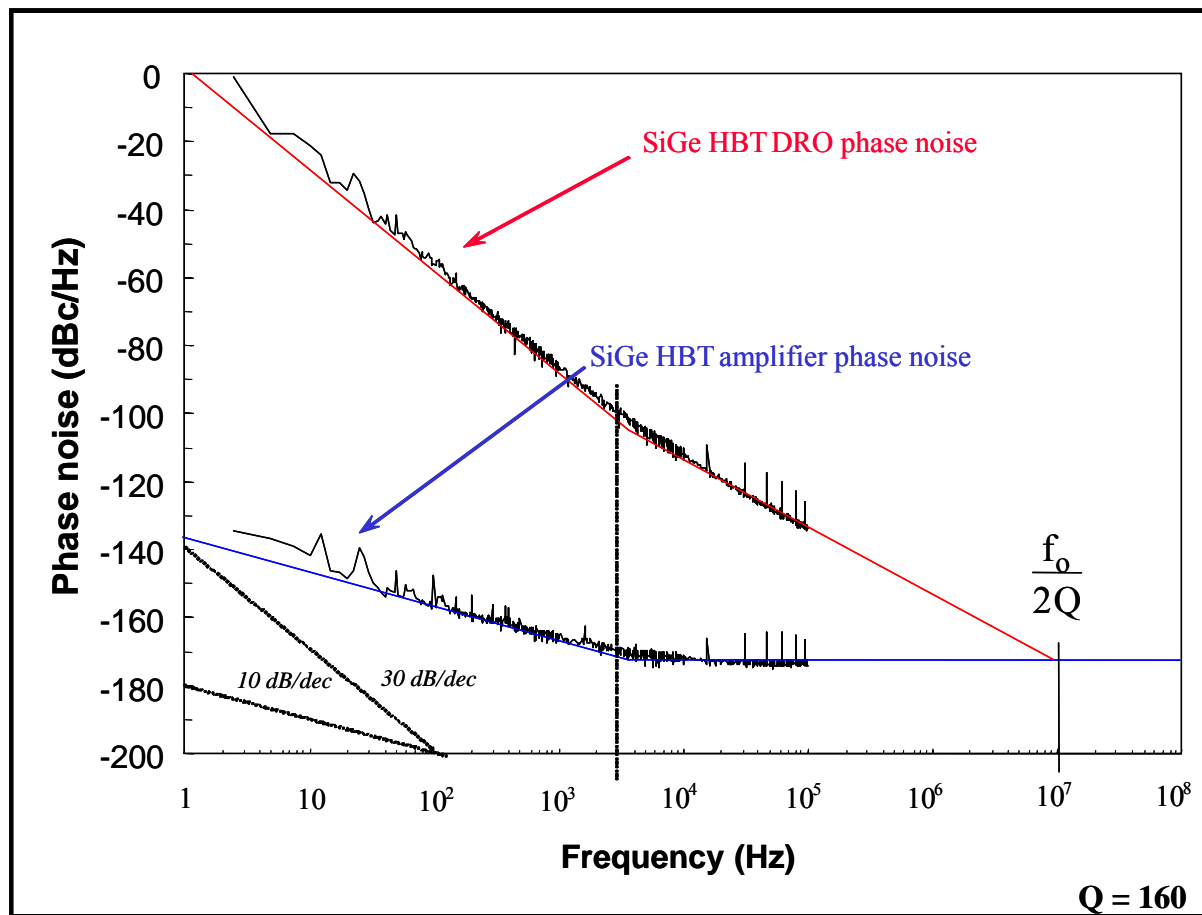

Example of phase to frequency conversion in a 4 GHz SiGe HBT oscillator

Residual phase noise measurement of low phase noise amplifiers and transistors

Advantages of open loop (or residual) phase noise studies versus oscillator phase noise studies :

SIMULATION

- ⇒ Faster for a driven circuit than an autonomous circuit
- ⇒ Possibility to analyse the noise conversion both in linear and nonlinear modes

MEASUREMENT

- ⇒ Better control of the parameters (no needs for a loop phase control)
- ⇒ Measurement either in linear and nonlinear modes

Amplifier phase noise characterisation

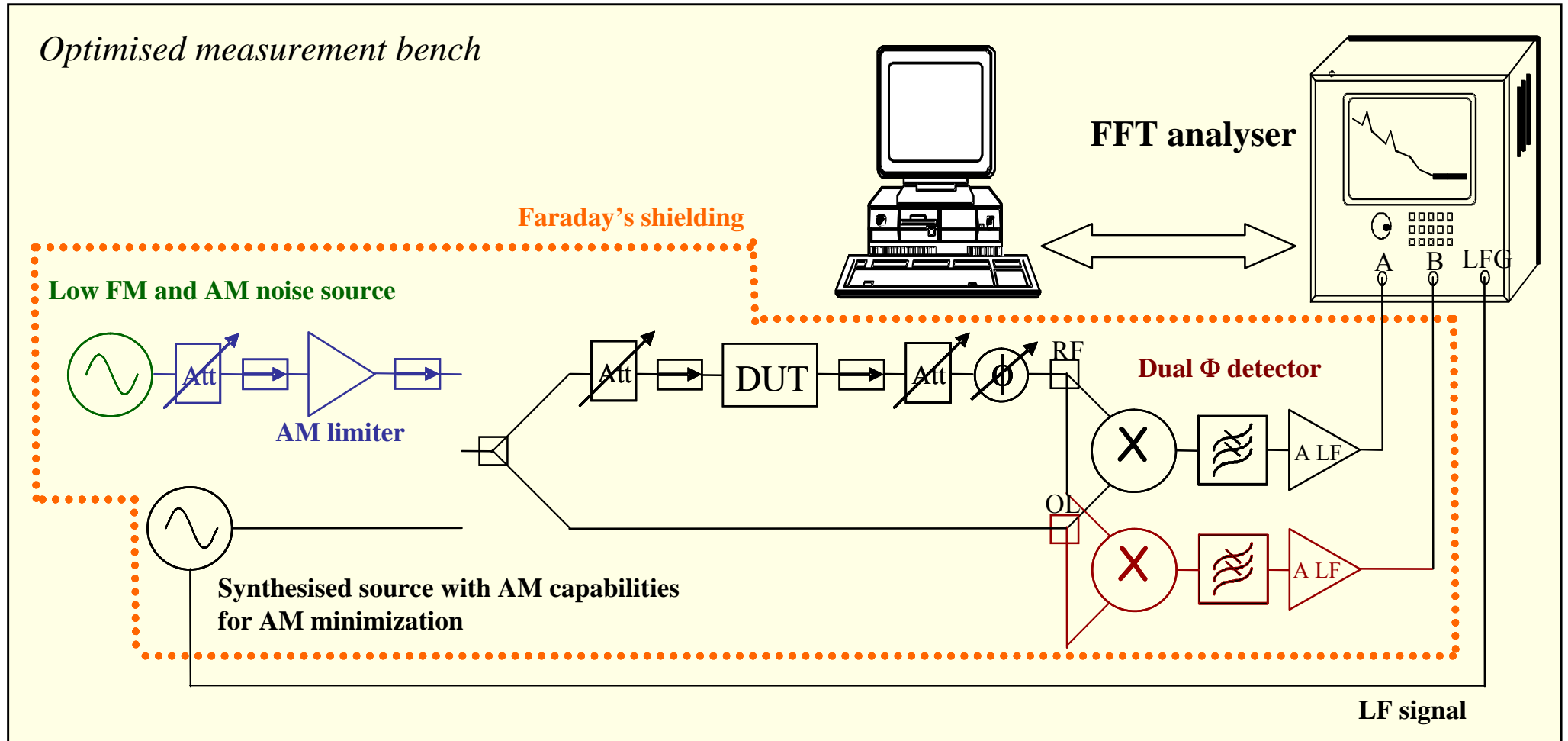

$$\Delta \bar{V}_s^2 = \underbrace{G^2 K_\phi^2 \Delta \bar{\phi}_t^2}_{\text{DUT noise}} + \underbrace{(2\pi t)^2 G^2 K_\phi^2 \Delta \bar{f}^2 + G^2 K_{AM}^2 \Delta \bar{A}^2 + G^2 K_\phi^2 \Delta \bar{\phi}_{mel}^2 + G^2 \Delta \bar{V}_{ampli}^2}_{\text{Noise Floor}}$$

Delay balance and low phase noise source
 AM limiter and low AM noise source
 Low 1/f noise Si detector / amplifier + cross-correlation detection

Amplifier phase noise characterisation : *measurement capabilities and AM rejection problem*

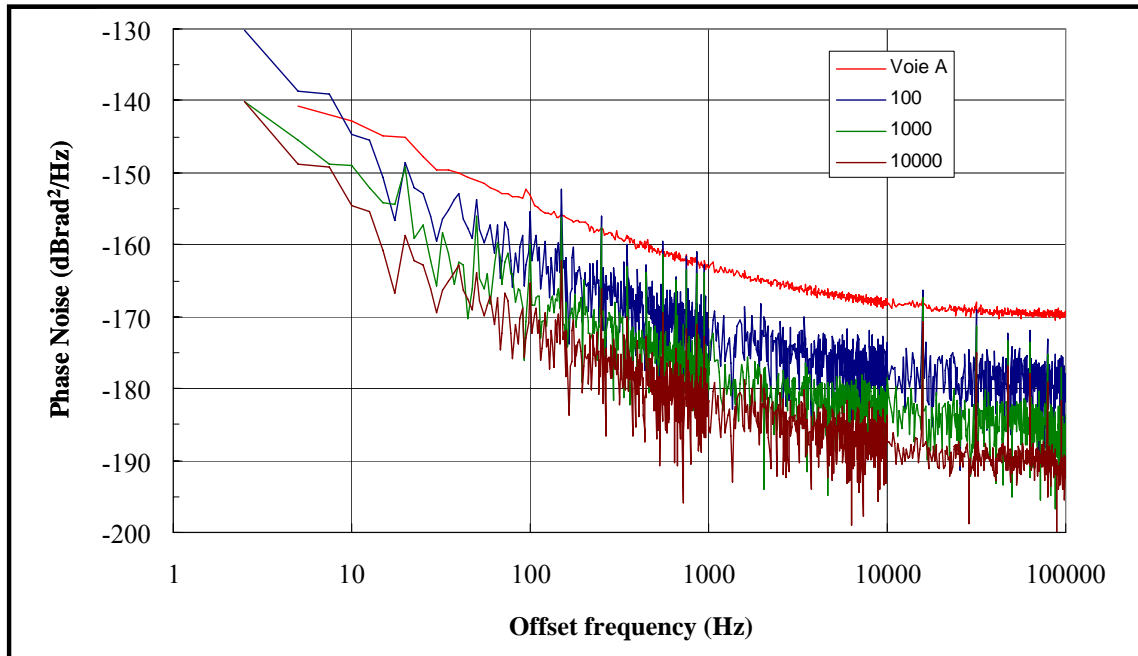

Advantage of the dual detector / cross-spectrum technique : effect of the averaging number on the 3.5 GHz noise floor

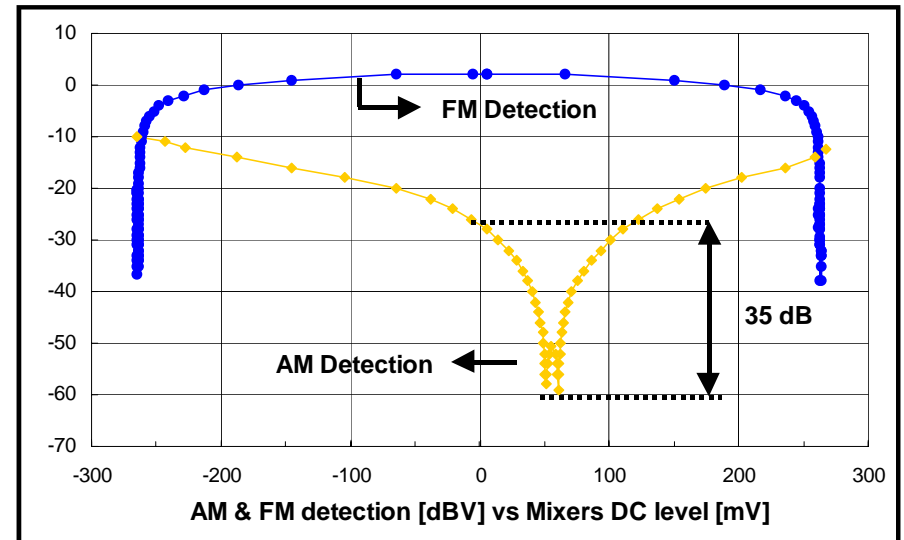

Phase (or frequency) detection, at the mixer level versus mixer DC output

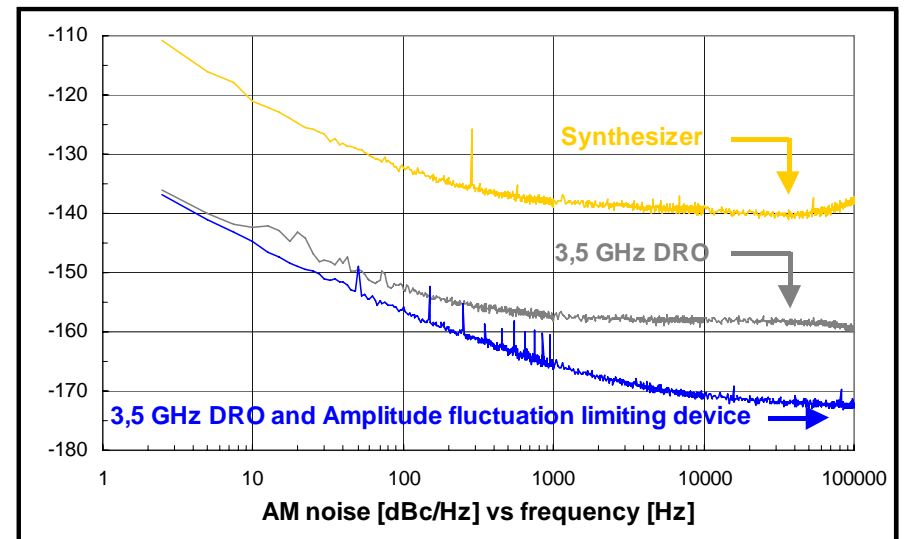

AM noise of different microwave sources

Phase noise in microwave transistors : *device selection for low phase noise oscillator design*

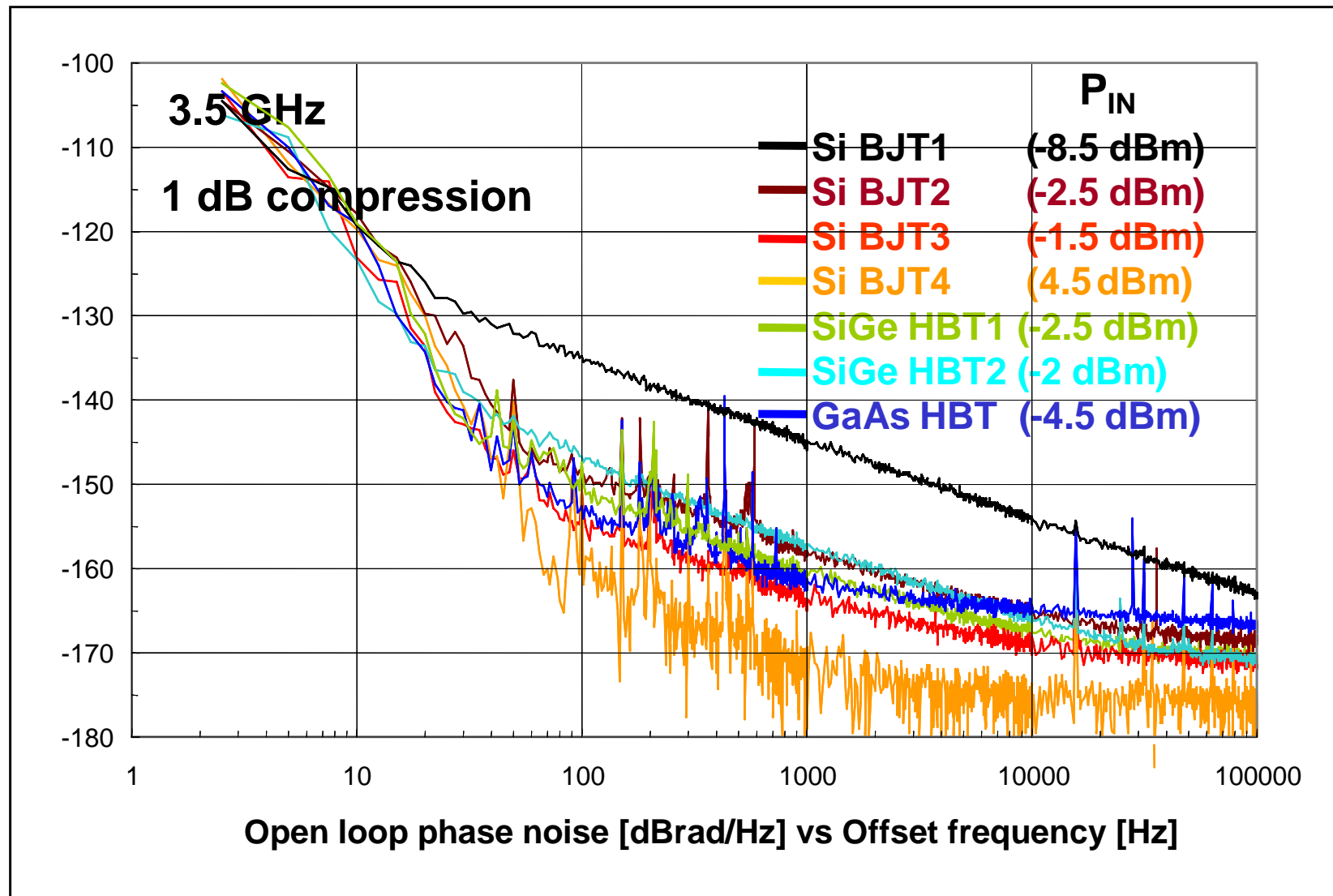

In this experiment, the devices are maintained onto 50 Ω load at RF (3.5 GHz), using two isolators, and are battery biased with a low impedance bias on the collector and a capacitive filtering of the LF current noise $S_{i_{be}}$ on the base bias (low impedance above 100 Hz)

G. Cibiel et al., 2003 GAAS Symp.

Phase noise in microwave SiGe HBTs :

investigations on the effect of the base bias network on the phase noise of a SiGe HBT

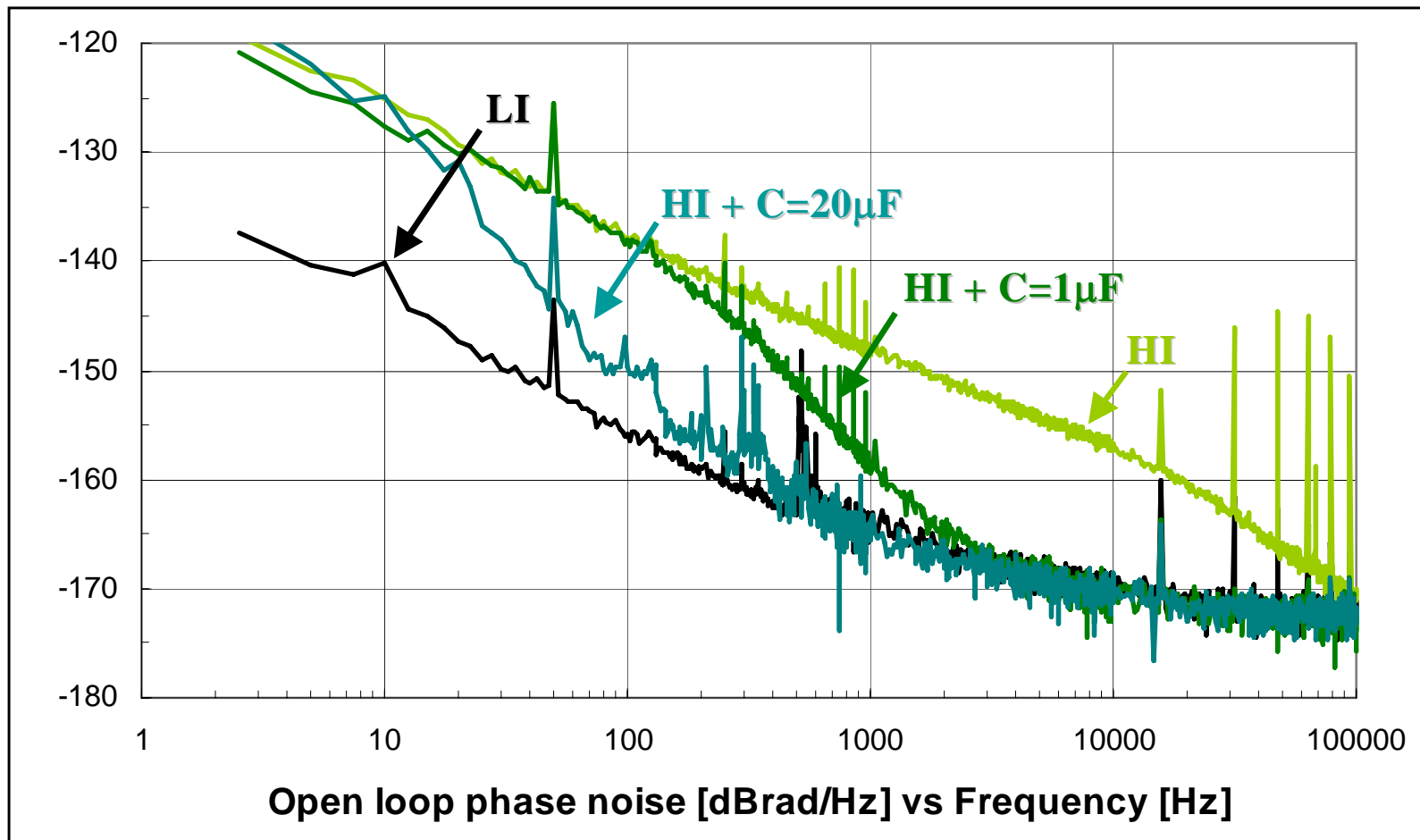

Residual phase noise of an SiGe HBT amplifier at 3.5 GHz (LPNT 32, SiGe Semiconductor)

Three types of base bias networks are compared : high impedance bridge, capacitive filtering and low impedance

The low impedance bias cancels the effect of the Si_{be} low frequency noise source

Phase noise in microwave SiGe HBTs :

Investigations on the phase noise of SiGe HBTs versus the transistor microwave input power

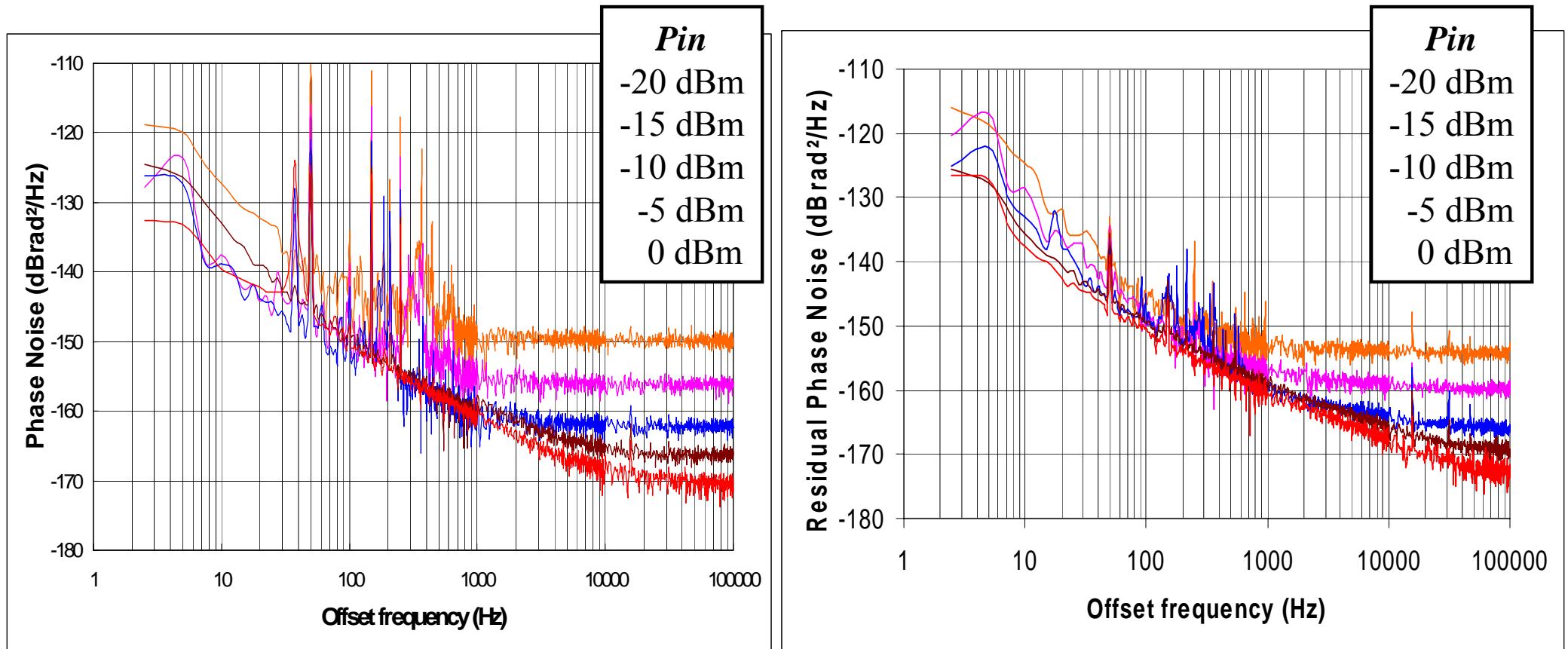

*Case of SiGe HBT (LPNT32)
loaded onto 50 Ω at 3.5 GHz
from linear regime up to 1dB compression*

*Case of SiGe HBT (BFP620)
loaded onto 50 Ω at 3.5 GHz
from linear regime up to 1dB compression*

S. Gribaldo et al., 2005 ICNF and EFTF Conferences

Phase noise in microwave SiGe HBTs : discussion on the results versus P_{in}

1/f phase noise is necessarily a conversion noise, and is related to the device LF noise

White phase noise can result either from a conversion process or be an additive noise

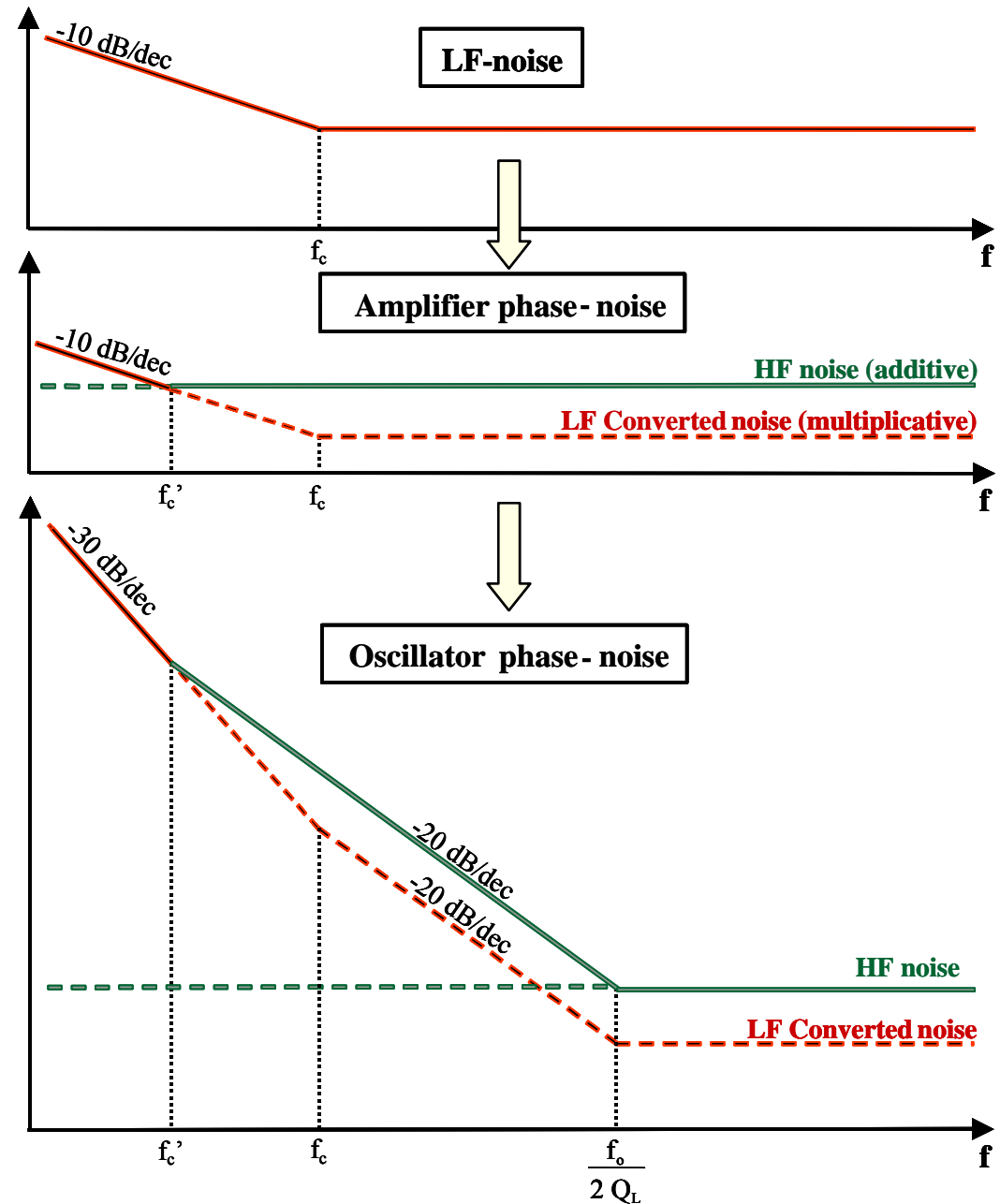
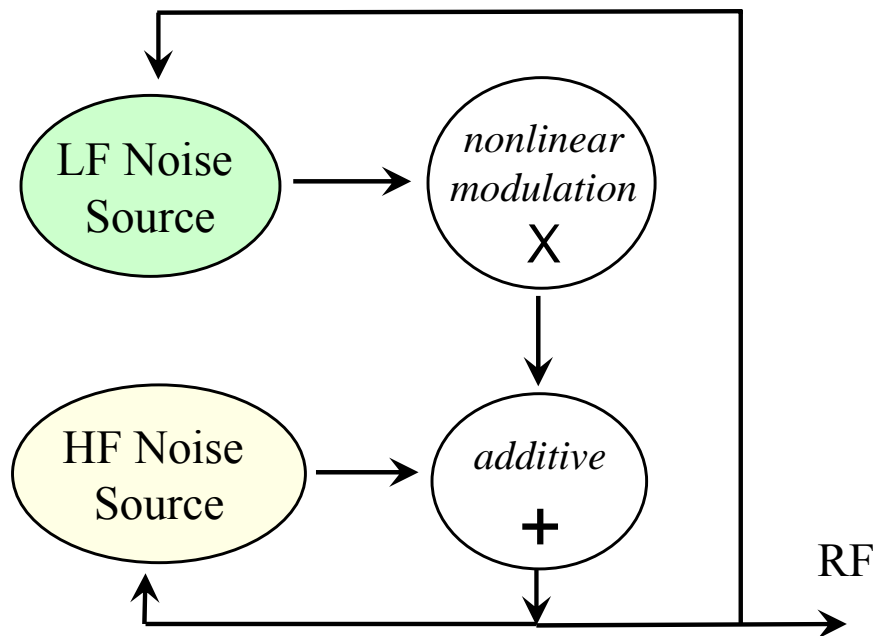

Phase noise in microwave SiGe HBTs :

phase noise floor analysis -> HF noise contribution to the phase noise

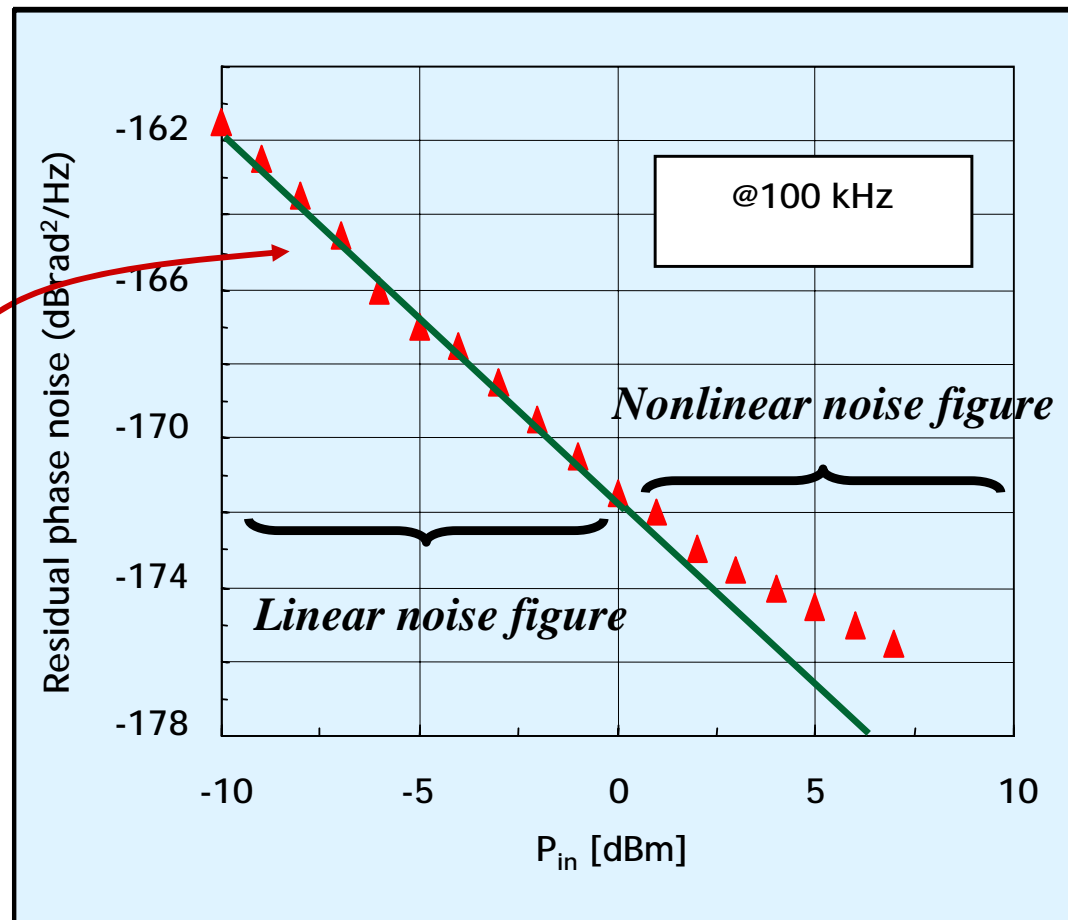
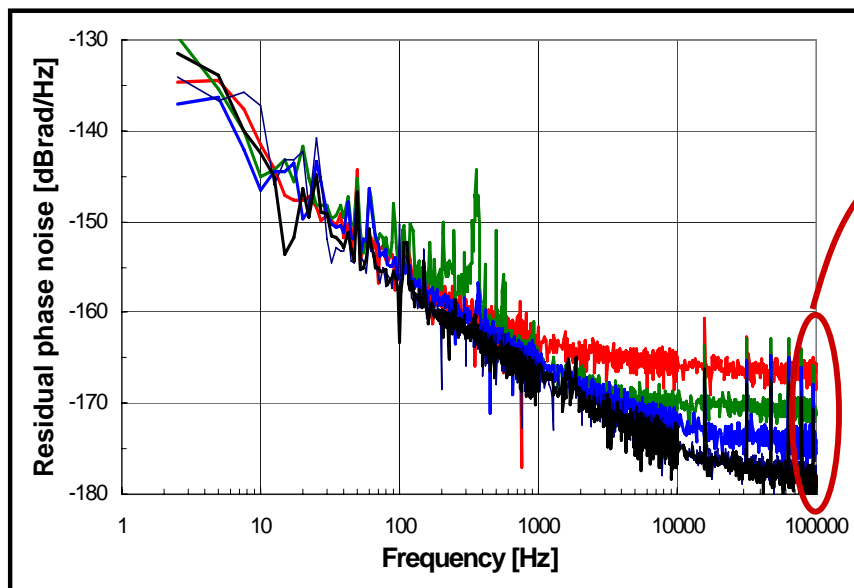

Signature of an additive phase noise

$$S_{\Phi_{add}} = \frac{F_{dut} k T_0}{P_{in}}$$

1 dB/dB slope, at least when the device is not too much driven into compression

Cibiel et al., IEEE Trans. on MTT, jan. 2004

Phase noise in microwave SiGe HBTs : *LF noise into phase noise conversion (modulation noise)*

1) Case n° 1 : no special filtering of the $S_{i_{be}}$ source

$$S_{i_{be}} = K \frac{I_{be_{DC}}^\alpha}{f^\beta} + 2qI_{be_{DC}}$$

The influence of this noise source is predominant. The phase noise is easy to calculate, but it is also about 15 dB higher than when this noise source effect is cancelled.

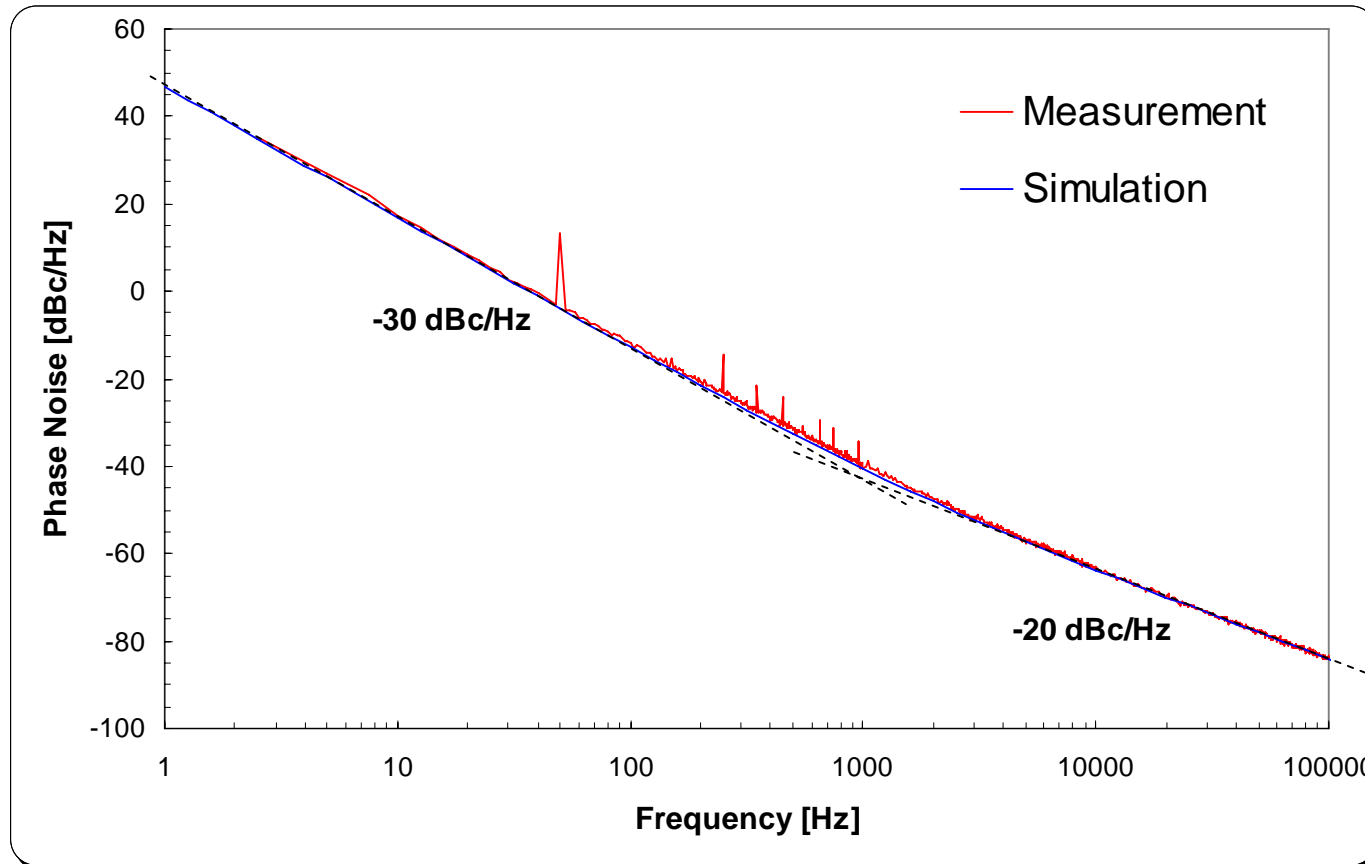

Ex : 10 GHz SiGe HBT VCO

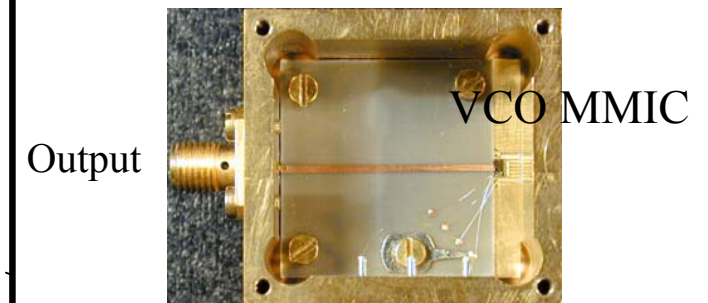

K. W. Wong et al., 2003 IEEE RFIC

Phase noise in microwave SiGe HBTs : *LF noise into phase noise conversion (modulation noise)*

2) Case 2 : cancellation of $S_{i_{be}}$ and extraction of the equivalent external $S_{v_{be}}$ noise source with different microwave power applied on the device

Main difficulty :

The LF noise is modified by the large signal operation, and the amplitude of the change is very dependent on the device

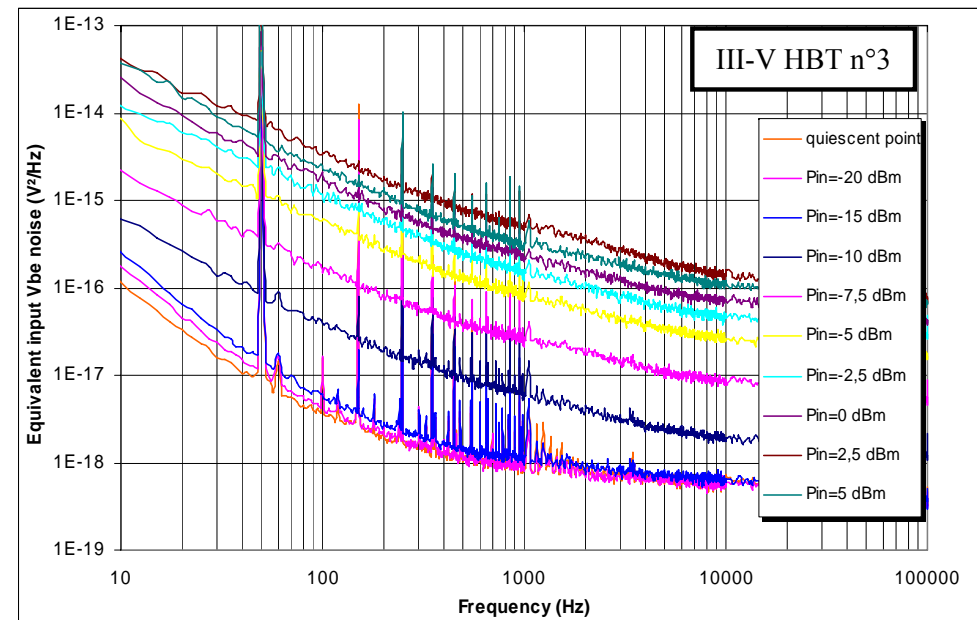
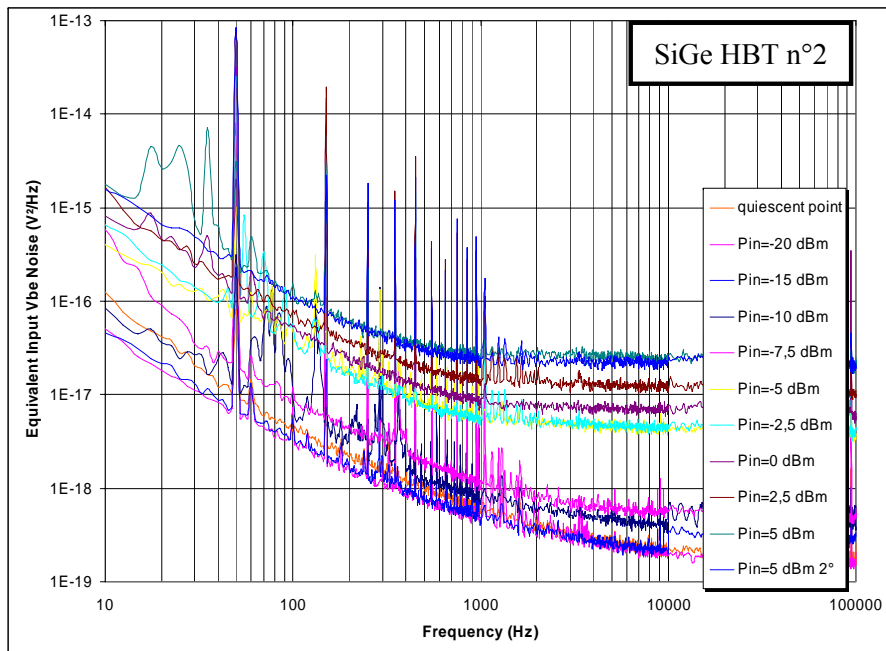
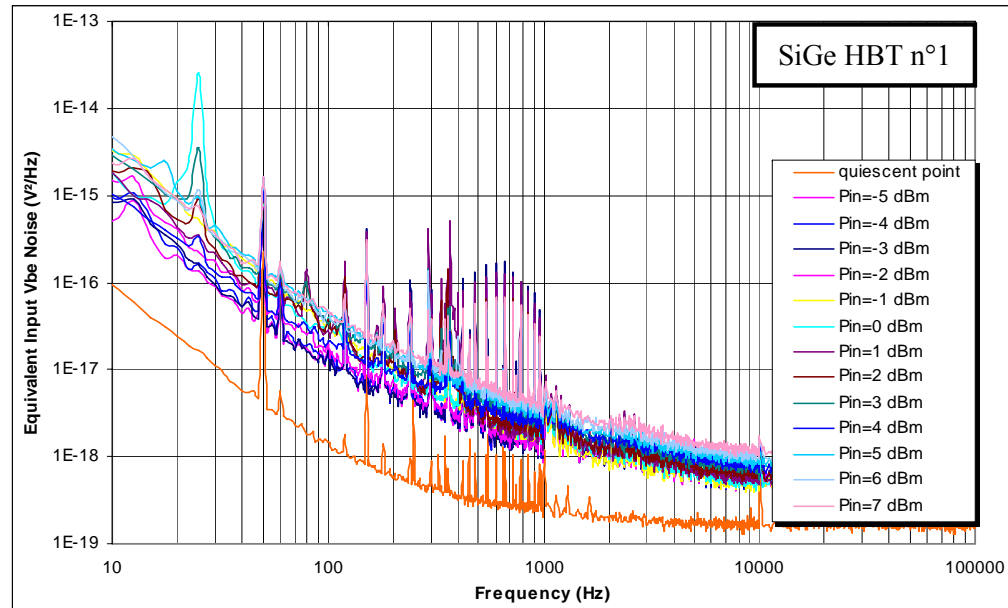

Phase noise in microwave SiGe HBTs : *LF noise into phase noise conversion (modulation noise)*

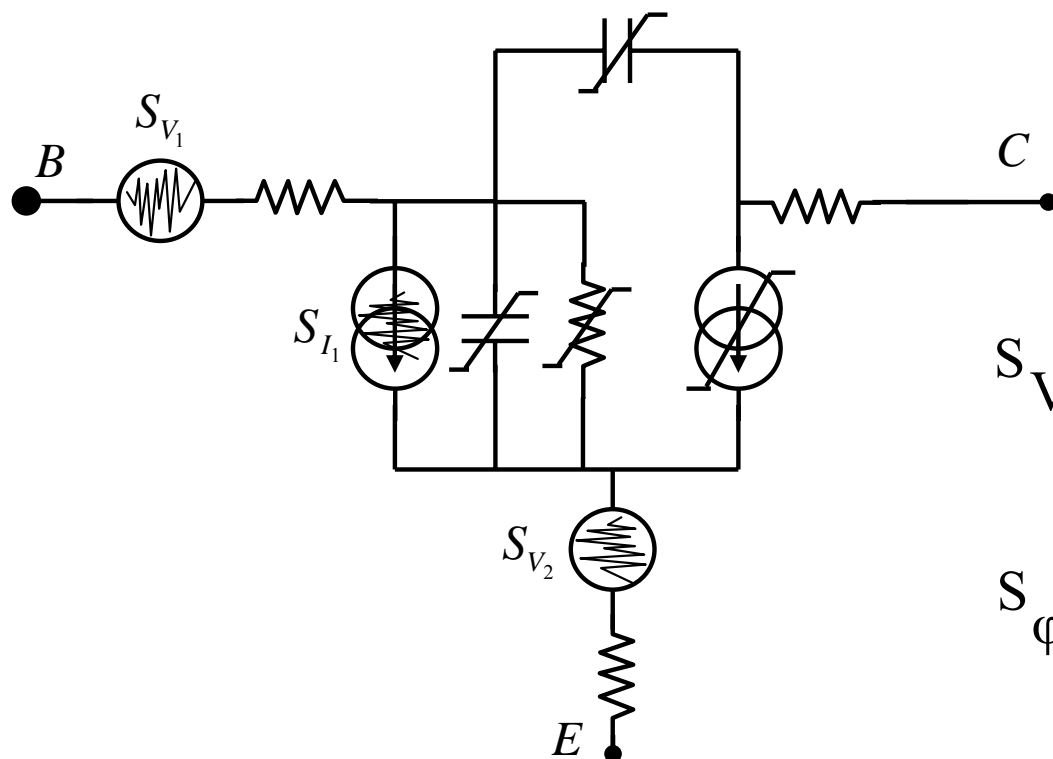

$$S_{V_e} = \sum K_{BF}^2 (V_{be}, V_{ce}) * S_{i \text{ or } v}$$

$$S_{\phi} = \sum K_{\phi}^2 (V_{be}, V_{ce}) * S_{i \text{ or } v}$$

The LF noise sources location with respect to the device nonlinearities is essential to correctly compute the transfer functions K_{BF} and K_{ϕ}

However, according to recent studies on cyclostationary noise, this noise description may not be sufficient and it may be necessary to take into account the nonlinear behaviour at the noise source level

Approach using nonlinear noise sources

Example : implementation of a nonlinear voltage noise source

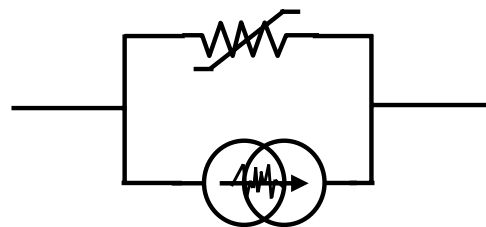

or ?

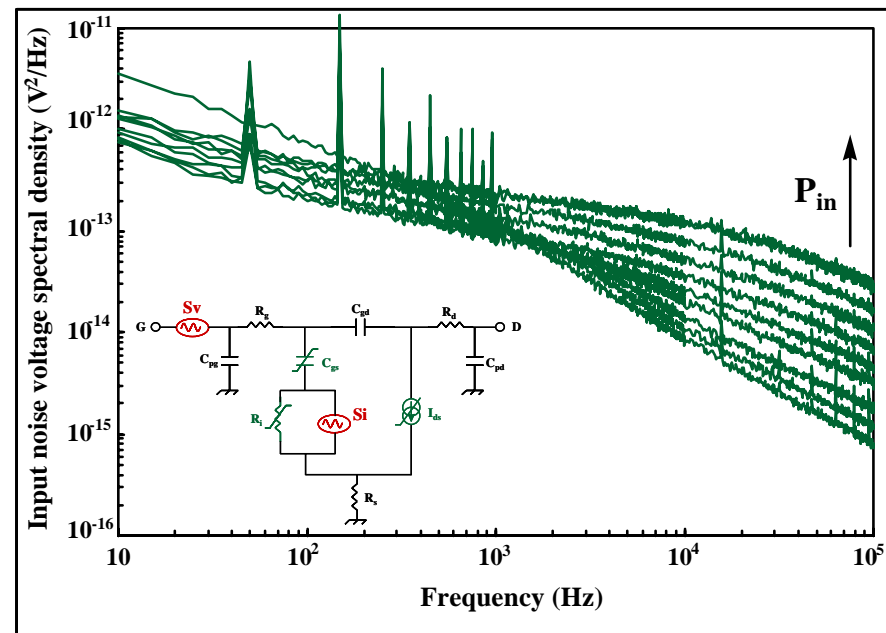
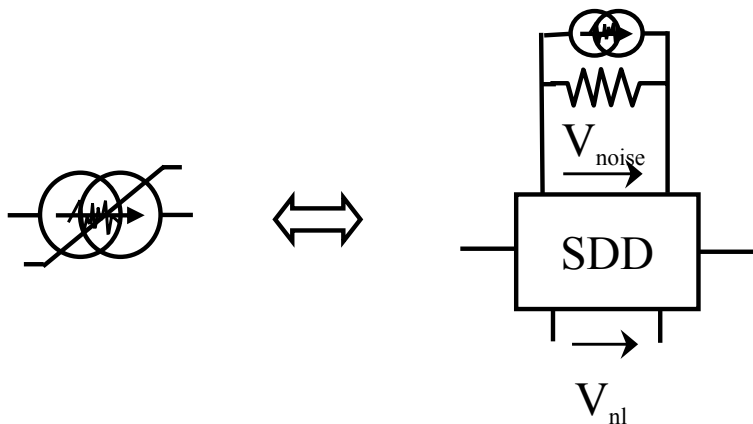
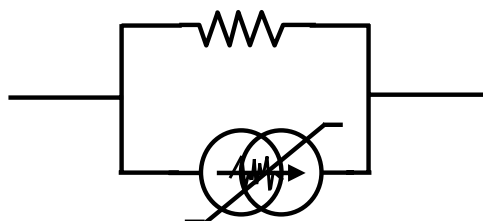

Example of a model developed for a HEMT device, including a current noise source associated to a non-linear resistance, to generate a nonlinear LF noise voltage equivalent behavior

O. Llopis et al., 2001 IEEE MTT S.

Alternative approach : a RF power dependent external voltage noise source

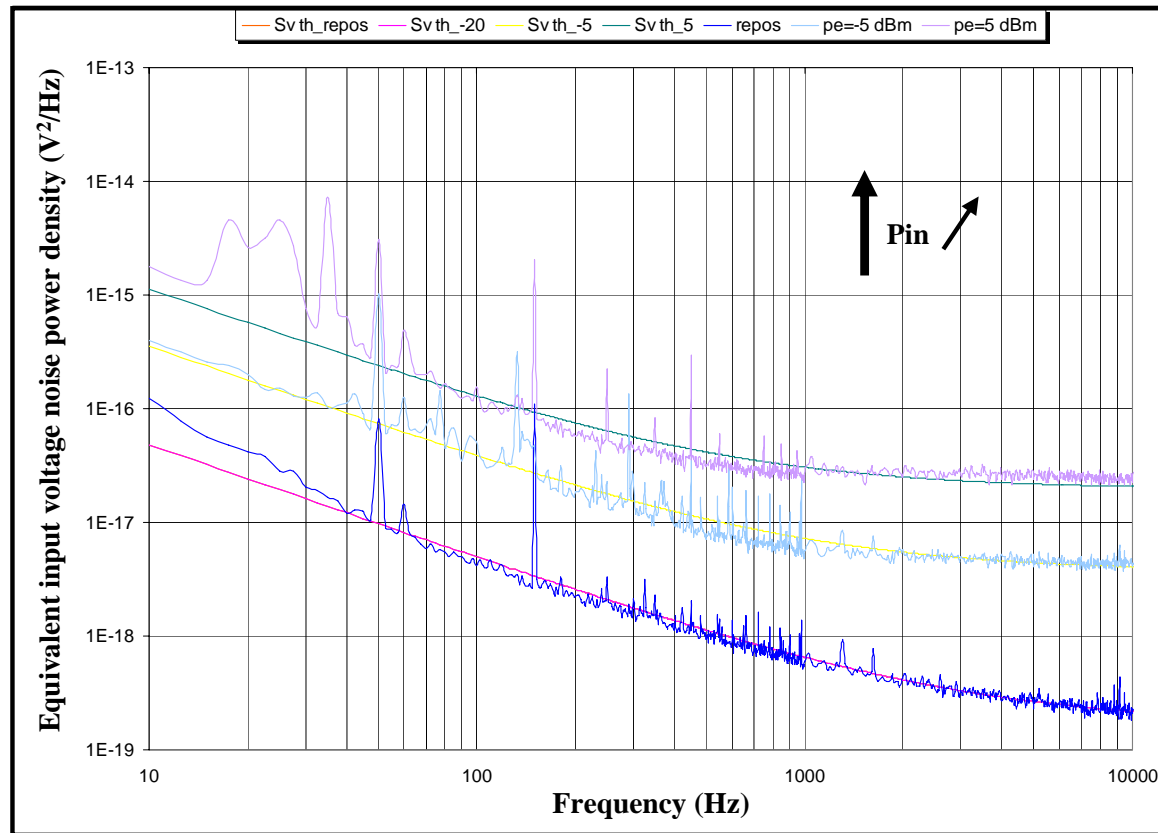

Equivalent input voltage noise of an SiGe HBT (BFP620) submitted to a 3.5 GHz large signal, from linear regime up to 1 dB compression (RF load = 50 Ω)

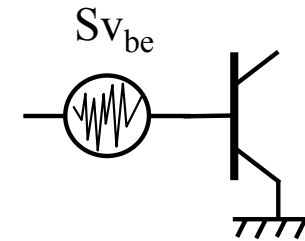

Model obtained with two empirical factors :

$$k_1 = a_1 * \left(e^{\left(\frac{P_{in}}{b_1} \right)} - \frac{1}{c_1} \right)$$

$$k_2 = a_2 * \left(e^{\left(\frac{P_{in}}{b_2} \right)} - \frac{1}{c_2} \right)$$

$$S_{v_{be}}(P_{in}) = \left(S_{v_{1/f}} + k_1(P_{in}) * S_{v_{floor}} \right) * (1 + k_2(P_{in}))$$

Gribaldo et al., 2005 ICNF

Phase noise in microwave SiGe HBTs : *simulating the overall amplifier phase noise*

Harmonic Balance

LF noise conversion



sensitivity techniques or pnmx

HF noise addition (nonlinear)



analytical using $F_{\text{nonlinear}}$ or pnmx

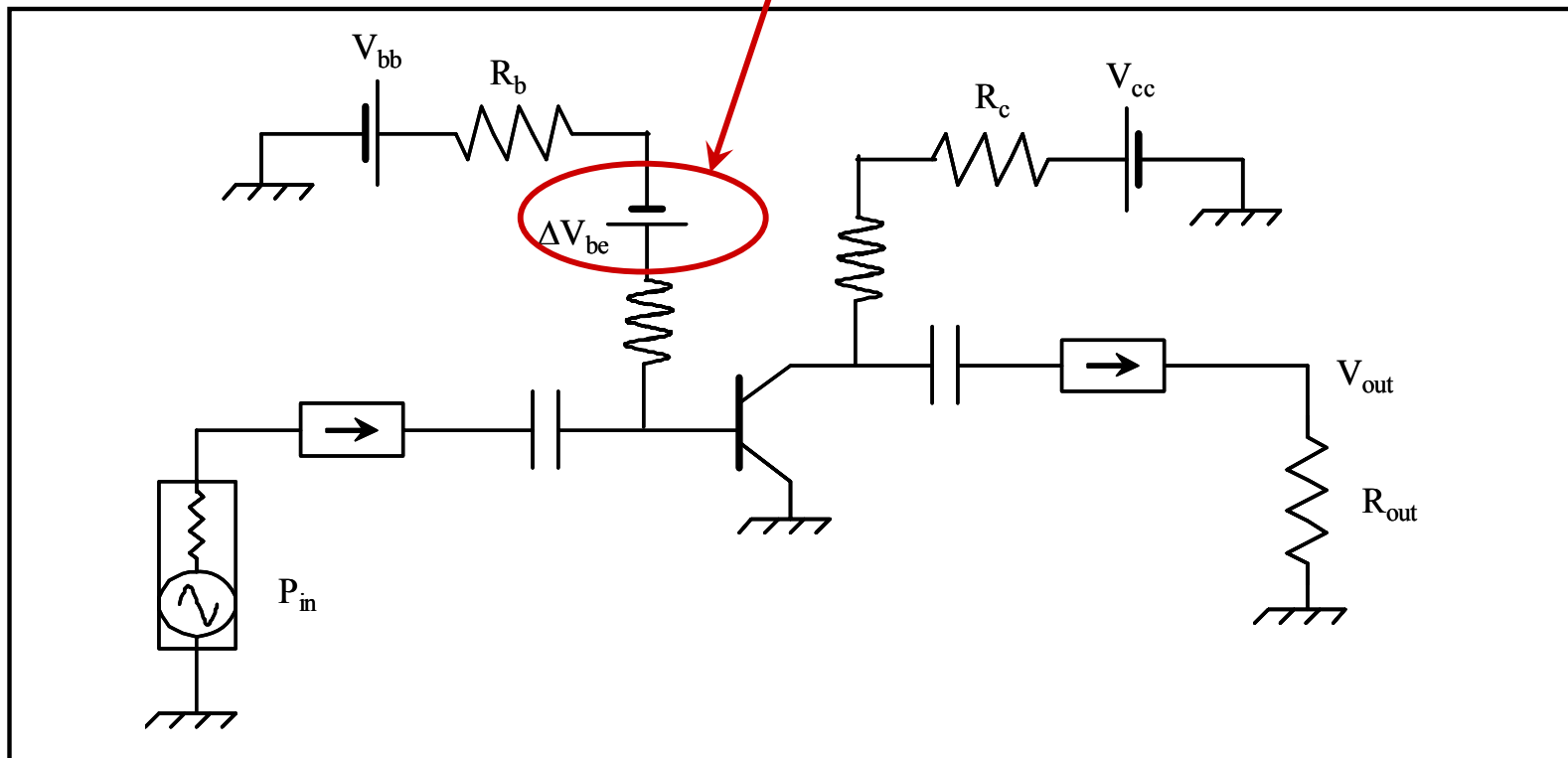

Simulation / measurement

SiGe HBT loaded onto 50 Ω
at 3.5 GHz

from linear regime
to small compression

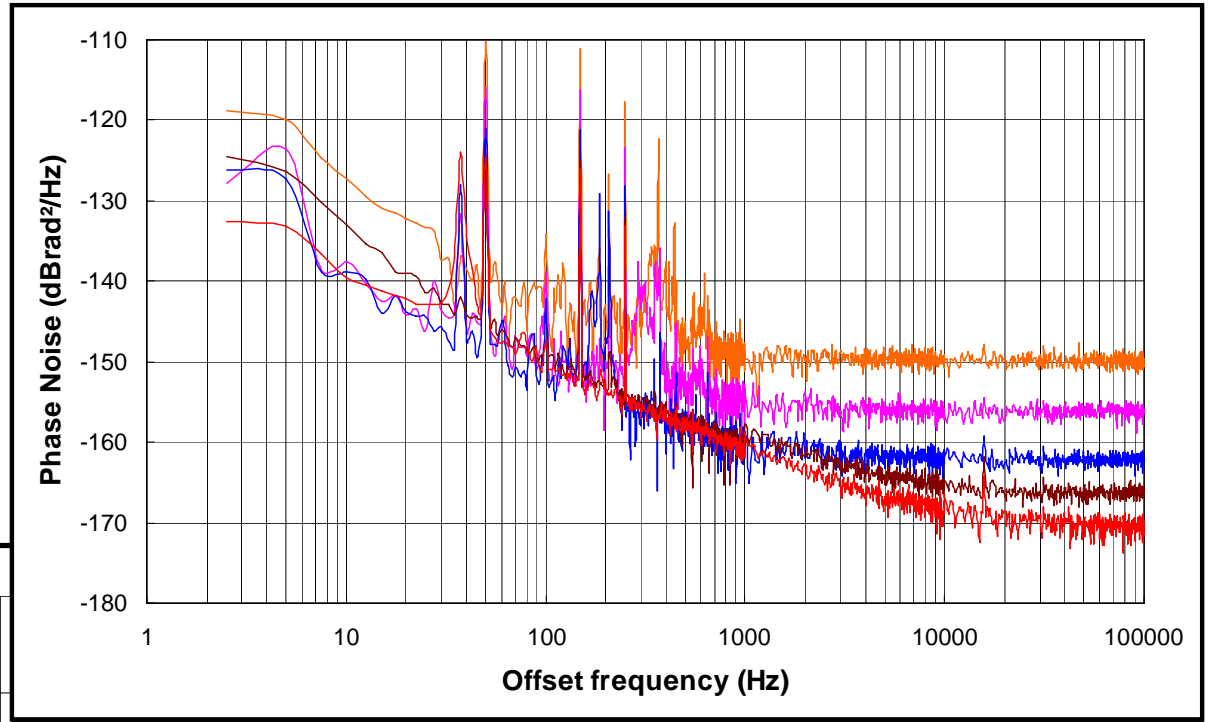
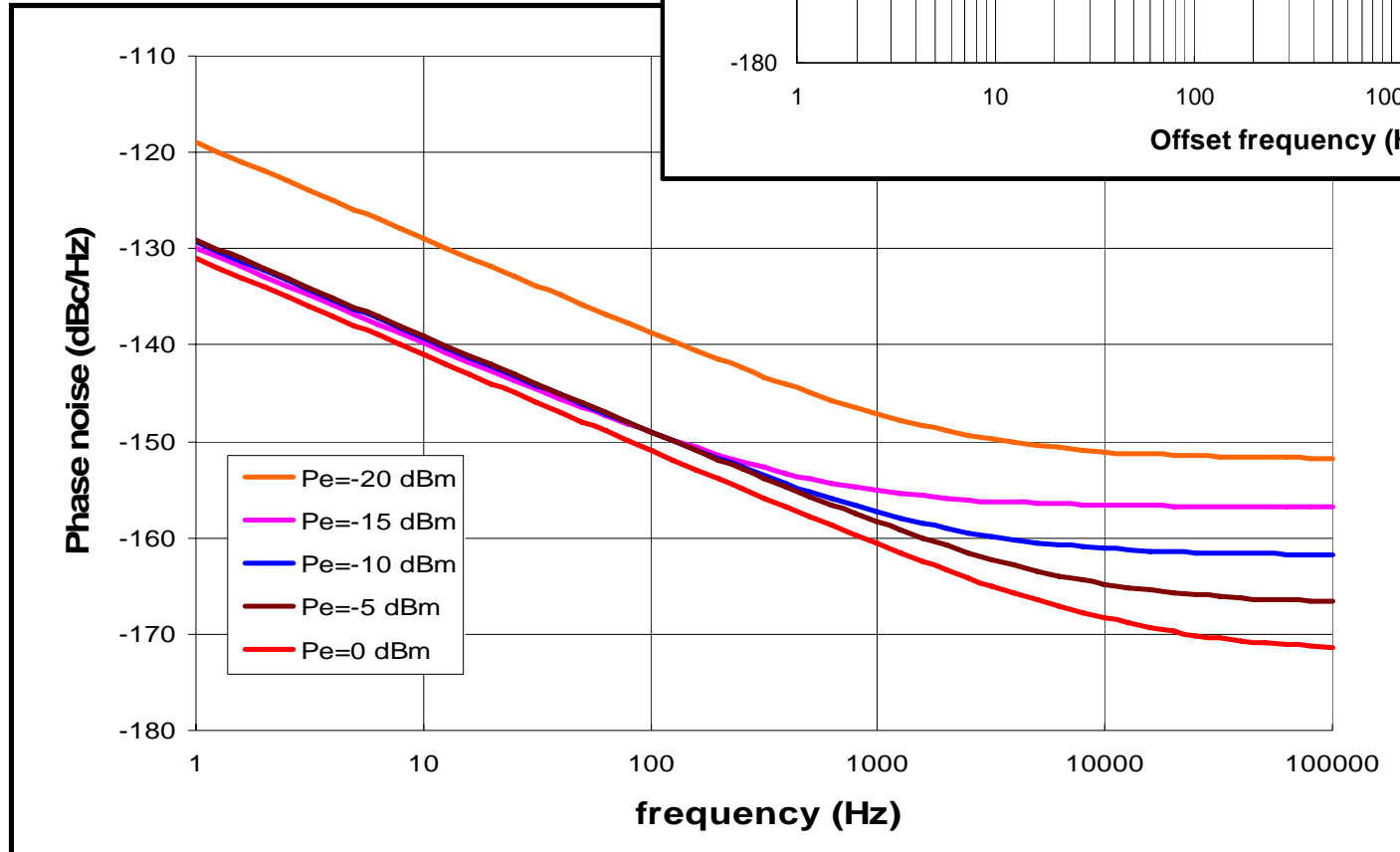

*Gummel-poon HBT
model, using an extrinsic
LF noise source
dependent on the
microwave RF power*

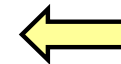

S. Gribaldo et al., 2005 ICNF

Phase noise optimisation

1) Case of an hybrid DRO (or any resonator stabilised oscillator)

High quality Oscillator = **low phase noise amplifier** + **high loaded Q resonator**

Resonator : Coupling factor involving at least 4 dB losses

Amplifier : Transistors selection using residual phase noise data

LF loading circuitry (bias network)

Close to the carrier phase noise (multiplicative)

→ minimisation of the LF noise conversion varying the transistor RF loads and the circuit topology (using CAD)

Far from carrier phase noise (additive)

→ minimisation of the transistor nonlinear noise figure (using CAD)

→ optimum resonator coupling close to 6 dB

2) Case of an integrated VCO (MMIC)

LF loading circuitry (bias network)

→ more difficult, because of the required size of the decoupling inductors

Optimisation of circuit topology (and transistor RF load) using a fast enough computing approach (ex : sensitivity technique)

Phase noise optimisation

3) Problem of gain & phase noise trade-off

3.1) Additive phase noise :

Amplifier :

$$S_{\phi} = \frac{F k T G}{P_{sat}}$$

$S_{\phi} \uparrow$ when $G \uparrow$

Resonator :

$Q_L \uparrow$ when $L \uparrow$

➔ *Optimum gain G, or coupling losses L*

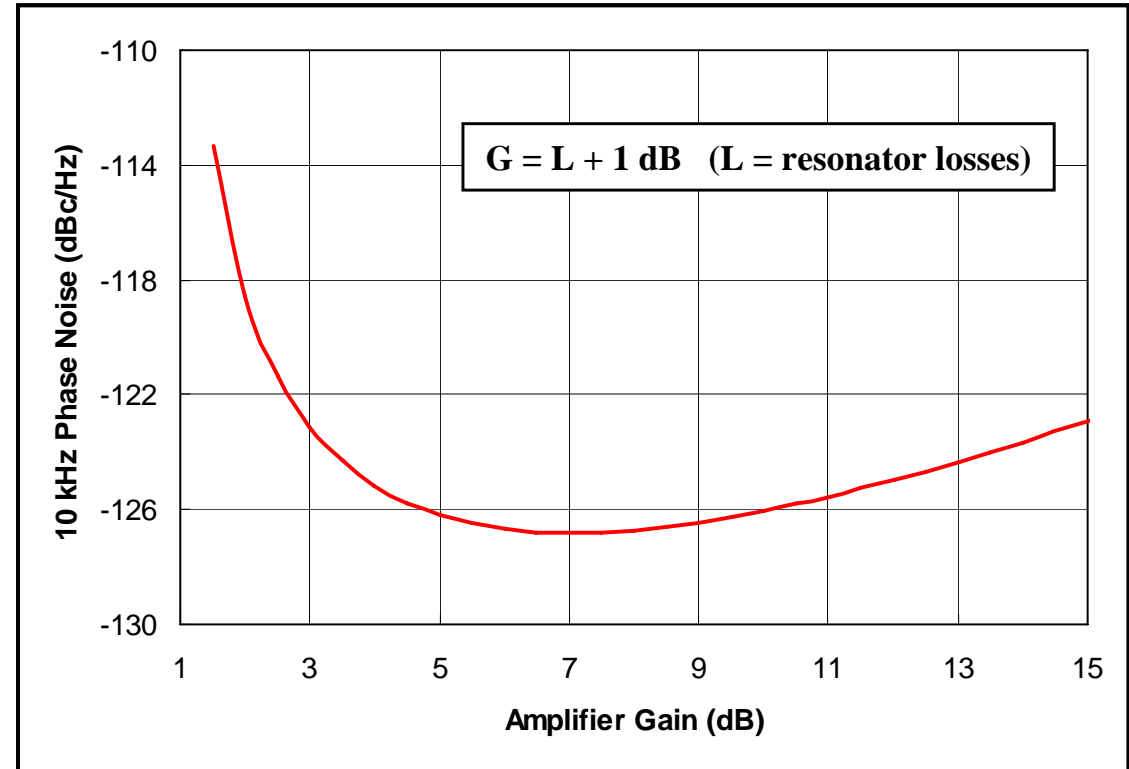

Oscillator phase noise versus amplifier gain, with a constant Noise Figure and at 1 dB compression ($f_o = 10 \text{ GHz}$, $Q_o = 10^4$)

$$L(f_m) \text{ in dBc/Hz} = 20 \log \left(\frac{f_0}{2 \sqrt{2} f_m Q_o} \frac{10^{\frac{G_o-1}{20}}}{10^{\frac{G_o-1}{20}} - 1} \right) + 10 \log \left(\frac{F k T_o}{P_{sat}} \right) + G_o$$

Phase noise optimisation

3) Problem of gain & phase noise trade-off

3.2) Conversion phase noise :

Gain matching, particularly at the transistor input, increases the LF noise conversion because of the resonant behaviour of the input nonlinear capacitance

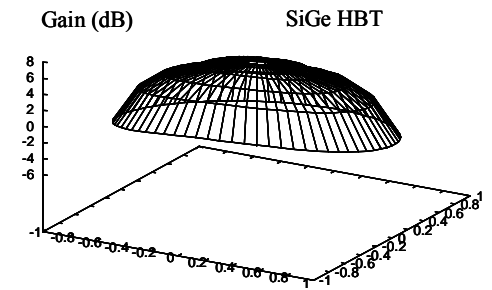
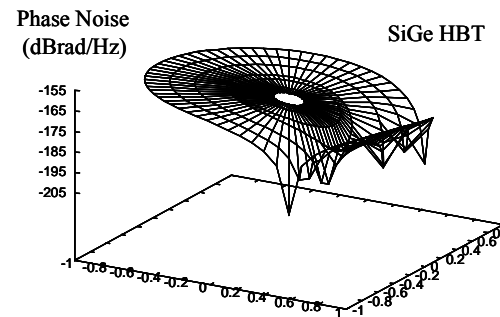
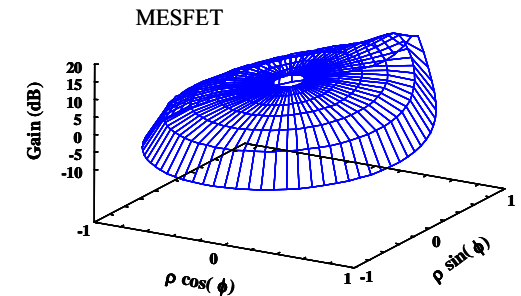
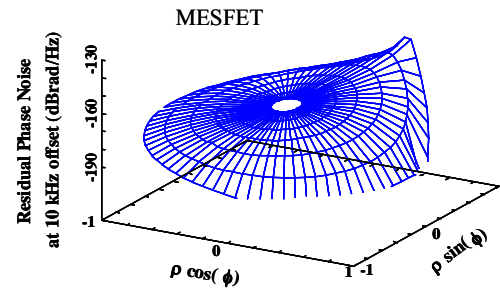

Juraver et al., 2000 EuMC (FET)

Régis et al., IEEE Trans. on MTT, oct. 1998 (Bipolar)

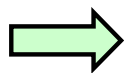
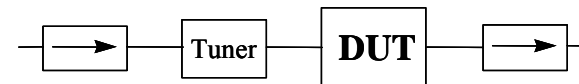

*It is almost impossible to get, with a one stage amplifier, both high gain and low phase noise
Equivalently, it is very difficult to reach low phase noise close to the device cut-off frequency*

Problem of gain & phase noise : two stages amplifier solution

- Theory :**
- 1) Conversion noise (1/f noise) is added : $\overline{\Delta\phi^2_{\text{two stages}}} = \overline{\Delta\phi^2_{\text{1rst stage}}} + \overline{\Delta\phi^2_{\text{2nd stage}}}$
 ➔ 3 dB increase of the 1/f noise
 in case of two stages working in the same conditions
 - 2) Additive noise is dominated by the first stage noise

1rst experiment :

Two identical SiGe HBTs between 50 Ω isolators

Gain @ 3.5 GHz = 14 dB

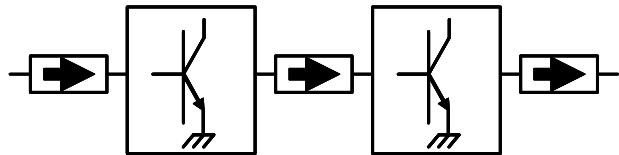

Comparison between phase noise of one stage and two stages amplifier, with identical devices and at the same input power (0 dBm) ➔

In this case : phase noise is dominated by the first stage amplifier, both for the 1/f noise or additive noise contributions

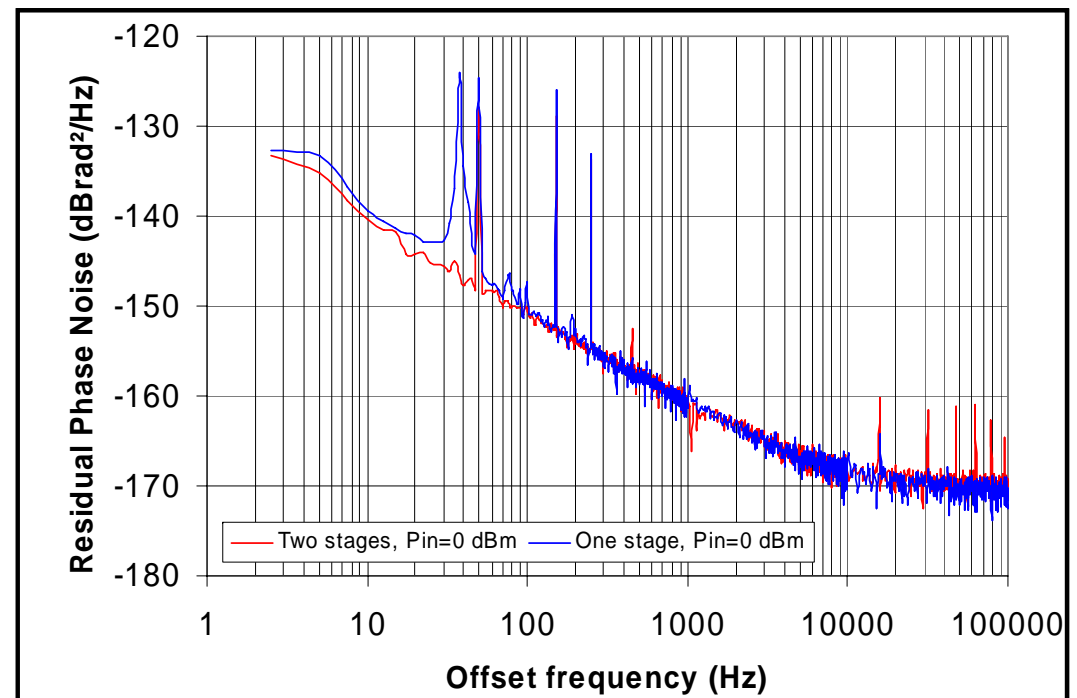

Problem of gain & phase noise : *two stages amplifier solution*

Prototype of a two stage amplifier for a 9.6 GHz application

SiGe HBT + Si BJT

8.2 dB Power Gain

-163 dBrad²/Hz @ 10 kHz

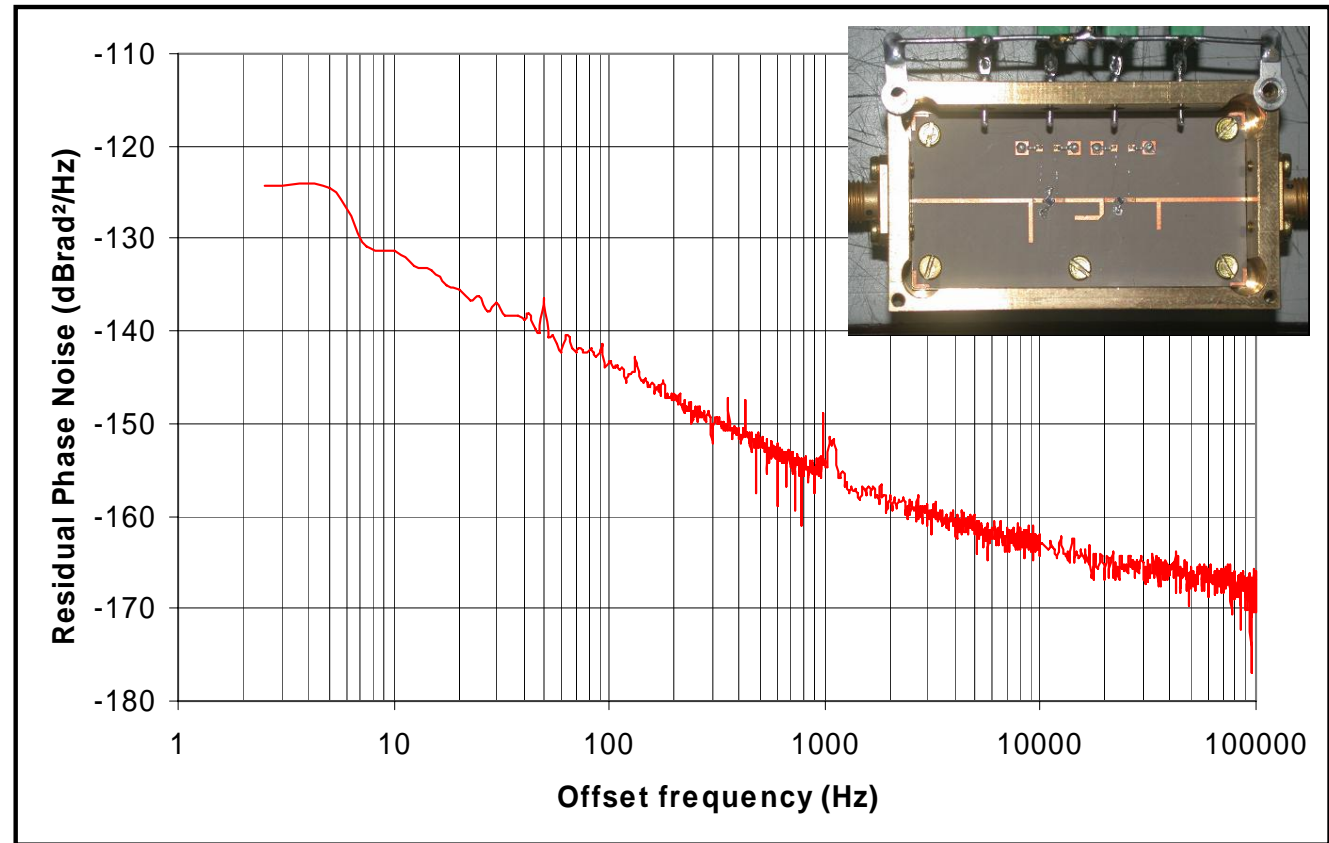

$$L(f_m) \text{ in dBc/Hz} = 20 \log \left(\frac{f_0}{2\sqrt{2} f_m Q_0} \frac{10^{\frac{L}{20}}}{10^{\frac{L}{20}} - 1} \right) + S_{\Phi} \text{ amplifier in dBrad}^2 / \text{Hz}$$

$$Q_0 = 2 \cdot 10^5 \quad L = 6 \text{ dB}$$

Application :

Ultra low phase noise X band sapphire oscillator

-152 dBc/Hz @ 10 kHz offset predicted

S. Gribaldo et al. 2005 EFTF and IEEE Freq. Control Symp

The evolution of HF resonators for oscillator stabilisation

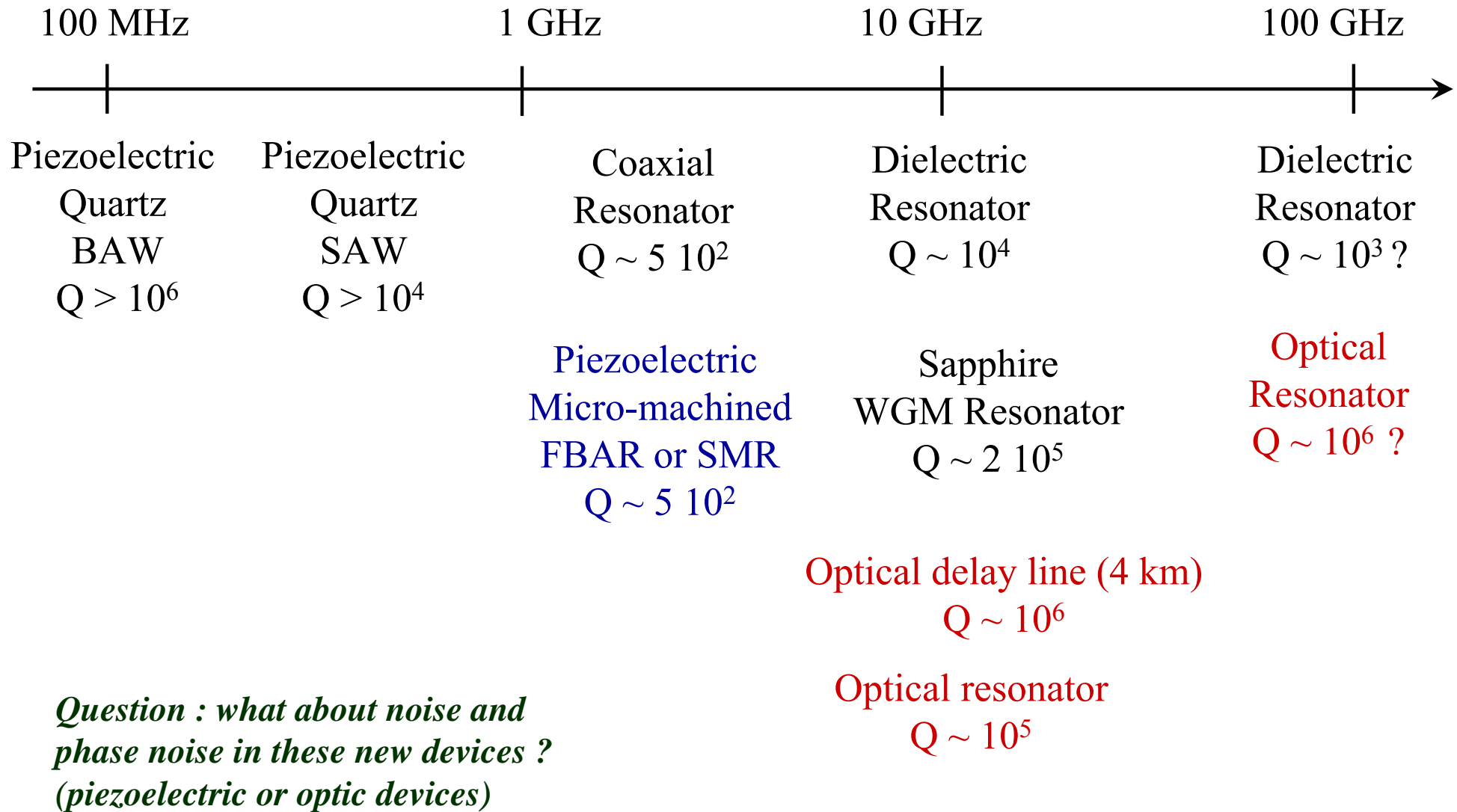

Phase noise in resonators : *micro-machined piezoelectric resonators*

Investigating the frequency and phase fluctuations of FBAR resonators for MMIC applications

FBAR = Film Bulk Acoustic Resonator

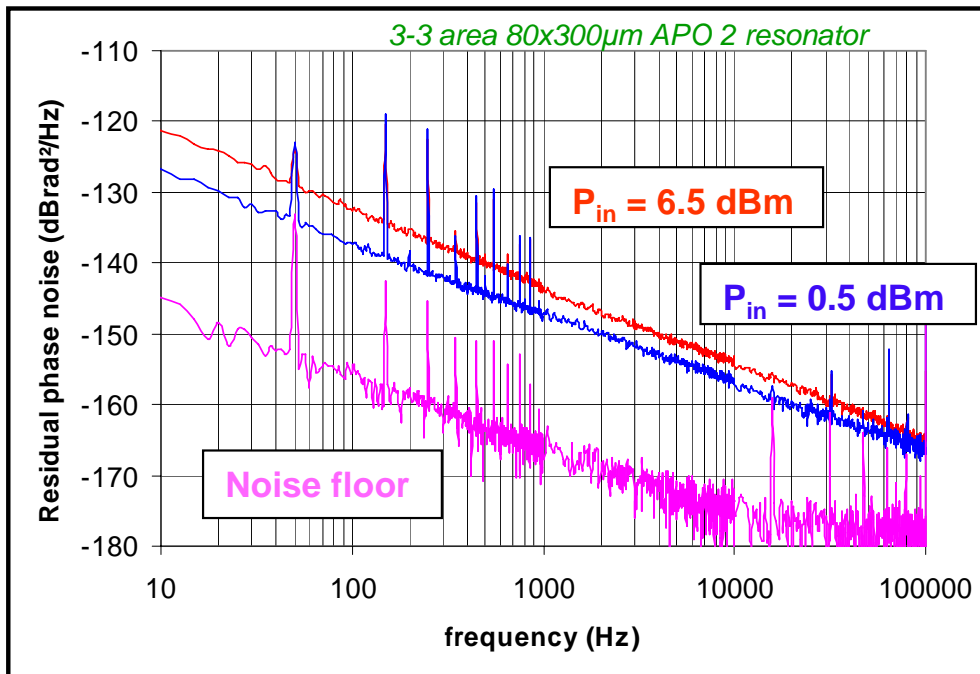

Evidence of a RF power dependent (\leftrightarrow nonlinear) close to 1/f phase fluctuation through the resonator

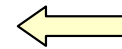

This 1/f phase fluctuation of the signal is caused by a 1/f fluctuation of the resonator center frequency

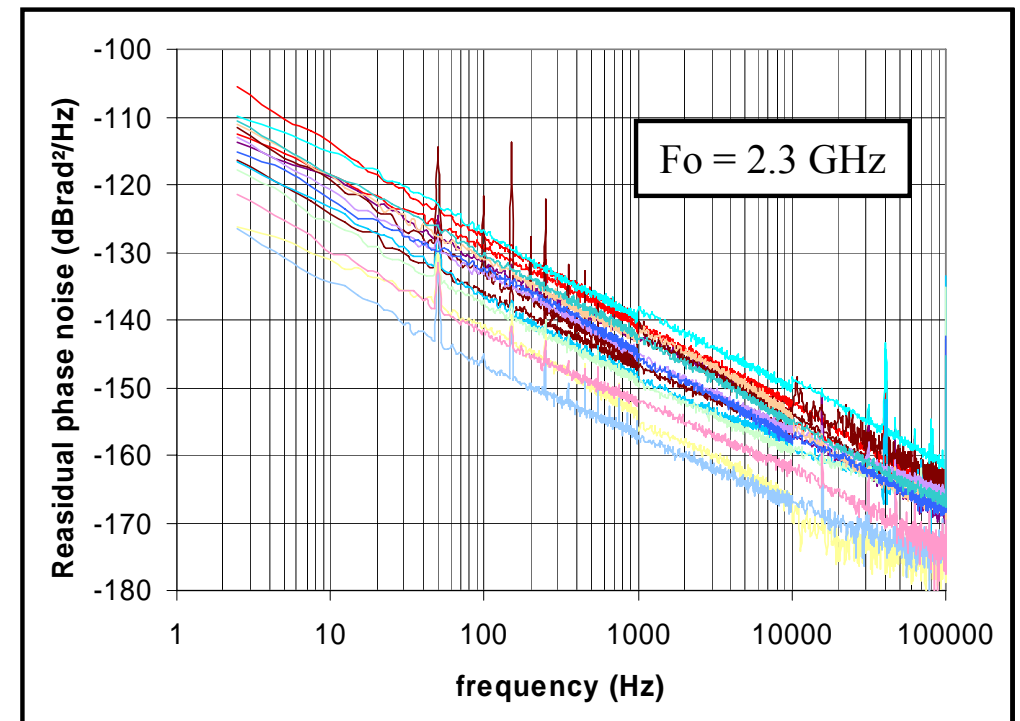

Phase noise measurement, using a probe test set, of 14 resonators with different geometries integrated above IC on Silicon substrate

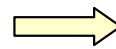

Evidence of a large dispersion of the results

Phase noise in resonators : *micro-machined piezoelectric resonators*

Phase noise measurement of an integrated 5 GHz FBAR oscillator

→ evidence of the main influence of the resonator 1/f noise

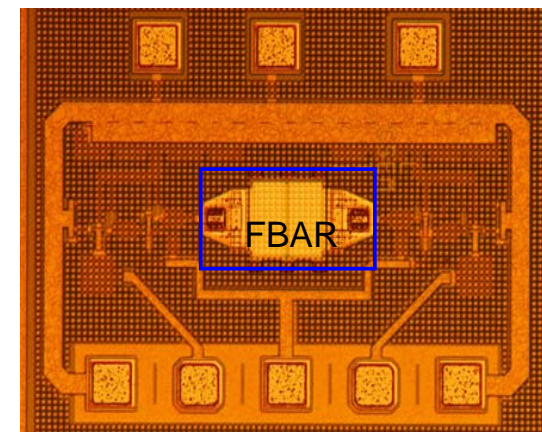
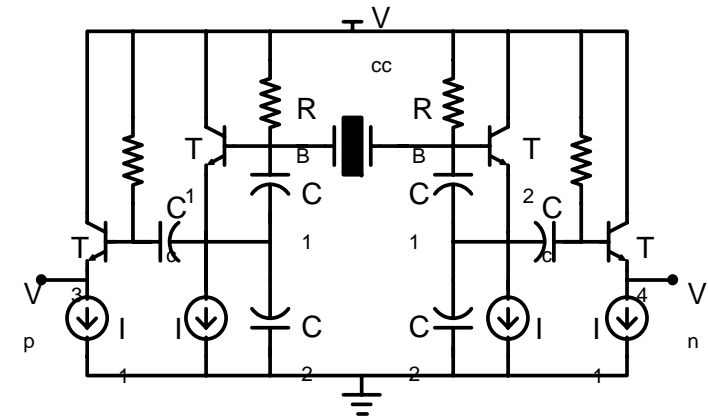
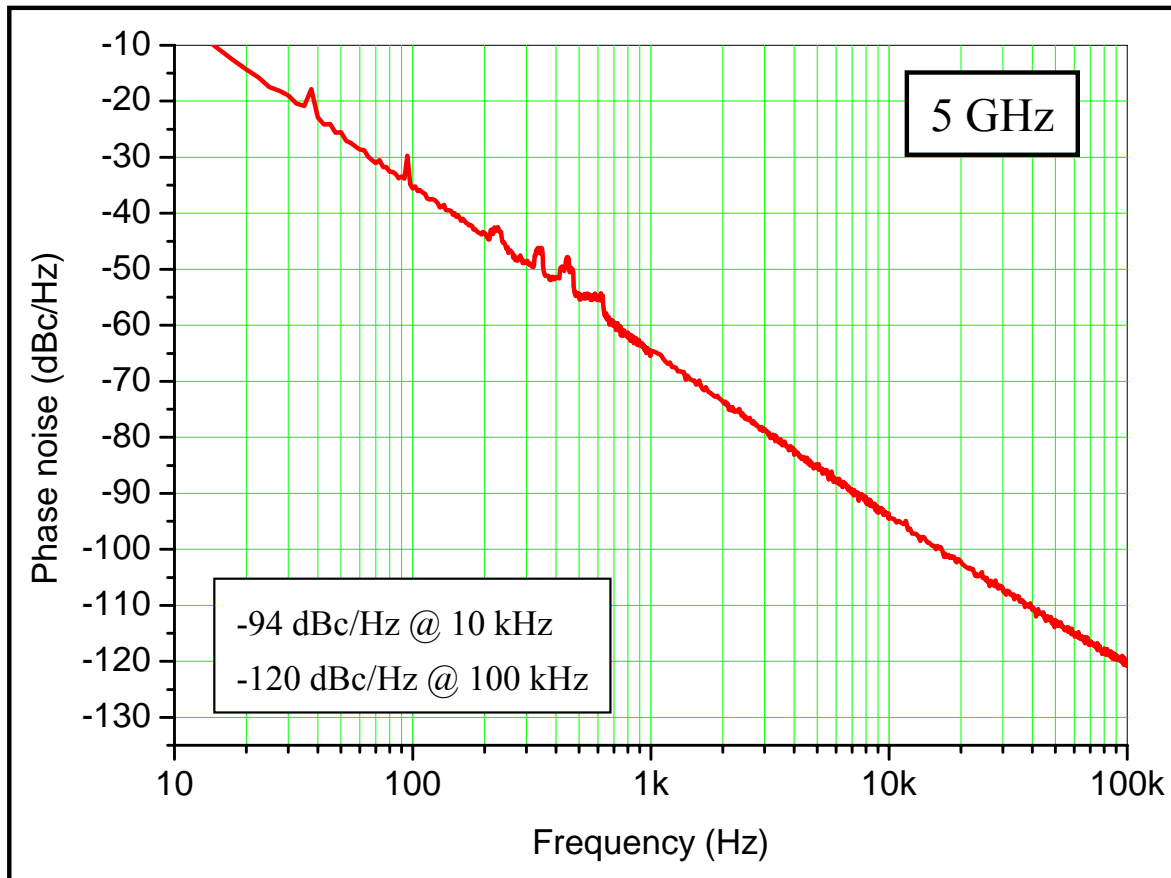

M. Aissi et al., 2006 IEEE ISSCC

Phase noise in resonators : *optical devices for microwave applications*

Example of an optical-microwave oscillator

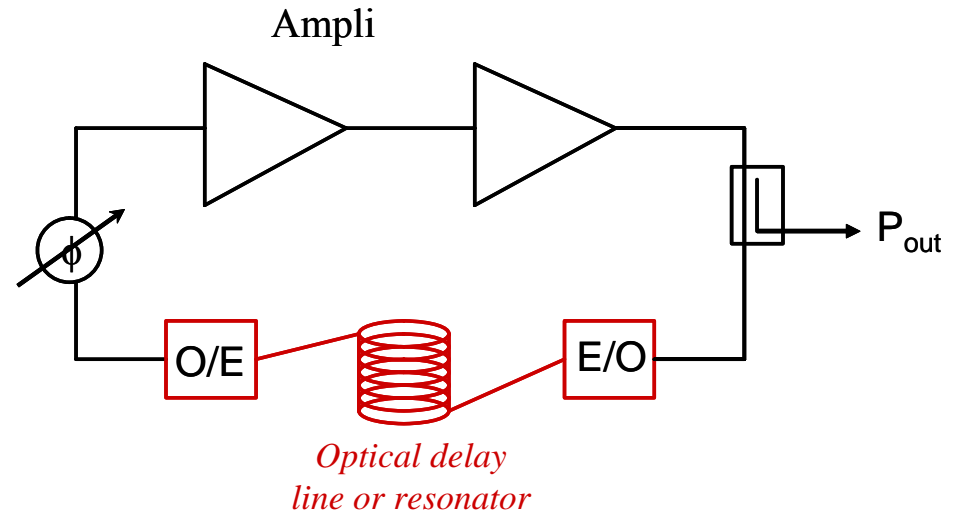
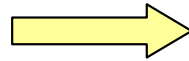

In these applications, the phase noise comes both from the RF amplifiers and from the optical to microwave or microwave to optical conversions - it may also be generated in long fiber optics delay lines (above ~ 5 km)

Optical to microwave \longrightarrow laser noise (RIN)

Microwave to optical \longrightarrow photodiode noise

Phase noise in resonators : *optical devices for microwave applications*

Example :

Phase noise of different optical links at microwave frequencies (output at X band)

1) *Noise floor*

well predicted with analytical equations

2) *“1/f” contribution*

surprisingly low

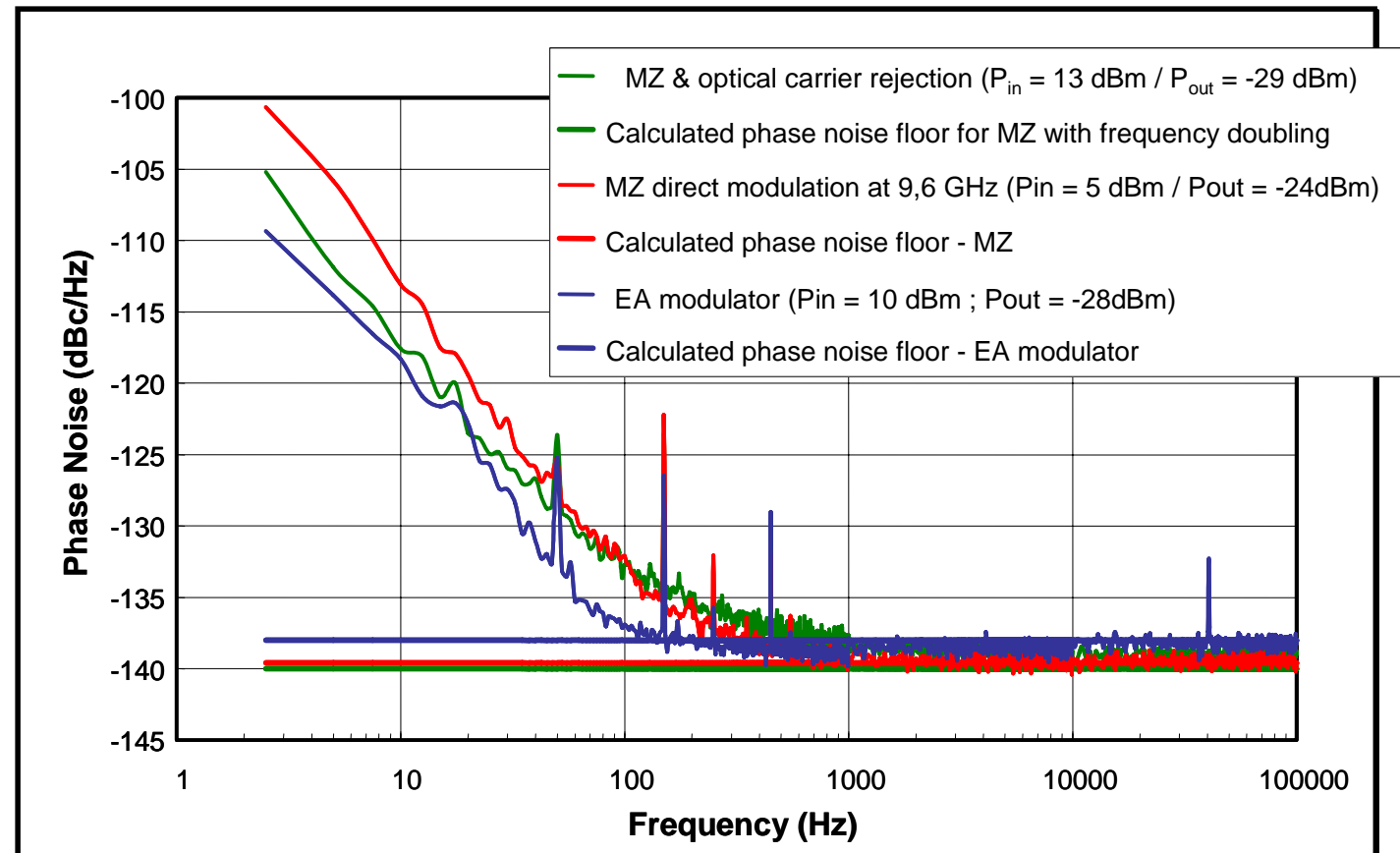

Analytical modeling :

$$CNR = \frac{P_{det}^2 \cdot S^2 \cdot m^2}{2 \cdot (P_{det}^2 \cdot S^2 \cdot RIN + 2 \cdot q \cdot (S \cdot P_{det} + i_{obs}))}$$

$$S_{\phi input} = K \cdot \frac{RIN_{LF_0}}{f_m} + \frac{1}{(2 \cdot CNR)}$$

B. Onillon et al. 2005 IEEE Freq. Control Symp

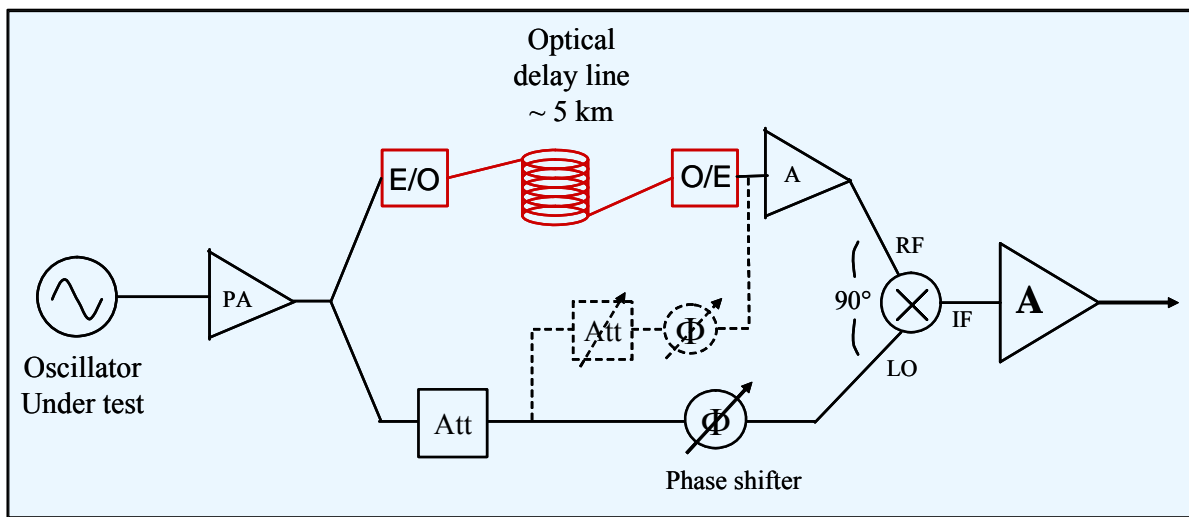

Application example :

**Ultra high sensitivity
delay line microwave
frequency discriminator**

Possible use :

Phase noise metrology

Radar

**May be telecommunications
if the delay can be integrated
(resonator instead of a delay
line)**

*B. Onillon et al., 2005
IEEE Int. Freq. Control Symp.*

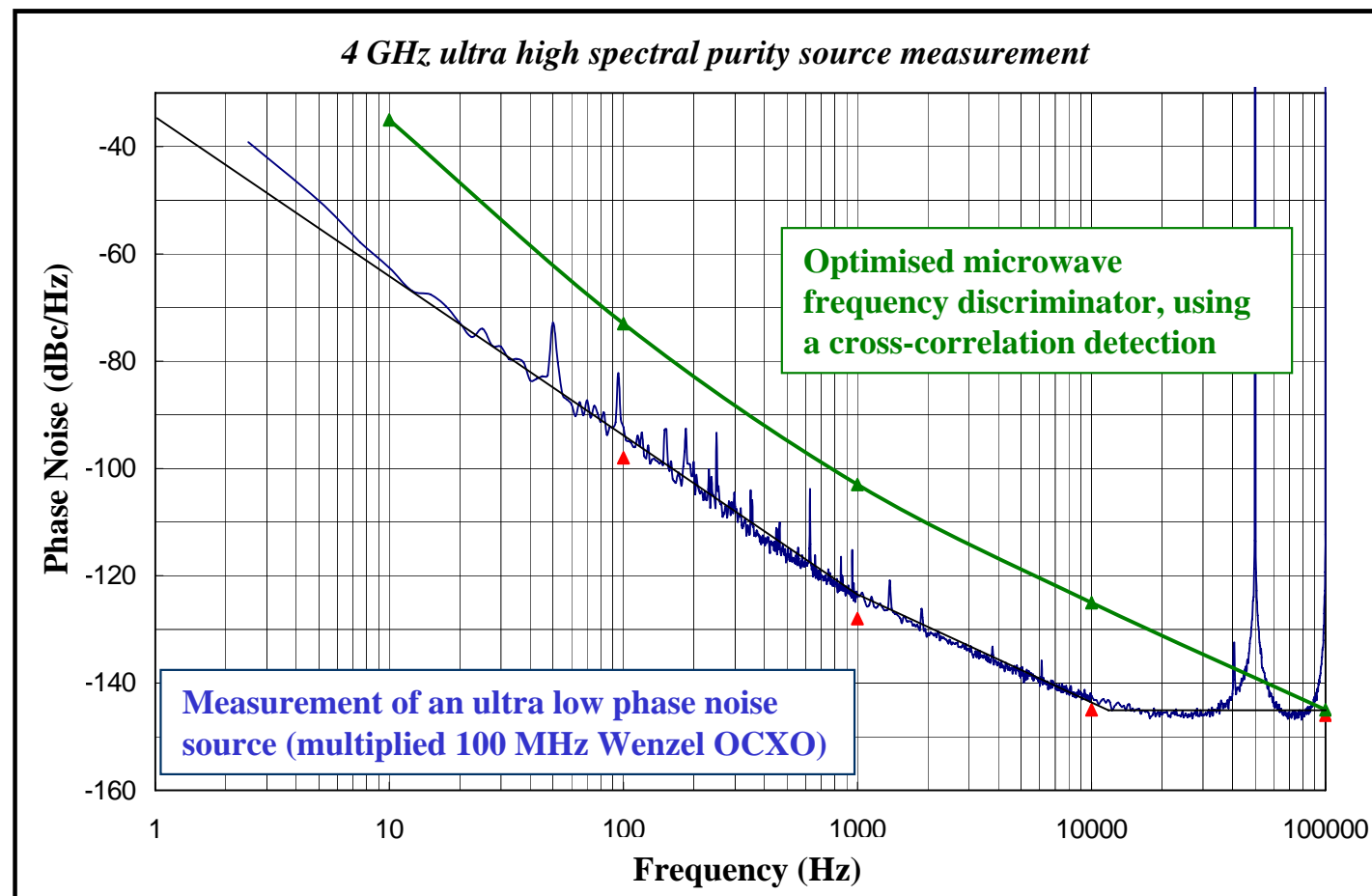

Conclusion

Residual phase noise measurement

⇒ *An efficient tool for fundamental investigations on nonlinear noise*

Amplifier phase noise modelling – the problem of conversion noise

⇒ *Nonlinear noise source or external RF power dependent noise source*

Gain and phase noise trade-off

⇒ *Investigations on two stages amplifiers*

Phase noise in new devices for frequency stabilization at microwave frequencies (piezoelectric or optical resonators)

⇒ *A new field of investigation*