



HAL
open science

Organic carbonates synthesis improved by pervaporation for CO₂ utilisation

Marie Décultot, Alain Ledoux, Marie-Christine Fournier-Salaün, Lionel Estel

► **To cite this version:**

Marie Décultot, Alain Ledoux, Marie-Christine Fournier-Salaün, Lionel Estel. Organic carbonates synthesis improved by pervaporation for CO₂ utilisation. *Green Processing and Synthesis*, 2019, 8 (1), pp.496-506. 10.1515/gps-2019-0018 . hal-02328173

HAL Id: hal-02328173

<https://hal.science/hal-02328173v1>

Submitted on 25 Jun 2024

HAL is a multi-disciplinary open access archive for the deposit and dissemination of scientific research documents, whether they are published or not. The documents may come from teaching and research institutions in France or abroad, or from public or private research centers.

L'archive ouverte pluridisciplinaire **HAL**, est destinée au dépôt et à la diffusion de documents scientifiques de niveau recherche, publiés ou non, émanant des établissements d'enseignement et de recherche français ou étrangers, des laboratoires publics ou privés.

Marie Décultot, Alain Ledoux, Marie-Christine Fournier-Salaün and Lionel Estel

Organic carbonates synthesis improved by pervaporation for CO₂ utilisation

<https://doi.org/10.1515/gps-2019-0018>

Received September 14, 2018; accepted February 21, 2019.

Abstract: This work is focused on the synthesis of organic carbonates from CO₂ and ethanol. A parametric study of the synthesis of diethyl carbonate from ethanol is performed in a 100 mL batch reactor. The influence of pressure and temperature is studied and we prove that the presence of water strongly decreases the yield in diethyl carbonate as an equilibrium is quickly reached. One method to improve this yield is to remove water from the reaction mixture to shift the equilibrium toward the formation of carbonates. The chemical methods give good results but separation and regeneration associated steps are prohibitive. For these reasons, a physical technique like pervaporation is chosen to remove water. The study of a pervaporation cell with membrane PERVAP 4100 gives good results for the dehydration of ethanol alone even at low concentrations of water from 0.33 %wt to 0.15 %wt. Twelve experiments on the dehydration of a mixture of ethanol, diethyl carbonate and water are performed. The calculated separation factors show a very good selectivity for water. That means that even in the presence of diethyl carbonate, the membrane has still a selective water permeability.

Keywords: CO₂ utilisation; pervaporation; organic carbonates; dehydration

List of abbreviations

<i>A</i>	Pre-exponential factor (g/h/m ²)
<i>D</i>	Membrane diffusion coefficient (m ² /s)
<i>E</i>	Activation energy (J/mol)
<i>J</i>	Flux (g/h/m ²)
<i>j</i>	Flux (m ³ (STP)/m ² /s)
<i>K</i>	Sorption coefficient (m ³ (STP)/m ³ /bar)
<i>l</i>	Membrane thickness (m)

* Corresponding author:

Marie Décultot, Alain Ledoux, Marie-Christine Fournier-Salaün and Lionel Estel, Normandie Univ, INSA Rouen, UNIROUEN, Laboratoire de Sécurité des Procédés Chimiques LSPC EA 4704, 76000 Rouen, France, e-mail: marie.decultot@insa-rouen.fr; alain.ledoux@insa-rouen.fr; marie-christine.fournier@insa-rouen.fr; lionel.estel@insa-rouen.fr

<i>M</i>	Molecular weight (g/mol)
<i>P</i>	Permeability (m ³ (STP)m/m ² /s/bar)
<i>p</i>	Partial pressure (bar)
<i>p^{sat}</i>	Saturation vapour pressure (bar)
<i>R</i>	Ideal gas constant (J/mol/K)
<i>T</i>	Temperature (K)
<i>v^G</i>	Molar volume of gas (m ³ /mol)
<i>x</i>	Liquid molar fraction (-)
<i>y</i>	Vapour molar fraction (-)
<i>α</i>	Selectivity (-)
<i>γ</i>	Activity coefficient (-)

1 Introduction

With 34 Gt emitted per year, carbon dioxide is the most human emitted greenhouse gases in the world. The elevation of the global temperature can reach up +5°C in 2100 if these emissions are not limited and the global warming effects on the earth could be irreparable [1]. For these reasons, carbon capture and storage is still an important topic [2]. This observation also stimulates a more rational use of carbon atoms, where CO₂ becomes a resource to be valued. In a circular economy perspective, a new chemistry using CO₂ is developing the reuse of CO₂, which becomes a source of carbon [3]. Moreover, considering the rarefaction and the cost of fossil fuels, the use of bio-based reactants has to be done to develop new processes.

In this context, our work is focused on the synthesis of organic carbonates by associating CO₂ with ethanol. Because of their low toxicity, organic carbonates have many potential applications like fuel additive, solvent or monomer [4]. Currently, they are produced by using some toxic and harmful components like phosgene. The synthesis via the route “CO₂ + alcohol” has proven to be the most interesting one with regard to the environmental aspect and the sequestration of CO₂ [5]. Compared to other reactions of CO₂ valorisation, organic carbonates represent the most important value added products and the market is around one million tons annually [6]. Figure 1 represents an example of the potential reactions: the synthesis of diethyl carbonate from CO₂ and bioethanol.

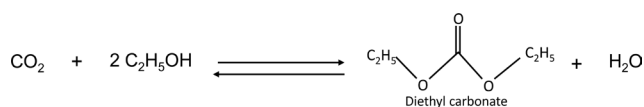

Figure 1: Ethanol carbonation with CO₂.

Because of the unfavourable thermodynamics of the reaction, the yield of carbonate is still low [7]. A lot of researches have been done to develop new performant catalysts [7,8]. Researches began with homogeneous catalysts mainly based on metal like titanium, zirconium and niobium. Nowadays, most of articles are based on heterogeneous catalysts, which are more advantageous for industrial applications. Zirconium oxide and cerium oxide are the most used one. Tomishige et al. were the first to highlight the potential of ZrO₂ with a selectivity of 100% [9]. Similar selectivities are obtained with CeO₂. The good results obtained are mainly due to the amphoteric properties of these two catalysts. Indeed, both of them have acid and base sites which are essential for the synthesis of carbonates [10]. By changing the shape or the calcination temperature of these catalysts, it is possible to increase the quantity of these sites to improve the yield in carbonates [10,11]. Some authors improve the yield by adding some Brønsted acid sites on the catalyst by using H₃PO₄/ZrO₂ [12] or H₃PW₁₂O₄/ZrO₂ [13]. Even if new catalysts are developed to improve yields in carbonates, yields are still low because thermodynamic equilibrium exists between reactants and products of the reaction.

A dehydration of the reaction medium can improve the yield. Indeed, by removing molecules of water produced during the reaction, chemical balance promotes reaction product formation and the production of carbonate is improved. The reactive dehydration is the most used method in the literature. A dehydrating agent is added in the reaction mixture to react with water molecules. Recently, the addition of 2-cyanopyridine has been proved to improve the yield in dimethyl carbonate [14]. Even if this dehydration method can improve the yield, it raises some issues like the separation and the recycling of the 2-cyanopyridine and the molecule produced. Beside to this chemical route, a physical dehydration route has to be developed.

Our work involves the use of a physical way to dehydrate called pervaporation. In this separation process, a liquid mixture is circulated on a dense membrane and the downstream side is kept under vacuum [15]. In our case, we used an hydrophilic membrane which separates selectively the water from the reaction mixture. This reputed low energy consuming process is

advantageous because no chemical reactive is added, so no additional problem of separation is introduced. The main industrial application of pervaporation is the dehydration of organic solvents, especially the production of anhydrous ethanol for the pharmaceutical industry [16]. A lot of researches have been done to improve the performance of the membrane to dehydrate solvents [17,18]. Pervaporation is also used in membrane reactors to remove water from the reaction mixture in case of reactions with thermodynamic limitations or if the water inhibits the catalyst [19]. The most developed example is the dehydration of the reaction of esterification [20]. Only few articles present results about the association of the reaction of carbonation with a dense or porous separation membrane [21-25]. Related experiments prove that this separation method is efficient but needs more studies. For example, Dibenedetto et al. increase the yield in diethyl carbonate from 0.9% to 2.3% by using pervaporation [21]. Kuenen et al. do a modelling on Aspen of a complete process with the catalytic membrane reactor and purification units of the products [23]. They conclude that this process is not viable economically and in term of CO₂ emission but they does not have enough data on the kinetics of the reaction and on the efficiency of the membrane separation. In an opposite way, Aresta et al. make an economical study to compare different ways of dehydrating this reaction mixture and they prove that pervaporation can be the most interesting way to dehydrate this kind of reaction mixture in term of energy saving and CO₂ emission [24].

In this article, we present the results obtained on the carbonation reaction and on the pervaporation separately. A parametric study has been done on the synthesis of diethyl carbonate (DEC). Some studies deal with the production of DEC from CO₂ and ethanol [26] but this synthesis is less studied in the literature than the synthesis of dimethyl carbonate. However, Shulka et al. show in a recent study the growing interest of this molecule and highlight the lack of data for its synthesis [27]. From the previous literature review, an heterogeneous catalyst is needed for the carbonation reaction. In our study, cerium oxide catalyst has been used because of its selectivity, cheapness, availability and low toxicity [28]. For the pervaporation part, a commercial membrane has been tested with different model solutions. These solutions are made of ethanol, DEC and very low amount of water, which can also potentially exist in the reactor. From our knowledge, no data is available on the study of this ternary mixture. The objective is to show the influence of the presence of DEC on the separation.

2 Materials and methods

2.1 Materials

Cerium (IV) oxide with a purity of 99.5% was purchased from Alfa Aesar. This catalyst was calcined at 600°C during 4 h in the air. Absolute ethanol (>99.7%) was purchased from VWR and diethyl carbonate from Alfa Aesar (>99%). Ethanol and diethyl carbonate were used as received.

2.2 Reactor unit

The parametric study of the reaction has been done in a Parr autoclave with a capacity of 100 mL represented in Figure 2. It is composed with a blade agitator, a valve to take samples during the reaction and two valves to add or remove CO₂. The temperature is controlled and the pressure is read on a pressure gauge. For a typical experiment, 50 mL of ethanol are filled in the reactor with 2 g of CeO₂. A test of pressure is made with nitrogen at 60 bar during 30 min. Then, the reactor is purged three times with CO₂. After that, the CO₂ is filled at the desired pressure by waiting for its solubilisation in ethanol during 45 min. The temperature is then increased up to the desired temperature. 1 mL of sample is taken at selected times during the reaction. At the end of the reaction, the reactor is cooled down and the pressure is decreased. Samples are diluted in methanol with hexanol as an internal standard and they are analysed by gas chromatography with a FID detector. Table 1 presents the reaction operating conditions used for the experiments.

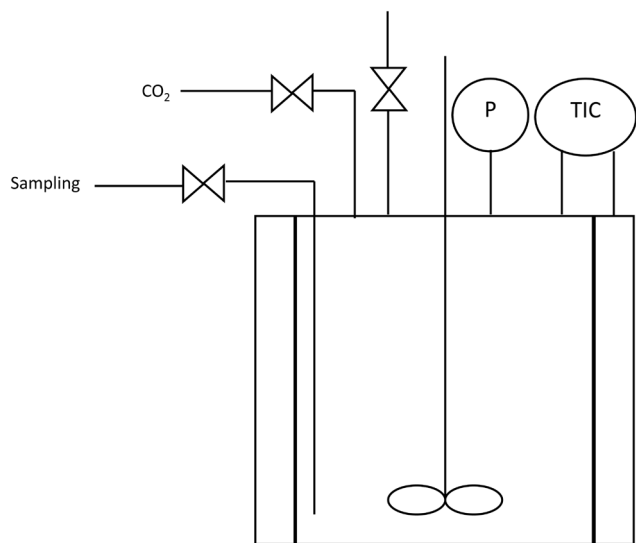

Figure 2: Scheme of the reactor used for the carbonation.

Table 1: Experimental conditions for reactions of carbonation of ethanol with 2 g of CeO₂ during 24 h.

Experiments	Temperature (°C)	Pressure (bar)	initial water content (%wt)
R1	110	11	
R2	110	18	
R3	110	28	
R4	110	36	
R5	110	52	
R6	110	66	
R7	92	48	
R8	101	50	
R9	112	53	
R10	118	55	
R11	125	58	0.080
R12	125	58	0.050
R13	125	58	0.163
R14	125	58	0.262
R15	125	58	0.264

2.3 Pervaporation experiments

The process used to study the pervaporation is shown schematically in Figure 3. The pervaporation cell and the membrane PERVAP 4100 were supplied from DeltaMem [29]. A porous steel plate is placed in one part of the pervaporation cell, and the membrane is placed on it. The two parts of the cell are then closed and an O-ring in EPDM is used to ensure no leakage between the feed part and the permeate part. The area of the membrane is 0.016 m². The heated and agitated feed (around 1 L) is circulated at 444 mL/min in the pervaporation cell with a feed pump. A thermometer is placed before the pervaporation cell to control the temperature. The permeate side pressure is maintained at 2 mbar with a vacuum vane pump and the permeate is condensed in two cold traps immersed in liquid nitrogen. For a typical experiment, the feed is heated at the desired temperature. Then it is circulated on the pervaporation cell and the permeate is condensed in a first cold trap. After 1 h of circulation, the steady state is obtained because the temperature in the cell is constant, the permeate is condensed in the second cold trap and the experiment begins. At the end of the experiment, the circulation flow is stopped and the feed is cooled down. The vacuum pump is stopped and the permeate is recovered in the second cold trap. The permeate and the feed are weighted and analysed. The amount of ethanol and DEC are analysed by a gas chromatograph with a FID detector with an accuracy of 2% and the amount of water is determined by a Karl Fischer titration with a coulometric method for concentration below 1 %wt and a volumetric method for higher concentrations. Accuracies of these

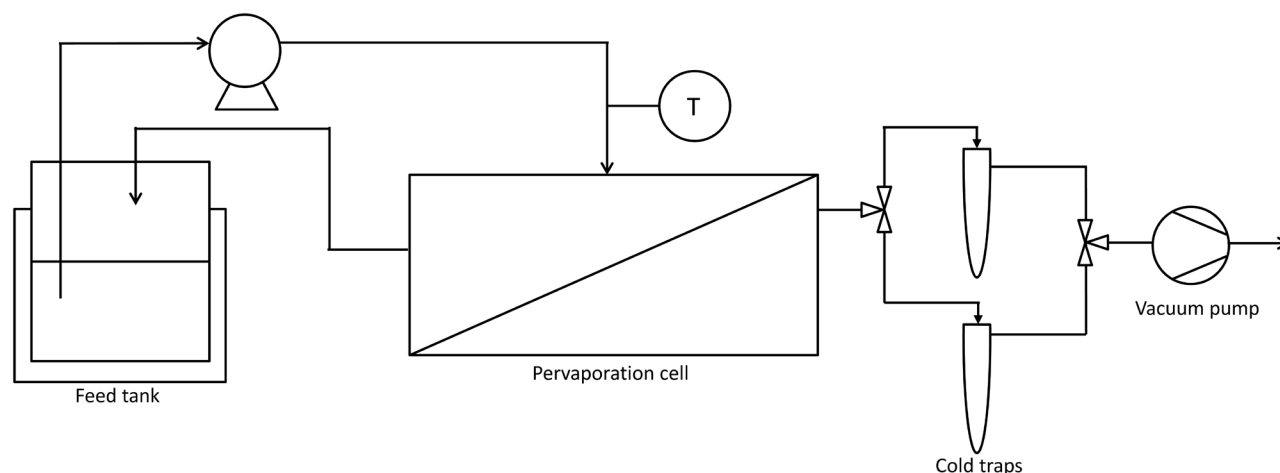

Figure 3: Scheme of the pervaporation process.

Table 2: Experimental conditions for pervaporation.

Experiments	Temperature (°C)	Time (h)	initial water content (%wt)	initial DEC content (%wt)
P1	67	16	0.33	0
P2	73	16	0.33	0
P3	77	16	0.33	0
P4	83	16	0.33	0
P5	87	16	0.33	0
P6	87	6	0.20	0
P7	87	5	0.33	0
P8	87	6	0.20	1
P9	87	5	0.33	1
P10	87	6	0.20	3
P11	87	5	0.33	3
P12	87	6	0.20	5
P13	87	5	0.33	5
P14	87	6	0.20	10
P15	87	5	0.33	10
P16	87	6	0.20	15
P17	87	5	0.33	15

two methods are respectively 10% and 2%. The amount of permeate removed by the membrane was below 0.1% of the volume of the feed in order to keep the concentration in the feed almost constant. Table 2 presents the operating conditions used to study the pervaporation process.

3 Results and discussion

3.1 Parametric study of the reaction

Figure 4 represents the evolution of the amount of diethyl carbonate (DEC) as a function of the pressure in the

reactor. Reactions are performed at 110°C during 24 h. Between 10 bar and 40 bar, the conversion of ethanol in DEC increases. For pressure higher than 40 bar, the conversion seems to be constant or even to decrease. This behaviour was reported in the literature in the case of the carbonation of methanol [13].

Figure 5 shows the influence of temperature on the conversion of ethanol in DEC. For these reactions, CO₂ is introduced until a constant pressure of 24 bar is obtained after dissolution of CO₂ in ethanol. Then, the reactor is heated at the desired temperature. Samples have been taken as a function of time to study the evolution of the yield during the time. It can be seen that the conversion seems to increase quickly at the beginning and seems to stabilize after 20 h. This evolution of reaction as a function of time is similar to the case of methanol in literature [30]. The conversion of ethanol increases with the temperature between 95°C and 125°C. This behaviour is also seen in literature for the carbonation of methanol but with higher temperature, the yield may decrease. Indeed, the reaction is exothermic so this decrease can be due to the reaction thermodynamics [31,32]. Although temperature can improve conversion, the yield of DEC seems to have a limited value.

The influence of the initial presence of water in the reaction medium has been also tested. The reactions were performed at 125°C with 24 bar of CO₂ and different amounts of water were added at the beginning of the reaction. As we can see in Figure 6, the presence of water decreases the yield. Indeed, from 0.050 %wt of water to 0.264 %wt of water, the yield is reduced by half. This conclusion proves that it is necessary to dehydrate the reaction mixture to improve the yield.

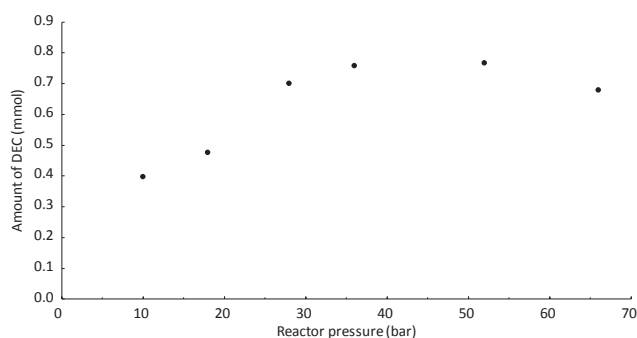

Figure 4: The dependence of the pressure on the amount of DEC produced.

Ethanol: 50 mL, CeO₂: 2 g, temperature: 110°C, reaction time: 24 h.

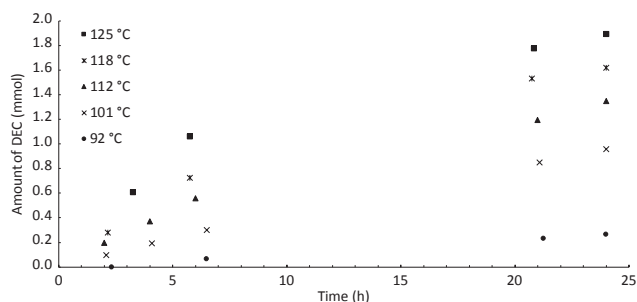

Figure 5: Evolution of amount of DEC produced as a function of time for different reactor temperatures.

Ethanol: 50 mL, CO₂: 24 bar, CeO₂: 2 g.

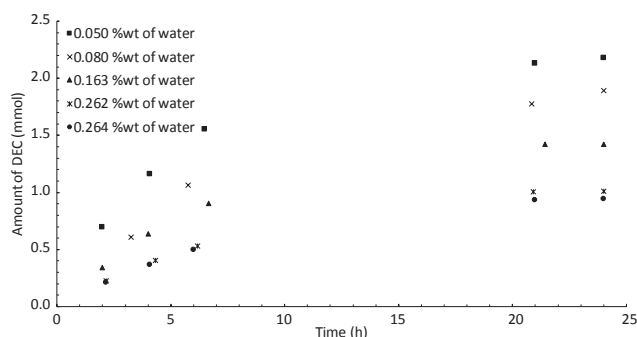

Figure 6: Influence of the initial water concentration on the amount of DEC produced during the reaction.

Ethanol: 50 mL, CeO₂: 2 g, CO₂: 24 bar, 125°C.

3.2 Dehydration of a ternary mixture ethanol-DEC-water by pervaporation

Classical dehydrations of ethanol by pervaporation are made with amounts of water higher than 1 %wt [17]. In our case, at the end of a typical reaction, the amount of water is lower than 0.30 %wt. To understand the behaviour of the membrane for such low amounts of water, some tests were performed to dehydrate ethanol-water solution with a little amount of water. Figure 7

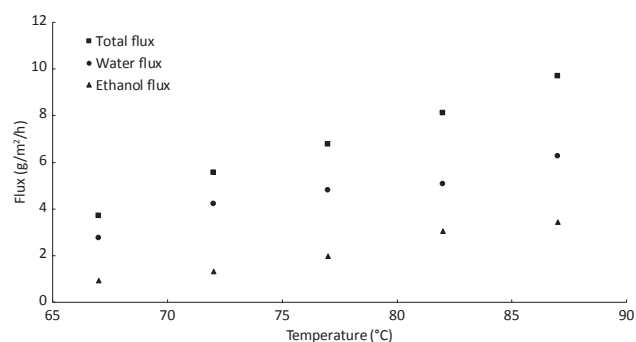

Figure 7: Influence of temperature on the flux for ethanol-water solution with 0.33 %wt of water.

represents results of experiments on the influence of temperature with 0.33 %wt of water in the feed. The flux corresponds to the weight of permeate divided by the time of the experiment and the membrane surface. The accuracy of the calculated flux is around 5%. It can be seen that temperature has an important impact on the flux. Indeed, between 67°C and 87°C the total flux increases from 4 g/m²/h up to 10 g/m²/h. The mass transfer through the membrane can be described by Arrhenius-type laws shown in Eq. 1 [15].

$$J_i = A_i \exp\left(\frac{-E_i}{RT}\right) \quad (1)$$

where J_i represents the flux of the component i in g/m²/h, A_i is the pre-exponential factor in g/m²/h, E_i is the activation energy in J/mol. For our case, Figure 8 represents the logarithm of the water and the ethanol flux as a function of the inverse of the temperature. The results show that the mass transfer obeys to an Arrhenius law. The activation energy of water is smaller (37 kJ/mol) than the one of ethanol (69 kJ/mol). We can conclude that the flux increases with the temperature but the selectivity seems to decrease. To understand this phenomenon, we analysed the influence of temperature on the behaviour of the membrane and on the pressure gradient. Indeed, we can describe the flux with solution-diffusion model [33]:

$$j_i = \frac{D_i K_i}{l} (p_{i,feed} - p_{i,permeate}) = \frac{P_i}{l} (p_{i,feed} - p_{i,permeate}) \quad (2)$$

where D_i is the membrane diffusion coefficient and K_i the sorption coefficient of component i . P_i is the permeability, which represents the combination of the two effects of sorption and diffusion. l is the membrane thickness and P_i/l is called the permeance. $p_{i,feed}$ and $p_{i,permeate}$ represent the pressure of component i respectively in the feed

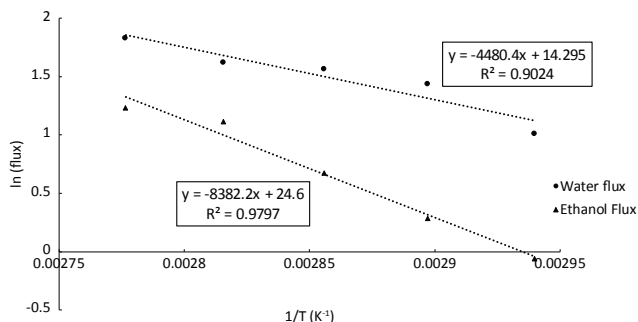

Figure 8: Logarithm of water and ethanol flux against the inverse of temperature.

and in the permeate. With this model, the flux can be represented by the product of the permeance, which is related to the intrinsic properties of the membrane, and the activity gradient, which is the difference of pressure between the two parts of the membrane. We can calculate the two pressures with Eq. 3 and 4:

$$p_{i\text{ feed}} = \gamma_i x_i p_i^{\text{sat}} \quad (3)$$

$$p_{i\text{ permeate}} = y_i p_{\text{permeate}} \quad (4)$$

γ_i is the activity coefficient (obtained by NRTL model), x_i is the liquid molar fraction and p_i^{sat} is the saturation vapour pressure of the component i in the feed liquid. y_i is the vapour molar fraction of component i in the permeate and p_{permeate} is the pressure in the permeate side. We can calculate the permeance by using Eq. 5:

$$\frac{P_i}{l} = \frac{j_i}{p_{i\text{ feed}} - p_{i\text{ permeate}}} \quad (5)$$

j_i is the molar flux in $\text{m}^3(\text{STP})/\text{m}^2\text{s}$ and is calculated with Eq. 6:

$$j_i = J_i \frac{V_i^G}{M_i} \quad (6)$$

V_i^G is the molar volume of gas i ($0.0224 \text{ m}^3(\text{STP})/\text{mol}$) and M_i is the molecular weight of component i . In that case, the permeance P_i/l can be expressed in gpu (gas permeation unit, $1 \text{ m}^3/\text{m}^2 \text{ s kPa} = 1.33 \times 10^8 \text{ gpu}$).

Figure 9 represents the permeance and the pressure gradient of water and ethanol as a function of the temperature between 67°C and 87°C . We can see that for both water and ethanol, the gradient of pressure increases with temperature which is consistent because the partial pressure of each component in the feed increases with temperature. The pressure gradient is 100 times higher

for ethanol than for water because the fraction of water is really low (0.33 %wt). But the permeance is 1000 times higher for water than for ethanol that means that the membrane has a good selectivity for water compare to ethanol. The permeance does not seem to be influenced by the temperature. Indeed, the permeance of water is quite constant and the permeance of ethanol increases slightly. The temperature does not seem to influence the intrinsic property of the membrane, so the increase of the water and ethanol flux can be explained only by the increase of the gradient of pressure for this temperature range. The decrease of the selectivity of water with the increase of temperature can be explained by the more important increase of the partial vapour pressure of ethanol in that temperature range than the increase of the partial vapour pressure of water. Indeed, the boiling point of ethanol and water are 78°C and 100°C respectively. Between 67°C and 87°C we are lower than the boiling point of water but the boiling point of ethanol is in this temperature range. For the study of the ternary mixtures, we decided to work at 87°C , which gives better results.

Figure 10 represents the partial flux, with an accuracy of 6%, obtained for the dehydration of 12 solutions with different compositions of ethanol, DEC (from 0 to 15 %wt) and water (0.20 %wt and 0.33 %wt) detailed in Table 2. The flux for the experiments with 0.33 %wt of water in the feed is higher than the one for 0.20 %wt of water. The amount of water in the permeate is also higher in the case of 0.33 %wt in the feed with 70 %wt. Only 60 %wt of water in the permeate is obtained in the case of 0.20 %wt of water in the feed. The flux of DEC increases with the increase of the amount of DEC in the feed: at 15 %wt of DEC in the feed, we obtained 6% wt in the permeate, which is still low. To compare the selectivity of the membrane between these three components, we calculate selectivity factors defined in Eq. 7.

$$\alpha = \frac{x_{A\text{ permeate}} / x_{B\text{ permeate}}}{x_{A\text{ feed}} / x_{B\text{ feed}}} \quad (7)$$

where x represents the molar fraction of the component in the permeate and in the feed. A represents the component selectively transferred in the permeate, water in our case, and B represents the other component: ethanol or DEC. Table 3 shows the calculated factors for the 12 experiments. We can see that these factors are high, they are in the range of 750 and 1020 for water on ethanol. Water or DEC concentrations do not seem to have a significant impact on these factors. Selectivity

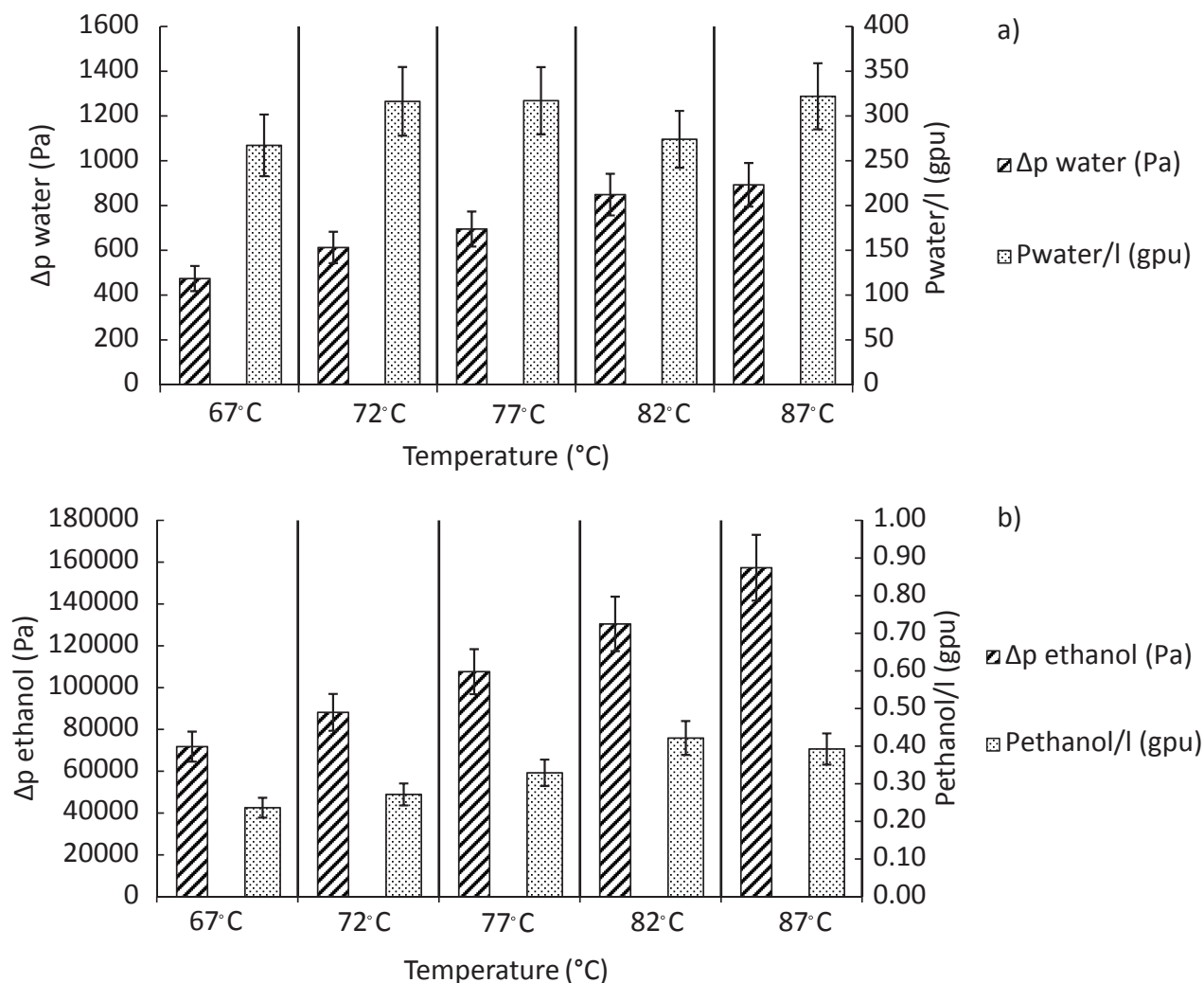

Figure 9: Influence of the temperature on the pressure gradient and the permeance for ethanol-water solution with 0.33 %wt of water.

factors for water on DEC are higher than for water on ethanol especially for the case at 0.33 %wt of water in the feed.

Figure 11 shows the calculated gradients of pressure and permeances for these 12 experiments. Figure 11a presents results obtained for water. The gradient of pressure is higher for the case at 0.33 %wt of water in the feed but the permeance is quite the same for the two cases at 0.20 or 0.33 %wt. So the difference in the flux of water is only due to the difference in the gradient of pressure. The permeance of water seems to decrease slowly with the increase of the amount of DEC in the feed. It can be due to the fact that DEC has a slightly better affinity with the membrane than ethanol. We can see that difference in Figures 11b and 11c: the permeance

of ethanol is around 0.4 and the one of DEC is higher at 0.6. This difference is quite small so the decrease in water permeance stays negligible for this range of amount of DEC. These results are really interesting and promising for the association of the reaction and the pervaporation because the DEC seems to stay in the feed.

As expected, this first study on the pervaporation of the ternary mixture of ethanol, DEC and water, confirms that the dehydration of the reaction mixture is possible. The objective is now to optimize the surface area of the membrane necessary to improve the yield in DEC significantly. A kinetic model of the reaction and a modelling of the dehydration of the reaction mixture with different compositions are needed to simulate

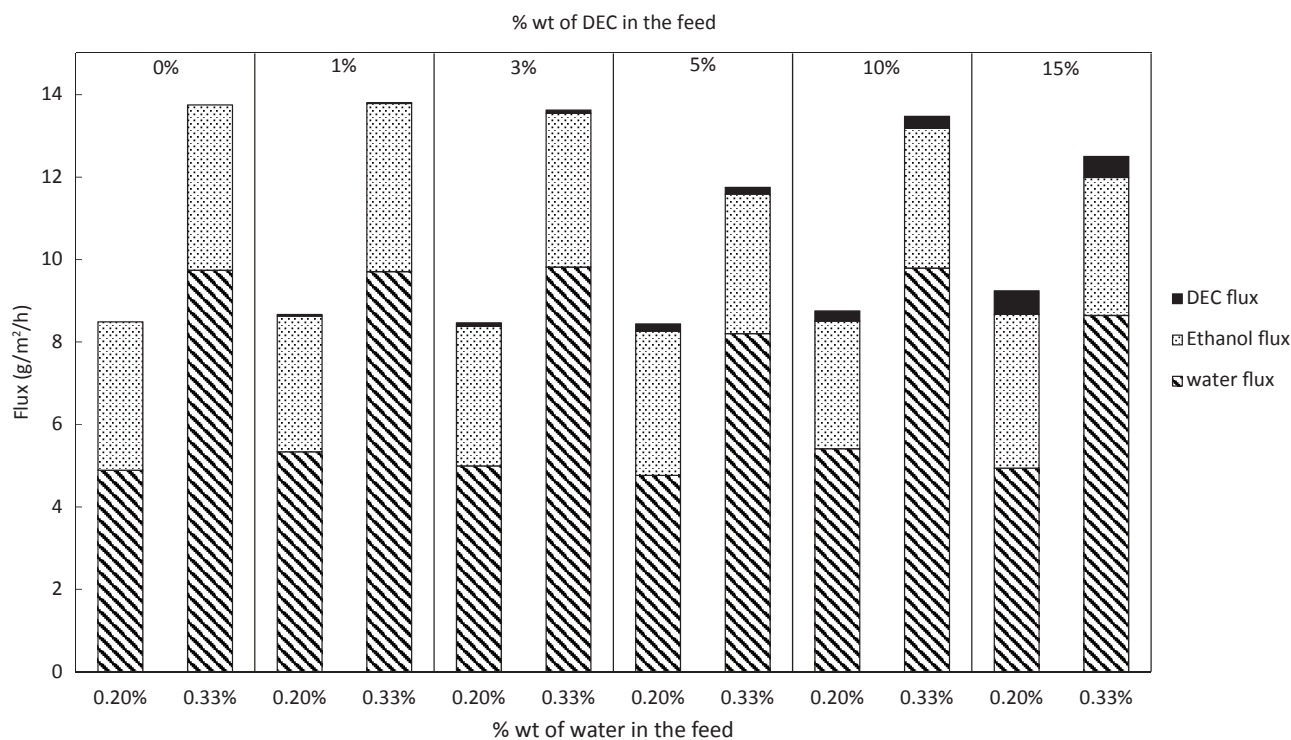

Figure 10: Partial flux of water, ethanol and DEC in function of the amount of water and DEC in the feed.

Table 3: Water selectivity as a function of ethanol and DEC for two amounts of water in the feed: 0.20 %wt and 0.33 %wt and different amounts of DEC: 0 %wt, 1 %wt and 3 %wt.

% of DEC in the feed	0.20% of water in the feed		0.33% of water in the feed	
	$\alpha_{\text{water/ethanol}}$	$\alpha_{\text{water/DEC}}$	$\alpha_{\text{water/ethanol}}$	$\alpha_{\text{water/DEC}}$
0%		860	940	
1%	1200	961	880	1630
3%	910	1130	970	1440
5%	810	850	940	1010
10%	990	1440	970	1300
15%	750	910	890	1080

the circulation loop between the reactor and the pervaporation cell and then, to optimize the surface area of the membrane.

4 Conclusion

A parametric study of the reaction of carbonation of ethanol has been made. The results are quite similar to

those obtained in the literature on the synthesis of dimethyl carbonate from methanol. The influence of the presence of water in the production of DEC has been highlighted. This result shows that it is necessary to dehydrate the reaction mixture to improve the yield in DEC. The pervaporation experiments show that it is possible to dehydrate ethanol even with an amount of water below than 0.33 %wt. The temperature and the amount of water in the feed have a strong impact on the separation. Twelve experiments have been performed to simulate the dehydration of a reaction medium at the end of a reaction. The presence of DEC from 0 to 15 %wt in the feed seems to have no impact on the water flux. These results are promising. The continuous extraction of water by pervaporation all along the reaction has to be done to improve the yield in DEC.

Acknowledgements: The authors thank MADNESS project. The MADNESS project has been funded with the support from the European Union with the European Regional Development Fund (ERDF) and from the Regional Council of Normandie. The authors are also grateful for the financial support from ADEME and the Regional Council of Normandie.

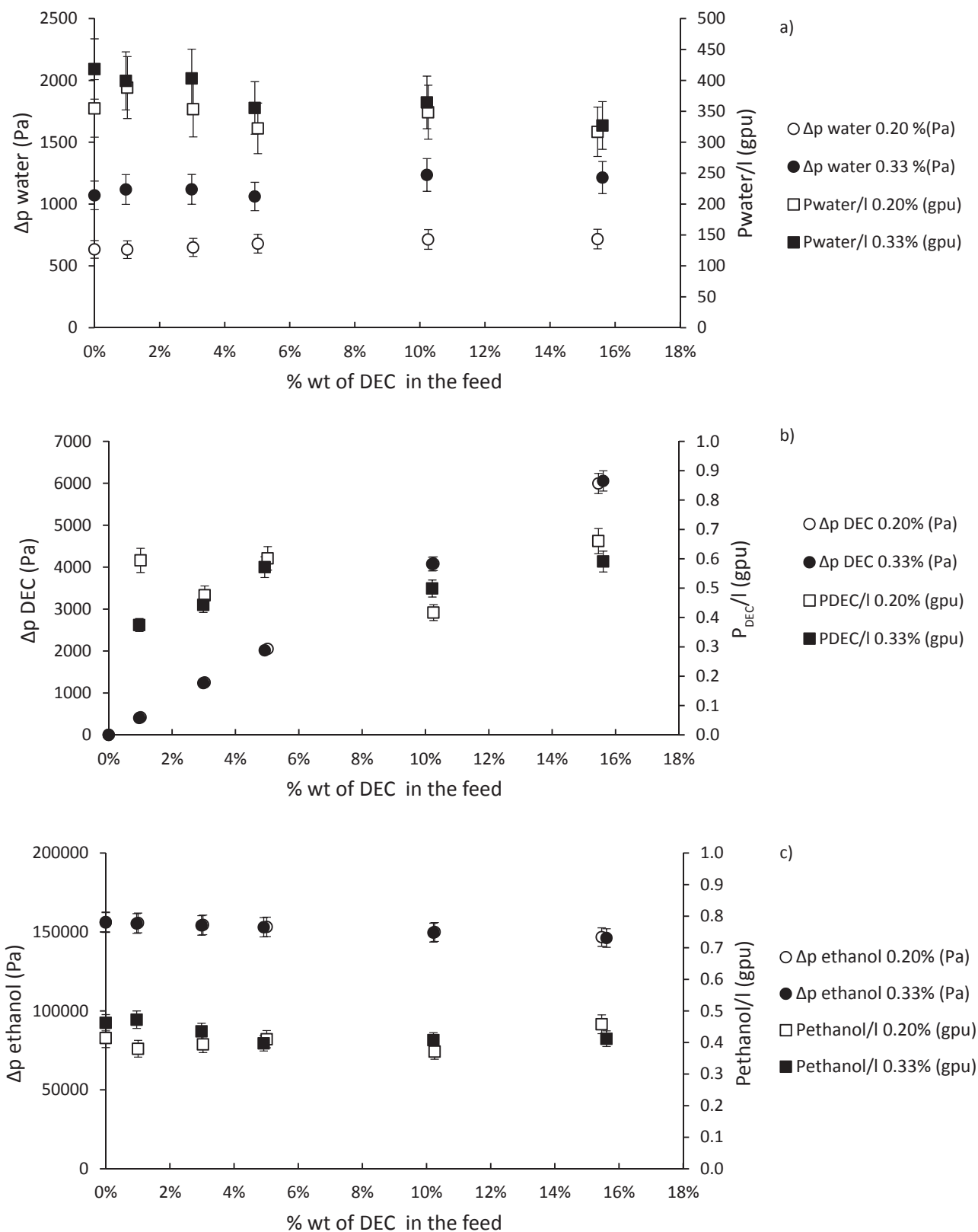

Figure 11: Influence of the amount of DEC on the pressure gradient and permeance of (a) water, (b) DEC and (c) ethanol.

References

- [1] IEA. Energy and Climate Change, 2015.
- [2] Leung D.Y.C., Caramanna G., Maroto-Valer M.M., An overview of current status of carbon dioxide capture and storage technologies. *Renew. Sust. Energ. Rev.*, 2014, 39, 426-443.
- [3] Olajire A.A., Valorization of greenhouse carbon dioxide emissions into value-added products by catalytic processes. *J. CO₂ Util.*, 2013, 3, 74-92.
- [4] Huang S., Yan B., Wang S., Ma X., Recent advances in dialkyl carbonates synthesis and applications. *Chem. Soc. Rev.*, 2015, 44, 3079-3116.
- [5] Monteiro J.G.M.-S., Araújo O. de Q.F., Medeiros J.L. de., Sustainability metrics for eco-technologies assessment, part I: preliminary screening. *Clean. Technol. Envir.*, 2009, 11, 209-214.
- [6] ADEME. Valorisation chimique du CO₂ - Etat des lieux, 2014.
- [7] Tamboli A.H., Chaugule A.A., Kim H., Catalytic developments in the direct dimethyl carbonate synthesis from carbon dioxide and methanol. *Chem. Eng. J.*, 2017, 323, 530-544.
- [8] Kindermann N., Jose T., Kleij A.W., Synthesis of Carbonates from Alcohols and CO₂. *Top. Curr. Chem.*, 2017, 375, 15.
- [9] Tomishige K., Sakaihorii T., Ikeda Y., Fujimoto K., A novel method of direct synthesis of dimethyl carbonate from methanol and carbon dioxide catalyzed by zirconia. *Catal. Lett.*, 1999, 58, 225-229.
- [10] Wang S., Zhao L., Wang W., Zhao Y., Zhang G., Ma X., et al., Morphology control of ceria nanocrystals for catalytic conversion of CO₂ with methanol. *Nanoscale*, 2013, 5, 5582-5588.
- [11] Tomishige K., Ikeda Y., Sakaihorii T., Fujimoto K., Catalytic properties and structure of zirconia catalysts for direct synthesis of dimethyl carbonate from methanol and carbon dioxide. *J. Catal.*, 2000, 192, 355-362.
- [12] Ikeda Y., Asadullah M., Fujimoto K., Tomishige K., Structure of the Active Sites on H₃PO₄/ZrO₂ Catalysts for Dimethyl Carbonate Synthesis from Methanol and Carbon Dioxide. *J. Phys. Chem. B*, 2001, 105, 10653-10658.
- [13] Jiang C., Guo Y., Wang C., Hu C., Wu Y., Wang E., Synthesis of dimethyl carbonate from methanol and carbon dioxide in the presence of polyoxometalates under mild conditions. *Appl. Catal. A-Gen.*, 2003, 256, 203-212.
- [14] Honda M., Tamura M., Nakagawa Y., Sonehara S., Suzuki K., Fujimoto K., et al., Ceria-Catalyzed Conversion of Carbon Dioxide into Dimethyl Carbonate with 2-Cyanopyridine. *ChemSusChem*, 2013, 6, 1341-1344.
- [15] Jonquière A., Arnal-Hérault C., Babin J., Pervaporation. In: Hoeck E.M.V., Tarabara V.V., Encyclopedia of Membrane Science and Technology, 2013.
- [16] Jonquière A., Clément R., Lochon P., Néel J., Dresch M., Chrétien B., Industrial state-of-the-art of pervaporation and vapour permeation in the western countries. *J. Membrane Sci.*, 2002, 206, 87-117.
- [17] Bolto B., Hoang M., Xie Z., A review of membrane selection for the dehydration of aqueous ethanol by pervaporation. *Chem. Eng. Process*, 2011, 50, 227-235.
- [18] Chapman P.D., Oliveira T., Livingston A.G., Li K., Membranes for the dehydration of solvents by pervaporation. *J. Membrane Sci.*, 2008, 318, 5-37.
- [19] Diban N., Aguayo A.T., Bilbao J., Urriaga A., Ortiz I., Membrane Reactors for in Situ Water Removal: A Review of Applications. *Ind. Eng. Chem. Res.*, 2013, 52, 10342-10354.
- [20] Izák P., Mateus N.M.M., Afonso C.A.M., Crespo J.G., Enhanced esterification conversion in a room temperature ionic liquid by integrated water removal with pervaporation. *Sep. Purif. Technol.*, 2005, 41, 141-145.
- [21] Dibenedetto A., Aresta M., Angelini A., Ethiraj J., Aresta B.M., Synthesis, Characterization, and Use of NbV/CeIV-Mixed Oxides in the Direct Carboxylation of Ethanol by using Pervaporation Membranes for Water Removal. *Chem.-Eur. J.*, 2012, 18, 10324-10334.
- [22] Li C.-F., Zhong S.-H., Study on application of membrane reactor in direct synthesis DMC from CO₂ and CH₃OH over Cu-KF/MgSiO catalyst. *Catal. Today*, 2003, 82, 83-90.
- [23] Kuenen H.J., Mengers H.J., Nijmeijer D.C., van der Ham A.G.J., Kiss A.A., Techno-economic evaluation of the direct conversion of CO₂ to dimethyl carbonate using catalytic membrane reactors. *Comput. Chem. Eng.*, 2016, 86, 136-147.
- [24] Aresta M., Dibenedetto A., Dutta A., Energy issues in the utilization of CO₂ in the synthesis of chemicals: The case of the direct carboxylation of alcohols to dialkylcarbonates. *Catal. Today*, 2017, 281, Part 2, 345-351.
- [25] Wang J., Hao Z., Wohlrab S., Continuous CO₂ esterification to diethyl carbonate (DEC) at atmospheric pressure: Application of porous membranes for in-situ H₂O removal. *Green Chem.*, 2017, 19, 3595-3600.
- [26] Wang Y., Jia D., Zhu Z., Sun Y., Synthesis of Diethyl Carbonate from Carbon Dioxide, Propylene Oxide and Ethanol over KNO₃-CeO₂ and KBr-KNO₃-CeO₂ Catalysts. *Catalysts*, 2016, 6, 52.
- [27] Shukla K., Srivastava V.C., Diethyl carbonate: critical review of synthesis routes, catalysts used and engineering aspects. *RSC Adv.*, 2016, 6, 32624-32645.
- [28] Yoshida Y., Arai Y., Kado S., Kunimori K., Tomishige K., Direct synthesis of organic carbonates from the reaction of CO₂ with methanol and ethanol over CeO₂ catalysts. *Catal. Today*, 2006, 115, 95-101.
- [29] Yave W., Separation performance of improved PERVAP membrane and its dependence on operating conditions. *J. Membrane Sci. Res. (in press)*, doi:10.22079/jmsr.2018.88186.1198.

- [30] Santos B.A.V., Pereira C.S.M., Silva V.M.T.M., Loureiro J.M., Rodrigues A.E., Kinetic study for the direct synthesis of dimethyl carbonate from methanol and CO₂ over CeO₂ at high pressure conditions. *Appl. Catal. A-Gen.*, 2013, 455, 219-226.
- [31] Kumar P., With P., Chandra Srivastava V., Shukla K., Gläser R., Mani Mishra I., Dimethyl carbonate synthesis from carbon dioxide using ceria-zirconia catalysts prepared using a templating method: characterization, parametric optimization and chemical equilibrium modeling. *RSC Adv.*, 2016, 6, 110235-110246.
- [32] Hofmann H.J., Brandner A., Claus P., Direct Synthesis of Dimethyl Carbonate by Carboxylation of Methanol on Ceria-Based Mixed Oxides. *Chem. Eng. Technol.*, 2012, 35, 2140-2146.
- [33] Baker R.W., Wijmans J.G., Huang Y., Permeability, permeance and selectivity: A preferred way of reporting pervaporation performance data. *J. Membrane Sci.*, 2010, 348, 346-352.