



HAL
open science

Alternative Technologies That Facilitate Access to Discrete Metal Complexes

Audrey Beillard, Xavier Bantreil, Thomas-Xavier Métro, Jean Martinez, Frédéric Lamaty

► **To cite this version:**

Audrey Beillard, Xavier Bantreil, Thomas-Xavier Métro, Jean Martinez, Frédéric Lamaty. Alternative Technologies That Facilitate Access to Discrete Metal Complexes. *Chemical Reviews*, 2019, 119 (12), pp.7529-7609. 10.1021/acs.chemrev.8b00479 . hal-02325837

HAL Id: hal-02325837

<https://hal.science/hal-02325837>

Submitted on 16 Mar 2021

HAL is a multi-disciplinary open access archive for the deposit and dissemination of scientific research documents, whether they are published or not. The documents may come from teaching and research institutions in France or abroad, or from public or private research centers.

L'archive ouverte pluridisciplinaire **HAL**, est destinée au dépôt et à la diffusion de documents scientifiques de niveau recherche, publiés ou non, émanant des établissements d'enseignement et de recherche français ou étrangers, des laboratoires publics ou privés.

Alternative Technologies That Facilitate Access to Discrete Metal Complexes

Audrey Beillard, Xavier Bantreil,*^{ib} Thomas-Xavier Métro,*^{ib} Jean Martinez,^{ib} and Frédéric Lamaty*^{ib}

Institut des Biomolécules Max Mousseron (IBMM), UMR 5247, CNRS, Université de Montpellier, ENSCM, Campus Triolet, Place Eugène Bataillon, 34095 Montpellier cedex 5, France

ABSTRACT: Organometallic complexes: these two words jump to the mind of the chemist and are directly associated with their utility in catalysis or as a pharmaceutical. Nevertheless, to be able to use them, it is necessary to synthesize them, and it is not always a small matter. Typically, synthesis is via solution chemistry, using a round-bottom flask and a magnetic or mechanical stirrer. This review takes stock of alternative technologies currently available in laboratories that facilitate the synthesis of such complexes. We highlight five such technologies: mechanochemistry, also known as solvent-free chemistry, uses a mortar and pestle or a ball mill; microwave activation can drastically reduce reaction times; ultrasonic activation promotes chemical reactions because of cavitation phenomena; photochemistry, which uses light radiation to initiate reactions; and continuous flow chemistry, which is increasingly used to simplify scale-up. While facilitating the synthesis of organometallic compounds, these enabling technologies also allow access to compounds that cannot be obtained in any other way. This shows how the paradigm is changing and evolving toward new technologies, without necessarily abandoning the round-bottom flask. A bright future is ahead of the organometallic chemist, thanks to these novel technologies.

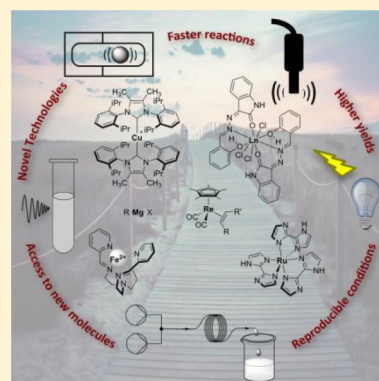

CONTENTS

1. Introduction	7530	6.3. Photochemistry for Synthesis of Group 6 Metal Complexes	7543
2. Technologies	7530	6.4. Continuous Flow Chemistry for Synthesis of Chromium Complexes	7545
2.1. Grinding and Milling	7530	7. Group 7	7545
2.2. Microwave Irradiation	7531	7.1. Mechanochemistry of Rhenium Complexes	7545
2.3. Ultrasound Activation	7531	7.2. Microwave Irradiation for the Synthesis of Group 7 Metal Complexes	7546
2.4. Photochemistry	7532	7.3. Photochemical Synthesis of Manganese and Rhenium Complexes	7549
2.5. Continuous Flow	7532	8. Group 8	7550
3. Contribution of Each Technology Compared to Classical Syntheses	7533	8.1. Synthesis of Iron and Ruthenium Complexes Using Ball Milling	7550
4. Lithium and Magnesium	7534	8.2. Microwave Procedures	7552
4.1. Mechanochemical Access to Grignard Reagents	7534	8.3. Ultrasonic Irradiation for Iron Complexes	7562
4.2. Microwave Irradiation for the Synthesis of Magnesium Complexes	7534	8.4. Syntheses of Iron and Ruthenium Complexes Using Photochemistry	7563
4.3. Ultrasonic Procedures	7535	8.5. Continuous Flow Conditions to Prepare Iron and Ruthenium Complexes	7566
4.4. Continuous Flow Syntheses	7535	9. Group 9	7566
5. Groups 2, 3, 4, and 5	7537	9.1. Synthesis of Cobalt and Rhodium Complexes by Mechanochemistry	7566
5.1. Mechanochemical Procedures for Complexes of Groups 2, 3, and 4	7537	9.2. Procedures Using Microwave Irradiation	7569
5.2. Microwave Irradiation for the Synthesis of Vanadium Complexes	7537	9.3. Photochemical Synthesis of Iridium Complexes	7573
5.3. Synthesis of Vanadium Complexes Using Ultrasound	7538	10. Group 10	7574
6. Group 6	7538	10.1. Mechanochemical Approach	7574
6.1. Mechanochemistry of Molybdenum and Chromium Complexes	7538		
6.2. Microwave Irradiation for the Synthesis of Group 6 Metal Complexes	7539		

10.2. Microwave Irradiation	7577
10.3. Ultrasounds for the Synthesis of a Nickel Complex	7582
10.4. Continuous Flow Synthesis of Nickel Complexes	7582
11. Group 11	7583
11.1. Mechanochemistry and Coinage Metals	7583
11.2. Microwave Synthesis of Group 11 Metal Complexes	7586
11.3. Ultrasounds for the Synthesis of Copper and Silver Complexes	7589
11.4. Continuous Flow for the Synthesis of NHC Copper Complexes	7589
12. Group 12	7590
12.1. Mechanochemistry of Group 12 Metal Complexes	7590
12.2. Microwave Irradiation for the Synthesis of Group 12 Metal Complexes	7591
12.3. Ultrasonic Activation and Mercury	7593
13. Mechanochemical Access to Aluminum and Indium Complexes	7593
14. Group 14	7593
14.1. Mechanochemically Synthesized Lead Complexes	7593
14.2. Microwave Syntheses of Tin and Germanium Compounds	7594
14.3. Ultrasonic Bath for the Synthesis of Lead Complexes	7595
15. Group 15: Syntheses by Ball Milling	7595
16. Lanthanide	7596
16.1. Mechanochemical Approach	7596
16.2. Microwave Syntheses	7596
17. Conclusion	7596
Author Information	7597
Corresponding Authors	7597
ORCID	7597
Notes	7597
Biographies	7597
Acknowledgments	7598
List of Abbreviations	7598
References	7599

1. INTRODUCTION

Over the past decade, remarkable developments of new synthetic procedures for the production of discrete metal complexes have been described. Microwave-assisted,¹ electrochemical,² photochemical,³ mechanochemical,⁴ and continuous flow procedures⁵ have increased yields, while reducing reaction times and environmental impact. In addition, many procedures are highly selective and lead to the desired product with minimal byproducts.

The impressive number of discrete metal complex applications can explain such an increase in the number of innovative strategies to produce them. Indeed, metal complexes are frequently used for their catalytic properties such as in cross-coupling reactions, olefin metathesis, or even oxidation and reduction reactions. Various metal complexes also exhibit biological properties such as antifungal, antibacterial, antimalarial, or anticancer activities.^{6–17} Due to their luminescent properties, they are also widely used as task-specific materials.

The number of their synthetic procedures has also increased using classical solution synthesis, but many of these procedures

have numerous disadvantages such as long reaction times and, in many cases, low to moderate yields. In addition, these procedures may have a negative environmental impact. Consequently, these last years, new strategies were deployed to synthesize discrete metal complexes more efficiently.

This review focuses on the use of enabling technologies for the syntheses of discrete metal complexes. The synthesis of coordination complexes, which would include coordination polymers, metal–organic frameworks, etc., will not be considered herein. Thus, syntheses of discrete metal complexes utilizing mechanical forces, microwave irradiation, ultrasound activation, photochemistry, and continuous flow will be summarized and discussed below. The syntheses of metal complexes using established electrochemical procedures are deliberately excluded in this review, which focuses on newer technologies. Following an introductory part describing the various technologies available for activation, the review is organized according to the periodic table, by metallic element group.

2. TECHNOLOGIES

All of these technologies have been known and used for some time. The first use of a mortar and pestle in chemistry was dated to the fourth century BC and described the grinding of cinnabar and acetic acid. Photochemistry is used by plants for photosynthesis. Ultrasonic waves are produced by different animals such as bats to detect their prey, while the most well-known use of microwaves is cooking. Unfortunately, the application of these technologies to organic synthesis was neglected until the 1980s but then was considerably developed. In this introductory part, each new technology will be discussed in detail.

2.1. Grinding and Milling

Mechanochemistry refers to reactions “*induced by the input of mechanical energy*”.^{4,18} There are different modes of mechanical activation, and this review will focus on activation by grinding and milling. Mechanical energy is usually produced by shock or friction between two different surfaces. For a long time, this approach was neglected, and solution-based syntheses were developed as default. However, recently, considerable efforts were made to develop new procedures, and this technique has emerged due to the numerous advantages it provides. Generally, reactions are performed in the solid state by grinding. Using a mortar and pestle is the oldest technique to induce reactions by mechanical forces. The historical mechanochemical reaction realized by Faraday was performed using the readily available mortar and pestle. For reactions requiring a long grinding time, the affordable mortar and pestle can be replaced by a ball mill, which also provides more reproducible results. Various apparatuses, mostly vibratory and planetary ball mills, were developed to perform chemical syntheses by mechanical means. This equipment is classically used to reduce the particle size of reagents and to homogenize the reaction mixture. Trivially, reagents and one or several balls are added into a jar which is closed and subjected to grinding for a specific time at a preset frequency. Sizes and materials of jars and balls can be changed, among Teflon, PMMA (poly(methyl methacrylate)), stainless steel, zirconium oxide, agate, and tungsten carbide, depending on the application. An important feature of using ball milling is the possibility of performing reactions under solvent-free or solvent-less conditions.¹⁹ The combination of a highly concentrated

reaction mixture with excellent mass transfer dramatically increases the reaction rate compared to classical solution chemistry. In addition, ball milling as a solvent-free methodology gives access to compounds that cannot be obtained in solution, even in drastic conditions.²⁰ Nevertheless, users should be aware that contamination resulting from abrasion of the grinding jar/balls (<30 to 40 000 ppm) can be found in the products, but this can be reduced by a judicious choice of the milling material.^{21,22} This contamination from wear could be a problem depending on the applications of the synthesized products (e.g., pharmaceutical products).

For scale-up, other equipment has been developed.^{23,24} Eccentric ball mills, also called eccentric vibratory ball mills,²⁵ are composed of a vibrating unit attached to a grinding chamber displaced from its center of gravity. This arrangement features a 5–300 L grinding vessel, which can lead to the formation of kilograms of products.

Another approach to scale-up is the reactive extrusion process. Typically, reactants are introduced in a barrel containing one (or two) screws that mix and carry the material from one end to the other, where products are recovered or can be recycled into the feeding port of the barrel. The main advantage of this technique is the possibility to work in a continuous manner.²⁶ Typically, one (or two) screws are used to mix reagents and carry the material to the end of the process, where products are recovered or can be reinjected into the cavity. This method can be used to make grams or kilograms of products. Both pieces of these scale-up equipment can be heated at elevated temperatures.

2.2. Microwave Irradiation

The use of microwaves in chemical synthesis has been known since the 1980s, with the first syntheses performed in domestic microwave ovens.²⁷ Since then, many developments have been made.^{28–31} Some of these ovens were modified to improve their use in chemistry; however, because temperature and pressure were not controlled, they were often dangerous (potential explosion at high temperature and pressure), and reproducibility was difficult. Nowadays, dedicated instruments have been developed and are used in chemistry laboratories with adequate safety, making microwave activation a common tool used in synthesis. One should emphasize that currently, because of safety reasons, domestic ovens should not be used to perform any chemistry. Nevertheless, it is important to note that some of the pioneering work in organometallics synthesis reported in this review was carried out in such ovens.

Microwave technology makes use of an electromagnetic wave generated by a magnetron at a frequency which ranges between 0.3 and 300 GHz, very often factory set to 2.45 GHz to avoid interference with other instruments using microwaves. Under microwave irradiation, polarized molecules in a reaction mixture will constantly try to realign their dipole moment with the oscillating electric field, thus creating molecular motion leading to intermolecular friction and collisions and ultimately generating heat (dipolar polarization) in the core of the irradiated mixture. The second important heating mechanism, known as ionic conduction, involves charged compounds (usually ions). When submitted to an oscillating electric field, charged compounds will adopt oscillating trajectories in the solution and create many intermolecular collisions of which the energy dissipates as heat. The reaction mixture can reach very high temperatures, reaching a maximum set between 250 and 300 °C for commercial instruments. According to the

Arrhenius equation, this efficient increase of temperature will translate to faster reactions.³² Very often instruments dedicated to synthesis make use of sealed tubes that allow pressure build-up in the course of the reaction.³³ Generally, one important parameter is the choice of the solvent and more specifically its capacity to absorb microwaves and generate heat. Nevertheless, in this review dedicated to organometallic chemistry and in all the cases described, the presence of a metal or a metallic salt ensures the absorbance of the microwaves, thus enabling the transformation to occur.³⁴ Moreover, this absorption and concomitant temperature increase on very localized areas of the mixture may efficiently promote a reaction (hot spot theory).

2.3. Ultrasound Activation

The sound spectrum is divided into four intervals: infrasound with frequencies ranging from 0 to 16 Hz, audible sound between 16 Hz and 16 kHz, ultrasound 16 kHz to 200 kHz, and finally hypersound with frequencies higher than 100 GHz. This part will describe the excitation of molecules by ultrasound. Ultrasounds are elastic waves having the properties of sound waves, namely, the propagation of mechanical disturbances in an elastic media. The main characteristic of these waves is their frequency, which depends on the propagation speed of the sound and the wavelength associated with this wave. Ultrasound waves in a liquid produce a pressure variation responsible for the creation, growth, oscillation, and finally the implosion of a gas bubble. This phenomenon is known as cavitation.³⁵ The implosion of gas bubbles is accompanied by mechanical and chemical effects that will be transformed into energy.^{36,37} Sonochemistry is based on the acoustic energy and the cavitation phenomenon produced by ultrasound.³⁸ It should also be noted that upon ultrasonic activation radicals may be formed in the reaction mixture. A transducer is used to produce an ultrasound, which relies on the properties of piezoelectric materials to convert electric energy into acoustic energy.

From a practical point of view,^{39,40} the first and most frequently used equipment for sonochemistry is the ultrasonic bath. These baths allow working with frequencies ranging from 20 to 60 kHz and low sound power under indirect irradiation. A vibratory source is fixed at the bottom of the tank to irradiate the liquid (often water) which transfers energy to the reaction. Ultrasound is inhomogeneously distributed into the reactor, and its intensity is highly dependent on the position of the reaction mixture inside the tank. Since low reproducibility was obtained for reactions, these baths are nowadays mostly used to dissolve compounds, clean surfaces, break emulsions, or degas liquids. “Cup-horn” reactors permit a direct and homogeneous irradiation, which is 50 times more powerful than classical ultrasonic baths. Ultrasonic probes were also developed for a better transfer of energy to the sample. The device is composed of a generator that converts the electric current into high frequency electrical energy, which is then converted into mechanical energy using an ultrasonic converter, an amplificatory probe to increase the amplitude of the wave, and finally an ultrasonic probe to transfer the energy to the sample. With ultrasonic probes, the irradiation is direct, and the acoustic power is more than a hundred times more powerful than ultrasonic baths. In addition, this equipment is resistant to hot spots, erosion, and mechanical stress. To perform highly energetic reactions, high frequency reactors were developed, with a direct irradiation from the

bottom to the top of the reactor using piezoelectric ceramics attached to the bottom of double-jacketed reactors. Nevertheless, these reactors quickly deteriorate due to the powerful temperature elevation resulting from the ultrasound.

Different parameters can affect the cavitation phenomenon. The frequency of ultrasound determines the lifespan of the bubbles: a higher frequency makes the bubbles grow and collapse faster. Temperature and hydrostatic pressure are also important. Increasing pressure or temperature will lead to poorer cavitation, but the energy or the diffusion is increased, respectively. Although low temperatures promote better cavitation, experiments demonstrate that better yields are achieved with elevated temperatures. The medium is an important parameter. Solvents with a high vapor pressure (most organic solvents) decrease the intensity of the cavitation, but the presence of dissolved gas improves the nucleation step of the bubbles.⁴¹

Even though enhancing reactions with ultrasonic activation is very promising, the reproducibility of the reactions, because of the difficulty in controlling different physicochemical parameters, is a huge limitation of sonochemistry. Equipment and experimental conditions have to be precisely reported to allow the replication of the experiments. In addition, the scale-up of sonochemical reactions to date remains difficult.

2.4. Photochemistry

Interactions between light and matter have long been known and are used in nature, e.g., photosynthesis, the phenomenon of eyesight, and tanning.⁴² Upon light exposure, the energy of the photon absorbed by a molecule or material will allow an electron to transfer from its fundamental state to an excited state of higher energy.^{43–45} The activated molecule can directly react or transfer its energy to another reactant. In the latter case, the molecule is called a photosensitizer. In principle, photochemistry can be performed in the gas phase, solid state, or solution, although photochemical reactions in solution are the most developed.⁴⁶

The most consistent and sustainable source of light is sunlight. Photochemistry performed with this source would be the ideal situation. Unfortunately, most reagents absorb in the UV (ultraviolet) region (between 200 and 300 nm), and the Earth's atmosphere mostly filters ultraviolet rays. Therefore, mercury-vapor lamps, namely, gas discharge lamps that use an electric arc through vaporized mercury to produce light, were developed to work in a range between 250 and 600 nm.⁴⁷ Lamps with a low pressure (5–10 atm) were first developed, but then medium- or high-pressure lamps (5–100 atm) were used to improve the efficiency. Unfortunately, mercury lamps are highly toxic in the case of breakage and have a short lifespan. An efficient, albeit still expensive, alternative is the UV LED lamp (ultraviolet light-emitting diodes) which allows one to work at high power and also possess a longer lifetime. Other lamps can be used to work at a specific wavelength such as sodium lamps, which irradiate at 600 nm. Interestingly, additional solid or liquid filters may be used to restrict the irradiation wavelengths. With regard to the reactors, they have to be transparent to the desired working wavelengths. Most reactors used for photochemistry are made of quartz, which absorbs only at 254 nm. Pyrex reactors absorb under 275 nm, while standard window glass absorbs at wavelengths lower than 350 nm.

When performing photochemistry, the first parameter to consider is the irradiation wavelength to determine which

reactor and light source to use. Recording the UV spectra of all photoactive species may help to find the maximum of absorption of each molecule and determine the best compromise. Of note, the absorption energy is highly dependent on the choice of the irradiation wavelength. The choice of solvent is also important as solvent can absorb the light and react under specific conditions. Chlorinated solvents are often avoided due to the possibility of C–Cl bond cleavage, leading to chlorination reactions. Numerous solvents also inhibit photochemical reactions because of high UV absorption, such as cyclohexane at 215 nm or hydrocarbon solvents around 330 nm. The purity of the solvent should also be considered as impurities can absorb and lead to low conversions. Interestingly, the choice of solvent may lead to different conversions or different final products. To conclude, three characteristics have to be considered for the choice of solvent. It should be transparent at the selected irradiation wavelength, free of impurities, and it should dissolve reactants and reagents.

In addition to the chemical yield, the quantum yield is also defined in photochemistry to evaluate the efficiency of a photochemical transformation. This yield corresponds to the number of events (photochemical-induced transformations) divided by the number of absorbed photons. Typically, the quantum yield should be equal to 1 when one molecule absorbs one photon. Since not all photons are absorbed productively, it is usually lower than 1. However, for chain reactions, quantum yields can be higher than 10 000. Nevertheless, in the case of low quantum yield, the chemical yield is not correlated and can be excellent.

2.5. Continuous Flow

Continuous flow chemistry is one of the major advances in the last few decades in terms of new technology for synthesis.^{5,48} Although chemists are still attached to conventional batch chemistry using round-bottom flasks and stirrers to homogenize reactant solutions, the transition to continuous flow chemistry is taking place. The benefits of working in a continuous flow are numerous. In fact, compared with conventional chemistry, working in microfluidic mode enables one to improve heat and mass transfers and consequently the kinetics of a reaction. The possibility of performing reactions under pressure also allows one to work in superheated solvent (above the boiling point), similar to sealed microwave reactors. This represents one of the many reasons why microwave reactions are generally translatable to continuous flow.⁴⁹ In addition, because each part of the tubing only contains small amounts of reagents in contact with each other, the risks associated with possible reaction exothermicity are limited. This similarly applies to the use of explosive reagents.⁵⁰ In terms of reactivity, it is also possible to control the stoichiometry of reagents locally because only a few molecules are mixed at any one time and thus influence the selectivity of a reaction.⁵¹ In addition, the use or in situ preparation of highly reactive species is very convenient in continuous flow. However, one of the main limitations of continuous flow chemistry is the use or the formation of solids that lead to reactor clogging.

Different suppliers offer turnkey equipment including pumping systems, via HPLC or peristaltic pumps, variable and interchangeable reaction modules with integrated heating, such as reactor coils or microfluidic chips, and the possibility of adding columns that may contain purification resins or

Table 1. Chart Comparing Some Enabling Technologies and Classical Solution Chemistry for the Synthesis of Organometallic Complexes

	Ball-mill	Microwave irradiation	Ultrasounds	Photochemistry	Continuous flow
Reduced time	Applicable	Applicable	Applicable	Applicable	Applicable
New products / reactions	Applicable	Applicable	Applicable	Applicable	Applicable
Better yields	Applicable	Applicable	Applicable	Applicable	Applicable
Solvent-free	Applicable	Not applicable	Applicable	Applicable	Not applicable
Scalability	Not applicable	Applicable	Not applicable	Applicable	Applicable
Reproducibility	Applicable	Applicable	Applicable	Applicable	Applicable
Economy	Applicable	Applicable	Applicable	Applicable	Applicable

Color code: Applicable Not applicable

heterogeneous reagents. The assembly can be improved by combining it with an automated reagent sampler and a fraction collector, the whole being controlled by a computer. It is also possible to perform low-temperature reactions using the appropriate add-on module. To further improve the potential of such equipment, real-time and *in situ* analysis of the reaction mixture through IR (infrared) and UV spectroscopy, as well as gas chromatography, can be used to monitor the reaction. With this in mind, the Poliakoff group recently developed a self-optimizing algorithm for the reaction of aniline with dimethyl carbonate in supercritical CO₂.⁵²

Flow chemistry is very adaptable. Recently, the development of photoredox catalysis resulted in suppliers developing photochemical reactors with different wavelengths depending on the targeted application.⁵³ Similarly, the use of gases is not a limitation in continuous flow due to the development of tube-in-tube reactors, which feature an inner gas permeable membrane.⁵⁴

If the turnkey equipment is relatively expensive or not necessarily adapted to certain types of chemistry, it is possible to build homemade continuous flow systems from spare parts.⁵⁵ This approach also has the advantage of modularity compared to commercially available equipment. It is also possible to monitor a continuous flow reaction while remaining in a distant office, thus conducting continuous flow experiments via remote control and cloud chemistry.⁵⁶

3. CONTRIBUTION OF EACH TECHNOLOGY COMPARED TO CLASSICAL SYNTHESSES

A summary of the benefits provided by the use of the enabling technologies selected in this review over solution chemistry for the preparation of discrete metal complexes is presented in Table 1. Even though they share many benefits, some particular advantages can be highlighted.

First, one general advantage is the reduction of reaction time. Many reports compare microwave activation or mechanochemistry to classical syntheses, and in most cases, the use of these techniques allows one to reduce the reaction time from several hours or days to a few minutes. The use of ultrasound or continuous flow techniques gives similar enhancements, but only a few reports show a direct comparison of these techniques with conventional conditions, especially for the synthesis of organometallic complexes. In the case of photochemistry, the comparison is less appropriate

since few photochemical reactions would proceed in conventional conditions.

This last point is of high interest. Indeed, the enabling technologies described above make it possible to carry out reactions that would not be successful by conventional methods. This is particularly the case for photochemistry which is often used in organic chemistry to achieve transformations that could not occur without this activation. This aspect is also currently under development for the preparation of organometallics. More generally, the use of microwave activation in closed-vessel mode allows the reaction of poorly reactive substrates which would normally remain inactive under refluxing conditions. In mechanochemistry, the number of examples dealing with the formation of new molecules, which cannot be synthesized in solution, or with a change in selectivity compared to solution is growing.²⁰ In the case of ultrasound waves, activation modes may differ, but the phenomenon of cavitation or the generation of transient species such as radicals would promote difficult reactivities. To date, for continuous flow, it is difficult to evaluate the feasibility of new reactions or access to new organometallic complexes since reports dealing with the synthesis of discrete metal complexes are scarce. However, since this technology is increasingly being developed, and more often than not combined with other activation techniques, it will most probably demonstrate its effectiveness in this synthetic area in the near future.

The most important benefit of mechanochemistry using ball milling compared to other conditions is the possibility of working under solvent-free or solvent-reduced conditions. Initial developments of mechanochemistry consisted of grinding mixtures of solids to synthesize alloys or inorganic compounds. Subsequently, ball mills were used to grind solid-liquid or even liquid-liquid reaction mixtures. Due to the absence of solvent, reactants are present in high concentration and have excellent mass transfer due to milling. Reaction times are decreased, and products are generally obtained in higher yield and purity. In terms of waste reduction, mechanochemistry has proven its efficiency. Green metrics have demonstrated the reduced environmental impact of synthesis performed in a ball mill compared to classical conditions. This is because of solvent-free conditions, increased yields, reduced reaction times, and simplified purification.

The major advantage of microwave irradiation, as provided by specially adapted equipment, is to reach and maintain high

Scheme 1. Mechanochemical Generation of Grignard Reagents

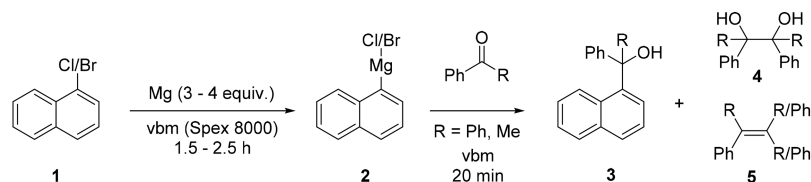

temperature in a reaction vessel, most commonly in a sealed tube, and hence accelerate the reaction. Furthermore, most salts and organometallic species present in a reaction mixture are excellent microwave absorbers, which contribute to the efficiency of the process. For the preparation of organometallic complexes, the reaction mixture is often ground in a mortar and pestle before irradiation. Authors have also described solvent-free syntheses using an additive (such as aluminum) to enhance microwave absorption.⁵⁷ In a similar way, but with different types of activation, sonochemistry, by generating intense local effects, may promote impossible or slow transformations.

While providing a way of promoting specific transformations, photochemistry has the advantage of being inexpensive and producing little waste. The ultimate aim is to use the sun as the light source. However, since the reproducibility of such reactions would depend on the weather, most processes are performed using light bulbs or LEDs (light-emitting diodes) with a controlled power source.

Using these techniques, yield and selectivity can be increased, with the resulting formation of fewer byproducts. Increased yield and selectivity also imply a simplified workup of the reaction mixture, with sometimes a simple filtration or extraction to give the pure product, thus avoiding purification using chromatographic techniques. This is very advantageous, particularly when it comes to scaling-up reactions.

Furthermore, combinations of these technologies are rapidly developing, especially in the case of flow chemistry where the equipment setup can include modules providing alternative activations, such as microwaves, ultrasound, or photochemistry.

4. LITHIUM AND MAGNESIUM

In contrast to elements of other groups, organometallic species involving lithium and magnesium are generally unstable and highly reactive. They thus have to be reacted rapidly with an electrophilic species. New procedures have been developed in the literature to form them *in situ* using enabling technologies such as milling, microwave irradiation, ultrasound, and continuous flow. These innovations will be described briefly below.

The Grignard reaction is one of the most common synthetic pathways in organic chemistry.⁵⁸ Reaction reproducibility can be affected by different factors: metal purity, degree of association in solution, or Schlenk equilibrium. Generally, the reaction needs to be activated.⁵⁹ On the other hand, lithiation can facilitate reactions that are not possible using Grignard reagents; however, lithiated species are extremely sensitive to air and can be harmful. A range of methods of preparation and reactions of these species have been developed (chemically, mechanically, thermally, or sonochemically) and will be discussed below.

4.1. Mechanochemical Access to Grignard Reagents

In 2001, Harrowfield et al. investigated the activation of magnesium in a ball mill to generate Grignard reagents from naphthalene halides (bromide and chloride).⁶⁰ The reaction of magnesium (50 mesh) in excess (up to 4 equiv) with 1-chloro- and 1-bromo-naphthalene 1 was performed in a Spex 8000 vibratory ball mill (Scheme 1). The reactor was filled and closed inside a glovebox to ensure an inert atmosphere during the reaction. After 1.5 to 2.5 h of reaction, it was possible to recover the corresponding Grignard reagent 2, which could be stored inside the glovebox without decomposition for up to 10 weeks. Subsequent reaction with acetophenone or benzophenone provided the expected tertiary alcohols 3–5. Excess of magnesium in the milling jar, however, promoted the formation of side products resulting from a McMurry reaction.

4.2. Microwave Irradiation for the Synthesis of Magnesium Complexes

The Hulshof group described the synthesis of highly reactive Grignard reagents from magnesium turnings and a halide substrate under microwave irradiation. The species generated *in situ* were trapped with CO₂, CS₂, or benzaldehyde to form corresponding products 6–8 in 30–88% yield (Scheme 2).⁶¹

Scheme 2. Microwave-Assisted Synthesis of Grignard Reagents

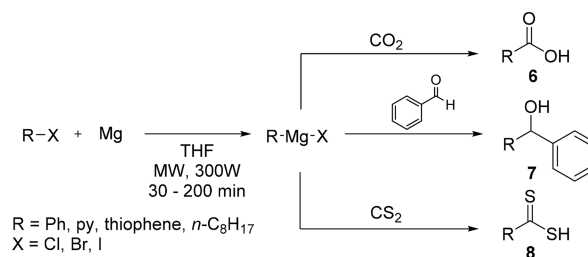

In comparison with conventional methods, reaction times and yields were similar, but microwave-induced discharge on the magnesium surface led to a considerably shorter initiation time and eliminated the use of initiators such as iodide or dibromoethane, which are toxic. In addition, the method limited the formation of byproducts. Inspired by this work, the Kappe group demonstrated that the reaction was highly dependent on the electromagnetic field of the microwave irradiation and not on the temperature.³⁴ Microwave irradiation using low-field density conditions led to an apparent acceleration of the insertion of Mg metal into the carbon-halide bond and reduced the initiation period. Conversely, using high-field density conditions resulted in the creation of carbonaceous material by solvent decomposition, which covered the Mg metal and prevented access to the organohalogen reagent, thus stopping the formation of the organomagnesium complex.

4.3. Ultrasonic Procedures

Cravotto et al. described the activation of a magnesium surface under ultrasonic irradiation.⁵⁹ The procedure was found to be safe, efficient, and reproducible. A 300 kHz cup horn was found to be the most efficient ultrasonic device. All Grignard reagents **10** were prepared in quantitative yield after less than 1 h of reaction and then reacted with a sterically hindered ketone, benzophenone, to furnish corresponding tertiary alcohols **11** in 84–94% yields (Scheme 3). This ultrasonic

Scheme 3. Ultrasound Synthesis of Grignard Reagent

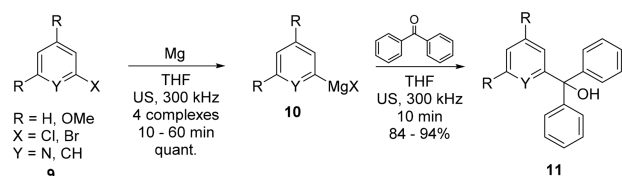

procedure was applied successfully to moderately reactive aryl halides such as 2-chloropyridine and 3,5-dimethoxy-bromobenzene. In comparison to the MW procedure, the US procedure enabled working under milder and safer conditions and avoided the risk of arcing.

4.4. Continuous Flow Syntheses

Using continuous flow chemistry, Grignard reagents could be generated *in situ* and reacted with electrophile to prepare various kinds of products: *N,N*-diethyl-4-(3-fluorophenylpiperidin-4-ylidenemethyl)benzamide **13** as a δ -opioid receptor agonist,⁶² 3-hydroxymethylindoles **15**,⁶³ 2,4,5-trifluorobenzoic acid **17**,⁶⁴ diaryl-substituted methyl alcohol **19**,⁶⁵ and propargylic alcohols and analogues **20–22**⁶⁶ (Scheme 4). In contrast to microwave or ultrasound syntheses, Grignard species were generated by the reaction of a halide compound with RMgCl , which had to be less stable than the desired Grignard reagent. The formation of the Grignard reagent could be monitored in-line by IR.⁶⁵ In addition, a continuous flow

Scheme 4. *In Situ* Generation of Grignard Reagents for the Formation of Organic Compounds in Continuous Flow

Synthesis of a δ -opioid receptor agonist⁶²

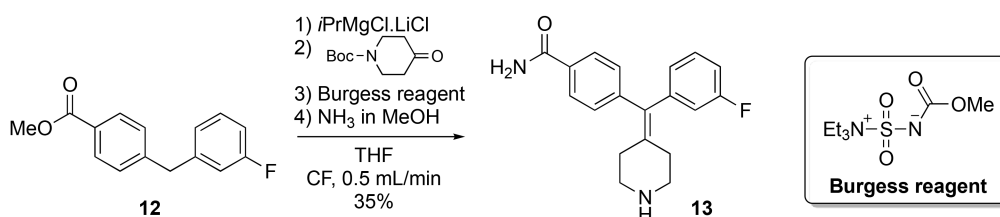

Generation of 3-hydroxymethylindoles⁶³

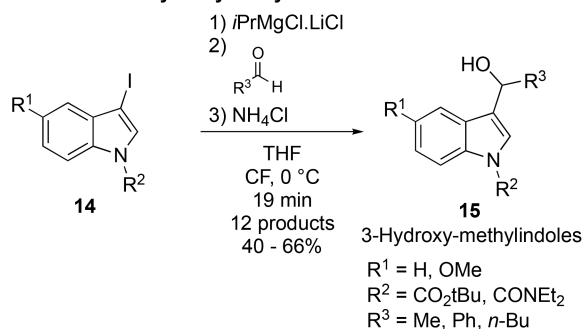

Carboxylation of Grignard reagents⁶⁴

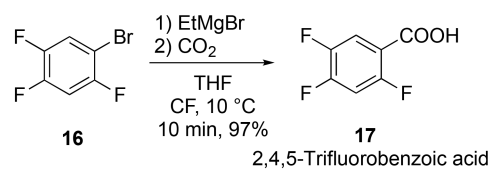

Continuous preparation of diarylmethyl alcohols⁶⁵

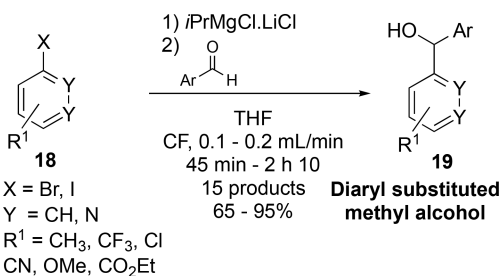

Preparation of propargyl alcohols⁶⁶

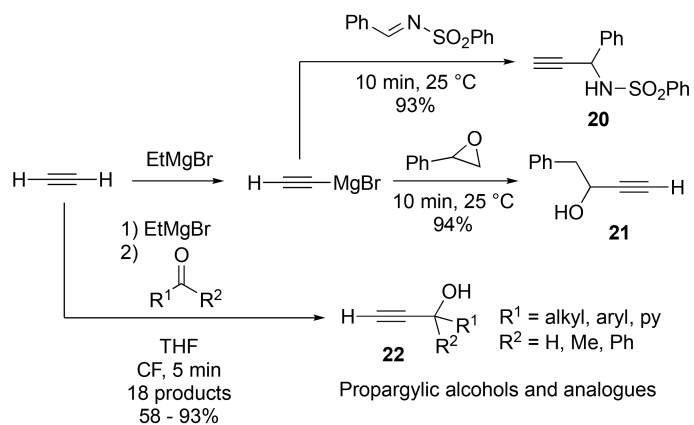

method was developed for the synthesis of Grignard reagent using a fluidized bed reactor.⁶⁷ In the latter case, the formation of the Grignard reagents and their reaction with CO₂ could be followed by in-line measurements of NMR spectra.

Continuous processes of lithiation and Grignard reaction were developed and compared in 2016 by the Kopach group (Scheme 5).⁶⁸ Different reactors and procedures were

Scheme 5. Development of Continuous Processes for Grignard and Lithiation for the Synthesis of Benzyl Alcohol

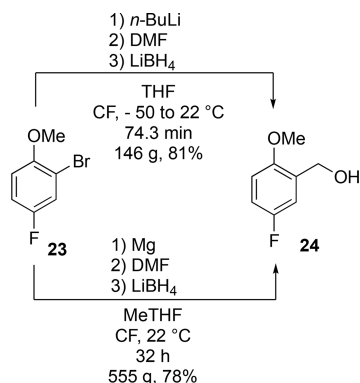

developed to produce the desired benzyl alcohol, using DMF (*N,N*-dimethylformamide) as the carbonyl source and LiBH₄ to reduce the intermediate aldehydes. Similar yields and product purities were obtained with either the lithiation or the Grignard method. Advantages of the lithiation approach include reduced generation of solid (this avoids clogging the

system), as well as allowing for a rapid reaction and the ability to use commercially available *n*-BuLi. The lithium halogen exchange, however, generated undesirable 1-bromobutane and butane side products. In contrast, the Grignard method was found to be more atom-economical and safer due to using less hazardous magnesium as opposed to pyrophoric *n*-BuLi. This approach used mild temperatures (20–40 °C), while the lithiation process required working at low temperatures (–50 °C) to avoid side reactions. More recently, the use of less pyrophoric hexyl lithium was reported in a similar halogen/lithium exchange reaction to perform in-line *C-tert*-butoxycarbonylation reactions.⁶⁹

Different lithiation reactions were also developed in continuous flow⁷⁰ for the synthesis of various organic compounds (Scheme 6): aryl boronic pinacol ester **31**,⁷¹ α -keto ester **30**,⁷² α -trifluoromethylamides **33**,⁷³ functionalized aryl fluorides **25**,⁷⁴ substituted aryl ketone **27**,⁷⁵ and α -haloalcohols **35**.⁷⁶ Complexes were generated *in situ* by reaction of the halide derivative with *n*- and *s*-BuLi or MeLi and were then reacted with the electrophilic species. Syntheses were highly efficient, yielding the corresponding products in up to 99% yield in only a few minutes. The aryl boronic pinacol ester **31** was scaled up to 26 g and was recovered in 99% yield after 4 h of total reaction.⁷¹ Interestingly, thanks to continuous flow and with a similar strategy, different substituted aryl ketones **27** were synthesized in a protecting-group-free procedure.⁷⁵

Scheme 6. Lithiation Reactions Developed Using the Continuous Flow Process

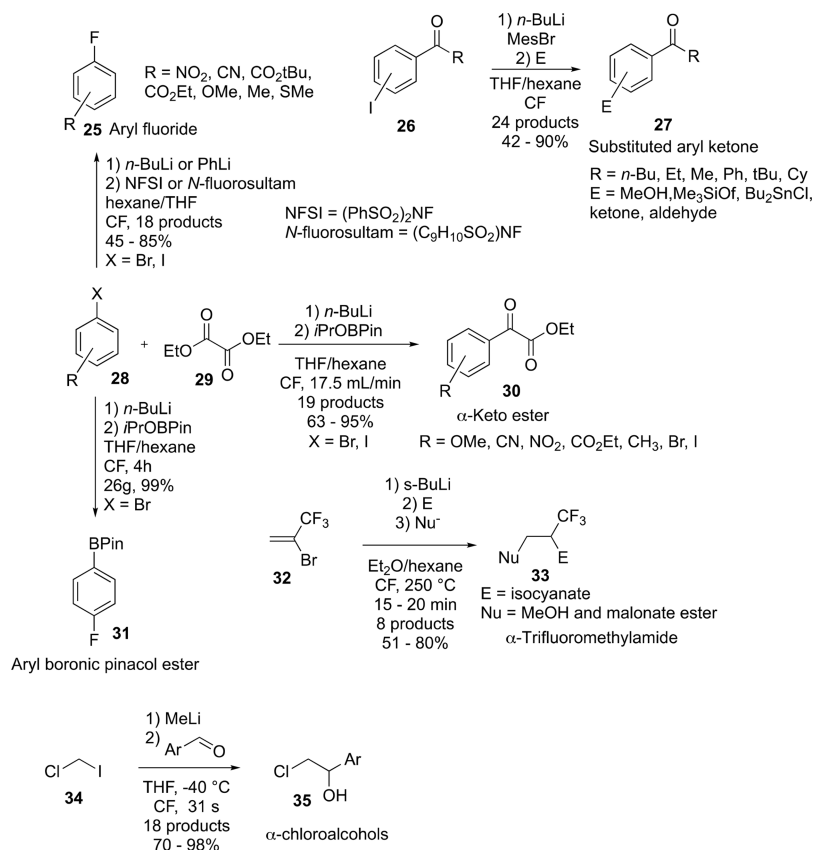

5. GROUPS 2, 3, 4, AND 5

5.1. Mechanochemical Procedures for Complexes of Groups 2, 3, and 4

Numerous syntheses of metal complexes containing Schiff bases have been described in the literature because of their good catalytic properties in a wide number of reactions including polymerization, reduction, oxidation, and C–C coupling reactions.⁷⁷ Interestingly, chiral Schiff-base-containing complexes were more selective in various reactions such as oxidation, hydroxylation, aldol condensation, and epoxidation than complexes featuring other ligands. In addition, Schiff base metal complexes exhibited numerous biological activities such as antifungal, antibacterial, antimalarial, antiproliferative, anti-inflammatory, antiviral, and antipyretic properties.⁷⁸ A large number of mechanochemical syntheses of metal complexes containing Schiff base ligands will be described in the following sections, beginning with zirconium, hafnium, and scandium Schiff base complexes.

Makhaev et al. reported the only mechanochemical synthesis of group 4 metal complexes containing a Schiff base. These complexes were used to catalyze ethylene polymerization.⁷⁹ Salen complexes **37** with a general formula $[\text{MCl}_2\text{L}_2]$ ($\text{M} = \text{Zr}$, Hf and $\text{L}^1 = N$ -(3,5-di-*tert*-butylsalicylidene)-2,3,5,6-tetrafluoroanilinate anion) were formed starting from a mixture of N -(3,5-di-*tert*-butylsalicylidene)-2,3,5,6-tetrafluoroaniline **36** (HL^1), NaH, and MCl_4 , first ground in a mortar and pestle and then transferred to an eccentric vibratory ball mill. The reaction mixture was subjected to grinding for 2 h at 12 Hz and then heated at 150 °C under vacuum to isolate both complexes in a 75–87% yield (Scheme 7). It was found that the reaction

Scheme 7. Mechanochemical Synthesis of Zr and Hf Complexes of N -(3,5-Di-*tert*-butylsalicylidene)-2,3,5,6-tetrafluoroanilinate Ligand L^1

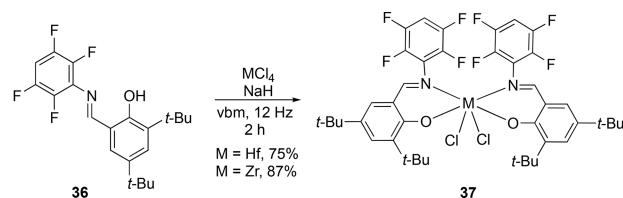

was very sensitive to purity and ratio of reagents. Traces of solvent in phenoxyimine led to complete inhibition of the reaction. Even though no explanation was given for this result, the purest complexes were formed by the activation of $\text{LH}-\text{NaH}-\text{MCl}_4$ in a 1:1 metal:ligand ratio rather than the 1:2 required by the stoichiometry of the final product. Interestingly, if complexes were synthesized during the milling process, high catalytic properties were observed only after heating the reaction mixture at 150 °C under vacuum.

During the same year, the mechanochemical synthesis of tris(allyl)-scandium species **39** using a disperser mill or a planetary ball mill was reported (Scheme 8).⁸⁰ A disperser mill is composed of a reactor containing a mixing arm and balls, usually made of metal. The rotation at high speed of the mixing arm creates vigorous movements of the balls, leading to a highly efficient mixing of the material placed inside the reactor. Notably, scandium complex **39** in Scheme 8 was unprecedented and never isolated from solution conditions.

In 2016, Boyde et al. performed the mechanochemical synthesis of Cp (cyclopentadienyl) complexes of titanium **41**, zirconium, and

Scheme 8. Mechanochemical Synthesis of Tris(allyl)scandium Species **39**

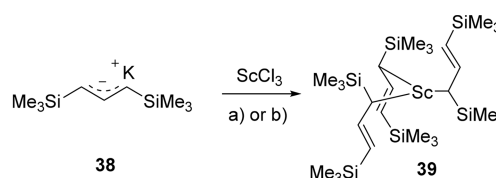

^aConditions: (a) disperser milling, 15 min, 25% (around 65 mg scale), (b) pbm, 600 rpm, 10 min, 48% (410 mg scale).

hafnium using halide metathesis (Scheme 9). Interestingly, starting from $[\text{MCp}_2\text{Cl}_2]$ ($\text{M} = \text{Zr}$ and Hf), the synthesis led to

Scheme 9. Mechanochemical Synthesis of $[\text{TiCp}(\text{O}t\text{-Bu})_3]$

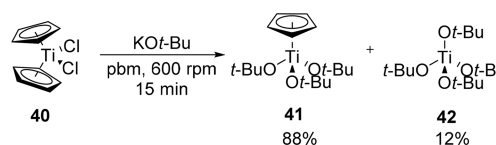

$[\text{MCp}_2(\text{O}t\text{-Bu})_2]$ complexes; however, starting from the titanium complex **40**, the reaction was selective in forming compound **41** as the major product.⁸¹ Remarkably, when the synthesis was carried out in hexane, the selectivity of the reaction was similar, but in a polar media such as THF, the synthesis was selective. Using ball milling, reactions could be completed in minutes, whereas hours were required for reactions performed in solution.

Makhaev et al. demonstrated the mechanochemical synthesis of vanadium(III) β -diketonates starting from vanadium chloride and sodium β -diketonates or potassium tetramethylheptanedionate **43** (Scheme 10).⁸² Five products were obtained in 43–85% yield after 1 to 3 h of mechanochemical treatment. Interestingly, products could be recovered after sublimation or extraction.

Scheme 10. Mechanochemical Synthesis of Vanadium(III) β -Diketonates

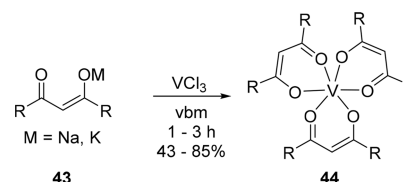

5.2. Microwave Irradiation for the Synthesis of Vanadium Complexes

To date there is just a single report of vanadium complex mechanochemical synthesis. In contrast, synthesis via microwave irradiation is more common. Coordination chemistry and reactivity of vanadium have been studied because of the physiological relevance of the metal and also for its activity in various industrial processes. A number of heterocyclic derivatives containing nitrogen and sulfur atoms such as benzothiazole (one of the most important) serve as a unique and versatile scaffold for experimental drug design. 1,10-Phenanthroline (phen, **46**) has been extensively used as a ligand due to its high chemical stability, its redox properties, and its good coordination capacity. Alias et al. decided to mix

Scheme 11. Synthesis of Mixed Benzothiazole/Phenanthroline Vanadium Complexes

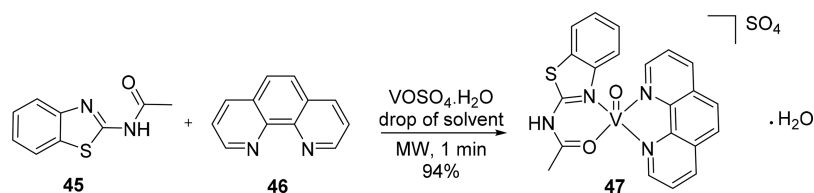

these two ligands in the same complex (Scheme 11). Vanadium(IV) sulfate hydrate, 2-acetamido-1,3-benzothiazole **45**, and 1,10-phenanthroline were first mixed in a grinder in a 1:1:1 ratio, and then the reaction mixture was irradiated in the microwave oven using a few drops of solvent.⁸³ In 1 min, the corresponding complex **47** was recovered in 94% yield after a simple filtration using ethanol.

Similarly, heating a solution of $\text{VOSO}_4 \cdot 5\text{H}_2\text{O}$ with different tetradentate Schiff base ligands **48** in DMF using refluxing conditions or microwave irradiation led to the synthesis of unsymmetrical salen-like vanadium complexes **49** (Scheme 12).⁸⁴ At reflux, 2–3 h was necessary to enable chelation, yet microwave irradiation required only 1 min to achieve better yields (80–84% in MW, 68–70% in solution).

Scheme 12. Microwave Synthesis of Schiff Base Vanadium Complexes

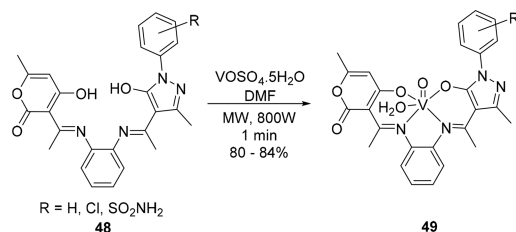

5.3. Synthesis of Vanadium Complexes Using Ultrasound

Salen-type vanadium complexes **52** were also synthesized by ultrasound irradiation. Merzougui et al. described the combination of ultrasound irradiation and solvent-free conditions for the synthesis of the tetradentate oxovanadium complex **52**. In contrast to classical Schiff base metal syntheses, condensation of diaminoethane **51** and 2-hydroxy-1-naphthaldehyde **50** was not realized before reaction with the metal source: in this procedure all the reagents, including the metal source, were mixed in a mortar before exposure to ultrasound (Scheme 13).⁸⁵ Ultrasonic activation yielded complex **52** in only 40 min and in 95% yield. In contrast, reaction in solution required 3 h at reflux for a yield of 78%.

Scheme 13. One-Pot Synthesis of Salen Vanadium Complex **52** by Ultrasonic Irradiation

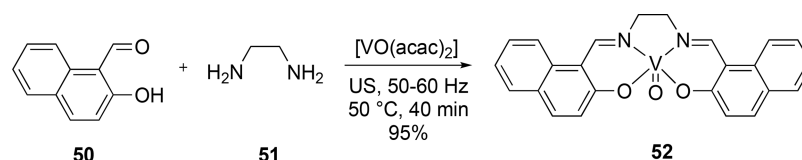

6. GROUP 6

6.1. Mechanochemical Synthesis of Molybdenum and Chromium Complexes

Molybdenum and chromium complexes exhibit similar properties in reactions such as epoxidation of alkenes.⁸⁶ Due to the rapid hydrolysis of imine ligands in an aqueous solution, the preparation of chromium complexes with ligands containing imine groups remains difficult in aqueous solvent systems. In organic solvents, the insolubility of ligands or metal sources often lowers the reaction efficiency. To avoid this limitation, the Makhaev group proposed the use of mechanical activation for reacting chromium(III) chloride and sodium 4-imino-2-pentanonate **53** (NaACIM) in 1994 (Scheme 14).⁸⁷ The

Scheme 14. Synthesis of Chromium Acetylacetonate Derivatives

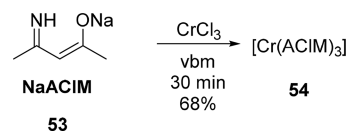

reaction was performed using a vibratory ball mill under nitrogen, and no byproduct was observed. To the best of our knowledge, this report is the only procedure developed for the synthesis of chromium complexes using mechanochemical activation.

Different complexes based on molybdenum possessing the general formula $[\text{MoO}_2(\text{MSAP})(\text{ROH})]$ **55** ($\text{H}_2\text{MSAP} = N$ -3-methoxysalicylidene-2-amino-3-hydroxypyridine, $\text{R} = \text{Me}, \text{Et}, \text{Pr}$) were ground in a mortar and pestle for a few minutes (5–35 min) to afford $[\text{MoO}_2(\text{MSAP})]$ **57** with loss of ROH (Scheme 15, reaction A).⁸⁸ Mortar and pestle were used instead of ball mills to allow the removal of alcoholic vapors from the system. Heating complexes **55** at 200 °C afforded the polymeric $[\text{MoO}_2(\text{MSAP})]_n$ **56** which could also be transformed into the monomeric complexes **57** by grinding in a mortar. The same results were reported using the *N*-salicylidene-2-amino-3-hydroxypyridine Schiff ligand.⁸⁹ In the presence of an *N*-donating ligand, both these monomeric and polymeric complexes could be transformed into $[\text{MoO}_2(\text{MSAP})(\text{NR}')]]$ **58** or $[(\text{MoO}_2(\text{MSAP}))_2(4,4'\text{-bipy})]$ **59** (bipy = bipyridine) complexes using ball milling (Retsch MM200) (Scheme 15, reaction B). Notably, liquid-assisted grinding (LAG) procedures using ACN (acetonitrile) or DCM

Scheme 15. Mechanochemical Transformation of $[\text{MoO}_2(\text{MSAP})(\text{ROH})]$

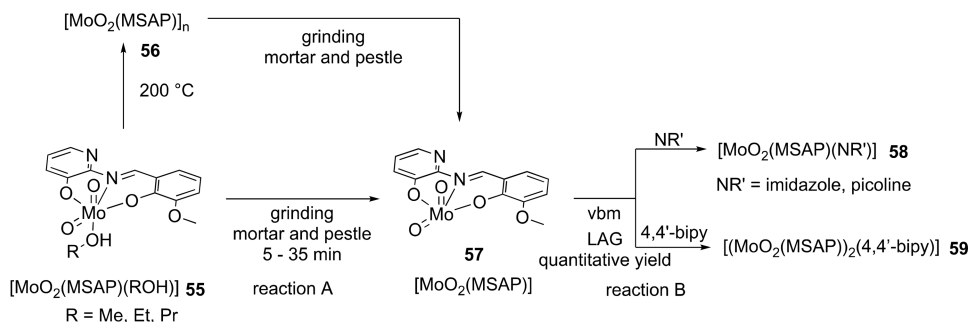

(dichloromethane) allowed isolation of the product in better yields. Using ball milling with an O-donating ligand did not lead to the desired complexes due to the sensitivity of the Mo–alcohol bond under mechanical treatment.

Nine different molybdenum(IV) O,N,O–Schiff base complexes **61** were mechanosynthesized using a Retsch MM200 vibratory ball mill operated at 25 Hz (Scheme 16).⁹⁰ Schiff

Scheme 16. Mechanosynthesis of Molybdenum Complexes Using a Liquid Additive

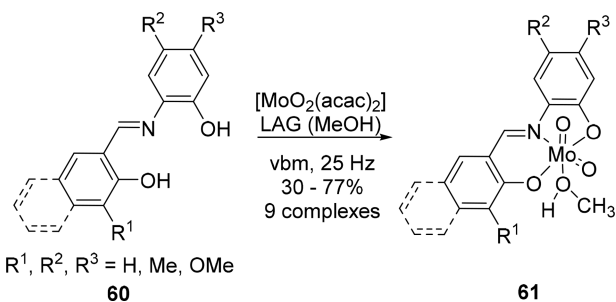

base ligands **60** and $[\text{MoO}_2(\text{acac})_2]$ (acac = acetylacetonate) were ground in equimolar quantities with a few microliters of MeOH as a liquid additive. The authors pointed out that these liquid additives played an important role in the stability of the intermediates that led to the formation of the complexes. Catalytic properties of all molybdenum complexes were examined for the epoxidation of cyclooctene, cyclohexene, and limonene. The best results were obtained using the complex coordinated with the Schiff base derived from 2-hydroxybenzaldehyde and 2-aminophenol.

6.2. Microwave Irradiation for the Synthesis of Group 6 Metal Complexes

As an example of a new procedure using microwave irradiation, the first microwave synthesis of $[\text{Cr}(\text{DPM})_3]$ (DPM = 2,2,6,6-tetramethyl-3,5-heptadionato) was described in 1990.⁹¹ A solution of $\text{CrCl}_3 \cdot 3\text{H}_2\text{O}$, urea, and dipivaloylmethane in a mixture of EtOH and water was heated in a Teflon container under microwave irradiation (500–600 W) for 40 s to obtain the complex in 71% yield. In conventional conditions, the synthesis required 24 h. Consequently, this procedure was definitely an improvement and a milestone for future applications of microwaves in organometallic synthesis.

A series of zerovalent organometallic carbonyl compounds with the general formula $[\text{ML}(\text{CO})_4]$ (M = Cr, Mo, or W and L = 1,2-ethylenediamine **51**, dpmp **62**, dppe **63**, and 2,2'-bipy **64**) were synthesized under microwave irradiation by Green and co-workers.⁹² Compared to the previously published

syntheses performed in solution, reaction times were reduced by a factor of 5 to over 300, and yields were also increased (Scheme 17). Interestingly, reaction times were found to be

Scheme 17. Synthesis of Zerovalent Organometallic Carbonyl Compounds

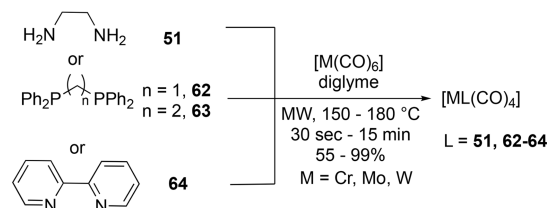

dependent on the metal source without any ligand influence: molybdenum complexes were synthesized in 30 s, chromium complexes in 5 min, and tungsten complexes in 15 min.

To demonstrate the potential of microwave irradiation, 23 organometallic compounds of group 6 were synthesized by the Osroft group in 2004 (Table 2).⁹³ Hexacarbonyl complexes and in particular molybdenum complexes reacted with a range of mono-, bi-, and tridentate P- and N-coordinating ligands in a modified conventional microwave oven (Table 2, entries 1–10 and 16–23). Interestingly, the selectivity of the reaction between PPh_3 and $[\text{Mo}(\text{CO})_6]$ was dependent on the quantity of PPh_3 (Table 2, entries 1 and 2). An inert atmosphere was not necessary for the reaction. Better yields and lower reaction times were obtained under microwave irradiation instead of classical refluxing conditions. A further advantage of the microwave synthesis approach was that no sublimation of the parent carbonyl was detected, thereby avoiding a potentially hazardous situation. This is often the case in conventional systems where sublimation can lead to a blockage of the condenser.

More recently, octahedral group 6 carbonyl complexes bearing phosphine or pyridyl ligands were synthesized by coupling borohydride catalyst and microwave heating using a laboratory microwave oven (Scheme 18).⁹⁴ The combination of alcohol solvents and borohydride salts was described to be ideal when combined with microwave heating. Both the hydroxyl group of the alcohol and the borohydride salt strongly absorbed microwaves resulting in a rapid temperature increase. This procedure gave better selectivity than when using solely microwave heating or longer conventional reflux conditions, and the pure *cis*- $[\text{Mo}(\text{PPh}_3)_2(\text{CO})_4]$ complex was isolated in 73% yield. Of note, pyridyl complexes were obtained in lower yield than phosphine complexes.

Table 2. Microwave-Assisted Synthesis of Different Organometallic Complexes of Group 6

entry	substrate	ligand (equiv)	product	time (min) ^a	yield (%)
1	[Mo(CO) ₆]	PPh ₃ (1.20)	[Mo(CO) ₅ (PPh ₃)]	40	85
2		PPh ₃ (2.40)	<i>trans</i> -[Mo(CO) ₄ (PPh ₃) ₂]	80	70
3		dppm 62 (1.20)	[Mo(CO) ₄ (62)]	20	87
4		dppe 63 (1.20)	[Mo(CO) ₄ (63)]	20	96
5		piperidine (excess)	[Mo(CO) ₄ (NHC ₅ H ₁₀) ₂]	40	83
6		2,2'-bipy 64 (1.20)	[Mo(CO) ₄ (64)]	20	94
7		1,10-phen 46 (2.20)	[Mo(CO) ₄ (46)]	15	91
8		pyridine (excess)	<i>cis</i> -[Mo(CO) ₄ (py) ₂]	20	50
9		dicyclopentadiene (2.00)	[MoCp(CO) ₃] ₂	60	94
10		acetic acid (excess)	[Mo ₂ (OAc) ₄]	45	48
11	[Mo(CO) ₄ (64)]	2,2'-bipy (2.15)	<i>cis</i> -[Mo(CO) ₂ (64) ₂]	90	53
12	[Mo(CO) ₄ (62)]	dppm 62 (1.20)	<i>cis</i> -[Mo(CO) ₂ (62) ₂]	40	63
13		dppe 63 (1.20)	<i>cis</i> -[Mo(CO) ₂ (62)(63)]	40	52
14	[Mo(CO) ₄ (63)]	dppe 63 (1.20)	<i>cis</i> -[Mo(CO) ₂ (63) ₂]	40	45
15	[MoCp(CO) ₃] ₂	diphenylacetylene (3.00)	[Mo ₂ Cp ₂ (CO) ₄ (μ -PhC ₂ Ph)]	120	39
16	[W(CO) ₆]	PPh ₃ (2.40)	[W(CO) ₄ (PPh ₃) ₂]	20	96
17		dppm 62 (0.90)	[W(CO) ₄ (62)]	20	68
18		piperidine (excess)	<i>cis</i> -[W(CO) ₄ (piperidine) ₂]	120	35
19		2,2'-bipy 64 (1.20)	[W(CO) ₄ (64)]	80	39
20		1,10-phen 46 (2.00)	[W(CO) ₄ (46)]	60	85
21	Cr(CO) ₆	piperidine (excess)	[Cr(CO) ₅ (piperidine)]	40	14
22		Et ₄ NCl·H ₂ O (1.10)	[Cr(CO) ₅ Cl][NEt ₄]	30	74
23		anisole (excess)	[Cr(η^6 -C ₆ H ₅ OMe)(CO) ₃]	240	45

^aMicrowave syntheses were carried out in a flask equipped with a water condenser and placed in a modified PROLINE program 1250 750 W microwave oven. dppm = bis(diphenylphosphino)methane. dppe = bis(diphenylphosphino)ethane.

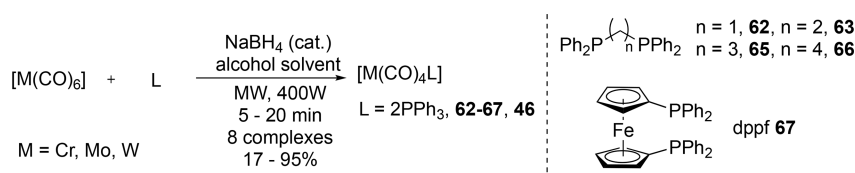
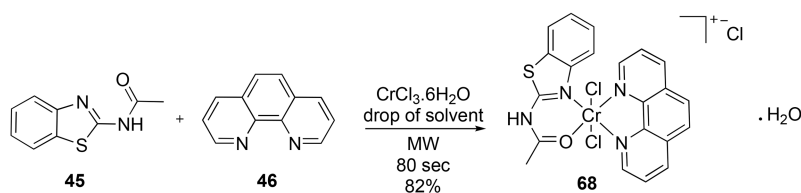
Scheme 18. Microwave-Assisted Synthesis of Group 6 Complexes Using NaBH₄ as Catalyst

Scheme 19. Synthesis of Mixed Ligand Chromium Complexes

In 2015, and as they did for the synthesis of vanadium complexes (see part 5.2, [Scheme 11](#)), Alias et al. described the microwave synthesis of the mixed phenanthroline and 2-acetamide benzothiazole chromium complex **68** that was produced after 80 s of heating and isolated in 82% yield ([Scheme 19](#)).⁸³

Between 2010 and 2016, the Jain group described the microwave synthesis of different chromium complexes with Schiff base ligands which were further used for their antimicrobial properties. [Cr(**74**)(H₂O)₃]Cl,⁹⁵ [Cr(**75**)Cl]·2H₂O,⁹⁵ [Cr(**78**)₂(H₂O)₂]·Cl,⁹⁶ [Cr(**80**)₂(H₂O)₂]Cl,⁹⁶ [Cr-(**84**)₂(H₂O)₂]Cl·2H₂O,⁹⁷ [Cr(**83**)(H₂O)₃]Cl₂,⁹⁷ [Cr(**88**)-(H₂O)Cl],⁹⁸ [Cr(**81**)₂(H₂O)₂]·Cl,⁹⁸ [Cr(**82**)₂(H₂O)₂]·Cl,⁹⁹ [Cr(**85**)₂(H₂O)₂]Cl,¹⁰⁰ and [Cr(**86**)₂(H₂O)₂]Cl¹⁰⁰ were synthesized as follows. Chromium salt and ligand were ground together and then transferred into a reactor with 3–5 mL of

dry EtOH to be heated under microwave irradiation ([Table 3](#), entries 1–11; see [Figure 1](#) for ligand structure). All products were recovered in higher yields and lower reaction times than when using conventional reflux conditions; reaction times did not exceed 14 min, while yields ranged from 57 to 87%.

The Fahmi group has also described the synthesis of Schiff base chromium complexes via microwave irradiation starting from CrCl₃ and ligand **72** or **73** ([Table 3](#)).¹⁰¹ Changing the metal:ligand ratio led to the selective formation of different complexes. With a 1:1 ratio, [CrCl(L)(H₂O)₂] complexes were formed ([Table 3](#), entries 12 and 14), while with a 1:2 ratio, [CrCl(L)₂(H₂O)] complexes were obtained ([Table 3](#), entries 13 and 15). In all cases, since concentration was increased in the procedure utilizing microwave irradiation, this led to a difficult comparison with the classical solution procedure. Ligand and metal complexes have been screened

Table 3. Synthesis of Schiff Base Chromium Complexes^a

entry	chromium complex	microwave synthesis		conventional heating		ref
		time (min)	yield (%)	time (h)	yield (%)	
1	[Cr(74)(H ₂ O) ₃]Cl	8	80	8	60	95
2	[Cr(75)Cl]·2H ₂ O	8	78	8	60	95
3	[Cr(78) ₂ (H ₂ O) ₂]Cl	9	79	8	61	96
4	[Cr(80) ₂ (H ₂ O) ₂]Cl	10	78	8	59	96
5	[Cr(84) ₂ (H ₂ O) ₂]Cl·2H ₂ O	9	78	8	60	97
6	[Cr(83)(H ₂ O) ₃]Cl ₂	8	76	8	57	97
7	[Cr(88)(H ₂ O)Cl]	9	79	10	62	98
8	[Cr(81) ₂ (H ₂ O) ₂]Cl	8	80	8	58	99
9	[Cr(82) ₂ (H ₂ O) ₂]Cl	9	75	9	61	99
10	[Cr(85) ₂ (H ₂ O) ₂]Cl	9	77	9	61	100
11	[Cr(86) ₂ (H ₂ O) ₂]Cl	8	79	9	65	100
12	[CrCl(72)(H ₂ O) ₂]	10	83	15	73	101
13	[CrCl(72) ₂ (H ₂ O)]	10	87	14	87	101
14	[CrCl(73)(H ₂ O) ₂]	12	80	16	70	101
15	[CrCl(73) ₂ (H ₂ O)]	14	84	14	77	101

^aSee Figure 1 for the structure of ligands.

in vitro for antimicrobial activity and *in vivo* for antifertility activity on male albino rats. Of note, the complexes are more potent than the parent ligands.

Similarly, a series of Salen-type chromium complexes were synthesized using microwave irradiation starting from tetradentate schiff base ligands **107** (Scheme 20).¹⁰² Complexes **108** were obtained rapidly in good yields and exhibited antimicrobial activity.

Interestingly, Whittaker and Mingos described different reactions under microwave irradiation, in a modified domestic oven, using metal powder.¹⁰³ Thus, chromium powder was transformed into a sandwich organometallic species **110** in reasonable yield (52%) when treated with AlCl₃, toluene, and HCl gas (Scheme 21, pathway A). The same complex as well as **109**, a similar one derived from benzene, could be synthesized using a mixture of aluminum powder, AlCl₃, and CrCl₃ (Scheme 21, pathway B). Reactions were not chosen to display any significant increase in reaction rate and/or yields but rather to demonstrate the possibility of using metal powder under microwave irradiations. Despite this, reaction times were considerably reduced from hours to only a few minutes using microwave irradiation instead of classical solution conditions. Although utilization of zerovalent metal powders is known to be highly reactive under microwave irradiations, no peculiar incident and/or process deviation were reported by the authors.

The conventional synthesis of (η^6 -arene)-tricarbonylchromium complexes was described as being limited by the high temperature and long reaction time required. To overcome this hurdle, many useful complexation reagents were developed for the synthesis of arene chromium complexes such as [Cr(CO)₃(L)₃] **111** (L = py, NH₃, η^6 -naphthalene, and ACN which were considered as labile ligands). These procedures required a step involving derivatization of chromium hexacarbonyl into **111**. This derivatization was shown to be unnecessary when using microwave irradiation for the reaction of [Cr(CO)₆] and various arenes. The procedure produced the complexes in 1 h and in 48–79% yields while being economical in atoms and steps (Scheme 22).¹⁰⁴ Interestingly, this strategy was applied to the synthesis of

112, a tricarbonylchromium complex of a steroid-like compound.

Peroxo complexes and in particular oxodiperoxo molybdenum complexes bearing bidentate ligands are widely used in the epoxidation of olefins. The oxodiperoxo complex [MoO(O₂)₂(tbbpy)] **114** (tbbpy = 4,4'-di-*tert*-butyl-2,2'-bipyridine) was isolated from the reaction of [MoO₂Cl₂(tbbpy)] **113** in water under microwave irradiation at 120 °C for 4 h (Scheme 23).¹⁰⁵ Of note, it was the first report describing the isolation of this type of complex in the absence of a highly oxidant species such as H₂O₂ or peroxide. Oxidation was only due to atmospheric oxygen. When the same reaction was carried out under classical reflux conditions, no formation of the oxodiperoxo complex was observed.

Due to their potential relevance as model systems for molybdenum enzymes, numerous papers reported the synthesis of metallacyclic oxomolybdenum complexes. As for vanadium oxide described earlier (see section 6.2), a novel synthesis of unsymmetrical Schiff base complexes with oxocation of molybdenum was realized using classical stirring and microwave technology. In solution, 8–10 h of stirring was generally necessary to afford the desired complexes in 59–61% yield. When performing the same reaction under microwave irradiation, reaction time was decreased to 1 min, and complexes **115** were recovered in 77–79% yield (Scheme 24).⁸⁴

cis-[Mo(CO)₄(piperidine)₂] **117**¹⁰⁶ and *cis*-[Mo(CO)₄(pzpy)] **118**¹⁰⁷ (pzpy = ethyl[3-(2-pyridyl)-1-pyrazolyl]acetate) were synthesized by reacting [Mo(CO)₆] under microwave irradiation with piperidine and pzpy **116**, respectively (Scheme 25, reactions A, B, and C). Complexes were recovered in shorter reaction times and in higher yields than when obtained by synthesis in solution. Interestingly, due to the lability of the amine ligand, simple ligand substitution reactions in **117** could be carried out using various nucleophiles such as triphenylphosphine. Notably, the synthesis of **118** under microwave irradiation enabled shortening of the synthetic scheme by one step. In solution, **118** had to be synthesized by ligand substitution of **117**.

Optimization of organometallic complex production via microwave irradiation is generally limited by the necessity to carry out *ex situ* analysis of the reaction mixture, leading to laborious and time-consuming step-by-step optimization. To solve this problem, Barnard and Leadbeater developed equipment for real-time monitoring of organometallic reactions under microwave irradiation using *in situ* Raman spectroscopy.¹⁰⁸ This setup was utilized to efficiently monitor the ligand substitution reactions of [Mo(CO)₆]. Thus, the formation of mono-[Mo(CO)₅L], bi-[Mo(CO)₄L₂], and tri-[Mo(CO)₃L₃] species could be detected and analyzed by *in situ* Raman spectroscopy during the course of the reactions (ligand = Py, octylamine, and PPh₃).

Molybdenum complex **118** (Scheme 25) and *cis*-[W(CO)₄(pzpy)] **119** (Scheme 26) were synthesized under microwave irradiation from ligand **116** with [Mo(CO)₆] and [W(CO)₆], respectively. Tungsten complex **119** was obtained after 15 min irradiation, with longer reaction times required compared to that of molybdenum complex **118** due to the lower reactivity of [W(CO)₆] compared to [Mo(CO)₆] (15 min instead of 30 s).¹⁰⁷

Incorporation of an organometallic functional group into a biomolecule to modify its properties has been developed recently. For instance, tungsten-containing pyrimidines such as

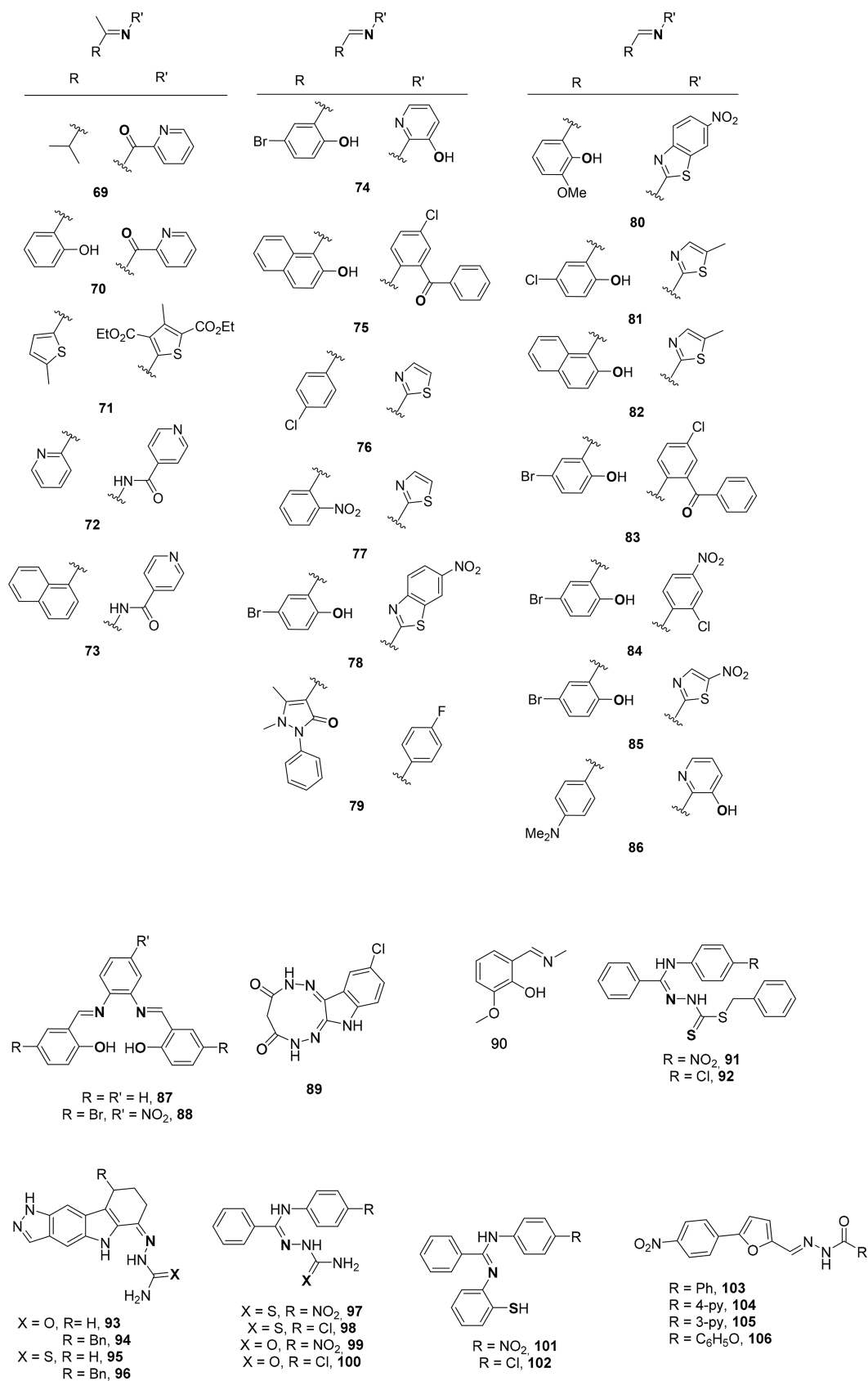
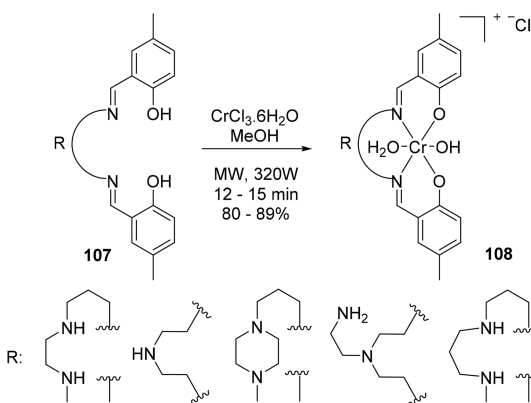

Figure 1. Schiff base ligand used for the synthesis of metal complexes under microwave irradiation.

121–123 have been interesting for their biological properties; compounds were identified as ethologically active compounds

in the ponerine ant *Megaponera fetens*. Their syntheses were described in solution by reaction of alkynyl alkoxy carbene

Scheme 20. Synthesis of Salen-Type Chromium Complexes Using Microwave Irradiation



Scheme 21. Sandwich Chromium Species Formation under Microwave Irradiation

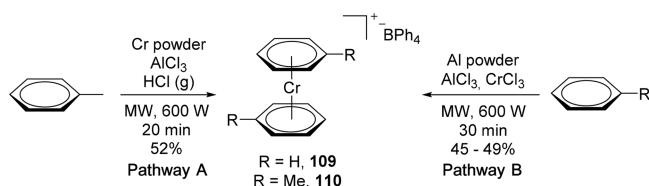

metal complexes with mono- and dimethyl ureas, furnishing the heterocycles in high yields but in long reaction times. By using microwave irradiation, reaction time was considerably reduced from hours (at room temperature) to a few minutes (at 60 °C) (Scheme 27).¹⁰⁹ Despite this, yields were in the same range as conventional solution-based synthesis. Change of the acetylene moiety was studied: a trimethylsilyl-substituted alkynyl carbene complex was used, but low yields were obtained due to the easy desilylation of the starting material.

6.3. Photochemistry for Synthesis of Group 6 Metal Complexes

Photochemical ligand substitution of group 6 metal complexes is a well-known reaction. Mechanism investigations demonstrated that labile ligands were easily removed at the beginning of the reaction, in particular CO ligands that were released from the reaction as gas. An exogenous ligand could further react with the intermediate photolyzed species. In this part, different substitutions will be described. Two different photochemical methods for the synthesis of arene-chromium $[\text{Cr}(\text{arene})(\text{CO})_3]$ **111** were developed in 1989. The first involved irradiation with a mercury lamp of a $[\text{Cr}(\text{CO})_6]$ solution and arene in THF (Scheme 28, reaction A), while the second proceeded by the same irradiation of a suspension of

Scheme 22. Microwave Synthesis of Arene Chromium Complexes

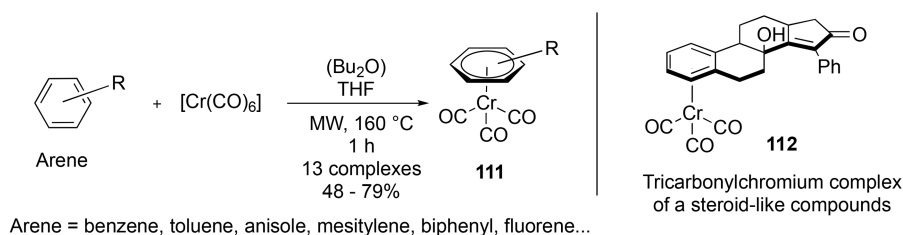

Scheme 23. Synthesis of Oxodiperoxo Molybdenum Complex 114 Using Air as an Oxidant

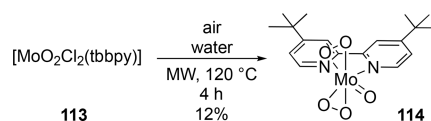

Scheme 24. Schiff Base Complexes of Molybdenum Oxide Synthesized under Microwave Irradiation

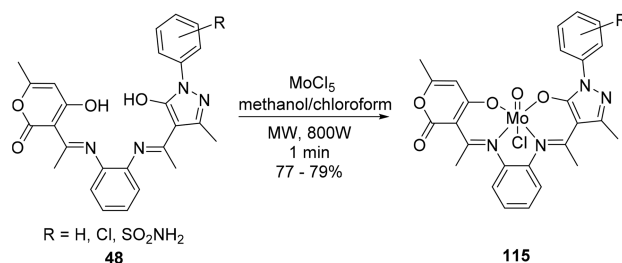

Scheme 25. Microwave Transformation of $[\text{Mo}(\text{CO})_6]$ under Microwave Irradiation

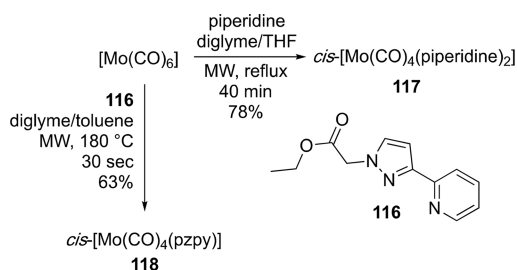

Scheme 26. $[\text{W}(\text{CO})_4(\text{pzpy})]$ Formation under Microwave Irradiation

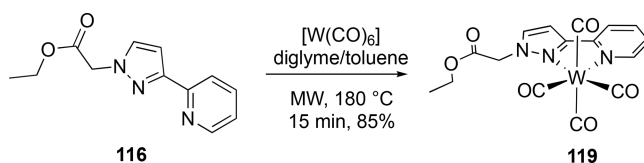

$[\text{Cr}(\text{CO})_6]$ in THF before adding the arene in the reaction mixture (Scheme 28, reaction B).¹¹⁰ Different arenes were used (e.g., benzene, halobenzene, anisole, *N,N*-dimethylaniline, and methylbenzoate, etc.), and interestingly, thermal sensitive arene-containing substrates resulted in the corresponding products with satisfying yields. Notably, yields were lower than those obtained classically via thermal solvent-based methods; yet the milder reaction conditions under photochemical conditions gave an additional advantage to this protocol. Significantly, this procedure was effectively applied to

Scheme 27. Microwave-Assisted Synthesis of Tungsten Uracil-Analogue Fisher Carbene Complexes

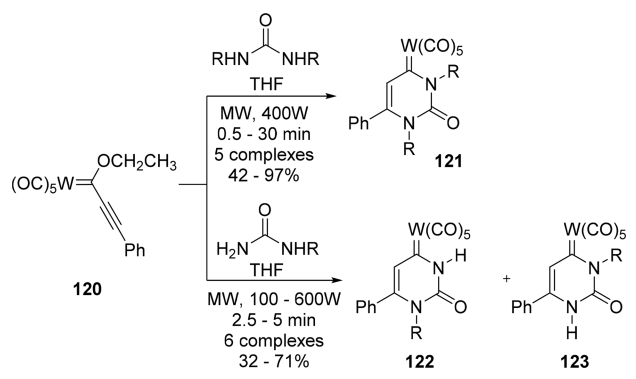

the synthesis of $[\text{W}(\text{C}_6\text{H}_5\text{OMe})(\text{CO})_3]$ that contained an electron-rich arene and which could be recovered in 24% yield (Scheme 29, reaction A). Moreover, the irradiation of $[\text{Cr}(\text{benzene})(\text{CO})_3]$ in the presence of an excess of piperidine led to the formation of the $[\text{Cr}(\text{piperidine})(\text{CO})_3]$ complex.¹¹¹

Preparation of hexaalkylborazole chromium complexes could not be achieved by thermal activation. The reaction was consistently unsuccessful despite considerable efforts to make it succeed. Contrastingly, photolysis under reduced pressure of $[\text{Cr}(\text{CO})_6]$ in the presence of hexaalkylborazole ligands led to the formation of the desired complexes in excellent yields (Scheme 28, reaction C).¹¹² Moreover, half-sandwich-type complexes with the general formula $[\text{CrL}(\text{CO})_3]$ ($\text{L} = (\text{C}_2\text{H}_5)_3\text{B}_3\text{N}_3(\text{CH}_3)_3$, $(\text{CH}_3)_3\text{B}_3\text{N}_3(\text{C}_2\text{H}_5)_3$, C_6H_6 , $\text{C}_3\text{H}_5\text{N}$, $\text{C}_6\text{H}_5\text{CN}$, and mesitylene) could also be synthesized by photochemical reaction of $[\text{Cr}(\text{CO})_6]$ in the presence of the ligand under reduced pressure. Complexes were recovered in 80–90% yields after only 1 h of irradiation using a mercury vapor lamp (125 W). Interestingly, reactions were performed without the use of a traditional bulk solvent. They were replaced by the ligands that were liquid at room temperature and used in excess. Moreover, reactions performed under atmospheric pressure failed, and this failure could be explained by the nonfavorable equilibrium of nucleophilic substitution under these conditions. In order to shift the equilibrium of the reaction toward the formation of the complex, CO ligands had to be removed under reduced pressure. Starting from the same chromium source, irradiation with a mercury vapor lamp of a solution of $[\text{Cr}(\text{CO})_6]$ in acetonitrile led to the photochemical substitution of two carbonyls by the acetonitrile ligand in 20

Scheme 29. Photochemical Transformation of $[\text{W}(\text{CO})_6]$

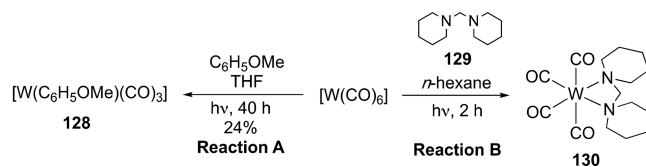

min, leading to the formation of $\text{cis}-[\text{Cr}(\text{CO})_4(\text{ACN})_2]$ **124** (Scheme 28, reaction D).¹¹³ While shorter reaction times led to incomplete conversion and formation of the monosubstituted complex, the $\text{fac}-[\text{Cr}(\text{CO})_3(\text{ACN})_3]$ complex started to be detected after more than 30 min irradiation. In comparison, the reaction under thermal conditions led to the formation of the complex after 24h. The product was, however, contaminated by both the mono- and the trisubstituted derivatives. Complex **124** ($\text{cis}-[\text{Cr}(\text{CO})_4(\text{dppm})]$ **126** in 65% and to $\text{trans}-[\text{Cr}(\text{CO})_4(\text{PPh}_3)_2]$ **125** in 79% yield after conventional heating with dppm **62** and PPh_3 , respectively.

Photolysis of $[\text{Cr}(\text{CO})_6]$ could also be performed under pressure of propene (1370 psi), obtaining $[\text{Cr}(\text{CO})_5(\eta^2-\text{C}_3\text{H}_6)]$ **127** in 60% yield. Under pressure, propene was transformed into a liquid that acted as both a reagent and a solvent (Scheme 28, reaction E).¹¹⁴ Under N_2 or H_2 atmosphere, photolysis of this last complex led to the formation of $[\text{Cr}(\text{CO})_5\text{X}_2]$ ($\text{X} = \text{N}$ or H) or $\text{cis}-[\text{Cr}(\text{CO})_4(\eta^2-\text{C}_3\text{H}_6)\text{X}_2]$ by losing either C_3H_6 or CO .

Similarly to chromium complexes, photochemical ligand substitution was described for tungsten complexes. As piperidinium chloride and dipiperidylmethane **129** were observed after reaction of $\text{cis}-[\text{W}(\text{CO})_4(\text{pip})_2]$ with piperidine in DCM, Kociecka et al. decided to investigate the direct photochemical reaction of **129** with $[\text{W}(\text{CO})_6]$ in hexanes (Scheme 29, reaction B).¹¹⁵ Interestingly, the diamine was found to be a good chelating ligand, and the resulting complex **130** was more stable than $[\text{W}(\text{CO})_4(\text{pip})_2]$. The new bidentate amine tungsten complex **130** was the first example of a metal being coordinated by a diamine ligand with nitrogen atoms separated by such a short distance.

Nucleophilic photochemical substitutions of $[\text{M}(\text{CO})_6]$ were also studied by using buckminsterfullerene (C_{60}). Indeed, sunlight-induced photoreactions of $[\text{M}(\text{CO})_6]$ ($\text{M} = \text{Mo}$ and W) with C_{60} in hexane led to the formation of $[\text{M}(\text{CO})_5(\eta^2-\text{C}_{60})]$ **131** in 2 h. The complexes were recovered in 80–90% yield (Scheme 30).¹¹⁶

Scheme 28. Photochemical Reaction of $[\text{Cr}(\text{CO})_6]$ Leading to the Formation of Different Chromium Complexes

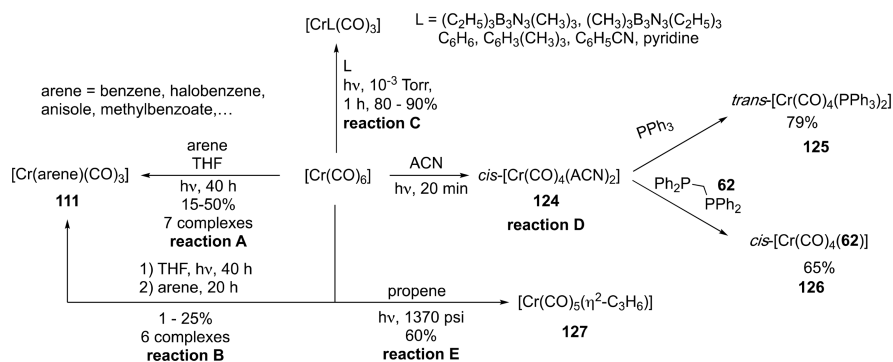

Scheme 30. Photochemical Synthesis of $[M(CO)_5(\eta^2-C_{60})]$

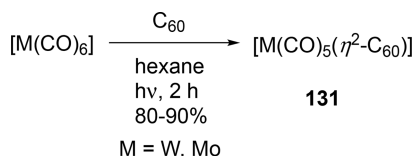

The photoreaction of $[Mo(CO)_6]$ with $P(n-Bu)_3$ was studied in 1980 by Post et al. and led to the formation of complexes bearing various substitution configurations: $[Mo(CO)_5(P(n-Bu)_3)]$ **132**, *cis*- and *trans*- $[Mo(CO)_4(P(n-Bu)_3)_2]$ **133**, and *cis*- and *trans*- $[Mo(CO)_3(P(n-Bu)_3)_3]$ **134** (Scheme 31, reaction A).¹¹⁷ The reaction could be performed using a sun lamp or a mercury lamp, with reaction time reduced to only 1 or 4 h, respectively. Interestingly, the study included the separation of the product mixture by chromatography and led to pure complexes.

In 1987, Manuta et al. described the formation of complex **135** ($[Mo(CO)_4(2,2'-bipy)]$) by photolysis of a solution containing $[Mo(CO)_6]$ and 2,2'-bipyridine using a mercury lamp (200 W).¹¹⁸ In only 30 min, **135** was recovered in 80% yield (Scheme 31, reaction B). Further substitution could be achieved by photochemical irradiation of a solution of **135** containing the coordinating PPh_3 ligand. These conditions led to the formation of $[Mo(CO)_3(2,2'-bipy)(PPh_3)]$ **136** after only 5 min of reaction (Scheme 31, reaction C). In the same conditions as described previously, photolysis of $[Mo(Cp)(CO)_3]$ in the presence of liquid propene led to the formation of $[Mo(Cp)(CO)_2(\eta^2-C_3H_6)]$.¹¹⁴ $[Mo(Cp^*)(CO)_2(\eta^2-C_3H_6)]$ (Cp^* = pentamethylcyclopentadienyl) was synthesized by thermal activation and was more stable than the Cp derivative.

Recently, Sener et al. described the photosynthesis of $[M(CO)_5(L)]$ **138** from $[M(CO)_6]$ and imine ligands **137** ($L = 3$ -[4-ethyl(phenyl)imino][1*H*-indol-2-one] or 3-[4-butyl(phenyl)imino][1*H*-indol-2-one] and $M = Mo, Cr, \text{ and } W$) (Scheme 32).¹¹⁹ Similarly, **138** was formed starting from $[Mn(CO)_3Cp]$ and imine ligands upon decoordination of the Cp ligand.

6.4. Continuous Flow Chemistry for Synthesis of Chromium Complexes

In conventional conditions, syntheses of arene–chromium complexes are reported at high temperature using the arene as the solvent and reacting for 1–4 days. In addition, the procedure was complicated by the sublimation of $[Cr(CO)_6]$

Scheme 31. Photochemical Reaction of $[Mo(CO)_6]$

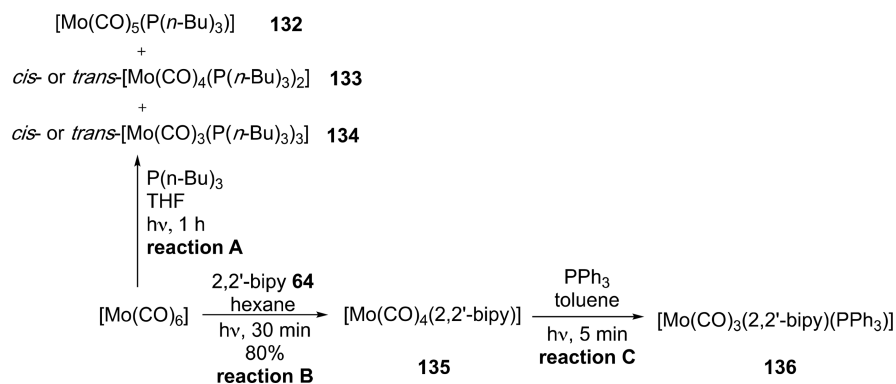

Scheme 32. Photosynthesis of $[M(CO)_5(L)]$ Complexes

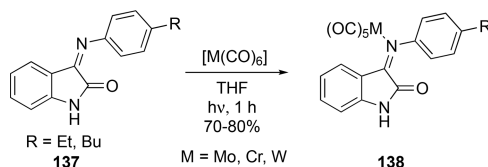

and the competitive decomposition of the arene chromium product due to long reaction times. These complexes could be synthesized more easily by an indirect route starting from naphthalene chromium tricarbonyl complex or with chromium complexes bearing three labile ligands. A continuous flow process was used in 2012 by Lee et al. to develop an efficient synthesis of the $[Cr(\text{arene})(CO)_3]$ complex which avoided all usual synthetic problems. For example, $[Cr(C_6H_5CH_3)(CO)_3]$ **139** was synthesized directly from $[Cr(CO)_6]$ and toluene in only 10 min (Scheme 33).¹²⁰ This complex could be

Scheme 33. First Use of the Continuous Flow Process for the Synthesis of the Arene Chromium Tricarbonyl Complex

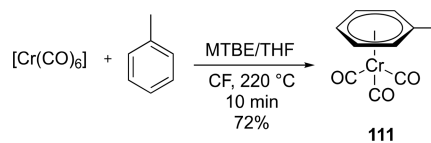

made on the gram scale and was recovered in 72% yield. Three other complexes were made with quantitative conversion by applying this procedure (cumene, chlorobenzene, and acetophenone). Unsurprisingly, the use of anisole or bromoacetophenone as substrates did not lead to the desired complexes, using neither this procedure nor the classical solution conditions. To the best of our knowledge, this is, today, the first and only synthesis of chromium complexes using a continuous flow process.

7. GROUP 7

7.1. Mechanosynthesis of Rhenium Complexes

Rhenium complexes have been thoroughly investigated for their fluorescence and applications in cell imaging.¹²¹ Interestingly, these rhenium species exhibited little or no intrinsic toxicity, while the ligand itself could be highly toxic. In 2014, the group of Frišćić developed the mechanosynthesis of families of complexes with the general formulas $[Re-$

$X_2(CO)_2Cp]$ and $[ReX_2(CO)_2Cp^*]$.¹²² Conventional syntheses involved complex starting materials, multistep reactions, photolysis, high pressures, and/or aggressive reagents such as halogens (Br₂, pyridinium perbromide) or acids (trifluoroacetic acid and AlCl₃). To circumvent these issues, the authors described a simple and quick mechanosynthesis starting from metal halides, halogen salt, and oxone (2KHSO₅·KHSO₄·K₂SO₄) in the absence of solvent. Two different isomers could be formed during the reaction: the diagonal (*diag*-) and the lateral (*lat*-) isomers **141** and **142** (Table 4). Using different

Table 4. Mechanosynthesis of Rhenium Complexes

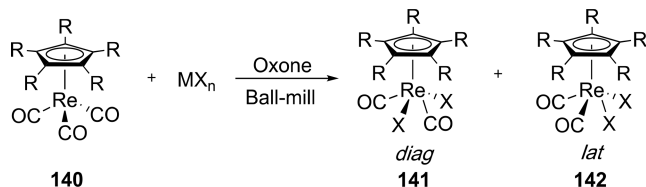

entry	Re source	MX _n	<i>diag</i> / <i>lat</i> ratio	yield of major isomer (%)
1	R = H, [Re(CO) ₃ Cp]	NaBr	98:2	89
2		CuBr	30:70	50
3		CuCl ₂ ·2H ₂ O	10:90	75
4		NaI	61:39	50
5	R = Me, [Re(CO) ₃ Cp*]	CuBr	16:84	57
6		CuCl ₂	10:90	56
7		NaI	17:83	74

sources of bromide, an interesting change in selectivity was observed. Thus, milling NaBr with $[Re(CO)_3Cp]$ for only 30 min at 30 Hz gave *diag* isomer **141** with a 98:2 selectivity (Table 4, entry 1). Contrastingly, milling the same rhenium complex with CuBr or CuCl₂·2H₂O predominantly gave *lat* isomer **142** in 70:30 and 90:10 ratio, respectively (Table 4, entries 2 and 3). Interestingly, using LiBr as a source of bromide resulted in almost no selectivity. Yet, adding a few drops of water during milling gave only the *diag* isomer **141**. Similar syntheses were described with $[Re(CO)_3Cp^*]$ as a substrate, giving corresponding complexes with good selectivity, yields higher than 50%, and in only 30 min (Table 4, entries 5–7).

The same group also demonstrated the power of mechanochemistry for the synthesis of different rhenium complexes in the context of developing model radiopharmaceuticals containing the *fac*- $Re(CO)_3$ species.¹²³ Five minutes of milling was necessary to obtain pentacarbonylrhenium halides (Cl, Br, I) in 85–96% yield starting from $[Re_2(CO)_{10}]$ (Scheme 34). Notably, pentacarbonylmanganese halide complexes **144** were synthesized using the same procedure in 28–88% yield. Furthermore, the use of mechanochemistry eliminated the need for elementary halogens, toxic solvents, or photolytic activation usually used for the synthesis of these compounds. Besides, complex **144** was transformed into a tribromide complex $[ReBr_3(CO)_3] \cdot [TEA]_2$ **145** by milling with an excess of tetraethylammonium bromide (TEAB) in a tungsten carbide milling jar placed in a vibratory ball mill operated at 30 Hz. Ligand substitution using 1,10-phenanthroline was also possible in a ball mill. Finally, the efficiency of this approach was demonstrated in multicomponent reactions,

Scheme 34. Mechanosynthesis of Rhenium Complexes

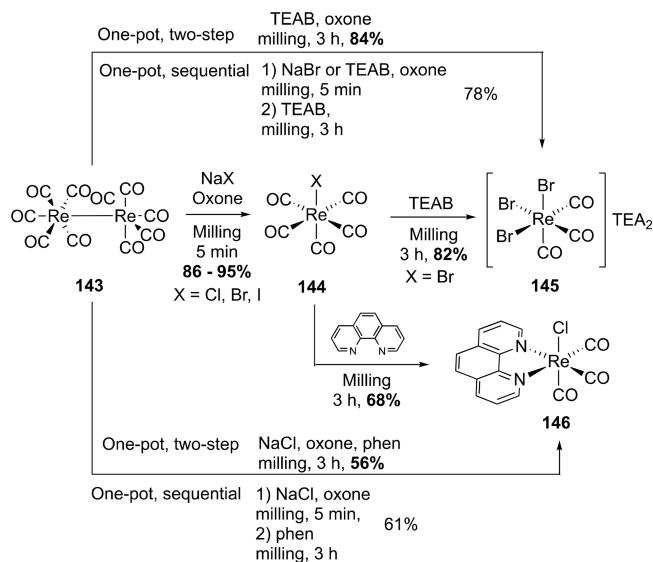

which could be performed in one pot, allowing the assembly of the complex or solution-sensitive organometallic species.

Similarly, rhenium complex **150** featuring *N,N,N',N'*-tetramethylethylenediamine **149** (TMEDA) and a fluorine atom as ligands was mechanosynthesized in excellent yield (Scheme 35). Its formation could be performed sequentially, starting from $Re_2(CO)_{10}$ **143**, through oxidative addition in the presence of sodium iodide and oxone, ligand exchange with a fluoride, and coordination of TMEDA. Alternatively, highly efficient one-pot procedures have been developed. Importantly, treatment of the reaction to form **150** had to be performed in a glovebox to avoid degradation of the moisture-sensitive $[ReF(CO)_5]$ intermediate **147**. Indeed, in the presence of water, the pentacarbonyl rhenium fluoride complex was hydrolyzed into $[Re(CO)_3]_4[OH]_4$ **148** (Scheme 35).

The superoxide anion has been associated with neurological disorders such as Parkinson's and Alzheimer's diseases. Among metal complexes capable of catalyzing dismutation of the superoxide anion, manganese complexes are effective and currently used for developing SOD (superoxide dismutase) mimics.⁷ Other biological properties of manganese complexes, such as the selective binding to quadruplex over duplex DNA (desoxyribonucleic acid), were also reported.⁶ Despite this, there is only one report of Mn complex mechanosynthesis in the literature. Milling manganese powder with *ortho*-quinone **151** and pyridine under atmospheric air led to the formation of the previously unknown mononuclear manganese complex $[Mn(SQ)_2(Py)_2]$ **152** (SQ = semiquinonate) using solid-state metal oxidation and direct coordination of the ligand formed *in situ* to the metal (Scheme 36).¹²⁴ Similar conditions were used for the synthesis of numerous zinc complexes (see section 12.1).

7.2. Microwave Irradiation for the Synthesis of Group 7 Metal Complexes

In an early paper dealing with microwave syntheses, $KReO_4$ and PPh_3 were heated in ethanol/water (10:1) in a modified microwave oven (250–350 W).¹²⁵ A round-bottom flask was placed in the microwave cavity with the water-cooled reflux condenser outside. This setup allows the solutions to heat quickly and to reflux safely without a buildup of pressure and the release of volatile solvents into the atmosphere (Figure 2).

Scheme 35. Mechanochemical synthesis of the Fluoride-Containing Rhenium Complex

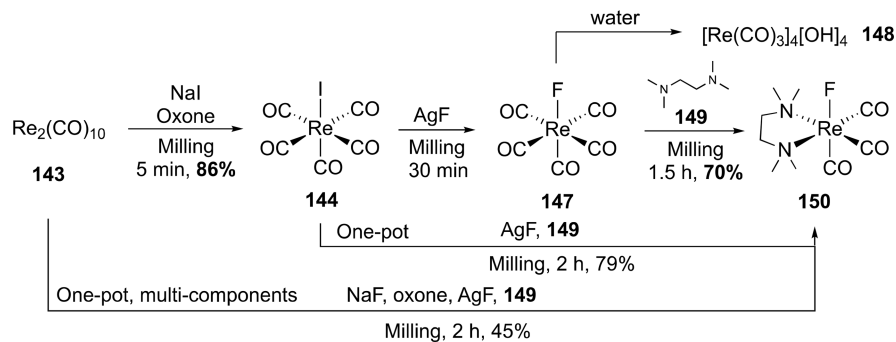

Scheme 36. Use of Manganese Powder for the Synthesis of the $[\text{Mn}(\text{SQ})_2(\text{Py})_2]$ Complex

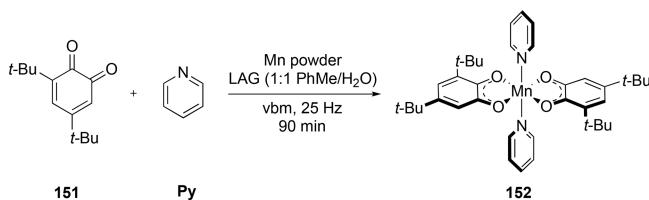

Scheme 37. Synthesis of Dirhenium Paddlewheel Complexes

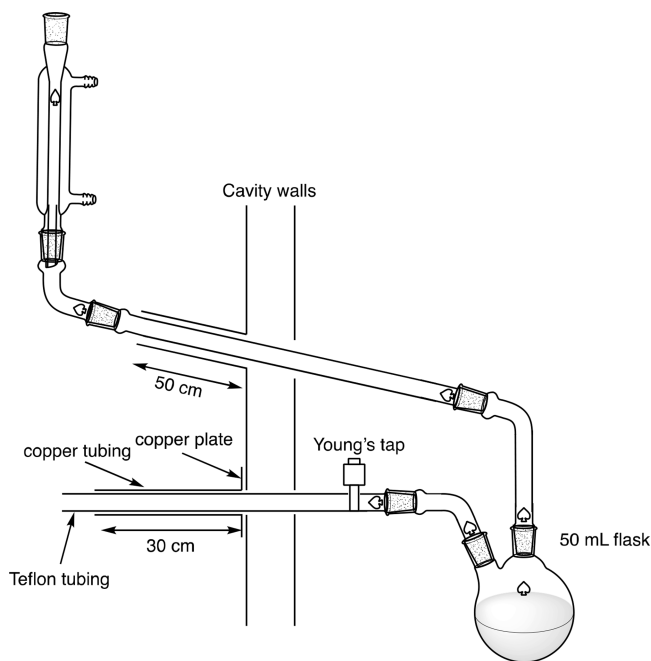
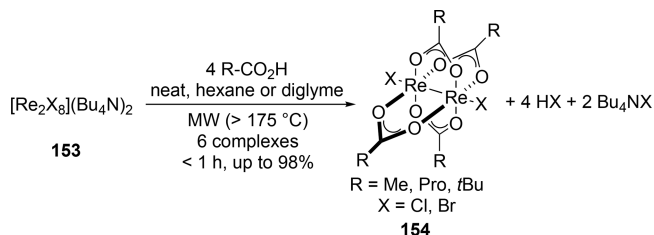

Figure 2. Modified microwave heating system.

The atmosphere in the flask could be controlled by a Teflon tube connected to an inert gas bottle. Using this homemade equipment, $[\text{ReOCl}_3(\text{PPh}_3)_2]$ was synthesized in 30 min of heating and isolated in 94% yield. Notably, in the literature 5 h was necessary to obtain full conversion. Even if the reaction time was considerably reduced via microwave irradiation, the temperature was difficult to control and could be 100 °C higher than in conventional reflux conditions.

In 2015, Reed et al. described the microwave synthesis of six dirhenium paddlewheel complexes **154** (Scheme 37).¹²⁶ The reactions were performed under inert atmosphere and were heated in a Discover S microwave reactor with an Explorer System (2455 MHz). $[\text{Re}_2\text{Cl}_8][\text{Bu}_4\text{N}]_2$ **153** with a mixture of

acid and anhydride was heated in neat conditions or with hexane or diglyme in a reaction vessel. In all cases, microwave synthesis allowed full conversion in significantly shorter time (<1 h) compared to the traditional reflux conditions (1 h to 4 days) and with higher yields. However, using butyric and pivalic acid resulted in increased reaction times and lowered yields. However, the method was still more efficient than a traditional reflux.

Starting from MO_4^- ($\text{M} = \text{Re}$, $^{99\text{m}}\text{Tc}$, and $^{186/188}\text{Re}$), a rapid multistep microwave synthesis was developed for the preparation of molecularly targeted Tc- and Re-based imaging and therapy agents **155** (Scheme 38).¹²⁷ Four steps developed

Scheme 38. Microwave Synthesis of Tc- and Re-Based Imaging and Therapy Agents

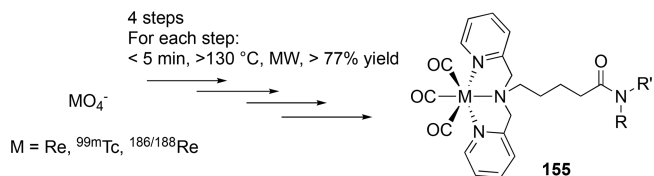

in a microwave oven using a Biotage Initiator Sixty instrument were necessary to form the desired molecules in only a few minutes and in high yield. First, MO_4^- was transformed into $[\text{M}(\text{CO})_3(\text{H}_2\text{O})_3]^+$. The carbonyl precursor was then engaged with the pincer ligand that contained a terminal carboxyl group to form the coordinated complexes. The acid function was then transformed into an amide group in two steps to obtain the final complex **155**. In order to create a useful multistep labeling procedure, rapid purification and workup were developed to minimize loss due to decay and to maximize the specific activity of the product. The entire synthetic procedure was completed in less than 30 min, while 2 h was necessary using conventional heating.

A solution of $[\text{Re}(\text{CO})_3\text{Br}]$ **144** with 1 equiv of *tris*-pyrazolyl ligand **156** in toluene was irradiated for several cycles

of 10 min using a CEM microwave system at 300 W to provide rhenium complexes **157** and **158** (Scheme 39).¹²⁸ Reactions

Scheme 39. Synthesis of Pyrazolylrhenium Complexes

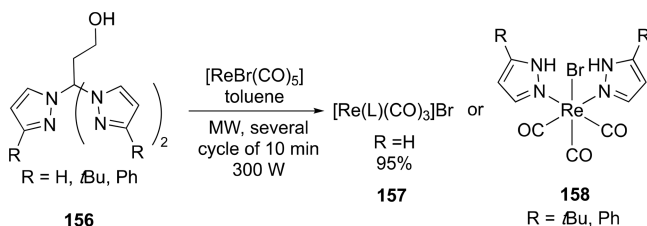

were stopped when no change in the IR spectrum of the solution was observed. Different structures were obtained from the ligand screening. Indeed, the desired complex **157** featuring one tridentate ligand was obtained in 95% yield with $\text{R} = \text{H}$, but the unexpected $[\text{ReBr}(\text{Hpz}^{\text{R}})_2(\text{CO})_3]$ **158** ($\text{pz} = \text{pyrazole}$) was identified with other substituents ($\text{R} = t\text{-Bu}$ or Ph). A similar dehydroxy compound $[\text{Re}((\text{pz})_3\text{CCH}_2\text{CH}_3)(\text{CO})_3]\text{Br}$ was also isolated in 80% yield using the same strategy.

With the same goal of developing new radiopharmaceutical compounds, the group of Valliant developed a microwave synthesis of mono-, dialkyl, or aryl technetium and rhenium metallocarboranes (carboranes are polyhedral boron clusters). Rhenium source and carborane clusters were heated in ethanol using a Biotage Initiator Sixty Instrument at 200 °C for 15 min to provide the corresponding complexes **159** and **160** in good yields (Scheme 40).¹²⁹ This microwave approach also

Scheme 40. Microwave Synthesis of Rhenium Metallocarboranes

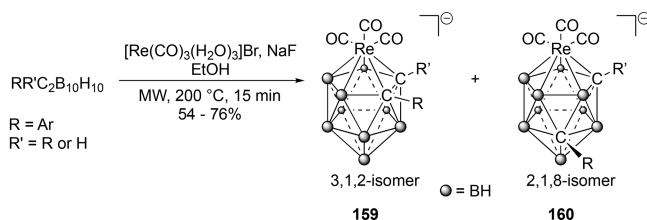

permitted the transformation of the 1,2 to 1,7 carborane cage isomer. Subsequently, this procedure was applied to six rhenium complexes and a technetium-99m analogue ($\text{R} = \text{PhOH}$, $\text{R}' = \text{H}$).¹³⁰ The technetium complex was isolated after 5 min of heating and reverse-phase purification, in a high radiochemical yield (84%) and with a high effective specific activity. The affinities of these rhenium and technetium complexes for $\text{ER}\alpha$ ($\text{ER} = \text{estrogen receptor}$) and $\text{ER}\beta$ were also determined (ER is an attractive target for molecular imaging due to its upregulation in various cancers).

In order to obtain active antibacterial molecules, the Jain group reported the synthesis of $\text{Mn}(\text{II})$ complexes with amide-containing ligands, with the assumption that these compounds could be highly active since $\text{Mn}(\text{II})$ is a surrogate of $\text{Mg}(\text{II})$ and amide ligands are prevalent in biologically active molecules (Scheme 41).¹³¹ Both microwave and conventional heating procedures were described. Using microwave irradiation enabled the reduction of the reaction time from 2–3 h to only a few minutes and the increase of isolated yields. Complexes **162** were tested as antibacterials against *E. coli*

Scheme 41. Synthesis of Antibacterial $\text{Mn}(\text{II})$ Complexes

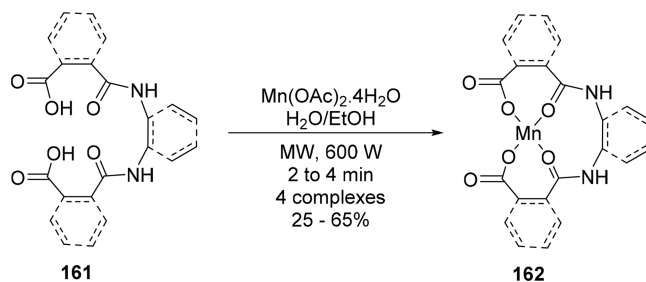

(*Escherichia coli*) and *Staphylococcus aureus* which gave promising activities.

Xu et al. adopted a similar approach for the formation of a manganese(II) complex featuring β -diketone ligand **163** via microwave irradiation (Scheme 42).¹³² Interestingly, complex **164** was synthesized by reacting two solid reactants, which were ground together prior to irradiation in the absence of a solvent. X-ray structure determination was realized, and **164** was tested for *in vitro* antibacterial activities against Gram-positive (*Bacillus subtilis*, *Staphylococcus aureus*, *Streptococcus faecalis*) and Gram-negative strains (*Pseudomonas aeruginosa*, *E. coli*, and *Enterobacter cloacae*).

Several Schiff-base-containing $\text{Mn}(\text{II})$ complexes were synthesized using microwave irradiation (Table 5, see Figure 1 for the structure of ligands). $[\text{Mn}(\mathbf{79})_2]$ was obtained in 88% yield after 25 s of irradiation of $\text{Mn}(\text{OAc})_2$ and ligand **79** in an EtOH solution (Table 5, entry 1).¹³³ To form complex $[\text{Mn}(\mathbf{71})] \cdot \text{H}_2\text{O}$, the tridentate ligand **71** and $\text{Mn}(\text{OAc})_2$ were mixed together in a 1:1 ratio in a ball mill, and the reaction mixture was then irradiated in a microwave oven in EtOH for only 6 min (Table 5, entry 2).¹³⁴ Moreover, complex $[\text{Mn}(\mathbf{87})_2]$ was isolated after 1 min of irradiation and in 83% yield (Table 5, entry 3).¹³⁵ In each case, microwave synthesis outperformed classical reflux conditions in terms of reaction times and yields. Similarly, complex $[\text{Mn}(\text{OH})_6(\mathbf{90})_6][\text{ClO}_4]_2$, which exhibits blue fluorescence emission at 458 nm, could be obtained via microwave irradiation in 27% yield while heating an aqueous solution of MnClO_4 , 2-hydroxy-3-methoxybenzaldehyde, methylamine, and triethylamine at 80 °C (Table 5, entry 4).¹³⁶ In comparison, the synthesis in an autoclave required 120 h of heating at 80 °C and cooling to room temperature over a period of 5 h (10 °C/h) to afford the complex in 22% yield.

Microwave synthesis of various $[\text{Mn}(\eta\text{-arene})(\text{CO})_3][\text{PF}_6]$ complexes **166** using a domestic microwave oven was described in 1997 (Scheme 43).⁵⁷ In contrast with the classical conditions, aluminum powder was added to increase microwave absorption. This method enabled reduction of reaction times from several hours to only 3 min. The yields were, however, significantly lower. Additionally, sterically hindered arenes reacted poorly and were partially dealkylated during the process. Reaction with fluorobenzene led to phenol complex formation due to the extreme sensitivity of the desired fluoride complex to hydrolysis.

The hexanuclear $[\text{Mn}_6\text{O}_2(\text{sao})_6(\text{O}_2\text{CH})_2(\text{CH}_3\text{OH})_4] \cdot 2\text{MeOH}$ **167**, which was found to be a single molecule magnet, was synthesized in 80% yield by microwave irradiation of a solution of $[\text{Mn}(\text{ClO}_4)_2] \cdot 4\text{H}_2\text{O}$, saoH_2 (salicylaldehyde), and NaOMe in MeOH for 5 min at 110 °C (Figure 3).¹³⁷ The complex could also be synthesized under ambient conditions, but the crystalline product did not appear immediately. In this

Scheme 42. Microwave-Assisted Synthesis of a Mn(II)- β -Diketone Complex

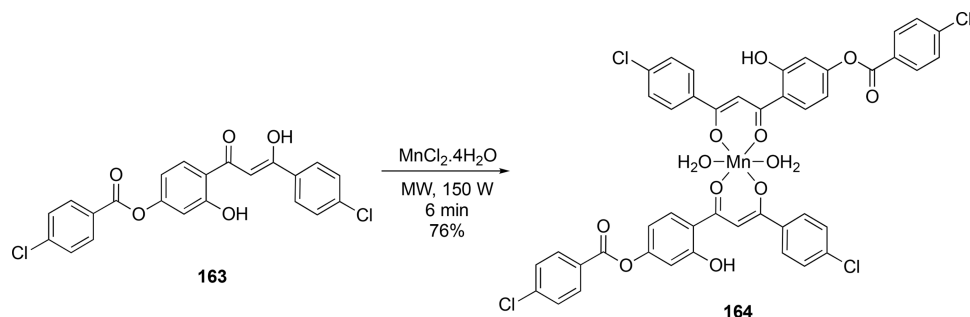

Table 5. Microwave Synthesis of Schiff Base–Mn(II) Complexes^a

entry	manganese complex	microwave synthesis		conventional heating		ref
		time (min)	yield (%)	time (h)	yield (%)	
1	[Mn(79) ₂]	0.5	88	5.5	78	133
2	[Mn(71)]·H ₂ O	6	82	10	64	134
3	[Mn(87) ₂]	1	83	5	74	135
4	[Mn ₇ (OH) ₆ (90) ₆][ClO ₄] ₂	55	27	125	22	136

^aSee Figure 1 for the structure of ligands.

Scheme 43. Microwave Synthesis of Arene–Manganese Complexes

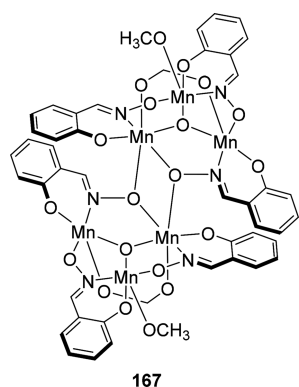
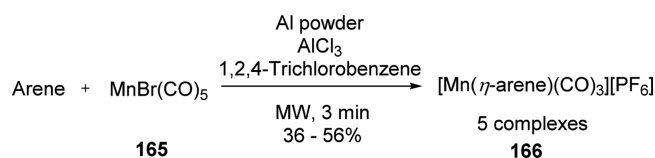

Figure 3. Structure of a single-molecule magnet synthesized by microwave irradiation.

case, the maximum yield (30%) was achieved only after 60 min of reaction and 5 days of crystallization. Hence, microwave irradiation facilitated a highly efficient alternative.

7.3. Photochemical Synthesis of Manganese and Rhenium Complexes

Photochemistry was also used in manganese chemistry to promote ligand exchanges. [Mn(IET₂Me₂)(CO)₂Cp'] 170 (IET₂Me₂ = 1,3-diethyl-4,5-dimethylimidazol-2-ylidene, Cp' = methylcyclopentadienyl) was isolated in 37% yield upon irradiation ($\lambda > 285$ nm) of [Mn(CO)₃Cp'] 168 in the presence of the free N-heterocyclic carbene 169 (IET₂Me₂) in hexane at room temperature.¹³⁸ Photolysis of this complex resulted only in one CO loss to afford [Mn(IET₂Me₂)(CO)Cp'] which was stabilized by a strong interaction with the

NHC ligand. In contrast, photolysis of [Mn(PPh₃)(CO)₂Cp'] provided a mixture of [Mn(PPh₃)(CO)Cp'] and [Mn(CO)₂Cp']. The same group has generalized this photochemical method to afford several [Mn(NHC)(CO)₂Cp'] complexes 170 in 37–51% yields (Scheme 44).¹³⁹ If reactions

Scheme 44. Photochemistry of NHC–Mn Complexes

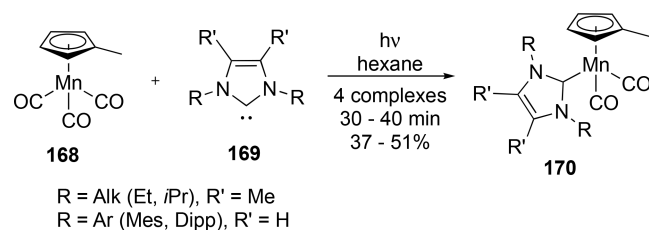

were complete in only 30 min with an alkyl substituent on the NHC, 10 more minutes is necessary with less reactive aryl NHC ligands. As described above, UV photolysis of these complexes with fast infrared detection allowed the detection of the monocarbonyl intermediates [Mn(NHC)(CO)Cp'].

In 1990, the Sutton group described the UV photolysis of [Re(CO)₃Cp*] 140 or [Re(N₂)(CO)₂Cp*] 171 in the presence of unsaturated organic ligands (alkenes, allenes, dienes, Scheme 45).¹⁴⁰ Using this procedure, different [Re(η^2 -alkene)(CO)₂Cp*], [Re(η^2 -allene)(CO)₂Cp*], and [Re(η^2 -diene)(CO)₂Cp*] were synthesized within a very short time. Analogous [Re(L)(η^2 -alkene)(CO)Cp*] (L = PMe₃, H) could also be photosynthesized starting from [Re(L)-

Scheme 45. Photochemical Synthesis of Re–Alkene Complexes

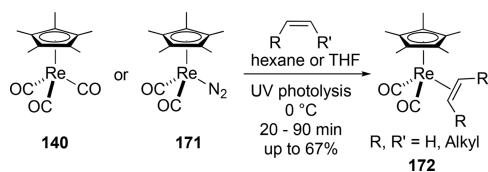

(CO)₂Cp*]. When photolysis of rhenium alkene complexes 172 was prolonged, intramolecular C–H activation occurred. This result established that rhenium-based organometallic compounds were capable of performing the carbon–hydrogen activation reaction.

8. GROUP 8

Iron complexes and in particular cyclopentadienyl iron complexes are highly active species that catalyze numerous reactions.¹⁴¹ They also play an important role in biology (activity against both estrogen-dependent and estrogen-independent breast cancer cells).^{6,142} Similarly, ruthenium complexes catalyze a wide number of reactions, the first of them being the well-known alkene metathesis reaction.^{143–145} Ruthenium complexes were also studied for their fluorescence and potential cell imaging applications,¹²¹ as well as anticancer agents to offer solutions to the limitations caused by platinum complexes (low efficacy against widespread tumors, intrinsic and acquired resistance of neoplasms, and severe side effects accompanying the therapy). Recently, the anticancer potential of osmium complexes was also explored.^{6,142} Due to the rising potential of these complexes, several research groups have reported the use of innovative techniques for their production and their subsequent transformation.

8.1. Synthesis of Iron and Ruthenium Complexes Using Ball Milling

Ferrocene complexes were mechanosynthesized for the first time in 1999 by the group of Makhaev.¹⁴⁶ All experiments were carried out using a homemade eccentric vibratory ball mill. Potassium cyclopentadienide (KCp) and FeCl₂ in a 3.4:1 ratio were subjected to mechanical milling for 15 min at a frequency of 12 Hz and an amplitude of 11 mm, furnishing the corresponding complex 173 in 85% yield after sublimation (Scheme 46). Decreasing the amplitude from 11 mm to 3 mm

Scheme 46. Mechanosynthesis of Ferrocene

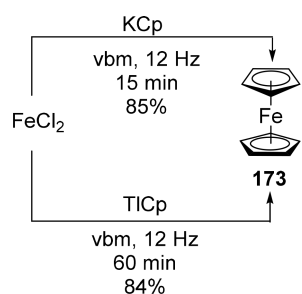

led to a very low conversion, with only traces of ferrocene 173 detected after 15 min of milling. It was also observed that stoichiometric amounts of KCp led to lower yields, which was attributed to the high oxygen and moisture sensitivity of KCp. To circumvent this, TICp was used in a TICp/FeCl₂ 1.8:1 ratio to form 173 in 84% yield after 60 min of grinding.

Scheme 47. Synthesis of a Hydrogen-Bonded Organic–Organoiron Complex

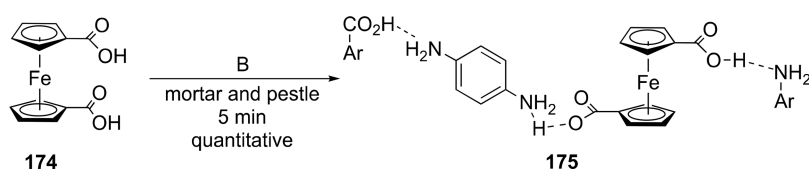

Interestingly, the solid-state reaction of ferrocene with TiCl₂ was found to be reversible. Using the same method, 1,1'-dimethylferrocene was synthesized in 90% yield in 30 min of grinding starting from NaMeCp and FeCl₂ in 2.1:1 ratio.

In 2002, the Braga group used the carboxylic-acid-containing ferrocene 174 to produce hydrogen-bonded organic–organometallic complexes via mechanosynthesis.¹⁴⁷ Manual grinding of 174 and 1,4-diazabicyclo[2.2.2]octane or 1,4-phenylenediamine in a 1:1 ratio in an agate mortar and pestle led to the quantitative formation of the corresponding complexes (Scheme 47). The method was generalized to different solid bases (piperazine, *trans*-1,4-cyclohexanediamine, and guanidinium carbonate [(NH₂)₂C]₂[CO₃]). The corresponding complexes were generated quantitatively as pure compounds, as verified by powder X-ray diffraction (PXRD) and comparison with data obtained by single-crystal X-ray diffraction.¹⁴⁸

In a similar way, hybrid organic–organometallic materials 177 and 178 could be formed via a solid–solid reaction of 1,1'-dipyridyl-ferrocene 176 with various organic diacids (fumaric, succinic, tridecanedioic, terephthalic, trimesic, and thiophene-2,5-dicarboxylic acids).¹⁴⁹ Different structures ([Fe(η⁵-C₅H₄-C₅H₄N)(η⁵-C₅H₄-C₅H₄NH)][A-AH] for 177 or [Fe(η⁵-C₅H₄-C₅H₄NH)₂][A-A] for 178) could be obtained after mechanochemical treatment depending on the acid used (Scheme 48). Interestingly, mechanosynthesis of a maleic acid–iron complex yielded a different product from the one obtained under classical solution conditions.

Scheme 48. Synthesis of Hybrid Organic–Organometallic Materials

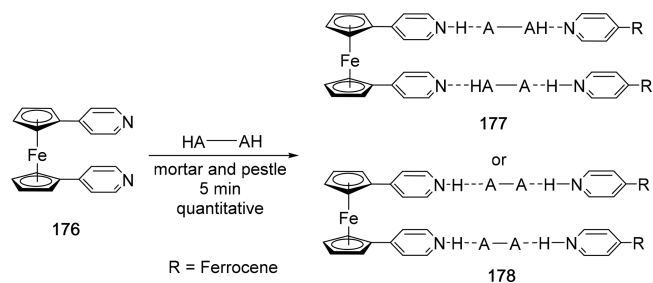

When linear alkyl diacids such as adipic, suberic, azelaic, and sebacic acids were utilized, new supramolecular macrocyclic adducts were synthesized (Figure 4).¹⁵⁰ Thus, [Fe(η⁵-C₅H₄-C₅H₄N)₂][HOOC(CH₂)_nCOOH] 179 (*n* = 4, 6, 7, 8) were obtained quantitatively by kneading powdered samples of the ferrocenyl complex and acid in a 1:1 ratio with a few drops of MeOH. Surprisingly, when pimelic acid was used (*n* = 5), an isomeric open-chain structure was observed.

The Braga group also reported the mechanosynthesis of disubstituted pyridine/pyrimidine ferrocenyl complexes 182 using Suzuki–Miyaura coupling conditions (Scheme 49).¹⁵¹ The procedure required three grinding steps performed with a

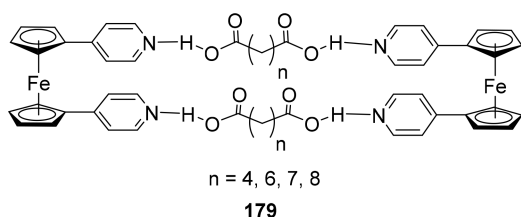
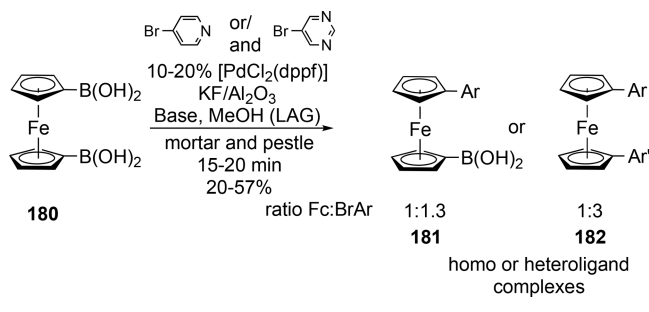

Figure 4. Supramolecular structure of macrocyclic adducts.

Scheme 49. Mechanochemistry of Disubstituted Ferrocenyl Complexes



mortar and pestle: (i) grinding $[\text{Fe}(\eta^5\text{-C}_5\text{H}_4\text{B}(\text{OH})_2)_2]$ **180** and $[\text{PdCl}_2(\text{dppf})]$ (dppf = 1,1'-bis(diphenylphosphino)-ferrocene, **67**) in a $\text{KF}/\text{Al}_2\text{O}_3$ mixture until complete homogenization, (ii) addition of the halogenated pyridine and grinding until homogenization, and (iii) addition of the base (KOH or KF) and further grinding for 15–20 min. For the last step, MeOH could be added to improve the efficiency of the synthesis. Since boronic acids are thermally stable and unreactive to both oxygen and water at ambient temperature and pressure, reactions could be carried out in air at room temperature. For this solvent-free Suzuki–Miyaura cross-coupling, the choice of $[\text{PdCl}_2(\text{dppf})]$ as the catalytic species was crucial since the use of $[\text{Pd}(\text{PPh}_3)_4]$ did not provide the desired complex. Interestingly, the reaction selectivity could be controlled in favor of the mono- or dicoupled products, **181** and **182**, respectively, by changing the reagent stoichiometry.

The formation of imines has also been used to functionalize ferrocene derivatives. Unfortunately, some decomposition of ferrocenyl-imines is observed when they are produced by

heating a solution of ferrocenyl-aldehyde and an aromatic amine. To avoid this, a simple, convenient, and milder approach was developed by grinding reactants at room temperature in a pyrex tube with a glass rod.¹⁵² Thus, mixing ferrocenyl-aldehyde **183** and aromatic amine in a 1:1 ratio provided the corresponding imine complex **184** in excellent yields and very short reaction times (Scheme 50). In the case of less reactive starting materials, gentle heating of the reaction mixture in a water bath (50 °C) was required to obtain a good conversion. The procedure was also applied to 1,1'-ferrocenedicarboxaldehyde,¹⁵³ dianiline, and diaminoalkanes¹⁵⁴ to afford the corresponding diimine compounds (**186** and **185**). The latter ferrocenyl complexes were used as ligands for the synthesis of rhodium complexes in solution.

Another modification of ferrocenylaldehyde was the formation of ferrocenyl-acrylonitriles **187** by mixing the aldehyde with 4-substituted phenylacetonitriles (Figure 5).

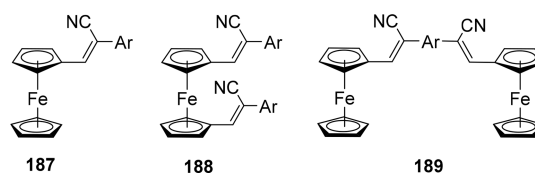
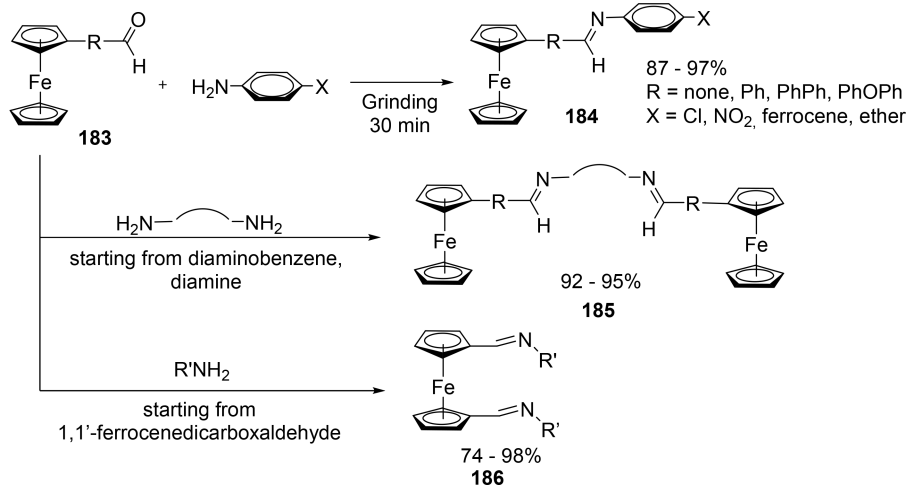

Figure 5. Acrylonitrile complexes obtained by mechanochemistry.

The corresponding products were obtained in excellent yields (89–99%), except if the phenylacetonitrile bore a methoxy at the para position of the phenyl group.¹⁵³ Synthesis of ferrocenyl-diacrylonitrile **188** and bis(ferrocenyl)-diacrylonitrile **189** could also be performed by mechanochemical treatment using a catalytic amount of piperidine during the grinding (Figure 5).¹⁵⁵ However, this methodology also showed limitations as soon as phenylacetonitriles featuring an electron-donating group in the para position were used.

In 2013, Nieto et al. reported a facile one-pot route to prepare unexpected highly electron-poor 1-cyanocarbonylferrocene **191**.¹⁵⁶ This procedure represented the first example describing the solid-state formation of a $-\text{C}(\text{O})\text{CN}$ bond without using an acyl chloride reactant. Simple manual grinding of cyanomethylferrocene **190** and silica gel in an agate mortar, in air, and at room temperature provided the oxidized complex in 53% yield in less than 1 h (Scheme 51).

Scheme 50. Highly Efficient Mechanochemistry of Ferrocenyl-imines



Scheme 51. Unexpected Mechanochemistry of 1-Cyanocarboxyferrocene

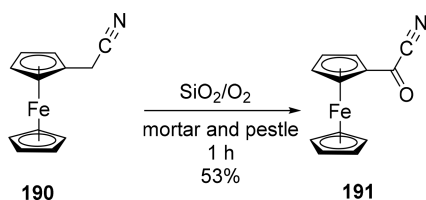

The slightly acidic surface of silica due to the presence of silanol groups was postulated to be responsible for the success of the reaction. The authors proposed a mechanism that was initiated by silica gel surface-mediated one-electron oxidation of the iron atom.

In 1993, Borisov et al. described the mechanochemical synthesis of iron(III) bisdicarbollyl complex **194** (Scheme 52).¹⁵⁷ The reaction was performed in an eccentric vibratory ball mill. The steel reactor was charged with 15 steel balls (12 mm in diameter), FeCl₃, and Ti₂C₂B₉H₁₁ **192**. After 30 min of agitation at a frequency of 12 Hz and an 11 mm amplitude, the reaction mixture was recovered and treated with an excess of tetramethylammonium hydrogenosulfate to obtain **194** after filtration and recrystallization.

Hemin (**195**) is an organo-iron complex, which has also been synthesized by mechanochemistry. It has been used as a model to understand hemoglobin chemistry and as a starting reagent in the synthesis of pharmaceutical products for the treatment of anemia. Hemin has two potential sites that can react with a base, the two acidic groups, and the Fe^{III} cation (Figure 6). They are important for the synthesis of complexes with pharmaceutical properties because of the modification of hydrogen bonding of this acidic residue with other OH groups. In 2002, Paneque et al. described different mechanochemical reactions of hemin with various fluorides.¹⁵⁸ While LiF and NaF were found to be inert when milled with **195**, KF, CsF, NH₄F, and AgF (MF) reacted at both sites, leading to halide exchange on iron, as proved by the detection of MCl by XRD and the neutralization of the acidic groups to form MHF₂. It was demonstrated that reactions first took place at the iron site and then at the peripheral acidic groups.

In 2015, Giri et al. described a subcomponent synthesis of three iron supramolecular complexes **198**, **200**, and **202** under solvent-free conditions (Scheme 53).¹⁵⁹ Under selected ball-milling conditions, these three iron(II) complexes could be synthesized starting from a source of iron, 2-pyridinecarboxaldehyde **196**, and three different amines (Scheme 53). Interestingly, a one-pot procedure was developed involving mixing of the iron source, aldehyde **196**, and the three amines **197**, **199**, and **201**, yielding the three complexes simultaneously. Notably, under mechanochemical treatment, complex **202** could be quantitatively converted into compound **198**, which in turn could be converted into **200** as a consequence of the relative thermodynamic stability of these complexes.

Although the synthesis of many iron complexes was described by using mechanochemistry, to date only one

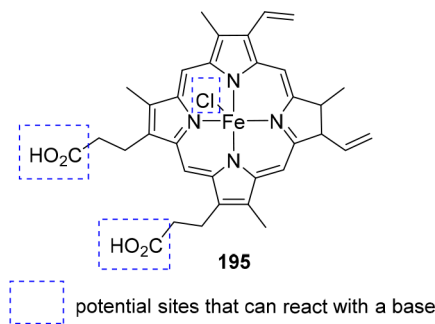

Figure 6. Hemin structure.

publication reported the mechanochemical synthesis of a ruthenium complex. Thus, after manual grinding in a mortar and pestle of [Ru(H₂biim)₃][PF₆]₂·3H₂O **203** (H₂biim = 2,2'-biimidazole) and CH₃CO₂NH₄ with a few drops of H₂O₂ for 25 min, complex **204** was recovered in 98% yield (Scheme 54).¹⁶⁰ The reaction could also be performed at room temperature in solution, but the complex was isolated with a low yield of 30%.

8.2. Microwave Procedures

The first synthesis of organo-iron complexes using microwave irradiation was reported by Dabirmanesh and Roberts in 1993. [Fe(η-C₅H₅)(η-arene)]PF₆ **205** and [Fe(η-arene)₂]PF₆ **206** were synthesized from various arenes using a simple solid CO₂-cooled apparatus in a conventional domestic microwave oven (Scheme 55).¹⁶¹ Syntheses of monoarene complexes **205** from ferrocene **173** (Scheme 55, reaction A) were facilitated by using microwave irradiation. Reaction times were decreased from hours to only a few minutes, and yields were improved. On the contrary, for the synthesis of complexes **206** bearing two arenes (Scheme 55, reaction B), yields were generally much lower than those obtained by conventional synthesis. Considerable rearrangements of the original arene by inter- and intramolecular migration of the methyl groups were observed. These rearrangements occurred prior to complexation and led to the formation of byproducts. In a detailed study, 1,2,4-trichlorobenzene (TCB) was identified as the solvent of choice, and the efficiency of metals as zinc or copper to replace the aluminum commonly used for the reaction was examined. The reaction scope was then extended to several arene compounds including sterically hindered ones.^{57,162} A mixture of ferrocene, arene, AlCl₃, and Al powder in TCB was irradiated in an unmodified domestic microwave oven for 6 min to form corresponding heteroleptic complex **205**, HPF₆ being added during the workup procedure to afford the desired counteranion. Adding W(CO)₄(PPh₃)₂ to the reaction mixture provided [[Fe(η-C₆H₅)(Cp)]₂P(Ph)](PF₆)₂ and POPh₃ produced [[Fe(η-C₆H₅)(Cp)]P(O)(Ph)₂]PF₆. Interestingly, microwave-assisted decomplexation was attempted using graphite flakes or graphite powder and gave excellent results in a very short time (2 min).

In 2006, Roberts reported the advantages of microwave heating applied to the production and modification of organo-iron complexes, this time by performing S_NAr reactions with

Scheme 52. Synthesis of the Iron(III) Bisdicarbollyl Complex

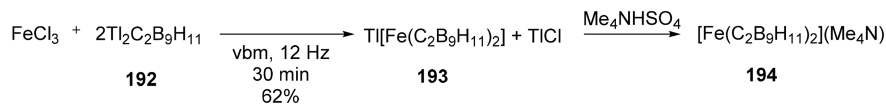

Scheme 53. Mechanochemical Synthesis of Metallosupramolecular Iron(II) Complexes

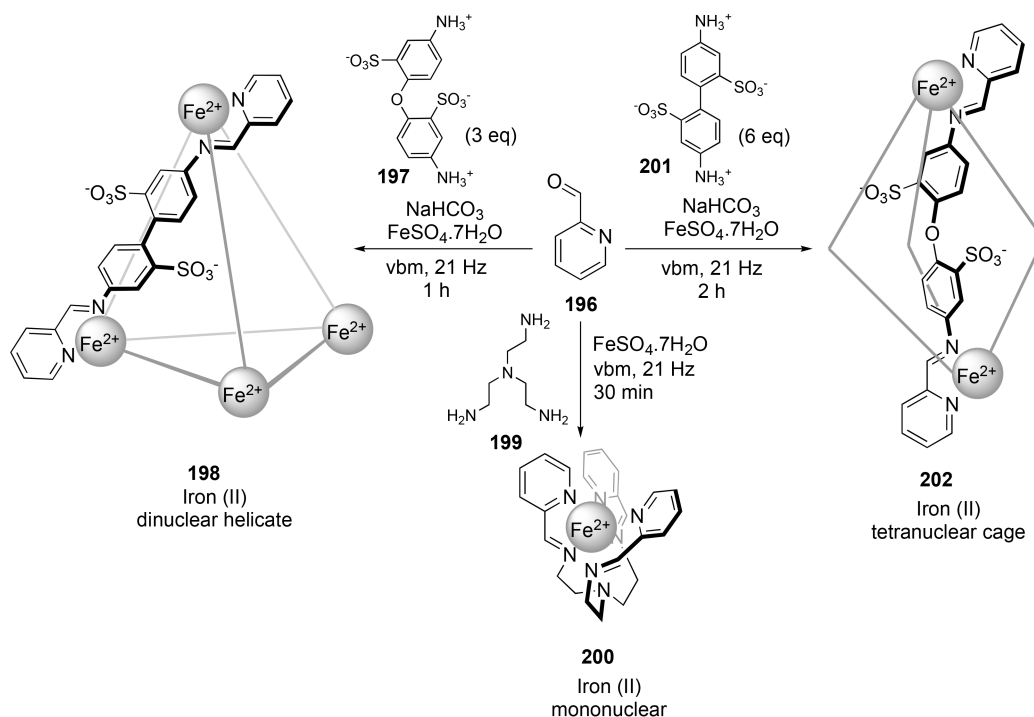

Scheme 54. Synthesis of the $[\text{Ru}(\text{Hbiim})_3]$ Complex

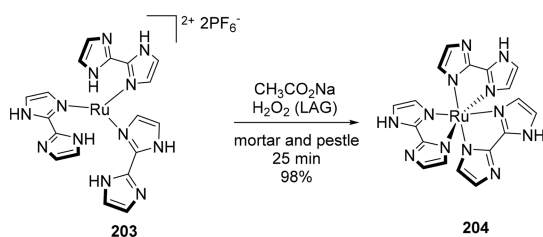

Scheme 55. Microwave Synthesis of Arene-Iron Complexes

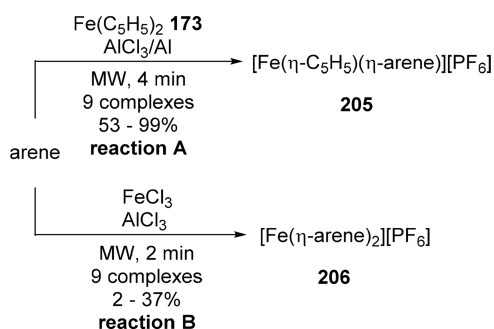

N-containing nucleophiles. For instance, such $\text{S}_{\text{N}}\text{Ar}$ reactions on complexes **205** ($[\text{Fe}(\text{Cp})(\eta\text{-arene})]^+$) performed by conventional heating can take place over several hours or, in some cases, over days. Using microwave irradiation accelerates the rate of these reactions leading to $\text{S}_{\text{N}}\text{Ar}$ displacements in only 5 min (Scheme 56, reaction A).¹⁶³ The technique was used to achieve a one-pot synthesis of an N-arylated amino acid **210** (Scheme 55, reaction B). Afterward, decoordination of iron could be performed using KOTBu under microwave irradiation for 3 min to liberate unprotected amino acid **210**.

In the same year, Roberts reported the use of microwave heating conditions to introduce oxygen substituents into iron

Scheme 56. Synthesis of Amino-Substituted $(\eta^6\text{-Arene})(\eta^5\text{-cyclopentadienyl})\text{iron(II)}$ Complexes

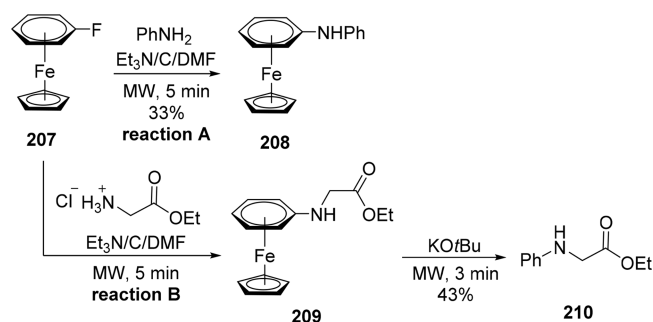

complex **205**.¹⁶⁴ Ligand exchange reactions (Scheme 55) performed on ferrocene with phenolic reactants using microwave irradiation resulted in the isolation of $[\text{Fe}(\text{Cp})(\text{ArOH})]$ complexes in very low yields, probably because of the strong complexation or reaction with AlCl_3 that suppressed its Lewis acidity. Better results were obtained with phenyl-*t*-butylether and *O*-trimethylsilylphenol, resulting in the corresponding $[\text{Fe}(\text{Cp})(\text{PhOH})]$ complex in 45% and 44% yield, respectively. When trimethylsilylated catechol was used, the complex was obtained in 9% yield and was the first example in the literature of an ArFeCp complex containing two OH groups. Among the protecting groups tested, *t*Bu and Me_3Si were the best ones because their steric hindrance probably inhibited complexation with AlCl_3 . Moreover, their deprotection proceeded concomitantly with the complexation reaction. Synthesis of a $[\text{Fe}(\text{Cp})(\text{ArOR})]$ complex could also be performed under microwave irradiation by $\text{S}_{\text{N}}\text{Ar}$ displacement of the halogen substituent of $[\text{Fe}(\eta\text{-chlorobenzene})(\text{Cp})]\text{PF}_6$ by phenol in the presence of Et_3N . In this case, the reaction time was reduced to only 5 min, while 12–15 h was required under classical conditions.

In 2009, different organo-iron complexes were synthesized using a CEM Discover LabMate single-mode microwave instrument in minutes rather than days.¹⁶⁵ First, ferrocene could be formed starting from a solution of dicyclopentadiene and $\text{KO}t\text{Bu}$ in diglyme irradiated at 200 W for 10 min that was subsequently added to a solution of $\text{FeCl}_2 \cdot 4\text{H}_2\text{O}$ in DMSO (86% yield). Further modification of ferrocene into acetylferrocene could then be achieved using acetic anhydride and concentrated phosphoric acid as a catalyst placed under microwave conditions for 5 min (75% yield). The same authors showed that the challenging formation of the expensive $[\text{Fe}(\text{CO})_2(\text{Cp}^*)]_2$ could be performed efficiently via microwave irradiation from $[\text{Fe}(\text{CO})_5]$ and pentamethylcyclopentadiene in DMF (200 W, 10 min, 88% yield). $[\text{FeCp}(\text{CO})_2\text{I}]$ **212** could also be synthesized from $[\text{FeCp}(\text{CO})_2\text{I}]$ **211** in 90% yield in only 10 min (150 W) and transformed into $[\text{FeCp}(\text{CO})(\text{PPh}_3)\text{I}]$ **213** using PPh_3 (Scheme 57). A one-pot microwave synthesis starting from **211** was even more efficient.

Scheme 57. Microwave Synthesis of $[\text{FeCp}(\text{CO})(\text{PPh}_3)\text{I}]$

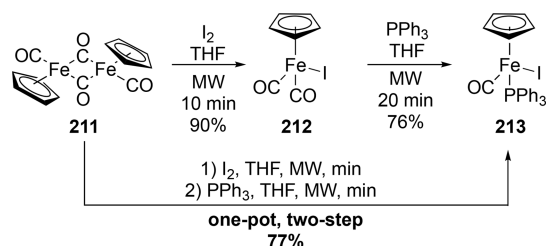

Additionally, $[\text{FeCp}(\text{CO})(\text{PPh}_3)(\text{COMe})]$ **215** was synthesized in 86% yield starting from a solution of $[\text{FeCp}(\text{CO})_2(\text{Me})]$ **214** and triphenylphosphine in acetonitrile that was placed under microwave heating for 60 min (Scheme 58).¹⁶⁵ Finally, four different phosphine complexes were

Scheme 58. Photochemical Transformation of Iron Complexes with Phosphine Ligand

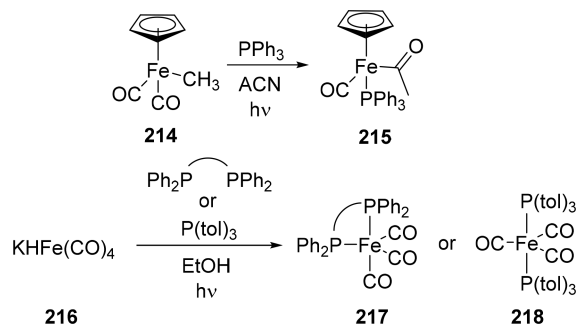

prepared via microwave irradiation of $\text{KHF}e(\text{CO})_4$ with the appropriate phosphine in an EtOH solution for 5 min at 150 W. Complexes **217** and **218** were recovered in 40–67% yield.

Two series of piano-stool iron(II) complexes bearing monodentate, bidentate diphosphine, or bidentate mixed P–N ligands were prepared upon reaction with $[\text{FeCp}(\text{CO})_2\text{I}]$ **219** or $[\text{FeCp}(\text{naphthalene})][\text{PF}_6]$ **223** under microwave irradiation.¹⁶⁶ If cationic species **221** were obtained by using different monophosphines (Scheme 59, reaction A), the neutral complex $[\text{FeCp}(\text{PPh}_3)\text{ICO}]$ was obtained with triphenylphosphine in 90% yield. Lower yields were obtained for **221** due to the difficulty in isolating the pure product. The

Scheme 59. Microwaves Synthesis of $[\text{FeCpL}_3][\text{X}]$

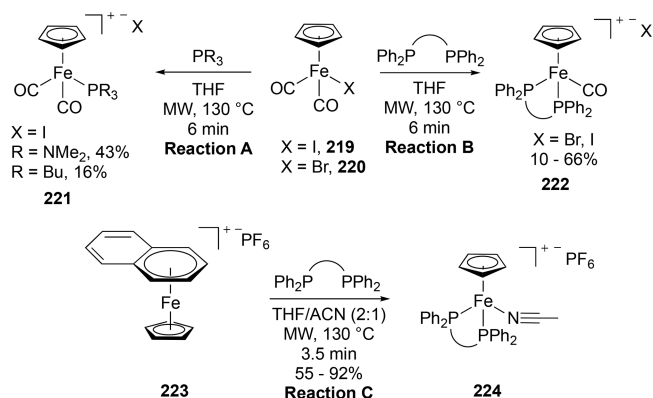

synthesis method was also applied to a diphosphine ligand producing complexes **222** with slightly better yields (Scheme 59, reaction B). Since the low lability of CO can be problematic for catalytic applications, $[\text{FeCp}(\text{naph})][\text{PF}_6]$ **223** was used as an alternative reactant to introduce a more labile acetonitrile ligand. After reaction with various diphosphines in the presence of acetonitrile under microwave irradiation, the corresponding complexes **224** were isolated in 55–92% yield (Scheme 59, reaction C).

In 1994, Puciova et al. reported their difficulties in repeating the previously described syntheses of ferrocenyl-substituted heterocycles **227**–**233** by using conventional heating. With the purpose of improving these procedures, they performed these syntheses by using microwave irradiation (Scheme 60).¹⁶⁷ Thus, ferrocenylthiophene **227** was prepared starting from 3-chloro-3-ferrocenylacrylaldehyde **225** and thioglycolic acid in $\text{Et}_3\text{N}/\text{DMF}$. The reaction mixture was irradiated for 2 min to afford corresponding complex **227** in 87% yield. A similar procedure was applied successfully for the synthesis of ferrocenylfuran **229** and two different 1,1'-bis(2-thienyl)ferrocenes **228**. Besides, heating 3-chloro-3-ferrocenylacrylaldehyde **225** under microwave irradiation with hydrazine in an EtOH/AcOH (1:1) mixture produced the corresponding pyrazole **230**. Despite this, when hydroxylamine, phenylhydrazine, and 2,4-dinitrophenylhydrazine were used instead of hydrazine, the reaction led only to product **232**, which resulted from an acyclic condensation, as opposed to what was observed under classical conditions.

In the same year, Villemin et al. described microwave-assisted Claisen–Schmidt condensations of acetylferrocene **234** and ferrocene carboxaldehyde **236** with various electrophiles in neat conditions using KOH as a base and an ammonium salt as the catalyst (Aliquat 336). When benzaldehyde, furaldehyde, or 2-thienylcarboxaldehyde were used as the electrophiles, the reaction mixture did not need to be irradiated to obtain satisfactory results. However, with piperonal and paramethoxybenzaldehyde, irradiation at 140 W was necessary to obtain the corresponding complexes **235** in short time and good yields (Scheme 61, reaction A).¹⁶⁸ When using ketones as the electrophiles (Scheme 61, reaction B), three out of the four ferrocene complexes were produced by using microwave irradiation due to the low reaction rate when the reaction was performed at room temperature.

In 2008, a similar microwave-assisted Claisen–Schmidt condensation was utilized to form 1,5-dioxo-3-ferrocenyl[5]-ferrocenophane compounds **239**, which contain a bridging C_5 chain between the two cyclopentadienyl rings of the same

Scheme 60. Microwave Synthesis of Ferrocenyl-Substituted Heterocycles

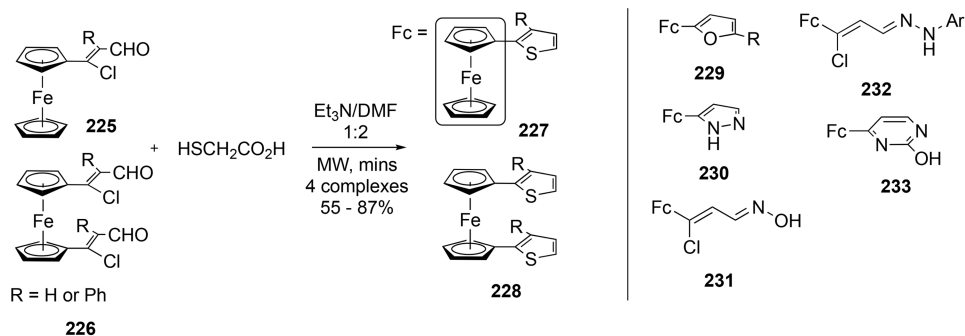

Scheme 61. Claisen–Schmidt Microwave Reactions

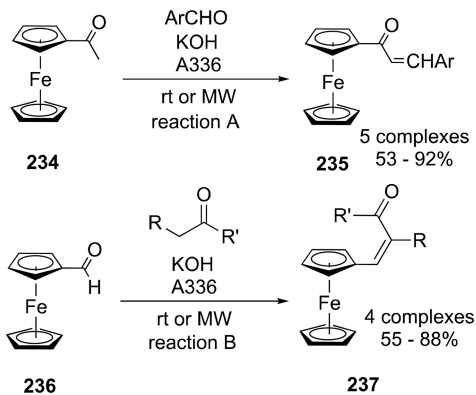

Scheme 62. Microwave Synthesis of 1,5-Dioxo-3-substituted [5]Ferrocenophanes

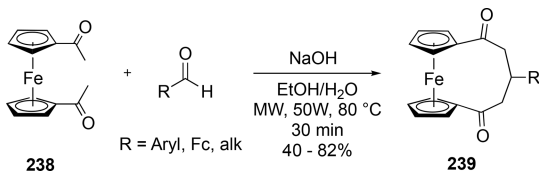

ferrocene unit and are compounds of interest for their electronic properties (Scheme 62).¹⁶⁹ Complexes **239** were isolated in a short time and in moderate to good yields after submitting a solution of 1,10-diacetylferrocene **238** to microwave irradiation in the presence of an aldehyde and sodium hydroxide.

In 2017, Kulikov et al. described a microwave-assisted synthesis of ferrocenyl hydrazones **241** starting from ferrocene carbohydrazide **240** and aldehydes in EtOH (Scheme 63).¹⁷⁰ After a few seconds of heating, compounds **241** were recovered in very high yields (93–100% yield) after a simple filtration of the resulting precipitate. Conventional heating led to higher reaction times and lower yields, presumably due to partial decomposition of either **240** or **241** under prolonged heating. This partial decomposition also led the authors to perform complicated chromatographic purification to isolate the desired products in satisfying purities.

Microwave irradiation also proved to be highly beneficial for the rearrangement of Dewar benzene–ferrocene complexes **242**. While they did not rearrange upon heating to their melting point or to 150 °C in DMSO, heating at 180 °C resulted in their decomposition. Remarkably, their rearrangement toward the corresponding 1-benzene–ferrocene com-

plexes **243** could be achieved when solubilized in THF and heated under microwave irradiation at 180 °C for 6 h (Scheme 64).¹⁷¹

Scheme 63. Synthesis of Ferrocenyl Hydrazones under Microwave Irradiation

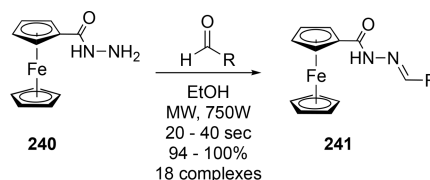

Scheme 64. Synthesis of Benzene–Ferrocene Complexes

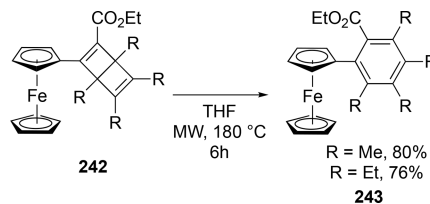

In contrast to synthesis by mechanochemistry, around 30 publications reported the synthesis of ruthenium complexes by using microwave activation. Different polypyridine–ruthenium complexes, which possess interesting photochemical and redox properties, were synthesized using microwaves (Scheme 65, reaction A).¹⁷² Starting from a stoichiometric ratio of the pyridine ligands and $[\text{RuCl}_3] \cdot [\text{H}_2\text{O}]_3$ along with Et_3N in MeOH, complexes were formed after irradiation in a domestic microwave oven at 650 W in a Teflon autoclave for 2 runs of 20 s (the autoclave was allowed to cool for 25 min before the second run). Addition of KPF_6 in water led to the precipitation of the desired complexes **244** that could be isolated in good yields after filtration and washings.

The same general approach was published in 1994 for the synthesis of polypyridine–ruthenium complexes **247** via reflux under microwave irradiation in an open system (Scheme 65, reaction B).¹⁷³ Starting from 10 different polypyridine ligands, products were recovered in good yields (57–95%). Similarly, a series of new octahedral ruthenium(II)–polypyridine complexes were prepared via microwave irradiation to elucidate the effect of ligand structure on the redox potential of the complexes. Different ruthenium complexes of substituted bipyridine, benzimidazole, pyridine, quinoline, and phenanthroline were synthesized in 65–95% yields. Their E_L (L) parameter (derived from the oxidation potentials) was

Scheme 65. Synthesis of Polypyridine–Ruthenium Complexes via Reflux under Microwave Irradiation

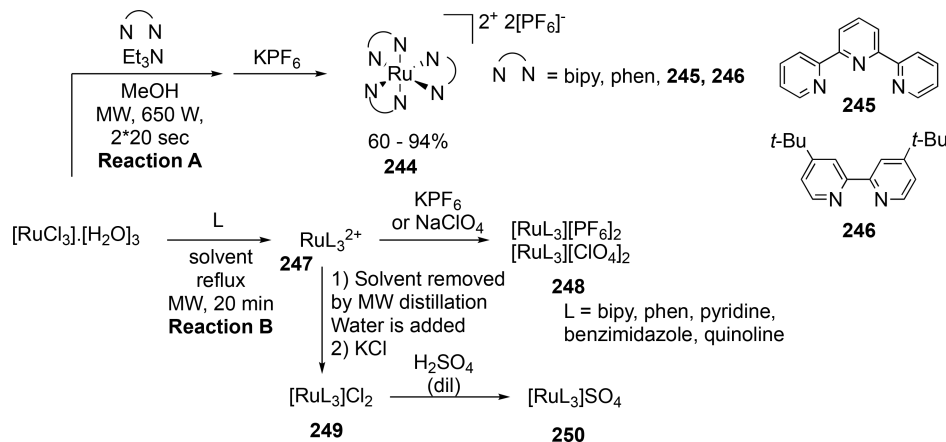

Scheme 66. Syntheses of Ru(II) Complexes by Microwave Heating

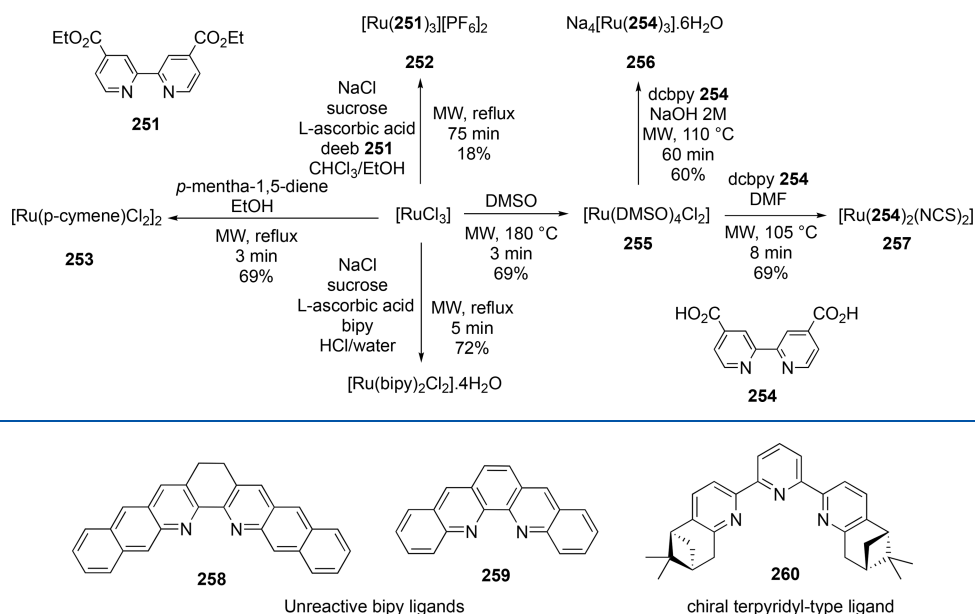

Figure 7. Highly encumbered bipy ligands unreactive under conventional heating conditions.

correlated with the π -donor/ π -acceptor properties of the ligands.¹⁷⁴ A comparable methodology was used for the synthesis of tris(4,7-diphenyl-1,10-phenanthroline)–ruthenium(II) hexafluorophosphate from a dichloro(*p*-cymene)ruthenium(II) dimer, resulting in a complex with very promising electroluminescence behavior when operated in a solid-state light-emitting electrochemical cell.¹⁷⁵

Recently, another publication reported a microwave-assisted synthesis of polypyridyl–ruthenium complexes. Starting from $[\text{Ru}(\text{DMSO})_4\text{Cl}_2]$, complexes $[\text{Ru}(\text{L})_3][\text{PF}_6]_2$ (L = bipy or phen) were obtained in 93–94% yields after 15 min of heating under microwave irradiation at 160 °C.¹⁷⁶ Starting from $[\text{Ru}(\text{L})_2\text{Cl}_2]$ (L = bipy or phen), heteroleptic $[\text{Ru}(\text{L})_2(\text{L}')] [\text{PF}_6]_2$ (if L = bipy, L' = phen; if L = phen, L' = bipy) were obtained in 94–100% yield by using a similar procedure.

Microwave irradiation was also used for the synthesis of seven Ru(II) complexes to be employed in solar energy conversion and dye-sensitized solar cells (Scheme 66).¹⁷⁷ All syntheses were performed using a CEM system in an open (atmospheric pressure) or closed vessel (pressurized conditions). Thus, $[\text{Ru}(\text{DMSO})_4\text{Cl}_2]$ **255** was synthesized in 3

min from a refluxing solution of RuCl_3 in DMSO. This complex could then be transformed into $\text{Na}_4[\text{Ru}(\text{dcbpy})_3] \cdot 6\text{H}_2\text{O}$ **256** (dcbpy = 4,4'-dicarboxy-2,2'-bipyridine **254**) and $[\text{Ru}(\text{dcbpy})_2(\text{NCS})_2]$ **257** in 60% and 69% yields, respectively. Using the same equipment, $[\text{Ru}(\text{p-cymene})\text{Cl}_2]_2$ **253** was synthesized in 15 min in 65% yield from RuCl_3 and *p*-mentha-1,4-diene. In the same publication, RuCl_3 was also used to synthesize $[\text{Ru}(\text{bipy})_2\text{Cl}_2] \cdot (\text{H}_2\text{O})_4$ by heating with 2,2'-bipyridine, NaCl, sucrose, and L-ascorbic acid in an aqueous HCl solution. These reaction conditions provided one of the most difficult Ru(II) complexes, which possesses high quantum yield photoluminescence emission properties. $[\text{Ru}(\text{deeb})_3]^{2+}$ complex **252** (deeb = 4,4'-diethylester-2,2'-bipyridine **251**) could indeed be produced in 18% yield in only 75 min of heating under microwave irradiation. This contrasted greatly with the 7 days of conventional heating in solution required to isolate the complex in 15% yield. Furthermore, $[\text{Ru}(\text{bpy})_2(\text{dcbpy})] \text{Cl}_2 \cdot 2\text{H}_2\text{O}$ could be obtained in 93% yield by heating at 90 °C for 30 min in a solution of $[\text{Ru}(\text{bpy})_2\text{Cl}_2]$ and dcbpy **254** in a AcOH/water mixture. Interestingly, the majority of these complexes was recovered

Scheme 67. Microwave Synthesis of Mixed Polypyridine Ruthenium Complexes

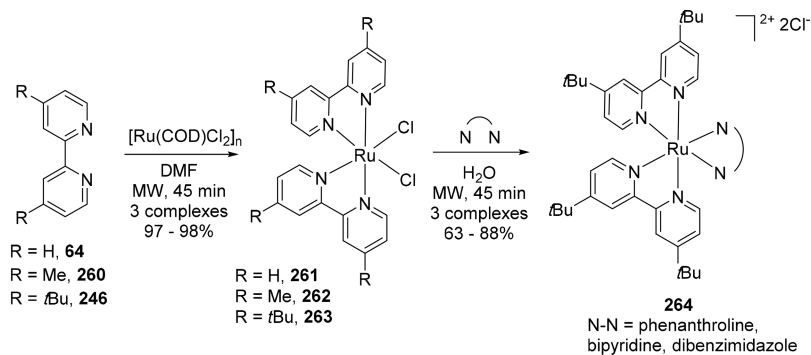

Scheme 68. Synthesis of $[\text{Ru}(\text{dcmb})_{3-n}(\text{tbbpy})_n][\text{PF}_6]_2$ Using Microwave Irradiation

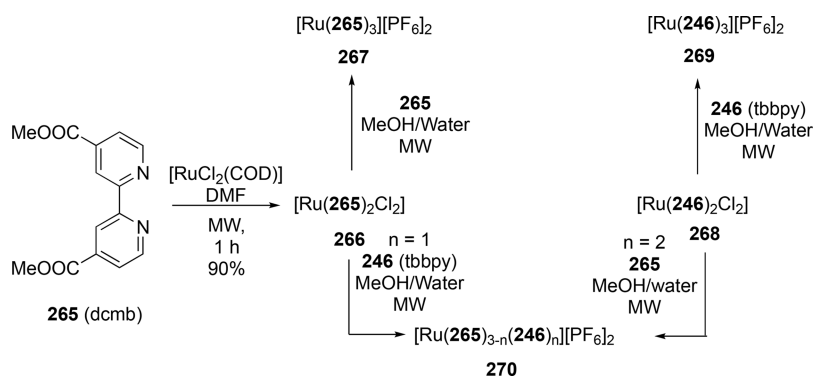

without column chromatography and was purified by simple work-ups.

Interestingly, microwave heating can assist the reactions of highly encumbered bipyridine ligands (3,3'-dimethylene-2,2'-bibenzo[*g*]quinoline **258** and bisbenzo[2,3:9,8]-1,10-phenanthroline **259**) to form their corresponding ruthenium complexes. Thus, the treatment of these bipyridines with $[\text{RuCl}_3] \cdot (\text{H}_2\text{O})_3$ or $[\text{Ru}(\text{bipy})_2\text{Cl}_2] \cdot (\text{H}_2\text{O})_2$ in aqueous EtOH at reflux did not lead to the formation of the corresponding ruthenium complexes (Figure 7). However, running reactions in ethylene glycol for 15–30 min under microwave heating led to the formation of $[\text{Ru}(\text{L})_3][\text{PF}_6]_2$ complexes in 15 and 19% yield.¹⁷⁸ Better yields were obtained in the synthesis of $[\text{Ru}(\text{L})(\text{bipy}-d_8)]_2[\text{PF}_6]_2$ from *cis*- $[\text{Ru}(\text{bipy}-d_8)_2\text{Cl}_2] \cdot (\text{H}_2\text{O})_2$ (41 and 44%, respectively). In all cases, NH_4PF_6 was used during the workup procedure to obtain the desired counterion. Similarly, ruthenium complexes with annelated 2,2':6',2''-terpyridine ligand^{179,180} and with enantiomerically pure chiral terpyridyl-type ligand **260**¹⁸¹ were synthesized in a few minutes and in yields of up to 95%. A range of homoleptic electron-withdrawing pyrrolidine-containing bipyridine and terpyridine ruthenium complexes have also been prepared using microwave-assisted heating. Complexes were obtained in high yields and very short reaction times (3 min), while classical thermal conditions failed.¹⁸²

Bipyridine substitution of a COD ligand (COD = cycloocta-1,5-diene) on the ruthenium complex $[\text{Ru}(\text{COD})\text{Cl}_2]_n$ was shown to be possible by microwave activation. The corresponding luminescent mixed polypyridine ruthenium complexes **261–263** were obtained in 45 min and in high yields (Scheme 67).¹⁸³ Subsequent substitution of the chlorine atoms with different *N,N*-ligands (substituted phenanthroline-, bipyridine-, and dibenzimidazole-type ligands) was also

possible by microwave heating in water. The use of microwaves considerably decreased the reaction time and provided the products in excellent yields and purities. Alternatively, $[\text{Ru}(\text{R-bipy})_2\text{Cl}_2]$ complexes **261–263** ($\text{R} = \text{H}, \text{Me}, \text{tert-butyl}$) could be obtained in a few minutes and in quantitative yields by applying microwave heating to a solution of $[\text{RuCl}_3] \cdot (\text{H}_2\text{O})_3$, substituted bipy ligands, and NEM (*N*-ethylmorpholine) in DMF.¹⁸⁴

The introduction of carboxylic groups on bipyridine ligands can be a valuable asset for dye-sensitized solar cell applications of ruthenium complexes. Thus, the ruthenium complexes $[\text{RuCl}_2(\text{dcmb})_2]$ **266** (dcmb = 4,4'-dimethoxycarbonyl-2,2'-bipyridine, **265**) and $[\text{Ru}(\text{dcmb})_{3-n}(\text{tbbpy})_n](\text{PF}_6)_2$ ($n = 0–3$) **270** could be synthesized with high efficiency by using a microwave-assisted synthetic procedure (Scheme 68).¹⁸⁵ The positive effect of microwave irradiation was impressive as **266** could be isolated in 90% yield after 1 h heating under microwave irradiation, whereas the same complex was obtained in 78% yield after 50 h of conventional thermal heating. Interestingly, in 2006, Anderson et al. reported the microwave-assisted reaction of debpy (debpy = 4,4'-diethoxycarbonyl-2,2'-bipyridine) with RuCl_3 which led to the formation of $[\text{Ru}(\text{bipy})_3][\text{PF}_6]_2$ through an unexpected decarboxylation of the ligand.¹⁸⁶

Microwave irradiation of racemic *cis*-polypyridine and *cis*-polyphenanthroline ruthenium complexes **271** in the presence of enantiopure methyl *p*-tolyl sulfoxide produced the corresponding ruthenium bis(diimine) sulfoxide complexes **272** or **273** with high diastereoselectivity (73–76% de) and with a reduced reaction time compared to conventional heating (Scheme 69).¹⁸⁷

Microwave irradiation of 2 equiv of tridentate *N,N,N*-dqp and dqp NH_2 ligands (dqp = 2,6-di(quinolin-8-yl)pyridine **274**,

Scheme 69. Diastereoselective Formation of Polypyridine Ruthenium Complexes by Microwave Heating

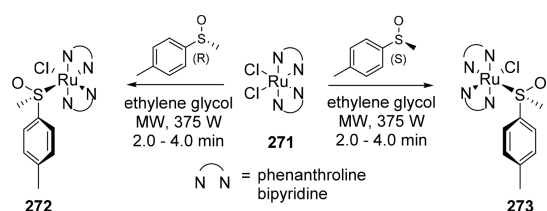

dqpNH₂ = 2,6-di(quinolin-8-yl)-4-aminopyridine **275**) with 1 equiv of [Ru(DMSO)₄Cl₂] **255** in ethylene glycol at 196 °C led to the formation of corresponding [Ru(dqp)₂][PF₆]₂ **278** and [Ru(dqpNH₂)₂][PF₆]₂ **279** in 87% and 22% yield, respectively (Scheme 70).¹⁸⁸ This procedure was unsuccessful

Scheme 70. Synthesis of Ruthenium Complexes with Tridentate Ligands

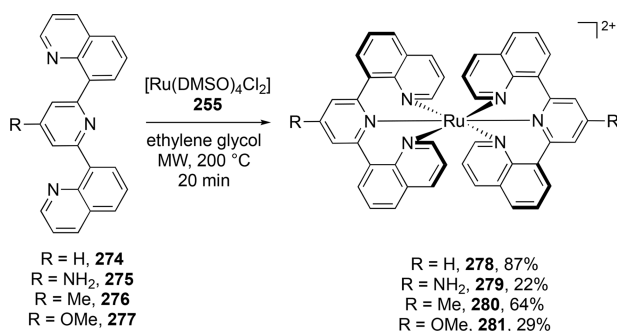

with dqpCO₂Et (4-ethyl-carboxy-2,6-di(quinolin-8-yl)-pyridine); only traces of product were detected.¹⁸⁹ These complexes showed unprecedented ³MLCT (metal to ligand charge transfer) lifetimes between 3 and 5.5 μs in room-temperature solution, which was a promising starting point for the construction of molecular arrays for applications in artificial photosynthesis. A similar synthesis using microwave irradiation was applied to form meridional (*mer*-) bistridentate ruthenium(II) complexes based on a dqp ligand containing inert functional groups.¹⁹⁰ Heating dqpPhMe **276** or dqpOMe **277** with [Ru(DMSO)₄Cl₂] in ethylene glycol at 200 °C using an Initiator single mode microwave cavity led to the formation of the *mer*-ruthenium complexes in 64 and 49% yield, respectively. Ligands with more reactive functional groups (R = -NH₂, -NO₂, -CO₂Et, or -Br) led to the corresponding complexes in lower yields or to the production of inseparable mixtures of complexes. Interestingly, after 5 min of irradiating dqp and [Ru(DMSO)₄Cl₂] in an ethylene glycol solution at 180 °C instead of 200 °C, a mixture of *cis*- and *trans*-*fac*-[Ru(dqp)₂]²⁺ **278** was obtained. Purification by column

chromatography produced the *cis* isomer in 56% and the *trans* in 12% yield. Notably, prolonged microwave heating of both isomers resulted in the isolation of the *mer*-isomer in quantitative yields.

Complexes featuring polystyrene-functionalized terpyridines **284** with varying molecular weights have also been prepared using microwave irradiation (Scheme 71).¹⁹¹ Three PS_x-[Ru]-PEG₇₀ (PS = polystyrene; PEG = polyethylene glycol) block copolymers have been obtained with conversions of up to 73% using optimized parameters: 1 h at 90 °C in chloroform or in a THF/MeOH mixture. While reduction of Ru(III) into Ru(II) requires harsh conditions under conventional heating, microwave irradiation enabled a decrease in reaction time and an increase in yield.

The use of microwave irradiation can also be valuable for the selective formation of organo-ruthenium species. During the conventional synthesis of [Ru(tctpy)(C-N)(NCS)] **286** (tctpy = tricarboxylterpyridine, C-N = cyclometallating ligand such as 2-phenylpyridinato or 2-(4-(2-phenylethynyl)phenyl)pyridinato) starting from [RuCl(Me-tctpy)(C-N)] **285**, an inseparable stereoisomer of the desired complex was generated due to isomerization of the starting materials.¹⁹² Pure ruthenium complex **286** could be obtained selectively by inhibition of the undesired isomerization using microwave irradiation (Scheme 72).

Similarly, only one isomer of [Ru(**288**)₃][PF₆]₂ complexes **289** was obtained by the reaction of 4-alkoxycarbonyl-substituted unsymmetrical bipyridine ligands **288** with ruthenium(III) chloride in ethylene glycol under microwave irradiation (Scheme 73).¹⁹³ This procedure was the first example of selective synthesis of the *fac*-isomer when using disconnected ligands. The authors could show that the position of the carboxyl group on the ligand played an important role for the stereochemistry of the complex since moving the ester from position C₄ to C₅ was detrimental to the *fac/mer* selectivity.

Microwave synthesis of polypyridyl ruthenium complexes was used to form a rare [Ru₂(**290**)₃]⁴⁺ triple helicate **291** which was shown to interact with DNA. The complex could be separated efficiently into P- and M-enantiomers by DNA-based affinity chromatography. Initially, RuCl₃ and the rigid quaterpyridine derivative **290** (5,5''-dimethyl-2,2':5',3'':6'':2''-quaterpyridine) in a 2:3 ratio were heated in EtOH at reflux for 2 weeks, resulting in a complex mixture of products. When the reaction was performed under microwave irradiation (pressure vessel) at 225 °C in ethylene glycol for 4.5 h, complex **291** was recovered in 36% yield (Scheme 74).¹⁹⁴ Although 36% is a moderate yield, it is by far better than the 1% yield previously reported for the synthesis of a dinuclear ruthenium(II) helicate.¹⁹⁵

Scheme 71. Synthesis of Heteroleptic Copolymer Complexes

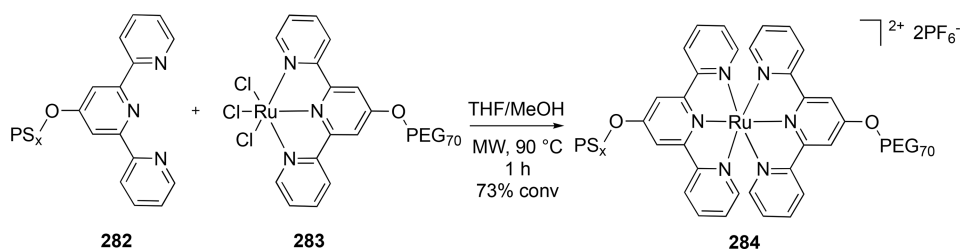

Scheme 72. Microwave Inhibition of Isomerization during the Synthesis of [Ru(tctpy)(C-N)(NCS)] Complexes

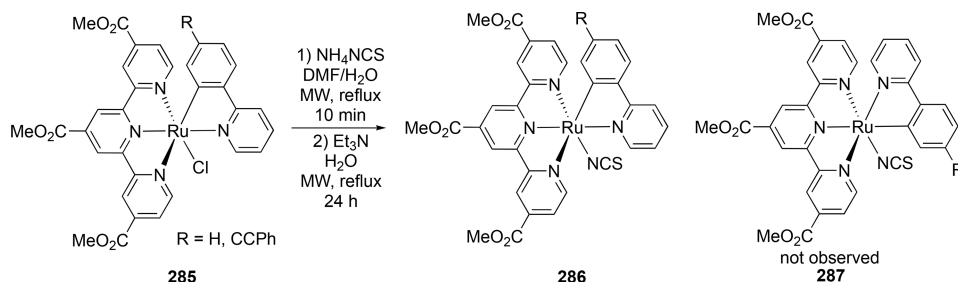

Scheme 73. Microwave Synthesis of *fac*-Isomer of Ruthenium Complexes

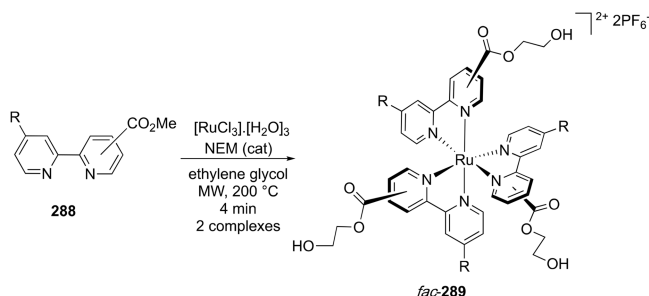

Scheme 74. Use of Microwave Irradiation for the Formation of the [Ru₂L₃][PF₆]₄ Triple Helicate

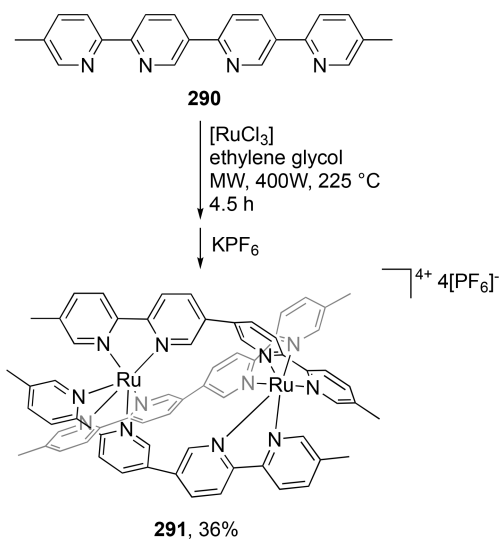

In view of introducing a bridging group between two organometallic moieties, a Sonogashira cross-coupling reaction between bromoruthenium complex **292** and triisopropylsilylacetylene (TIPSA) was employed to yield the ethynyl-functionalized product [**Ru(tipsepd)(bipy)**]₂[PF₆]**293** (tipsepd = ((triisopropylsilyl)ethynyl)-2,4-pentanedionate ion) (Scheme 75).¹⁹⁶ When compared to classical conditions, microwave irradiation allowed for a reduction in the reaction time from 4–5 days to 1 h, along with an increase in yield (from 40% to 62%).

In the search for new ligands with similar or higher acidity than pyridine-based diamines, a series of homoleptic trichelated ruthenium(II)–arylazoimidazole complexes **295** were synthesized by microwave heating (Scheme 76).¹⁹⁷ After (i) dissolution of [RuCl_3] \cdot [H_2O]₃ in super dry EtOH and heating

Scheme 75. Sonogashira Coupling with Functionalized Bipyridine Complex under Microwave Heating

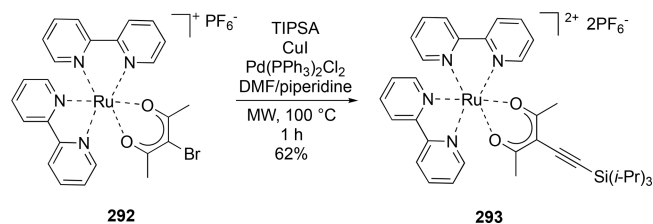

Scheme 76. Formation of Arylazoimidazoles Ruthenium Complexes under Microwave Heating

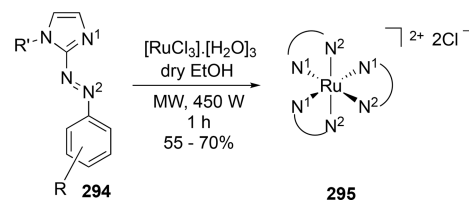

under MW irradiation for 3 × 5 min and (ii) addition of the ligand **294** previously dissolved in EtOH and heating under MW irradiation for another 3 × 5 min, complexes **295** were recovered in moderate to good yields.

A highly efficient microwave-assisted synthesis of paddlewheel tetrakis(diaryltriazenido)diruthenium complexes **297**, which possess interesting redox properties, was described in 2010 by the Jiménez-Aparicio group (Scheme 77).¹⁹⁸ These

Scheme 77. First Microwave Synthesis of Multiple Metal–Metal Bond Paddlewheel Compounds

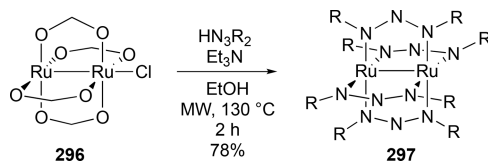

compounds were rarely described in the literature mainly because of the complexity of their synthesis, which requires five synthetic steps and up to 3 days to recover the complex in moderate yield. Using microwave irradiation enabled a reduction of the reaction time to 2 h, with the yield increased to 78% (90% for a reaction time of 8 h) as well as avoidance of toxic reagents and solvents. The same benefits were found for the microwave-assisted substitution of the acetate groups of [$\text{Ru}_2\text{Cl}(\text{OAc})_4$] by three different types of *N,N*-donor ligands (1,3-diaryltriazenido, 1,3-diarylformamidinate, and guanidinate). Six corresponding complexes were isolated in high

Scheme 78. Synthesis of Different Ruthenium Complexes Starting from $[\text{RuCl}_3] \cdot (\text{H}_2\text{O})_n$

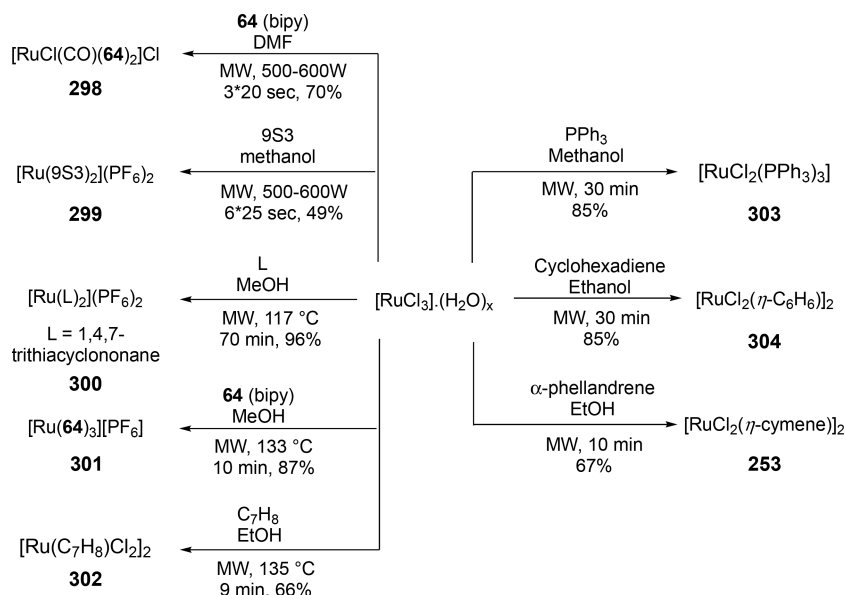

yields (90–98%) with reaction times between 15 min and 8 h.¹⁹⁹

As for rhenium complexes (see section 7.2), an early paper dealing with synthesis under microwave heating reported the synthesis of three different ruthenium complexes.¹²⁵ By using the same equipment, the microwave irradiation of $[\text{RuCl}_3] \cdot (\text{H}_2\text{O})_n$ and PPh_3 in MeOH for 30 min provided $[\text{RuCl}_2(\text{PPh}_3)_3]$ **303** in 85% yield (Scheme 78). Similarly, $[\text{RuCl}_2(\eta\text{-C}_6\text{H}_6)_2]$ **304** and $[\text{RuCl}_2(\eta\text{-cymene})_2]$ **253** were synthesized in 85 and 67% yield, respectively, by using EtOH as the solvent and cyclohexadiene or α -phellandrene as ligand precursors that were oxidized during the process. In comparison with the literature, 3 to 4 h was necessary under conventional reflux conditions, while less than 1 min was required with microwave heating. Remarkably, $[\text{RuCl}(\text{CO})(\text{bipy})_2]\text{Cl}$ **298** was isolated in 1 week using conventional synthesis but was obtained in only 1 min (70% yield) when using microwave irradiation in an autoclave (500–600 W).⁹¹ $[\text{Ru}(9\text{S}3)_2][\text{PF}_6]_2$ **299** (9S3 = 1,4,7-trithiacyclononane) was also synthesized in a few minutes in 49% yield, while it could not be obtained directly using conventional reflux conditions. Similarly, $[\text{Ru}(\text{bipy})_3][\text{PF}_6]$ **301** and $[\text{Ru}(\text{C}_7\text{H}_8)\text{Cl}_2]_2$ **302** (C_7H_8 = cycloheptatriene) were also synthesized in yields up to 87% and in short times (9 to 10 min) via microwave activation.²⁰⁰ Notably, this was the first reported use of a pressure-controlled microwave oven for the synthesis of organometallic species.

In 2009, the Clarke group described the microwave synthesis of new chiral catalyst **306** for the enantioselective hydrogenation and transfer hydrogenation of bulky and poorly reactive ketones.²⁰¹ It was the first time that a ruthenium complex featuring a chiral tridentate $\text{P}^{\wedge}\text{N}^{\wedge}\text{NH}_2$ -type ligand was used in this enantioselective reaction. Ruthenium complex **306** was synthesized in 83% yield by heating the ligand and $[\text{RuCl}_2(\text{DMSO})_4]$ under microwave irradiation (Biotage Initiator Microwave) in THF for 15 min at 120 °C (Scheme 79).

In 2014, synthesis of $[\text{Ru}_2\text{Br}(\mu\text{-O}_2\text{CC}_6\text{H}_4\text{Me})_4]$ **308** with the methyl group in either ortho, meta, or para position was described using three different methods: microwave irradiation

Scheme 79. Microwave Synthesis of a $\text{P}^{\wedge}\text{N}^{\wedge}\text{NH}_2$ Ruthenium Complex

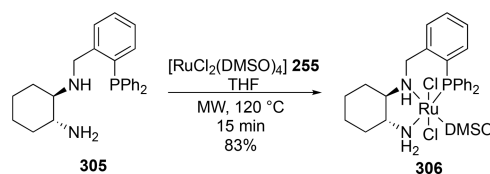

(using water as the solvent), solvothermal synthesis (using an autoclave and MeOH as the solvent), and conventional synthesis (at reflux in a MeOH/ H_2O mixture).²⁰² $[\text{Ru}_2\text{Br}(\text{OAc})_4]$ **307** was used as the ruthenium source and *o*-, *m*-, or *p*-toluic acid as ligand precursors (Scheme 80). All of the

Scheme 80. Microwave Synthesis of New Bromidotetracarboxylatodiruthenium(II,II) Complexes

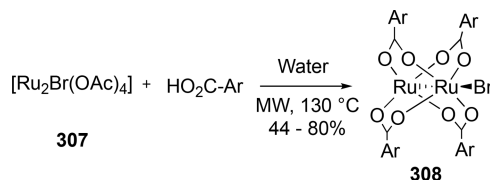

complexes adopted the typical paddlewheel structure (two ruthenium supported by four carboxylate ligands), and cationic $[\text{Ru}_2(\mu\text{-O}_2\text{CC}_6\text{H}_4\text{Me})_4]^+$ units were bridged by bromide anions giving infinite zigzag chains. Interestingly, although the reaction yield with *m*-toluic acid was better with the microwave-assisted procedure, those using conventional heating were slightly better for *o*- and *p*-toluic acid. The same study was carried out for the synthesis of $([\text{Ru}_2\text{Cl}(\text{9-atc})_4] \cdot 2\text{H}_2\text{O})_n$ (9-atc = 9-anthracenecarboxylic acid).²⁰³ In this case, heating a solution of $[\text{Ru}_2\text{Cl}(\text{OAc})_4]$ and 9-atc in a mixture of MeOH/water at reflux for 4 h was more efficient than microwave irradiation as the expected complex product was recovered in 70% and 56%, respectively.

Generally, synthesis of $[\text{Ru}(\textit{p}\text{-cymene})(\text{azole})_2\text{Cl}]\text{Cl}$ **310–313** (azole = 1-Me-imidazole, 1*H*-pyrazole, 1*H*-benzimidazole,

Scheme 81. Microwave-Enhanced Synthesis of N-Heterocycle-Containing Ruthenium Species

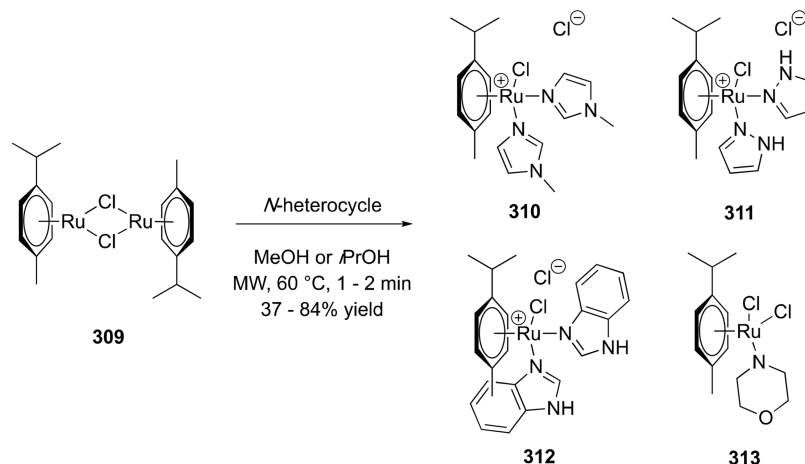

Scheme 82. Microwave Synthesis of $[\text{Ru}(\text{Cp}^\wedge)_2\text{Cl}_2]_2$

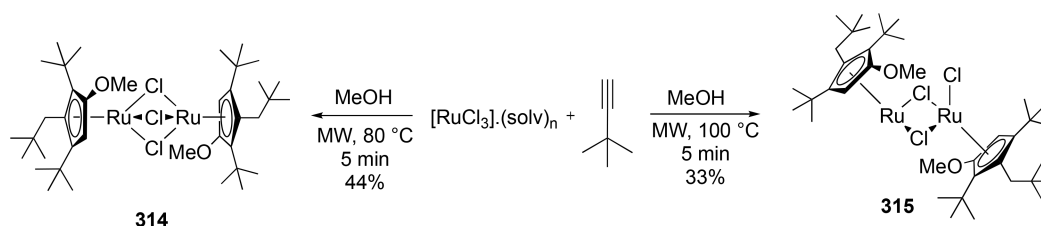

Scheme 83. Microwave Synthesis of a Tp Sandwich Compound

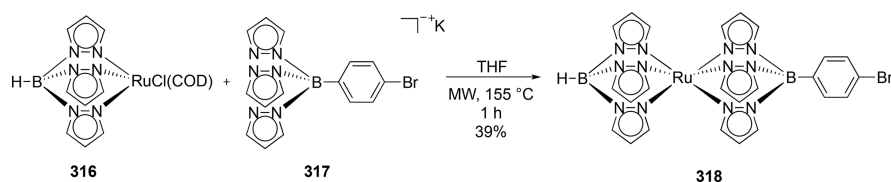

or morpholine) is performed by refluxing a solution of $[\text{Ru}(\text{arene})\text{Cl}_2]_2$ **309** for 7–18 h in the presence of the N-containing heterocycle. The reaction time was, however, drastically decreased to only 1 or 2 min by heating the reaction mixture at 60 °C under microwave irradiation (Scheme 81) (CEM Explorer 12 Hybrid apparatus).²⁰⁴ The yields were higher than those obtained by a conventional synthesis (37–84% vs 32–75%).

Dinuclear complexes $[\text{RuCl}_2(\textit{p}\text{-cymene})]_2$ and $[\text{RuCl}_2(\text{cyclopentadienyl})]_2$ are important starting materials for the synthesis of other ruthenium complexes. Standard syntheses of these complexes were performed by heating the metal source and the ligand in an alcoholic solvent for several hours at reflux. In 1990, a microwave apparatus was used to develop a more efficient synthesis of $[\text{RuCl}_2(\textit{p}\text{-cymene})]_2$ (Scheme 78).¹²⁵ In 2013, reaction conditions were further optimized to obtain the complex in only 30 s of microwave heating at 140 °C (by using a Biotage initiator 2.0).²⁰⁵ The complex was obtained in 86% yield, and only 2.5 equiv of the diene precursor was used instead of the large excess employed in the previously described methods. Similarly, $[\text{RuCl}_2(\text{Cp}^*)]$ could be synthesized in 72% yield by microwave heating at 100 °C for 5 min while taking particular care to exclude air from the reaction mixture. Interestingly, $[\text{RuCl}_2(\text{Cp}^\wedge)]_2$ **315** (Cp^\wedge = “Cp roof ligand”, 2,4-di-*tert*-butyl-3-(2,2-dimethylpropyl)-1-methoxycyclopentadienyl) could be formed *in situ* by a metal-

mediated multicomponent reaction between *tert*-butylacetylene and MeOH (Scheme 82). Heating the reaction mixture at 100 °C for 5 min led to the formation of the desired complex, whereas decreasing the temperature to 80 °C induced the formation of the unexpected ruthenium complex **314**, the formation of which could not be rationalized.

Hydrido-tris(pyrazolyl)borate (Tp) is an analogue of the widely used Cp ligand. The Metzler–Nolte group used it for the production of ruthenium complexes in 2011. Starting from a solution of $[\text{RuTp}(\text{COD})\text{Cl}]$ **316** and *p*-BrC₆H₄TpK **317** in THF, $[\text{Ru}(\textit{p}\text{-C}_6\text{H}_4\text{Tp})\text{Tp}]$ **318** was synthesized by heating the reaction mixture for 1 h at 155 °C under microwave irradiation (Scheme 83).²⁰⁶ In classical conditions, the reaction mixture was heated for 12 h to obtain the complex in lower yield (19%), probably because of starting material decomposition. Interestingly, **318** was then converted to $[\text{RuTp}(\textit{p}\text{-(CO}_2\text{H)-C}_6\text{H}_4\text{Tp})]$, which was coupled to the pentapeptide Enkephalin using solid-phase synthesis to provide $[\text{RuTp}(\textit{p}\text{-(CO-Tyr-Gly-Gly-Phe-Leu-OH)-C}_6\text{H}_4\text{Tp})]$ as the first example of a ruthenium Tp sandwich bioconjugate.

Fast ligand modification around the ruthenium center of $[\text{RuCl}(\text{Cp})(\text{PPh}_3)_2]$ **319** could be performed efficiently using microwave irradiation. Heating a mixture of dppm **62** and various thiolate ligands with **319** in diethylene glycol produced the corresponding $[\text{Ru}(\text{Cp})(\text{dppm})\text{SR}]$ complexes **320** in good yields (Scheme 84).²⁰⁷ Complexes were recovered after

Scheme 84. Microwave Synthesis of Cyclopentadienyl Bisphosphine Ruthenium(II) Thiolate Complexes

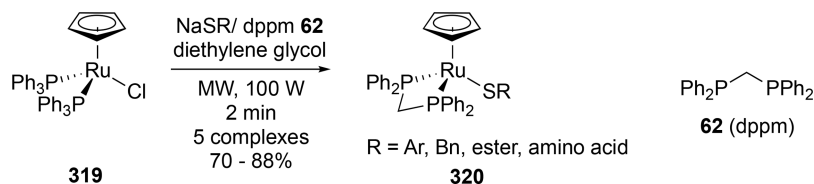

only 2 min of heating with a Labwell Microwell 10 reactor operated at 100 W, in 10 min while using a household microwave oven and in 2 h when using conventional heating conditions. Similar yields were obtained independently of the chosen method. Direct insertion of thiophenol into the coordination sphere of **319** proved difficult since numerous side products were formed. Such examples proved the need for a stabilizing bidentate dppm ligand on the metal. Interestingly, the use of an amino acid thiolate ligand resulted in the selective formation of a Ru–S bond under microwave activation, while a mixture with a COO linkage was observed in classical synthesis.

Contrary to what was observed with Cp ligands, microwave heating (Biotage initiator) of ruthenium complexes featuring arene ligands in the presence of L–L' bidentate ligands (P–P', N–N', P–N, and P–S– chelate ligands) led to the displacement of the arene, resulting in complexes of the general formula $[(\text{arene})\text{Ru}(\mu\text{-Cl})_3\text{RuCl}(\text{L-L}')] \mathbf{323}$ (Scheme 85).²⁰⁸ Microwave irradiation of $[\text{RuCl}_2(\text{arene})]_2$

Scheme 85. Microwave Synthesis of $[(\text{arene})\text{Ru}(\mu\text{-Cl})_3\text{RuCl}(\text{L-L}')] \mathbf{323}$ Complexes

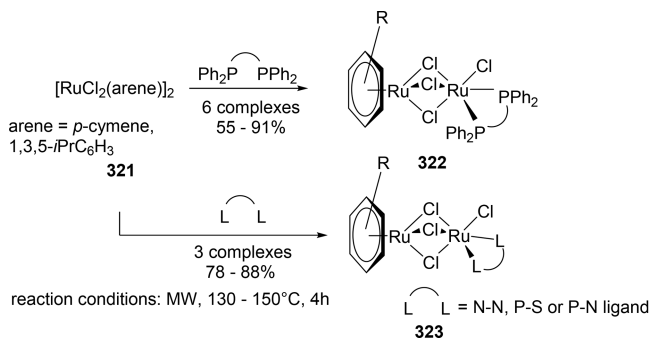

with diphosphine ligands in a THF solution at 130–150 °C for 4 h provided six dinuclear ruthenium complexes **322** in yields of 55–91%, including $[\text{Ru}(\mu\text{-Cl})_3\text{RuCl}(\mu\text{-}(\text{S,S})\text{-DIOP})]$ (DIOP = (4*S*,5*S*)-2,2-(dimethyl-1,3-dioxolane-4,5-diyl)bis(methylene)bis(diphenylphosphine)). Under classical reflux conditions in THF, $[\text{RuCl}_2(\textit{p}\text{-cymene})_2(\mu\text{-}(\text{S,S})\text{-DIOP})]$ was formed, but a change of solvent to 2-ethoxyethanol allowed the isolation of the desired dinuclear complex $[\text{Ru}(\mu\text{-Cl})_3\text{RuCl}(\mu\text{-}(\text{S,S})\text{-DIOP})]$, albeit in lower yield and longer reaction time than under microwave irradiation. The use of N–N', P–N,

and P–S– chelates was also efficient, providing corresponding complexes **323** in 78–88% yields.

A microwave-assisted synthesis of Shvo-type complexes **325** was developed in 2014 by the Mazzoni group.²⁰⁹ Hydroxycyclopentadienylruthenium hydride dimer complexes, known as Shvo-type complexes, are precursors of useful catalysts. When solutions of $[\text{Ru}_3(\text{CO})_{12}]$ and functionalized tetraarylcyclopentadienones **324** were heated in MeOH at 110 °C in a “high-throughput rotor” microwave oven, corresponding complexes **325** were produced in 23–75% yields (Scheme 86). The most striking advantage of this approach is the reduction of the reaction time, from 40 h under classical solution conditions to 50 min via microwave irradiation.

There are few examples of microwave synthesis of osmium complexes described in the literature. In 2006, the microwave-assisted synthesis of $[\text{Os}_2\text{Cl}_3(\text{PET}_2\text{Ph})_6]\text{Cl}$ **328** was reported (Scheme 87).²¹⁰ This complex was used as a synthon for the synthesis of various osmium complexes and was crucial for the synthesis of dihydrogen osmium complexes. Microwave heating enabled the isolation of **328** in only 5 min under aerobic conditions, while previous methods required refluxing in aqueous EtOH for 1 week. Interestingly, this publication was the first to describe the structure of the complex thanks to single-crystal X-ray diffraction.

The classical synthesis of arene(osmium) halide complexes is well-documented, and all the reported procedures require long reaction times (up to 100 h) as well as high temperatures to achieve completion.²¹¹ Microwave heating at 110 °C of Na_2OsCl_6 with 1,3-cyclohexadiene in EtOH allowed the formation of $[\text{OsCl}_2(\eta\text{-C}_6\text{H}_6)]_2$ **329** in high yield (97%) with a shorter reaction time (Scheme 88).

Similarly to ruthenium complexes (see Scheme 81), $[\text{Os}(\textit{p}\text{-cymene})\text{Cl}(\text{azole})_2]\text{Cl}$ (azole = 1-Me-imidazole, 1*H*-pyrazole, or 1*H*-benzimidazole) could be synthesized by heating a polar alcohol solution of $[\text{Os}(\textit{p}\text{-cymene})\text{Cl}_2]$ with an N-containing heterocyclic ligand at 80 °C with microwave activation.²⁰⁴ Only 1 or 2 min of reaction was necessary for efficient formation of the osmium complexes (54–78% yield). Using morpholine (morph) in the reaction mixture provided the $[\text{Os}(\textit{p}\text{-cymene})(\text{morph})\text{Cl}_2]$ complex.

8.3. Ultrasonic Irradiation for Iron Complexes

Two different 2-ferrocenylpyrazoles **330** were methylated using ultrasound chemistry (Scheme 89).¹⁶⁷ A solution of ferrocenyl complex **330**, sodium hydride, and methyl *p*-

Scheme 86. Synthesis of Shvo-Type Ruthenium Complexes

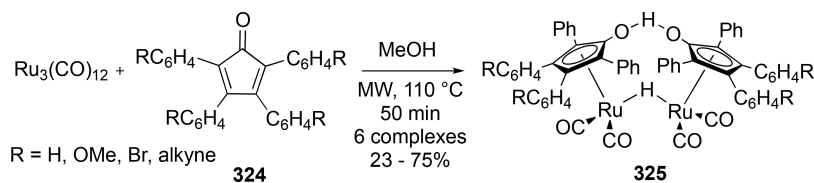

Scheme 87. Microwave Synthesis of a Useful Osmium Synthone

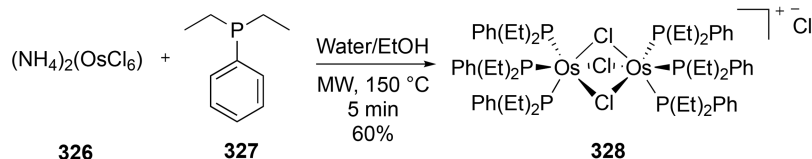

Scheme 88. Synthesis of $[\text{OsCl}_2(\eta\text{-C}_6\text{H}_6)]_2$ Using Microwave Irradiation

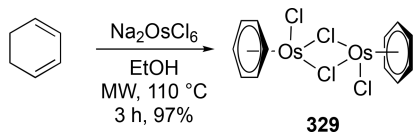

Scheme 89. Methylation of 2-Ferrocenylpyrazole under Ultrasonic Irradiation

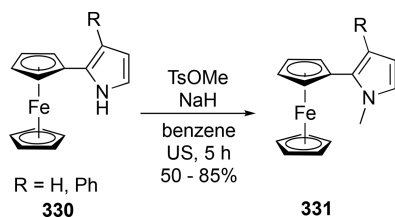

toluenesulfonate in benzene was sonicated for 5 h to produce the corresponding complexes **331** in 50 and 85% yield.

The Raghunathan group developed an expedient one-pot, four-component synthesis of ferrocene-grafted spiropyrrolidine heterocycles **336** that was assisted by ultrasonic treatment.²¹²

A solution of the ferrocene-derived dipolarophile **335**, ninhydrin **332**, 1,2-phenylenediamine **333**, and sarcosine **334** in MeOH was sonicated under refluxing conditions for 1 to 2 h to afford the desired complexes with high yield and high regioselectivity, as confirmed by X-ray diffraction (Scheme 90). The author suggested that the reaction proceeded via reaction of ninhydrin, 1,2-phenylenediamine, and sarcosine to form the azomethine ylide intermediate **338**, which then reacted with ferrocene derivative **335** via a [3 + 2]-cycloaddition. By reacting with 1-phenyl-3-ferrocenyl-3-prop-2-en-1-one derivatives, five similar complexes were formed in high yields. Under classical thermal conditions, 5 to 7 h was necessary to afford the desired ferrocene complexes **336** in lower yields.

Scheme 90. Ultrasound Synthesis of Novel Ferrocene-Grafted Pyrrolidine Heterocycles

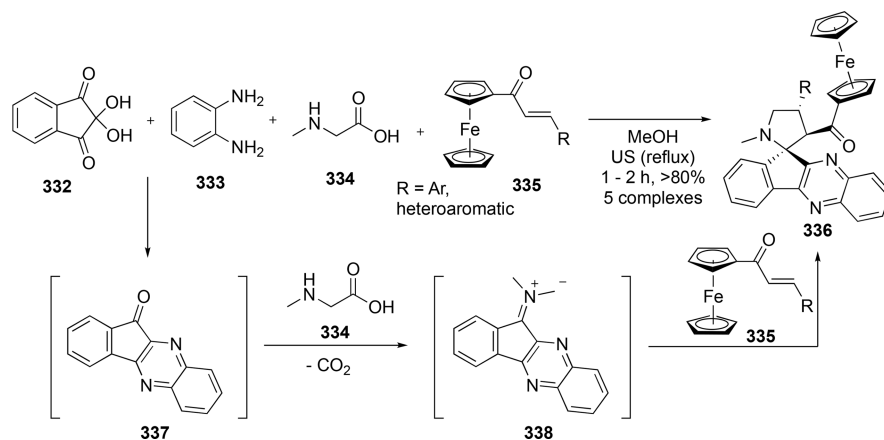

The Penoni and Cravotto groups developed an ultrasound-assisted, one-pot, three-component reaction with ferrocene-carboxaldehyde **236** (Scheme 91).²¹³ Allylindation and

Scheme 91. Ultrasound Allylation of Ferrocenecarboxaldehyde

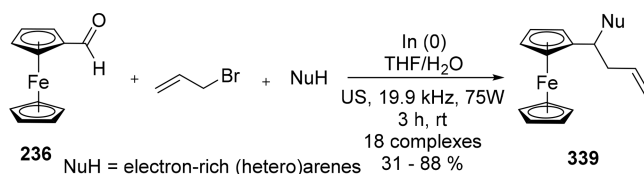

dehydrative alkylation of stabilized C- or N-nucleophiles gave the corresponding functionalized ferrocenes **339** in good yields. Various ultrasonic baths were tested for the reaction, and the cup horns working at 19.9 kHz (75 W) were found to be the most efficient. When reacting with highly activated nucleophiles such as pyrrole and furan, the bisalkylated compound was the single product.

8.4. Syntheses of Iron and Ruthenium Complexes Using Photochemistry

In 2008, a short review written by Aranzas and Astruc described the synthesis of various piano-stool organo-iron complexes $[\text{FeCpL}^1\text{L}^2\text{L}^3]^+$ **341**–**343** (L = neutral two-electron ligand) by visible photolysis of $[\text{FeCp}(\text{arene})][\text{PF}_6]$ sandwich complexes **340** (Scheme 92).²¹⁴ Arene displacement and nucleophilic substitution were performed under light irradiation and yielded the phosphino or acetonitrile complexes. When the nucleophilic substitution was attempted on $[\text{FeCp}(\text{C}_6\text{Me}_6)][\text{OH}]$ in water, the reaction led to the decomposition of the ferrocenyl complex. If all the reactions were first described with a Cp ring on the iron complex, the reaction conditions could also be used to form Cp*-containing iron derivatives.

Scheme 92. Photochemical Access to Piano-Stool FeCp Analogue Complexes

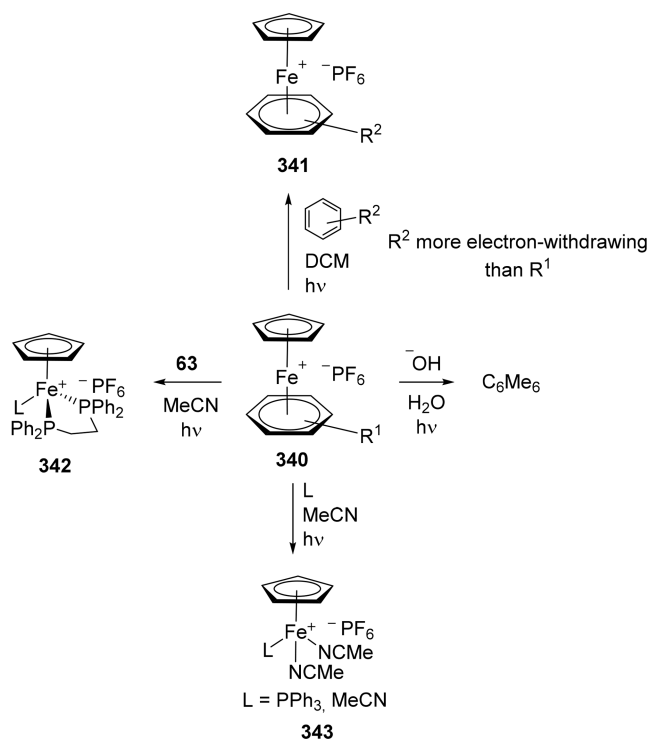

Interestingly, photolysis of $[\text{FeCp}(\text{arene})]\text{PF}_6$ could be used to functionalize Cp–iron complexes. In this context, the Astruc group described the photolysis of $[\text{FeCp}(\eta^6\text{-toluene})]\text{PF}_6$ **344** in 2009 as a general route to iron–alkynyl complexes **345** using terminal alkynes, through a decoordination of the toluene ligand (Scheme 93).²¹⁵ The reaction was then extended to ferrocenylacetylene to yield bimetallic complexes **346–347** starting from 1,4-bis(ethynyl)benzene or ethynylferrocene.

Starting from ferrocenyl imines **348** and **349**, ferrocene-substituted 2-azetidinones **351** and **352** could be obtained predominantly as *cis* isomers in good yields after irradiation in the presence of alkoxychromium(0)–carbene complexes **350** (Scheme 94, reaction A).²¹⁶ Contrastingly, irradiation of the ferrocenechromium(0)–carbene complex **353** with an imine under different reaction conditions was systematically unsuccessful, thus showing that this complex was photochemically inert (Scheme 94, reaction B). Alternative approaches to place a ferrocene moiety at the C3 position of the 2-azetidinone ring failed. However, irradiation under CO

pressure of aminochromium(0)–carbene complex **354** possessing a ferrocene group attached to its amino moiety gave azetidine complex **356** in low yield (23%) (Scheme 94, reaction C).

There are few reports of ruthenium complex synthesis via photochemistry. In 1989, Suen et al. subjected a series of ruthenium terpyridine complexes to photolysis and studied their ligand substitution. Photolysis (using a 275 W sunlamp) of $[\text{Ru}(\text{terpy})\text{L}_3]^{2+}$ **357** or $[\text{Ru}(\text{terpy})\text{L}_2\text{Cl}]^+$ **358** (L = ACN, PPh₃, Py) in acetone or dichloromethane resulted in the efficient loss of the ligand and coordination of the solvent molecule (acetonitrile or propionitrile). When these nitriles were replaced by tetraethylammonium chloride, a chloride ligand was added to the metal center (**359–360**, Scheme 95).²¹⁷ Column chromatography using alumina was used to purify the complexes, which were recovered in yields higher than 80%. Surprising specificity of ligand loss was observed, in favor of the ligand in the axial position. This observation was explained by a photosubstitution theory based on the angular overlap model with the basic assumption defined by IUPAC as “the strength of a bond formed using atomic orbitals on two atoms is related to the magnitude of overlap of the two orbitals”.

In 2009, Matsubara et al. described the irradiation of a solution of $[\text{Ru}(\text{terpy})(\text{bipy})(\text{DMF})]^{2+}$ **363** and triethylamine in THF using 436 nm monochromatic light for 2 h to generate the hydrido complex $[\text{Ru}(\text{terpy})(\text{bipy})\text{H}]^+$ **364**, which could be produced in quantitative yield (Scheme 96).²¹⁸ After irradiation, the 1-benzyl-3-trifluoromethylpyridinium cation **365** was added to obtain the corresponding hydride reduction product **366**. Investigations of the properties of $[\text{Ru}(\text{terpy})(\text{bipy})(\text{DMF})]^{2+}$ **363** and $[\text{Ru}(\text{terpy})(\text{bipy})(\text{NEt}_3)]^{2+}$ indicated that the formation of the hydrido ruthenium complex **364** proceeded via the excitation of the triethylamino–ruthenium complex. In the absence of NEt₃, irradiation of a solution containing complex **363** in THF resulted in a ligand exchange reaction to give the $[\text{Ru}(\text{terpy})(\text{bipy})(\text{THF})]^{2+}$ complex. Due to the low reformation of **363** and the large quantity of THF as compared to DMF, $[\text{Ru}(\text{terpy})(\text{bipy})(\text{THF})]^{2+}$ was obtained in nearly quantitative yield.

Padhi and Tanaka demonstrated the photoredox behavior of complex $[\text{Ru}(\text{phbn})(\text{bipy})_2]\text{PF}_6$ **368** (phbn = 3-phenylbenzo-[b][1,6]naphthyridine).²¹⁹ Irradiation of the complex in the presence of 1 equiv of hydroquinone in a mixture of acetonitrile/Et₃N produced the reduced $[\text{Ru}(\text{phbnH}_2)(\text{bipy})_2]\text{PF}_6$ **369** quickly and in good yield (Scheme 97, pathway A). Similarly, under irradiation, the reduction could be performed in acetonitrile with 1 equiv of *p*-chloranil, yielding **369** in 78% yield (Scheme 97, pathway B).

Scheme 93. Synthesis of Iron–Acetylide Complexes by Visible-Light Photolysis

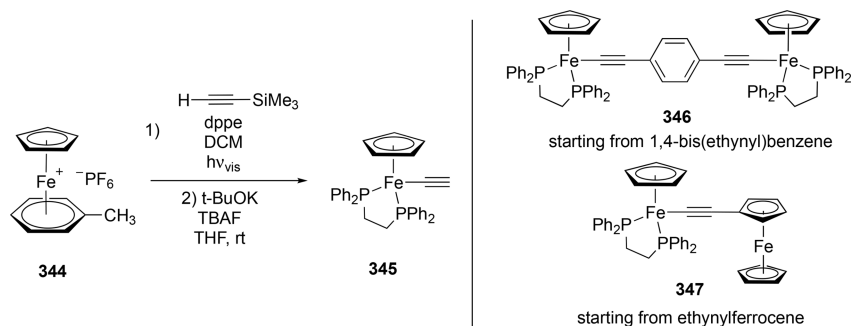

Scheme 94. Photochemical Synthesis of Ferrocene-Substituted 2-Azetidinone Complexes

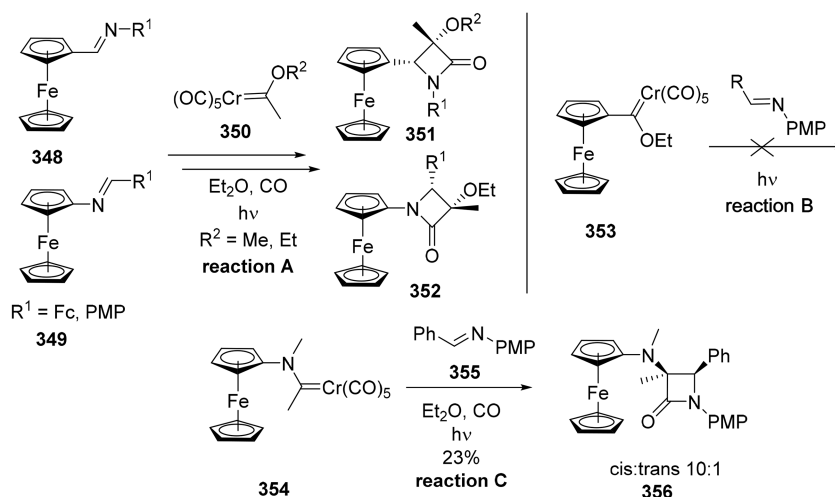

Scheme 95. Photochemical Ligand Substitution of $[\text{Ru}(\text{terpy})\text{L}_3]^{2+}$ and $[\text{Ru}(\text{terpy})\text{L}_2\text{Cl}]^+$

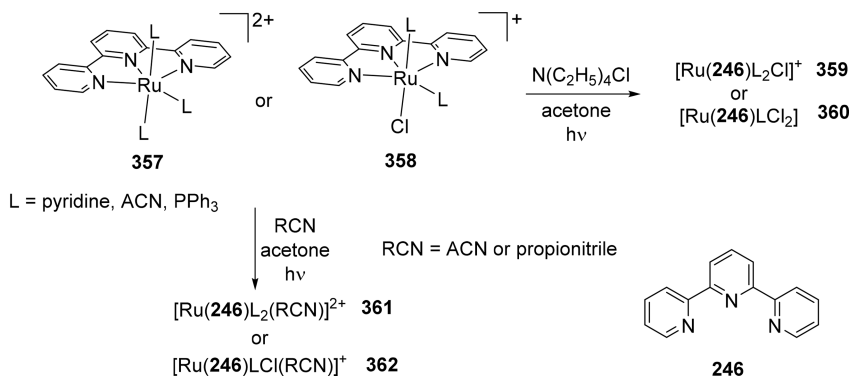

Scheme 96. Photochemical Formation of a Hydrido Ruthenium Complex by Irradiation of $[\text{Ru}(\text{terpy})(\text{bipy})(\text{DMF})]^{2+}$

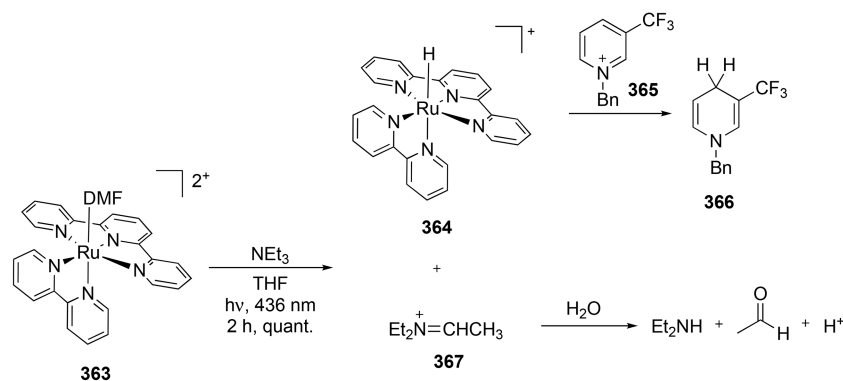

In 2007, Cooke proposed the photochemical preparation of various $[\text{Ru}(\text{CO})_4(\eta^2\text{-alkene})]$ complexes (**370**) from $[\text{Ru}_3(\text{CO})_{12}]$ (Scheme 98).²²⁰ The aim of this study was to demonstrate that under light excitation a metal–metal bond can be cleaved instead of the more classical metal–carbonyl bond breakage. The reaction could be performed under different conditions ranging from filtered high-intensity light to sunlight or conventional fluorescent lighting. Only a few minutes was necessary using a high-intensity light, while irradiation for days was required under fluorescent lighting of lower intensity. The methods were suitable for preparative-

scale reactions (around 0.2 g), and products were recovered in quantitative yield.

As for iron, photolysis of $[\text{RuCp}(\text{benzene})]^+$ **371** in acetonitrile at 313 nm led to the decoordination of the benzene and the quantitative formation of $[\text{RuCp}(\text{ACN})_3]^+$ **372**, which could be isolated as a PF_6^- salt with a quantum yield of 0.4.²²¹ No photoreaction was observed when irradiating a solution of **371** in CH_2Cl_2 in the absence of ligands. The addition of phosphites ($\text{P}(\text{OCH}_3)_3$ or $\text{P}(\text{OEt})_3$), however, yielded the corresponding $[\text{RuCp}(\text{P}(\text{OR})_3)_3]^+$ **373** complexes after photolysis (Scheme 99). Surprisingly, in the presence of $\text{P}(\text{OPh})_3$, only the starting materials were

Scheme 97. Photoredox Reaction of the Ru Complex

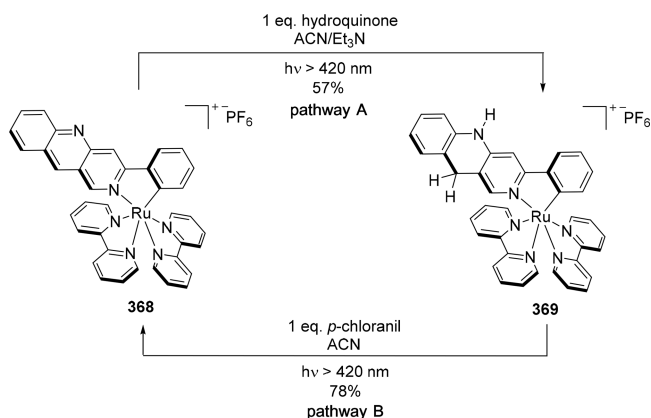

Scheme 98. Photochemical Transformation of [Ru₃(CO)₁₀]

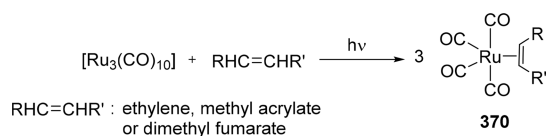

recovered. This contrasted with results obtained for the photolysis of [FeCp(*p*-xylene)], which led to the efficient formation of [FeCp(P(OPh)₃)₃]⁺. Notably, under thermal conditions, the trisacetonitrile complex 372 could be transformed into different phosphino- or arene-ruthenium complexes. The number of acetonitrile substitutions was controlled by temperature as room temperature promoted only one substitution, while refluxing conditions resulted in three acetonitrile substitutions.

8.5. Continuous Flow Conditions to Prepare Iron and Ruthenium Complexes

The Renaud and Whitby groups transferred their microwave procedures (Scheme 59) into a flow process with minor adjustments of reacting temperatures and solvents (Scheme 100). Using this method, mixed phosphorus-nitrogen ferrocene complexes 224 were obtained from [FeCp(*naphthalene*)]⁺[PF₆]⁻ 223 in slightly lower yields than via microwave irradiation.¹⁶⁶

Cationic cyclopentadienyl ruthenium complexes [RuCp]⁺ are highly versatile catalysts due to their high π -acidic character, their capacity to hold reversible redox cycles, and their large range of oxidation states and coordination geometries. For these reasons the Jamison group investigated the preparation of [RuCp(ACN)₃]⁺PF₆⁻ 372 from [RuCp(η^6 -C₆H₆)]⁺PF₆⁻ 371 via continuous flow photochemistry.²²² Synthesis was performed using homemade equipment featuring a coil wrapped around a condenser and a 450 W Hg lamp (Scheme 101). Under these conditions, the catalyst

Scheme 99. Phototransformation of [RuCp(η^6 -benzene)]⁺PF₆⁻

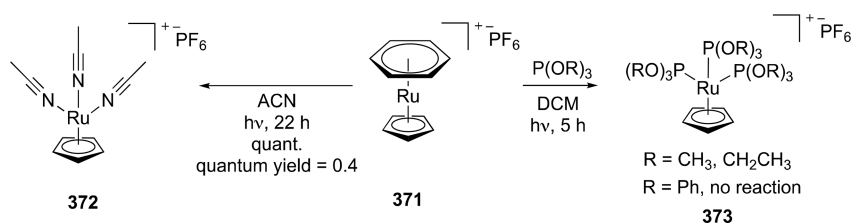

Scheme 100. Continuous Flow Process for the Synthesis of Phosphino Iron Complexes

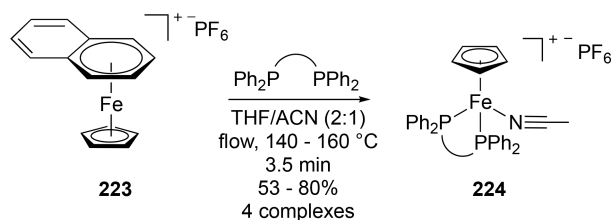

Scheme 101. Reactor for the Synthesis of [RuCp(ACN)₃]⁺PF₆⁻

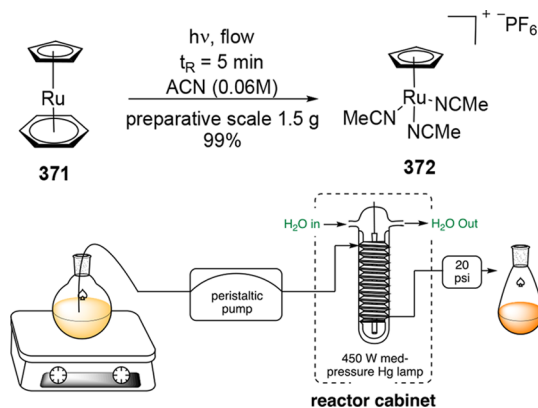

was formed in >99% purity, and no additional purification was required. The ruthenium catalyst was produced with a throughput of 1.56 g/h using a 5 mL reactor, which is 10 times higher than the reported batch process. Additionally, inter- and intramolecular ene-yne coupling reactions could be catalyzed by the species formed *in situ* during photolysis of 371 under continuous flow conditions.²²³ Interestingly, the catalyst could be quantitatively recovered at the end of the reaction.

9. GROUP 9

9.1. Synthesis of Cobalt and Rhodium Complexes by Mechanochemistry

Similarly to group 8 metal complexes, cobalt complexes exhibit promising activity against several human cancer cell lines, and several rhodium complexes exhibit oxygen-independent light-induced anticancer activity.¹⁴² Cobalt complexes were also investigated for the inhibition of enzymes.⁶ As for iron(III) bisdicarbollyl complex 194, Borisov et al. described the mechanochemistry of cobalt(III) bisdicarbollyl complex 375 in 1993.¹⁵⁷ The reaction was performed in a stainless steel reactor that was charged with 15 steel balls (12 mm diameter), CoCl₃, and Tl₂C₂B₉H₁₁ 192. After 30 min of reaction at a frequency of 12 Hz and an amplitude of 11 mm, the reaction

mixture was recovered and treated with an excess of Me_4NHSO_4 to isolate the desired cobalt complex **375** after filtration and recrystallization (Scheme 102). Importantly, the

Scheme 102. Mechanochemical Synthesis of a Cobalt(III)–Bisdicarbollyl Complex

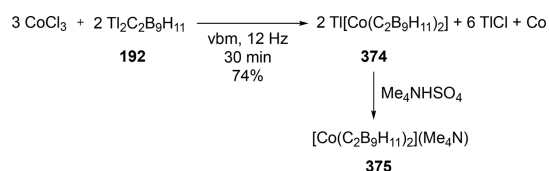

reaction could be performed at room temperature or at a maximum of 30–40 °C (if heating of the jar occurred during milling), whereas those described in solution had to be heated at 60 °C.

Similarly to iron complexes, the zwitterionic $[\text{Co}^{\text{III}}(\eta^5\text{-C}_5\text{H}_4\text{COOH})(\eta^5\text{-C}_5\text{H}_4\text{COO})]$ complex reacted in the solid state under mechanical forces with numerous salts such as KBr, NH_4PF_6 , and KPF_6 to produce the $[\text{Co}^{\text{III}}(\eta^5\text{-C}_5\text{H}_4\text{COOH})(\eta^5\text{-C}_5\text{H}_4\text{COO})]_2 \cdot \text{C}^+ \text{A}^-$ (C^+ = cation, K^+ , Rb^+ , Cs^+ , and NH_4^+ ; A^- = anion, Cl^- , Br^- , and PF_6^-) complexes in quantitative yields.²²⁴

In 1991, Ogawa et al. described the mechanochemical formation of $[\text{Co}(\text{bipy})_3]\text{Cl}_2$ complex **376**.²²⁵ Dried cobalt(II) montmorillonites and bipy were ground in an agate mortar and pestle for a few minutes at room temperature under a dry air atmosphere (Scheme 103). Before grinding the solid mixture,

Scheme 103. Structure of Pyridine-Containing Cobalt Complexes

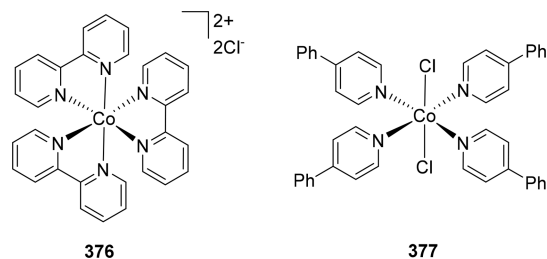

cobalt(II) montmorillonite was dried under two different conditions to vary the hydrated states of Co(II) interlayers (either at 120 °C for 2 h under vacuum or at 300 °C for 2 h

under air). Whereas montmorillonite dried at 120 °C led to the desired complex after grinding, when it was dried at 300 °C the expected complex was not produced.

Mechanochemical synthesis was also used to obtain the Werner complex $[\text{CoCl}_2(\text{4-PhPy})_4]$ **377** (4-PhPy = 4-phenylpyridine) by grinding the 4-PhPy ligand with CoCl_2 (Scheme 103).²²⁶ Octahedral 0-D Werner complexes $[\text{MX}_2\text{L}_4]$ are generally known for their ability to trap a variety of aromatic guests and have been employed in chromatography for the separation of aromatic compounds.²²⁷ Manual grinding of the ligand 4-PhPy with a mixture of CoCl_2 and NiCl_2 produced the solid solution $[\text{Ni}_{0.5}\text{Co}_{0.5}\text{Cl}_2(\text{4-PhPy})_4]$. Crystallization of a mixture of $[\text{NiCl}_2(\text{4-PhPy})_4]$ and $[\text{CoCl}_2(\text{4-PhPy})_4]$ **377** in MeOH did not result in the solid solution but a nonhomogeneous product (mixture of $[\text{MCl}_2(\text{4-PhPy})_4]$; M = Co, Ni) composed of MeOH solvates of the Ni and Co complexes, showing that the solid solution can only be obtained by grinding.

Two mechanochemical methods were developed to prepare $[\text{CoCl}_2(\text{CEAP})_2]$ **381** (CEAP = 4-[N,N-bis(2-cyanoethyl)-amino]pyridine, **378**).²²⁸ CEAP and $\text{CoCl}_2 \cdot 6\text{H}_2\text{O}$ (2:1 ratio) or $[\text{CEAPH}]_2[\text{CoCl}_4]$ **380** and KOH were ground in an agate mortar and pestle for 15 min to produce the same complex **381**. Notably, the hydrogen-bonded salt **380** that was used in the second method could also be synthesized mechanochemically by grinding CEAPH **379** and $\text{CoCl}_2 \cdot 6\text{H}_2\text{O}$ for 15 min (Scheme 104). The products could be synthesized using classical solvothermal conditions, but longer reaction times were required to reach completion.

Similarly to the ruthenium complexes described above (Scheme 54), $[\text{Co}(\text{Hbiim})_3] \cdot 3\text{H}_2\text{O}$ was synthesized in 84% yield by grinding with ammonium acetate and H_2O_2 in a mortar and pestle for 25 min.

In 1997, the synthesis of dichlorobis(4-toluidine) cobalt(II) was reported by grinding $\text{CoCl}_2 \cdot 6\text{H}_2\text{O}$ and 4-toluidine at 1:2 stoichiometric ratio at room temperature. The complex was obtained in 95% yield after 15 min of grinding.²²⁹ Similarly, the Liu group used various anilines, ground with $\text{CoCl}_2 \cdot 6\text{H}_2\text{O}$, to form seven cobalt–amine complexes with the general formula $[\text{CoCl}_2(\text{H}_2\text{O})_2(\text{ArNH}_2)_2]$ (**382**, Scheme 105).²³⁰ The reactions were efficient with anilines containing an electron-donating group on the phenyl ring and led to the complexes quickly and in quantitative yields. On the contrary, when a moderate ($-\text{COCH}_3$, $-\text{CO}_2\text{C}_2\text{H}_5$) or strong ($-\text{CN}$, $-\text{NO}_2$) electron-withdrawing group was present on the aniline, the

Scheme 104. Synthesis of Co–CEAP Complexes Using Mortar and Pestle

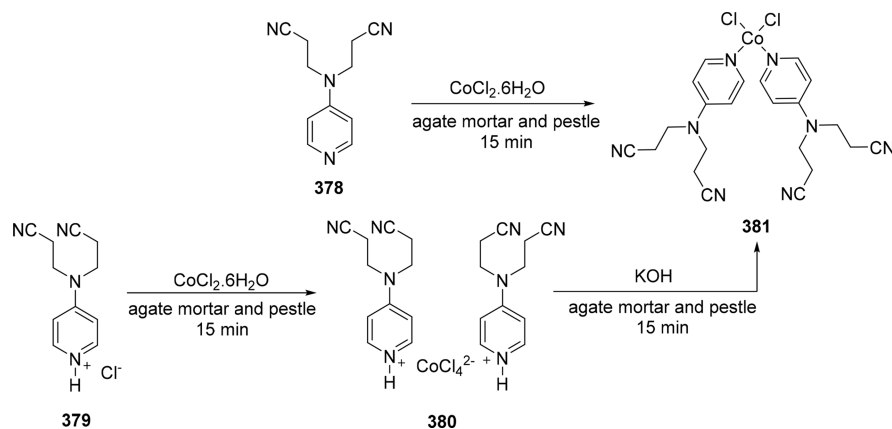

Scheme 105. Mechanochemical Synthesis of Cobalt–Amine Complexes

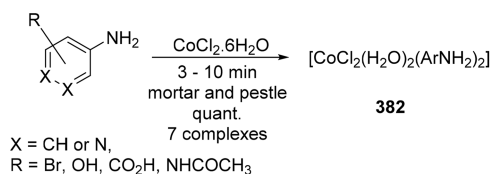

reactions were completely inhibited. Additionally, the use of *ortho*-substituted aromatic amines or the use of an extra aromatic ring on the aniline did not provide the desired complexes after mechanochemical treatment. Interestingly, the complexes were stable to air when stored at room temperature but were transformed back into the corresponding starting reactants when dissolved in a solvent.

Besides, cobalt complexes **384** were obtained by grinding diimines **383** with Co(II) sources using a Retsch MM400 mill at 30 Hz (Scheme 106).²³¹ The reaction conditions were first

Scheme 106. Mechanochemical Synthesis of Diimine–Cobalt Complexes

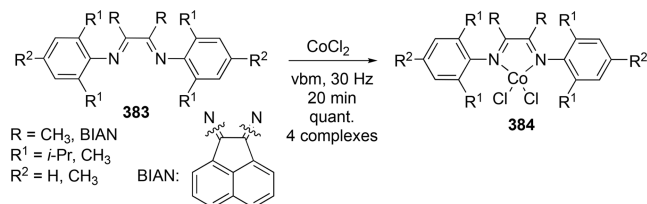

developed for the synthesis of Ni(II) complexes and then applied to the synthesis of four cobalt analogues. After only 20 min of grinding, the complexes were recovered in quantitative yields.

As for manganese(0) (Scheme 36), milling cobalt(0) powder with an *ortho*-quinone **151** and pyridine led to the formation of mononuclear cobalt complex $[\text{Co}(\text{SQ})_2(\text{Py})_2]$ **385** using solid-state metal oxidation and direct coordination of the *in situ* formed ligand to the metal (Scheme 107).¹²⁴

Cobalt complex **387** featuring a Schiff base ligand derived from 1-[(2-biphenylamino)methylen]naphthalen-2(1*H*)-one was synthesized in quantitative yield by grinding ligand precursor **386** with $[\text{Co}(\text{OAc})_2] \cdot 4\text{H}_2\text{O}$ and triethylamine followed by annealing at 160 °C (Scheme 108).²³² Grinding was operated at 25 Hz for 50 min in a 10 mL stainless steel jar using a vibratory ball-mill Retsch MM200. Only a partial reaction was obtained by neat grinding. The course of the reaction differed remarkably and advantageously when using a liquid assistant. While the use of acetonitrile and MeOH

Scheme 107. Use of Cobalt Powder for the Synthesis of the $[\text{Co}(\text{SQ})_2(\text{Py})_2]$ Complex

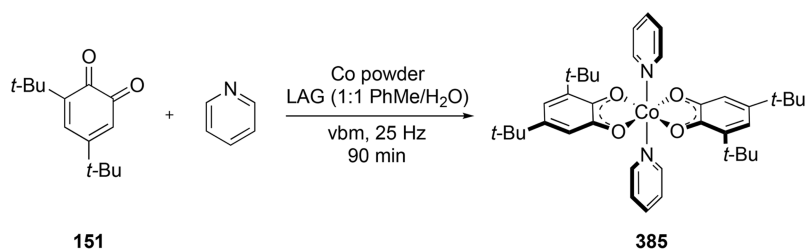

Scheme 108. Mechanochemical Synthesis of Schiff Base Cobalt Complexes

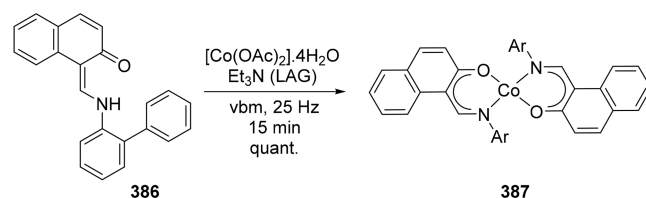

produced mixtures composed of solvates, trimethylamine led to the acetic solvate as the major product. Annealing at 160 °C enabled the removal of the acetic acid molecule to provide the expected cobalt complex. When synthesized in solution, complex **387** was isolated in only 62% yield.

Hernández and Bolm have developed the first mechanochemical synthesis of rhodium complexes.²³³ Indeed, $[\text{RhCl}_2\text{Cp}^*]_2$ complex **388** was synthesized by grinding $[\text{RhCl}_3] \cdot (\text{H}_2\text{O})_n$ and Cp^*H . Different ball mills (planetary or vibratory) and types of milling material (stainless steel, zirconium oxide, and tungsten carbide) were screened. The best results were obtained when using a planetary ball mill along with a tungsten carbide jar agitated at 800 rpm for 3 h, while MeOH was used as the liquid grinding assistant (Scheme 109).

Scheme 109. Mechanochemical Synthesis of $[\text{RhCl}_2\text{Cp}^*]_2$

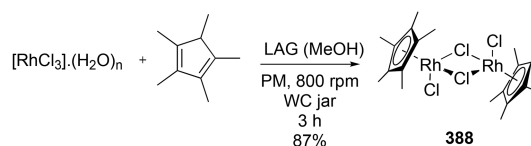

Complex **388** could also be synthesized in neat conditions or by using EtOH as an assistant but in lower yields. To confirm that the formation of the rhodium complex occurred during the milling process and not during the analysis or the workup procedure, a mixture of $[\text{RhCl}_3] \cdot (\text{H}_2\text{O})_n$, Cp^*H , and MeOH was stirred at room temperature in CDCl_3 . After 6 h of agitation, no dimer was detected, demonstrating the efficiency of the milling process. Rhodium complex **388** was then used as a catalyst for the mechanochemical halogenation of 2-phenylpyridine using NBS or NIS (*N*-bromosuccinimide and *N*-iodosuccinimide). Under these conditions, reactions occurred without heating and in short reaction times (3–8 h).

The same group developed the synthesis of Wilkinson's catalyst $[\text{RhCl}(\text{PPh}_3)_3]$ **389** in the ball mill in 2018 (Scheme 110).²³⁴ This approach was revealed to be highly interesting since ball milling under solvent-free conditions, or even with an alcoholic liquid grinding assistant, allowed the isolation of an elusive polymorphic orange form, which was only observed via

Scheme 110. Mechanochemical Isolation of the Orange Polymorph of Wilkinson's Catalyst

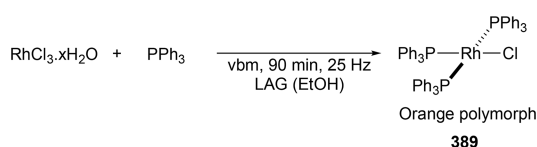

classical solution synthesis when reduced quantities of solvent were used. The complex polymorphism was confirmed by PXRD and ^{31}P solid-state NMR. The two polymorphs of Wilkinson's catalyst were evaluated in the dehydrocoupling of amine borane and further hydrogenation of olefins. In the aforementioned reaction, the efficiency was dependent on the polymorph used, indicating the importance of isolating both polymorphs.

9.2. Procedures Using Microwave Irradiation

As for chromium complexes (see section 6.2), the Jain and Mishra groups reported the microwave-assisted synthesis of numerous cobalt(II) complexes with Schiff bases as ligands between 2010 and 2016. Syntheses were performed in an open glass vessel using a modified open microwave (model 2001 ETB) equipped with a rotating tray. The microwave delivered an 800 W energy output, while the irradiation frequency was fixed at 2450 MHz. To control the temperature, microwave reactions were performed using on/off cycles. $[\text{Co}(\mathbf{84})_2] \cdot 2\text{H}_2\text{O}$,⁹⁷ $[\text{Co}(\mathbf{83})(\text{H}_2\text{O})]\text{Cl}$,⁹⁷ $[\text{Co}(\mathbf{88})(\text{H}_2\text{O})_2]$,⁹⁸ $[\text{Co}(\mathbf{81})_2(\text{H}_2\text{O})_2]$,⁹⁹ $[\text{Co}(\mathbf{82})_2(\text{H}_2\text{O})_2]$,⁹⁹ $[\text{Co}(\mathbf{85})_2(\text{H}_2\text{O})_2] \cdot \text{H}_2\text{O}$,¹⁰⁰ $[\text{Co}(\mathbf{86})_2(\text{H}_2\text{O})_2]$,¹⁰⁰ $[\text{Co}(\mathbf{78})_2(\text{H}_2\text{O})_2]$,⁹⁶ $[\text{Co}(\mathbf{80})_2(\text{H}_2\text{O})_2]$,⁹⁶ $[\text{Co}(\mathbf{76})_2(\text{H}_2\text{O})_2] \cdot \text{Cl}_2$,²³⁵ $[\text{Co}(\mathbf{77})_2\text{Cl}_2] \cdot 2\text{H}_2\text{O}$,²³⁵ $[\text{Co}(\mathbf{74})(\text{H}_2\text{O})_3]$,⁹⁵ and $[\text{Co}(\mathbf{75})\text{Cl}] \cdot 2\text{H}_2\text{O}$ ⁹⁵ were synthesized as follows. Ligand and $\text{CoCl}_2 \cdot 6\text{H}_2\text{O}$ were ground together in a stoichiometric ratio (1:1 or 2:1) before being transferred to a reactor with 3–5 mL of dry EtOH and heated under microwave irradiation for 6–8 min (Table 6, entries 1 to 13, see Figure 1 for ligand structures).

Table 6. Microwave versus Conventional Heating for the Synthesis of Co–Schiff Base Complexes^a

entry	cobalt complex	microwave synthesis		conventional heating		ref
		time	yield (%)	time (h)	yield (%)	
1	$[\text{Co}(\mathbf{84})_2] \cdot 2\text{H}_2\text{O}$	7 min	79	7	64	97
2	$[\text{Co}(\mathbf{83})(\text{H}_2\text{O})]\text{Cl}$	8 min	78	7	64	97
3	$[\text{Co}(\mathbf{88})(\text{H}_2\text{O})_2]$	8 min	84	8.5	64	98
4	$[\text{Co}(\mathbf{81})_2(\text{H}_2\text{O})_2]$	7 min	85	7	67	99
5	$[\text{Co}(\mathbf{82})_2(\text{H}_2\text{O})_2]$	8 min	82	7	68	99
6	$[\text{Co}(\mathbf{85})_2(\text{H}_2\text{O})_2] \cdot \text{H}_2\text{O}$	8 min	82	8	69	100
7	$[\text{Co}(\mathbf{86})_2(\text{H}_2\text{O})_2]$	8 min	81	8	66	100
8	$[\text{Co}(\mathbf{78})_2(\text{H}_2\text{O})_2]$	8 min	81	7	68	96
9	$[\text{Co}(\mathbf{80})_2(\text{H}_2\text{O})_2]$	8 min	82	6.5	62	96
10	$[\text{Co}(\mathbf{76})_2(\text{H}_2\text{O})_2] \cdot \text{Cl}_2$	7 min	82	7	68	235
11	$[\text{Co}(\mathbf{77})_2\text{Cl}_2] \cdot 2\text{H}_2\text{O}$	8 min	81	8	66	235
12	$[\text{Co}(\mathbf{74})(\text{H}_2\text{O})_3]$	7 min	81	7	68	95
13	$[\text{Co}(\mathbf{75})\text{Cl}] \cdot 2\text{H}_2\text{O}$	7 min	79	8	65	95
14	$[\text{Co}(\mathbf{87})]$	1 min	85	5	72	135
15	$[\text{Co}(\mathbf{79})_2]$	25 s	95	5	83	133
16	$[\text{Co}(\mathbf{71})] \cdot \text{H}_2\text{O}$	9 min	85	8	70	134

^aSee Figure 1 for the structure of ligands.

The corresponding products were recovered in high yields ranging from 78 to 85%. Microwave irradiation outperformed classical conditions, allowing for a reduction in time from hours to only a few minutes and an increase in yields from 64–69% to 78–85%.

The work of Jain and Mishra followed related work from the Meshram group. Indeed, Meshram et al. reported a similar microwave-assisted synthesis of $[\text{Co}(\mathbf{87})]$ ¹³⁵ and $[\text{Co}(\mathbf{79})_2]$ ¹³³ in 2009 (Table 6, entries 14 and 15). These complexes were obtained after microwave irradiation of an ethanolic $[\text{Co}(\text{OAc})_2] \cdot (\text{H}_2\text{O})_n$ solution and the corresponding ligand for less than a minute in a domestic oven, providing the products in excellent yields. A similar procedure was also described in 2014 for the synthesis of complex $[\text{Co}(\mathbf{71})] \cdot \text{H}_2\text{O}$ (Table 6, entry 16).¹³⁴ Only 9 min under microwave irradiation was necessary to obtain complete conversion (compared to 8 h in solution), producing the complex in 85% yield.

In 2016, a microwave-assisted synthesis of three macrocyclic Co(II) complexes **392** was described (Scheme 111).²³⁶

Scheme 111. Microwave Synthesis of the Macrocyclic Co(II) Complex 392

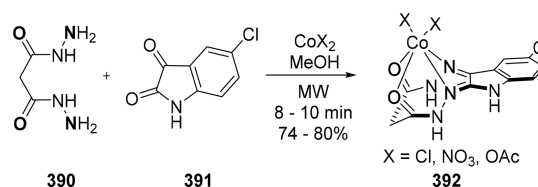

Malonic acid dihydrazide **390**, 5-chloroisatin **391**, and CoX_2 ($\text{X} = \text{Cl}, \text{NO}_3$ or OAc) were mixed in a grinder in a 1:1:1 ratio before being irradiated in a microwave synthesizer for 8–10 min. The corresponding products were obtained in yields between 74 and 80%, higher in comparison to conventional reflux conditions.

Similarly to Schiff base complexes, cobalt complex **394** featuring a luminol derivative ligand could be obtained in 83% yield via microwave heating (Scheme 112).²³⁷ Notably, ligand **393** and the metal source were finely mixed using a mortar and pestle before being placed under microwave irradiation in the absence of a solvent.

Scheme 112. Microwave Synthesis of a Cobalt Complex with Luminol Derivative

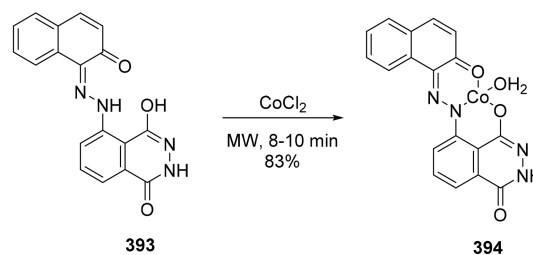

As for the synthesis of vanadium (see section 5.2) and chromium (see section 6.2) complexes, Alias et al. described the microwave synthesis of a mixed phenanthroline and 2-acetamide benzothiazole cobalt complex **395** in 2015 (Scheme 113).⁸³ The product was recovered in 95% yield after only 1 min of microwave heating.

Scheme 113. Microwave-Assisted Synthesis of a Mixed Ligand Cobalt Complex

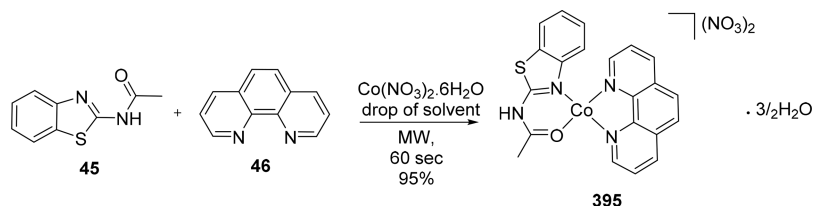

Scheme 114. Microwave-Assisted Cycloaddition for the Formation of Cobalt(III)–Tetrazolate Complexes

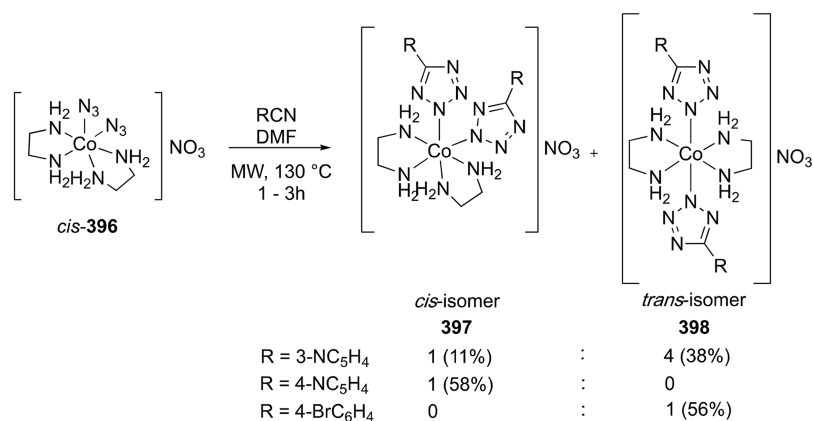

Microwave-assisted 1,3-dipolar cycloaddition reaction of *cis*-[Co(N₃)₂(en)₂](NO₃) **396** (en = 1,2-ethylenediamine) with different organonitriles (R-CN) produced the bistetrazolate [Co(N₄CR)₂(en)₂](NO₃) **397** and **398** in 1–3 h at 130 °C.²³⁸ Interestingly, changing the nitrile (R = 3-NC₅H₄, 4-NC₅H₄, and 4-BrC₆H₄) gave different ratios of isomers (Scheme 114). Starting from *trans*-[Co(N₃)₂(en)₂](NO₃) cycloaddition reaction with the same organonitriles using microwave irradiation unexpectedly produced a mixture of both isomers with the *cis*-isomer as the major product.

Taylor et al. described the microwave-assisted synthesis of planar chiral cobalt metallocenes (Scheme 115).²³⁹ Five-

only 10 min was necessary to complete the reaction, whereas 18 h was required under classical reflux conditions. Both isomers could be separated by column chromatography or by recrystallization and were characterized by X-ray diffraction.

Harcourt et al. developed a similar approach using microwave irradiation to synthesize cyclopentadienyl–cobalt sandwich complexes **405**–**406** by intermolecular cyclization of diarylacetylene (Scheme 116).²⁴⁰ In comparison with the

Scheme 115. Microwave-Assisted Synthesis of Planar Chiral Cobalt Metallocenes

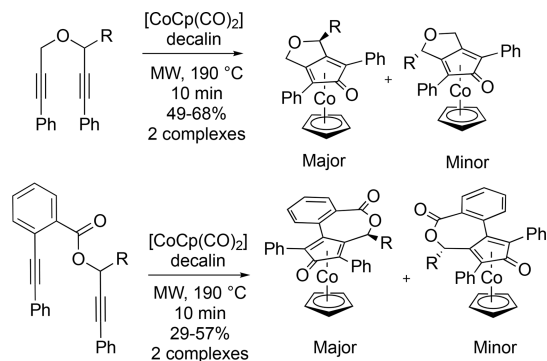

membered ring cyclopentadienone complexes **400** and **401** were obtained from ether-linked diynes **399**. Similarly, ester-linked diynes **402** produced 7-membered ring cyclopentadienone complexes **403** and **404**. Compounds **400** and **401** were isolated in similar yields, whether using classical reflux condition or microwave irradiation. Despite this, application of microwaves increased yields from 21–33% to 29–57% in the synthesis of **403** and **404** (Scheme 115). For all complexes,

Scheme 116. Microwave-Assisted Synthesis of Cobalt Sandwich Complexes

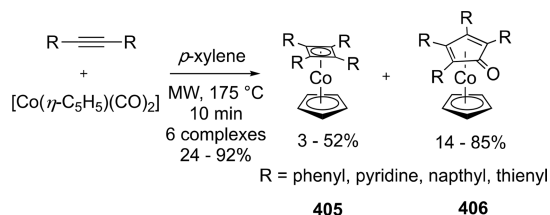

traditional thermal approach, the method reduced the reaction times and increased the yields. In the case of bulky diarylacetylene compounds, the microwave approach gave access to complexes, which could not be obtained under classical heating conditions. Interestingly, a first one-pot/two-step synthesis was developed to form cobalt complexes. The synthesis started with a Sonogashira coupling to generate the diphenylacetylene *in situ*, followed by the cyclization–metalation to obtain the desired product. The proof of concept was established with one example, yet with lower yield compared to the step-by-step synthesis.

The Aubert and Gandon group described an improved protocol for the synthesis of sandwich cobalt complexes **409** in 2012. In contrast with preceding studies, microwave-assisted synthesis proved to be highly chemoselective and yielded pure complexes in almost all cases.²⁴¹ The use of the nonclassical cobalt source **408** instead of [CoCp(CO)₂] or [CoCp-

$(C_2H_4)_2]$ was shown to inhibit the formation of other insertion products (cyclopentadienone or cyclohexadiene). The procedure was applied to the synthesis of numerous complexes starting from different alkynes: diarylacetylene (Scheme 117),

Scheme 117. Microwave Synthesis of [CoCpCb] Complexes

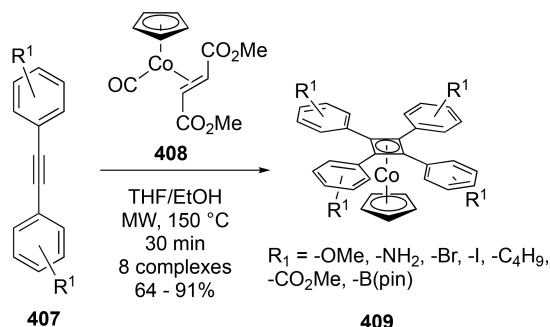

thienylalkynes, unsymmetrical diarylalkyne, but also diynes. No product was formed when diphenyl acetylene with ortho substituent was employed as a reactant. Due to the presence of functional groups on the diphenylacetylene, several modifications could be applied to the cobalt complexes, such as cross-coupling (when $R^1 = Br, I,$ or $B(pin)$) or saponification and reduction into alcohol (when $R^1 = CO_2Me$).

Microwave-assisted heating also proved beneficial for the synthesis of rhodium complexes. For instance, $[Rh_2(pfm)_4]$ complex **411** ($pfm =$ perfluorobutyramide, **410**) was initially prepared by heating a solution of perfluorobutyramide and rhodium acetate in chlorobenzene at reflux for 60 h using a Soxhlet extraction apparatus. To develop an easier and faster method, the same reaction was performed using a Biotage Initiator operated at 205 W (Scheme 118).²⁴² After 30 min of

Scheme 118. Microwave Preparation of Rhodium Perfluorobutyramide

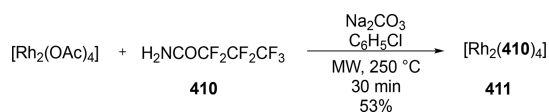

microwave-assisted heating at 250 °C, **411** was isolated in 53% yield. It was then used as catalyst in the trichloroethoxysulfonyl, nosyl, and tosyl aziridination of olefins (nosyl = 4-nitrobenzene-1-sulfonyl; tosyl = 4-methylbenzene-1-sulfonyl).

Classical syntheses of the $cis-[Rh(bipy)_2X_2]^+$ **412** ($X = Cl, Br, I$) complex gave reasonable yields (70–90%) but were limited by the tedious purification required to enable the photophysical study of these complexes. This is mainly due to the formation of $[Rh(bipy)X_4]$, $trans-[Rh(bipy)_2X_2]^+$, and $[Rh(bipy)_3]^{3+}$ as these byproducts can be difficult to remove, in particular the tris complex, which is highly light-emissive. To develop improved protocols to produce cis -**412**, the Megehee group reported syntheses via conventional and microwave heating (Scheme 119).²⁴³ If yields were comparable employing both techniques, microwave reactions required shorter reaction times (1.25–4 min compared to 20–65 min), yet the reaction temperature was more difficult to control, sometimes leading to the formation of the undesirable and insoluble Rh_2O_3 . The complexes were easily recovered by precipitation using KPF_6 . Notably, the authors highlighted the fact that a complete

Scheme 119. Microwave-Assisted Synthesis of $[Rh(bipy)_2X_2]^+$

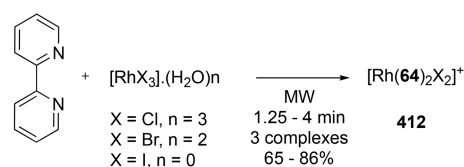

solubilization of the reactants before heating the reaction mixture was a key to obtain pure complexes.

Since the clinical success of platinum complexes for the development of novel antitumor agents, there has been an increasing demand for the development of metallodrugs for these applications. Due to the main disadvantages of these Pt-containing drugs (low efficacy against widespread tumors, intrinsic and acquired resistance of neoplasms, and severe side effects accompanying the therapy), different metallodrugs have been developed. In this context, a new microwave synthesis of antitumor pentamethylcyclopentadienyl rhodium complexes of maltol (**414**) and allomaltol (**415**) was developed. Both complexes were recovered in 71% yield and after only a few seconds of heating (Scheme 120).²⁴⁴ Contrastingly, 18 h at

Scheme 120. Microwave-Assisted Synthesis of Pentamethylcyclopentadienyl Rhodium Complexes Derived from Maltol and Allomaltol

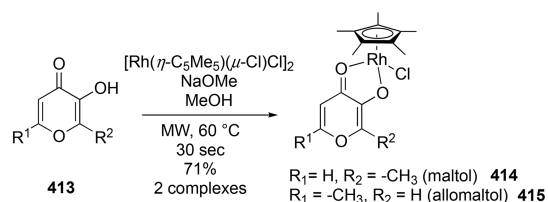

room temperature was necessary to synthesize **415** in 45% yield from allomaltol. Unfortunately, **414** and **415** were found to exhibit moderate to low cytotoxicity with IC_{50} (half maximal inhibitory concentration) values in the range of 100–300 μM .

As for rhenium (see section 7.2) and ruthenium (see Scheme 78) complexes, $[RhCl(COD)]_2$ was produced using a modified commercially available microwave oven.¹²⁵ $RhCl_3 \cdot xH_2O$ and cyclooctadiene in a EtOH/water (5:1) mixture were heated for 25 min to provide the complex in 87% yield. This reaction time could be reduced to only 1 min when the reaction was performed in an autoclave placed inside the microwave apparatus. Contrastingly, conventional refluxing conditions required 18 h of heating to produce the complex in good yield. Although the reaction time was considerably reduced using the microwave reflux procedure, the temperature was difficult to control. Two years later the same group published a slightly modified procedure to obtain $[RhCl(COD)]_2$ in 84% yield after 30 s at 140 °C under microwave irradiation.²⁰⁰

The very first report on microwave-assisted synthesis of organometallic complexes was published in 1989 by Baghurst and Mingos. This publication described the synthesis of diolefin–rhodium(I) complexes by microwave-assisted heating of a mixture composed of an olefin and $RhCl_3 \cdot xH_2O$ in an alcoholic solvent (MeOH or EtOH).²⁴⁵ One minute of heating was sufficient to provide the rhodium complexes in more than 62–91% yield. Interestingly, the use of freshly distilled

cyclopentadiene resulted in the sandwich cation $[\text{Rh}(\text{Cp})_2]^+$ instead of the chloro-bridged dimer $[\text{Rh}(\text{olefin})\text{Cl}]_2$ obtained in other cases (C_8H_{12} or norbornadiene). The procedure was also applied to one example of the diolefin–iridium complex. $[\text{Ir}(\text{C}_8\text{H}_{12})\text{Cl}]_2$ was recovered in 72% yield after 45 s of heating instead of several hours in classical refluxing conditions.²⁴⁵

As for $[\text{RuCl}_2(\text{cyclopentadienyl})]_2$ (see section 8.2, Scheme 78), the Severin group reported a microwave-assisted synthesis of $[\text{RhCl}_2(\text{cyclopentadienyl})]_2$ and $[\text{IrCl}_2(\text{cyclopentadienyl})]_2$ (cyclopentadienyl = tetramethylcyclopentadienyl and pentamethylcyclopentadienyl Cp*).²⁰⁵ Although conventional refluxing conditions required very long reaction times (21–48 h for $[\text{RhCl}_2\text{Cp}^*]_2$ and 36–48 h for $[\text{IrCl}_2\text{Cp}^*]_2$), heating a methanolic solution of $[\text{RhCl}_3]\cdot(\text{H}_2\text{O})_n$ or $[\text{IrCl}_3]\cdot(\text{H}_2\text{O})_n$ with pentamethylcyclopentadiene under microwave irradiation led to the formation of the corresponding dimeric complexes in only 3 min. Complexes were obtained in excellent yields (88% yield for the rhodium complex and 87% for the iridium complex). Tetramethylcyclopentadienyl complexes of rhodium and iridium have received less attention in the literature. Despite this, by applying the same procedure they could be obtained in good yields (79% and 67%, respectively).

As for ruthenium and osmium (see section 8.2) complexes, Schmidlehner et al. reported the synthesis of two different types of rhodium complexes by microwave irradiation in 2014 (Scheme 121).²⁰⁴ Heating a solution of $[\text{Rh}(\text{Cp}^*)\text{Cl}_2]_2$ and

Scheme 121. Microwave Synthesis of Azole–Metal Complexes

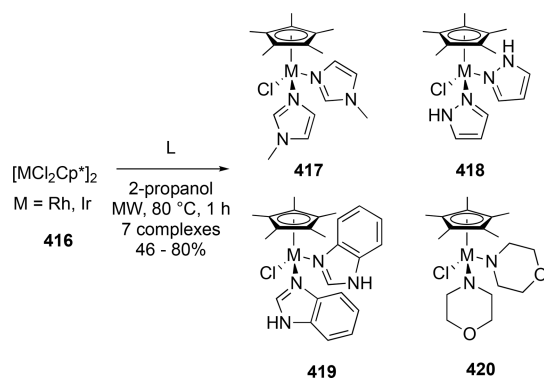

methylimidazole or pyrazole in 2-propanol at 80 °C provided the cationic $[\text{Rh}(\text{Cp}^*)(\text{azole})_2\text{Cl}]\text{Cl}$ complexes in only 1 min (417 and 418) in good yields (80% and 76%, respectively). Similarly, heating the same starting materials for the same time with benzimidazole or morpholine at 80 °C resulted in the neutral $[\text{Rh}(\text{Cp}^*)(\text{azole})\text{Cl}_2]$ complexes (419 and 420) in lower yields (52% and 70%). Subsequently, the same operating procedure was applied to synthesize three iridium complexes with methylimidazole, pyrazole, and morpholine. In 1–2 min, products were recovered in moderate yields (62%, 46%, and 46%, respectively).

In an interesting approach, rhodium and iridium complexes were prepared with iodide ion binding as models for an application in biomolecule labeling with ^{211}At as an iodide replacement.²⁴⁶ Microwave-assisted synthesis was investigated due to the rapid conversion of the metal source to the product (compared with classical conditions which takes 1–1.5 h),

which is necessary for a radiopharmaceutical study. Rhodium and iridium complexes (421 and 422) were synthesized in good yields (90% and 83%, respectively) after 35 min under microwave irradiation (Scheme 122).

Scheme 122. Microwave Synthesis of Potential Precursors for Astatine Radiopharmaceuticals

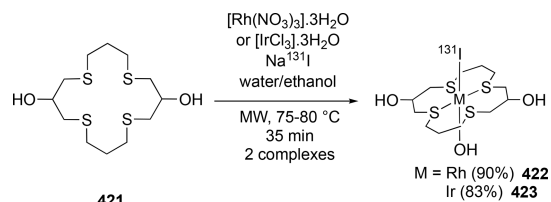

Furthermore, the $[\text{Ir}(\text{SC}(\text{NH}_2)_2)_2\text{Cl}_4][\text{Ir}(\text{SC}(\text{NH}_2)_2)_4\text{Cl}_2]$ complex was synthesized by reacting $\text{K}_3[\text{IrCl}_6]$ with thiocarbamide using a microwave oven at 800 W for 1 min.²⁴⁷ Although coordination compounds with thiourea or thiocarbamide are known in the literature, iridium complexes with thiocarbamide have not been adequately investigated. Under microwave irradiation, the iridium(III) chloride complex formed burgundy crystals. In contrast to using conventional heating, the synthesis led to a complex with the same composition but with a yellow color and a different crystallographic structure.

In 1990, Baghurst et al. reported the synthesis of two other iridium complexes via microwave irradiation.⁹¹ $[\text{IrCl}_3]\cdot(\text{H}_2\text{O})_n$ and PPh_3 were irradiated using a microwave oven (500–600 W) in DMF for 45 s to give $[\text{IrCl}(\text{CO})(\text{PPh}_3)_2]$ in 70% yield. The procedure was applied to classical reflux conditions and led to the formation of the same complex in 12 h, which was, however, contaminated with $[\text{IrCl}_3(\text{CO})(\text{PPh}_3)_2]$. To eliminate this oxidized byproduct, it was necessary to add zinc as a reducing agent to the reaction mixture. This addition was unnecessary when using microwave irradiation. In a similar method, $[\text{IrCl}_3(\text{9S3})]$ (9S3 = 1,4,7-trithiacyclononane) was synthesized by placing a solution of $[\text{IrCl}_3]\cdot(\text{H}_2\text{O})_n$ with 9S3 in MeOH under microwave irradiation (500–600 W) for 16 s. The desired product was isolated in 98% yield.

Syntheses of iridium polypyridine complexes have been described as being very long, implying laborious purifications while providing the complexes in very low yield. To improve the method, a microwave-assisted synthesis of photosensitive iridium(III) polypyridine complexes 424–425 was developed (Scheme 123, pathway A).²⁴⁸ Typically, iridium precursor and 2,2'-bipyridine ligand (in a 1:3 ratio) in ethylene glycol were

Scheme 123. Microwave-Assisted Synthesis of Iridium Polypyridine Complexes

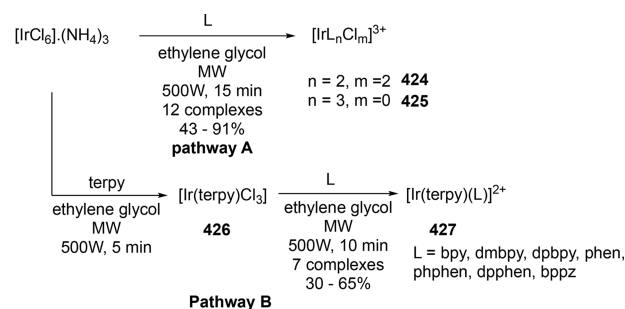

heated for 15 min at reflux using a microwave oven (RR-12AF, 500 W, Mitsubishi Denki Co. Ltd., 2450 MHz). A saturated solution of KPF_6 was added at the end to precipitate the desired product. Twelve iridium complexes with the general formula $[\text{Ir}(\text{L})_2\text{Cl}_2][\text{PF}_6]$ (**424**)²⁴⁹ or $[\text{Ir}(\text{L})_3][\text{PF}_6]_3$ (**426**)²⁵⁰ were recovered in 45–91% yield with different ligands (bipy, dmbpy = 4,4'-dimethyl-2,2'-bipyridine, dpbpy = 4,4'-diphenyl-2,2'-bipyridine **260**, phen, dpphen = 4,7-diphenyl-1,10-phenanthroline, and bqn = 2,2'-biquinoline). Complexes exhibited an intense luminescence around 505–630 nm with various colors in acetonitrile which corresponded to a triplet π - π^* emission. The same procedure was then applied to the synthesis of mixed-ligand Ir(III) complexes with both terpyridine and various bipyridine derivatives $[\text{Ir}(\text{terpy})(\text{L})\text{Cl}]^{2+}$ **427** (L = bpy, dmbpy, dpbpy, phen, pphen = 5-phenyl-1,10-phenanthroline, dpphen, bppz = 2,3-bis(2-pyridyl)pyrazine, and Cl_2) (Scheme 123, pathway B).²⁵¹ Complexes were prepared by a sequential procedure with a ligand replacement. An iridium source and terpyridine ligand (1:1 ratio) in ethylene glycol solution were refluxed in a microwave oven for 5 min. Subsequently, the bipyridine ligand was added, and the resulting mixture was refluxed for an additional 10 min. After addition of KPF_6 , the complexes were recovered by filtration with yields ranging from 30 to 65%. Similarly, mixed-ligand complexes $[\text{IrCl}(\text{L})(\text{tterpy})](\text{PF}_6)_2$ (L = phen, dpphen, dmbpy, bpy, and tterpy = 4'-(4-tolyl)-2,2':6',2''-terpyridine) were synthesized via microwave irradiation for 15 min and isolated in 18–63% yields.²⁵²

Microwave irradiation was also used to produce two facial tris-ortho-metalated iridium(III) complexes. Thus, *fac*- $[\text{Ir}(\text{ppy})_3]$ **429** and *fac*- $[\text{Ir}(\text{tpy})_3]$ **430** (tpyH = 2-(*p*-tolyl)pyridine) were synthesized by reaction between $[\text{IrCl}_3] \cdot (\text{H}_2\text{O})_3$ and a large excess of 2-arylpyridine **428** under microwave irradiation for 1–3 min (Scheme 124).²⁵³ Under

Scheme 124. Selective Microwave-Assisted Synthesis of *fac*-Tris-ortho-Metalated Iridium(III) Complexes

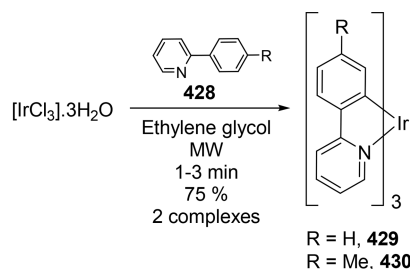

standard conditions, the reaction between iridium chloride and **428** at reflux formed the undesired dichloro-bridged dimer $[\text{Ir}_2\text{Cl}_2(\text{Rpy})_4]$ (R = 2-phenyl or 2-(*p*-tolyl)) as the major product. To avoid this, conditions were developed using a dehalogenating agent under reflux for several hours. Interestingly, microwave-assisted synthesis did not require the use of a dehalogenating agent, and products could be obtained quickly, efficiently, and selectively. Notably, the undesired complex could be obtained by decreasing the ligand excess while increasing the reaction time. The optimized procedure was applied to the synthesis of $[\text{Ir}(\text{phq})_3]$ (phq = 2-phenyl-1-quinoline), which was difficult to synthesize using the conventional method (after 10 h, only trace amounts of product were detected).²⁵⁴ Using microwave irradiation, only 20 min was required to obtain the complex in low yield (10%).

An electrophosphorescent device with $[\text{Ir}(\text{phq})_3]$ as a dopant in the emitting layer was developed making use of the highly efficient orange emission of this iridium complex.

9.3. Photochemical Synthesis of Iridium Complexes

Light irradiation of a solution of $[\text{IrCp}^*(\text{CO})_2]$ **431** in 2,2-dimethylpropane (neopentane) at room temperature for 5 h led to the formation of the new hydridoneopentyliridium complex **432**.²⁵⁵ Due to the high instability of the resulting iridium product, the yield was estimated by reacting the complex with CCl_4 until complete formation of the stable $[\text{IrClCp}^*(\text{CO})(\text{CH}_2\text{CMe}_3)]$ **433** (Scheme 125). Similarly,

Scheme 125. Photochemical Generation of an Iridium Complex

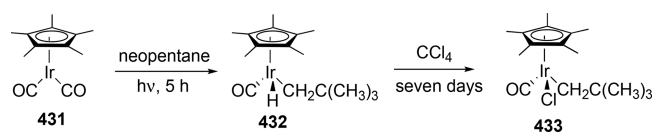

irradiation of **431** in cyclohexane, in cyclohexane-*d*₁₂, or in benzene produced cyclohexylhydrido derivatives $[\text{Ir}(\text{H})(\text{CO})(\text{L})]$ (L = C_6H_{11} , C_6D_{11} , or C_6H_5), which could easily be converted to the chloride derivatives $[\text{IrCl}(\text{CO})(\text{L})]$ using CCl_4 .

There are few examples of diiridium(II) complexes containing no bridging ligands across the Ir–Ir bond in the literature. In this context, Mak et al. described the synthesis of $[\text{Ir}(\text{Cp}^*)(\mu\text{-CO})(\text{C}_6\text{F}_4\text{CN})_2]$ complexes **437** under visible-light irradiation. A solution of $[\text{IrCp}^*(\text{CO})_2]$ **431** in $\text{C}_6\text{F}_5\text{CN}$ was irradiated with a tungsten lamp for 4 h leading to the formation of complexes **436** and **437** (Scheme 126, pathway A).²⁵⁶ The minor isomer **437** represented one of the few examples of such a species that did not contain a bridging ligand across the Ir–Ir bond. Notably, when placed under visible-light irradiation, the latter was transformed into the major isomer **436** which was obtained in 90% yield. Interestingly, in the presence of moisture, complex **435**

Scheme 126. Photochemistry Reaction of $[\text{IrCp}^*(\text{CO})_2]$ with $\text{C}_6\text{F}_5\text{CN}$

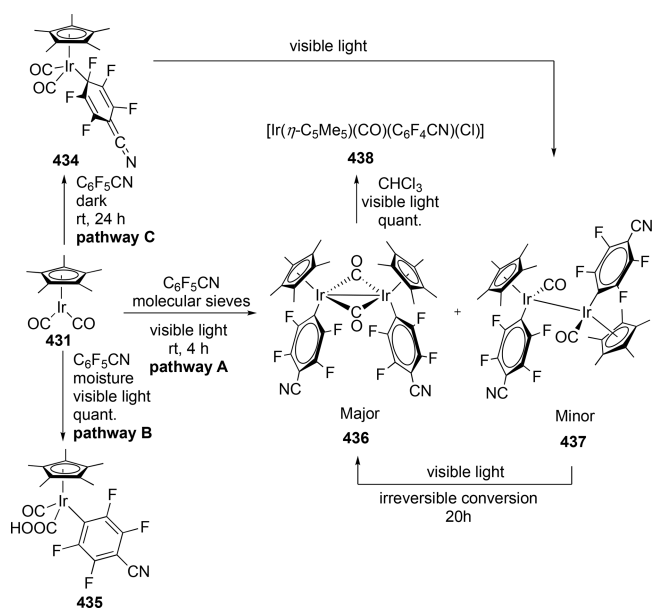

holding a formate ligand was obtained quantitatively (Scheme 126, pathway B). Under the same conditions, C₆F₆ reacted under a UV lamp; however, no reaction was observed under visible-light irradiation. Additionally, in the presence of water, no analogous reaction corresponding to pathway B was detected. Mechanistic investigations of reaction A were achieved by performing the reaction in the dark (Scheme 126, pathway C). These conditions resulted in 90% conversion to the iridium intermediate 434 after 24 h of stirring, which was then transformed into 437 under visible-light irradiation. Photochemically, [Ir(Cp*)(μ-CO)(C₆F₄CN)]₂ 436 could be quantitatively transformed into [Ir(Cp*)(CO)(C₆F₄CN)Cl] complex 438 with no observation of the [Ir(Cp*)(CO)(C₆F₄CN)(CHCl₂)] complex. The reaction failed in the absence of visible-light irradiation.

10. GROUP 10

Group 10 metal complexes are extensively studied for their catalytic properties as well as applications as bio-organometallic drugs. Palladium complexes are widely used in the laboratory or industrial scale; for example, in C–C coupling reactions, they exhibit high catalytic properties. The introduction of different types of ligands, for example, NHC (N-heterocyclic carbene), enabled the optimization of the performances of corresponding palladium complexes.²⁵⁷ Since the discovery of cisplatin as an anticancer agent, platinum complexes have also been considerably studied due to their therapeutic effect.^{6,7,142} Similarly, nickel complexes have also been investigated for their biological properties.⁶

10.1. Mechanochemical Approach

Cyclopalladated complexes have been significantly studied not only for their wide application in organic synthesis and catalysis but also for their mesogenic, bioactive, and photoluminescent properties. Solid-state reactions of dicyclopalladated azobenzenes 439 and triphenylphosphine led to the formation of the *cis*-isomer-bridged complexes 440 (Scheme 127).²⁵⁸ It was expected that DMF present in the substrate as

Scheme 127. Mechanochemical Synthesis of Azobenzene/Triphenylphosphine Palladacycles

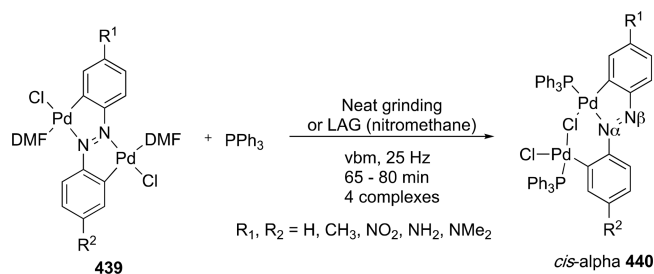

Scheme 128. Mechanochemical Synthesis of Cyclopalladated Complexes

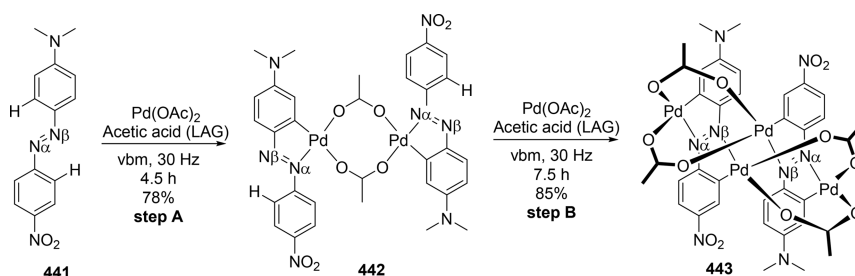

ligand could be simply displaced by the PPh₃, whereas azobenzene would act as a double chelating C,N-donor. Surprisingly, in the aforementioned case, a structural rearrangement led to the formation of a bridged dipalladium complex in which azobenzene acted as a monodentate C-donor and as a chelating C,N-donor. Notably, reactions could be performed under neat grinding, but addition of a small quantity of nitromethane shortened the reaction times.

To obtain similar cyclopalladated complexes, the Ćurić group reported the first mechanochemical transition-metal-mediated activation of a strong phenyl C–H bond in 2014 (Scheme 128).²⁵⁹ Reaction of azobenzene 441 with palladium acetate under mechanochemical grinding for 4.5 h led to the formation of the corresponding palladated complex 442 in 78% yield. Interestingly, *in situ* monitoring using solid-state Raman spectroscopy enabled both the characterization of reaction species and the direct optimization of the milling process. In this case, the first palladation, higher yielding, proved to be regioselective and much faster than the analogous reaction in solution (3 days, 39%) (Scheme 128, step A). Interestingly, a second C–H activation could be performed by addition of palladium acetate and grinding for 7.5 h, yielding tetrapalladated species 443 (85%, Scheme 128, step B). It is worth noting that the conventional solution procedures did not permit the formation of this complex to be observed.

Grinding the bistiocarbamate ligand 444 with [PdCl₂(NCPH)₂] for 2 min in a vibratory ball mill led to the synthesis of the Pd^{II}–pincer complex 445 in 95% yield, through a C–H bond activation (Scheme 129).²⁶⁰ Initially, the

Scheme 129. Mechanochemical Synthesis of Pd^{II}–Pincer Complex

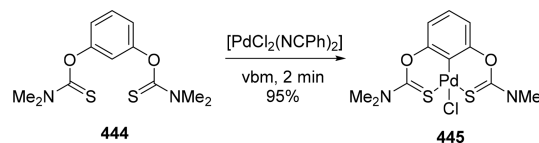

authors described the synthesis using a mortar and pestle, but a vibratory ball mill was required to perform the synthesis at the gram scale. Interestingly, formation of 445 could be observed by the formation of a paste resulting from benzonitrile release during the reaction.

In 2018, Kumar et al. described the synthesis of dimeric cyclobutenylpalladium chloride complexes 446–447 by mixing palladium(II) chloride and diphenylacetylene in a 1:2 ratio in the presence of an alcohol (Scheme 130).²⁶¹ The same conditions, using only a catalytic amount of PdCl₂, allowed the trimerization of diphenylacetylene into hexaphenylbenzene.

Scheme 130. Mechanochemical Synthesis of Dimeric Cyclobutenylpalladium Chloride Complexes

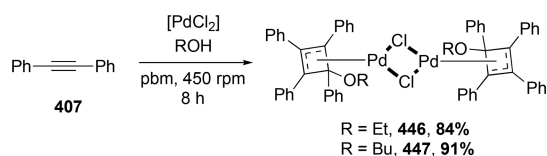

An original procedure for the synthesis of *N,N*-diaryl NHC–palladium complexes using a vibratory ball-mill Retsch MM200 was described in 2017.²⁶² Starting from NHC–silver complexes **449**, an allylpalladium(II) chloride dimer was added into a stainless steel jar and led to the formation of corresponding palladium complex **450** in 98% yield after 1.5 h of reaction (Scheme 131, reaction A). Starting directly from the imidazolium salt **448**, a one-pot, two-step synthesis could be performed in the ball mill, involving metalation of the imidazolium followed by the transmetalation of the silver complex intermediate. Using this procedure, complex **450** was recovered after 1.5 h in 92% yield (Scheme 131, reaction B). In the same year, Adams et al. demonstrated the direct mechanochemical synthesis of $[\text{Pd}(\text{NHC})_2\text{Cl}_2]$ **452** using a mortar and pestle (Scheme 131, reaction C).²⁶³ The two steps, intermediate formation of $[\text{NHC}]_2[\text{PdCl}_4]$ and further grinding with KOH to isolate **452**, were performed as a one-pot reaction.

In 2015, the Orpen group demonstrated that PEPPSI-type complexes (PEPPSI = pyridine-enhanced precatalyst preparation stabilization and initiation), which are well-known for their catalytic properties, could be mechanochemically synthesized following a two-step procedure.²⁶⁴ Using an agate mortar and pestle, grinding of an imidazolium chloride (**448**, **451**, and **453**), pyridinium chloride, and the metallic salt K_2MCl_4 ($\text{M} = \text{Pd}, \text{Pt}$) produced intermediate salt **454**, which upon grinding with KOH produced the desired PEPPSI complexes **455** in quantitative yield (Scheme 132). Syntheses involving platinum salts required more time than with palladium salts. The first step could be followed using PXRD, but attempts to crystallize the intermediate salt resulted in the spontaneous deprotonation of the pyridinium counterions to form $[\text{MCl}_3(\text{Py})]^-[\text{NHCH}]^+$. In comparison with a solvent-based strategy, PEPPSI complexes are formed by refluxing a mixture of PdCl_2 , K_2CO_3 , and the imidazolium salt in neat 3-

chloropyridine for 16 h, resulting in the products in excellent yields, but the excess of pyridine had to be distilled at the end of the procedure.

The fast coordination of imidazole (Him) **458** and pyrazole (Hpz) **459** on platinum and palladium in the solid state was described by the same group (Scheme 133).²⁶⁵ Various strategies were investigated for the synthesis of discrete complexes with the general formula $[\text{M}(\text{L})_2\text{Cl}_2]$ **456** ($\text{M} = \text{Pd}, \text{Pt}$; $\text{L} = \text{Him}, \text{Hpz}$), by grinding ligands with either K_2MCl_4 (Scheme 133, reaction A) or with MCl_2 or $\text{M}(\text{OAc})_2$ using a mortar and pestle (Scheme 133, reaction B). Using MCl_2 and $\text{M}(\text{OAc})_2$ has the main advantage that they produce the desired complex without salts. Conversely, when K_2MCl_4 was used (reactions A and E), KCl was formed as a byproduct but could be easily removed by washing the reaction mixture with water. *Cis*- $[\text{MCl}_2(\text{Him})_2]$ ($\text{M} = \text{Pd}, \text{Pt}$), *trans*- $[\text{PdCl}_2(\text{Hpz})_2]$, and *cis*- $[\text{PtCl}_2(\text{Hpz})_2]$ were the only isomers recovered after mechanochemical treatment. Interestingly, *cis*- $[\text{PdCl}_2(\text{Him})_2]$ could easily be transformed into the *trans*-isomer at high temperatures. Using a different strategy, salts with the general formula $[\text{HL}]_2[\text{MCl}_4]$ were synthesized using mechanochemistry with **458** and **459** as their hydrochloride salts (Scheme 133, reactions D and E). They were easily transformed into the desired discrete complexes when ground with a base (Scheme 133, reaction C). Ag_2O was preferred to KOH or K_2CO_3 because it avoided the formation of KCl and the subsequent formation of K_2MCl_4 . Notably, $[\text{PdCl}_2(\text{Him})_2]$ could not be synthesized by grinding $[\text{H}_2\text{Im}]_2[\text{PdCl}_4]$ with a base; the reaction produced only a mixture of the unprecedented $[\text{Pd}(\text{Him})_4]\text{Cl}_2$ complex and PdCl_2 . Similarly, $[\text{Pd}(\text{Hpz})_4]\text{Cl}_2$ was recovered after mechanochemical treatment of PdCl_2 with Hpz. In order to efficiently synthesize $[\text{Pd}(\text{Hpz})_2\text{Cl}_2]$, the palladium source was changed from PdCl_2 or K_2PdCl_4 to $\text{Pd}(\text{OAc})_2$. It is worth noting that the reaction of K_2PtCl_4 and imidazole did not occur in solution but only in a ball mill to yield $[\text{PtCl}_2(\text{Him})_2]$.

In 2018, the Frišćić group developed a straightforward mechanochemical procedure for the oxidation of elementary palladium into soluble $[\text{M}_2\text{PdX}_4]$ salts **460** ($\text{M} = \text{K}, \text{NH}_4$) (Scheme 134).²⁶⁶ Subsequently, these compounds could be milled with a variety of ligands (dppf, triphenylphosphine, tricyclohexylphosphine and tris(pentafluorophenyl)phosphine (ppfp_3), ACN, and acac) to form the corresponding coordination complexes **461** and **462**. Direct synthesis of

Scheme 131. Mechanochemical Synthesis of NHC–palladium Complexes

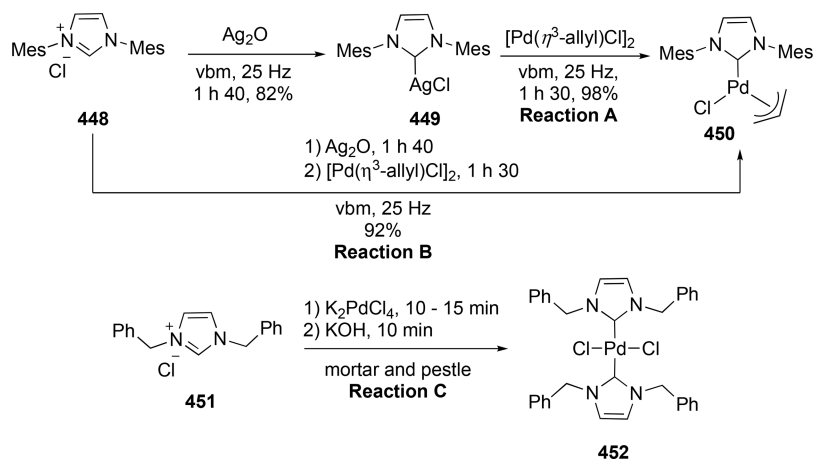

Scheme 132. Mechano-synthesis of PEPPSI-Type Complexes

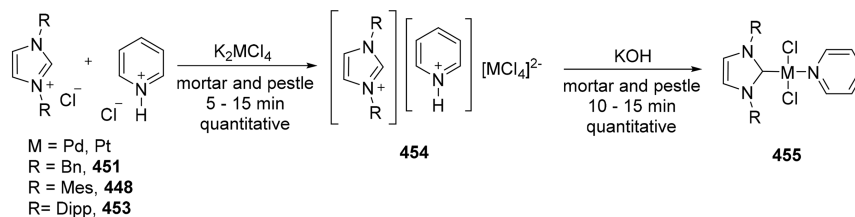

Scheme 133. Coordination of Platinum and Palladium with Pyrazole and Imidazole

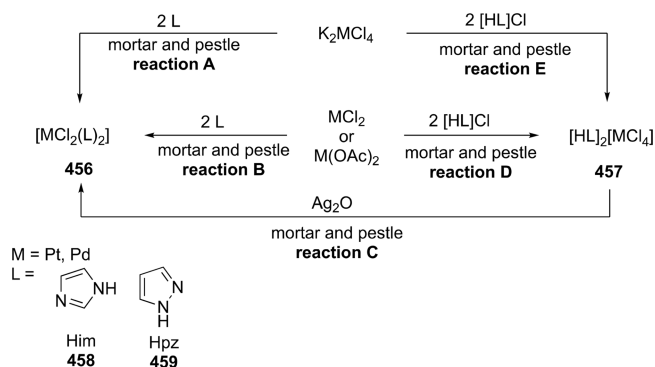

Scheme 134. Mechanochemical Oxidation of Pd Metal

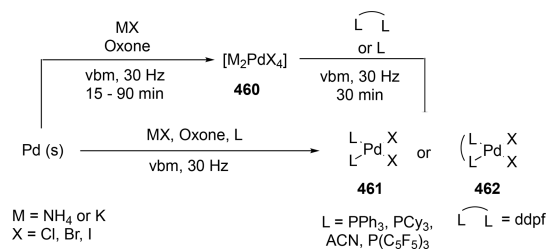

[PdL₂X₂] **461** was also described starting from palladium metal, the ligand, chloride salt, and the oxidant. Interestingly, this method avoids the use of aggressive acids, molten salts, or cyanides, which are usually used to perform the oxidation.

In 2002, Balema et al. described the first mechano-synthesis of platinum complexes.²⁶⁷ Following standard procedures, *cis*-bis(triphenylphosphine)platinum(II) dichloride **463** is formed by reacting PtCl₂ with PPh₃ under melting conditions (292 °C), however, with the concomitant formation of around 20% of the *trans*-isomer. Interestingly, ball milling (Spex-8000 mill) of PtCl₂ with 2 equiv of PPh₃ for 1 h at room temperature selectively produced *cis*-[Pt(PPh₃)₂]Cl₂ **463** (98% yield) without any side products (such as triphenylphosphine oxide or other phosphorus-containing species), as shown in solid-state ³¹P MAS (magic-angle spinning) NMR analysis (Scheme 135, step A). The corresponding carbonate adduct **464** could be synthesized by milling with K₂CO₃ (70% yield), while Ag₂CO₃ was the only metal carbonate effective for this transformation in solution. Despite this, around 20% of

Scheme 135. First Mechano-synthesis of Platinum Complexes

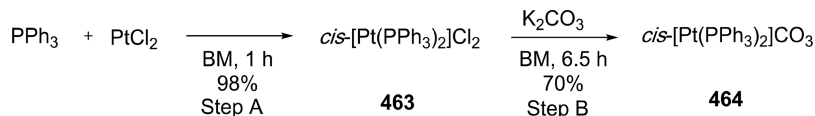

triphenylphosphine oxide was detected in the milling process (Scheme 135, step B). The direct preparation of **464** was attempted from PtCl₂, PPh₃, and K₂CO₃. The desired complex could be detected; however, consumption of intermediate **463** remained incomplete after 14 h.

In 2013, the mechano-synthesis of [Ni(OAc)₂(TMP)₂] **466** (TMP = trimethoprim; (5-(3,4,5-trimethoxybenzyl)-pyrimidine-2,4-diamine)) was described, with the purpose of developing a coordination complex derived from an active pharmaceutical ingredient (Scheme 136).²⁶⁸ Indeed, trimetho-

Scheme 136. Mechano-synthesis of [Ni(TMP)₂(OAc)₂]

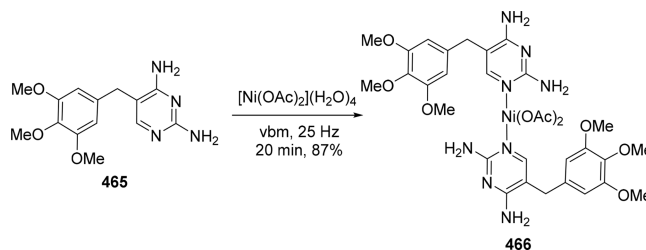

prim **465** is a bacteriostatic antibiotic used to treat urinary infections. TMP **465** and [Ni(OAc)₂]**4H₂O** were ground in equimolar amounts for 20 min in a vibratory ball mill operated at 25 Hz in a stainless steel jar, forming complex **466** in 87% yield. Mechano-synthesis was faster than solution-based conventional synthesis, which required 2 h in methanol at reflux and five more days at room temperature for recrystallization.

Nickel(II) coordination compounds with diimine ligands are generally known as Brookhart-type catalysts. Several procedures have been developed over time to synthesize this type of complex. Following a standard method, metalation is performed with [NiBr₂(DME)] (DME = 1,2-dimethoxyethane) in solution during 24 h. The Duarte group has developed an efficient mechanochemical alternative using vibratory ball milling (Retsch MM400) (Scheme 137).²³¹ Using [NiBr₂(DME)] as the metal source resulted in corresponding complex **467** in quantitative yield after only 20 min of milling. Interestingly, using anhydrous NiBr₂ instead of [NiBr₂(DME)], the same product was obtained in quantitative yield after 30 min of grinding. The use of anhydrous NiBr₂ in solution was already described using glacial acetic acid as solvent, but this approach was found less efficient (67% yield). Finally, preparation of [Ni(**η**-Ind)₂] (Ind =

Scheme 137. Mechanochemical Synthesis of Brookhart-Type Nickel Complexes

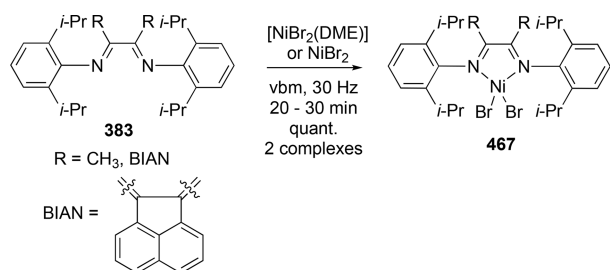

indene) was attempted, but the resulting red solid decomposed before any characterization could be performed, due to the supposed instability toward oxygen and moisture.

Thiosemicarbazone metal complexes have been extensively studied due to their interesting donor properties, their structural diversity, and their biological and catalytic properties. In 2012, three different techniques (ball mill, electrochemistry, and solution conditions) were used to form Ni(II) salicylaldehyde 4-methyl and 4-phenylthiosemicarbazonato complexes **469** and **470**.²⁶⁹ Three different geometries could be obtained for the final complexes, either tetrahedral, square planar, or octahedral. In solution, the 4-methyl-substituted complex was recovered with a tetrahedral structure, while the 4-phenyl was obtained with a square planar structure. Additionally, products were obtained in low yields (respectively, 41 and 85%) after 30 min of reaction. Electrochemical synthesis using a nickel anode in methanol for 1 day furnished the octahedral complex **469** with the 4-methyl derivative and the square planar one with the 4-phenyl counterpart, in 78 and 86% yield, respectively. When the reaction is performed using mechanochemistry, only the octahedral nickel complexes **469** and **470** were recovered quickly and quantitatively (Scheme 138). This study clearly demonstrates that the activation technique can affect the outcome of the reaction.

Scheme 138. Mechanochemical Synthesis of Ni(II) Salicylaldehyde Thiosemicarbazonato Complexes

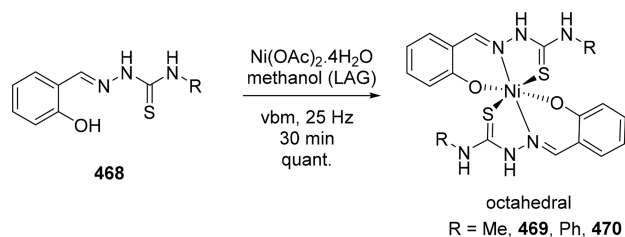

In 2014, the James group reported the mechanochemical synthesis of Salen–nickel complexes through the formation of a diimine and further reaction with nickel(II) acetate (Scheme 139).²⁷⁰ The final nickel complex **473** could be obtained in its pure form in 1 h, however, as a different polymorph than classically obtained. Subsequently, the same group developed the scale-up of this reaction using twin-screw extrusion.²⁷¹ The application of different activation techniques resulted in the isolation of a dimeric form of the expected complex (**474**).

As for ferrocene, nickelocene **475** could be synthesized by grinding NiCl₂ and TiCp in a 1:1.8 ratio for 60 min using an original homemade vibratory ball mill (90% yield, Scheme 140).¹⁴⁶ Similarly, grinding together NiCl₂·6H₂O with para-

toluidine in a 1:2 stoichiometric ratio for 15 min provided dichlorobis(paratoluidine) nickel(II) in 95% yield.²²⁸ Using an analogous strategy, and as reported for cobalt complexes, [NiCl₂(4-PhPy)₄] could be mechanochemically synthesized directly and easily from 4-PhPy and NiCl₂ and confirmed by PXRD analysis.²²⁶

10.2. Microwave Irradiation

Between 2010 and 2016, the Jain group reported the microwave-assisted synthesis of numerous nickel(II) complexes with Schiff bases as ligands (Table 7, see Figure 1 for the structures of ligands). Syntheses were performed in an open-glass vessel using a modified microwave open model 2001 ETB with a rotating tray. Microwave reactions were performed using on/off cycles to control the temperature. [Ni(**84**)₂]·2H₂O,⁹⁷ [Ni(**83**)(H₂O)₃]Cl,⁹⁷ [Ni(**88**)·2H₂O],⁹⁸ [Ni(**81**)₂(H₂O)₂],⁹⁹ [Ni(**82**)₂(H₂O)₂],⁹⁹ [Ni(**85**)·3H₂O],¹⁰⁰ [Ni(**86**)₂·2H₂O],¹⁰⁰ [Ni(**74**)(H₂O)₃],⁹⁵ [Ni(**75**)Cl]·3H₂O,⁹⁵ [Ni(**76**)₂Cl₂]·2H₂O,²³⁵ [Ni(**77**)₂Cl₂]·2H₂O,²³⁵ [Ni(**78**)₂]·2H₂O,⁹⁶ [Ni(**80**)₂(H₂O)₂],⁹⁶ [Ni(**69**)₂(H₂O)₂]Cl₂,²⁷² and [Ni(**70**)₂]²⁷² (Table 7, entries 2–16) were synthesized using a similar procedure. Before performing microwave irradiation, the appropriate ligand and NiCl₂·6H₂O were ground in a stoichiometric ratio (1:1 or 2:1). After 6–8 min of irradiation in 3–5 mL of dry EtOH, complexes were obtained in high yields (81–86%). Microwave activation outperformed classical conditions, reducing reaction times from hours to only a few minutes and increasing the yields from 60–70% to more than 80%.

In the same way, the microwave-assisted synthesis of [Ni(**71**)·H₂O] was described in 2014. In only 5 min, the complex was produced in 85% yield (Table 7, entry 18).¹³⁴ The [Ni(**79**)₂] complex could be obtained from the addition of nickel(II) acetate tetrahydrate to **79** in EtOH under irradiation at 600 W for 20 s (Table 7, entry 17).¹³³

The synthesis of macrocyclic Ni(II) complex [Ni(**89**)] under microwave irradiation was reported by Ali et al. (Table 7, entry 19).²³⁶ The reaction time was considerably reduced from hours to minutes, and the yield was increased (74–80%) in comparison with the 55% yield obtained under reflux. Similarly, [Ni(**87**)] synthesis was described in 2009 by an identical procedure using H₂L as ligand. The complex was recovered in 1 min and in 88% yield (Table 7, entry 1).¹³⁵ Recently, in 2017, microwave syntheses of [Ni(**103**)₂], [Ni(**104**)Cl], [Ni(**105**)Cl], and [Ni(**106**)₂] were performed in a few minutes using DMF as the solvent (Table 7, entries 20–23).²⁷³

Alias et al. described the microwave synthesis of mixed phenanthroline and benzothiazole nickel complex **476** (Scheme 141), following the same procedure used for the synthesis of vanadium complex **47** (Scheme 11). After 20 s of microwave irradiation with a few drops of solvent, the desired Ni complex was obtained in 97% yield and was isostructural to the corresponding vanadium complex.⁸³

The same methodology as for a ruthenium complex (Scheme 80) could be applied for [Ni₂(**9-atc**)₄(H₂O)(Py)₄]·2H₂O, synthesized by heating a solution of NiCO₃·2Ni(OH)₂, 9-anthracenecarboxylic acid, and pyridine in an EtOH/water mixture via microwave irradiation.¹⁷⁴ A two-step program was used consisting of a 20 min heating ramp up to 150 °C followed by a 2 h isotherm at 150 °C. After removal of the volatiles, the corresponding complex [Ni₂(**9-atc**)₄(H₂O)(Py)₄]·2H₂O was recovered in 56% yield.

Scheme 139. Nickel–Salen Complexes Obtained through Ball Milling and Twin-Screw Extrusion

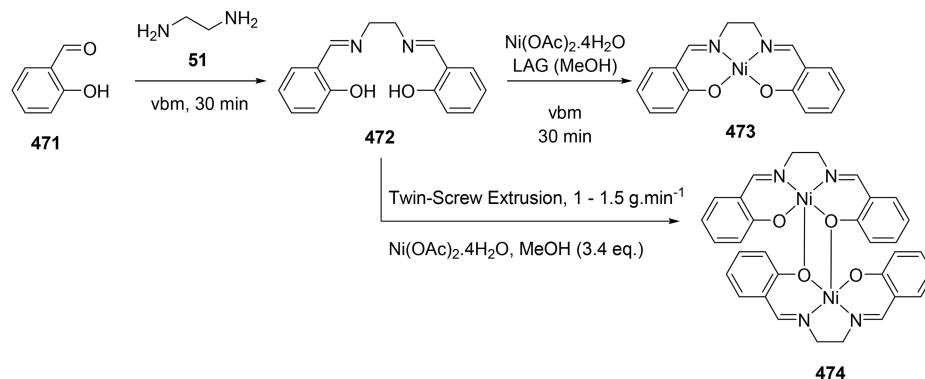

Scheme 140. Mechanochemistry of Nickelocene

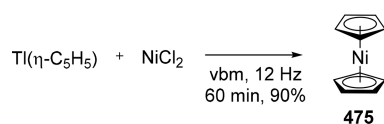

In the [Group 9](#) section, luminol derivative **393** was used to coordinate cobalt ([Scheme 112](#)). Similarly, nickel(II) complex **477** could be prepared in less than 10 min and in 84% yield starting from NiCl₂ ([Scheme 142](#)). Once again, the coordination of luminol derivative **393** on nickel induced a shortening of the fluorescence lifetime.²³⁷

The Zeise's salt [KPtCl₃(C₂H₄)] was the first organo-metallic compound isolated in essentially pure form. The first syntheses of this complex required prolonged reaction times (7–14 days) and the use of high pressures. Since then, catalytic

processes have been developed with tin chloride to yield the complex in only a few hours at atmospheric pressure but have led to difficulties in product isolation. To solve these issues, Shoemaker et al. described the microwave-assisted synthesis of [KPtCl₃(C₂H₄)] starting from a solution of K₂PtCl₄ and ethene (50 psi) in a mixture of water:EtOH:HCl.²⁷⁴ After only 15 min, the product could be recovered in 89% yield after a simple filtration/evaporation workup.

Similarly, the microwave-assisted synthesis of cisplatin, the first FDA-approved Pt(II) drug for which anticancer activity is known worldwide, has also been described.²⁷⁵ Thus, *cis*-[Pt(NH₃)₂Cl₂] was synthesized in more than 80–90% yield whereby an aqueous solution of K₂PtCl₄, KCl, and NH₄OAc in a 1:2:4 ratio was heated at 100 °C under microwave irradiation for 15 min ([Scheme 143](#)). Notably, a simple recrystallization was sufficient to recover the pure complex. The entire procedure lasted 80 min, thus opening the door to the

Table 7. Synthesis of Ni(II)–Schiff Base Complexes by Microwave Irradiation versus Conventional Heating^a

entry	nickel complex	microwave synthesis		conventional heating		ref
		time (min)	yield (%)	time	yield (%)	
1	[Ni(87)]	1	88	5	79	135
2	[Ni(84) ₂]·2H ₂ O	7	80	7	67	97
3	[Ni(83)(H ₂ O) ₃]Cl	7	81	7	68	97
4	[Ni(88)]·2H ₂ O	8	80	7	68	98
5	[Ni(81) ₂ (H ₂ O) ₂]	7	83	6	65	99
6	[Ni(82) ₂ (H ₂ O) ₂]	8	80	7	63	99
7	[Ni(85)]·3H ₂ O	7	81	7	69	100
8	[Ni(86) ₂]·2H ₂ O	7	84	8	71	100
9	[Ni(74)(H ₂ O) ₃]	8	84	8	66	95
10	[Ni(75)Cl]·3H ₂ O	7	84	7	66	95
11	[Ni(76) ₂ Cl ₂]·2H ₂ O	7	84	7	69	235
12	[Ni(77) ₂ Cl ₂]·2H ₂ O	7	84	8	69	235
13	[Ni(78) ₂]·2H ₂ O	8	83	7	70	96
14	[Ni(80) ₂ (H ₂ O) ₂]	7	85	7	69	96
15	[Ni(69) ₂ (H ₂ O) ₂]Cl ₂	9	80	8	67	272
16	[Ni(70) ₂]	8	84	7	71	272
17	[Ni(79) ₂]	20 s	90	5	76	133
18	[Ni(71)]·H ₂ O	5	85	8	61	134
19	[Ni(89)]	8–10	74–80	hours	55	236
20	[Ni(103) ₂]	2	74	4.5	62	273
21	[Ni(104)Cl]	1.5	77	2	62	273
22	[Ni(105)Cl]	2.5	68	3	54	273
23	[Ni(106) ₂]	2.1	73	3.5	65	273

^aSee [Figure 1](#) for the structure of ligands.

Scheme 141. Microwave Synthesis of a Benzothiazole/Phenanthroline Mixed Nickel Complex

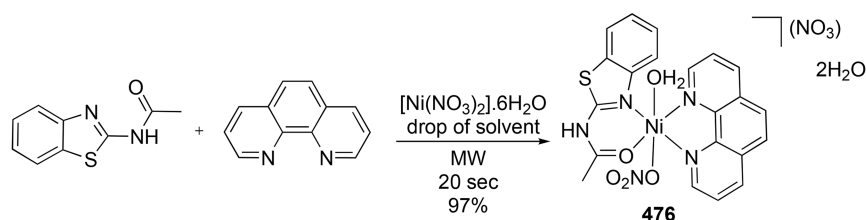

Scheme 142. Microwave Synthesis of a Ni–Luminol Complex

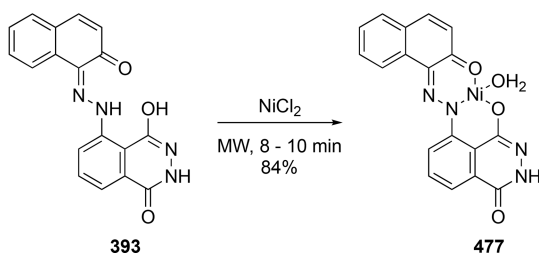

Scheme 143. Expedient Microwave-Assisted Formation of Cisplatin

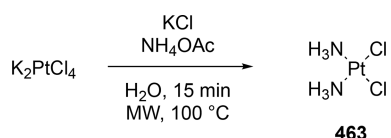

synthesis of the $^{195\text{m}}\text{Pt}$ corresponding complex and the related biological studies. This result is a drastic improvement compared to classical solution conditions, which required 2–3 h from the beginning of the reaction to isolation of the complex. The conditions were optimized to avoid the formation of the *trans*-isomer and the Magnus green salt ($[\text{Pt}(\text{NH}_3)_3\text{Cl}][\text{Pt}(\text{NH}_3)\text{Cl}_3]$). Interestingly, higher temperatures led to the formation of the *trans*-isomer, and higher concentrations of NH_4OAc salt led to the formation of the Magnus salt.

Carlsson and Eliasson described the one-pot microwave synthesis of mono- or diarylalkynyl platinum complexes **478** and **480** with phosphine or phosphite ligands. Reaction of PtCl_2 with acetylide **479** and phosphorus ligand resulted in the monosubstituted complexes, whereas addition of CuI allowed the formation of the disubstituted complexes (Scheme 144).²⁷⁶ The microwave-assisted reaction was fast, and complexes were obtained in good yields. It is worth noting that this synthesis did not require prior preparation of the intermediate $[\text{PtCl}_2(\text{PR}_3)_2]$ complex, which was formed *in situ* during the microwave procedure.

In 2003, Januário-Charmier et al. described the [2 + 3] cycloaddition of nitronone **481** with different platinum sources containing EtCN ligands, the anionic platinum(II) $[\text{PPh}_3(\text{CH}_2\text{Ph})][\text{PtCl}_3(\text{EtCN})]$ **482** (Scheme 145, reaction A), the neutral platinum(II) $[\text{PtCl}_2(\text{EtCN})_2]$ **483** (Scheme 145, reaction B), or the neutral platinum(IV) $[\text{PtCl}_4(\text{EtCN})_2]$ **484** (Scheme 145, reaction C).²⁷⁷ Compared to in solution, the reactions were accelerated by microwave irradiation and led to the formation of fused bicyclic oxadiazoline ligands when starting from cyclic nitrones. Longer reaction times were necessary when using acyclic compound **485** (Scheme 145, reaction D). Interestingly, reacting nitronone and EtCN under platinum-free conditions did not yield the corresponding cyclic adduct. Similarly, the cycloaddition was described with *cis*- and *trans*- $[\text{PtCl}_2(\text{PhCN})_2]$ and led to the selective formation of *cis*- or *trans*- $[\text{PtCl}_2(\text{oxadiazoline})(\text{PhCN})]$, respectively, using different acyclic nitrones (**485**).²⁷⁸ Notably, the resulting complexes featuring the oxadiazoline ligand could be used for further reactions thanks to the lability of benzonitrile. Interestingly, subsequent reaction with a second equivalent of nitronone resulted in symmetrical or unsymmetrical *trans*- $[\text{PtCl}_2(\text{oxadiazoline}^1)(\text{oxadiazoline}^2)]$. In contrast, the reaction with the *cis*-isomer failed. A one-pot, microwave-assisted reaction was used in the direct synthesis of *trans*- $[\text{PtCl}_2(\text{oxadiazoline})_2]$ in only 1 h starting from a solution of acyclic nitrones and *trans*- $[\text{PtCl}_2(\text{RCH}_2\text{CN})_2]$ (R = CO_2Me , Cl) in DCM.²⁷⁹

A similar strategy in which the platinum activates the electrophilicity of the nitrile ligand was used starting from ketoximes **487** instead of nitrones. Microwave irradiation of the reaction mixture led to the addition of the oxime onto the nitrile to synthesize iminoacyl–platinum complexes **489** and **490** (Scheme 146).²⁸⁰ Compared to classical solution conditions, reactions were accelerated by microwave irradiation, leading to higher isolated yields without decreasing the selectivity. Both *trans* and *cis* isomers were formed during the process, but they could be separated by column chromatography. Selective formation of the *trans* isomer was possible when a stronger electron-withdrawing group such as a methyl ester was used. Contrastingly, the chloride derivative resulted in a mixture of *cis* and *trans* isomers.

Scheme 144. Microwave Preparation of Mono- and Dialkynyl Phosphino Platinum Complexes

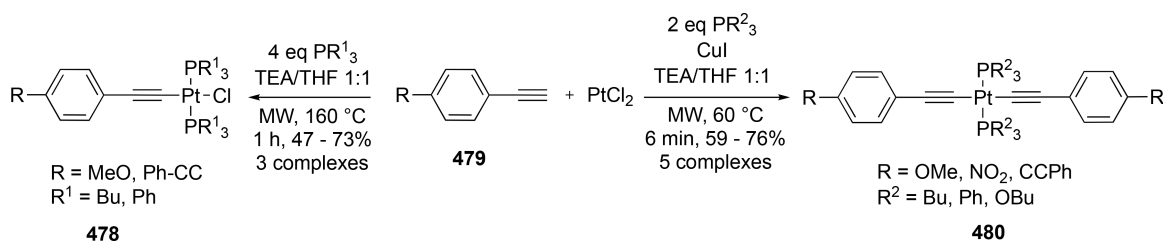

R = MeO, Ph-CC
R¹ = Bu, Ph

478

R = OMe, NO₂, CCPh
R² = Bu, Ph, OBU

480

Scheme 145. Microwave-Assisted [2 + 3] Cycloaddition of Nitron to Platinum-Bound Organonitriles

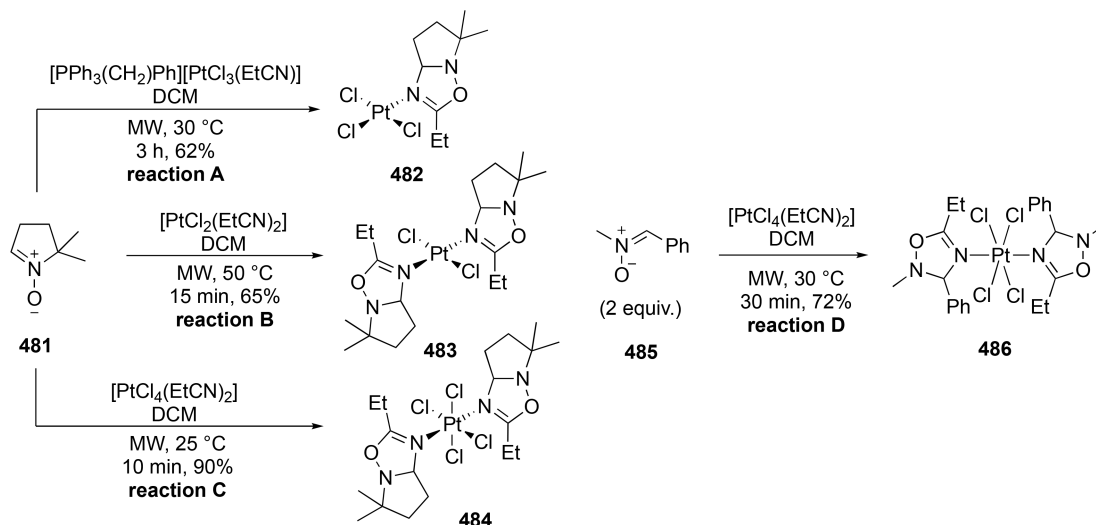

Scheme 146. Reaction of Ketoxime with Nitrile–Platinum Complexes under Microwave Irradiation

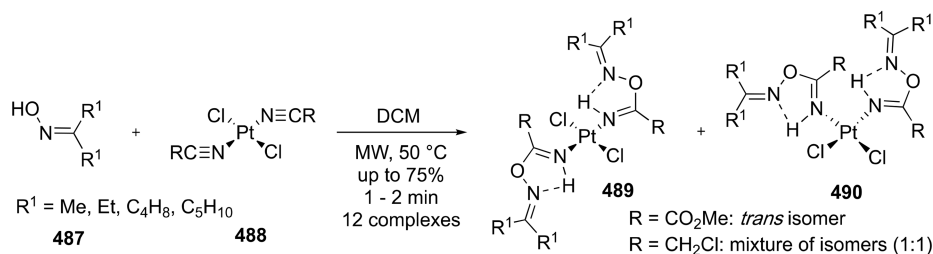

Similar cycloaddition was described for the formation of a tetrazole-containing platinum complex starting from 4-fluorobenzonitrile **491** and a diazido-bis(triphenylphosphine) platinum complex (Scheme 147).²⁸¹ The reaction conditions

Scheme 147. Microwave Synthesis of Tetrazolato–Platinum Complexes

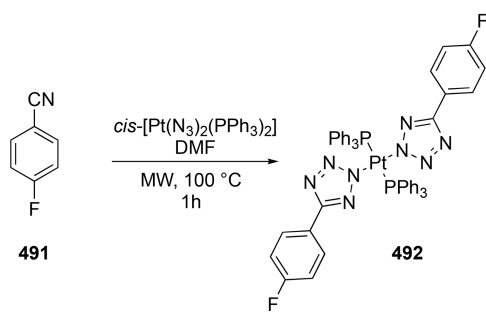

(MW, 100 °C, 1 h) were then applied to the synthesis of *trans*-[Pt(N₄CR)₂(PPh₃)₂] complexes **492** starting from various nitriles (RCN; R = Me, Et, Pr, Ph, and C₆H₄Cl).²⁸² Interestingly, the reaction of *cis*-[Pt(N₃)₂(PPh₃)₂] with propionitrile in solution produced the unexpected *trans*-[Pt(CN)(5-ethyltetrazolato)(PPh₃)₂] complex resulting from an unusual NC–C bond cleavage. This side product was completely undetected when the reaction was performed under microwave irradiation. Similarly, microwave irradiation of *cis*-[Pt(N₃)₂(2,2-bipy)] with nitriles led to the synthesis of *cis*-[Pt(N₄CR)₂(2,2'-bipy)] complexes.

An interesting example of microwave-assisted reaction involved [2 + 3] cycloaddition of azido–platinum complexes **493**, featuring 1,3,5-triaza-7-phosphaadamantane (PTA) ligands, with organonitriles. This reaction yielded the corresponding tetrazolato complexes, which could liberate tetrazoles and the water-soluble *cis*-[Pt(Cl)₂(PTA-H)₂]Cl₂ complex **495** in diluted HCl media (Scheme 148).²⁸³

Different pyridine and bipyridine complexes **496**–**497** were synthesized by microwave irradiation starting from a solution of platinum salt K₂PtCl₄ in an EtOH/water mixture (Scheme 149).²⁸⁴ Syntheses with 2-methylpyridine ligands failed probably due to the increased steric hindrance. A similar failure was observed upon microwave irradiation, with the 4,4'-bis(2-morpholinoethoxy)-2,2'-bipyridine ligand. The desired complex could only be obtained by heating the reaction mixture at reflux for 24 h starting from [PtCl₂(COD)]. K₂PtCl₄ was also used for the synthesis of [PtCl(terpy)]Cl·3H₂O **498** (terpy = 2,2',2''-terpyridine). Under classical reflux conditions, **498** was synthesized in 24–100 h, whereas only 60 s was required under microwave irradiation, giving the desired complex in 47% yield.⁹¹

Usually, cyclometalations of [MX₃(2,4'-bipy-Me)] **499** (M = Pd, Pt) give the corresponding [MX₂(2,4'-bipy-Me)] complexes (**500**) and require long reaction times to reach completion. In 1994, however, Castan et al. demonstrated that these reactions took only a few minutes under microwave irradiation (Scheme 150).²⁸⁵ Interestingly, palladium complexes were much more reactive than their platinum analogues, whereas chloride compounds were more reactive than their respective bromides. The reactions were also performed in the solid state by heating the sample at 140–200 °C; however,

Scheme 148. Microwave Synthesis of Water-Soluble Platinum Complexes

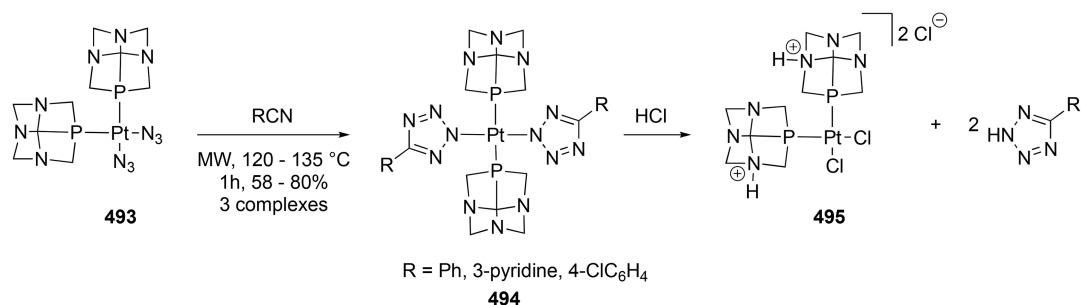

Scheme 149. Microwave-Assisted Synthesis of Pyridine-Platinum Complexes

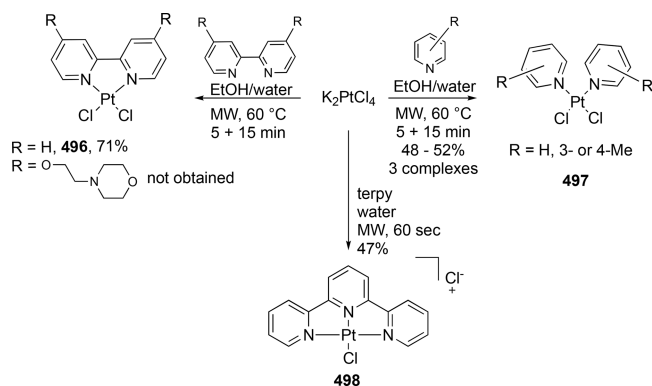

Scheme 150. Cyclometallation of [MX₃(2,4'-bipy-Me)]

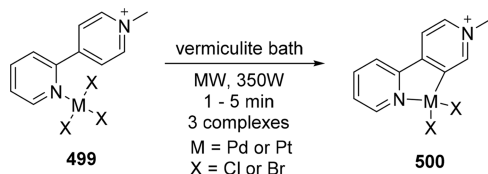

reactions using microwave irradiation were comparatively much faster (1 h instead of a few minutes).

Similarly, cyclometallated chloridoplatinum complexes **501**–**504** containing benzo[*h*]quinolone, 4-methoxypyridine, 2-phenylpyridine, and 2-(2'-thienyl)pyridine could be synthesized under microwave irradiation in only 1–6 min (Figure 8).²⁸⁶ Complexes were recovered in similar or lower yield

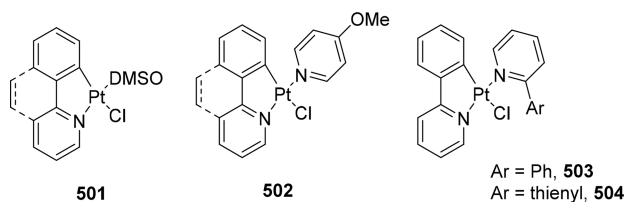

Figure 8. Cyclometallated chloridoplatinum complexes prepared by microwave irradiation.

compared to using conventional heating. This could be explained by the rapid decomposition of the platinum salt to black Pt⁰, which was observed during synthesis at high temperatures.

The reaction of metal chlorides MCl₂ (M = Pd, Pt) with Schiff base ligand **505** has been shown to form [M(**505**)₂Cl₂]

or, in the presence of NH₄OH, [ML₂] **506**. Both types of complexes could be formed under classical reflux conditions in a few hours. When syntheses were performed under microwave irradiation, reaction times were reduced to 5–7 min (Scheme 151).²⁸⁷ Both complexes and ligands were screened for their

Scheme 151. Microwave Synthesis of Schiff Base Palladium and Platinum Complexes

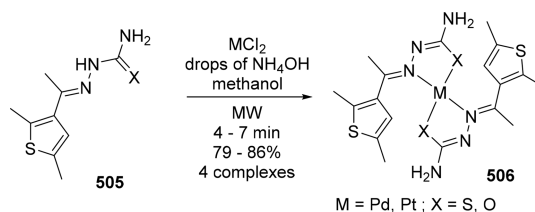

antimicrobial properties. Interestingly, the complexes showed better antimicrobial and antiamoebic activities than the ligand itself and also inhibited the growth of fungi and bacteria (*Entamoeba histolytica*).

Palladium complexes bearing NHC ligands could also benefit from microwave-assisted synthesis.²⁸⁸ Thus, PEPSI-type complexes [PdCl₂(NHC)(3-chloropyridine)] **507** (Scheme 152, reaction A) and [PdCl(NHC)(*acac*)] **508**

Scheme 152. Microwave-Assisted Synthesis of NHC-Palladium Complexes

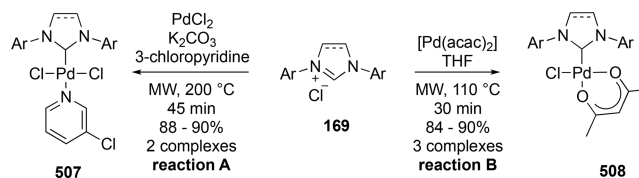

(Scheme 152, reaction B) were synthesized with a significant reduction in the reaction time compared to classical solution conditions (20–88 times faster). This protocol was then applied to the synthesis of [PdCl(IPr)(*acac*)] complexes (IPr = 1,2-bis(2,6-diisopropylphenyl)imidazol-2-ylidene) on a 5 mmol scale (2.76 g). The complexes were obtained in only 30 min.

A new catalyst for different cross-coupling reactions was synthesized under microwave irradiation by Tu et al.²⁸⁹ Interestingly, the complex was prepared from cheap and commercially available precursors, namely, imidazolium salt **509** and palladium acetate, in DMSO under irradiation at 160 °C for 25 min (Scheme 153). Despite this, complex **510** was recovered in moderate yield. Catalytic properties of the

Scheme 153. Microwave Synthesis of a Pyridine-Bridged Bisbenzimidazolylidene CNC Pincer Palladium Complex

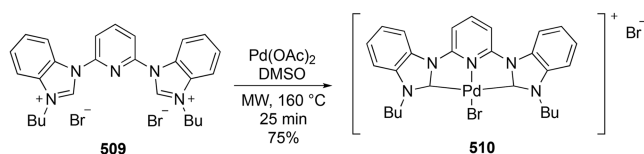

pyridine-bridged bisbenzimidazolylidene CNC pincer palladium complex **510** were demonstrated in Mizoroki–Heck and Suzuki–Miyaura cross-couplings at catalyst loadings as low as 0.1–1 ppm. Notably, the catalyst was thermally stable under air and moisture.

Similarly, an original prolinol-based chiral NCN pincer palladium complex **512** was quickly and efficiently synthesized under microwave irradiation, via an insertion of Pd⁰ into a C–Br bond (Scheme 154).²⁹⁰ Under standard conditions,

Scheme 154. Microwave Synthesis of a NCN Pincer Palladium Complex

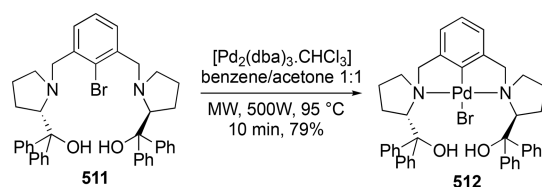

complex **512** was obtained in 44% yield after 16 h of thermal heating at 60 °C. The resulting bromide derivative could be transformed by metathesis reaction to the corresponding BF₄ and PF₆ products. Both complexes were evaluated in an aldol condensation reaction between methyl isocyanoacetate and aromatic aldehyde, efficiently yielding *cis*-oxazolines with good regio- and stereoselectivity.

Microwave irradiation was also used to synthesize different porphyrin metal complexes (**517**). Complexes of Ni, Pd, and Pt were recovered easily within a few minutes and in yields higher than 70%, if not quantitative (Scheme 155).²⁹¹ Using

Scheme 155. Microwave-Assisted Synthesis of Metalloporphyrins

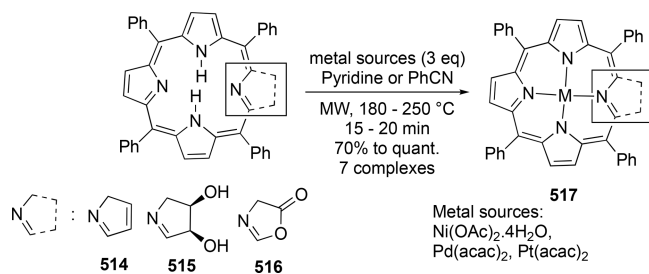

the diol-containing porphyrin ligand **515**, various nickel and palladium byproducts arising from the diol oxidation were recovered. Despite this, the corresponding nickel complex was recovered in 70% yield after workup. Unfortunately, in the case of palladium, only 50% conversion could be obtained. Notably, syntheses were also performed with platinum sources, but corresponding complexes were difficult to form. However, when reaction temperatures were increased to 250 °C and benzonitrile was used instead of pyridine as the solvent, the

desired complexes were isolated in quantitative yields. Classical solution methods were much slower than the microwave-assisted method (reaction times up to days). Nevertheless, classical solvent-based conditions led to a more selective complex synthesis featuring the diol derivative with less nickel and palladium byproducts, thus demonstrating that the byproduct formation was accelerated under microwave irradiation.

10.3. Ultrasounds for the Synthesis of a Nickel Complex

There is one publication reporting the use of ultrasound for the synthesis of group 10 organometallic complexes. In this study, nickel acetate and KbpzB **518** (potassium bispyrazolyl borate) were reacted under ultrasound for 1 h, leading to the formation of nanostructures of [Ni(bpzB)₂]₂ **519** in 66% yield (Scheme 156).²⁹² The nanostructure was characterized by SEM

Scheme 156. Ultrasound Synthesis of Nanostructured [Ni(bpzB)₂]₂

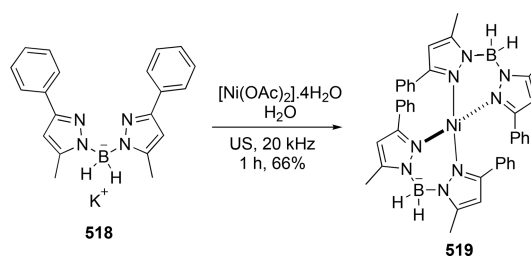

(scanning electron microscopy), PXRD, IR, and elemental analysis. Interestingly, without the use of ultrasound, **519** was no longer recovered as nanostructures but as single crystals. Analyses revealed that individual molecules interacted with each other by directional intramolecular interactions, creating 3D supramolecular frameworks.

10.4. Continuous Flow Synthesis of Nickel Complexes

To date, only one example of continuous flow chemistry applied to the synthesis of complexes involving a group 10 metal has been reported. New square-planar nickel(II)–salphen complexes **521** were synthesized by Rakers et al. in 2018 using a continuous flow approach (Scheme 157).²⁹³

Scheme 157. Continuous Flow Synthesis of Nickel Complexes

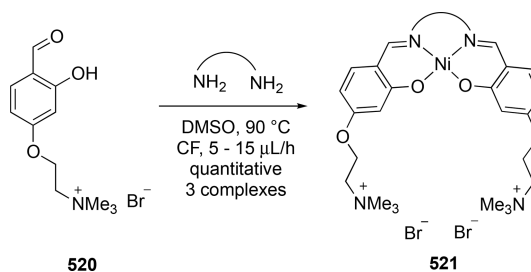

Complexes were obtained in two steps, synthesis of the ligand through condensation of a diamine (ethylene diamine, *o*-phenylene diamine, or 2,3-diaminonaphthalene) and the aldehyde **520** followed by coordination of the metal. A one-pot methodology ultimately facilitated the isolation of the same complexes in quantitative yields, and no purification was required. Interestingly, two of these complexes have been

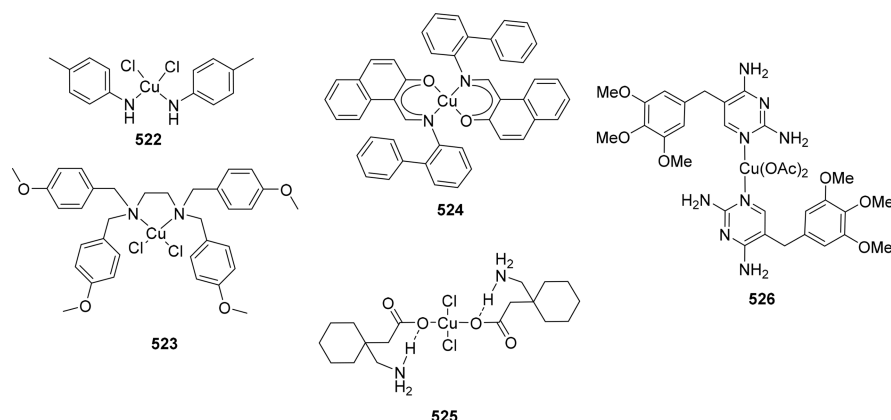

Figure 9. Copper complexes with N-coordinated ligands.

found to be very good G-quadruplex DNA binders and displayed high selectivity for duplex DNA.

11. GROUP 11

Copper, silver, and gold complexes play an important role in organic as well as organometallic chemistry.²⁹⁴ Also known as coinage metals, their utility in catalysis is well documented, although there is still room for development of new reactivities. Their corresponding organometallic complex can also possess therapeutic properties, such as antifungal or antibacterial activities. Numerous groups are working on their syntheses using nonconventional methods.

11.1. Mechanochemistry and Coinage Metals

In 2011, Sun and co-workers described the first dimerization of a copper metal complex ($[\text{Cu}(\text{NH}_3)_3(\text{L})] \cdot (\text{H}_2\text{O})_{0.66}$, $\text{H}_2\text{L} = 2,2'-(1,2\text{-phenylenebis(methylene)})\text{bis(sulfanediyl)dibenzoic acid}$) by mechanical activation.²⁹⁵ The synthesis was carried out in a steel vessel in a vibratory ball mill operated at 20 Hz for 30 min. Dimerization was also performed under classical thermal activation for 15 min in an oven at 176 °C. The color of the complex changed from green to blue as the transformation involved a change in the coordination geometry of the copper ion. This color change indicated that the transformation may have potential application in sensing devices.

In 2009, the Bowmaker group grinded copper(I) thiocyanate and ethylenethiourea (etu) in stoichiometric quantities to form $[\text{Cu}(\text{SCN})(\text{etu})_2]$ after accelerated aging at 70 °C for 2 h.²⁹⁶ The reaction could be monitored *ex situ* by IR thanks to the $\nu(\text{CN})$ variations in the thiocyanate ligand. The addition of a few drops of water as a grinding assistant was necessary to obtain a complete reaction. In only 2 h, the desired $[\text{Cu}(\text{SCN})(\text{etu})_2]$ complex could be quantitatively isolated. Notably, when performed in solution, a poor conversion to a mixture of $[\text{Cu}(\text{SCN})(\text{etu})_2]/[\text{Cu}(\text{SCN})(\text{etu})]$ was obtained, thus demonstrating that mechanochemistry was more efficient and selective than solution conditions. The 1:1 adduct $[\text{Cu}(\text{SCN})(\text{etu})]$ was prepared following the same method. Both reagents were mixed in a mortar and pestle and in stoichiometric amounts in the presence of water and heated at 70 °C overnight. Water was crucial for the reaction and likely helps diffusion and therefore the reagents to react. Interestingly, the formation of $[\text{Cu}(\text{SCN})(\text{etu})]$, starting from a 1:1 mixture of CuSCN/etu , undergoes rapid formation of

$[\text{Cu}(\text{SCN})(\text{etu})_2]$, which slowly reacts further with remaining CuSCN .

The same group also described the mechanochemistry of $[\text{Cu}(\text{SCN})(\text{PCy}_3)_x]$ ($x = 1, 2$), $[\text{Cu}(\text{SCN})(\text{PCy}_3)(\text{py})]$, and $[\text{Cu}(\text{SCN})(\text{P}(o\text{-tol})_3)(\text{ACN})]$.²⁹⁷ The complexes were obtained by grinding reagents (bulky tertiary phosphine, pyridine, and CuSCN) in a mortar and pestle with acetonitrile as liquid additive. Under classical solution conditions care was taken to exclude air moisture, due to the possible oxidation of the phosphine, and syntheses were usually performed in a glovebox. Mechanochemical treatments enabled this problem to be entirely circumvented. The reaction was complete after only a few minutes, whereas several hours was necessary in solution. Obtained yields were excellent (>95%) and better than those in solution (<80%).

In a similar manner, grinding copper halides ($\text{CuCl}_2 \cdot 2\text{H}_2\text{O}$, CuI , and CuBr_2), pyridine, and iodine in a mortar and pestle in air provided $[\text{CuX}_2(\text{Py})_4] \cdot 2\text{Py}$ ($X = \text{I}, \text{I}_3, \text{IBr}, \text{I}(\text{NCS})$) and $[\text{H}_2\text{O}(\text{Py})_4\text{CuClCu}(\text{Py})_4](\text{I}_3)_3 \cdot \text{H}_2\text{O}$ complexes.²⁹⁸ Pyridine was used as a reagent but also as a liquid additive. Pure copper(II)–iodo complexes were also prepared from copper(I) iodide in the presence of pyridine and iodine. This method was applied to prepare mixed iodo/(pseudo)halo analogues and perform a five-component redox synthesis in excellent yields (>90%).

In 2008, the same authors used mechanochemistry to perform a ligand dissociation reaction.²⁹⁹ Ground in an agate mortar and pestle, $[\text{Cu}(\text{SCN})(\text{PPh}_3)(\text{Py})_2]$ with acetonitrile led to the formation of $[\text{Cu}(\text{SCN})(\text{PPh}_3)(\text{Py})]$ with loss of one pyridine within a few minutes. Interestingly, no reaction was observed without milling. In solution, while heating at 120 °C, the reaction led to a mixture of the expected product and $\text{Cu}(\text{SCN})$ as side product. This example clearly shows that the application of grinding enables isolation of products otherwise inaccessible under standard solution conditions.

It is also possible to mechanochemically synthesize dichlorobis(*p*-toluidine) copper(II) **522** by grinding $\text{CuCl}_2 \cdot 2\text{H}_2\text{O}$ (1 equiv) and *p*-toluidine (2 equiv) for five minutes. The analytically pure product was obtained in 96% yield (Figure 9).²⁹⁹ Using a similar strategy with a bidentate ligand, a mechanochemical formation of $[(\text{CuCl}_2)(\text{N,N,N',N'}\text{-tetra-}p\text{-methoxybenzyl-ethylenediamine})] \cdot 2(\text{H}_2\text{O})$ **523** was described in 2014.³⁰⁰ The bidentate ligand was first protonated by HCl and then ground with $\text{CuCl}_2 \cdot \text{H}_2\text{O}$ for 1 min in a mortar and pestle to produce $[\text{H}_2\text{L}]^{2+}[\text{CuCl}_4]^{2-}$ in quantitative yield. Subsequently, the reaction mixture was ground with KOH in a 1:2 ratio to

Scheme 158. Mechanochemistry of a Copper–Salen Complex

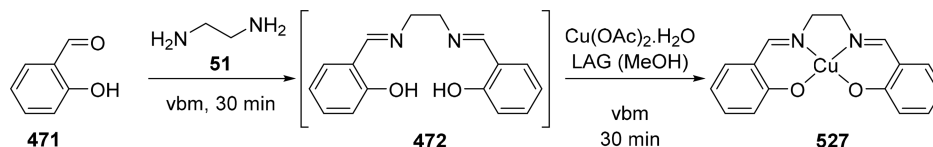

carry out the dehydrochlorination and obtain **523**. Neat grinding was unsuccessful, but addition of a few drops of methanol led to complete conversion after only a few minutes of milling. Similarly, copper(II) complex **524** featuring 1-[(2-biphenylamino)methylene]naphthalene-2(1*H*)-one ligands was synthesized by grinding the organic ligand (2 equiv) with $\text{Cu}(\text{OAc})_2 \cdot \text{H}_2\text{O}$ (1 equiv) and triethylamine as a liquid additive.²³² Grinding was performed in a 10 mL stainless steel jar using a vibratory ball-mill Retsch MM200 operated at 25 Hz. The copper complex was obtained after only 50 min in quantitative yield. Under reflux conditions (MeOH/ACN 1:1, 2 h) the desired product was obtained in 80% yield.

In 2008, the Braga group described the mechanochemistry of $[\text{CuCl}_2(\text{gabapentin})_2]$ **525** by manual grinding of solid amorphous gabapentin and $\text{CuCl}_2 \cdot 2\text{H}_2\text{O}$ in an agate mortar and pestle.³⁰¹ The desired complex was obtained in quantitative yield after only 5 min of grinding. The amino acid gabapentin is a neuroleptic drug, and the use of coordination complexes of an active pharmaceutical ingredient may open up new drug delivery routes. Following this concept, milling of $\text{Cu}(\text{OAc})_2 \cdot \text{H}_2\text{O}$ and trimethoprim for 20 min in a stoichiometric quantity provided $[\text{Cu}(\text{OAc})_2(\text{TMP})_2]$ **526** in 80% yield.²⁶⁸ The reaction time was drastically reduced since 2 h was necessary under reflux.

Salen-type copper complex **527** could be obtained readily from the appropriate aldehyde and diamine using ball milling (Scheme 158).²⁷⁰ Intermediate formation of the ligand **472** required 30 min of milling, and copper acetate was added directly into the milling jar, with methanol as a grinding assistant, to quantitatively afford the desired copper–salen complex. Contrary to observations with nickel (Scheme 139), the final complex was analytically identical to that prepared using classical solution techniques.

In 2014, the Kato group described the mechanochemistry of three different luminescent copper iodide complexes, $[\text{CuI}(\text{PPh}_3)_2(\text{L})]$ **528** (L = isoquinoline, 1,6-naphthyridine, and pyridine) (Scheme 159).³⁰² These complexes were formed by grinding copper(I) iodide, triphenylphosphine, and various N-heteroaromatic ligands **529** in an agate mortar and pestle for a few minutes. The products were obtained in yields between 63 and 85% without any impurities. Notably, the reactions were

Scheme 159. Mechanochemistry of Luminescent Copper Complexes

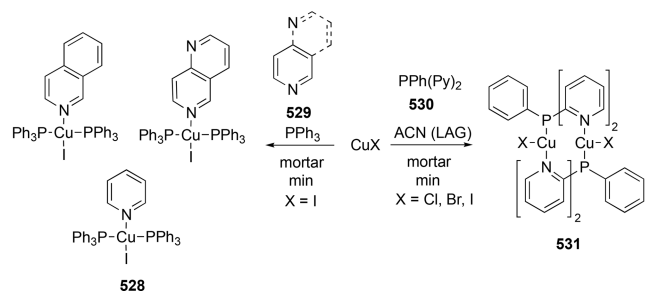

not complete within less than 3 equiv of the N-heteroaromatic ligand. In 2016, the same authors also described the mechanochemistry of highly luminescent Cu(I) dinuclear complexes $[\text{Cu}_2\text{X}_2(\text{dpypp})_2]$ **531** (X = Cl, Br, I, dpypp = 2,2'-(phenylphosphinediyl)dipyridine **530**), using a mortar and pestle with yields between 63% and 80%.³⁰³ $[\text{Cu}_2\text{I}_2(\text{dpypp})_2]$ could also be obtained with addition of a liquid assistant, starting from $[\text{Cu}_2(\text{ACN})_2(\text{dpypp})_2](\text{BF}_4)_2$ and KI in equimolar quantities for 3 min (60% yield). Among the different solvents tested as an assistant, acetonitrile and benzonitrile were the best choices mainly due to the high solubility of copper in both solvents.

In 2017, the Lamaty group reported the synthesis of *N,N*-diaryl NHC copper complexes **532** by transmetalation in a ball mill (Scheme 160).²⁶² Starting from the corresponding NHC

Scheme 160. Synthesis of NHC Copper Complexes by Transmetalation or Direct Metalation

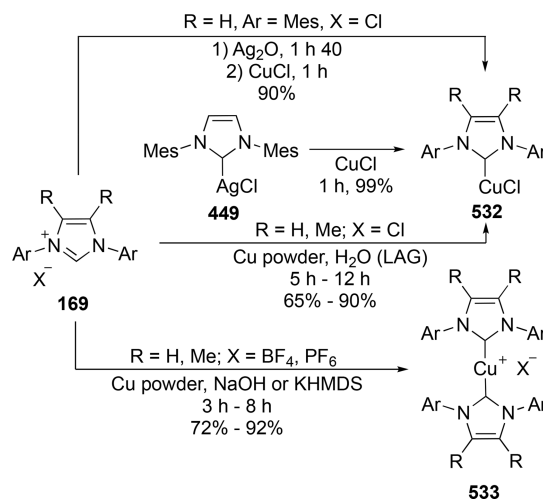

silver species **449**, **532** was obtained in 99% yield using vibratory ball-mill Retsch MM200 at 25 Hz in only 1 h. A one-pot, two-step synthesis, involving metalation of imidazolium salt **169** with Ag_2O and transmetalation with CuCl , allowed the isolation of the corresponding $[\text{CuCl}(\text{NHC})]$ complex in 90% yield after 160 min of milling. *N,N*-Diaryl NHC copper complexes could also be obtained by direct metalation of various imidazolium salts $\text{NHC} \cdot \text{HX}$ (X = Cl, BF_4 and PF_6) using copper powder in a planetary ball-mill Retsch PM100 at 450 rpm (Scheme 160).³⁰⁴ Due to highly efficient mixing, the reaction was performed between gas (dioxygen from air), solid (copper(0) and imidazolium salt), and liquid (water) in a very short time and gave corresponding copper(I) complexes **532** and **533** in yields of up to 97%. Importantly, the quantity of O_2 could be reduced to nearly stoichiometric amounts, while keeping the same efficiency. Additionally, mechanochemistry outperformed classical syntheses under reflux in terms of reaction time and yield, in particular for highly challenging

Scheme 161. Different Silver Chloride Complexes with Ethylenethiourea

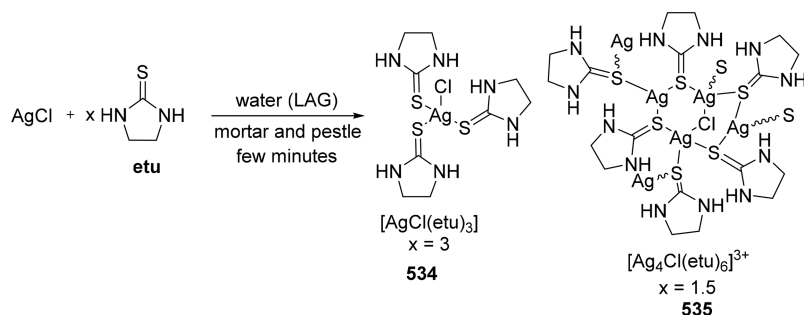

complexes such as homoleptic copper complexes **533** featuring noncoordinating anions.

Silver is one of the less expensive noble metals, and corresponding complexes are highly developed for different applications, such as catalysis, in particular for activation of alkynes.³⁰⁵ Numerous silver salts and complexes exhibited biological properties (antimicrobial,³⁰⁶ anticancer,³⁰⁷ or anti-inflammatory³⁰⁸).

Bowmaker et al. used mechanochemistry, and more specifically grinding using a mortar and pestle, to quickly evaluate the stability and formation of silver complexes featuring various thioureas (x)**tu** as ligands (**tu** = thiourea, **detu** = *N,N'*-diethylthiourea, and **ettu** = *N*-ethylthiourea) in highly concentrated mixtures. In all of these studies, liquid-assisted grinding was necessary to obtain satisfactory reaction rates. Manual grinding of $[\text{Ag}_4\text{Cl}(\text{etu})_6]\text{Cl}_3$ **535**, as a 1:1.5 AgCl/etu complex, with 1.5 equiv of ethylenethiourea and a few drops of water provided $[\text{AgCl}(\text{etu})_3]$ **534** (Scheme 161).³⁰⁹ When lower amounts of **etu** were used, a mixture composed of starting materials and **534** was obtained, as witnessed by IR spectroscopy. This confirmed that $[\text{AgCl}(\text{etu})_2]$ was unstable with respect to the other complexes. Since the complex $[\text{AgI}(\text{etu})]$ was found to be highly unstable in water, the authors subsequently investigated the reaction of $[\text{AgI}(\text{etu})_{0.5}]$ with varying amounts of **etu**. IR analysis demonstrated that $[\text{AgI}(\text{etu})_2]$ could be formed exclusively and that $[\text{AgI}(\text{etu})]$ and $[\text{AgI}(\text{etu})_3]$ were too unstable to be observed. The same authors further extended the knowledge of the mechanochemistry of silver halides with thiourea.³¹⁰ $[\text{AgX}(\text{tu})]$, $[\text{AgX}(\text{tu})_3]$, and $[\text{AgX}(\text{tu})_4]$ ($X = \text{Cl}, \text{Br}, \text{I}$) could be obtained selectively using various silver:**tu** ratios. Use of mono- and disubstituted ureas led to the unique formation of $[\text{AgX}(\text{ettu})_3]$ and $[\text{AgX}(\text{detu})_3]$, respectively. This difference in behavior was assigned to the reduction of hydrogen bonding strength upon urea *N*-substitution. A similar study was performed using silver(I) thiocyanate as the starting material.³¹¹ The mechanochemical method enabled the verification of the findings of the stoichiometric reaction of AgSCN with **etu**, that $[\text{AgSCN}(\text{etu})]$ was not stable enough to be observed. Instead, a mixture of $[\text{AgSCN}(\text{etu})_2]/[\text{AgSCN}(\text{etu})_{0.5}]$ was obtained. Interestingly, $[\text{AgSCN}(\text{etu})_{0.5}]$ was never observed before, even when performing the reactions in solution. When silver nitrate was used as a starting material, the solid adducts $[\text{AgNO}_3(\text{tu})_x]$ could be synthesized ($x = 1, 1.5, 1.53, 3$).²⁹¹ Importantly, the mechanochemical procedure allowed the suppression of the undesired side reactions, which occurred in solution in the case of $[\text{AgNO}_3(\text{tu})]$, to access new Ag/**tu** stoichiometries (e.g., 15:23).

In 2011, the same group reported the mechanochemical synthesis of $[\text{Ag}(\text{HCO}_3)(\text{PPh}_3)_2]$ grinding Ag_2CO_3 , PPh_3 , CO_2 , and H_2O

with ethanol as a liquid assistant with a mortar and pestle.³¹² Interestingly, the formation of the bicarbonate ligand came from atmospheric CO_2 and H_2O . Similarly, $[\text{Ag}(\text{H}_2\text{cit})(\text{PPh}_3)_2] \cdot \text{EtOH}$, $[(\text{Ag}(\text{PPh}_3)_2)_2(\text{H}_2\text{cit})]$, and $[\text{Ag}(\text{H}_2\text{cit})(\text{PPh}_3)_3]$ (H_2cit = dihydrogen citrate) were formed by mechanochemical synthesis using a one-pot two-step procedure, in which the liquid assistant was purposefully different in the two steps.³¹³ The choice of assistant was according to the solubility of the reagents and products. First, silver oxide and citric acid were ground with a small quantity of water, followed by addition of triphenylphosphine and a small amount of ethanol to yield an off-white paste. The ratio of all reagents was varied as to obtain different complexes. This procedure enabled reaction times to be reduced to a minimum. The mechanochemical synthesis of trisilver(I) citrate was also reported by grinding silver(I) oxide and citric acid in a 3:2 ratio by water-assisted grinding.

Syntheses of different NHC silver complexes **536** and **537** were developed by the Lamaty group. *N,N*-Dialkyl NHC silver halide complexes were formed by mixing an imidazolium salt and silver oxide in a stainless-steel jar using a vibratory ball-mill Retsch MM200 at 25 Hz (Scheme 162, reaction A).³¹⁴ Eleven

Scheme 162. Mechanochemical Synthesis of NHC Silver Complexes

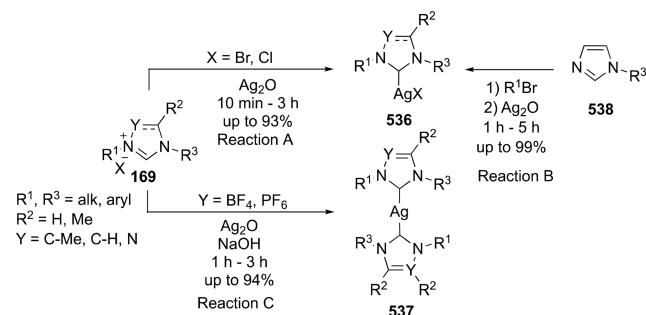

complexes were prepared in yields of up to 93% with milling times between 10 and 150 min featuring different alkyl groups on the ligand. Comparison with literature conditions showed that the ball-mill approach has a real positive effect in terms of reaction times and yields and gives access to unprecedented complexes. A one-pot, two-step approach from imidazolium **538** enabled avoidance of imidazolium salt intermediate isolation, while keeping the same overall efficiency (Scheme 162, reaction B). To generalize the method, authors described the synthesis of *N,N*-diaryl NHC silver halide complexes.²⁶² Due to the lower reactivity of *N,N*-diaryl imidazolium salts, the milling frequency was increased to 30 Hz; however, a short reaction time of 1.5 to 3 h was kept, even for the synthesis of

Scheme 163. Synthesis and Transformation of NHC Gold Complexes

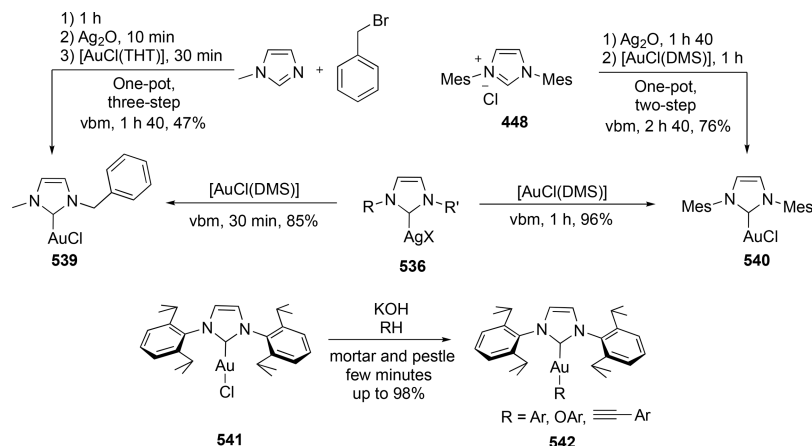

challenging silver complexes featuring sterically hindered ligands. As for copper complexes, this methodology facilitated access to homoleptic silver complexes, which were rarely described because of synthetic issues (Scheme 162, reaction C).³¹⁵ Starting from imidazolium salts featuring a non-coordinating anion (BF_4 , PF_6), complexes **537** were prepared in yields of up to 94% and within a short time (1–3 h). Due to the relatively low reactivity of imidazolium tetrafluoroborate and hexafluorophosphate salts, sodium hydroxide was added into the jar to perform the metalation.

Apart from their use in catalysis, gold complexes are well-known in pharmaceutical science for their applications as drugs to treat rheumatoid arthritis. Moreover, Au(I) phosphine complexes display a wide spectrum of anticancer activity *in vivo*.⁷ Interestingly, Au(III) is isoelectronic and isostructural of Pt(II). Therefore, Au(III) analogues of Pt(II) complexes were investigated for their biological properties.¹⁴²

As for NHC palladium and copper complexes (Scheme 131 and Scheme 160), the transmetalation of $[\text{AgCl}(\text{NHC})]$ into $[\text{AuCl}(\text{NHC})]$ in a vibratory ball-mill Retsch MM200 operated at 25 Hz was found to be highly efficient (Scheme 163).³¹⁴ Complex **539** was also obtained from *N*-methylimidazole in a one-pot, three-step procedure, which gave the desired product in 47% yield (78% average yield on each step) in only 100 min compared to hours in solution. The same procedure was used to form *N,N*-diaryl NHC gold complex **540** in high yield.²⁶² In 2013, the Nolan group described the one-pot mechanotransformation of $[\text{AuCl}(\text{IPr})]$ **541** into $[\text{Au}(\text{IPr})\text{R}]$ **542** by grinding it with a mortar and pestle with an excess of KOH. $[\text{Au}(\text{IPr})\text{OH}]$, a complex which was previously synthesized in solution, was formed intermediately. Ulterior grinding with an organic R–H substrate in stoichiometric amounts produced complexes **542** (Scheme 163).³¹⁶ The overall synthesis was complete within a few minutes in a mortar even for highly challenging substrates, whereas hours were necessary in solution (time is dependent on the $\text{p}K_a$ of the organic substrate). Surprisingly, more acidic phenols and carboxylic acids did not react in the solid-state synthesis, although they were the most reactive in solution.

In their publication on the mechanochemical oxidation of zerovalent metals, as well as for palladium oxidation (Scheme 134), the Frišćić group demonstrated the mechanochemical oxidation of metallic gold to form $[\text{AuCl}(\text{PPh}_3)]$ **544** in a two-step procedure (Scheme 164).³¹⁷ The use of ball milling

enables the avoidance of strong acids or molten salts as oxidants.

Scheme 164. Mechanochemical Oxidation of Metallic Gold

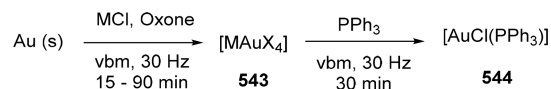

In a one-pot, two-step synthesis in a ball mill, dinuclear gold complexes **546** ($[\text{Au}_2(\text{dpephos})_2]\text{X}_2$, X = NO_3 , CF_3SO_3 , BF_4 , PF_6 , and SbF_6 , dpephos = bis[(2-diphenylphosphino)phenyl] ether) were formed in only 10 min of grinding (Scheme 165).³¹⁸ Interestingly, the compounds display aurophilicity-

Scheme 165. Dichloromethane-Assisted Mechanochemical Synthesis of $[\text{Au}_2(\text{dpephos})_2]\text{X}_2$

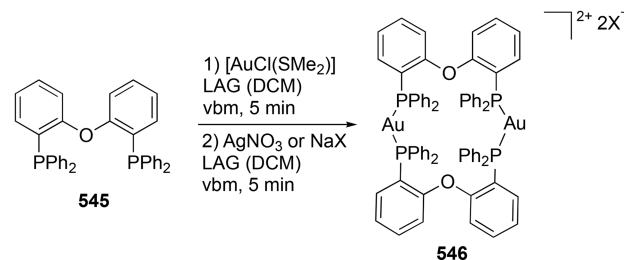

triggered multicolor emission. In the solid state, the emission wavelength of the compounds is dependent on the working temperature, the excitation wavelength, and pressure. Moreover, reversible mechanochromic luminescence was demonstrated upon exposure of the compounds to solvent vapors during grinding.

11.2. Microwave Synthesis of Group 11 Metal Complexes

Copper(II) complexes featuring Schiff base ligands were intensely studied in recent years due to their biological properties as antimicrobial or antioxidizing agents. In 2012, Ramakanth et al. reported the synthesis of a $[\text{Cu}(\mathbf{79})_2]$ complex (Table 8, entry 1).¹³³ Ligand **79** was added to copper(II) acetate monohydrate in ethanol, in a 2:1 ratio. The reaction mixture was then heated in a microwave oven at 600 W for 18 s to obtain the product in 92% yield. This represents a drastic time reduction since 5.5 h was necessary to obtain the same complex in 81% yield under conventional reflux conditions.

Table 8. Microwave Synthesis of Cu(II)–Schiff Base Complexes versus Conventional Heating^a

entry	copper complex	microwave synthesis		conventional heating		ref
		time	yield (%)	time (h)	yield (%)	
1	[Cu(79) ₂]	18 s	92	5.5	81	133
2	[Cu(74)(H ₂ O)]	7 min	85	7	62	95
3	[Cu(75)Cl]·H ₂ O	8 min	83	7	66	95
4	[Cu(76 ₂ Cl ₂)·2H ₂ O	6 min	84	6	64	235
5	[Cu(77 ₂ Cl ₂)·2H ₂ O	7 min	82	7	68	235
6	[Cu(88)]·2H ₂ O	6 min	85	7	66	98
7	[Cu(78) ₂]·2H ₂ O	7 min	82	7	65	96
8	[Cu(80) ₂]	8 min	84	6	63	96
9	[Cu(69) ₂ (H ₂ O) ₂]Cl ₂	8 min	83	7	60	272
10	[Cu(70) ₂]	7 min	85	6	67	272
11	[Cu(81) ₂]	7 min	86	6	74	99
12	[Cu(82) ₂]·H ₂ O	7 min	81	8	71	99
13	[Cu(84) ₂]·2H ₂ O	8 min	82	7	69	97
14	[Cu(83)(H ₂ O)]Cl	7 min	84	7	68	97
15	[Cu(85) ₂]·2H ₂ O	8 min	84	8	64	100
16	[Cu(86) ₂ (H ₂ O) ₂]	7 min	82	8	68	100
17	[Cu(71)]·H ₂ O	8 min	84	10	55	134
18	[Cu(89)]	8–10 min	74–80	hours	55	236
19	[Cu(103) ₂]	1 h	83	0.5	76	273
20	[Cu(104)Cl]	1.5 h	77	2	62	273
21	[Cu(105)Cl]	2.5 h	68	3	54	273
22	[Cu(106) ₂]	2.1 h	73	3.5	65	273

^aSee Figure 1 for the structure of the ligands.

Between 2012 and 2016, the Jain group reported the microwave synthesis of numerous copper(II) complexes with Schiff bases as ligands. Syntheses were performed in an open glass vessel using a modified microwave oven model 2001 ETB with a rotating tray and a microwave energy output of 800 W. Microwave reactions were performed using on/off cycling to control the temperature. [Cu(74)(H₂O)],⁹⁵ [Cu(75)Cl]·2H₂O,⁹⁵ [Cu(76)₂Cl₂]·2H₂O,²³⁵ [Cu(77)₂Cl₂]·2H₂O,²³⁵ [Cu(88)]·2H₂O,⁹⁸ [Cu(78)₂]·2H₂O,⁹⁶ [Cu(80)₂],⁹⁶ [Cu(69)₂(H₂O)₂]Cl₂,²⁷² [Cu(70)₂],²⁷² [Cu(81)₂],⁹⁹ [Cu(82)₂]·2H₂O,⁹⁹ [Cu(84)₂]·2H₂O,⁹⁷ [Cu(83)(H₂O)]Cl,⁹⁷ [Cu(85)₂]·2H₂O,¹⁰⁰ and [Cu(86)₂(H₂O)₂]¹⁰⁰ (Table 8, entries 2 to 16, see Figure 1 for ligand structures) were synthesized using a similar procedure. Before microwave irradiation, the ligand and [CuCl₂]·2H₂O were ground in a stoichiometric ratio of 1:1 or 2:1. After 6 to 8 min of irradiation in 3–5 mL of dry ethanol, the corresponding complexes were recovered in yields between 81 and 86%. Microwave irradiation outperformed classical conditions, enabling the reaction time to be reduced from hours to only minutes and to increase the yield from 60–70% to more than 80%.

In 2014, the microwave synthesis of [Cu(71)]·H₂O was reported.¹³⁴ Only 8 min of microwave irradiation was necessary to isolate the complex in 84% yield; in comparison, conventional heating required 10 h to obtain a moderate 55% yield (Table 8, entry 17). In DMF, [Cu(103)₂], [Cu(104)Cl], [Cu(105)Cl], and [Cu(106)₂] were synthesized under microwave irradiation. The reaction times were slightly reduced, and the yields were improved compared to conventional syntheses.²⁷²

Once again (see cobalt and nickel luminol complexes, Scheme 112), Aswathy et al. showed that coordination of a luminol derivative onto copper was detrimental to the fluorescence lifetime (Scheme 166). Nevertheless, copper(II)

complex 547 could be obtained in 5 min irradiation and in 80% yield starting from CuCl₂.²³⁷

Scheme 166. Microwave-Assisted Synthesis of a Copper Complex Featuring a Luminol Derivative Ligand

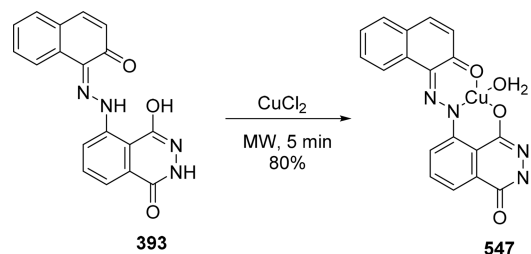

Macrocyclic copper(II) complexes 548 could also be obtained through microwave activation (Scheme 167 and

Scheme 167. Microwave Synthesis of Macrocyclic Cu(II) Complexes

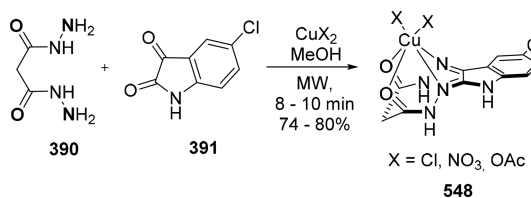
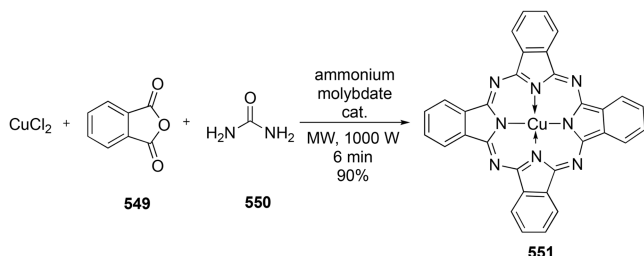

Table 8, entry 18).²³⁶ Malonic acid dihydrazide 390, 5-chloroisatin 391, and CuX₂ (X = Cl, NO₃, OAc) were mixed in a grinder in a 1:1:1 ratio. The Schiff base ligand was formed *in situ*. The reaction mixture was then irradiated in an UWave-1000 Sineo microwave synthesizer for 8–10 min to obtain the corresponding copper complexes in yields between 74 and

80%. The reaction time was considerably reduced from hours to minutes, and yields were increased, compared with the 55% obtained under reflux.

The conventional synthesis of the Cu(II) phthalocyanine complex takes several hours under reflux; therefore, a more sustainable synthesis was developed using microwave irradiation (Scheme 168).³¹⁹ Solvent-free synthesis was performed

Scheme 168. Synthesis of a Cu(II) Phthalocyanine Complex



by first grinding anhydrous CuCl_2 , phthalic anhydride **549** in a 1:4 ratio, urea **550** in large excess, and ammonium molybdate in catalytic quantity with a mortar and pestle. The homogenized reaction mixture was then transferred to a reactor and placed in a laboratory microwave oven (1000 W) for 6 min (6 cycles of 1 min of heating with pauses of 5 s) to isolate desired product **551** in 90% yield.

Microwave irradiation also enabled the drastic acceleration of NHC copper, silver, and gold complex synthesis (Scheme 169).³²⁰ Using a CEM Discover unit at 110 °C with

Scheme 169. Microwave Formation of NHC Copper and Silver Complexes

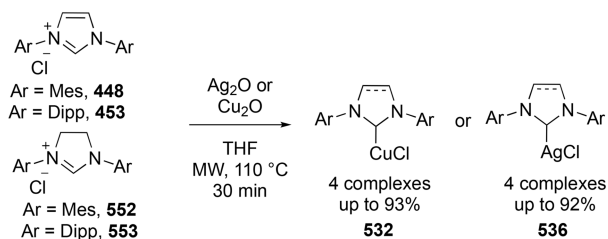

simultaneous cooling, imidazolium salts ($\text{IMes}\cdot\text{HCl}$ **448** = 1,3-bis(2,4,6-trimethylphenyl)-1*H*-imidazolium chloride, $\text{SIMes}\cdot\text{HCl}$ **552** = 1,3-bis(2,4,6-trimethylphenyl)-1*H*-imidazolium chloride, $\text{IPr}\cdot\text{HCl}$ **453** = 1,3-bis(2,6-diisopropylphenyl)-1*H*-imidazolium chloride, and $\text{SIPr}\cdot\text{HCl}$ **553** = 1,3-bis(2,6-diisopropylphenyl)-1*H*-imidazolium chloride) were reacted with copper(I) oxide for 30 min to produce the corresponding $[\text{CuCl}(\text{NHC})]$ complexes **532** in yields between 73 and 98%. Importantly, reactions required 24 h when using classical refluxing conditions. Interestingly, yields were better for more hindered salts, **453** and **553**. The synthesis was scaled up to 2 g

Scheme 170. Microwave Syntheses of NHC Gold Complexes

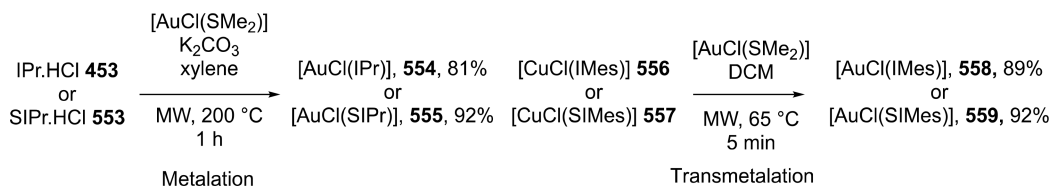

of $[\text{CuCl}(\text{453})]$ in less than 1 h (93% yield). The same reaction improvement was observed for the formation of four $[\text{AgCl}(\text{NHC})]$ complexes **536** from silver(I) oxide.

The synthesis of gold complexes was found to be more challenging since direct metalation was only efficient with $\text{IPr}\cdot\text{HCl}$ **453** and $\text{SIPr}\cdot\text{HCl}$ **553**, at 200 °C for 1 h in xylene (Scheme 170, metalation). When this procedure was attempted for the synthesis of $[\text{AuCl}(\text{IMes})]$ **558** and $[\text{AuCl}(\text{SIMes})]$ **559**, a mixture of products was obtained. To avoid this, transmetalation of corresponding copper(I) complexes **556**–**557** was performed, producing the desired gold complexes in yields of up to 92% after 5 min at 65 °C (Scheme 170, transmetalation).

Transmetalation of gold complexes with arylboronic acids was also investigated using microwave activation since aryl gold complexes are highly valuable molecules in numerous applications (emissive materials, metallodrugs, mechanistic intermediates).³²¹ Reacting $[\text{AuCl}(\text{JohnPhos})]$ **560** (JohnPhos = di(*tert*-butyl)(1,1'-biphenyl-2-yl)-phosphine) or $[\text{AuCl}(t\text{BuXPhos})]$ **561** (*t*BuXPhos = di-*tert*-butyl(2',4',6'-triisopropylbiphenyl-2-yl)phosphine), $\text{ArB}(\text{OH})_2$, and Cs_2CO_3 in THF in a 1:2:2 ratio at 70 °C for 30–90 min under microwave activation proved highly efficient (Scheme 171). In

Scheme 171. Synthesis of Aryl Gold(I) Species by Microwave Irradiation

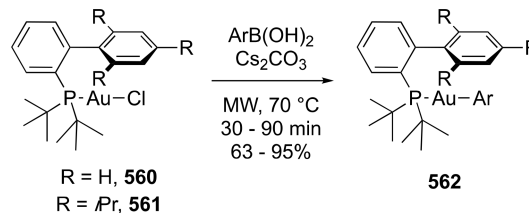

addition to improvements in terms of reaction time (up to 60 h under reflux), the use of microwaves enabled reduction in arene formation and working with electron-rich, electron-poor, or even ortho-substituted boronic acids. Notably, benzothio-phene-2-boronic acid, which is prone to protodeboronation, could be transmetalated efficiently using this microwave methodology.

Gold complexes featuring nitrogen-containing ligands could also be obtained with enhanced results through microwave activation. An early paper reported the first microwave synthesis of the $[\text{AuCl}(\text{terpy})]\text{Cl}_2\cdot 3\text{H}_2\text{O}$ complex.⁹¹ Using a sealed Teflon reactor in a microwave oven with a power level of 500–600 W for 1 min, the desired complex was synthesized, from HAuCl_4 and terpy, in 37% yield. The formation of small quantities of the $[\text{Au}(\text{terpy})\text{Cl}]_2$, $[\text{AuCl}_2]_3$, $[\text{AuCl}_4]$ intermediate was also observed. Using conventional reflux conditions, the reaction required 24 h to obtain the desired complex.

Scheme 172. Syntheses of Pyridine-Containing Gold Complexes

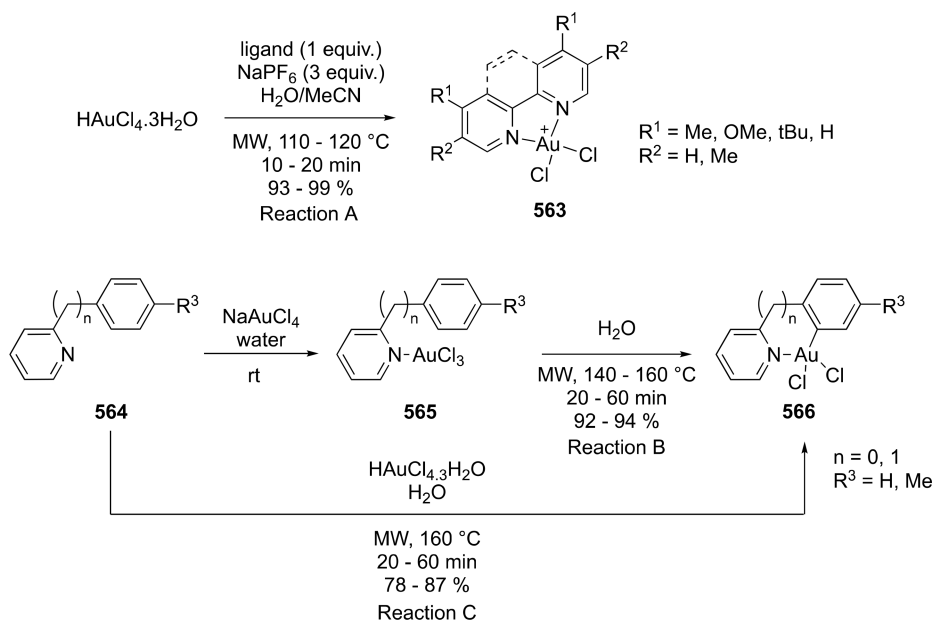

Coordination of bipyridine-type ligands starting from $\text{HAuCl}_4 \cdot 3\text{H}_2\text{O}$ was also reported using microwave irradiation.³²² Ligands, $\text{HAuCl}_4 \cdot 3\text{H}_2\text{O}$, and NaPF_6 in a 1:1:3 ratio were heated at 120 °C in a sealed Teflon vessel using a Milestone MicroSYNTh oven to produce pure $[\text{AuCl}_2(\text{N}-\text{N})][\text{PF}_6]$ **563** in 10–30 min and excellent yields (Scheme 172, reaction A). In addition to a reduced reaction time compared to the classical synthesis, the microwave methodology allowed for an otherwise necessary recrystallization step to be avoided. Access to $[\text{AuCl}_2(\text{C}-\text{N})]$ complexes **566** (C–N = cyclometalated 2-phenylpyridine 2-benzylpyridine-type ligands) was possible either from pyridine-ligated gold complex **565** through C–H activation (Scheme 172, reaction B) or directly from the C–N ligand **564** and $\text{HAuCl}_4 \cdot 3\text{H}_2\text{O}$ in a one-pot approach (Scheme 172, reaction C). Using both pathways, yields and reaction times were dramatically improved in comparison with refluxing conditions. The only limitation was the unsuccessful cyclometalation with 2-ethylpyridine.

11.3. Ultrasounds for the Synthesis of Copper and Silver Complexes

Sonochemical syntheses of copper and silver complexes are quite rare in the literature, and to the best of our knowledge, no example has been reported for gold. In 2015, the Morsali group described the ultrasonic synthesis of $[\text{Cu}(\text{567})] \cdot (\text{EtOH})_{0.5} \cdot (\text{H}_2\text{O})_{1.5}$ and $[\text{Cu}(\text{568})_2]$ at 40 kHz for 1 h (Figure 10).³²³ Interestingly, the same conditions under reflux were also efficient in yielding the expected complexes, but the powder obtained was not nanosized. Regarding silver, the only application of sonochemistry dealt with anion metathesis starting from $[\text{Ag}(\text{569})_2]\text{Cl}$ to yield $[\text{Ag}(\text{569})_2]\text{BF}_4$, a

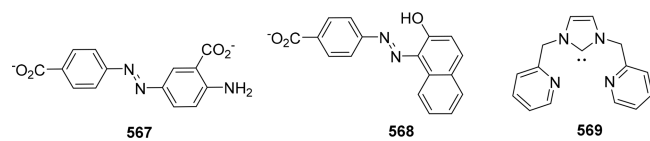

Figure 10. Ligands used for ultrasonic synthesis of copper and silver complexes.

photoluminescent complex.³²⁴ Only 5 min was required to afford the classical homoleptic tetrafluoroborate complex (89% yield) using an ultrasonic cleaner, which could be transformed, upon addition of AgBF_4 , into a trimetallic species featuring different luminescent properties.

11.4. Continuous Flow for the Synthesis of NHC Copper Complexes

As discussed above, continuous flow is still an emerging technology, particularly in relation to organometallic synthesis. To date, only copper complexes have been synthesized using this enabling technology. In 2013, the McQuade group described the first continuous synthesis of $[\text{CuCl}(\text{NHC})]$ complexes **532** by flowing a DCM/toluene solution of imidazolium salts **169** through a packed bed of solid Cu_2O suspended in molecular sieves to prevent leaching of fine-grained Cu_2O and to remove water produced during the reaction.³²⁵ The use of solids in flow is generally avoided since they could cause pump or reactor clogging. Using a packed bed of Cu_2O downstream of the pumps, however, allowed the formation of the desired complexes and increased the rate of complex synthesis due to the increasing interaction between solid Cu_2O and the imidazolium salt. When imidazolium triflate and tetrafluoroborate were used instead of imidazolium chloride, the reaction did not afford the desired complexes. Since some imidazolium salts are not isolatable as their chloride salt, an ion exchange column was used upstream to form an intermediate of the chloride salt that would then react with Cu_2O (Scheme 173). These examples show that using Cu_2O for the synthesis of NHC–copper complexes is limited when considering halide copper(I) complex production. Despite this, the formation of complexes that were impossible to make in classical solution was enabled following this method. For example, 1,3-dicyclohexylimidazolium chloride reacted efficiently in flow, whereas the corresponding urea was obtained in batch conditions. To demonstrate that this flow methodology was scalable, 1 g of $[\text{CuCl}(\text{SIMes})]$ was produced in 16 min.

In 2015, Chapman et al. reported the electrochemical continuous flow synthesis of NHC copper(I) complexes **532**

Scheme 173. Schematic Representation of the NHC Cu Synthesis Reactor in Continuous Flow Using Cu₂O

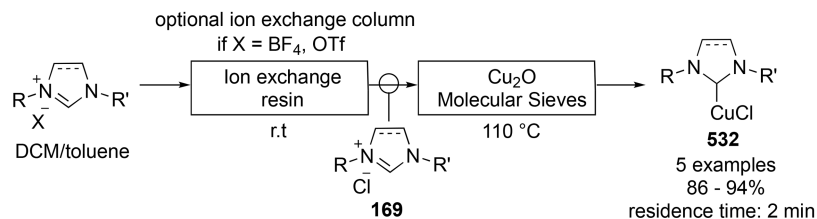

(Figure 11).³²⁶ During the electrochemical reaction, imidazolium ions were reduced at the cathode, and oxidation of the

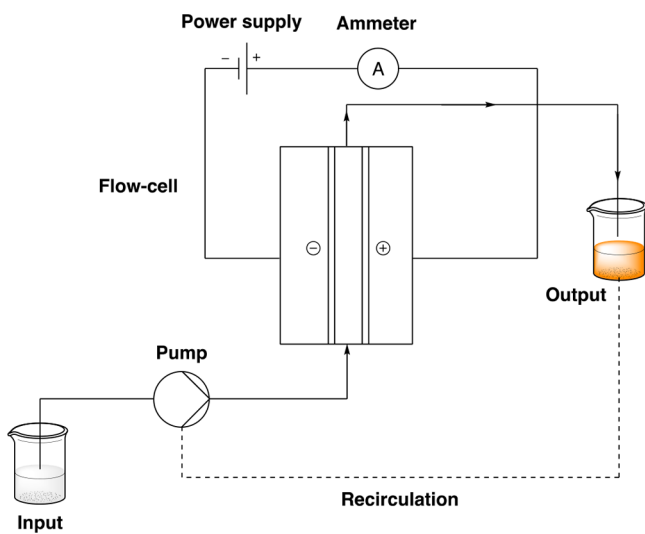

Figure 11. Schematic diagram of the electrochemical synthesis of NHC Cu complexes.

sacrificial copper anode liberates Cu⁺ ions into the solution. The most efficient homemade reactor was prepared in the following manner: six square copper plates, alternating between the anode and cathode and separated by PTFE spacers, were assembled. This design allowed the optimization of all of the reactor parameters. Six copper complexes were synthesized in high yields (91–95%) within a short time (7–30 min). Time was increased to 300 min for the synthesis of one of these complexes in recirculation mode. The method was quite general since different counteranions (Cl, Br, PF₆), bulky and base-sensitive N-substituents, as well as a macrocyclic imidazolium salts could be used.

12. GROUP 12

12.1. Mechanochemical Synthesis of Group 12 Metal Complexes

The Friščić group described a one-pot associative synthesis of zinc complexes that combined solid-state metal oxidation and direct coordination of the ligand. Grinding Zn powder with 3,5-di-*tert*-butyl *ortho*-quinone **151** in the absence of solvent gave poor conversions. In contrast, liquid-assisted grinding of the same mixture in the presence of a 1:1 mixture of toluene and water resulted in the corresponding discrete complexes in 90 min of reaction (Scheme 174).¹²⁴ Interestingly, grinding Zn powder with 1,4-bis(2-(pyridin-4-yl)vinyl)benzene **570** and *ortho*-quinone **151** led to the formation of two different species depending on the toluene:water proportion. In a 1:1 ratio, formation of the dinuclear [Zn₂(SQ)₄(**570**)] complex **576** was observed, whereas in a 4:1 ratio, coordination polymer

Scheme 174. Mechanochemical Reaction of *ortho*-Quinone with Zn Powder^a

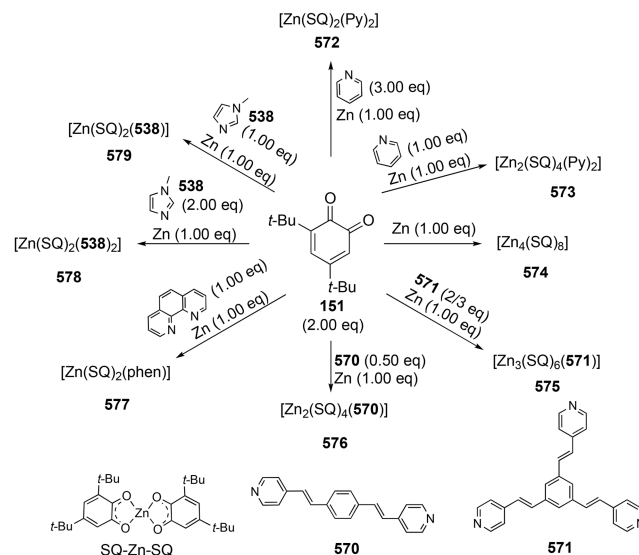

^aReaction conditions: vbm, 25 Hz (60 μL, PhMe/H₂O 1:1 ratio), 90 min, NMI = *N*-methylimidazole.

[Zn(SQ)₂(**570**)] was obtained. Notably, the trinuclear zinc complex **575** was also formed using the tripodal 1,3,5-tris(2-(pyridin-4-yl)vinyl)benzene ligand **571**. XRD data revealed that trigonal complexes arrange into a loosely packed structure with solvent molecules occupying vacant cavities. Interestingly, all syntheses could also be performed using ZnO as a metal source starting from a 1:1 mixture of *ortho*-quinone **151** and the corresponding catechol. The conditions were identical to those with Zn powder.

The James group, in their report dealing with the formation of salen complexes of nickel (Scheme 139) and copper (Scheme 158), also described the isolation of zinc–salen complex **580**.²⁷⁰ The mechanochemical synthesis could be performed either through a one-pot, two-step sequence or all at once by milling salicylaldehyde, ethylene diamine, and zinc oxide at 25 Hz for 1 h (Scheme 175). Interestingly, addition of methanol as a liquid assistant was necessary in the sequential approach but not in the multicomponent approach.

The same group demonstrated that the synthesis of Zn–salen complexes was possible using twin-screw extrusion.³²⁷ Starting from the appropriate aldehyde **581** and diamine **582** in the presence of zinc(II) acetate, the multicomponent reaction yielded corresponding complex **583** with full conversion (Scheme 176). It is important to note that the formation of the bisimine ligand could not be performed efficiently without the addition of the metal source and thus that a sequential synthesis of the complex was not possible.

Scheme 175. Mechanochemistry of a Zn–Salen Complex

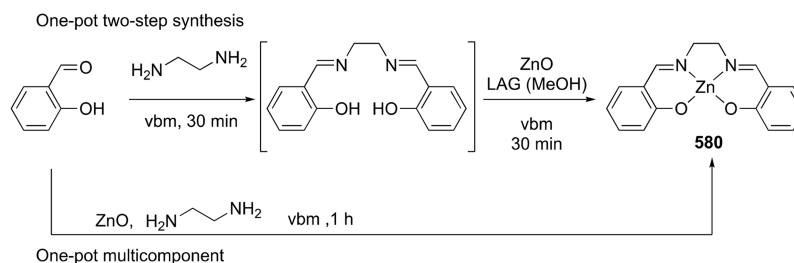

Scheme 176. Multicomponent Preparation of a Zn–Salen Complex

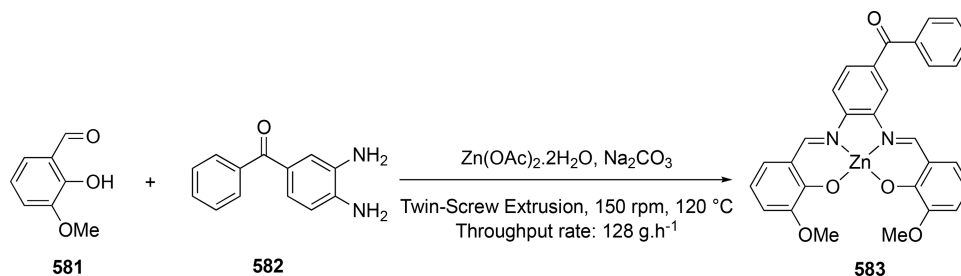

The use of twin-screw extrusion allowed a scale-up of the synthesis, reaching a throughput rate of 128 g·h⁻¹.

As already described with a copper source (Figure 9), manual grinding of anhydrous gabapentin **584** with ZnCl₂ for 5 min with an agate mortar and pestle gave access to [ZnCl₂(gabapentin)₂] **585** in quantitative yield (Scheme 177, reaction A).³⁰¹ Similarly, [MCl₂(CEAP)₂] **586** and the

Scheme 177. Mechanochemistry of Gabapentin and CEAP Complexes

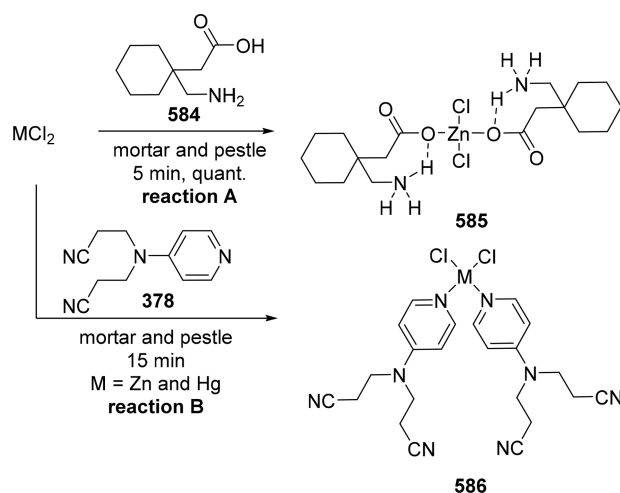

corresponding hydrogen-bonded salts [CEAPH]₂[MCl₄] (M = zinc or mercury) were synthesized mechanochemically using CEAP **378** or CEAP·HCl as ligand source and MCl₂ as metal source, respectively (Scheme 177, reaction B).²²⁸ Interconversion of [MCl₂(CEAP)₂] and [CEAPH]₂[MCl₄] was possible either through grinding in the presence of a base or through absorption of HCl vapors. In contrast to cobalt (Scheme 106) and zinc complexes, the mercury hydrogen-bonded salts could not be converted into the corresponding discrete [HgCl₂(CEAP)₂] complex by grinding with KOH in the solid state.

There is only one reported study on the synthesis of cadmium complexes using mechanochemistry. Grinding cadmium oxide with stoichiometric imidazole in an agate mortar provided the cadmium imidazolate complex in only 30 min.³²⁸ Similarly, only 20 min was necessary to prepare zinc or mercury imidazolates. Interestingly, zinc, cadmium, and mercury imidazolates prepared through grinding were found to have different polymorphic forms than the ones obtained by crystallization.

Crawford et al. recently used a batch mixer, previously used for the preparation of polymers, to optimize the reaction conditions for the synthesis of zinc complex **588** featuring 8-hydroxyquinoline ligands (Scheme 178).³²⁹ Conditions

Scheme 178. Twin-Screw Extrusion of a Zinc Complex with OLED Applications

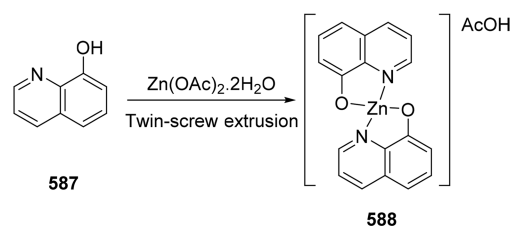

obtained were then directly transferred to twin-screw extrusion in order to scale-up the synthesis of the desired complex, which is of interest for OLED applications.

12.2. Microwave Irradiation for the Synthesis of Group 12 Metal Complexes

Microwave-assisted synthesis was used to form a series of cyanobipyridine-derived zinc(II) bis(thiolate) complexes **591**. Two different procedures, with the addition of either an excess of bipyridine or a thioarene, were developed leading to different zinc complexes, **590** and **591**, respectively (Scheme 179).³³⁰ Addition of a second bipyridyl unit provided the basic chromophoric framework **590** with the potential for modulating luminescent properties (Scheme 179, reaction

Scheme 179. Synthesis of Zinc Complexes with Bipyridine Ligands under Microwave Irradiation

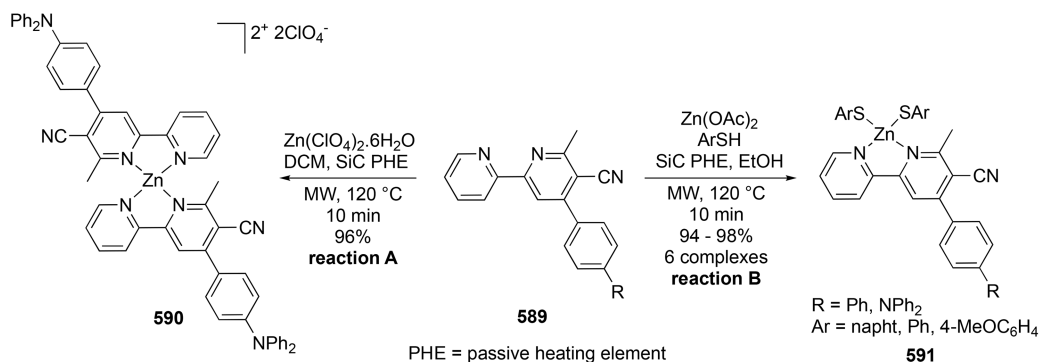

A). Under classical conditions, the desired complexes were obtained in a lower yield (44–56%) and with higher time (24 h). Notably, the cyanopyridine-derived zinc(II) bis(thiolate) complexes **591** displayed LLCT (ligand to ligand charge transfer) fluorescence in the solid state.

In order to optimize the synthesis of phthalocyanine-based zinc-containing liquid crystals, for which the main drawback is the rather long reaction time (from 22 to 88 h), Akabane et al. have developed a microwave procedure, using ethylene glycol as the solvent, enabling the reaction time to be reduced to less than 1 h (Scheme 180).³³¹ Five complexes **593** were synthesized in good yield (58–83%) and characterized.

Scheme 180. Microwave Synthesis of Phthalocyanine Zinc Complexes

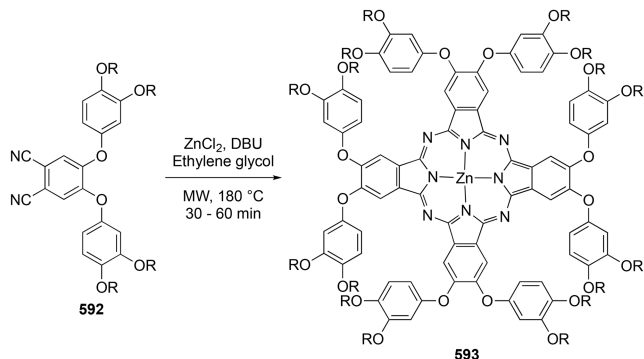

[Zn(79)₂] and [Hg(79)₂] complexes were formed by heating a solution of ligand **79** and M(OAc)₂ (M = Zn and Hg) in ethanol using microwave irradiation (Table 9, entries 1 and 2).¹³³ Similarly, the synthesis of [Zn(87)] was described in 2009 using microwave irradiation starting from ligand **87** (Table 9, entry 3).¹³⁵ Using ZnCl₂ salt as the zinc source, [Zn(71)]¹³⁴ and the macrocyclic [Zn(89)₂]²³⁶ were synthesized using microwave irradiation (Table 9, entries 4 and 5). The reaction mixture was first ground and then irradiated in a microwave oven in 3 or 4 mL of ethanol for a few minutes. All complexes were recovered after only a few seconds of heating and in higher yield than using conventional heating conditions.

A mixture of Zn(NO₃)₂·4H₂O, 2-hydroxy-3-methoxybenzaldehyde, methylamine, and triethylamine in water was heated in a microwave oven (Table 9, entry 6) at 80 °C for 5 min (then rt for 50 min) to produce [Zn₇(OH)₆(90)₆](NO₃)₂ in 20% yield.¹³⁶ Synthesis was also carried out in an autoclave, heating at 80 °C for 120 h, and cooling to room temperature (period of 6 h) to result in the desired complex in 15% yield. In contrast to [Mn₇(OH)₆(90)₆][ClO₄]₂ (Table 5, entry 4), the zinc complex exhibited no fluorescent properties.

Four different Schiff base cadmium complexes were synthesized starting from a methanolic solution of chelates of carbazoles **93–96** derived from Schiff base ligands with N[^]X (X = O, S) link and CdCl₂ (see Figure 1 for ligand structures). The reaction mixture was refluxed under microwave irradiation, and complexes were recovered in 5–6 min and in 89–92% yield (Table 9, entries 7–10).³³² Interestingly, complexes were found more thermally stable than the corresponding ligands and inhibited the growth of microorganisms even at low concentrations.

Table 9. Schiff Base Used for the Synthesis of Zinc and Mercury Complexes^a

entry	complex	microwave synthesis		conventional heating		ref
		time (min)	yield (%)	time (h)	yield (%)	
1	[Zn(79) ₂]	15 s	90	5	80	133
2	[Hg(79) ₂]	25 s	94	5	83	133
3	[Zn(87)]	1	93	5	84	135
4	[Zn(71)]·H ₂ O	6	82	8	64	134
5	[Zn(89) ₂]	8–10	74–80	hours	55	236
6	[Zn ₇ (OH) ₆ (90) ₆](NO ₃) ₂	55	20	126	15	136
7	[Cd(93) ₂ Cl ₂]	6	92	n.a. ^b	n.a. ^b	332
8	[Cd(94) ₂ Cl ₂]	6	89	n.a. ^b	n.a. ^b	332
9	[Cd(95) ₂ Cl ₂]	5	90	n.a. ^b	n.a. ^b	332
10	[Cd(96) ₂ Cl ₂]	6	91	n.a. ^b	n.a. ^b	332

^aSee Figure 1 for the structure of ligands. ^bn.a.: not available.

As for the synthesis of cobalt, nickel, and copper complexes featuring luminal derivatives as the ligand (Scheme 112), corresponding zinc(II) complex **594** was synthesized in less than 10 min, in 81% yield starting from ZnCl₂ (Scheme 181). The result in terms of fluorescence was found to be the same as with the other metals. The fluorescence lifetime was decreased compared to the free ligand.²³⁷

Scheme 181. Microwave-Assisted Synthesis of a Zinc-Luminal Derivative

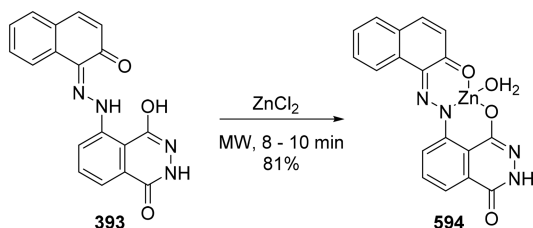

12.3. Ultrasonic Activation and Mercury

Two mercury(II) complexes **596** and **597** were synthesized from 4-mtrt ligand **595** (4-methyl-4*H*-1,2,4-triazole-3-thiol) and HgX₂ (X = Br, Cl) under classical heating conditions or using an ultrasonic bath (Scheme 182).³³³ Sonochemical

Scheme 182. Ultrasound Synthesis of Nanostructured [Hg(4-mtrt)X₂] Complexes

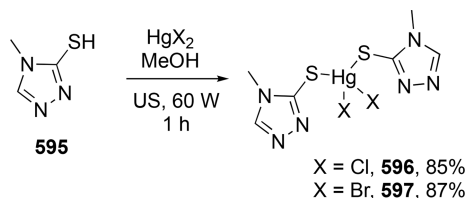

synthesis was carried out in order to obtain nanosized supramolecular materials, whereas synthesis in solution enabled crystals suitable for X-ray diffraction to be acquired. Comparison of PXRD patterns confirmed that both methods produced the same compounds; varying sizes of particles were, however, observed. SEM analysis showed that samples prepared by sonochemical methods were about 50–60 nm.

13. MECHANOCHEMICAL ACCESS TO ALUMINUM AND INDIUM COMPLEXES

Under solvent-free conditions, mechanochemical treatment of [Al(OAc)₂(OH)] and 8-hydroxyquinoline **587** led to the formation of AlQ₃·AcOH **598** (Q = 8-hydroxyquinolinate) within a few minutes (Scheme 183).³³⁴ Syntheses were developed in vibratory and planetary ball mills with scalability of up to 50 g. Notably, **598** was easily transformed into AlQ₃ by heating at 200 °C for 2 h. Interestingly, another polymorph of **598** could be obtained via vapor diffusion of acetone into a solution of AlQ₃ in acetic acid. The synthesis of **598** was recently described by using a batch mixer and a twin-screw extruder.³²⁹ The AlQ₃ complex is well-known to exhibit photoluminescence and has important applications in OLED materials. Notably, samples obtained by solid-state synthesis exhibited identical photoluminescence as samples prepared by the conventional synthetic route.

Scheme 183. Ball-Mill Synthesis of AlQ₃·AcOH^a

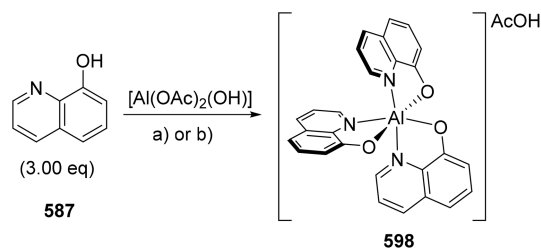

^aReaction conditions: (a) vbm, 25 Hz, 15 min, 94% (1.12 g), (b) pbm, 450 rpm, 35 min, 78% (48.3 g).

Unsolvated tris(allyl)aluminum species had never been isolated under classical solution conditions, although adducts with THF, OPPh₃, and pyridine are known. In this context, Rightmire et al. described the mechanochemical synthesis of [Al(1,3-(SiMe₃)₂C₃H₃)₃] starting from AlX₃ (X = Cl, Br) and the allyl anion **599** (Scheme 184).⁸⁰ Various milling processes were used; for example syntheses using a disperser mill led to the formation of around 150 mg of [Al(1,3-(SiMe₃)₂C₃H₃)₃] **600** in 15 min and in 80–85% yield. Using a planetary ball mill, 1.3 g of the complex was recovered in only 5 min with an excellent yield of 88%. Interestingly, the tris(allyl)aluminum complex, featuring bulky ligands, did not react with sterically hindered triphenylmethanol but reacted instantaneously with benzophenone in solution to yield the tris(O-coordinated) aluminum species **601**. Moreover, the nonsolvated aluminum species obtained through grinding was found to react faster than the THF-solvated one.

Indium complexes **604** and **605**, featuring bisimine ligands **583**, were prepared by mechanochemistry in 2016 by Wang et al. (Scheme 185).³³⁵ Alternatively, an efficient one-pot, two-step procedure starting from the corresponding diketone **602** and anilines **603** could be performed in a vibratory ball-mill MM400. The one-pot synthesis using 4-bromoaniline unfortunately led to the desired product in a mixture with other indium byproducts. Interestingly, the solid-state thermal reactions of neat bisimine with InCl₃ at 180 °C for 2.5 h led to the decomposition of the starting materials without any reaction. With longer reaction times and lower yields, the same complexes could be obtained via classical solution conditions. The same protocol was later used for the synthesis of four more complexes featuring differently substituted bisimines.³³⁶

14. GROUP 14

14.1. Mechanosynthesized Lead Complexes

Due to their rapid progress in power conversion, perovskite photovoltaic devices have become alternative candidates for future power generation. In general, preparation methods of materials have an important influence on their properties. Numerous procedures have been developed including solvothermal syntheses and high-temperature solid-state reactions. Milling appropriate precursors using a mortar and pestle led to the formation of the perovskite with significant amounts of unreacted precursors. Using a vibratory ball mill for 30 min, highly crystalline hydrid organic–inorganic perovskite CH₃NH₃PbI₃ could be synthesized with full conversion starting from CH₃NH₃I and PbI₂.³³⁷ Particle analysis showed an exact stoichiometric composition and high thermal stability. In addition, the material exhibited superior performances

Scheme 184. Mechanochemistry of $[\text{Al}(\text{1,3}-(\text{SiMe}_3)_2\text{C}_3\text{H}_3)_3]$ Starting from Silylallyl anion^a

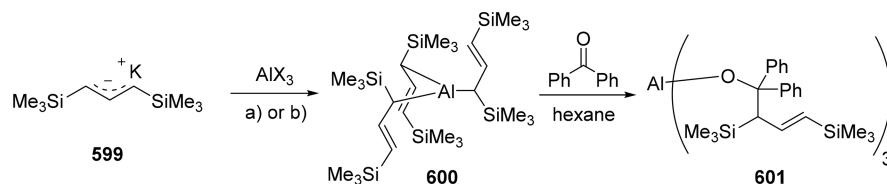

^aReaction conditions: (a) X = Cl or Br, disperser milling, 15 min, 80–85% (around 150 mg scale), (b) X = Br, pbm, 600 rpm, 5 min, 88% (1.3 gram scale).

Scheme 185. Mechanochemistry of Indium Complexes

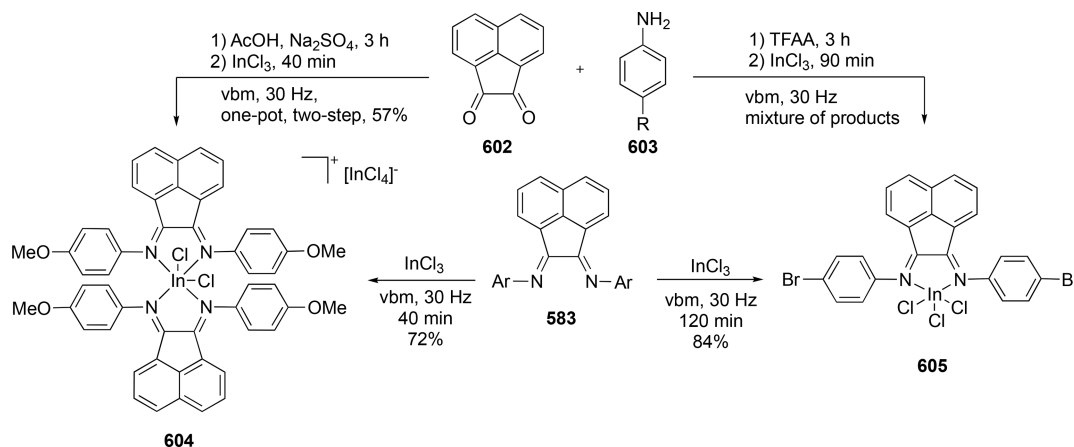

Scheme 186. Microwave-Assisted Synthesis of Tin Complexes of Hippuric Carboxylate

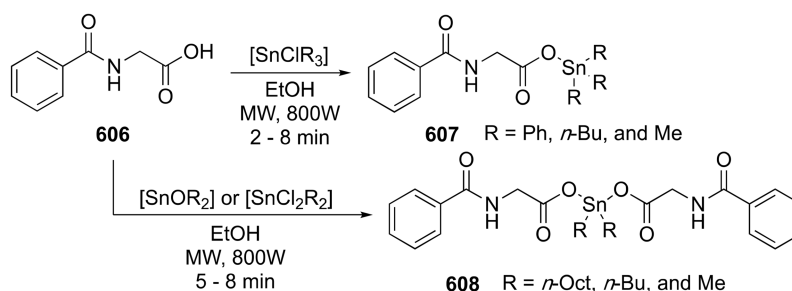

compared to perovskite prepared by a standard solution process.

14.2. Microwave Syntheses of Tin and Germanium Compounds

To evaluate their biological properties as anticancer and anti-inflammatory agents, six different tin complexes featuring hippuric acid (HHA) **606** as the ligand were synthesized under microwave irradiation.³³⁸ Substitution of the chloride in various triorganotin(IV) chlorides SnClR_3 resulted in the corresponding $[\text{Sn}(\text{HA})\text{R}_3]$ complexes **607** (R = Ph, *n*-Bu, and Me). Alternatively, $[\text{Sn}(\text{HA})_2\text{R}_2]$ **608** (R = *n*-Oct, *n*-Bu, and Me) could be obtained from diorganotin chlorides or oxides (Scheme 186). As already described above for the synthesis of complexes featuring Schiff base ligands, the reaction mixture was ground with a mortar and pestle before irradiation. Comparison with the conventional thermal method demonstrated that the microwave irradiation method was more convenient because of a shorter reaction time (minutes vs 4 to 14 h under conventional conditions), and a lower quantity of solvent was used, although yields were comparable.

Starting from a solution of ligand **79** and Sn(II) acetate (at a stoichiometric ratio) in ethanol, $[\text{Sn}(\text{79})_2]$ was synthesized via microwave irradiation in 35 s to obtain the product in 95% yield (Table 10, entry 1).¹³³ Similarly to cadmium complexes, four tin complexes were prepared from carbazole-derived Schiff base ligands (**93–96**) and $\text{SnCl}_2 \cdot 2\text{H}_2\text{O}$. The corresponding complexes were recovered in only 5 min and in 89–96% yield (Table 10, entries 2–5).³³²

Microwave-assisted synthesis of eight organotin(IV) $[\text{Sn}(\text{CH}_3)_2(\text{L})\text{Cl}]$ and $[\text{Sn}(\text{CH}_3)_2(\text{L})_2]$ complexes was developed starting from the corresponding Schiff bases derived from dithiocarbamate (**91** and **92**), thiosemicarbazone (**97** and **98**), semicarbazone (**99** and **100**), or benzothiazoline (**101** and **102**) and $\text{SnCl}_2(\text{CH}_3)_2$ in solution in MeOH.^{339,340} Equimolar and bimolar ratios of ligand/metal were used to obtain both families of complexes, $[\text{Sn}(\text{CH}_3)_2(\text{L})\text{Cl}]$ and $[\text{Sn}(\text{CH}_3)_2(\text{L})_2]$, respectively. In comparison with reflux, the use of microwave irradiation decreased reaction times from overnight to only a few minutes and increased the yield from 70–76% to 80–89% (Table 10, entries 6–21). All the tin complexes were tested and were found to be more active than their parent Schiff bases

Table 10. Synthesis of Schiff-Base-Containing Tin Complexes^a

entry	tin complex	microwave procedure		classical synthesis		ref
		time (min)	yield (%)	time (h)	yield (%)	
1	[Sn(79) ₂]	0.5	95	5		133
2	[Sn(93) ₂ Cl ₂]	5	96	n.d. ^a	n.d. ^a	332
3	[Sn(94) ₂ Cl ₂]	5	96	n.d. ^a	n.d. ^a	332
4	[Sn(95) ₂ Cl ₂]	5	90	n.d. ^a	n.d. ^a	332
5	[Sn(96) ₂ Cl ₂]	5	89	n.d. ^a	n.d. ^a	332
6	[Sn(CH ₃) ₂ (91)Cl]	8	84	15	76	339
7	[Sn(CH ₃) ₂ (91) ₂]	6	82	16	73	339
8	[Sn(CH ₃) ₂ (92)Cl]	5	87	14	71	339
9	[Sn(CH ₃) ₂ (92) ₂]	5	86	13	73	339
10	[Sn(CH ₃) ₂ (101)Cl]	4	85	16	72	339
11	[Sn(CH ₃) ₂ (101) ₂]	6	87	13	73	339
12	[Sn(CH ₃) ₂ (102)Cl]	6	85	14	69	340
13	[Sn(CH ₃) ₂ (102) ₂]	4	84	17	70	340
14	[Sn(CH ₃) ₂ (97)Cl]	3	82	15	75	340
15	[Sn(CH ₃) ₂ (97) ₂]	6	86	15	72	340
16	[Sn(CH ₃) ₂ (98)Cl]	5	89	14	70	340
17	[Sn(CH ₃) ₂ (98) ₂]	5	87	13	73	340
18	[Sn(CH ₃) ₂ (99)Cl]	4	85	16	71	340
19	[Sn(CH ₃) ₂ (99) ₂]	6	88	13	69	340
20	[Sn(CH ₃) ₂ (100)Cl]	6	80	14	74	340
21	[Sn(CH ₃) ₂ (100) ₂]	4	84	15	70	340

^aSee Figure 1 for the structure of ligands.

against several strains of bacteria (*Bacillus subtilis*(+), *Staphylococcus aureus* (+), *Pseudomonas aeruginosa* (-), and *Salmonella typhi* (-)) and fungi (*Penicillium crysogenes* and *Rhizoctonia phaseoli*). Antifertility activity in male albino rats was also interesting, reducing the motility and the sperm count irreversibly.

Similarly, microwave irradiation was applied in the synthesis of germanium complexes **610** featuring ketimine ligands starting from a solution of [GeClR₃] (R = Me and Ph) and ketamine **609** in methanol (Scheme 187).³⁴¹ Microwave

Scheme 187. Microwave-Assisted Synthesis of Schiff Base Germanium(IV) Complexes

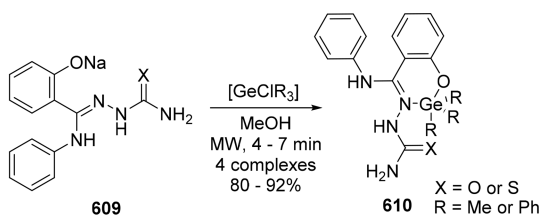

Scheme 188. Sonochemical Synthesis of Lead(II) Complexes of O-,N-Coordinating Ligand

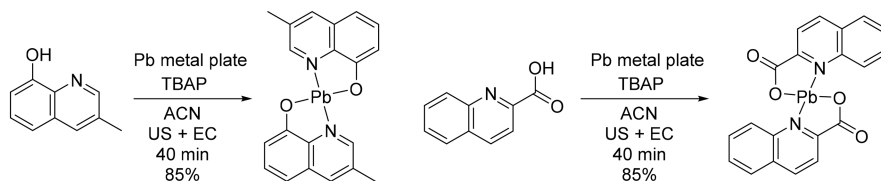

irradiation allowed the formation of the corresponding complexes in lower time and in higher yield (4–7 min, 80–92%) than under classical reflux conditions (12–15 h, 70–76%). These complexes showed moderate biological activity, however, higher than that displayed by the respective ligand, on selected fungi (*Alternaria alternata*, *Aspergillus niger*, *Fusarium oxysporum*, and *Macrophomina phaseolina*) and four bacteria (*Staphylococcus aureus*, *Klebsiella aerogenes*, *Escherichia coli*, and *Pseudomonas cepacicola*). Interestingly, the triphenylhydrazine carbothioamide germanium complex was highly effective as an insecticide with a LC₅₀ (lethal concentration required to result in death of 50% of a test population) of 210 mg/L.

14.3. Ultrasonic Bath for the Synthesis of Lead Complexes

Two nanostructured lead(II) complexes of quinolone-2-carboxylic acid **613**³⁴² and 2-methyl-8-hydroxyquinoline **611**³⁴³ were prepared by the Davarani group using either electrochemistry or sonoelectrochemistry (Scheme 188). Nanosized samples were obtained thanks to a combination of electrochemistry and powerful ultrasonic radiation (20 kHz–10 MHz). At the cathode, the acidic proton in quinoline was reduced into H₂, also yielding the anionic ligand, while oxidation of the Pb anode produced cationic Pb²⁺. It was proposed that the collapsing bubbles caused by ultrasound resulted in particles of high velocities that would push the nanoparticles to form nanospheres. Calcination of the resulting complex at 600 °C in air yielded PbO nanoparticles, which were found to be smaller than the PbO particles resulting from a calcination of the Pb(II) complex prepared through electrochemistry.

As already described above in the mechanochemical section, the CH₃NH₃PbI₃ perovskite has become an alternative candidate for future power generation from sunlight. To synthesize this complex, two similar methods were developed at approximately the same time using ultrasound irradiation. In the first one, addition of a solution of CH₃NH₃I into a homogeneous dispersion of PbI₂ in isopropanol (prepared using ultrasonic irradiation) resulted in the desired perovskite with a rod-like structure.³⁴⁴ In the second method, the addition of reagents was reversed, and the resulting reaction mixture was irradiated for 10–30 min, yielding ultrafine polygonal nanoparticles (10–40 nm).³⁴⁵

15. GROUP 15: SYNTHESSES BY BALL MILLING

Similarly to aluminum complexes (Scheme 184), grinding trihalides of As and Sb with allyl anion **599** led to the formation of tris(TMS-allyl)metal complexes **615** in only 5 min and in good yields (Scheme 189, reaction A).³⁴⁶ Unfortunately, similar synthesis using bismuth(III) halide salt led to a dark gray powder, which consisted of bismuth metal and hexadiene as the only identifiable products. An alternative strategy was to mill tris(allyl)aluminum complex **600** with

Scheme 189. Mechanochemical Synthesis of Tris(TMS-allyl)metal Complexes

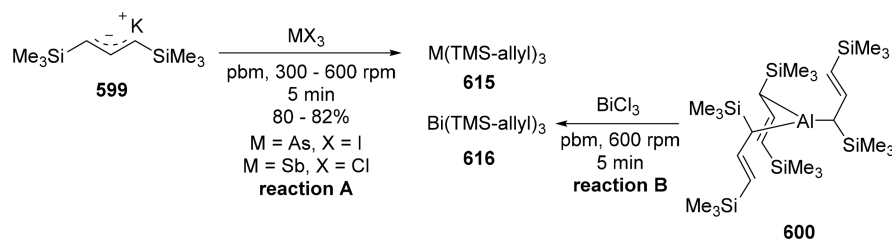

BiCl_3 in a planetary ball mill for 5 min. The desired tris(TMS-allyl)Bi complex **616** was formed albeit as a mixture with unidentified byproducts (Scheme 189, reaction B). In addition, this bismuth complex was found to be light-sensitive and thermally unstable and had completely decomposed within 3 days at room temperature. Complexes were isolated as a mixture of diastereoisomers of C_1 and C_3 symmetry, with the ratio of C_1/C_3 dependent on the metal. Notably, using appropriate conditions (solvent and reagents), all complexes formed with longer reaction times (2–72 h) and in lower yields (64–80%) in solution. The bismuth complex described above was not the first bismuth complex to be synthesized by ball milling. Indeed, the synthesis of various *ortho*-functionalized triarylbismuthanes by ball milling was reported in 2003 by the Suzuki group.³⁴⁷ In contrast to the conventional solution method, this ball-milling approach was simple and efficient and produced the complex in satisfactory yields.

16. LANTHANIDE

16.1. Mechanochemical Approach

Inspired by the original synthesis of $[\text{Sm}(\text{Cp}^*)_3]$, analogous lanthanide complexes were prepared from Ln^{3+} precursors (La, Ce, Pr, Nd, and Gd) in benzene or in toluene. Starting from heavy lanthanides, Woen et al. described the synthesis of the unknown $[\text{Ln}(\text{Cp}^*)_3]$ ($\text{Ln} = \text{Tb}, \text{Dy}, \text{Ho}, \text{and Er}$) complexes **618**.³⁴⁸ Since steric bulk in $[\text{Ln}(\text{Cp}^*)_3]$ with small metallic centers may result in arene (toluene, benzene) metalation, a solvent-free method was envisioned. Syntheses were performed in a disperser mill containing 40 stainless steel balls by reacting KC_5Me_5 with lanthanide $[\text{Ln}(\text{Cp}^*)_2(\mu\text{-Ph})_2\text{BPh}_2]$ precursors **617**, which contained a labile tetraphenylborate counteranion (Scheme 190). XRD analysis of the resulting complexes

Scheme 190. Syntheses of Lanthanide Complexes Using a Disperser Mill

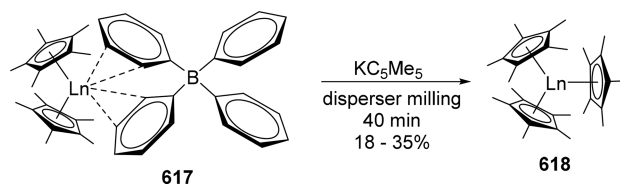

showed a tilt of a Cp^* ring away from the metal center. This tilt increases as the ionic radius of the metal decreases and was proposed as a metric to evaluate the ability of a $[\text{Ln}(\text{Cp}^*)_3]$ complex to achieve C–H activation of arenes.

16.2. Microwave Syntheses

Kumari et al. described the solvent-free synthesis of different lanthanide complexes ($\text{Ln} = \text{La}, \text{Ce}, \text{Pr}, \text{Nd}, \text{S}, \text{Eu}, \text{and Gd}$) featuring (2-(*N*-salicylideneamino)-3-carboxyethyl-4,5-dime-

thylthiophene) **619**³⁴⁹ and [(2-hydroxybenzaldehyde)-3-isatin]bishydrazone) **620**³⁵⁰ Schiff base ligands under microwave irradiation. The ligand and metal were first ground with a mortar and pestle with ethanol, and the pH was adjusted to be between 6.0 and 6.5. The solvent was then evaporated, and the resulting reaction mixture was irradiated for 10–15 min to produce complexes **621** and **622** in 60–70% yield (Scheme 191). Lanthanide complexes exhibited greater *in vitro* antibacterial activity than their respective ligands against *Escherichia coli*, *Staphylococcus aureus*, *Bacillus megaterium*, and *Vibrio cholera*. Interestingly, the $[\text{La}(\text{619})_2\text{Cl}_3]$ complex was subjected to transesterification in alcohol (methanol and *n*-propanol), although not through microwave activation, giving rise to two new complexes. Notably, antifungal activity was demonstrated to be dependent on the nature of the metal ion, the nature of the ligand, the coordinating sites, the geometry of the complex, the hydrophilicity, the lipophilicity, the presence of coligands, and also steric and pharmacokinetic factors.

$[\text{Tb}(\text{acac})_3(\text{dmdpphen})]$ **624** (dmdpphen **623** = 2,9-dimethyl-4,7-diphenyl-1,10-phenanthroline), a complex exhibiting intense green luminescence, was synthesized under microwave irradiation. A solution of both ligands and terbium(III) nitrate in ethanol was heated under microwave irradiation for 12 min (Scheme 192).³⁵¹ The resulting terbium complex **624**, which demonstrated good thermal stability and high green luminescence, could be used in functional materials such as OLEDs.

In 2013, the Zhou group described the synthesis of two europium complexes featuring cinnamate ligands, $[\text{Eu}(\text{phen})(\text{C}_6\text{H}_5\text{CH}=\text{CHCOO})_3]$ **625**³⁵² and $[\text{Eu}(\text{bipy})(\text{C}_6\text{H}_5\text{CH}=\text{CHCOO})_3]$ **626** (Scheme 193).³⁵³ Both ligands, bipyridine and cinnamic acid, were dissolved in EtOH and added to a solution of europium nitrate, and the pH of the resulting solution was adjusted to 6–7 using a 6 M NH_3 aqueous solution. Subsequently, the reaction mixture was irradiated for 20–24 min in a microwave oven. Both complexes exhibited high luminescence at 614 nm for **625** and at 592, 615, and 697 nm for **626**.

17. CONCLUSION

The synthesis of organometallic complexes using enabling technologies has already attracted a lot of attention, and this field still has a bright future. Until recently, a special focus was placed on the synthesis of discrete metal complexes featuring palladium, copper, or iron as the metal center, mostly because of their catalytic properties. Few metals have been investigated until now, for example, titanium, osmium, or iridium. The aim of this review was to provide the chemistry community with an overview of the possibilities, opportunities, and benefits of using enabling technologies. Most importantly, by underlying understudied areas, it opens perspectives for the future of

Scheme 191. Microwave-Assisted Synthesis of Lanthanide Complexes

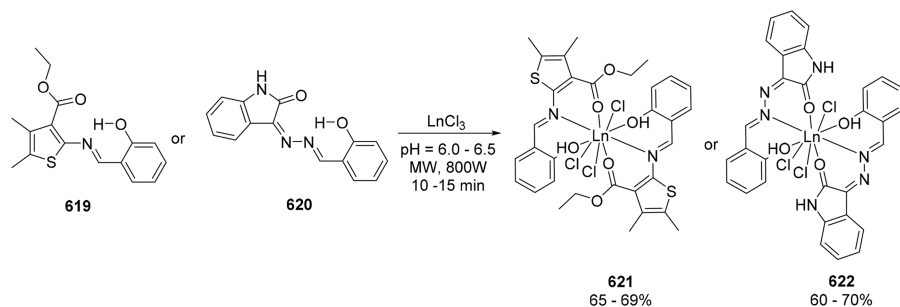

Scheme 192. Microwave-Assisted Synthesis of a Highly Luminescent Terbium(III) Complex

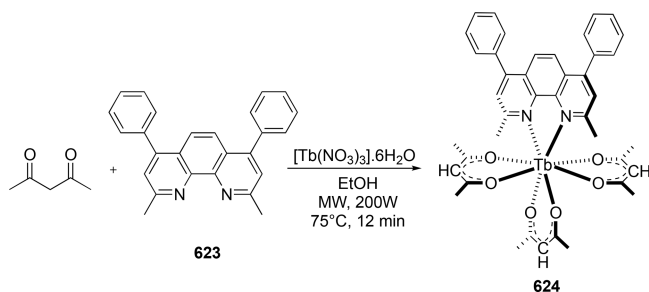

Scheme 193. Synthesis of Europium Complexes with Cinnamic Acid

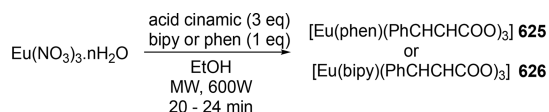

organometallic synthesis. It is clear that the habits of chemists, persistent for more than one century, in using a classical flask with a stirring plate need to be modified. It is now time to evolve to perform chemistry faster and more efficiently.

Microwave activation, mechanochemistry, ultrasonic activation, photochemistry, and continuous flow chemistry clearly bring new ways of thinking about chemistry and provide new opportunities to access compounds, which would not be reachable in any other way. Microwave equipment, mostly used to reduce reaction times while increasing pressure and temperature, is widely available in laboratories and could be used more systematically.

Mechanochemistry, mostly through ball milling, is becoming more and more prevalent. In this review, most of the examples were performed using a mortar and pestle, the simplest equipment available. This technology still has a bright future since only specialized research groups are currently equipped, and among them few are taking organometallic synthesis into account.

Ultrasound is less commonly used in organometallic synthesis. This is probably because this activation method is not widespread. Nevertheless, this approach is highly interesting in terms of understanding how cavitation can promote reactions.

Photochemistry has been used mostly for ligand exchange or modification, with a wide range of metals. This activation is becoming more and more established in organic chemistry, notably with photoredox catalysis, but its use in organometallic synthesis or modification is still underused. There is no doubt

that, with the development of photochemistry in general, the applications in organometallic synthesis will increase.

Finally, continuous flow chemistry is highly interesting in terms of safety, scalability, and reactivity. However, it is still in its infancy for organometallic synthesis, with very rare examples of discrete metal complexes synthesized in a continuous flow process. Flow chemistry was initially expensive, which caused reluctance in researchers to use this technique; the equipment has, however, recently become much more affordable and modular. The benefits in performing flow chemistry should motivate organometallic chemists to turn their attention to this novel technology.

It is also important to add that the technologies presented herein mostly contribute to one of the most important topics of the 21st century, namely, respect for the environment. Reduction of reaction times, of the quantity of solvent used, and of the formation of side products and safer procedures are all qualities that fit the 12 principles of Green Chemistry developed in 1992 by Anastas and Warner. There is thus no doubt that enabling technologies will be part of the future of organometallic synthesis.

AUTHOR INFORMATION

Corresponding Authors

*E-mail: xavier.bantreil@umontpellier.fr.

*E-mail: thomas-xavier.metro@umontpellier.fr.

*E-mail: frederic.lamaty@umontpellier.fr.

ORCID

Xavier Bantreil: 0000-0002-2676-6851

Thomas-Xavier Métro: 0000-0003-2280-3595

Jean Martinez: 0000-0002-4551-4254

Frédéric Lamaty: 0000-0003-2213-9276

Notes

The authors declare no competing financial interest.

Biographies

Audrey Beillard graduated with a degree in fine and industrial organic chemistry from the Ecole Nationale Supérieure d'Ingénieur de Caen (ENSICAEN) in 2014. The same year, she also obtained a Master's degree in organic synthesis at the University of Caen. She received her Ph.D. in biomolecular engineering from the University of Montpellier (Institute of Biomolecules Max Mousseron) in 2017, under the direction of Dr. Frédéric Lamaty, on the mechanochemical synthesis of NHC-metal complexes. In 2018, she joined the Commissariat à l'Énergie Atomique et aux Énergies Alternatives (CEA) of Marcoule in France as a postdoctoral researcher, where she worked on the synthesis of new extractants for liquid-liquid extraction.

Xavier Bantreil graduated as a chemical engineer in 2004 from Ecole Nationale Supérieure de Chimie de Paris (ENSCP-ParisTech, France). He then received a Master's degree and later his Ph.D. in 2008 from Université Pierre et Marie Curie (UPMC - Paris VI) under the supervision of Prof. Giovanni Poli, working on palladium-catalyzed reactions. During his doctorate, he spent two months in the group of Prof. Paul S. Pregosin at ETH Zürich working on the isolation of π -allyl palladium complexes. He then took up a postdoctoral position in the group of Profs. Steven P. Nolan and Catherine S. J. Cazin and spent three months at the ICIQ in Tarragona (Spain) and then 19 months at the University of St Andrews (UK), working on the synthesis of new catalysts for olefin metathesis. He then returned to France for a one-year postdoctoral position in Dr. Philippe Belmont's research group at Institut Curie (Paris, France) working on the silver-catalyzed synthesis of quinoline derivatives. In September 2011, he joined Dr. Frédéric Lamaty's group in Montpellier at the Institut des Biomolécules Max Mousseron (IBMM) as assistant professor. In 2017, he obtained his habilitation (HDR). His research topics are focused on catalysis, organometallic synthesis, and organic and green chemistry, with a special emphasis on heterocycles and organometallics and the use of alternative solvents and enabling technologies (microwaves, ball milling, continuous flow).

After having spent one year at Atofina Chemicals, USA, working on organic peroxide safety process research, Thomas-Xavier Métro graduated with both a Master's degree in general chemistry from the Ecole Supérieure de Chimie Organique et Minérale and a Master's degree in medicinal chemistry from the Université de Pharmacie de Montpellier in 2004. He completed his Ph.D. in organic chemistry in 2008 at the Université Pierre et Marie Curie (Paris) under the supervision of Dr. Domingo Gomez Pardo and Prof. Janine Cossy, working on the rearrangement of amino alcohols and its application to the synthesis of (*S,S*)-reboxetine and SSR241586. After a first postdoc in process R&D at Sanofi Chimie in Sisoner and a second postdoc in medicinal chemistry at Sanofi-Aventis R&D in Montpellier, he joined the CNRS in 2011 as a Chargé de Recherche in the Green Chemistry and Enabling Technologies Team at the Max Mousseron Institute for Biomolecules (IBMM; Montpellier). Since then, his research activity has mainly been based on the development of solvent-free/solvent-less methodologies, aiming to provide the organic chemist with a set of solutions to reduce the environmental impact of chemical enterprise.

Jean Martinez received his Ph.D. degree in organic chemistry from the University of Montpellier at the Ecole Nationale Supérieure de Chimie de Montpellier under the direction of Prof. F. Winteritz. He completed his chemical education as a postdoctoral fellow with Dr. E. Bricas, Orsay, University of Paris Sud, and then with Prof. M. Bodanszky, Case Western Reserve University, Cleveland, OH. Back in France, he was recruited as a CNRS Research Associate and then as a Research Director in Montpellier. Pursuing investigations at the interface of chemistry and biology, he joined the University of Montpellier and was appointed Full Professor in both organic chemistry and medicinal chemistry. He became the head of a succession of research laboratories in Montpellier including the Laboratory of Chemistry and Pharmacology of Biologically Interesting Molecules, the Laboratory of Amino Acids, Peptides and Proteins. He founded the Institute of Biomolecules Max Mousseron in 2007 and acted as the director until December 2014. In 2015, he remained in the same institute, taking up the position of head of the Department of Amino Acids, Peptides and Proteins. His current research interests focus on peptide chemistry, stereoselective syntheses of biomolecules, design and production of original biomaterials, green chemistry, and

the biology and pharmacology of neuropeptides of the gastrointestinal tract.

Frédéric Lamaty graduated as a chemical engineer in 1988 from the Ecole Supérieure de Chimie Industrielle de Lyon (ESCIL now ESCPE, France). In 1992, he received his Ph.D. degree from Purdue University (West Lafayette, IN, USA) under the supervision of Professor Ei-ichi Negishi in the field of Pd-catalyzed cyclizations. He then joined the group of Professor Marc Julia at the Ecole Normale Supérieure in Paris as a Rhône-Poulenc postdoctoral fellow to work on the synthesis of Vitamin A. In 1994, he obtained a permanent position at the Centre National de la Recherche Scientifique (CNRS) in Montpellier and is currently working as Directeur de Recherche at the Max Mousseron Institute for Biomolecules (IBMM). Since 2011, he has headed the Green Chemistry and Enabling Technologies team (www.greenchem.um2.fr) at IBMM. His research topics in the area of catalysis, organic, and green chemistry are devoted to the synthesis of amino acids, peptides, heterocycles, and organometallics, the use of alternative solvents (PEG, PEG-IL, glycerol, water), and enabling technologies (microwaves, ultrasound, ball milling, continuous flow) with an emphasis on mechanochemistry. In 2011 he was awarded the Prix des Techniques Innovantes pour l'Environnement ADEME-Pollutec for his activity in peptide mechanosynthesis under solvent-free conditions.

ACKNOWLEDGMENTS

The Université de Montpellier, Centre Nationale de la Recherche Scientifique (CNRS), French Ministry of Higher Education and Research (grant to A. B.), and Agence Nationale de la Recherche (grant no. ANR-16-CE07-0009-01 for X. B.) are acknowledged for funding.

LIST OF ABBREVIATIONS

% de	percentage diastereomeric excess
9-atc	9-anthracenecarboxylic acid
acac	acetylacetonate
ACIM	4-imino-2-pentanone
ACN	acetonitrile
BIAN	bis(arylimino)acenaphthene
Bipy	bipyridine
Bppz	2,3-bis(2-pyridyl)pyrazine
bqn	2,2'-biquinoline
CEAP	4-[<i>N,N</i> -bis(2-cyanoethyl)amino]pyridine
CF	continuous flow
COD	cycloocta-1,5-diene
Cp	cyclopentadienyl
Cp'	methylcyclopentadienyl
Cp*	pentamethylcyclopentadienyl
Cp [^]	"Cp roof ligand" 2,4-di- <i>tert</i> -butyl-3-(2,2-dimethylpropyl)-1-methoxycyclopentadienyl
DBU	1,8-diazabicyclo[5.4.0]undec-7-ene
dcby	4,4'-dicarboxy-2,2'-bipyridine
DCM	dichloromethane
dcmb	4,4'-dimethoxycarbonyl-2,2'-bipyridine
debpy	4,4'-diethoxycarbonyl-2,2'-bipyridine
deeb	4,4'-diethylester-2,2'-bipyridine
detu	<i>N,N'</i> -diethylthiourea
diag	diagonal
DIOP	2,3- <i>O</i> -isopropylidene-2,3-dihydroxy-1,4-bis-(diphenylphosphino)butane
dmbpy	4,4'-dimethyl-2,2'-bipyridine
dmdpphen	2,9-dimethyl-4,7-diphenyl-1,10-phenanthroline
DME	1,2-dimethoxyethane

DMF	<i>N,N</i> -dimethylformamide	phbn	3-phenylbenzo[<i>b</i>][1,6]naphthyridine
DMSO	dimethyl sulfoxide	PHE	passive heating element
DNA	desoxyribonucleic acid	Phen	1,10-phenanthroline
dpbpy	4,4'-diphenyl-2,2'-bipyridine	phphen	5-phenyl-1,10-phenanthroline
dpephos	bis[(2-diphenylphosphino)phenyl] ether	phq	2-phenyl-1-quinoline
DPM	2,2,6,6-tetramethyl-3,5-heptadionato	pip	piperidine
dppb	1,4-bis(diphenylphosphino)butane	PMMA	poly(methyl methacrylate)
dppe	1,2-bis(diphenylphosphino)ethane	PMP	<i>para</i> -methoxyphenyl
dppf	1,1'-bis(diphenylphosphino)ferrocene	ppfp ₃	tris(pentafluorophenyl)phosphine
dpphen	4,7-diphenyl-1,10-phenanthroline	PS	polystyrene
dppm	bis(diphenylphosphino)methane	PTA	1,3,5-triaza-7-phosphaadamantane
dppp	1,3-bis(diphenylphosphino)propane	PTFE	polytetrafluoroethylene
dpypp	2,2'-(phenylphosphinediyl)dipyridine	PXRD	powder X-ray diffraction
dqp	2,6-di(quinolin-8-yl)pyridine	Py	pyridine
dqp-NH ₂	2,6-di(quinolin-8-yl)-4-aminopyridine	pz	pyrazole
dqpCO ₂ Et	4-ethyl-carboxy-2,6-di(quinolin-8-yl)pyridine	pzpy	ethyl[3-(2-pyridyl)-1-pyrazolyl]acetate
<i>E. coli</i>	<i>Escherichia coli</i>	Q	8-hydroxyquinolinate
en	1,2-ethylenediamine	saoH ₂	salicylaldoxime
ER	estrogen receptor	SEM	scanning electron microscopy
ettu	<i>N</i> -ethylthiourea	SIMes·HCl	1,3-bis(2,4,6-trimethylphenyl)-1 <i>H</i> -imidazolium chloride
etu	ethylenethiourea	SIPr·HCl	1,3-bis(2,6-diisopropylphenyl)-1 <i>H</i> -imidazolium chloride
<i>fac</i> -	facial	SOD	superoxide dismutase
Fc	ferrocenyl	SQ	semiquinone
H ₂ cit	dihydrogencitrate	tbbpy	4,4'-di- <i>tert</i> -butyl-2,2'-bipyridine
H ₂ MSAP	<i>N</i> -3-methoxysalicylidene-2-amino-3-hydroxypyridine	<i>t</i> BuXPhos	di- <i>tert</i> -butyl(2',4',6'-triisopropylbiphenyl-2-yl)-phosphine
HHA	hippuric acid	TCB	1,2,4-trichlorobenzene
Him	imidazole	tctpy	tricarboxylterpyridine
Hpz	pyrazole	TEAB	tetraethylammonium bromide
IC ₅₀	half maximal inhibitory concentration	terpy	2,2',2''-terpyridine
IEt ₂ Me ₂	1,3-diethyl-4,5-dimethylimidazol-2-ylidene	THF	tetrahydrofuran
IMes·HCl	1,3-bis(2,4,6-trimethylphenyl)-1 <i>H</i> -imidazolium chloride	TIPSA	triisopropylsilylacetylene
Ind	indene	tipsepd	((triisopropylsilyl)ethynyl)-2,4-pentanedionate ion
IPr	1,2-bis(2,6-diisopropylphenyl)imidazol-2-ylidene	TMEDA	<i>N,N,N',N'</i> -tetramethylethylenediamine
IPr·HCl	1,3-bis(2,6-diisopropylphenyl)-1 <i>H</i> -imidazolium chloride	TMP	trimethoprim (5-(3,4,5-trimethoxybenzyl)-pyrimidine-2,4-diamine)
IR	infrared	TMS	trimethylsilyl
JohnPhos	di(<i>tert</i> -butyl)(1,1'-biphenyl-2-yl)-phosphine	tosyl	4-methylbenzene-1-sulfonyl
KbpzB	potassium bispyrazolyl borate	Tp	hydrido-tris(pyrazolyl)borate
LAG	liquid-assisted grinding	TPBP	1,3,5-tris(2-(pyridin-4-yl)vinyl)benzene
<i>lat</i> -	lateral	tterpy	4'-(4-tolyl)-2,2':6',2''-terpyridine
LED	light-emitting diode	tu	thiourea
LLCT	ligand to ligand charge transfer	US	ultrasound
MAS	magic-angle spinning	UV	ultraviolet
<i>mer</i> -	meridional	vbm	vibratory ball mill
MLCT	metal to ligand charge transfer	W	Watt
morph	morpholine		
MTBE	methyl <i>tert</i> -butyl ether		
MW	microwave		
NBS	<i>N</i> -bromosuccinimide		
NEM	<i>N</i> -ethylmorpholine		
NHC	<i>N</i> -heterocyclic carbene		
NIS	<i>N</i> -iodosuccinimide		
NMI	<i>N</i> -methylimidazole		
NMR	nuclear magnetic resonance		
nosyl	4-nitrobenzene-1-sulfonyl		
OLED	organic light-emitting diode		
pbm	planetary ball mill		
PEG	polyethylene glycol		
PEPPSI	pyridine-enhanced precatalyst preparation stabilization and initiation		
pfm	perfluorobutyramide		

REFERENCES

- (1) Abe, T.; Miyazawa, A.; Kawanishi, Y.; Konno, H. Microwave-Assisted Synthesis of Metal Complexes. *Mini-Rev. Org. Chem.* **2011**, *8*, 315–333.
- (2) Rodríguez, A.; García-Vázquez, J. A. The Use Of Sacrificial Anodes For The Electrochemical Synthesis Of Metallic Complexes. *Coord. Chem. Rev.* **2015**, *303*, 42–85.
- (3) Hoffmann, N. Photochemical Reactions as Key Steps in Organic Synthesis. *Chem. Rev.* **2008**, *108*, 1052–1103.
- (4) Tan, D.; Friščić, T. Mechanochemistry for Organic Chemists: An Update. *Eur. J. Org. Chem.* **2018**, *2018*, 18–33.
- (5) Ley, S. V.; Fitzpatrick, D. E.; Ingham, R. J.; Myers, R. M. Organic Synthesis: March Of The Machines. *Angew. Chem., Int. Ed.* **2015**, *54*, 3449–3464.

- (6) Bruijninx, P. C. A.; Sadler, P. J. New Trends For Metal Complexes With Anticancer Activity. *Curr. Opin. Chem. Biol.* **2008**, *12*, 197–206.
- (7) Zhang, C. X.; Lippard, S. J. New Metal Complexes As Potential Therapeutics. *Curr. Opin. Chem. Biol.* **2003**, *7*, 481–489.
- (8) Meier-Menches, S. M.; Gerner, C.; Berger, W.; Hartinger, C. G.; Keppler, B. K. Structure-Activity Relationships For Ruthenium And Osmium Anticancer Agents - Towards Clinical Development. *Chem. Soc. Rev.* **2018**, *47*, 909–928.
- (9) Chen, Z.-F.; Orvig, C.; Liang, H. Multi-Target Metal-Based Anticancer Agents. *Curr. Top. Med. Chem.* **2017**, *17*, 3131–3145.
- (10) Patanjali, P.; Kumar, R.; Sourabh; Kumar, A.; Chaudhary, P.; Singh, R. Reviewing Gold(III) Complexes As Effective Biological Operators. *Main Group Chem.* **2018**, *17*, 35–52.
- (11) Mital, M.; Ziora, Z. Biological Applications Of Ru(II) Polypyridyl Complexes. *Coord. Chem. Rev.* **2018**, *375*, 434–458.
- (12) Hanif, M.; Hartinger, C. G. Anticancer Metallo drugs: Where Is The Next Cisplatin? *Future Med. Chem.* **2018**, *10*, 615–617.
- (13) Popolin, C. P.; Cominetti, M. R. A Review of Ruthenium Complexes Activities on Breast Cancer Cells. *Mini-Rev. Med. Chem.* **2017**, *17*, 1435–1441.
- (14) Leon, I. E.; Cadavid-Vargas, J. F.; Di Virgilio, A. L.; Etcheverry, S. B. Vanadium, Ruthenium and Copper Compounds: A New Class of Nonplatinum Metallo drugs with Anticancer Activity. *Curr. Med. Chem.* **2017**, *24*, 112–148.
- (15) Ali, B.; Iqbal, M. A. Coordination Complexes of Manganese and Their Biomedical Applications. *ChemistrySelect* **2017**, *2*, 1586–1604.
- (16) Jurowska, A.; Jurowski, K.; Szklarzewicz, J.; Buszewski, B.; Kalenik, T.; Piekoszewski, W. Molybdenum Metallo pharmaceuticals Candidate Compounds - The "Renaissance" of Molybdenum Metallo drugs? *Curr. Med. Chem.* **2016**, *23*, 3322–3342.
- (17) Bodio, E.; Le Gendre, P.; Denat, F.; Goze, C. Development Of Trackable Anticancer Agents Based On Metal Complexes. *Adv. Inorg. Chem.* **2016**, *68*, 253–299.
- (18) James, S. L.; Adams, C. J.; Bolm, C.; Braga, D.; Collier, P.; Friščić, T.; Grepioni, F.; Harris, K. D. M.; Hyett, G.; Jones, W.; Krebs, A.; Mack, J.; Maini, L.; Orpen, A. G.; Parkin, I. P.; Shearouse, W. C.; Steed, J. W.; Waddell, D. C. Mechanochemistry: Opportunities For New And Cleaner Synthesis. *Chem. Soc. Rev.* **2012**, *41*, 413–447.
- (19) Bowmaker, G. A. Solvent-Assisted Mechanochemistry. *Chem. Commun.* **2013**, *49*, 334–348.
- (20) Hernández, J. G.; Bolm, C. Altering Product Selectivity by Mechanochemistry. *J. Org. Chem.* **2017**, *82*, 4007–4019.
- (21) Métro, T.-X.; Bonnamour, J.; Reidon, T.; Duprez, A.; Sarpoulet, J.; Martínez, J.; Lamaty, F. Comprehensive Study of the Organic-Solvent-Free CDI-Mediated Acylation of Various Nucleophiles by Mechanochemistry. *Chem. - Eur. J.* **2015**, *21*, 12787–12796.
- (22) Métro, T.-X.; Bonnamour, J.; Reidon, T.; Sarpoulet, J.; Martínez, J.; Lamaty, F. Mechanochemistry Of Amides In The Total Absence Of Organic Solvent From Reaction To Product Recovery. *Chem. Commun.* **2012**, *48*, 11781–11783.
- (23) Kaupp, G. Waste-Free Large-Scale Syntheses Without Auxiliaries For Sustainable Production Omitting Purifying Workup. *CrystEngComm* **2006**, *8*, 794–804.
- (24) Kaupp, G.; Schmeyer, J.; Naimi-Jamal, M. R.; Zoz, H.; Ren, H. Reactive Milling With The Simoloyer®: Environmentally Benign Quantitative Reactions Without Solvents And Wastes. *Chem. Eng. Sci.* **2002**, *57*, 763–765.
- (25) https://www.equipnet.com/mp_data/media/2008951251_185006_1.pdf (accessed May 27, 2018).
- (26) Crawford, D. E. Extrusion – Back To The Future: Using An Established Technique To Reform Automated Chemical Synthesis. *Beilstein J. Org. Chem.* **2017**, *13*, 65–75.
- (27) Loupy, A. Microwaves in Organic Synthesis. In *Microwaves in Organic Synthesis*; Wiley-VCH, 2006.
- (28) Rathj, A. K.; Gawande, M. B.; Zboril, R.; Varma, R. S. Microwave-Assisted Synthesis - Catalytic Applications In Aqueous Media. *Coord. Chem. Rev.* **2015**, *291*, 68–94.
- (29) de la Hoz, A.; Diaz-Ortiz, A.; Moreno, A. Activation Of Organic Reactions By Microwaves. *Adv. Org. Synth.* **2005**, *1*, 119–171.
- (30) Loupy, A.; Perreux, L.; Liagre, M.; Burle, K.; Moneuse, M. Reactivity And Selectivity Under Microwaves In Organic Chemistry. Relation With Medium Effects And Reaction Mechanisms. *Pure Appl. Chem.* **2001**, *73*, 161–166.
- (31) Loupy, A.; Petit, A.; Hamelin, J.; Texier-Boullet, F.; Jacquault, P.; Mathe, D. New Solvent-Free Organic Synthesis Using Focused Microwaves. *Synthesis* **1998**, 1213–1234.
- (32) Obermayer, D.; Gutmann, B.; Kappe, O. C. Microwave Chemistry in Silicon Carbide Reaction Vials: Separating Thermal from Nonthermal Effects. *Angew. Chem., Int. Ed.* **2009**, *48*, 8321–8324.
- (33) de la Hoz, A.; Díaz-Ortiz, A.; Moreno, A. Microwaves In Organic Synthesis. Thermal And Non-Thermal Microwave Effects. *Chem. Soc. Rev.* **2005**, *34*, 164–178.
- (34) Gutmann, B.; Schwan, A. M.; Reichart, B.; Gspan, C.; Hofer, F.; Kappe, O. C. Activation and Deactivation of a Chemical Transformation by an Electromagnetic Field: Evidence for Specific Microwave Effects in the Formation of Grignard Reagents. *Angew. Chem., Int. Ed.* **2011**, *50*, 7636–7640.
- (35) Suslick, K. S. Sonochemistry. *Science* **1990**, *247*, 1439–1445.
- (36) Suslick, K. S.; Flannigan, D. J. Inside a Collapsing Bubble: Sonoluminescence and the Conditions During Cavitation. *Annu. Rev. Phys. Chem.* **2008**, *59*, 659–683.
- (37) Flint, E. B.; Suslick, K. S. The Temperature of Cavitation. *Science* **1991**, *253*, 1397–1399.
- (38) Grieser, F. *Sonochemistry and the acoustic bubble*; Elsevier: Amsterdam; Boston, 2015; p xvi, 282 pages.
- (39) Mason, T. J. *Practical sonochemistry: user's guide to applications in chemistry and chemical engineering*; E. Horwood: New York, 1991; p 186.
- (40) Mason, T. J.; Peters, D. *Practical Sonochemistry: Power Ultrasound Uses and Applications*; Elsevier Science: 2002.
- (41) Mason, T. J. Ultrasound In Synthetic Organic Chemistry. *Chem. Soc. Rev.* **1997**, *26*, 443–451.
- (42) Glusac, K. What Has Light Ever Done For Chemistry? *Nat. Chem.* **2016**, *8*, 734.
- (43) Turro, N. J.; Ramamurthy, V.; Scaiano, J. C. *Modern Molecular Photochemistry Of Organic Molecules*; University Science Books: Sausalito, Calif, 2010; p xxxiii, 1084 p.
- (44) Turro, N. J.; Ramamurthy, V.; Scaiano, J. C. *Principles Of Molecular Photochemistry: An Introduction*; University Science Books: Sausalito, Calif, 2009; p xxi, 495 p.
- (45) Klán, P.; Wirz, J. *Photochemistry Of Organic Compounds: From Concepts To Practice*; Wiley: Chichester, West Sussex, U.K., 2009; p xviii, 563 p.
- (46) Braun, A. M.; Maurette, M.-T. r. s.; Oliveros, E. *Photochemical Technology*; Wiley: Chichester, West Sussex, England; New York, 1991; p xx, 559 p.
- (47) <http://www.edisontechcenter.org/MercuryVaporLamps.html> (accessed April 27, 2018).
- (48) Gutmann, B.; Cantillo, D.; Kappe, C. O. Continuous-Flow Technology—A Tool for the Safe Manufacturing of Active Pharmaceutical Ingredients. *Angew. Chem., Int. Ed.* **2015**, *54*, 6688–6728.
- (49) Damm, M.; Glasnov, T. N.; Kappe, C. O. Translating High-Temperature Microwave Chemistry to Scalable Continuous Flow Processes. *Org. Process Res. Dev.* **2010**, *14*, 215–224.
- (50) Movsisyan, M.; Delbeke, E. I. P.; Berton, J. K. E. T.; Battilocchio, C.; Ley, S. V.; Stevens, C. V. Taming Hazardous Chemistry By Continuous Flow Technology. *Chem. Soc. Rev.* **2016**, *45*, 4892–4928.
- (51) Fukuyama, T.; Chiba, H.; Kuroda, H.; Takigawa, T.; Kayano, A.; Tagami, K. Application of Continuous Flow for DIBAL-H Reduction and *n*-BuLi Mediated Coupling Reaction in the Synthesis of Eribulin Mesylate. *Org. Process Res. Dev.* **2016**, *20*, 503–509.

- (52) Amara, Z.; Streng, E. S.; Skilton, R. A.; Jin, J.; George, M. W.; Poliakov, M. Automated Serendipity with Self-Optimizing Continuous-Flow Reactors. *Eur. J. Org. Chem.* **2015**, 2015, 6141–6145.
- (53) Hsieh, H.-W.; Coley, C. W.; Baumgartner, L. M.; Jensen, K. F.; Robinson, R. I. Photoredox Iridium–Nickel Dual-Catalyzed Decarboxylative Arylation Cross-Coupling: From Batch to Continuous Flow via Self-Optimizing Segmented Flow Reactor. *Org. Process Res. Dev.* **2018**, 22, 542–550.
- (54) Brzozowski, M.; O'Brien, M.; Ley, S. V.; Polyzos, A. Flow Chemistry: Intelligent Processing of Gas-Liquid Transformations Using a Tube-in-Tube Reactor. *Acc. Chem. Res.* **2015**, 48, 349–362.
- (55) Britton, J.; Jamison, T. F. The Assembly And Use Of Continuous Flow Systems For Chemical Synthesis. *Nat. Protoc.* **2017**, 12, 2423–2446.
- (56) Skilton, R. A.; Bourne, R. A.; Amara, Z.; Horvath, R.; Jin, J.; Scully, M. J.; Streng, E.; Tang, S. L. Y.; Summers, P. A.; Wang, J.; Pérez, E.; Asfaw, N.; Aydos, G. L. P.; Dupont, J.; Comak, G.; George, M. W.; Poliakov, M. Remote-Controlled Experiments With Cloud Chemistry. *Nat. Chem.* **2015**, 7, 1–5.
- (57) Dabirmanesh, Q.; Roberts, R. M. G. The Application Of Microwave Dielectric Heating To The Synthesis Of Arene-Metal Complexes. Synthesis Of $[(\eta\text{-arene})(\text{CO})_3\text{Mn}]\text{PF}_6$ Complexes And $[(\eta\text{-arene})(\eta\text{-cyclopentadienyl})\text{Fe}][\text{PF}_6]$ Complexes With Triphenylphosphine, Tert-Butylbenzenes And A Sterically Hindered Phenol As Arene Ligands. *J. Organomet. Chem.* **1997**, 542, 99–103.
- (58) Knochel, P.; Gavryushin, A.; Krasovskiy, A.; Leuser, H., 9.03 - Magnesium. In *Comprehensive Organometallic Chemistry III*; Mingos, D. M. P., Crabtree, R. H., Eds.; Elsevier: Oxford, 2007; pp 31–79.
- (59) Cravotto, G.; Procopio, A.; Oliverio, M.; Orio, L.; Carnaroglio, D. Simple Sonochemical Protocols For Fast And Reproducible Grignard Reactions. *Green Chem.* **2011**, 13, 2806–2809.
- (60) Harrowfield, J. M.; Hart, R. J.; Whitaker, C. R. Magnesium And Aromatics: Mechanically-Induced Grignard And Mcmurry Reactions. *Aust. J. Chem.* **2001**, 54, 423–425.
- (61) van de Kruijs, B. H. P.; Dressen, M. H. C. L.; Meuldijk, J.; Vekemans, J. A. J. M.; Hulshof, L. A. Microwave-Induced Electrostatic Etching: Generation Of Highly Reactive Magnesium For Application In Grignard Reagent Formation. *Org. Biomol. Chem.* **2010**, 8, 1688–1694.
- (62) Qian, Z.; Baxendale, I. R.; Ley, S. V. A Continuous Flow Process Using a Sequence of Microreactors with In-line IR Analysis for the Preparation of *N,N*-Diethyl-4-(3-fluorophenylpiperidin-4-ylidene)methyl)benzamide as a Potent and Highly Selective δ -Opioid Receptor Agonist. *Chem. - Eur. J.* **2010**, 16, 12342–12348.
- (63) Tricotet, T.; O'Shea, D. F. Automated Generation and Reactions of 3-Hydroxymethylindoles in Continuous-Flow Microreactors. *Chem. - Eur. J.* **2010**, 16, 6678–6686.
- (64) Deng, Q.; Shen, R.; Zhao, Z.; Yan, M.; Zhang, L. The Continuous Flow Synthesis Of 2,4,5-Trifluorobenzoic Acid Via Sequential Grignard Exchange And Carboxylation Reactions Using Microreactors. *Chem. Eng. J.* **2015**, 262, 1168–1174.
- (65) Brodmann, T.; Koos, P.; Metzger, A.; Knochel, P.; Ley, S. V. Continuous Preparation of Arylmagnesium Reagents in Flow with Inline IR Monitoring. *Org. Process Res. Dev.* **2012**, 16, 1102–1113.
- (66) Deng, Q.; Shen, R.; Ding, R.; Zhang, L. Generation of Ethynyl-Grignard Reagent in a Falling Film Microreactor: An Expeditious Flow Synthesis of Propargylic Alcohols and Analogues. *Adv. Synth. Catal.* **2014**, 356, 2931–2936.
- (67) Goldbach, M.; Danieli, E.; Perlo, J.; Kaptein, B.; Litvinov, V. M.; Blümich, B.; Casanova, F.; Duchateau, A. L. L. Preparation Of Grignard Reagents From Magnesium Metal Under Continuous Flow Conditions And On-Line Monitoring By NMR Spectroscopy. *Tetrahedron Lett.* **2016**, 57, 122–125.
- (68) Kopach, M. E.; Cole, K. P.; Pollock, P. M.; Johnson, M. D.; Braden, T. M.; Webster, L. P.; McClary Groh, J.; McFarland, A. D.; Schafer, J. P.; Adler, J. J.; Rosemeyer, M. Flow Grignard and Lithiation: Screening Tools and Development of Continuous Processes for a Benzyl Alcohol Starting Material. *Org. Process Res. Dev.* **2016**, 20, 1581–1592.
- (69) Degennaro, L.; Maggiulli, D.; Carlucci, C.; Fanelli, F.; Romanazzi, G.; Luisi, R. A Direct And Sustainable Synthesis Of Tertiary Butyl Esters Enabled By Flow Microreactors. *Chem. Commun.* **2016**, 52, 9554–9557.
- (70) Degennaro, L.; Carlucci, C.; Angelis, S. D.; Luisi, R. Flow Technology For Organometallic-Mediated Synthesis. *J. Flow Chem.* **2016**, 6, 136–166.
- (71) Murray, P. R. D.; Browne, D. L.; Pastre, J. C.; Butters, C.; Guthrie, D.; Ley, S. V. Continuous Flow-Processing of Organometallic Reagents Using an Advanced Peristaltic Pumping System and the Telescoped Flow Synthesis of (*E/Z*)-Tamoxifen. *Org. Process Res. Dev.* **2013**, 17, 1192–1208.
- (72) Nagaki, A.; Ichinari, D.; Yoshida, J.-i. Reactions Of Organolithiums With Dialkyl Oxalates. A Flow Microreactor Approach To Synthesis Of Functionalized α -Keto Esters. *Chem. Commun.* **2013**, 49, 3242–3244.
- (73) Nagaki, A.; Tokuoka, S.; Yoshida, J.-i. Flash Generation of α -(Trifluoromethyl)Vinylolithium And Application To Continuous Flow Three-Component Synthesis Of *A*-Trifluoromethylamides. *Chem. Commun.* **2014**, 50, 15079–15081.
- (74) Nagaki, A.; Uesugi, Y.; Kim, H.; Yoshida, J.-i. Synthesis of Functionalized Aryl Fluorides Using Organolithium Reagents in Flow Microreactors. *Chem. - Asian J.* **2013**, 8, 705–708.
- (75) Kim, H.; Nagaki, A.; Yoshida, J.-i. A Flow-Microreactor Approach To Protecting-Group-Free Synthesis Using Organolithium Compounds. *Nat. Commun.* **2011**, 2, 264–269.
- (76) Degennaro, L.; Fanelli, F.; Giovine, A.; Luisi, R. External Trapping of Halomethylolithium Enabled by Flow Microreactors. *Adv. Synth. Catal.* **2015**, 357, 21–27.
- (77) Gupta, K. C.; Sutar, A. K. Catalytic Activities Of Schiff Base Transition Metal Complexes. *Coord. Chem. Rev.* **2008**, 252, 1420–1450.
- (78) Abu-Dief, A. M.; Mohamed, I. M. A. A Review On Versatile Applications Of Transition Metal Complexes Incorporating Schiff Bases. *Beni-SUEF Univ. J. Appl. Sci.* **2015**, 4, 119–133.
- (79) Makhaev, V. D.; Petrova, L. A.; Bravaya, N. M.; Faingol'd, E. E.; Mukhina, E. V.; Panin, A. N.; Gagieva, S. C.; Tuskaev, V. A.; Bulychev, B. M. Mechanochemical Synthesis Of Zirconium And Hafnium Phenoxyimine Complexes L_2MCl_2 (L = *N*-(3,5-di-tert-butylsilyl)idene)-2,3,5,6-tetrafluoroanilate anion) and Their Catalytic Properties In Ethylene Polymerization. *Russ. Chem. Bull.* **2014**, 63, 1533–1538.
- (80) Rightmire, N. R.; Hanusa, T. P.; Rheingold, A. L. Mechanochemical Synthesis of $[\text{1,3}-(\text{SiMe}_3)_2\text{C}_3\text{H}_3]_3(\text{Al,Sc})$, a Base-Free Tris(allyl)aluminum Complex and Its Scandium Analogue. *Organometallics* **2014**, 33, 5952–5955.
- (81) Boyde, N. C.; Rightmire, N. R.; Bierschenk, E. J.; Steelman, G. W.; Hanusa, T. P.; Brennessel, W. W. Reaction Environment And Ligand Lability In Group 4 Cp_2MXY (X, Y = Cl, OtBu) complexes. *Dalton Trans* **2016**, 45, 18635–18642.
- (82) Makhaev, V. D.; Petrova, L. A. Mechanochemical Synthesis Of Vanadium(III) β -Diketonates. *Russ. J. Gen. Chem.* **2017**, 87, 1105–1109.
- (83) Alias, M. F.; Jaafer, F. S.; Sadiq, A. S. Synthesis Mixed Ligands Complexes Of Some Light Metals By Microwave Assisted Using 2-Acetamide Benzothiazole And 1,10-Phenanthroline. *Int. J. Pharm.* **2015**, 5, 451–458.
- (84) Thaker, B. T.; Barvalia, R. S. Microwave Assisted Synthesis And Characterization Of Unsymmetrical Tetradentate Schiff Base Complexes Of VO(IV) And Mo(V). *Spectrochim. Acta, Part A* **2011**, 84, 51–61.
- (85) Merzougui, M.; Ouari, K.; Weiss, J. Ultrasound Assisted Synthesis, Characterization And Electrochemical Study Of A Tetradentate Oxovanadium Diazomethine Complex. *J. Mol. Struct.* **2016**, 1120, 239–244.
- (86) McGarrigle, E. M.; Gilheany, D. G. Chromium– and Manganese–Salen Promoted Epoxidation of Alkenes. *Chem. Rev.* **2005**, 105, 1563–1602.

- (87) Borisov, A. P.; Petrova, L. A.; Karpova, T. P.; Makhaev, V. D. Solid-State Mechanochemical Synthesis Of Tris(4-Imino-2-Pentanonato)Chromium, $\text{Cr}[\text{CH}_3\text{C}(\text{NH})\text{CHC}(\text{O})\text{CH}_3]_3$. *Russ. Chem. Bull.* **1994**, *43*, 2107–2109.
- (88) Uzarevic, K.; Rubcic, M.; Radic, M.; Puskaric, A.; Cindric, M. Mechanosensitive Metal-Ligand Bonds In The Design Of New Coordination Compounds. *CrystEngComm* **2011**, *13*, 4314–4323.
- (89) Užarević, K.; Rubčić, M.; Đilović, I.; Kokan, Z.; Matković-Čalogović, D.; Cindrić, M. Concomitant Conformational Polymorphism: Mechanochemical Reactivity and Phase Relationships in the (Methanol)cis-dioxo(*N*-salicylidene-2-amino-3-hydroxypyridine)-molybdenum(VI) Trimorph. *Cryst. Growth Des.* **2009**, *9*, 5327–5333.
- (90) Cindric, M.; Pavlovic, G.; Katava, R.; Agustin, D. Towards A Global Greener Process: From Solvent-Less Synthesis Of Molybdenum(VI) ONO Schiff Base Complexes To Catalyzed Olefin Epoxidation Under Organic-Solvent-Free Conditions. *New J. Chem.* **2017**, *41*, 594–602.
- (91) Baghurst, D. R.; Cooper, S. R.; Greene, D. L.; Mingos, D. M. P.; Reynolds, S. M. Application Of Microwave Dielectric Loss Heating Effects For The Rapid And Convenient Synthesis Of Coordination Compounds. *Polyhedron* **1990**, *9*, 893–895.
- (92) VanAtta, S. L.; Duclos, B. A.; Green, D. B. Microwave-Assisted Synthesis of Group 6 (Cr, Mo, W) Zerovalent Organometallic Carbonyl Compounds. *Organometallics* **2000**, *19*, 2397–2399.
- (93) Ardon, M.; Hogarth, G.; Ocroft, D. T. W. Organometallic Chemistry In A Conventional Microwave Oven: The Facile Synthesis Of Group 6 Carbonyl Complexes. *J. Organomet. Chem.* **2004**, *689*, 2429–2435.
- (94) Birdwhistell, K. R.; Schulz, B. E.; Dizon, P. M. Rapid Synthesis Of Group VI Carbonyl Complexes By Coupling Borohydride Catalysis And Microwave Heating. *Inorg. Chem. Commun.* **2012**, *26*, 69–71.
- (95) Jain, R. K.; Mishra, A. P. Microwave Synthesis And Spectral, Thermal And Antimicrobial Activities Of Some Novel Transition Metal Complexes With Tridentate Schiff Base Ligands. *J. Serb. Chem. Soc.* **2012**, *77*, 1013–1029.
- (96) Mishra, A. P.; Jain, R. K. Microwave Synthesis, Spectral, Thermal And Antimicrobial Activities Of Some Transition Metal Complexes Involving 2-Amino-6-nitrobenzothiazole Moiety. *Proc. Natl. Acad. Sci., India, Sect. A* **2013**, *83*, 213–223.
- (97) Jain, R. K.; Mishra, A. P. Microwave Synthesis, Spectral, Thermal, 3D Molecular Modeling Analysis And Antimicrobial Activities Of Some Transition Metal Complexes Of Schiff Bases Derived From 5-Bromosalicylaldehyde. *J. Saudi Chem. Soc.* **2016**, *20*, 127–137.
- (98) Jain, R. K.; Mishra, A. P.; Mishra, D. K.; Gupta, S. K. Microwave Synthesis, Spectral, Thermal And Electrical Properties Of Some Metal Complexes Involving 5-Bromosalicylaldehyde. *E-J. Chem.* **2012**, *9*, 1721–1727.
- (99) Mishra, A. P.; Jain, R. K. Conventional And Microwave Synthesis, Spectral, Thermal And Antimicrobial Studies Of Some Transition Metal Complexes Containing 2-Amino-5-Methylthiazole Moiety. *J. Saudi Chem. Soc.* **2014**, *18*, 814–824.
- (100) Mishra, A. P.; Jain, R. K. Microwave Synthesis, Spectroscopic, Thermal And Biological Significance Of Some Transition Metal Complexes Containing Heterocyclic Ligands. *Transition Met. Chem.* **2010**, *2*, 51–61.
- (101) Fahmi, N.; Shrivastava, S.; Meena, R.; Joshi, S. C.; Singh, R. V. Microwave Assisted Synthesis, Spectroscopic Characterization And Biological Aspects Of Some New Chromium(III) Complexes Derived From $\text{N}^{\wedge}\text{O}$ Donor Schiff Bases. *New J. Chem.* **2013**, *37*, 1445–1453.
- (102) Praveen Kumar, S.; Suresh, R.; Giribabu, K.; Manigandan, R.; Munusamy, S.; Muthamizh, S.; Narayanan, V. Synthesis And Characterization Of Chromium(III) Schiff Base Complexes: Antimicrobial Activity And Its Electrocatalytic Sensing Ability Of Catechol. *Spectrochim. Acta, Part A* **2015**, *139*, 431–441.
- (103) Whittaker, A. G.; Mingos, D. M. P. Synthetic Reactions Using Metal Powders Under Microwave Irradiation. *J. Chem. Soc., Dalton Trans.* **2002**, 3967–3970.
- (104) Lee, Y. T.; Choi, S. Y.; Lee, S. I.; Chung, Y. K.; Kang, T. J. Microwave-Assisted Synthesis Of (H^6 -Arene)Tricarbonylchromium Complexes. *Tetrahedron Lett.* **2006**, *47*, 6569–6572.
- (105) Amarante, T.; Almeida Paz, F.; Gago, S.; Gonçalves, I.; Pillinger, M.; Rodrigues, A.; Abrantes, M. Microwave-Assisted Synthesis and Crystal Structure of Oxo(diperoxo)(4,4'-di-tert-butyl-2,2'-bipyridine)-molybdenum(VI). *Molecules* **2009**, *14*, 3610–3620.
- (106) Ardon, M.; Hayes, P. D.; Hogarth, G. Microwave-Assisted Reflux in Organometallic Chemistry: Synthesis and Structural Determination of Molybdenum Carbonyl Complexes. An Intermediate-Level Organometallic-Inorganic Experiment. *J. Chem. Educ.* **2002**, *79*, 1249–1251.
- (107) Coelho, A.; Almeida Paz, F.; Klinowski, J.; Pillinger, M.; Gonçalves, I. Microwave Assisted Synthesis of Molybdenum and Tungsten Tetracarbonyl Complexes with a Pyrazolylpyridine Ligand. Crystal structure of *cis*-[Mo(CO)₄{ethyl[3-(2-pyridyl)-1-pyrazolyl]acetate}]. *Molecules* **2006**, *11*, 940–952.
- (108) Barnard, T. M.; Leadbeater, N. E. Real-Time Monitoring Of Microwave-Promoted Organometallic Ligand-Substitution Reactions Using In Situ Raman Spectroscopy. *Chem. Commun.* **2006**, 3615–3616.
- (109) Artillo, A.; Sala, G. D.; De Santis, M.; Llordes, A.; Ricart, S.; Spinella, A. Preparation of organometallic uracil-analogue Fischer carbene complexes: Comparative study of conventional heating vs microwave irradiation. *J. Organomet. Chem.* **2007**, *692*, 1277–1284.
- (110) Kostermans, G. B. M.; Bobeldijk, M.; Kwakman, P. J.; de Wolf, W. H.; Bickelhaupt, F. Photochemical Synthesis Of Arene-tricarbonylchromium(0) Complexes: Scope And Limitations. *J. Organomet. Chem.* **1989**, *363*, 291–296.
- (111) Bengali, A. A.; Charlton, S. B. Displacement of the Benzene Solvent Molecule from $\text{Cr}(\text{CO})_5(\text{benzene})$ by Piperidine: A Laser Flash Photolysis Experiment. *J. Chem. Educ.* **2000**, *77*, 1348–1351.
- (112) Deckelmann, K.; Werner, H. Photochemische Darstellung von Hexaalkylborazol-und Aromaten-chromtricarbylen. *Helv. Chim. Acta* **1970**, *53*, 139–141.
- (113) McNeese, T. J.; Ezbiansky, K. A. Photochemical Preparation and Reactivity of *cis* $\text{Cr}(\text{CO})_4(\text{CH}_3\text{CN})_2$: An Advanced Undergraduate Inorganic Laboratory Experiment. *J. Chem. Educ.* **1996**, *73*, 548–550.
- (114) King, J. L.; Molvinger, K.; Poliakoff, M. Organometallic Synthesis as a Continuous Process: The Synthesis and Isolation of $\text{Cr}(\text{CO})_5(\eta^2\text{-C}_3\text{H}_6)$ and $(\text{C}_5\text{R}_5)\text{Mn}(\text{CO})_2(\eta^2\text{-C}_3\text{H}_6)$ (R = H and Me) from Superheated Liquid Propene. *Organometallics* **2000**, *19*, 5077–5082.
- (115) Kocięcka, P.; Kochel, A.; Szymańska-Buzar, T. Photochemical Synthesis, Structure And Spectroscopic Properties Of $[\text{W}(\text{CO})_4(\text{C}_5\text{H}_{10}\text{N})_2\text{CH}_2]$. *Inorg. Chem. Commun.* **2014**, *45*, 105–107.
- (116) Cortés-Figueroa, J. E. An Experiment for the Inorganic Chemistry Laboratory: The Sunlight-Induced Photosynthesis of $(\eta^2\text{-C}_{60})\text{M}(\text{CO})_5$ Complexes (M = Mo, W). *J. Chem. Educ.* **2003**, *80*, 799–800.
- (117) Post, E. W. An Inorganic Laboratory Experiment Involving Photochemistry, Liquid Chromatography, And Infrared Spectroscopy. *J. Chem. Educ.* **1980**, *57*, 819–822.
- (118) Manuta, D. M.; Lees, A. J. Preparation And Reaction Of 2,2'-Bipyridinetetracarbonylmolybdenum(0): An Experiment In Organometallic Photochemistry. *J. Chem. Educ.* **1987**, *64*, 637–638.
- (119) Sener, S.; Ercag, A. Photochemical Reactions Of Metal Carbonyls $[\text{M}(\text{CO})_6]$ (M = Cr, Mo, W), $\text{Mn}(\text{CO})_5\text{Cp}$ With 3[4-Ethyl(Phenyl)Imino][1H-Indol-2-One] And 3[4-Butyl(Phenyl)Imino][1H-Indol-2-One]. *Asian J. Chem.* **2017**, *29*, 235–238.
- (120) Lee, C. X.; Pedrick, E. A.; Leadbeater, N. E. Preparation of Arene Chromium Tricarbonyl Complexes Using Continuous-Flow Processing: $(\eta^6\text{-C}_6\text{H}_5\text{CH}_3)\text{Cr}(\text{CO})_3$ as an Example. *J. Flow Chem.* **2012**, *2*, 115–117.
- (121) Fernandez-Moreira, V.; Thorp-Greenwood, F. L.; Coogan, M. P. Application Of d6 Transition Metal Complexes In Fluorescence Cell Imaging. *Chem. Commun.* **2010**, *46*, 186–202.

- (122) Hernandez, J. G.; Macdonald, N. A. J.; Mottillo, C.; Butler, I. S.; Friščić, T. A Mechanochemical Strategy For Oxidative Addition: Remarkable Yields And Stereoselectivity In The Halogenation Of Organometallic Re(I) Complexes. *Green Chem.* **2014**, *16*, 1087–1092.
- (123) Hernandez, J. G.; Butler, I. S.; Friščić, T. Multi-Step And Multi-Component Organometallic Synthesis In One Pot Using Orthogonal Mechanochemical Reactions. *Chem. Sci.* **2014**, *5*, 3576–3582.
- (124) Glavinovic, M.; Qi, F.; Katsenis, A. D.; Friščić, T.; Lumb, J.-P. Redox-Promoted Associative Assembly Of Metal-Organic Materials. *Chem. Sci.* **2016**, *7*, 707–712.
- (125) Baghurst, D. R.; Mingos, D. M. P. Design And Application Of A Reflux Modification For The Synthesis Of Organometallic Compounds Using Microwave Dielectric Loss Heating Effects. *J. Organomet. Chem.* **1990**, *384*, C57–C60.
- (126) Reed, C. R.; Feeney, C.; Merritt, M. A. Microwave Synthesis Of Dirhenium Paddlewheel Complexes. *J. Coord. Chem.* **2015**, *68*, 3449–3456.
- (127) Causey, P. W.; Besanger, T. R.; Schaffer, P.; Valliant, J. F. Expedient Multi-Step Synthesis of Organometallic Complexes of Tc and Re in High Effective Specific Activity. A New Platform for the Production of Molecular Imaging and Therapy Agents. *Inorg. Chem.* **2008**, *47*, 8213–8221.
- (128) Kunz, P. C.; Berghahn, M.; Brückmann, N. E.; Dickmeis, M.; Kettel, M.; Spingler, B. Functionalised Tris(pyrazolyl)methane Ligands and Re(CO)₃ Complexes Thereof. *Z. Anorg. Allg. Chem.* **2009**, *635*, 471–478.
- (129) Armstrong, A. F.; Valliant, J. F. Microwave-Assisted Synthesis of Tricarbonyl Rhenacarboranes: Steric and Electronic Effects on the 1,2 → 1,7 Carborane Cage Isomerization. *Inorg. Chem.* **2007**, *46*, 2148–2158.
- (130) Causey, P. W.; Besanger, T. R.; Valliant, J. F. Synthesis and Screening of Mono- and Di-Aryl Technetium and Rhenium Metallo-carboranes. A New Class of Probes for the Estrogen Receptor. *J. Med. Chem.* **2008**, *51*, 2833–2844.
- (131) Bhojak, N.; Gudasaria, D. D.; Khiwani, N.; Jain, R. Microwave Assisted Synthesis Spectral and Antibacterial Investigations on Complexes of Mn(II) With Amide Containing Ligands. *E-J. Chem.* **2007**, *4*, 232–237.
- (132) Xu, S. P.; Xu, G.; Pei, Y.; Zhu, H. L. Microwave Solid Phase Synthesis, Characterization, And Antimicrobial Activities Of One Mononuclear Manganese(II) Complex With 4-Chlorobenzoic Acid 4-[3-(4-chlorophenyl)-3-hydroxyacryloyl]-3-hydroxyphenyl ester. *Russ. J. Coord. Chem.* **2014**, *40*, 63–67.
- (133) Ali, P.; Ramakanth, P.; Meshram, J. Exploring Microwave Synthesis For Co-Ordination: Synthesis, Spectral Characterization And Comparative Study Of Transition Metal Complexes With Binuclear Core Derived From 4-amino-2,3-dimethyl-1-phenyl-3-pyrazolin-5-one. *J. Coord. Chem.* **2010**, *63*, 323–329.
- (134) Ahmed, M. F. A. Microwave Synthesis And Antibacterial Activity Of Some Heterocyclic Schiff's Base Metal Complexes Of First Transition Series. *Res. J. Pharm., Biol. Chem. Sci.* **2014**, *5*, 912–919.
- (135) Pagadala, R.; Ali, P.; Meshram, J. S. Microwave Assisted Synthesis And Characterization Of N,N'-Bis(Salicylaldehyde)-Ethylenediimine Complexes of Mn(II), Co(II), Ni(II), and Zn(II). *J. Coord. Chem.* **2009**, *62*, 4009–4017.
- (136) Zhang, S.-H.; Feng, C. Microwave-Assisted Synthesis, Crystal Structure And Fluorescence Of Novel Coordination Complexes With Schiff Base Ligands. *J. Mol. Struct.* **2010**, *977*, 62–66.
- (137) Milios, C. J.; Vinslava, A.; Whittaker, A. G.; Parsons, S.; Wernsdorfer, W.; Christou, G.; Perlepes, S. P.; Brechin, E. K. Microwave-Assisted Synthesis of a Hexanuclear Mn(III) Single-Molecule Magnet. *Inorg. Chem.* **2006**, *45*, 5272–5274.
- (138) Batool, M.; Martin, T. A.; Naser, M. A.; George, M. W.; Macgregor, S. A.; Mahon, M. F.; Whittlesey, M. K. Comparison Of The Photochemistry Of Organometallic N-Heterocyclic Carbene And Phosphine Complexes Of Manganese. *Chem. Commun.* **2011**, *47*, 11225–11227.
- (139) Batool, M.; Martin, T. A.; Algarra, A. G.; George, M. W.; Macgregor, S. A.; Mahon, M. F.; Whittlesey, M. K. Photochemistry of Cp'Mn(CO)₂(NHC) (Cp' = η⁵-C₅H₄Me) Species: Synthesis, Time-Resolved IR Spectroscopy, and DFT Calculations. *Organometallics* **2012**, *31*, 4971–4979.
- (140) Zhuang, J. M.; Sutton, D. Photolysis of (η⁵-pentamethylcyclopentadienyl)rhenium tricarbonyl With Alkenes. Synthesis of (η⁵-C₅Me₅)Re(CO)₂(alkene) Complexes And Carbon-Hydrogen Activation To Give Allyl Hydrido Derivatives. *Organometallics* **1991**, *10*, 1516–1527.
- (141) Plietker, B., Ed. *Iron Catalysis in Organic Chemistry Reactions and Applications*; Wiley-VCH Verlag GmbH & Co. KGaA: 2008; p 279.
- (142) van Rijt, S. H.; Sadler, P. J. Current Applications And Future Potential For Bioinorganic Chemistry In The Development Of Anticancer Drugs. *Drug Discovery Today* **2009**, *14*, 1089–1097.
- (143) Younus, H. A.; Su, W.; Ahmad, N.; Chen, S.; Verpoort, F. Ruthenium Pincer Complexes: Synthesis and Catalytic Applications. *Adv. Synth. Catal.* **2015**, *357*, 283–330.
- (144) Colacino, E.; Martinez, J.; Lamaty, F. Preparation of NHC–Ruthenium Complexes And Their Catalytic Activity In Metathesis Reaction. *Coord. Chem. Rev.* **2007**, *251*, 726–764.
- (145) Scholl, M.; Ding, S.; Lee, C. W.; Grubbs, R. H. Synthesis and Activity of a New Generation of Ruthenium-Based Olefin Metathesis Catalysts Coordinated with 1,3-Dimesityl-4,5-dihydroimidazol-2-ylidene Ligands. *Org. Lett.* **1999**, *1*, 953–956.
- (146) Makhaev, V. D.; Borisov, A. P.; Petrova, L. A. Solid-State Mechanochemical Synthesis Of Ferrocene. *J. Organomet. Chem.* **1999**, *590*, 222–226.
- (147) Braga, D.; Maini, L.; Polito, M.; Mirolo, L.; Grepioni, F. Mechanochemical Assembly Of Hydrogen Bonded Organic-Organometallic Solid Compounds. *Chem. Commun.* **2002**, 2960–2961.
- (148) Braga, D.; Maini, L.; Polito, M.; Mirolo, L.; Grepioni, F. Assembly of Hybrid Organic–Organometallic Materials through Mechanochemical Acid–Base Reactions. *Chem. - Eur. J.* **2003**, *9*, 4362–4370.
- (149) Braga, D.; Giuffreda, S. L.; Grepioni, F.; Palladino, G.; Polito, M. Mechanochemical Assembly Of Hybrid Organic-Organometallic Materials. Solid-Solid Reactions Of 1,1'-di-pyridyl-ferrocene With Organic Acids. *New J. Chem.* **2008**, *32*, 820–828.
- (150) Braga, D.; Giuffreda, S. L.; Grepioni, F. Solid-State Preparation Of Hybrid Organometallic-Organic Macrocyclic Adducts With Long Chain Dicarboxylic Acids. *Chem. Commun.* **2006**, 3877–3879.
- (151) Braga, D.; D'Addari, D.; Polito, M.; Grepioni, F. Mechanically Induced Expedient and Selective Preparation of Disubstituted Pyridine/Pyrimidine Ferrocenyl Complexes. *Organometallics* **2004**, *23*, 2810–2812.
- (152) Imrie, C.; Nyamori, V. O.; Gerber, T. I. A. Solvent-Free Synthesis Of Ferrocenyylimines. *J. Organomet. Chem.* **2004**, *689*, 1617–1622.
- (153) Imrie, C.; Kleyi, P.; Nyamori, V. O.; Gerber, T. I. A.; Levendis, D. C.; Look, J. Further Solvent-Free Reactions Of Ferrocenylaldehydes: Synthesis Of 1,1'-Ferrocenyldiimines and Ferrocenylacrylonitriles. *J. Organomet. Chem.* **2007**, *692*, 3443–3453.
- (154) Kleyi, P. E.; McClelland, C. W.; Gerber, T. I. A. Solvent-Free Synthesis Of Bisferrocenyylimines And Their Rhodium(I) Complexes. *Polyhedron* **2010**, *29*, 1095–1101.
- (155) Ombaka, L. M.; Ndungu, P. G.; Omondi, B.; Nyamori, V. O. Mechanochemical Synthesis And Spectroscopic Properties Of 1,1'-Ferrocenyldiacrylonitriles: The Effect Of Para-Substituents. *J. Coord. Chem.* **2014**, *67*, 1905–1922.
- (156) Nieto, D.; Bruna, S.; Montero-Campillo, M. M.; Perles, J.; Gonzalez-Vadillo, A. M. a.; Mendez, J.; Mo, O.; Cuadrado, I. Mechanochemical And Silica Gel-Mediated Formation Of Highly Electron-Poor 1-Cyanocarbonylferrocene. *Chem. Commun.* **2013**, *49*, 9785–9787.
- (157) Borisov, A. P.; Makhaev, V. D.; Usyatinskii, A. Y.; Bregadze, V. I. Solid-State Mechanochemical Synthesis Of cobalt(III), iron(III),

and chromium(III) Bisdicarbollyl Complexes. *Russ. Chem. Bull.* **1993**, *42*, 1637–1639.

(158) Paneque, A.; Reguera, E.; Fernández-Bertrán, J.; Yee-Madeira, H. Mechanochemical Reactions Of Fluorides With Hemin. *J. Fluorine Chem.* **2002**, *113*, 1–5.

(159) Giri, C.; Sahoo, P. K.; Puttreddy, R.; Rissanen, K.; Mal, P. Solvent-Free Ball-Milling Subcomponent Synthesis of Metallosupramolecular Complexes. *Chem. - Eur. J.* **2015**, *21*, 6390–6393.

(160) Tan, Y.-H.; Yang, L.-F.; Cao, M.-L.; Wu, J.-J.; Ye, B.-H. Liquid-Assisted Solid-State Reaction: Assembly Of (6,3) and (10,3) Hydrogen-Bonded Networks Based On $[M(\text{Hbiim})_3]$ By Oxidation Of $[M(\text{H}_2\text{biim})_3]^{2+}$ Complexes In The Presence Of Acetate Anions. *CrystEngComm* **2011**, *13*, 4512–4518.

(161) Dabirmanesh, Q.; Roberts, R. M. G. The Synthesis Of Iron Sandwich Complexes By Microwave Dielectric Heating Using A Simple Solid CO₂-Cooled Apparatus In An Unmodified Commercial Microwave Oven. *J. Organomet. Chem.* **1993**, *460*, C28–C29.

(162) Dabirmanesh, Q.; Fernando, S. I. S.; Roberts, R. M. G. Synthesis And Decomplexation Of (η^6 -arene)(η^5 -cyclopentadienyl)-Iron(II) Hexafluorophosphates Using Microwave Dielectric Heating. *J. Chem. Soc., Perkin Trans. 1* **1995**, *1*, 743–749.

(163) Roberts, R. M. G. Synthesis of (η^6 -arene)(η^5 -cyclopentadienyl) Iron (II) Complexes With Heteroatom And Carbonyl Substituents Part II, Amino substituents. *J. Organomet. Chem.* **2006**, *691*, 4926–4930.

(164) Roberts, R. M. G. Synthesis of (η^6 -arene)(η^5 -cyclopentadienyl) iron (II) complexes With Heteroatom And Carbonyl Substituents. Part I: Oxygen and carbonyl substituents. *J. Organomet. Chem.* **2006**, *691*, 2641–2647.

(165) Garringer, S. M.; Hesse, A. J.; Magers, J. R.; Pugh, K. R.; O'Reilly, S. A.; Wilson, A. M. Microwave Synthesis of Benchmark Organo-Iron Complexes. *Organometallics* **2009**, *28*, 6841–6844.

(166) Pagnoux-Ozherelyeva, A.; Bolién, D.; Gaillard, S.; Peudru, F.; Lohier, J.-F.; Whitby, R. J.; Renaud, J.-L. Microwave Irradiation And Flow Chemistry For A Straightforward Synthesis Of Piano-Stool Iron Complexes. *J. Organomet. Chem.* **2014**, *774*, 35–42.

(167) Puciova, M.; Ertl, P.; Toma, S. Synthesis Of Ferrocenyl-Substituted Heterocycles: The Beneficial Effect Of The Microwave Irradiation. *Collect. Czech. Chem. Commun.* **1994**, *59*, 175–85.

(168) Villemin, D.; Martin, B.; Puciova, M.; Toma, S. Dry Synthesis Under Microwave Irradiation: Synthesis Of Ferrocenylenones. *J. Organomet. Chem.* **1994**, *484*, 27–31.

(169) Pedotti, S.; Patti, A. Microwave-Assisted Synthesis Of 1,5-Dioxo-3-Substituted [5]Ferrocenophanes. *J. Organomet. Chem.* **2008**, *693*, 1375–1381.

(170) Kulikov, V. N.; Nikulin, R. S.; Arkhipov, D. E.; Rodionov, A. N.; Babusenko, E. S.; Kovalenko, L. V.; Belousov, Y. A. Ferrocenecarboxylic Acid And Microwave-Assisted Synthesis Of Ferrocenyl Hydrazones. *Russ. Chem. Bull.* **2017**, *66*, 537–544.

(171) Jankova, S.; Cisarova, I.; Uhlik, F.; Stepnicka, P.; Kotora, M. Synthesis And Characterisation Of Dewar Benzene-Ferrocene Conjugates. *Dalton Trans* **2009**, 3137–3139.

(172) Greene, D. L.; Mingos, D. M. P. Application Of Microwave Dielectric Loss Heating Effects For The Rapid And Convenient Synthesis Of Ruthenium(II) Polypyridine Complexes. *Transition Met. Chem.* **1991**, *16*, 71–72.

(173) Matsumura-Inoue, T.; Tanabe, M.; Minami, T.; Ohashi, T. A Remarkably Rapid Synthesis of Ruthenium(II) Polypyridine Complexes by Microwave Irradiation. *Chem. Lett.* **1994**, *23*, 2443–2446.

(174) Xiao, X.; Sakamoto, J.; Tanabe, M.; Yamazaki, S.; Yamabe, S.; Matsumura-Inoue, T. Microwave Synthesis And Electrochemical Study On Ruthenium(II) Polypyridine Complexes. *J. Electroanal. Chem.* **2002**, *527*, 33–40.

(175) Bolink, H. J.; Cappelli, L.; Coronado, E.; Grätzel, M.; Nazeeruddin, M. K. Efficient and Stable Solid-State Light-Emitting Electrochemical Cell Using Tris(4,7-diphenyl-1,10-phenanthroline)-ruthenium(II) Hexafluorophosphate. *J. Am. Chem. Soc.* **2006**, *128*, 46–47.

(176) Luis, E. T.; Ball, G. E.; Gilbert, A.; Iranmanesh, H.; Newdick, C. W.; Beves, J. E. Efficient Microwave-Assisted Synthesis And Characterization Of Key Ruthenium(II) Polypyridyl Complexes $[\text{Ru}(\text{bpy})_3](\text{PF}_6)_2$, $[\text{Ru}(\text{phen})_3](\text{PF}_6)_2$, $[\text{Ru}(\text{bpy})_2(\text{phen})](\text{PF}_6)_2$ and $[\text{Ru}(\text{phen})_2(\text{bpy})](\text{PF}_6)_2$. *J. Coord. Chem.* **2016**, *69*, 1686–1694.

(177) Sun, Y.; Machala, M. L.; Castellano, F. N. Controlled Microwave Synthesis Of Ru(II) Synthons And Chromophores Relevant To Solar Energy Conversion. *Inorg. Chim. Acta* **2010**, *363*, 283–287.

(178) Wu, F.; Thummel, R. P. Ru(II) Complexes Of Crowded Delocalized Diimine Ligands. *Inorg. Chim. Acta* **2002**, *327*, 26–30.

(179) Sasaki, I.; Daran, J. C.; Ait-Haddou, H.; Balavoine, G. G. A. New Annelated 2,2':6',2''-Terpyridines And Their Ru(II) Complexes: Synthesis And Characterisation. *Inorg. Chem. Commun.* **1998**, *1*, 354–357.

(180) Beves, J. E.; Constable, E. C.; Housecroft, C. E.; Neuburger, M.; Schaffner, S.; Zampese, J. A. 4'-Chloro-2,2':6',2''-terpyridine (L): Ethyl Sulfate Salts Of $[\text{H}_2\text{L}]^{2+}$ And The Single Crystal Structures Of $[\text{H}_2\text{L}][\text{EtOSO}_3]\text{Cl}\cdot\text{H}_2\text{O}$ and $[\text{ML}_2][\text{PF}_6]_2$ with M = Fe and Ru. *Inorg. Chem. Commun.* **2008**, *11*, 1006–1008.

(181) Ziegler, M.; Monney, V.; Stoeckli-Evans, H.; Von Zelewsky, A.; Sasaki, I.; Dupic, G.; Daran, J.-C.; Balavoine, G. Complexes Of New Chiral Terpyridyl Ligands. Synthesis And Characterization Of Their Ruthenium(II) And Rhodium(III) Complexes. *J. Chem. Soc., Dalton Trans.* **1999**, 667–676.

(182) Martineau, D.; Beley, M.; Gros, P. C. Pyrrolidine-Containing Polypyridines: New Ligands for Improved Visible Light Absorption by Ruthenium Complexes. *J. Org. Chem.* **2006**, *71*, S66–S71.

(183) Rau, S.; Schäfer, B.; Grüßing, A.; Schebesta, S.; Lamm, K.; Vieth, J.; Görls, H.; Walther, D.; Rudolph, M.; Grummt, U. W.; Birkner, E. Efficient Synthesis Of Ruthenium Complexes Of The Type $(\text{R-bpy})_2\text{RuCl}_2$ and $[(\text{R-bpy})_2\text{Ru}(\text{L-L})]\text{Cl}_2$ By Microwave-Activated Reactions (R: H, Me, *tert*-But) (L-L: Substituted Bibenzimidazoles, Bipyrimidine, And Phenanthroline). *Inorg. Chim. Acta* **2004**, *357*, 4496–4503.

(184) Martineau, D.; Beley, M.; Gros, P. C.; Cazzanti, S.; Caramori, S.; Bignozzi, C. A. Tuning of Ruthenium Complex Properties Using Pyrrole- and Pyrrolidine-Containing Polypyridine Ligands. *Inorg. Chem.* **2007**, *46*, 2272–2277.

(185) Schwalbe, M.; Schäfer, B.; Görls, H.; Rau, S.; Tschierlei, S.; Schmitt, M.; Popp, J.; Vaughan, G.; Henry, W.; Vos, J. G. Synthesis and Characterisation of Poly(bipyridine)ruthenium Complexes as Building Blocks for Heterosupramolecular Arrays. *Eur. J. Inorg. Chem.* **2008**, *2008*, 3310–3319.

(186) Patil, S.; Deally, A.; Hackenberg, F.; Kaps, L.; Müller-Bunz, H.; Schobert, R.; Tacke, M. Novel Benzyl- or 4-Cyanobenzyl-Substituted N-Heterocyclic (Bromo)(carbene)silver(I) and (Carbene)(chloro)gold(I) Complexes: Synthesis and Preliminary Cytotoxicity Studies. *Helv. Chim. Acta* **2011**, *94*, 1551–1562.

(187) Pezet, F.; Daran, J.-C.; Sasaki, I.; Ait-Haddou, H.; Balavoine, G. G. A. Highly Diastereoselective Preparation of Ruthenium Bis(diimine) Sulfoxide Complexes: New Concept in the Preparation of Optically Active Octahedral Ruthenium Complexes. *Organometallics* **2000**, *19*, 4008–4015.

(188) Abrahamsson, M.; Jäger, M.; Österman, T.; Eriksson, L.; Persson, P.; Becker, H.-C.; Johansson, O.; Hammarström, L. A 3.0 μs Room Temperature Excited State Lifetime of a Bistridentate Ru(II)–Polypyridine Complex for Rod-like Molecular Arrays. *J. Am. Chem. Soc.* **2006**, *128*, 12616–12617.

(189) Abrahamsson, M.; Jäger, M.; Kumar, R. J.; Österman, T.; Persson, P.; Becker, H.-C.; Johansson, O.; Hammarström, L. Bistridentate Ruthenium(II) polypyridyl-Type Complexes with Microsecond ³MLCT State Lifetimes: Sensitizers for Rod-Like Molecular Arrays. *J. Am. Chem. Soc.* **2008**, *130*, 15533–15542.

(190) Jäger, M.; Kumar, R. J.; Görls, H.; Bergquist, J.; Johansson, O. Facile Synthesis of Bistridentate Ru(II) Complexes Based on 2,6-Di(quinolin-8-yl)pyridyl Ligands: Sensitizers with Microsecond ³MLCT Excited State Lifetimes. *Inorg. Chem.* **2009**, *48*, 3228–3238.

- (191) Ott, C.; Wouters, D.; Thijs, H. M. L.; Schubert, U. S. New Preparation and Purification Methods for Metallo-Supramolecular Block Copolymers. *J. Inorg. Organomet. Polym. Mater.* **2007**, *17*, 241–249.
- (192) Funaki, T.; Yanagida, M.; Onozawa-Komatsuzaki, N.; Kasuga, K.; Kawanishi, Y.; Kurashige, M.; Sayama, K.; Sugihara, H. Synthesis Of A New Class Of Cyclometallated Ruthenium(II) Complexes And Their Application In Dye-Sensitized Solar Cells. *Inorg. Chem. Commun.* **2009**, *12*, 842–845.
- (193) Grabulosa, A.; Beley, M.; Gros, P. C. Remarkable Effect of 4-Substituted 2,2'-Bipyridine Ligands on the Stereochemistry of Ruthenium(II) Complexes. *Eur. J. Inorg. Chem.* **2008**, *2008*, 1747–1751.
- (194) Glasson, C. R. K.; Meehan, G. V.; Clegg, J. K.; Lindoy, L. F.; Smith, J. A.; Keene, F. R.; Motti, C. Microwave Synthesis of a Rare $[\text{Ru}_2\text{L}_3]^{4+}$ Triple Helicate and Its Interaction with DNA. *Chem. - Eur. J.* **2008**, *14*, 10535–10538.
- (195) Pascu, G. I.; Hotze, A. C. G.; Sanchez-Cano, C.; Kariuki, B. M.; Hannon, M. J. Dinuclear Ruthenium(II) Triple-Stranded Helicates: Luminescent Supramolecular Cylinders That Bind and Coil DNA and Exhibit Activity against Cancer Cell Lines. *Angew. Chem., Int. Ed.* **2007**, *46*, 4374–4378.
- (196) Munery, S.; Jaud, J.; Bonvoisin, J. Synthesis And Characterization Of Bis(Bipyridine)Ruthenium(II) Complexes With Bromo Or Protected Ethynyl β -Diketonato Ligands. *Inorg. Chem. Commun.* **2008**, *11*, 975–977.
- (197) Jasimuddin, S.; Byabartta, P.; Mostafa, G.; Lu, T. H.; Sinha, C. Synthesis, Spectral Studies, Crystal Structure And Redox Properties Of Homoleptic Tris-Chelated Ruthenium(II)-Arylazoimidazoles. *Polyhedron* **2004**, *23*, 727–733.
- (198) Herrero, S.; Jimenez-Aparicio, R.; Perles, J.; Priego, J. L.; Urbanos, F. A. First Microwave Synthesis Of Multiple Metal-Metal Bond Paddlewheel Compounds. *Green Chem.* **2010**, *12*, 965–967.
- (199) Herrero, S.; Jimenez-Aparicio, R.; Perles, J.; Priego, J. L.; Saguar, S.; Urbanos, F. A. Microwave Methods For The Synthesis Of Paddlewheel Diruthenium Compounds With *N,N*-Donor Ligands. *Green Chem.* **2011**, *13*, 1885–1890.
- (200) Baghurst, D. R.; Mingos, D. M. P. A New Reaction Vessel For Accelerated Syntheses Using Microwave Dielectric Super-Heating Effects. *J. Chem. Soc., Dalton Trans.* **1992**, 1151–1155.
- (201) Díaz-Valenzuela, M. B.; Phillips, S. D.; France, M. B.; Gunn, M. E.; Clarke, M. L. Enantioselective Hydrogenation and Transfer Hydrogenation of Bulky Ketones Catalysed by a Ruthenium Complex of a Chiral Tridentate Ligand. *Chem. - Eur. J.* **2009**, *15*, 1227–1232.
- (202) Delgado-Martínez, P.; Elvira-Bravo, A.; González-Prieto, R.; Priego, L. J.; Jimenez-Aparicio, R.; Torres, R. M. Synthesis of $\text{Ru}_2\text{Br}(\mu\text{-O}_2\text{CC}_6\text{H}_4\text{-R})_4$ (R = *o*-Me, *m*-Me, *p*-Me) Using Microwave Activation: Structural and Magnetic Properties. *Inorganics* **2014**, *2*, 524–536.
- (203) Cortijo, M.; Delgado-Martínez, P.; González-Prieto, R.; Herrero, S.; Jiménez-Aparicio, R.; Perles, J.; Priego, J. L.; Torres, M. R. Microwave And Solvothermal Methods For The Synthesis Of Nickel And Ruthenium Complexes With 9-Anthracene Carboxylate Ligand. *Inorg. Chim. Acta* **2015**, *424*, 176–185.
- (204) Schmidehner, M.; Kuhn, P.-S.; Hackl, C. M.; Roller, A.; Kandioller, W.; Keppler, B. K. Microwave-Assisted Synthesis Of *N*-Heterocycle-Based Organometallics. *J. Organomet. Chem.* **2014**, *772–773*, 93–99.
- (205) Tönnemann, J.; Risse, J.; Grote, Z.; Scopelliti, R.; Severin, K. Efficient and Rapid Synthesis of Chlorido-Bridged Half-Sandwich Complexes of Ruthenium, Rhodium, and Iridium by Microwave Heating. *Eur. J. Inorg. Chem.* **2013**, *2013*, 4558–4562.
- (206) Zagermann, J.; Molon, M.; Metzler-Nolte, N. Microwave-Assisted Synthesis Of The Tp Sandwich Compound $\text{TpRu}(\text{P-Br-C}_6\text{H}_4\text{Tp})$ And Application Of Its Benzoic Acid Derivative $\text{TpRu}(\text{P}(\text{CO}_2\text{H})\text{-C}_6\text{H}_4\text{Tp})$ In The Covalent Labelling Of Biomolecules. *Dalton Trans* **2011**, *40*, 1011–1015.
- (207) Kuhnert, N.; Danks, T. N. Microwave Accelerated Synthesis Of Cyclopentadienyl Bis-Phosphine Ruthenium(II) Thiolato Complexes Using Focused Microwave Irradiation. *J. Chem. Res.* **2002**, *2002*, 66–68.
- (208) Albrecht, C.; Gauthier, S.; Wolf, J.; Scopelliti, R.; Severin, K. Microwave-Assisted Organometallic Syntheses: Formation of Dinuclear $[(\text{Arene})\text{Ru}(\mu\text{-Cl})_3\text{RuCl}(\text{L-L}')]$ Complexes (L-L': Chelate Ligands with *P*-, *N*-, or *S*-Donor Atoms) by Displacement of Arene π Ligands. *Eur. J. Inorg. Chem.* **2009**, *2009*, 1003–1010.
- (209) Cesari, C.; Sambri, L.; Zucchini, S.; Zanotti, V.; Mazzoni, R. Microwave-Assisted Synthesis of Functionalized Shvo-Type Complexes. *Organometallics* **2014**, *33*, 2814–2819.
- (210) Tardiff, B. J.; Decken, A.; Sean McGrady, G. Microwave-Assisted Synthesis Of $[\text{Os}_2\text{Cl}_3(\text{PEt}_2\text{Ph})_6]\text{Cl}$, Featuring The First Reported X-Ray Crystal Structure. *Inorg. Chem. Commun.* **2008**, *11*, 44–46.
- (211) Romanov, A. S.; Muratov, D. V.; Kudinov, A. R. High-Yield Synthesis Of Osmium Complexes $[(\eta^6\text{-C}_6\text{H}_6)\text{OsCl}_2]_2$, $[\text{CpOs}(\eta^6\text{-C}_6\text{H}_6)]^+$ and $\text{CpOs}(\eta^5\text{-cyclohexadienyl})$. *J. Organomet. Chem.* **2013**, *724*, 177–179.
- (212) Suresh Babu, A. R.; Gavaskar, D.; Raghunathan, R. An Expedient Ultrasonic Assisted One-Pot Four Component Synthesis Of Novel Ferrocene Grafted Pyrrolidine Heterocycles Via [3 + 2]-Cycloaddition Of Azomethine Ylides. *J. Organomet. Chem.* **2013**, *745–746*, 409–416.
- (213) Cappelletti, L.; Vaghi, L.; Rinaldi, L.; Rotolo, L.; Palmisano, G.; Cravotto, G.; Penoni, A. One-Pot Sonochemical Synthesis Of Ferrocenyl Derivatives Via A Three-Component Reaction In Aqueous Media. *Ultrason. Sonochem.* **2015**, *27*, 30–36.
- (214) Aranzaes, J. R.; Astruc, D. Simple Synthesis Of Organo-Iron Complexes From Iron-Sandwich Raw Materials Using Visible Light. *Inorg. Chim. Acta* **2008**, *361*, 1–4.
- (215) Ornelas, C.; Ruiz, J.; Astruc, D. Visible-Light Photolysis Of $[\text{FeCp}(\eta^6\text{-toluene})][\text{PF}_6]$ As A Clean, Convenient And General Route To Iron-Vinylidene And Iron-Acetylde Complexes. *J. Organomet. Chem.* **2009**, *694*, 1219–1222.
- (216) Sierra, M. A.; Mancheño, M. J.; Vicente, R.; Gómez-Gallego, M. Synthesis Of Ferrocene-Substituted 2-Azetidinones. *J. Org. Chem.* **2001**, *66*, 8920–8925.
- (217) Suen, H. F.; Wilson, S. W.; Pomerantz, M.; Walsh, J. L. Photosubstitution Reactions Of Terpyridine Complexes Of Ruthenium(II). *Inorg. Chem.* **1989**, *28*, 786–791.
- (218) Matsubara, Y.; Konno, H.; Kobayashi, A.; Ishitani, O. Quantitative Photochemical Formation of $[\text{Ru}(\text{tpy})(\text{bpy})\text{H}]^+$. *Inorg. Chem.* **2009**, *48*, 10138–10145.
- (219) Padhi, S. K.; Tanaka, K. Photo- and Electrochemical Redox Behavior of Cyclometalated Ru(II) Complexes Having a 3-Phenylbenzo[*b*][1,6]naphthyridine Ligand. *Inorg. Chem.* **2011**, *50*, 10718–10723.
- (220) Cooke, J.; Berry, D. E.; Fawkes, K. L. Photochemical Synthesis and Ligand Exchange Reactions of $\text{Ru}(\text{CO})_4(\eta^2\text{-alkene})$ Compounds. *J. Chem. Educ.* **2007**, *84*, 115–118.
- (221) Gill, T. P.; Mann, K. R. Photochemical Properties Of The Cyclopentadienyl($\eta^6\text{-benzene}$)ruthenium(II) cation. The Synthesis And Reactions Of A Synthetically Useful Intermediate: The Cyclopentadienyltris(acetonitrile)ruthenium(II) Cation. *Organometallics* **1982**, *1*, 485–488.
- (222) Gutierrez, A. C.; Jamison, T. F. Scalable and Robust Synthesis of $\text{CpRu}(\text{MeCN})_3\text{PF}_6$ via Continuous Flow Photochemistry. *J. Flow Chem.* **2012**, *1*, 24–27.
- (223) Gutierrez, A. C.; Jamison, T. F. Continuous Photochemical Generation of Catalytically Active $[\text{CpRu}]^+$ Complexes from $\text{CpRu}(\eta^6\text{-C}_6\text{H}_6)\text{PF}_6$. *Org. Lett.* **2011**, *13*, 6414–6417.
- (224) Braga, D.; Maini, L.; Polito, M.; Grepioni, F. Unexpected Solid-Solid Reaction Upon Preparation Of KBr Pellets And Its Exploitation In Supramolecular Cation Complexation. *Chem. Commun.* **2002**, 2302–2303.
- (225) Ogawa, M.; Hashizume, T.; Kuroda, K.; Kato, C. Intercalation Of 2,2'-Bipyridine And Complex Formation In The Interlayer Space Of Montmorillonite By Solid-Solid Reactions. *Inorg. Chem.* **1991**, *30*, 584–585.

- (226) Batisai, E.; Lusi, M.; Jacobs, T.; Barbour, L. J. A Mechanochemically Synthesised Solid Solution Enables Engineering Of The Sorption Properties Of A Werner Clathrate. *Chem. Commun.* **2012**, *48*, 12171–12173.
- (227) Ofodile, S. E.; Smith, N. O. Liquid Chromatographic Fractionation Of Isotopic *p*-Xylenes With Tetrakis(4-methylpyridine)nickel(II) thiocyanate. *Anal. Chem.* **1981**, *53*, 904–905.
- (228) Ni, J.; Pan, Y.-Z.; Wei, Z.-R.; Cong, Q.; Zhang, D.; Wang, Y.-G.; Liu, X.-Y. The Structures, Solvent-Free Synthesis And Interconversions Of The Complexes $[MCl_2(CEAP)_2]$ And Their Hydrogen-Bonded Salts $[CEAPH]_2[MCl_4]$ $\{M = Zn, Co \text{ and } Hg, CEAP = 4-[N,N\text{-bis}(2\text{-cyanoethyl})\text{amino}]pyridine\}$. *Inorg. Chem. Commun.* **2013**, *30*, 17–20.
- (229) Chen, T.; Liang, B.; Xin, X. Studies on Solid–Solid Reactions between 4-Methylbenzenamine and $CuCl_2 \cdot 2H_2O$, $CoCl_2 \cdot 6H_2O$, and $NiCl_2 \cdot 6H_2O$. *J. Solid State Chem.* **1997**, *132*, 291–293.
- (230) Tigineh, G. T.; Liu, L. K. Studies on Mechanochemistry: Solid Coordination Compounds from Primary Aromatic Amines and Cobalt(II) Chloride Hexahydrate. *J. Chin. Chem. Soc.* **2014**, *61*, 1180–1187.
- (231) Gomes, C. S. B.; Gomes, P. T.; Duarte, M. T. α -Diimine Transition-Metal Complexes: Mechanochemistry – A New Synthetic Approach. *J. Organomet. Chem.* **2014**, *760*, 101–107.
- (232) Cincic, D.; Kaitner, B. Schiff Base Derived From 2-Hydroxy-1-Naphthaldehyde And Liquid-Assisted Mechanochemical Synthesis Of Its Isostructural Cu(II) and Co(II) Complexes. *CrystEngComm* **2011**, *13*, 4351–4357.
- (233) Hernandez, J. G.; Bolm, C. $[Cp^*RhCl_2]_2$: Mechanochemistry And Applications In C-H Bond Functionalisations Under Ball-Milling Conditions. *Chem. Commun.* **2015**, *51*, 12582–12584.
- (234) Schumacher, C.; Crawford, D. E.; Raguž, B.; Glum, R.; James, S. L.; Bolm, C.; Hernández, J. G. Mechanochemical Dehydrocoupling Of Dimethylamine Borane And Hydrogenation Reactions Using Wilkinson's Catalyst. *Chem. Commun.* **2018**, *54*, 8355–8358.
- (235) Mishra, A. P.; Purwar, H.; Jain, R. K.; Gupta, S. K. Microwave Synthesis, Spectral, Thermal And Antimicrobial Studies Of Some Co(II), Ni(II) and Cu(II) Complexes Containing 2-Aminothiazole Moiety. *E-J. Chem.* **2012**, *9*, 1655–1666.
- (236) Ali, S.; Singh, V. Microwave Assisted Synthesis, Spectroscopic Characterization And Biological Screening Of Macrocyclic Metal(II) Complexes Of Malonic Acid Dihydrazide And 5-Chloroisatin. *Der Pharma Chem.* **2016**, *8*, 208–214.
- (237) Aswathy, R.; Mohanan, K. Microwave Assisted Synthesis, Characterisation and Fluorescence Studies of some Transition Metal Complexes with a Luminol Derivative. *J. Fluoresc.* **2017**, *27*, 1171–1181.
- (238) Saha, M.; Nasani, R.; Das, M.; Mobin, S. M.; Pathak, B.; Mukhopadhyay, S. The Effect Of Remote Substitution On The Formation Of Preferential Isomers Of Cobalt(III)-Tetrazolate Complexes By Microwave Assisted Cycloaddition. *Inorg. Chem. Front.* **2014**, *1*, 599–610.
- (239) Taylor, C. J.; Motevalli, M.; Richards, C. J. Synthesis of Planar Chiral Cobalt Metallocenes by Microwave-Assisted Diastereoselective Complexation. *Organometallics* **2006**, *25*, 2899–2902.
- (240) Harcourt, E. M.; Yonis, S. R.; Lynch, D. E.; Hamilton, D. G. Microwave-Assisted Synthesis of Cyclopentadienyl–Cobalt Sandwich Complexes from Diaryl Acetylenes. *Organometallics* **2008**, *27*, 1653–1656.
- (241) Bertrand, G.; Tortech, L.; Fichou, D.; Malacria, M.; Aubert, C.; Gandon, V. An Improved Protocol for the Synthesis of $[(\eta^4\text{-}C_4R_4)Co(\eta^5\text{-}C_5H_5)]$ Complexes. *Organometallics* **2012**, *31*, 126–132.
- (242) Keaney, G. F.; Wood, J. L. Rhodium Perfluorobutyramide $(Rh_2(Pfm)_4)$: A Synthetically Useful Catalyst For Olefin Aziridinations. *Tetrahedron Lett.* **2005**, *46*, 4031–4034.
- (243) Amarante, D.; Cherian, C.; Emmel, C.; Chen, H.-Y.; Dayal, S.; Koshy, M.; Megehee, E. G. Improved Synthetic Routes To Rhodium Bipyridine Complexes: Comparison Of Microwave vs. Conventional Synthesis. *Inorg. Chim. Acta* **2005**, *358*, 2231–2238.
- (244) Dömötör, O.; Aicher, S.; Schmidlehner, M.; Novak, M. S.; Roller, A.; Jakupec, M. A.; Kandioller, W.; Hartinger, C. G.; Keppler, B. K.; Enyedy, E. A. Antitumor Pentamethylcyclopentadienyl Rhodium Complexes Of Maltol And Allomaltol: Synthesis, Solution Speciation And Bioactivity. *J. Inorg. Biochem.* **2014**, *134*, 57–65.
- (245) Baghurst, D. R.; Michael, D.; Mingos, P.; Watson, M. J. Application Of Microwave Dielectric Loss Heating Effects For The Rapid And Convenient Synthesis Of Organometallic Compounds. *J. Organomet. Chem.* **1989**, *368*, C43–C45.
- (246) Pruszyński, M.; Bilewicz, A.; Zalutsky, M. R. Preparation of $Rh[16aneS_4\text{-diol}]^{211}At$ and $Ir[16aneS_4\text{-diol}]^{211}At$ Complexes as Potential Precursors for Astatine Radiopharmaceuticals. Part I: Synthesis. *Bioconjugate Chem.* **2008**, *19*, 958–965.
- (247) Buslaeva, T. M.; Kravchenko, V. V.; Kopylova, E. V.; Kashiricheva, I. I.; Alekseeva, O. A.; Kazantsev, S. S. Synthesis And Structure Of Iridium Complex With Thiocarbamide. *Crystallogr. Rep.* **2008**, *53*, 775–780.
- (248) Yoshikawa, N.; Masuda, Y.; Matsumura-Inoue, T. Rapid Synthesis of New Emitting Ir(III) Polypyridine Complexes. *Chem. Lett.* **2000**, *29*, 1206–1207.
- (249) Yoshikawa, N.; Sakamoto, J.; Matsumura-Inoue, T.; Takashima, H.; Tsukahara, K.; Kanehisa, N.; Kai, Y. Electrochemical And Phosphorescent Properties Of New Ir(III) Complexes Coordinated By Various Bipyridine Derivatives. *Anal. Sci.* **2004**, *20*, 711–716.
- (250) Matsumura-Inoue, T.; Yamamoto, Y.; Yoshikawa, N.; Terashima, M.; Yoshida, Y.; Fujii, A.; Yoshino, K. Microwave Synthesis Of Novel Ir(III) Complexes And Their Application To An Electroluminescence Device. *Opt. Mater.* **2004**, *27*, 187–191.
- (251) Yoshikawa, N.; Matsumura-Inoue, T. Electrochemical And Phosphorescent Properties Of New Mixed-Ligand Ir(III) Complexes Coordinated With Both Terpyridine And Various Bipyridine Derivatives. *Anal. Sci.* **2003**, *19*, 761–765.
- (252) Yoshikawa, N.; Yamabe, S.; Kanehisa, N.; Kai, Y.; Takashima, H.; Tsukahara, K. Synthesis, Characterization, and DFT Investigation of Ir(III) Tollyterpyridine Complexes. *Eur. J. Inorg. Chem.* **2007**, *2007*, 1911–1919.
- (253) Konno, H.; Sasaki, Y. Selective One-pot Synthesis of Facial Tris-ortho-metalated Iridium(III) Complexes Using Microwave Irradiation. *Chem. Lett.* **2003**, *32*, 252–253.
- (254) Saito, K.; et al. Microwave Synthesis of Iridium(III) Complexes: Synthesis of Highly Efficient Orange Emitters in Organic Light-Emitting Devices. *Jpn. J. Appl. Phys.* **2004**, *43*, 2733–2734.
- (255) Hoyano, J. K.; Graham, W. A. G. Oxidative Addition Of The Carbon-Hydrogen Bonds Of Neopentane And Cyclohexane To A Photochemically Generated Iridium(I) Complex. *J. Am. Chem. Soc.* **1982**, *104*, 3723–3725.
- (256) Mak, K. H. G.; Chan, P. K.; Fan, W. Y.; Ganguly, R.; Leong, W. K. Photochemical Reaction of $Cp^*Ir(CO)_2$ with C_6F_5X ($X = CN, F$): Formation of Diiridium(II) Complexes. *Organometallics* **2013**, *32*, 1053–1059.
- (257) Kantchev, E. A. B.; O'Brien, C. J.; Organ, M. G. Palladium Complexes of *N*-Heterocyclic Carbenes as Catalysts for Cross-Coupling Reactions—A Synthetic Chemist's Perspective. *Angew. Chem., Int. Ed.* **2007**, *46*, 2768–2813.
- (258) Cincic, D.; Juribasic, M.; Babic, D.; Molcanov, K.; Sket, P.; Plavec, J.; Curic, M. New Insight Into Solid-State Molecular Dynamics: Mechanochemical Synthesis Of Azobenzene/Triphenylphosphine Palladacycles. *Chem. Commun.* **2011**, *47*, 11543–11545.
- (259) Juribasic, M.; Uzarevic, K.; Gracin, D.; Curic, M. Mechanochemical C-H Bond Activation: Rapid And Regioselective Double Cyclopalladation Monitored By In Situ Raman Spectroscopy. *Chem. Commun.* **2014**, *50*, 10287–10290.
- (260) Aleksanyan, D. V.; Churusova, S. G.; Aysin, R. R.; Klemenkova, Z. S.; Nelyubina, Y. V.; Kozlov, V. A. The First Example Of Mechanochemical Synthesis Of Organometallic Pincer Complexes. *Inorg. Chem. Commun.* **2017**, *76*, 33–35.

- (261) Kumar, R.; Pandey, K.; Mondal, D.; Balakrishna, S. Reaction of PdCl₂ with Diphenylacetylene Revisited: Effect of Solvents and Ball Milling on Cyclization and Crystal Structures of Dimeric Cyclobutenylpalladium Chloride Complexes. *ChemistrySelect* **2018**, *3*, 1242–1247.
- (262) Beillard, A.; Bantreil, X.; Métro, T.-X.; Martinez, J.; Lamaty, F. Mechanochemistry for Facilitated Access To *N,N*-Diaryl NHC Metal Complexes. *New J. Chem.* **2017**, *41*, 1057–1063.
- (263) Adams, C. J.; Lusi, M.; Mutambi, E. M.; Orpen, A. G. Two-Step Mechanochemical Synthesis of Carbene Complexes of Palladium(II) and Platinum(II). *Cryst. Growth Des.* **2017**, *17*, 3151–3155.
- (264) Adams, C. J.; Lusi, M.; Mutambi, E. M.; Guy Orpen, A. Two-Step Solid-State Synthesis Of PEPPSI-Type Compounds. *Chem. Commun.* **2015**, *51*, 9632–9635.
- (265) Adams, C. J.; Haddow, M. F.; Hughes, R. J. L.; Kurawa, M. A.; Orpen, A. G. Coordination Chemistry Of Platinum And Palladium In The Solid-State: Synthesis Of Imidazole And Pyrazole Complexes. *Dalton Trans* **2010**, *39*, 3714–3724.
- (266) Do, J.-L.; Tan, D.; Frišćić, T. Oxidative Mechanochemistry: Direct, Room-Temperature, Solvent-Free Conversion of Palladium and Gold Metals into Soluble Salts and Coordination Complexes. *Angew. Chem., Int. Ed.* **2018**, *57*, 2667–2671.
- (267) Balema, V. P.; Wiench, J. W.; Pruski, M.; Pecharsky, V. K. Solvent-Free Mechanochemical Synthesis Of Two Pt Complexes: *cis*-(Ph₃P)₂PtCl₂ and *cis*-(Ph₃P)₂PtCO₃. *Chem. Commun.* **2002**, 1606–1607.
- (268) Tella, A. C.; Eke, U. B.; Owalude, S. O. Solvent-Free Mechanochemical Synthesis And X-Ray Studies Of Cu(II) And Ni(II) Complexes Of 5-(3,4,5-Trimethoxybenzyl)Pyrimidine-2,4-Diamine (Trimethoprim) In A Ball-Mill. *J. Saudi Chem. Soc.* **2016**, *20*, S376–S381.
- (269) Cindric, M.; Uzelac, M.; Cincic, D.; Halasz, I.; Pavlovic, G.; Hrenar, T.; Curic, M.; Kovacevic, D. Three Routes To Nickel(II) Salicylaldehyde 4-Phenyl And 4-Methylthiosemicarbazonato Complexes: Mechanochemical, Electrochemical And Conventional Approach. *CrystEngComm* **2012**, *14*, 3039–3045.
- (270) Ferguson, M.; Giri, N.; Huang, X.; Apperley, D.; James, S. L. One-Pot Two-Step Mechanochemical Synthesis: Ligand And Complex Preparation Without Isolating Intermediates. *Green Chem.* **2014**, *16*, 1374–1382.
- (271) Crawford, D.; Casaban, J.; Haydon, R.; Giri, N.; McNally, T.; James, S. L. Synthesis By Extrusion: Continuous, Large-Scale Preparation Of MOFs Using Little Or No Solvent. *Chem. Sci.* **2015**, *6*, 1645–1649.
- (272) Mishra, A. P.; Sharma, N.; Jain, R. K. Microwave Synthesis, Spectral, Thermal And Antimicrobial Studies Of Some Ni(II) And Cu(II) Schiff Base Complexes. *Open J. Synth. Theory Appl.* **2013**, *2*, 56–62.
- (273) Jabeen, M.; Mehmood, K.; Khan, M. A.; Nasrullah, M.; Maqbool, T.; Jabeen, F.; Afzal, M. Comparative Study Of Microwave Assisted And Conventional Synthesis Of Furfuraldehyde Based Hydrazone Derivatives And Their Metal Complexes With Biological Evaluation. *Asian J. Chem.* **2017**, *29*, 431–436.
- (274) Shoemaker, K. A.; Leadbeater, N. E. A Fast And Easy Approach To The Synthesis Of Zeise's Salt Using Microwave Heating. *Inorg. Chem. Commun.* **2009**, *12*, 341–342.
- (275) Petruzzella, E.; Chiroasca, C. V.; Heidenga, C. S.; Hoeschele, J. D. Microwave-Assisted Synthesis Of The Anticancer Drug Cisplatin, *cis*-[Pt(NH₃)₂Cl₂]. *Dalton Trans* **2015**, *44*, 3384–3392.
- (276) Carlsson, M.; Eliasson, B. One-Pot Synthesis of *trans* Mono- or Diarylalkynyl Substituted Platinum(II) Compounds with Tertiary Phosphine or Phosphite Ligands. *Organometallics* **2006**, *25*, 5500–5502.
- (277) Januário-Charmier, M. A.; Kukushkin, V. Y.; Pombeiro, A. J. L. Microwave-Assisted [2 + 3] Cycloaddition Of Nitrones To Platinum-(II) And -(IV) Bound Organonitriles. *Dalton Trans* **2003**, 2540–2543.
- (278) Desai, B.; Danks, T. N.; Wagner, G. Ligand Discrimination In The Reaction Of Nitrones With [PtCl₂(PhCN)₂]. Selective Formation Of Mono-Oxadiazoline And Mixed Bis-Oxadiazoline Complexes Under Thermal And Microwave Conditions. *Dalton Trans* **2004**, 166–171.
- (279) Lasri, J.; Januário-Charmier, M. A.; Haukka, M.; Pombeiro, A. J. L. Stereospecific Synthesis of Polysubstituted *E*-Olefins by Reaction of Acyclic Nitrones with Free and Platinum(II) Coordinated Organonitriles. *J. Org. Chem.* **2007**, *72*, 750–755.
- (280) Lasri, J.; Januário-Charmier, M. A.; Guedes da Silva, M. F. C.; Pombeiro, A. J. L. Direct Synthesis Of (Imine)Platinum(II) Complexes By Iminoacylation Of Ketoximes With Activated Organonitrile Ligands. *Dalton Trans* **2006**, 5062–5067.
- (281) Mukhopadhyay, S.; Lasri, J.; Guedes da Silva, M. F. C.; Januário-Charmier, M. A.; Pombeiro, A. J. L. *trans*-Bis[5-(4-fluorophenyl)tetrazolato]bis(triphenylphosphine)platinum(II). *Acta Crystallogr., Sect. E: Struct. Rep. Online* **2007**, *63*, m2656.
- (282) Mukhopadhyay, S.; Lasri, J.; Januário-Charmier, M. A.; Guedes da Silva, M. F. C.; Pombeiro, A. J. L. Microwave Synthesis Of Mono- And Bis-Tetrazolato Complexes Via 1,3-Dipolar Cycloaddition Of Organonitriles With Platinum(Ii)-Bound Azides. *Dalton Trans* **2007**, 5297–5304.
- (283) Smolenski, P.; Mukhopadhyay, S.; Guedes da Silva, M. F. C.; Januário-Charmier, M. A.; Pombeiro, A. J. L. New Water-Soluble Azido- And Derived Tetrazolato-Platinum(II) Complexes With PTA. Easy Metal-Mediated Synthesis And Isolation Of 5-Substituted Tetrazoles. *Dalton Trans* **2008**, 6546–6555.
- (284) Gabano, E.; Gama, S.; Mendes, F.; Fregonese, F.; Paulo, A.; Ravera, M. Application Of Microwave-Assisted Heating To The Synthesis Of Pt(II) Complexes. *Inorg. Chim. Acta* **2015**, *437*, 16–19.
- (285) Castan, P.; Labiad, B.; Villemin, D.; Wimmer, F. L.; Wimmer, S. Solid-State Cyclometallation Of The 1-Methyl-2,4'-Bipyridinium Complexes Of Palladium(II) And Platinum(II). *J. Organomet. Chem.* **1994**, *479*, 153–157.
- (286) Godbert, N.; Pugliese, T.; Aiello, I.; Bellusci, A.; Crispini, A.; Ghedini, M. Efficient, Ultrafast, Microwave-Assisted Syntheses of Cycloplatinated Complexes. *Eur. J. Inorg. Chem.* **2007**, *2007*, 5105–5111.
- (287) Sharma, K.; Singh, R.; Fahmi, N.; Singh, R. V. Microwave Assisted Synthesis, Characterization And Biological Evaluation Of Palladium And Platinum Complexes With Azomethines. *Spectrochim. Acta, Part A* **2010**, *75*, 422–427.
- (288) Winkelmann, O. H.; Navarro, O. Microwave-Assisted Synthesis of *N*-Heterocyclic Carbene- Palladium(II) Complexes. *Adv. Synth. Catal.* **2010**, *352*, 212–214.
- (289) Tu, T.; Malineni, J.; Dötz, K. H. A Novel Pyridine-Bridged Bis-benzimidazolylidene Pincer Palladium Complex: Synthesis and Catalytic Properties. *Adv. Synth. Catal.* **2008**, *350*, 1791–1795.
- (290) Gosiewska, S.; Martinez Herreras, S.; Lutz, M.; Spek, A. L.; Havenith, R. W. A.; van Klink, G. P. M.; van Koten, G.; Gebbink, R. J. M. K. Synthesis, Structure, and Catalytic Performance of Diastereopure Five-Coordinated NCN-Pincer Palladium(II) Complexes Bearing Bulky Amino Acid Substituents. *Organometallics* **2008**, *27*, 2549–2559.
- (291) Dean, M. L.; Schmink, J. R.; Leadbeater, N. E.; Bruckner, C. Microwave-Promoted Insertion Of Group 10 Metals Into Free Base Porphyrins And Chlorins: Scope And Limitations. *Dalton Trans* **2008**, 1341–1345.
- (292) Hanifehpour, Y.; Morsali, A.; Soltani, B.; Mirtamizdoust, B.; Joo, S. W. Ultrasound-Assisted Fabrication Of A Novel Nickel(II)-Bis-Pyrazolyl Borate Two-Nuclear Discrete Nano-Structured Coordination Compound. *Ultrason. Sonochem.* **2017**, *34*, 519–524.
- (293) Rakers, V.; Cadinu, P.; Edel, J. B.; Vilar, R. Development Of Microfluidic Platforms For The Synthesis Of Metal Complexes And Evaluation Of Their DNA Affinity Using Online FRET Melting Assays. *Chem. Sci.* **2018**, *9*, 3459–3469.
- (294) Lipshutz, B. H.; Yamamoto, Y. Introduction: Coinage Metals in Organic Synthesis. *Chem. Rev.* **2008**, *108*, 2793–2795.

- (295) Sun, J.; Dai, F.; Yuan, W.; Bi, W.; Zhao, X.; Sun, W.; Sun, D. Dimerization of a Metal Complex through Thermally Induced Single-Crystal-to-Single-Crystal Transformation or Mechanochemical Reaction. *Angew. Chem., Int. Ed.* **2011**, *50*, 7061–7064.
- (296) Bowmaker, G. A.; Hanna, J. V.; Skelton, B. W.; White, A. H. Solvent-Assisted Solid-State Synthesis: Separating The Chemical From The Mechanical In Mechanochemical Synthesis. *Chem. Commun.* **2009**, 2168–2170.
- (297) Bowmaker, G. A.; Hanna, J. V.; Hart, R. D.; Healy, P. C.; King, S. P.; Marchetti, F.; Pettinari, C.; Skelton, B. W.; Tabacaru, A.; White, A. H. Mechanochemical And Solution Synthesis, X-Ray Structure And IR And ^{31}P Solid State NMR Spectroscopic Studies Of Copper(I) Thiocyanate Adducts With Bulky Monodentate Tertiary Phosphine Ligands. *Dalton Trans* **2012**, *41*, 7513–7525.
- (298) Bowmaker, G. A.; Di Nicola, C.; Pettinari, C.; Skelton, B. W.; Somers, N.; White, A. H. Mechanochemical Synthesis In Copper(II) Halide/Pyridine Systems: Single Crystal X-Ray Diffraction And IR Spectroscopic Studies. *Dalton Trans* **2011**, *40*, 5102–5115.
- (299) Bowmaker, G. A.; Hanna, J. V.; Hart, R. D.; Skelton, B. W.; White, A. H. The Role Of Short-Range Diffusion In Solvent-Assisted Mechanochemical Synthesis Of Metal Complexes. *Dalton Trans* **2008**, 5290–5292.
- (300) Guo, F.; Shao, H.-d.; Yang, Q.; Famulari, A.; Marti-Rujas, J. Mechanochemical Dehydrochlorination And Chelation Reaction In The Solid State: From A Molecular Salt To A Coordination Complex. *CrystEngComm* **2014**, *16*, 969–973.
- (301) Braga, D.; Grepioni, F.; Maini, L.; Brescello, R.; Cotarca, L. Simple And Quantitative Mechanochemical Preparation Of The First Zinc And Copper Complexes Of The Neuroleptic Drug Gabapentin. *CrystEngComm* **2008**, *10*, 469–471.
- (302) Ohara, H.; Kobayashi, A.; Kato, M. Simple Manual Grinding Synthesis of Highly Luminescent Mononuclear Cu(I)-Iodide Complexes. *Chem. Lett.* **2014**, *43*, 1324–1326.
- (303) Kobayashi, A.; Hasegawa, T.; Yoshida, M.; Kato, M. Environmentally Friendly Mechanochemical Syntheses and Conversions of Highly Luminescent Cu(I) Dinuclear Complexes. *Inorg. Chem.* **2016**, *55*, 1978–1985.
- (304) Beillard, A.; Métro, T.-X.; Bantreil, X.; Martinez, J.; Lamaty, F. Cu(0), O₂ And Mechanical Forces: A Saving Combination For Efficient Production Of Cu-NHC Complexes. *Chem. Sci.* **2017**, *8*, 1086–1089.
- (305) Fang, G.; Bi, X. Silver-Catalysed Reactions Of Alkynes: Recent Advances. *Chem. Soc. Rev.* **2015**, *44*, 8124–8173.
- (306) Roland, S.; Jolival, C.; Cresteil, T.; Eloy, L.; Bouhours, P.; Hequet, A.; Mansuy, V.; Vanucci, C.; Paris, J.-M. Investigation of a Series of Silver–N-Heterocyclic Carbenes as Antibacterial Agents: Activity, Synergistic Effects, and Cytotoxicity. *Chem. - Eur. J.* **2011**, *17*, 1442–1446.
- (307) Eloy, L.; Jarrousse, A.-S.; Teyssot, M.-L.; Gautier, A.; Morel, L.; Jolival, C.; Cresteil, T.; Roland, S. Anticancer Activity of Silver–N-Heterocyclic Carbene Complexes: Caspase-Independent Induction of Apoptosis via Mitochondrial Apoptosis-Inducing Factor (AIF). *ChemMedChem* **2012**, *7*, 805–814.
- (308) Iqbal, M. A.; Umar, M. I.; Haque, R. A.; Khadeer Ahamed, M. B.; Asmawi, M. Z. B.; Majid, A. M. S. A. Macrophage And Colon Tumor Cells As Targets For A Binuclear Silver(I) N-Heterocyclic Carbene Complex, An Anti-Inflammatory And Apoptosis Mediator. *J. Inorg. Biochem.* **2015**, *146*, 1–13.
- (309) Bowmaker, G. A.; Chaichit, N.; Pakawatchai, C.; Skelton, B. W.; White, A. H. Solvent-Assisted Mechanochemical Synthesis Of Metal Complexes. *Dalton Trans* **2008**, 2926–2928.
- (310) Bowmaker, G. A.; Pakawatchai, C.; Saithong, S.; Skelton, B. W.; White, A. H. Structural And Spectroscopic Studies Of Some Adducts Of Silver(I) Halides With Thiourea And N-Ethyl Substituted Thioureas. *Dalton Trans* **2010**, *39*, 4391–4404.
- (311) Bowmaker, G. A.; Pakawatchai, C.; Saithong, S.; Skelton, B. W.; White, A. H. 1:1 Complexes Of Silver(I) Thiocyanate With (Substituted) Thiourea Ligands. *Dalton Trans* **2009**, 2588–2598.
- (312) Bowmaker, G. A.; Effendy; Hanna, J. V.; Healy, P. C.; King, S. P.; Pettinari, C.; Skelton, B. W.; White, A. H. Solution And Mechanochemical Syntheses, And Spectroscopic And Structural Studies In The Silver(I) (Bi-)Carbonate: Triphenylphosphine System. *Dalton Trans* **2011**, *40*, 7210–7218.
- (313) Bowmaker, G. A.; Hanna, J. V.; Skelton, B. W.; White, A. H. Mechanochemical And Solution Synthesis, And Crystal Structures And IR And Solid-State (CPMAS) NMR Spectroscopy Of Some Bis(Triphenylphosphine)Silver(I) Mono- And Di-Hydrogencitrate Systems. *Dalton Trans* **2012**, *41*, 5409–5417.
- (314) Beillard, A.; Golliard, E.; Gillet, V.; Bantreil, X.; Métro, T.-X.; Martinez, J.; Lamaty, F. Expedient Mechanochemical Synthesis of N,N-Dialkyl Imidazoliums and Silver(I)–Carbene Complexes in a Ball-Mill. *Chem. - Eur. J.* **2015**, *21*, 17614–17617.
- (315) Beillard, A.; Bantreil, X.; Métro, T.-X.; Martinez, J.; Lamaty, F. Unraveling The Synthesis Of Homoleptic [Ag(N,N-Diaryl-NHC)₂]Y (Y = BF₄, PF₆) Complexes By Ball-Milling. *Dalton Trans* **2016**, *45*, 17859–17866.
- (316) Egbert, J. D.; Slawin, A. M. Z.; Nolan, S. P. Synthesis of N-Heterocyclic Carbene Gold Complexes Using Solution-Phase and Solid-State Protocols. *Organometallics* **2013**, *32*, 2271–2274.
- (317) Do, J. L.; Tan, D.; Friščić, T. Oxidative Mechanochemistry: Direct, Room-Temperature, Solvent-Free Conversion of Palladium and Gold Metals into Soluble Salts and Coordination Complexes. *Angew. Chem., Int. Ed.* **2018**, *57*, 2667–2671.
- (318) Jobbágy, C.; Baranyai, P.; Marsi, G.; Rácz, B.; Li, L.; Naumov, P.; Deák, A. Novel Gold(I) Diphosphine-Based Dimers With Auophilicity Triggered Multistimuli Light-Emitting Properties. *J. Mater. Chem. C* **2016**, *4*, 10253–10264.
- (319) Sharma, R. K.; Sharma, C.; Sidhwani, I. T. Solventless and One-Pot Synthesis of Cu(II) Phthalocyanine Complex: A Green Chemistry Experiment. *J. Chem. Educ.* **2011**, *88*, 86–87.
- (320) Landers, B.; Navarro, O. Microwave-Assisted Synthesis of (N-Heterocyclic carbene)MCl Complexes of Group 11 Metals. *Eur. J. Inorg. Chem.* **2012**, *2012*, 2980–2982.
- (321) Lenker, H. K.; Gray, T. G.; Stockland, R. A. Rapid Synthesis Of Arylgold Compounds Using Dielectric Heating. *Dalton Trans* **2012**, *41*, 13274–13276.
- (322) Shaw, A. P.; Tilset, M.; Heyn, R. H.; Jakobsen, S. Microwave Methods For The Synthesis Of Gold(III) Complexes. *J. Coord. Chem.* **2011**, *64*, 38–47.
- (323) Hojaghani, S.; Hosaini Sadr, M.; Morsali, A. Sonochemical Synthesis Of Two New Copper(II) Complexes With Azo Ligands Derived From Anthranilic Acid And β -Naphthol. *Ultrason. Sonochem.* **2015**, *26*, 305–311.
- (324) Catalano, V. J.; Malwitz, M. A. Short Metal–Metal Separations in a Highly Luminescent Trimetallic Ag(I) Complex Stabilized by Bridging NHC Ligands. *Inorg. Chem.* **2003**, *42*, 5483–5485.
- (325) Opalka, S. M.; Park, J. K.; Longstreet, A. R.; McQuade, D. T. Continuous Synthesis and Use of N-Heterocyclic Carbene Copper(I) Complexes from Insoluble Cu₂O. *Org. Lett.* **2013**, *15*, 996–999.
- (326) Chapman, M. R.; Shafi, Y. M.; Kapur, N.; Nguyen, B. N.; Willans, C. E. Electrochemical Flow-Reactor For Expedient Synthesis Of Copper-N-Heterocyclic Carbene Complexes. *Chem. Commun.* **2015**, *51*, 1282–1284.
- (327) Crawford, D. E.; Miskimmin, C. K.; Cahir, J.; James, S. L. Continuous Multi-Step Synthesis By Extrusion – Telescoping Solvent-Free Reactions For Greater Efficiency. *Chem. Commun.* **2017**, *53*, 13067–13070.
- (328) Fernández-Bertrán, J. F.; Hernández, M. P.; Reguera, E.; Yee-Madeira, H.; Rodriguez, J.; Paneque, A.; Llopiz, J. C. Characterization Of Mechanochemically Synthesized Imidazolates Of Ag⁺, Zn²⁺, Cd²⁺, and Hg²⁺: Solid State Reactivity Of nd¹⁰ Cations. *J. Phys. Chem. Solids* **2006**, *67*, 1612–1617.
- (329) Crawford, D. E.; James, S. L.; McNally, T. Use of Batch Mixing To Investigate the Continuous Solvent-Free Mechanical Synthesis of OLED Materials by Twin-Screw Extrusion (TSE). *ACS Sustainable Chem. Eng.* **2018**, *6*, 193–201.

- (330) Bagley, M. C.; Lin, Z.; Pope, S. J. A. Microwave-Assisted Synthesis And Complexation Of Luminescent Cyanobipyridyl-Zinc(II) Bis(Thiolate) Complexes With Intrinsic And Ancillary Photo-physical Tunability. *Dalton Trans* **2010**, 39, 3163–3166.
- (331) Akabane, T.; Ohta, K.; Takizawa, T.; Matsuse, T.; Kimura, M. Discotic Liquid Crystals Of Transition Metal Complexes, 54: Rapid Microwave-Assisted Synthesis And Homeotropic Alignment Of Phthalocyanine-Based Liquid Crystals. *J. Porphyrins Phthalocyanines* **2017**, 21, 476–492.
- (332) Yadav, M.; Mishra, N.; Sharma, N.; Chandra, S.; Kumar, D. Microwave Assisted Synthesis, Characterization And Biocidal Activities Of Some New Chelates Of Carbazole Derived Schiff Bases Of Cadmium And Tin Metals. *Spectrochim. Acta, Part A* **2014**, 132, 733–742.
- (333) Paqhaleh, D. M. S.; Hashemi, L.; Amani, V.; Morsali, A.; Aminjanov, A. A. Synthesis Of Two New Nano-Structured Mercury(II) Complexes With 4-Methyl-4H-1,2,4-Triazole-3-Thiol Ligand By Sonochemical Method. *Inorg. Chim. Acta* **2013**, 407, 1–6.
- (334) Ma, X.; Lim, G. K.; Harris, K. D. M.; Apperley, D. C.; Horton, P. N.; Hursthouse, M. B.; James, S. L. Efficient, Scalable, and Solvent-free Mechanochemical Synthesis of the OLED Material Alq₃ (q = 8-Hydroxyquinolate). *Cryst. Growth Des.* **2012**, 12, 5869–5872.
- (335) Wang, J.; Ganguly, R.; Yongxin, L.; Diaz, J.; Soo, H. S.; Garcia, F. A Multi-Step Solvent-Free Mechanochemical Route To Indium(III) Complexes. *Dalton Trans* **2016**, 45, 7941–7946.
- (336) Wang, J.; Ganguly, R.; Yongxin, L.; Diaz, J.; Soo, H. S.; Garcia, F. Synthesis and the Optical and Electrochemical Properties of Indium(III) Bis(arylimino)acenaphthene Complexes. *Inorg. Chem.* **2017**, 56, 7811–7820.
- (337) Prochowicz, D.; Franckevicius, M.; Cieslak, A. M.; Zakeeruddin, S. M.; Gratzel, M.; Lewinski, J. Mechanochemical Synthesis Of The Hybrid Perovskite CH₃NH₃PbI₃: Characterization And The Corresponding Solar Cell Efficiency. *J. Mater. Chem. A* **2015**, 3, 20772–20777.
- (338) Nath, M.; Vats, M.; Roy, P. Design And Microwave-Assisted Synthesis Of Tri- And Dialkyltin(IV) Hippurates, Characterization, In Vitro Anti-Cancer And In Vivo Anti-Inflammatory Activities. *Med. Chem. Res.* **2015**, 24, 51–62.
- (339) Singh, R. V.; Chaudhary, P.; Chauhan, S.; Swami, M. Microwave-Assisted Synthesis, Characterization And Biological Activities Of Organotin (IV) Complexes With Some Thio Schiff Bases. *Spectrochim. Acta, Part A* **2009**, 72, 260–268.
- (340) Singh, R. V.; Chaudhary, P.; Poonia, K.; Chauhan, S. Microwave-Assisted Synthesis, Characterization And Biological Screening Of Nitrogen–Sulphur And Nitrogen–Oxygen Donor Ligands And Their Organotin(IV) Complexes. *Spectrochim. Acta, Part A* **2008**, 70, 587–594.
- (341) Dawara, L.; Singh, D.; Singh, R. V. Antimicrobial And Pesticidal Activity Of Some Organogermanium(IV) Complexes Synthesized Under Microwave Irradiation. *Main Group Met. Chem.* **2011**, 34, 69–75.
- (342) Shahrjerdi, A.; Hosseiny Davarani, S. S.; Najafi, E.; Amini, M. M. Sonochemical Synthesis Of A New Nano Lead(II) Complex With Quinoline-2-Carboxylic Acid Ligand: A Precursor To Produce Pure Phase Nano-Sized Lead(II) Oxide. *Ultrason. Sonochem.* **2015**, 22, 382–390.
- (343) Shahrjerdi, A.; Davarani, S. S. H.; Amini, M. M.; Najafi, E.; Janghouri, M.; Mohajerani, E.; Dehpour, A. Sonochemical Synthesis Of A Nanoscale Complex Of Lead(II) And 2-Methyl-8-Hydroxyquinoline: Spectroscopic, Photoluminescence, Thermal Analysis Studies And Its Application In An OLED. *J. Mater. Sci.* **2014**, 49, 441–449.
- (344) Kesari, Y.; Athawale, A. Ultrasound Assisted Bulk Synthesis Of CH₃NH₃PbI₃ Perovskite At Room Temperature. *Mater. Lett.* **2015**, 159, 87–89.
- (345) Bhooshan Kumar, V.; Gouda, L.; Porat, Z. e.; Gedanken, A. Sonochemical Synthesis Of CH₃NH₃PbI₃ Perovskite Ultrafine Nanocrystal Sensitizers For Solar Energy Applications. *Ultrason. Sonochem.* **2016**, 32, 54–59.
- (346) Rightmire, N. R.; Bruns, D. L.; Hanusa, T. P.; Brennessel, W. W. Mechanochemical Influence on the Stereoselectivity of Halide Metathesis: Synthesis of Group 15 Tris(allyl) Complexes. *Organometallics* **2016**, 35, 1698–1706.
- (347) Urano, M.; Wada, S.; Suzuki, H. A Novel Dry Route To Ortho-Functionalized Triarylbiuranes That Are Difficult To Access By Conventional Wet Routes. *Chem. Commun.* **2003**, 1202–1203.
- (348) Woen, D. H.; Kotyk, C. M.; Mueller, T. J.; Ziller, J. W.; Evans, W. J. Tris(pentamethylcyclopentadienyl) Complexes of Late Lanthanides Tb, Dy, Ho, and Er: Solution and Mechanochemical Syntheses and Structural Comparisons. *Organometallics* **2017**, 36, 4558–4563.
- (349) Kumari, B. S.; Rijulal, G.; Mohanan, K. Microwave Assisted Synthesis, Spectroscopic, Thermal and Biological Studies of Some Lanthanide(III) Chloride Complexes with a Heterocyclic Schiff Base. *Synth. React. Inorg. Met.-Org. Nano-Met. Chem.* **2009**, 39, 24–30.
- (350) Mohanan, K.; Kumari, B. S.; Rijulal, G. Microwave Assisted Synthesis, Spectroscopic, Thermal, And Antifungal Studies Of Some Lanthanide(III) Complexes With A Heterocyclic Bishydrazone. *J. Rare Earths* **2008**, 26, 16–21.
- (351) Nakashima, K.; Masuda, Y.; Matsumura-Inoue, T.; Kakihana, M. Microwave-Assisted Synthesis Of (Tris-Acetylacetonato)(2,9-Dimethyl-4,7-Diphenyl-1,10-Phenanthroline)Terbium(III) Complex With Outstanding High Green Luminescence. *J. Lumin.* **2009**, 129, 243–245.
- (352) Wang, X. J.; Zhou, X. C. Microwave Synthesis And Characterization Of Europium Complexes With Cinnamic Acid And 2,2'-Bipyridine. *Adv. Mater. Res.* **2013**, 670, 106–109.
- (353) Zhou, X. C.; Zhong, L. P.; Lin, J. Y. Microwave Synthesis And Characterization Of Europium Complexes With Cinnamic Acid And Phenanthroline. *Russ. J. Coord. Chem.* **2009**, 35, 460–463.