



**HAL**  
open science

## **Parallel Active Filtering based on a three –phase multicell converter**

Emmanuel Yofo, Philippe Djondiné

► **To cite this version:**

Emmanuel Yofo, Philippe Djondiné. Parallel Active Filtering based on a three –phase multicell converter. SCIREA Journal of Electrical Engineering, 2019, 4, pp.48 - 62. <hal-02318712>

**HAL Id: hal-02318712**

**<https://hal.science/hal-02318712v1>**

Submitted on 18 Oct 2019

**HAL** is a multi-disciplinary open access archive for the deposit and dissemination of scientific research documents, whether they are published or not. The documents may come from teaching and research institutions in France or abroad, or from public or private research centers.

L'archive ouverte pluridisciplinaire **HAL**, est destinée au dépôt et à la diffusion de documents scientifiques de niveau recherche, publiés ou non, émanant des établissements d'enseignement et de recherche français ou étrangers, des laboratoires publics ou privés.



HAL Authorization



## Parallel Active Filtering based on a three –phase multicell converter

Emmanuel Yoyo<sup>2</sup>, Philippe Djondiné<sup>1,2</sup>

<sup>1</sup>Department of Physics, Higher Teacher Training's College of Bertoua, The University of Ngaoundéré, Cameroun, [pdjondine@yahoo.fr](mailto:pdjondine@yahoo.fr)

<sup>2</sup>Department of Physics, Faculty of Science, The University of Ngaoundéré, Cameroun, [emmanuel\\_yoyo@yahoo.fr](mailto:emmanuel_yoyo@yahoo.fr)

### ABSTRACT

The energy issues related to the quality of the distribution of electrical energy require the development of active filtering devices of electrical networks. By injecting a current in phase opposition with the harmonics of the load (disruptive currents), the active power filter makes it possible to improve the quality of the electrical energy sampling and thus answers this problem. The aim of this article is based on the use of a three – phase multicellular converter with three switching cells per phase, to perform this function. The four voltage levels of this inverter provide the frequency benefits we will use. We start by modeling the filter in the sense of the instantaneous values and then we present its triangulo-sinusoidal control strategy. Subsequently we will develop the steps of the filter control. We finish by presenting the results of simulations of the harmonic current compensation.

**Keywords:** Active power filter, flying capacitor inverter, harmonics, Power quality

## **1. Introduction**

As society evolves, energy issues come to the first plan. The control of energy consumption, production and distribution is essential to ensure the balance of the general power distribution system. Electrical energy is a leading energy because it is easily transportable and can be produced in a clean way (hydraulic, wind, solar). Transport between consumers and producers is provided by high voltage power grids.

With the increase of isolated producers (energy injection by individuals ...) and consumers, the network is more and more subject to energy fluctuations, which was not taken into account in the model same network. To cope with risks of instability, it is important to implement devices to ensure the good quality of energy.

The devices of the power electronics are more and more present on the electrical networks (filter, FACTS, inverter ...) and can help to manage the electricity network. Based on this observation, the purpose of this paper is to use an advanced structure of the power electronics multicellular converter to perform a filtering function of the electrical network. This converter makes it possible by its structure to increase the voltage level and offers advantages at the frequency level. We will use this converter for an active filtering application, which involves injecting currents into a network to improve the quality of available currents or voltages [9].

In fact, the main role of active filtering is to control the harmonic distortion in an active way by the compensation of the harmonics present in the electrical network at any moment in time [1, 2, 3].

The second part of this article focuses on the modeling and control of the active filter. In this section, the filter principle and the structure of the three-phase inverter are presented. The principle of obtaining the reference and control currents of the inverter bridge closes the section. The third part presents the results of the simulations. A conclusion and perspectives constitute the last part of the document.

## **2. Modeling and controlling the filter**

### **2.1 Principle of the parallel active filter**

The principle of the parallel active filter consists in generating harmonics in opposition to those existing on the network. This can be schematized in figure 1. While the current

absorbed by the polluting load is non-sinusoidal, the current created by the active filter is such that the current absorbed by the network is sinusoidal [4, 5].

## 2.2. General structure of an active filter

An active filter is composed of four parts as shown in figure 2 [8]. The power part consists of a power storage circuit, an inverter for distributing the current in the different phases and an output filter for to realize the interface between the network and the inverter. The control part takes into account the energy storage circuit, the output filter and the harmonics on the network and makes it possible to actuate the inverter circuit.

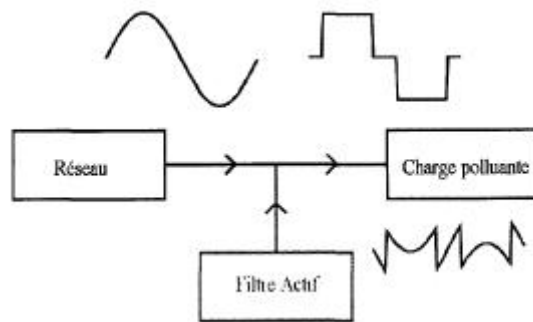

Fig. 1. Active filter principle

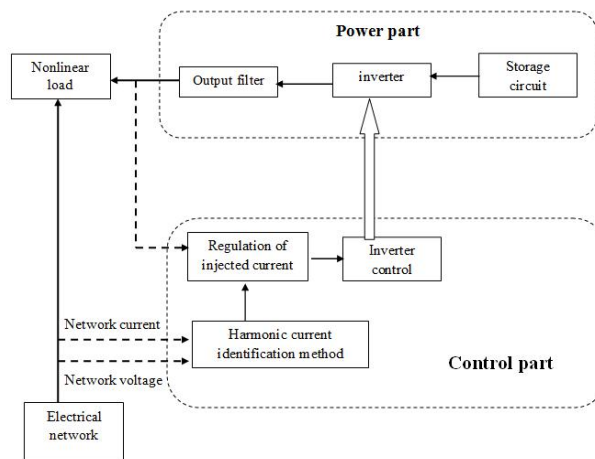

Fig. 2. General structure of an active filter

❖ **Inverter** : Two types of structures are possible: the so-called current and the so-called voltage. Our study focuses on the so-called current structure. The electro technical structure of a current inverter or current switch is shown schematically in figure 3 it is a matter of switching a current in the different phases [5]. The direct current is switched in the different phases by a combination of the different switches. These three-phase currents can be placed in the  $\alpha, \beta$  coordinate system by Concordia transformation. It is by a combination of these states

that a reference current can be reached [7]. However, since the network is inductive, it is not possible to directly connect the inverter. An input filter must be inserted between the network and the inverter. It is necessary to make close attention to the control of the filter because it can create oscillations which lead to a divergent regime.

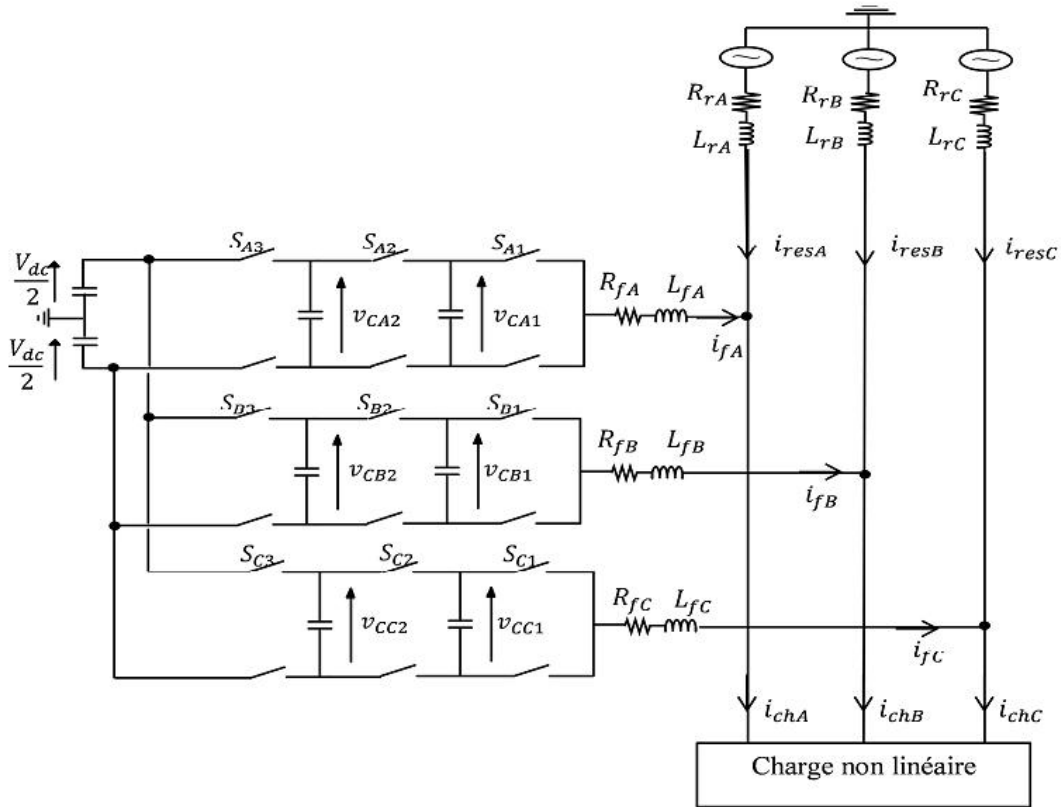
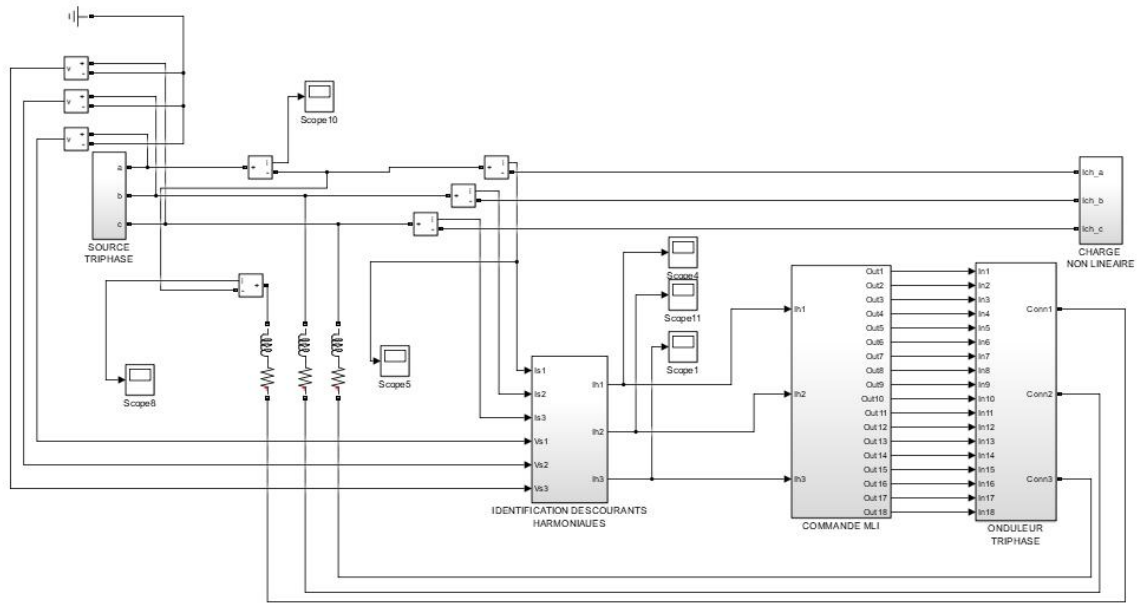

Fig. 3. Active filter based on a three phase multicell inverter

## 2.3 Active filter control

### 2.3.1 Obtaining references

The control strategy is based on the detection of disturbing currents in the time domain. It is a question of identifying these disturbing currents known as reference currents from the detection of the current of the polluting load [15]. The system is therefore equivalent to a network with a single polluting load. For our case, it is this assumption that is made as shown in figure 4. The point of operation of the load is unknown, only the current absorbed is measured. The harmonic references are obtained by taking the current of the load and the voltage at the point of connection of the active filter to the network. The method used is based on the calculation of instantaneous powers. This principle consists in separating the fundamental from the rest of the signal [6]. This is done by putting it in the "continuous domain" while the harmonics are in the "frequency domain".



**Fig. 4. Matlab/Simulink Model of nonlinear loads connected to grid along with APF using multilevel inverter**

Voltages and currents are placed in the axis system  $(\alpha, \beta, 0)$  by the Concordia transformation.

$$\begin{bmatrix} V_0 \\ V_\alpha \\ V_\beta \end{bmatrix} = \sqrt{\frac{2}{3}} \begin{bmatrix} \frac{1}{\sqrt{2}} & \frac{1}{\sqrt{2}} & \frac{1}{\sqrt{2}} \\ 1 & -\frac{1}{2} & -\frac{1}{2} \\ 0 & \frac{\sqrt{3}}{2} & -\frac{\sqrt{3}}{2} \end{bmatrix} \begin{bmatrix} V_{S1} \\ V_{S2} \\ V_{S3} \end{bmatrix} \quad (1)$$

And the relationship of currents below:

$$\begin{bmatrix} I_0 \\ I_\alpha \\ I_\beta \end{bmatrix} = \sqrt{\frac{2}{3}} \begin{bmatrix} \frac{1}{\sqrt{2}} & \frac{1}{\sqrt{2}} & \frac{1}{\sqrt{2}} \\ 1 & -\frac{1}{2} & -\frac{1}{2} \\ 0 & \frac{\sqrt{3}}{2} & -\frac{\sqrt{3}}{2} \end{bmatrix} \begin{bmatrix} I_{S1} \\ I_{S2} \\ I_{S3} \end{bmatrix} \quad (2)$$

The components with index (0) represent homopolar sequences of the three-phase system of current and voltage. It is thus possible to calculate the quantities P and Q [17] such that:

$$\begin{bmatrix} P \\ Q \end{bmatrix} = \begin{bmatrix} V_\alpha & V_\beta \\ -V_\beta & V_\alpha \end{bmatrix} \begin{bmatrix} I_\alpha \\ I_\beta \end{bmatrix} \quad (3)$$

Harmonics of the same frequency, current and voltage will generate a DC component while products of different frequencies will give an AC component. If the voltage is initially

sinusoidal, the DC component of the powers is relative to the fundamental current. Filtering this DC component amounts to keeping only the harmonic components of the current

$$\begin{bmatrix} I_\alpha \\ I_\beta \end{bmatrix} = \frac{1}{V_{S\alpha}^2 + V_{S\beta}^2} \begin{bmatrix} V_{S\alpha} & -V_{S\beta} \\ V_{S\beta} & V_{S\alpha} \end{bmatrix} \begin{bmatrix} \tilde{P} \\ \tilde{Q} \end{bmatrix} \quad (4)$$

The current references in the three-phase reference are therefore:

$$\begin{bmatrix} I_{\text{ref1}} \\ I_{\text{ref2}} \\ I_{\text{ref3}} \end{bmatrix} = \sqrt{\frac{2}{3}} \begin{bmatrix} 1 & 0 \\ -\frac{1}{2} & \frac{\sqrt{3}}{2} \\ \frac{1}{2} & -\frac{\sqrt{3}}{2} \end{bmatrix} \begin{bmatrix} I_\alpha \\ I_\beta \end{bmatrix} \quad (5)$$

The scheme for obtaining the harmonic references for the active filter is given in figure 5. It should be noted that in the presence of a non-sinusoidal voltage, the reference current is somewhat deformed. In fact, this is explained by the presence of voltage harmonics of the same rank as the current harmonics making part of them disappear when filtering powers P and Q [12, 13, 14]. By filtering the voltage, the result is therefore more satisfactory.

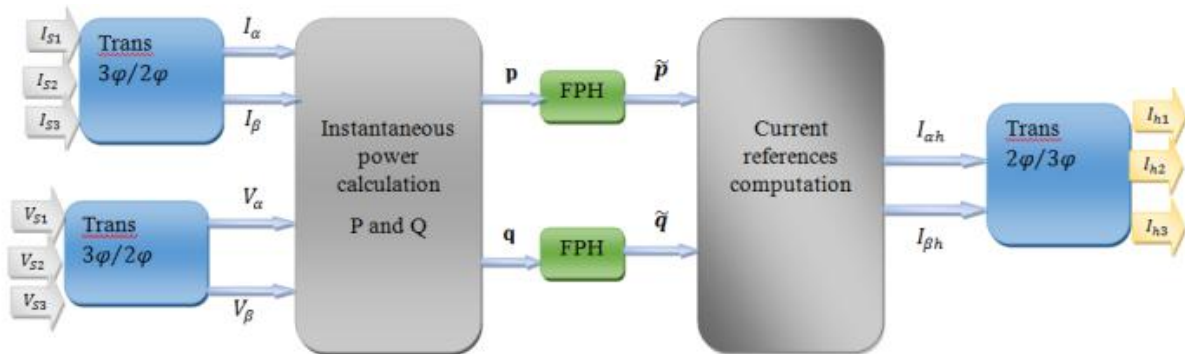

Fig. 5. Harmonic reference calculation principle

### 2.3.2 Compensation of losses

The harmonic references being calculated, the bridge which will generate these currents will have losses making decreasing the loop voltage [10, 11]. It is therefore necessary to compensate them. For this, a regulation not of the voltage but of the square of this one allows the simple computation of a current corresponding to the active power necessary to compensate the losses. This regulator can be of proportional type, first order filter or Proportional Integral (P.I.). This active current reference obtained is added to the harmonic current references.

### 2.3.3 Inverter bridge control

From these references, it is necessary to control the power bridge to effectively generate the desired currents. For this different techniques are used. The most frequently used is the hysteresis method or "all or nothing" or "sliding mode", which consists of a comparison on each phase of the current of the filter and the reference as shown in figure 6. This method very easy to implement even in analog is robust and fast. Its disadvantage is a switching frequency of the switches depending on many parameters current of the load, width of the hysteresis band, voltage of the loop. The other method, pulse width modulation (PWM), calculates the voltage needed at the bridge terminals to generate the desired current [16] as shown in Figure 6. This is the method we used.

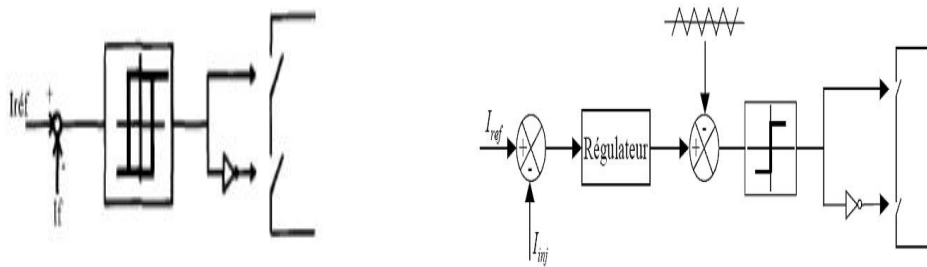

Fig. 6. Hysteresis and PWM control principle

### 3. Simulation results

The performance of the proposed SRF (Synchronous Reference Frame) controller based parallel active filter is evaluated through Matlab/Simulink power tools. The system parameters values are shown in table 1.

TABLE I System parameters and values

Parameters	Values
Storage capacity	$C_{dc} = 20mF$
Initial capacitor voltage	$V_{dc} = 600 V$
Electrical network	$V_s = 220 V, f = 50 Hz, (R_s = 0.5 m\Omega, L_s = 15 \mu H)$
Pollutant load	$R_{ch} = 1.7 \Omega, L_{ch} = 1.5 mH$
Output filter	$R_f = 0.65 \Omega, L_f = 0.5 \mu H$

The presence of current harmonics caused by the three-phase rectifier bridge has deformed the shape of the grid current. Figure 7 illustrates this anomaly.

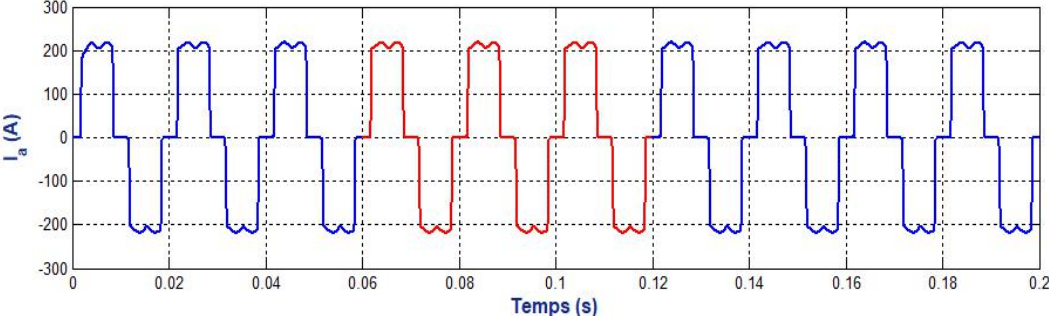

**Fig. 7. Current waveform before filtering.**

Using the Fast Fourier Transform, we quickly obtain the frequency spectrum of the current (Figure 8). This tool also allows us to calculate the THD of the signal obtained. The part of the curve in red corresponds to the 3 periods on which the analysis is made.

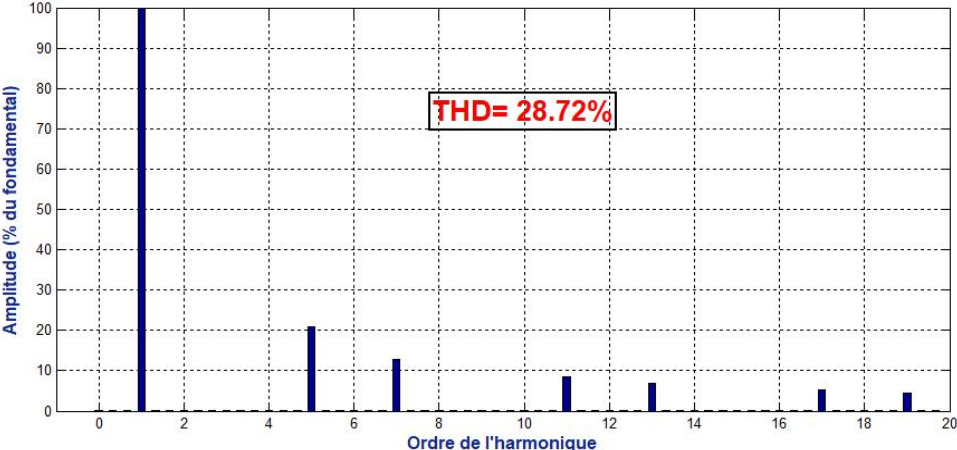

**Fig. 8. Frequency spectrum of the current before filtering:**

The THD found is 28.72% and represents a value well above the limit set by the standards in force. When we connect our parallel active filter, the reference current calculated by the block of instantaneous powers is represented by figure 9.

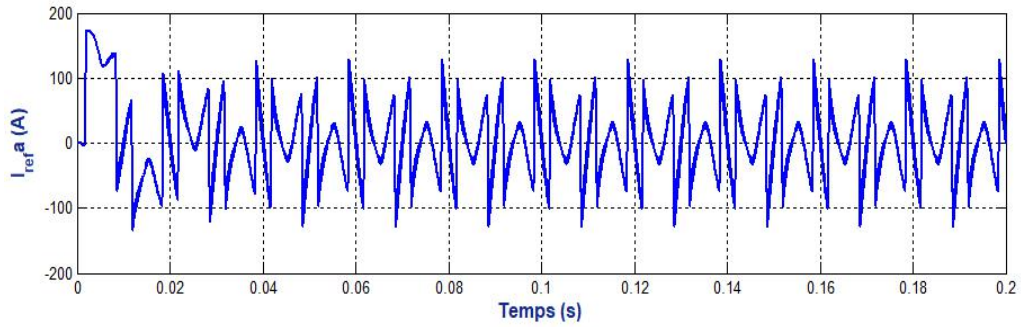

**Fig. 9. Reference current of the filter:**

This current is then injected via our MLI-controlled inverter into the network and in phase opposition. The current after filtering is given in Figure 10.

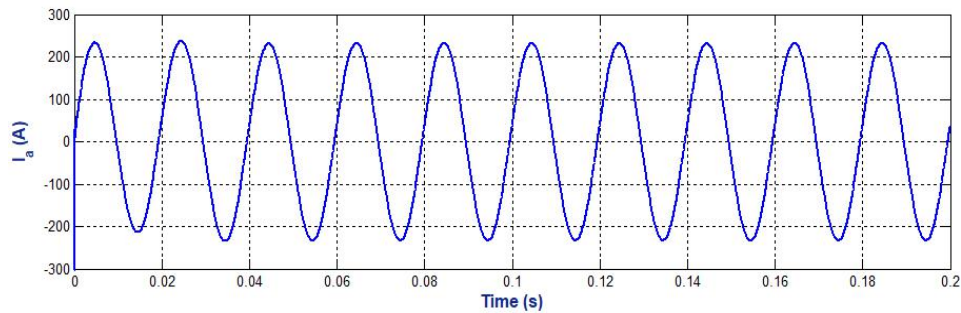

**Fig. 10. Network current after filtering**

Taking into account the transient regime, we opt to analyze this signal as a function of an initial time  $t$  and in an interval  $[t; 3T]$ . Where  $T$  is the period of the signal.

For  $t = 0s$  we have:

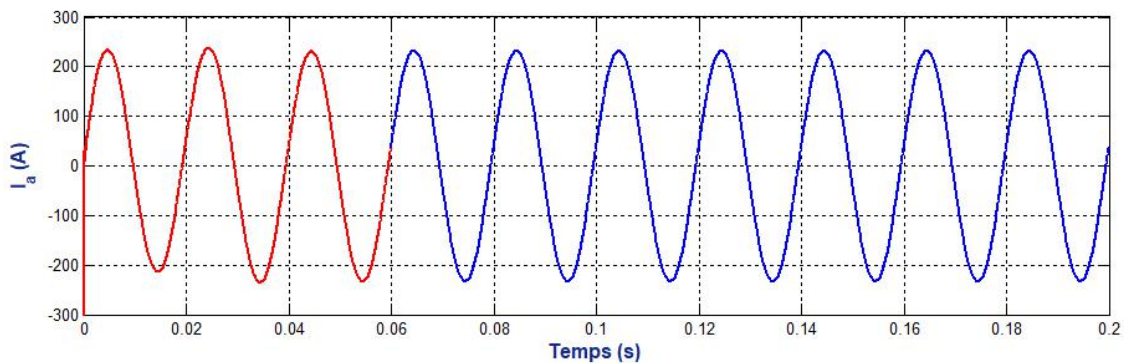

**Fig. 11. Network current after filtering ( $t = 0s$ )**

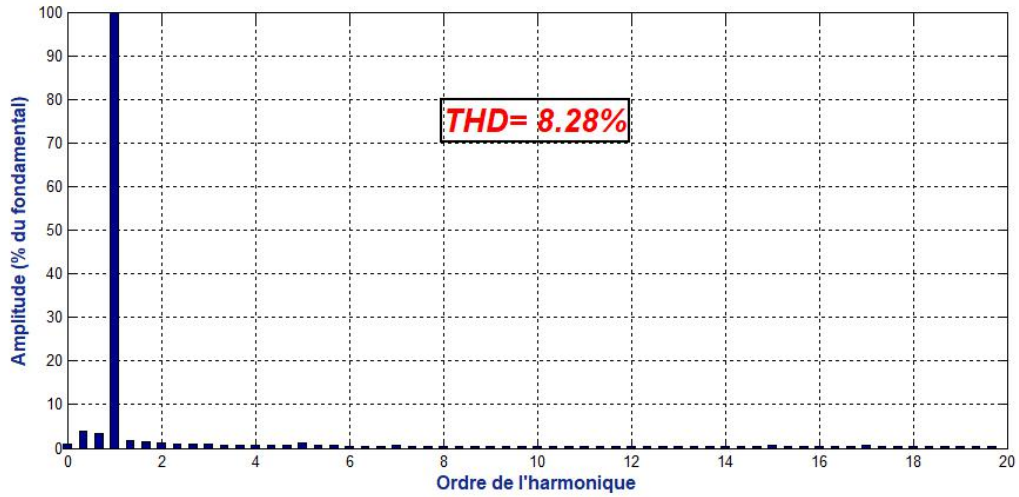

Fig. 12. Spectrum of the current after filtering for  $t = 0$ s.

For  $t = 0.02$ s we have:

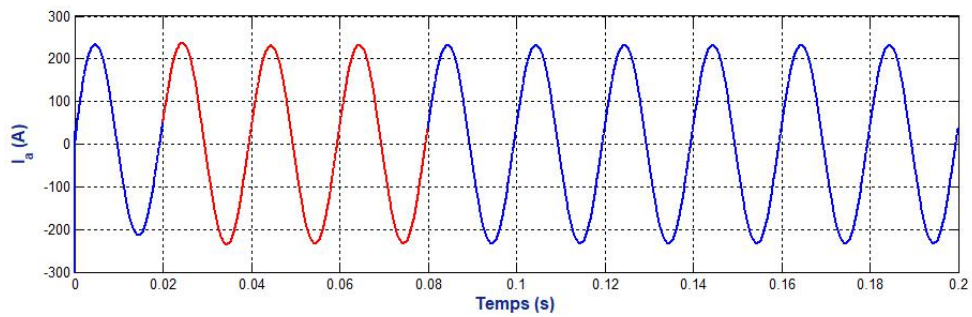

Fig. 13. Network current after filtering ( $t = 0.02$ s)

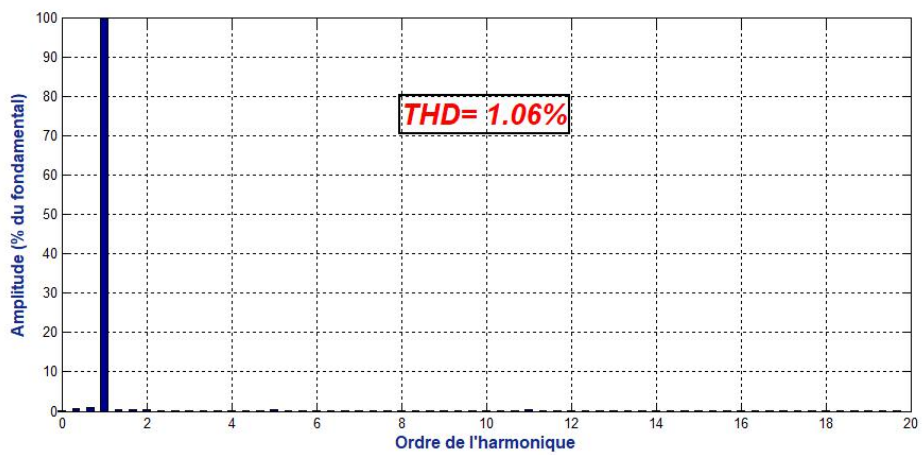
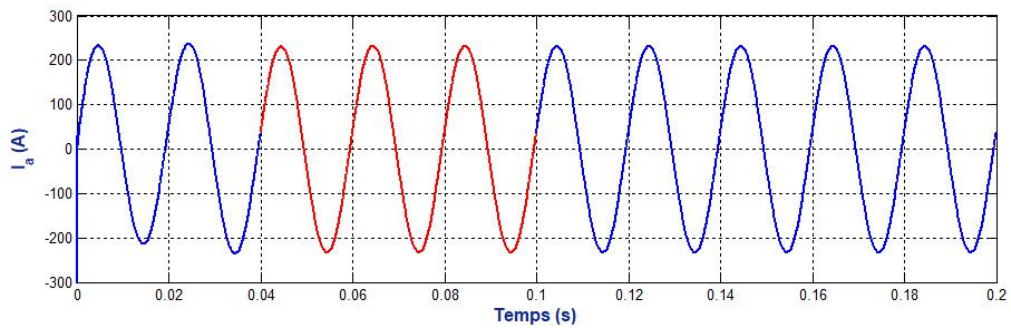
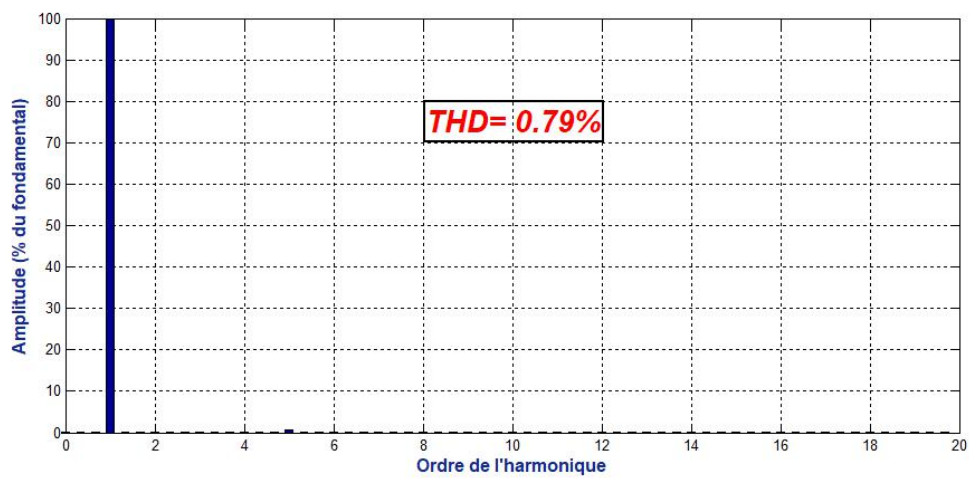

Fig. 14. Spectrum of the current after filtering for  $t = 0.02$ s

For  $t = 0.04\text{s}$  we have:

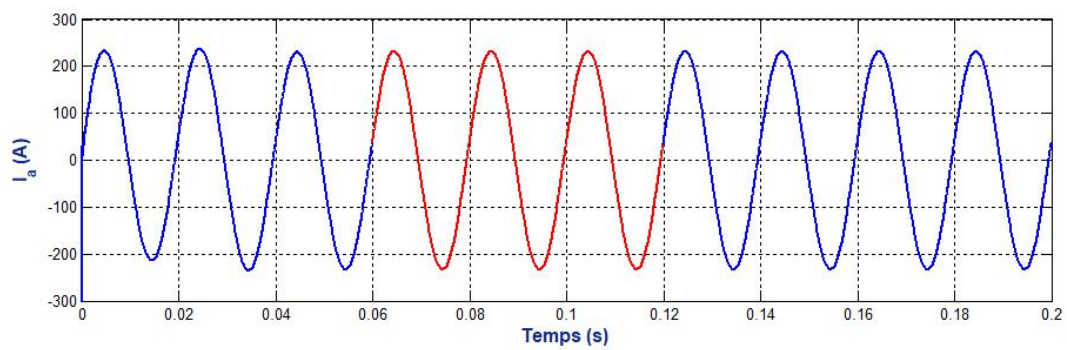

**Fig. 15. Network current after filtering ( $t = 0.04\text{s}$ )**



**Fig. 16. Spectrum of the current after filtering for  $t = 0.04\text{s}$**

For  $t = 0.06\text{s}$  we have:



**Fig. 17. Network current after filtering ( $t = 0.06\text{s}$ )**

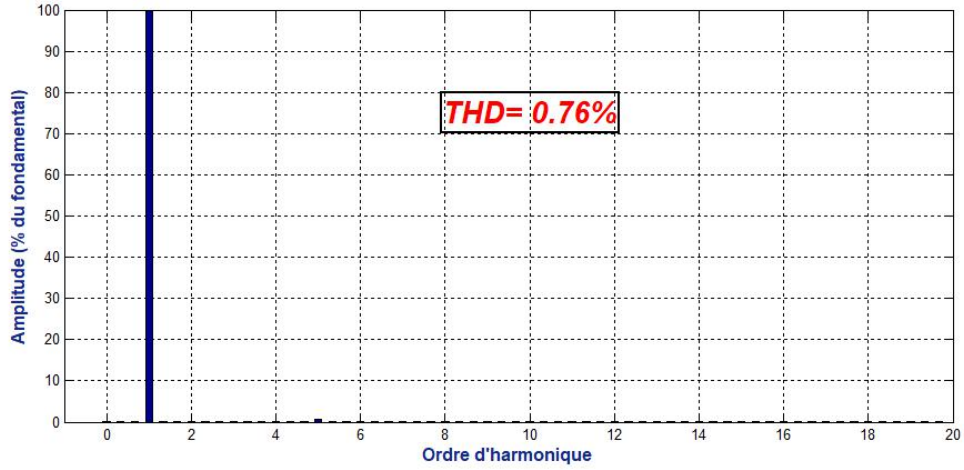

Fig. 18. Spectrum of the current after filtering for  $t = 0.06s$

For  $t = 0.08s$  we have:

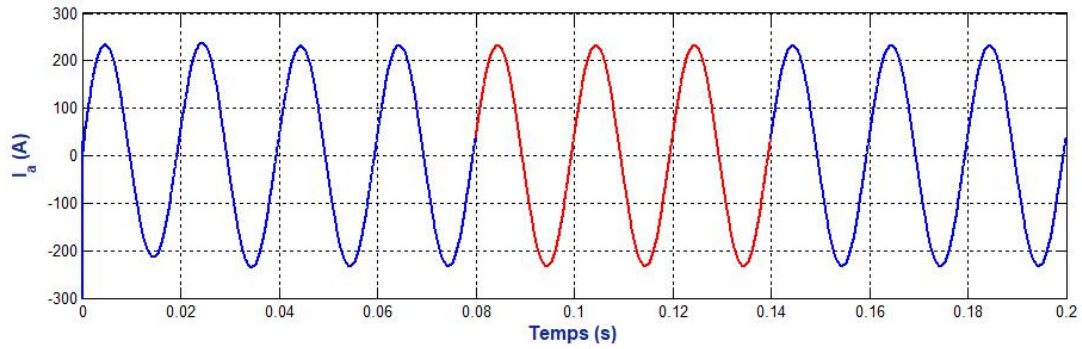

Fig.19. Network current after filtering ( $t = 0.08s$ )

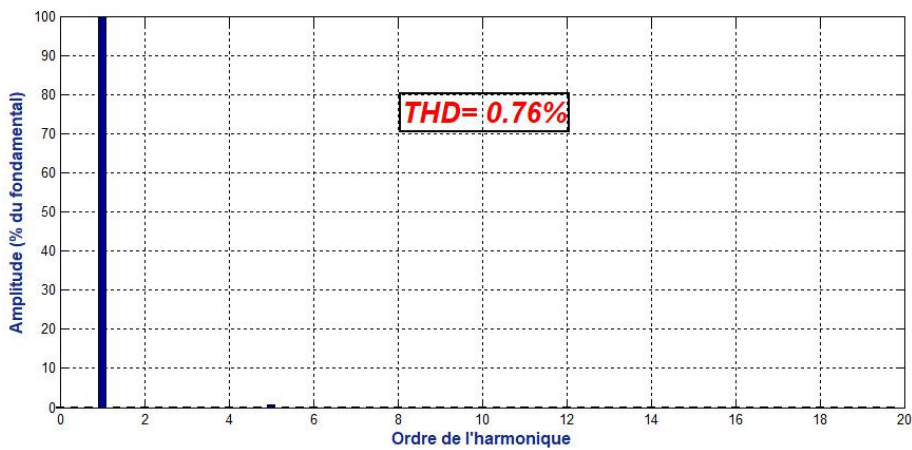
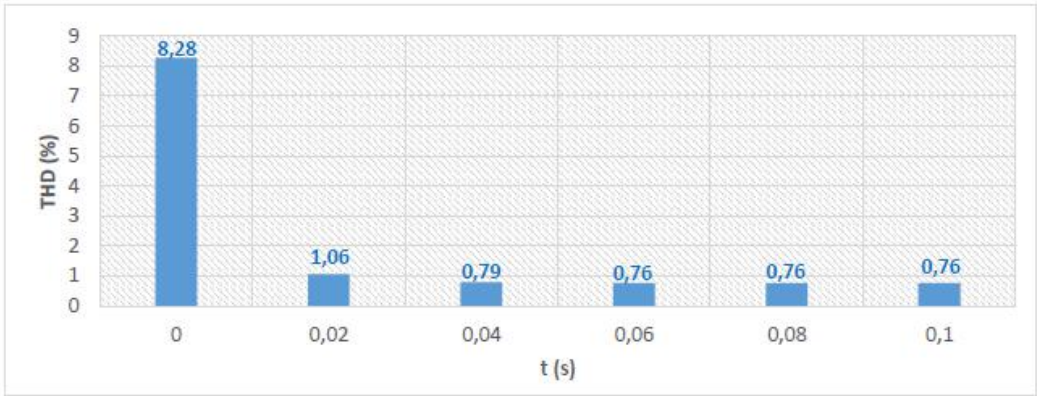

Fig. 20. Spectrum of the current after filtering for  $t = 0.08s$

By grouping these different cases in a table (Table III.1), this allows us to obtain the evolution of the THDs as a function of the possible beginning of the permanent regime (Figure 20).

**TABLE II THD EVOLUTION**

t(s)	THD (%)
0	8.28
0.2	1.06
0.04	0.79
0.06	0.76
0.08	0.76
1	0.76



**FIG. 21. GRAPH OF EVOLUTION OF THD**

Figure 20 shows that at  $t = 0s$  the signal is unstable. This one stabilizes very quickly up to  $t = 0.06s$ , time from which the value of the THD becomes constant and equal to 0.76%. However, considering that the steady state starts at  $t = 0.02s$ , the THD average over seven (07) periods (for a duration of 0.14s) gives us:  $THD = 0.83\%$ . This being done, we find that the frequency spectrum after filtering shows a single main line corresponding to the fundamental ( $f = 50Hz$ ). The other lines have thus been considerably attenuated by the active filter connected to the disturbed network. The THD found is evidence of an improvement in the waveform of the current.

## 4. Conclusion

This paper indicates the suitability of multilevel inverter based parallel active filter for power line conditioning of distribution networks. The multicellular inverter provides lower cost, higher performance and higher efficiency than the traditional PWM-inverter for power line conditioning applications. The inverter switching signals are derived from the proposed triangular-periodical current modulator that provides good dynamic performance under both transient and steady state operating conditions. SRF is employed to extract the fundamental component from the nonlinear load currents. This controller is developed by sensing load currents only. This approach is fairly simple to implement and is different from conventional methods. The PI-controller maintains the capacitance voltage of the cascaded inverter nearly constant. The extensive simulation results demonstrate the performance of the APF.

## References

- [1] C. Hochgraf, R. Lasseter, D. Divan, and T. A. Lipo, Comparison of multilevel inverters for static var compensation, *IEEE-IAS Annu. Meeting*, vol. 3, 1995, pp. 2557 – 2564.
- [2] G. Choe and M. Park, a new injection method for ac harmonic elimination by active power filter, *IEEE Transactions on Industry Applications*, vol. 35, n. 1, february 1988, pp. 141-147.
- [3] Lili, D. Czarkowski, Y. Liu, P. Pillay. Multilevel selective harmonic elimination PWM technique in series connected voltage inverters, *IEEE Transactions on Industry Applications*, vol. I-36, n. 1 pp. 160-169, january/February 2000.
- [4] S. Saadate, Thyristor GTO de forte puissance interrupteur entièrement commandable destiné à la traction électrique / Analyse et traitement des perturbations induites dans le réseau électrique par les convertisseurs statiques AC/DC, Habilitation à diriger des recherches, INP Lorraine, Nancy, 12 Janv. 1995.
- [5] C. Lott, Filtrage actif parallèle des harmoniques de courant sur des réseaux industriels Etude théorique et réalisation d'une maquette à GTO, PhD. Dissertation, l'INP Lorraine, Nancy, 1995.
- [6] H. Akagi, Y. Kanazawa and A. Nabae, Instantaneous reactive power compensators comprising switching devices without energy storage components, *IEEE trans. on Ind. Appl.* Vol. 20, pp.: 625-630, 1984.

- [7] A. Pigazo, V. M. Moreno, E. J. Estebanez, A Recursive Park Transformation to Improve the Performance of Synchronous Reference Frame Controllers in Shunt Active Power Filters. *IEEE Trans on Power Electronics*, vol. 24, n. 9, 2009.
- [8] M. Malinowski, K. Gopakumar, J. Rodriguez, M. A. Perez, A Survey on Cascaded Multilevel Inverters. *IEEE Trans on Industrial Electronics*, vol. 57, n. 7, 2010.
- [9] P. Karuppanan, K. K. Mahapatra, Shunt Active Power Line Conditioners for Compensating Harmonics and Reactive Power, *International Conference on Environment and Electrical Engineering (EEEIC)*, pp.: 277-280, 2010.
- [10] V. Dargahi, M. Abarzadeh, M. Salehifar, and A. Shoulaie, Voltage compensation by a modified mixed cascade flying capacitor multicell inverter, *1st Power Quality Conference (PQC)*, pp. 1–5, Tehran, 2010.
- [11] N. Senthilnathan, a novel control strategy for line harmonic reduction using three phase shunt active filter with balanced and unbalanced supply, *European Journal of Scientific Research*, vol. 67, n. 3, pp.456-466, 2012.
- [12] A. Morsli, A. Tlemçani, M. S. Boucherit, N. Ould, Cherchali, Dépollution des réseaux électrique Bt utilisant un filtre actif parallèle à deux niveaux contrôlé par l’algorithme P-Q, *conférence Nationale*, Tizi-Ouzou, Algeria, 2011
- [13] A. Yousfi, T. Allaoui, A. Chaker, Depollution of Low Voltage Electrical Networks using Parallel Active Filter five levels Controlled by the algorithm P-Q, *ICMS’2014*
- [14] A. Morsli, N. Ould Cherchali, A. Tlemçani, M. S. Boucherit, Application the P-Q Algorithm Method and Fuzzy Logic Controller by using a Multilevel Inverter as an Active Power Filter shunt, *the international conference on electronics & oil: from theory to applications*, 05-06 / Mars /2013 , Ouargla.
- [15] Raouf Belrechid, Mouloud Aissani, Filtrage des harmoniques via un poste à souder, *IC-WNDT-MI’14, CSC*, Annaba,09-11 novembre 2014
- [16] R. Rajeswari, power quality improvement of novel pwm based 15 level inverter for modified unified power quality conditioner (upqc), *international journal of mc square scientific research* vol.7, n.1 nov 2015
- [17] C. Mahamat, M. Petit, R. Marouani, C. Gautier, A. Mami, and F. Costa Decoupled PQ control Applied to a Multicellular Parallel Inverter for Grid-connected Photovoltaic System. *IEEE Conferences. 17th International Conference on Sciences and Techniques of Automatic Control and Computer Engineering (STA)*, Sousse, Tunisia. 2017