



HAL
open science

Network lifetime management in wireless sensor networks

Hayfa Ayadi, Ahmed Zouinkhi, Thierry Val, Adrien van den Bossche, Naceur Abdelkrim

► **To cite this version:**

Hayfa Ayadi, Ahmed Zouinkhi, Thierry Val, Adrien van den Bossche, Naceur Abdelkrim. Network lifetime management in wireless sensor networks. *IEEE Sensors Journal*, 2018, 18 (15), pp.6438-6445. 10.1109/JSEN.2018.2840830 . hal-02316842

HAL Id: hal-02316842

<https://hal.science/hal-02316842>

Submitted on 15 Oct 2019

HAL is a multi-disciplinary open access archive for the deposit and dissemination of scientific research documents, whether they are published or not. The documents may come from teaching and research institutions in France or abroad, or from public or private research centers.

L'archive ouverte pluridisciplinaire **HAL**, est destinée au dépôt et à la diffusion de documents scientifiques de niveau recherche, publiés ou non, émanant des établissements d'enseignement et de recherche français ou étrangers, des laboratoires publics ou privés.



Open Archive Toulouse Archive Ouverte

OATAO is an open access repository that collects the work of Toulouse researchers and makes it freely available over the web where possible

This is an author's version published in:

<http://oatao.univ-toulouse.fr/22431>

Official URL

DOI : <https://doi.org/10.1109/JSEN.2018.2840830>

To cite this version: Ayadi, Hayfa and Zouinkhi, Ahmed and Val, Thierry and Van Den Bossche, Adrien and Abdelkrim, Naceur *Network lifetime management in wireless sensor networks*. (2018) IEEE Sensors Journal, 18 (15). 6438-6445. ISSN 1530-437X

Any correspondence concerning this service should be sent to the repository administrator: tech-oatao@listes-diff.inp-toulouse.fr

Network Lifetime Management in Wireless Sensor Networks

Hayfa Ayadi, Ahmed Zouinkhi, Thierry Val, Adrien van den Bossche, and Mohamed Naceur Abdelkrim

Abstract—The energy consumption in wireless sensor networks stills a very interesting challenge in both industrial and research field. The IEEE 802.15.4 standard is an excellent result of the collaboration between these both fields in order to well managing the energy consumed in the node by controlling its duty cycle. It presents the most efficient standards for low energy consumption that is why it is considered as the main technology for the Internet of Thing. This paper consists mainly of validating through an experimental test bed, the two proposed methods. The first approach proposed is about computing the energy consumed by the node in its different transmission states with more efficiency. Although the second approach deals with computing, it is most convenable duty cycle basing on the remaining energy in the battery of the node which presents a very interesting issue for the energy consumption in wireless communication.

Index Terms—Energy, IEEE 802.15.4, WSN, IoT, auto-adaptation.

I. INTRODUCTION

INTERNET of Things (IoT) has emerged in the last decades. In this respect, many definitions have been advanced in order to provide a clear definition of the IoT. The most famous one is provided by the International Telecommunication Union (ITU). The IoT consists in connecting a wide range of objects [1], devices, buildings [1], vehicles sited within the reach of the same network, with the aim to make the Human being's life rather easier [2]. The IoT enables the things to see, hear, think as well as making decision [3] which leads to establish a smart city [4]. It is estimated that the number of connected things would reach 50 billion by the year 2020 [5]. The different kinds of connected objects contributes to many challenges such as maintaining the data source's security robustness [3], [6]. In effect, data security turns out to stand as a critically serious problem in IoT systems. The confidence of the data-provenance constitutes a crucial matter. In addition, the immense number of IoT system's connected objects might well culminate in the reception of a massive amount of data

which leads to the "big data" problem. In addition to that, the connectivity between the nodes and their different manufacturers/producers stands as a crucial objective. Moreover, most of the IoT system's associated devices appear to suffer from a low battery life. As nodes are most often deployed in very peculiar sites, the access to theirs power supply stand as a very serious problem for the node. In this respect, the entirety of the network's lifetime would be affected. The lifetime of the network is defined as the period of time that the node could live and be able to well communicate with the other member of the network, in our work the lifetime is just linked to the energy problem without considering the other sources of the node's death. For this reason, several research works, including this present work, have been established in order to resolve such issue such as the energy trouble and the problem relating to the network's data transmission associated faults [7]. The IoT is manipulated in a large domains and sectors, namely, the healthcare systems, transportation, agriculture, home monitoring and industry. This need for minimum energy consumption with maintaining an efficient wireless communication, lead to the apparence of the Low Rate Wireless Personal Area Network (LR WPAN) scheme [4]. In its full version, the latter is dedicated to defining the network with respect to the low power consumption, range, as well as throughput. As part of the Wireless Personal Area Network (WPAN), the LR-WPAN appears to display various benefits, mainly, ease of installation, short-range operation, remarkably low costs, reliable information-transmission procedure, moderate energy consumption, along with a selection of noticeably flexible protocols [8]. Our paper is organised by the way that section 2 presents a general overview about the standard IEEE 802.15.4. In the third section, a related work, about some other approaches which interest to same issu, is provided. In the next section, Both the proposed methods are explained. Section 5, presents the different simulation results. Then, the validation concept is described through the section 6. in the last section this paper is concluded.

II. IEEE 802.15.4: A GENERAL OVERVIEW

The LR-WPAN networks includes several technologies such as the IEEE 802.15.4 standard, liable to remarkable manipulations within the IoT systems. In this section, a general overview of this protocol is described. It presents the different modes that the nodes could enable which leads to the least of energy consumption, within a personal area network (PAN) context. In addition to that, it helps to offer the possibility

(Corresponding author: Hayfa Ayadi.)

H. Ayadi, A. Zouinkhi, and M. N. Abdelkrim are with the MACS Laboratory: Modeling, Analysis and Control of Systems, National Engineering School of Gabès, University of Gabès, Gabès 900103, Tunisia (e-mail: ayadihayfa.ing@gmail.com).

T. Val and A. van den Bossche are with the Institute of Research in Computer Science of Toulouse, University of Toulouse, 31000 Toulouse, France.

Digital Object Identifier 10.1109/JSEN.2018.2840830

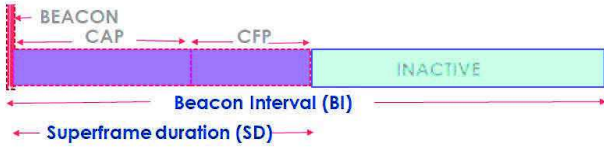

Fig. 1. Frame composition.

for a simultaneous implementation of two different protocols, mainly, the Carrier Sense Multiple Access with Collision Avoidance (CSMA-CA), along with the Time-Division Multiple Access TDMA protocol, as illustrated in figure 1. Additionally, this protocol provides the opportunity to manipulate three different topologies, specifically, the star topology as well as the peer-to-peer one and the mesh topology. [9]. It is also worth noting that the IEEE 802.15.4 is characterized by two different modes: a beacon enabled mode and a non-beacon enabled one. Regarding the former mode, the data frame appears to conform with the form given by the following **Figure 1**. The data frame starts with the beacon slots. The second part includes both of the Contention Access Period (CAP) and the Contention-Free Period (CFP). Throughout the inactive period, the node remains in a sleep period. Concerning the beacon frame, it is dispatched by the PAN coordinator to the network's different nodes periodically. It has many advantages, mainly, synchronizing the entirety of the network's members, in addition to identifying the associated PAN coordinator, and its most crucially allotted role lies in determining both of the node's activity period as well as inactivity periods. Actually, a better choice of the beacon values, the Beacon Interval (BI) and Super-frame Duration SD respective values, would directly contribute in defining the node's lifetime. The Super-frame Duration SD involves 960 symbols [9] and it is divided over 16 equally spaced slots. The Beacon Order (BO) value should range between 0 and 14, leading to a Beacon interval comprised between 15.36ms and 251.7ms via implementation on the 2.4GHz band. As presented in the equation, below, the CSMA/CA figures in the CAP part of the frame, whereas in the CFP part, the TDMA is enabled. In fact, the CFP section is made up of slots dubbed Guaranteed Time Slots (GTS).

$$BI = aBaseSuperframeDuration * 2^{BO};$$

$$1 \leq BO \leq 14 \quad (1)$$

$$SD = ABaseSuperframeDuration * 2^{SO};$$

$$0 \leq SO \leq BO \leq 14 \quad (2)$$

The CSMA/CA protocols designates the slotted version, as appearing in the Figure 2. In a first stage, the protocol's various parameters are initialized, specifically, the Congestion Window (CW), Backoff Exponent (BE) and the number of successive backoffs (NB). In a second stage, two successive Clear Channel Assessment CCA procedures are undertaken, in a bid to discover the transmission canal performance [9]. In case the canal is discovered to be unfree, the CCA would then be reduced 1 following each test, till it turns out to be 0. Once the canal appears to be in a busy state, the NB and BE respective values would then be decreased to 0, and

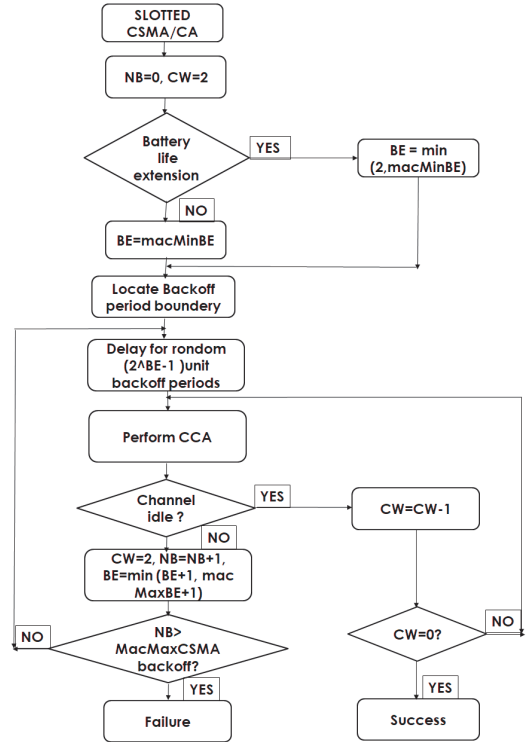

Fig. 2. CSMA/CA protocol.

CW set to 2. Subsequently, however, the entirety of the other parameters would then be updated, and the node would, once again, try to send its pertaining data, in the same way as described in Figure 2, below.

III. RELATED WORKS

The medium access related duty cycle control has an important role in controlling the radio associated sleeping and wake-up states. In this respect, the approaches interesting to the duty cycle could be distinguished [10]: a synchronous cycle, such as the SMAC [11], TMAC [12], WiseMAC [13] and SyncWUF [14]. As well as an asynchronous one, mainly, the LPL [15] BMAC [16] and X-MAC [17]. In the first case, the entirety of the network associated nodes sleep and wake-up simultaneously. In the second case, nodes have different activity and inactivity statuses (sleep and wake-up states). As far as the present work is concerned, the duty cycle is considered as being asynchronous, whereby, an energy failing node turns out to be influenced by our intervention. Indeed, before transmitting data, the asynchronous approach proceeds with a beacon hearing period. More specifically, pre-transmission overhead period is defined as a period of time at which the node V, charged with a data-sending is obliged to hear to the transmission canal until the receiver is ready to acquire such data. In this duration, the V node's radio turns out to be active which represents a major energy wasting origin. Considered as the most widely well-known methods among the transmission relating approaches [10], the asynchronous protocols display some serious drawbacks and limits, namely, those associated with the serious choice of the duty cycle. In fact, once the law duty cycle is enabled,

the sleep period turns out to be noticeably increased, which affects the receiver's idle period., and, consequently, several other aspects would prove to be affected, in turn, namely, reliability, throughput, and delay.

As the sleeping interval stands as a crucial dimension in minimizing the energy consumption factor, several works have been dedicated to investigating the IEEE 802.15.4 technology's role in dealing with such a dimension. Actually, there exist three possible cases whereby the node's lifetime could be well managed, more specifically, either adapting both of the BO and SO relevant values to the node's battery remaining energy, modifying the SO value while setting the BO value, or else simultaneously manipulating the BO value and setting the SO value. Actually, the most sophisticated approach consists in simultaneously intervening with altering both of the *BO* and *SO* associated values, as documented in [18], whereby both values could be computed on the basis of the remaining power amount. In this respect, the duty cycle itself is, in turn, affected, as highlighted in [19], whereby, a new method is put forward. Accordingly, the authors advance the idea that the duty cycle proves to depend highly on a number of parameters involving the number of packets received by the coordinator, the source node's number, the super-frame occupation ratio (OR) along with the collision ratio (CR) with a new approach named the Duty cycle Self-Adaptation Algorithm (DBSAA). The first method is based on modifying the *BO* value while preserving the *SO* value [20].

IV. PROPOSED APPROCHES

Two approaches are proposed in this paper which are about computing the energy consumed by the node and adapting the duty cycle value.

A. Mathematical Model for Energy Consumption

A special attempt is made here to calculate the energy amount consumed in every state of the node, i.e, throughout each of the transmission, reception, sleep and idle states, respectively. All the parameters used are declared in the Table I below: Noteworthy, the transmission phase constitutes the period during which the highest quantity of energy is consumed. Throughout the emission span, whereby the node undertakes to send its relevant data, the node proves to consume a certain power quantity level, dubbed emission energy E_{em} , as described by the equation (3), below:

$$E_{em} = (nbt_{sd} * T_{tt} * Eb) + 2 * U * I * CCA * T_{pback} \quad (3)$$

The T_{pback} is represented by the expression below:

$$T_{pback} = (2^{cst_{back}} - 1) * 20symbol \quad (4)$$

Additionally, the node lost a certain energy amount throughout the reception phase, labelled E_{rc} , as depicted by the expression (5), below:

$$E_{rc} = nbr_{SD} * Eb \quad (5)$$

Hence, the sleep method presents the best option to help in managing and intervening with the energy amount remaining

TABLE I
NOMENCLATURE OF PARAMETERS

Parameters	signification
E_{em}	emission energy
nbt_{sd}	the number of bit transmitted in the SD
T_{tt}	the frame size
Eb	the binary energy
U	the voltage value
I	the current value
cst_{back}	the back-off period
E_{rc}	the reception energy
nbr_{SD}	the number of bits received in the SD
E_{SLP}	the energy consumed in the sleep period
BI	Beacon Interval
SD	Superframe Duration
T_{SIFS}	the SIFS duration
$SIFS$	the Short Interframe Spacing (SIFS)
E_{BI}	the energy consumed in the SD
E_R	the Remaining Energy
E_T	the frame Energy.

in the node's battery, and determining the network's life duration, as a whole. Actually, the IEEE 802.15.4 standard is well known for its disposition and remarkable usefulness for making such a process achievable. Thus, the energy consumed throughout the sleep period E_{SLP} could be computed through implementation of the expression below:

$$E_{SLP} = Eb * (BI - SD) \quad (6)$$

As for the idle-state consumed energy, it can be depicted through the equation (7):

$$E_{idle} = T_{SIFS} * U * I \quad (7)$$

B. IEEE 802.15.4 Parametric Computing: Beacon Order, Superframe Order

At this step, we admit that the energy consumed during the Superframe period E_{BI} is suggested throw the expression (8):

$$E_{BI} = \frac{BI}{T_{tt}} * E_T \quad (8)$$

We assume that the amount of energy consumed still always inferior to the battery remaining energy, as given by the following formula (9).

$$E_{BI} \leq E_R \quad (9)$$

Therefore, equation (10) is expressed basing on both of the equations (8) and (9), such as:

$$\frac{BI}{T_{tt}} * E_T \leq E_R \quad (10)$$

As described in the official standard definition, the Beacon Interval (BI) is computed throw formula (11), below:

$$BI = 2^{BO} * aSuperFrameDuration$$

respectively, equation (11) is changed to be reported as (12):

$$\frac{2^{BO} * aSuperFrameDuration}{T_{tt}} * E_T \leq E_R \quad (11)$$

where the 2^{BO} can be extracted by expression (13):

$$2^{BO} \leq E_R * \frac{T_{II}}{E_T * aSuperFrameDuration} \quad (12)$$

Although the BO relating value is rendered through equation (14):

$$BO \leq \frac{\log(E_R * \frac{T_{II}}{E_T * aSuperFrameDuration})}{\log(2)} \quad (13)$$

Under the majoration condition, the BO is chosen by formula below (14). In order to maintain an efficient management of the last energy quantity available yet in the battery, it is kept just 10% of the energy is remaining in the node E_{R1} , as manipulated for effective exploitation. This situation is depicted via equation (15), below:

$$E_{R1} = E_R * 0.1 \quad (14)$$

Therefore, SO is described by means of equation (16), such as:

$$BO = \frac{\log(\frac{0.1 * E_R * T_{II}}{15,36 * 10^{(-3)} * E_T})}{\log(2)} \quad (15)$$

For the case of the Superframe Duration SD , just 10% from the BI period is exploited. So SO is expressed by formula (17).

$$SO = 0.7 * \frac{\log(\frac{0.1 * E_R * T_{II}}{15,36 * 10^{(-3)} * E_T})}{\log(2)} \quad (16)$$

C. Proposed Algorithm: Adaptive Beacon Enabled Mode (ABEM)

As an innovative method, initially designed and advanced by us in a previously edited article, the Adaptive Beacon Enabled Mode (ABEM). Our approach consist in first step in computing the energy consumption of the node. Then every node send its current levels to the PAN node which computes by itself the energy lasted in the battery of every node. If it detects that its remaining energy is inferior to the threshold set, the PAN node intervene by changing its current duty cycle via modifying both values of the BO and SO , as illustrated in the algorithm below.

V. SIMULATION RESULTS

In order to present the efficiency of our approach, the simulation results were compared to four other methods which are namely, the Optimal Beacon and Superframe Orders in WSNs (OBSO), [21], an Adaptive Algorithm to Optimize the Dynamics of IEEE 802.15.4 Network (AAOD), [22], the Battery Aware Beacon Enabled IEEE 802.15.4, as an adaptive and Cross-Layer Approach (BARBEI) [23], as well as the IEEE 802.15.4 with $(BO, SO)=(7, 5)$ [24]. For its good evaluation, the INETMANET/OMNET++ simulator is chosen to check the approach proposed. The OMNET++ is well known as a reliable, extensible and a modular simulator [25] in addition to its affectivity in constructing a realistic environment. It is very flexible simulator which able to accept many modules such as the INETMANET framework.

The simulation parameters are presented in Table, below II. The network is formed by 17 nodes one PAN coordinator

Algorithm 1: Proposed Algorithm Approach: ABEM Algorithm

Input: N NODES NUMBERS

for $x \leftarrow 0$ **to** N **do**

if $Coordinator_Receive_Energy_Consumption = true$ **then**

$Storage_Energy_Remaining(E_TR)$;

if $(E_r < E_t)$ **then**

$Node_fault_energy = True$;

$BO = \frac{\log(\frac{0.1 * E_R * T_{II}}{15,36 * 10^{(-3)} * E_T})}{\log(2)}$

$SO = 0.7 * \frac{\log(\frac{0.1 * E_R * T_{II}}{15,36 * 10^{(-3)} * E_T})}{\log(2)}$

else

$BO = BO_current$;

$SO = SO_current$;

end

$send(BO, SO)$;

end

end

return x

TABLE II
SIMULATION PARAMETERS

Parameters	Values
Network size	(800m,400m)
Initial Energy Value (J)	18720
Nodes number	17
PAN number	1
Channel frequency	2.4 GHz
Radio Type	IEEE 802.15.4 radio
dispersion	random

with 16 nodes. Every node sends periodically its different energy levels to the PAN node which computes by itself the energy lasted in the battery of every node. In the case of detecting a critical threshold, the ABEM algorithm is started. Four thresholds are set as presented in Figure 3. Every time the energy lasted in the battery reach one of these thresholds the ABEM intervene in order to postpone the death of the node. The different simulation results proves the efficiency of our proposed approach compared to the four other methods: OBSO, AAOD, BARBEI and the IEEE 802.15.4 with $(BO, SO)=(7, 5)$. As presented in Figures 4, 5, 6 and 7 the ABEM approach present very good results with the four kind of energy; reception, transmission, idle and sleep energy. After every intervention the energy consumed decrease in order to conserve more the quantity lasted in the battery of the node except the sleep energy which reach an increase with the increase of the traffic load.

VI. EXPERIMENTAL RESULTS

After proving the efficiency of our approach, by comparing it with four other approaches, we validate it with a real test

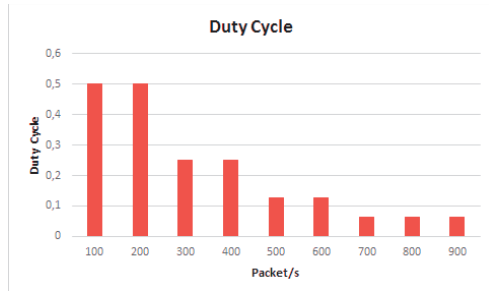

Fig. 3. Duty cycle.

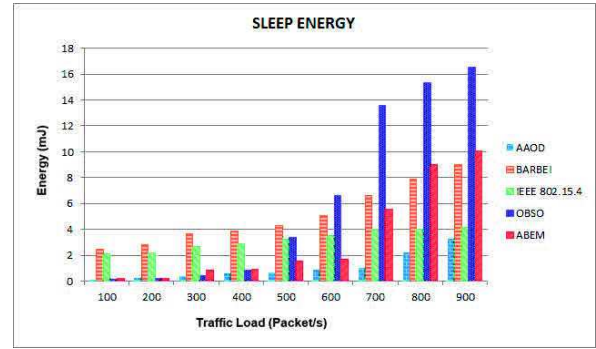

Fig. 7. Energy-consumption in sleep state.

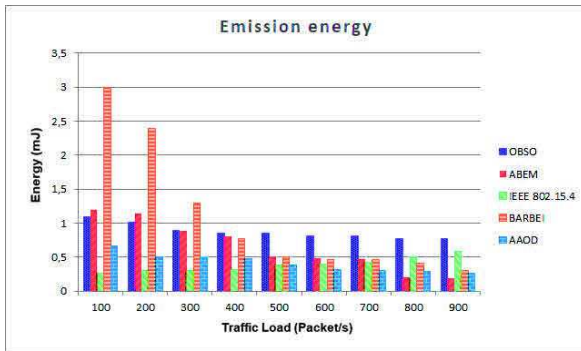

Fig. 4. Energy-consumption in emission state.

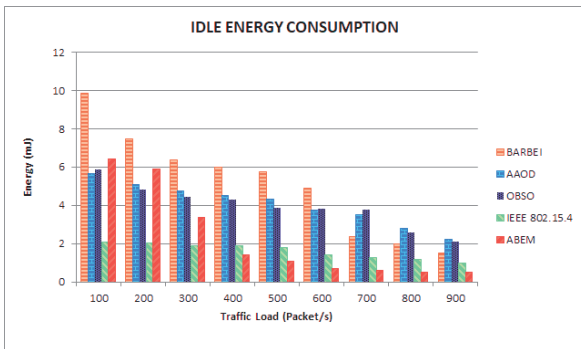

Fig. 5. Energy consumption in idle state.

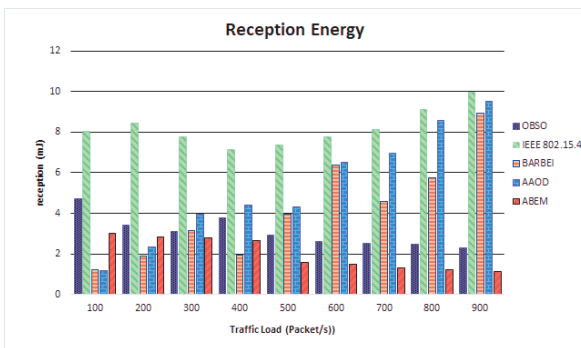

Fig. 6. Energy consumption in reception state.



Fig. 8. TeensyWiNo node.

TABLE III
TEENSY-WINO CHARACTERISTICS

Energy consumption	State	Power consumed
CPU	actif 96MHZ	129 (mW)
	actif 72MHZ	103 (mW)
	actif 48MHZ	88.8 (mW)
	actif 24MHZ	55.5 (mW)
	Sleep/awake by LPTMR	2 (mW)
	DeepSleep/awake by LPTMR	0.650 (mW)
	Hibernate/awake by LPTMR	< 0.030 (mW)
Transceiver	Transmit (10dbm)	76 (mW)
	Receive	57 (mW)
	IDLE	26 (mW)
	Sleep	<0.005 (mW)

The TeensyWiNo node involves several sensors, for instance, those relating to detecting temperature, light, an accelerometer, a Gyroscopic, as figuring in architecture Figure 9, below. It serves to help model and simulate a wide range of prototyping networks without the need for inserting any extra electronics. The architectural design is conceived to involve both of the hardware and software blocks. The hardware architecture is based on the Arduino ecosystem, given the efficiency, it displays in the prototyping of small electronic miniature components. Such a choice has been enhanced by the microcontroller module, powerful memory, and processor it encompasses. The memory is specifically devoted to safeguarding and maintaining the protocol's performance, in addition to storing the low-rate energy consumed throughout the CPU relating time lapse. Besides, the design also encloses a Lithium Polymer battery (Li-Po), allowing the prototype to fit for application in a mobile situation. These nodes have been examined and dispersed in the first flat of the laboratory pertaining to the University Institute of Technology (IUT) of Blagnac, Toulouse, attached to the Computer Science Research Institute (IRIT) of Toulouse, France.

The Figures 10, 11 present both the 2D and 3D. That node N65 has been selected to stand as the node sink of our network.

bed experiment. We used 17 nodes to reach our goal. It is named TeensyWiNo node as presenting in figure Figure 8. Its pertaining characteristics are depicted in the Table, below III.

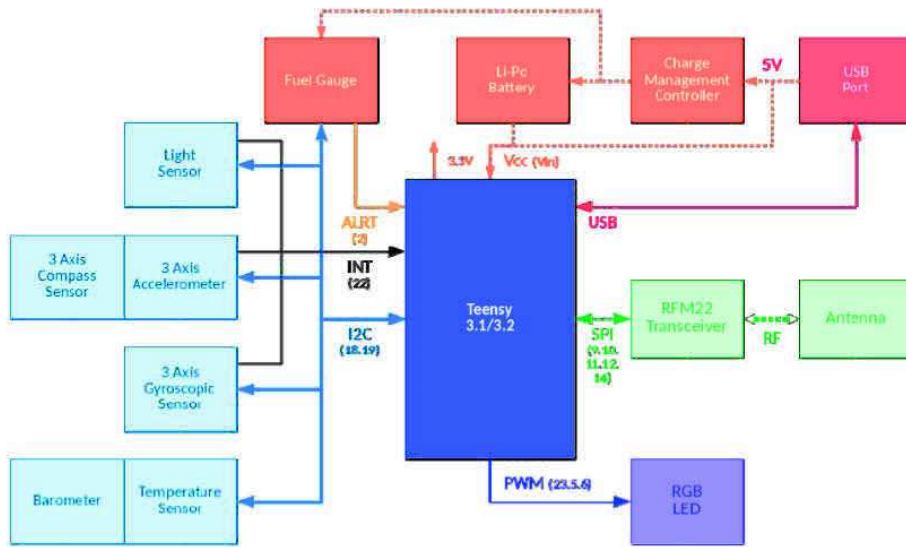

Fig. 9. WINO architecture.

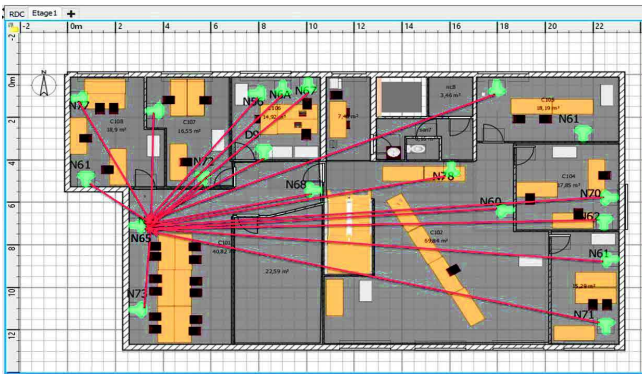

Fig. 10. First floor in 2D plan.



Fig. 11. First floor in 3D plan.

The latter is made up of 16 nodes, namely, those bearing the numbers: 60, 61, 62, 64, 67, 68, 70, 71, 72, 73, 77, 78, 6A, 6E, D9, and 56.

The nodes are dispersed and placed everywhere: on the walls, the doors, the windows etc, as appearing on the figure, below 12.

A. The Validation of the Mathematical Model for Energy Consumption

In the first step, our aim is to validate the proposed method of computing the energy consumed by the nodes.

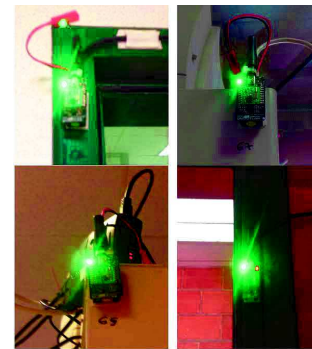

Fig. 12. Example nodes.

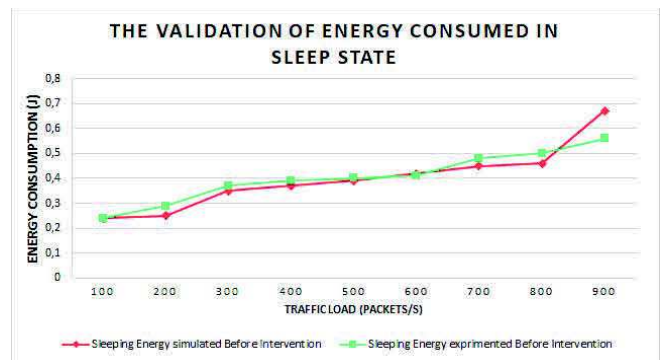

Fig. 13. The validation of energy consumed in sleep state.

So every node of the network sends their energies values to the PAN coordinator N65 which computes the energy lasted yet in the battery. Then a comparison is made between the simulated and the experimental results. At this level, the kinds of energy consumed validated are: the emission-related energy, the reception associated energy, the quantity of energy in the sleep and idle states as presented by figures (13, 14, 15 and 16). Indeed, it proves the increase congruently and in parallel with the increase in the network's traffic load. As remarkable in Figures (13 and 14) both the simulated and the experimental aspect of the method increase

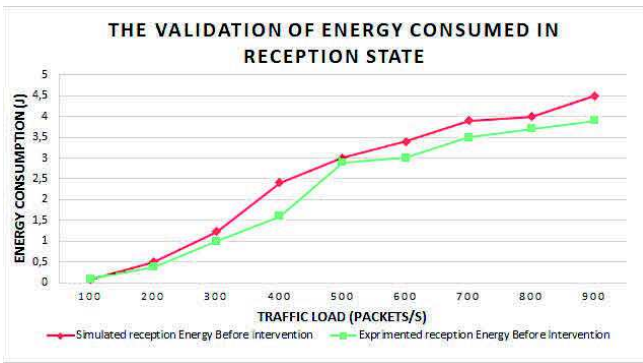

Fig. 14. The validation of energy consumed in reception state.

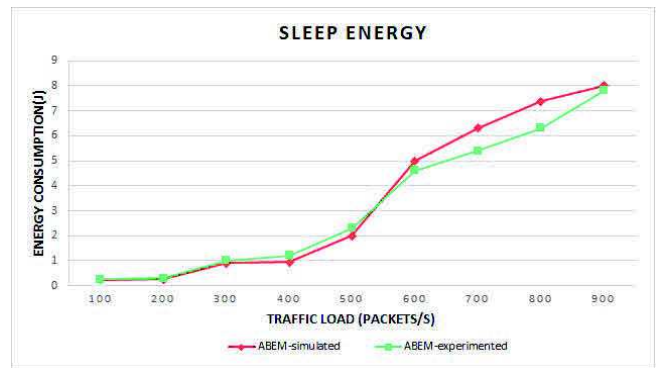

Fig. 17. ABEM validation in sleep state.

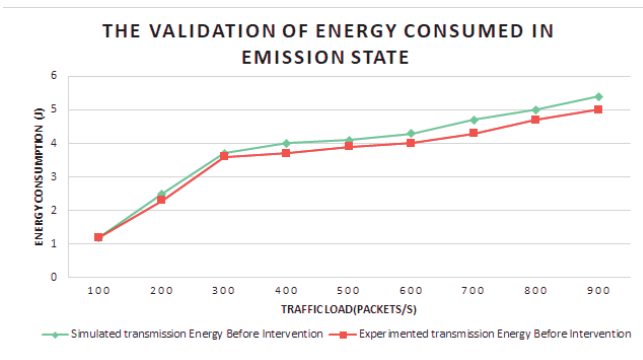

Fig. 15. The validation of energy consumed in emission state.

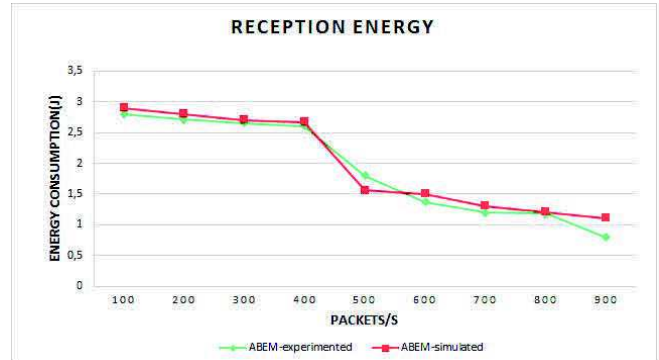

Fig. 18. ABEM validation in reception state.

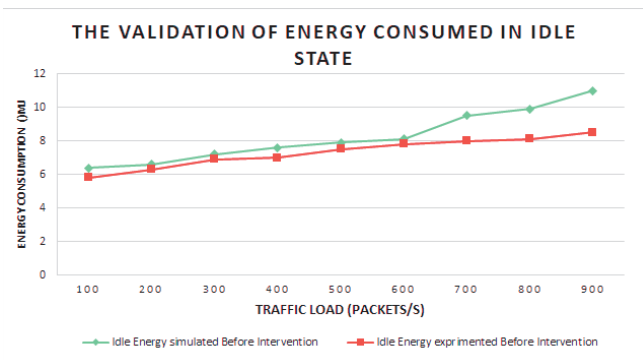

Fig. 16. The validation of energy consumed in idle state.

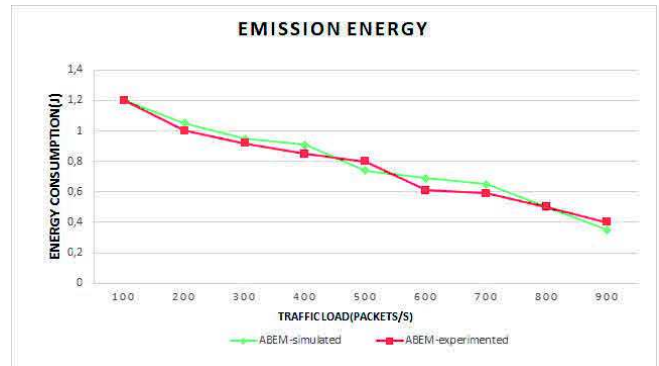

Fig. 19. ABEM validation in emission state.

by the same way. Moreover, Figures 15 and 16 describe the quantity of energy consumed in emission and idle states in which the simulated and the experimental results register both the same level. As a conclusion, the results of the fourth kinds of energy consumption have the same compoertement in both simulation and experimental aspect which prove the efficiency of our proposed approach.

B. Approach Proposed Validation

This section is devoted to evaluate with experimental testbed our advanced ABEM approach, relating to the emission, reception, idle as well as sleep state's relevant energy consumption. As already stated, our approach is based on adapting the node's associated duty cycle with the its battery remaining energy. In our case the node N62 suffers from

energy faults. The PAN coordinator (node N65) detects this problem when its node child (node N62) sends to it its different energies consumed values. Then the ABEM approach is started. As indicated through the Figure 3, the duty cycle associated values are changing in 4 levels throughout both of the simulation and experiment tests. The traffic load appears to range from 100 packets/s to 900 packets/s.

To sum it up, four energy thresholds have been tested throughout the present work, resulting in four duty-cycle associated values. On implementing the WINO platform, the energy consumed by the node at every state level and after each intervention (adapting the node's duty cycle) has been investigated and detected. Then the values are compared to the simulated results in order to prove the efficiency of ABEM approach. As presented by Figures 17, 18, 19 and 20,

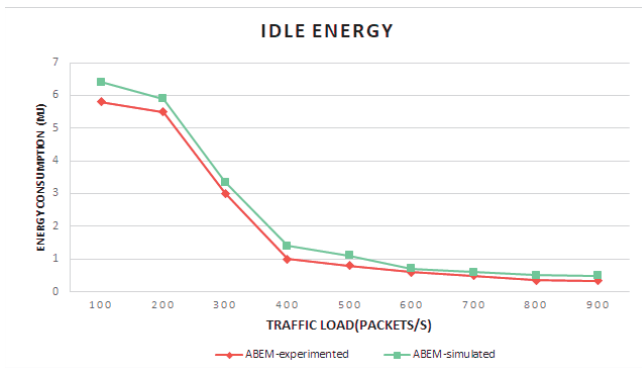

Fig. 20. ABEM validation in idle state.

the simulation and test-bed experiments (the WINO nodes) have the same comportement in all the states of node: emission, reception, idle and sleep state.

VII. CONCLUSION

In the IEEE 802.15.4 technology, both of the Beacon Order and the Superframe Order helps in controlling the node's activity duration. Our present work has put forward a novel energy-consumption method, along with a new energy control approach, named Adaptive Beacon Enabled Mode, relevant to monitoring the node battery remaining power, through intervening with the node associated duty cycle. The present research is primarily conceived to present a validation of both methods. In a first place, it is designed to help effectively validate the consumed-energy computational methods concerning the entirety of the emission, reception, idle and sleep state's relating durations. In a second place, it is elaborated for the purpose of validating the ABEM approach reliability as to the *BO* and *SO* associated values. Eventually, both of the approaches' reached results turn out to testify the designed methodology's efficiency. Still, and in a potential work, the harvesting energy presents a very interesting field which could present an excellent solution for the energy challenge in the wireless communication.

REFERENCES

- [1] K.-K. Du, Z.-L. Wang, and M. Hong, "Human machine interactive system on smart home of IoT," *J. China Univ. Posts Telecommun.*, vol. 20, pp. 96–99, Aug. 2013.
- [2] S. Tata, M. Mohamed, and A. Megahed, "An optimization approach for adaptive monitoring in IoT environments," in *Proc. IEEE Int. Conf. Services Comput. (SCC)*, Jun. 2017, pp. 378–385.
- [3] M. Ammar, G. Russello, and B. Crispo, "Internet of Things: A survey on the security of IoT frameworks," *J. Inf. Secur. Appl.*, vol. 38, pp. 8–27, Feb. 2018.
- [4] S. E. Bibri, "The IoT for smart sustainable cities of the future: An analytical framework for sensor-based big data applications for environmental sustainability," *Sustain. Cities Soc.*, vol. 38, pp. 230–253, Apr. 2018.
- [5] A. Al-Fuqaha, M. Guizani, M. Mohammadi, M. Aledhari, and M. Ayyash, "Internet of Things: A survey on enabling technologies, protocols, and applications," *IEEE Commun. Surveys Tuts.*, vol. 17, no. 4, pp. 2347–2376, 4th Quart., 2015.
- [6] H. Ayadi, A. Zouinkhi, B. Boussaid, M. N. Abdelkrim, and T. Val, "Energy efficiency in WSN: IEEE 802.15.4," in *Proc. 17th Int. Conf. Sci. Techn. Autom. Control Comput. Eng. (STA)*, Dec. 2016, pp. 766–771.
- [7] Q. Zhang, L. T. Yang, Z. Chen, and P. Li, "High-order possibilistic c-means algorithms based on tensor decompositions for big data in IoT," *Inf. Fusion*, vol. 39, pp. 72–80, Jan. 2018.

- [8] C.-H. Lo and N. Ansari, "IEEE 802.15.4 based wireless sensor network design for smart grid communications," in *Handbook of Green Information and Communication Systems*. New York, NY, USA: Elsevier, 2013, pp. 91–114.
- [9] *Wireless Medium Access Control (MAC) and Physical Layer (PHY) Specifications for Low-Rate Wireless Personal Area Networks (WPANs)*, IEEE Standard 802.15.4, IEEE Computer Society, 2006.
- [10] P. Park, S. C. Ergen, C. Fischione, and A. Sangiovanni-Vincentelli, "Duty-cycle optimization for IEEE 802.15.4 wireless sensor networks," *ACM Trans. Sensor Netw.*, vol. 10, no. 1, 2013, Art. no. 12.
- [11] W. Ye, J. Heidemann, and D. Estrin, "Medium access control with coordinated adaptive sleeping for wireless sensor networks," *IEEE/ACM Trans. Netw.*, vol. 12, no. 3, pp. 493–506, Jun. 2004.
- [12] T. Van Dam and K. Langendoen, "An adaptive energy-efficient MAC protocol for wireless sensor networks," in *Proc. 1st Int. Conf. Embedded Netw. Sensor Syst.*, 2003, pp. 171–180.
- [13] A. El-Hoiydi and J.-D. Decotignie, "Low power downlink MAC protocols for infrastructure wireless sensor networks," *Mobile Netw. Appl.*, vol. 10, no. 5, pp. 675–690, 2005.
- [14] X. Shi and G. Stromberg, "SyncWUF: An ultra low-power MAC protocol for wireless sensor networks," *IEEE Trans. Mobile Comput.*, vol. 6, no. 1, pp. 115–125, Jan. 2007.
- [15] J. L. Hill and D. E. Culler, "Mica: A wireless platform for deeply embedded networks," *IEEE Micro*, vol. 22, no. 6, pp. 12–24, Nov./Dec. 2002.
- [16] J. Polastre, R. Szewczyk, and D. Culler, "Telos: Enabling ultra-low power wireless research," in *Proc. IEEE 4th Int. Symp. Inf. Process. Sensor Netw.*, Apr. 2005, pp. 364–369.
- [17] M. Buettner, G. V. Yee, E. Anderson, and R. Han, "X-MAC: A short preamble MAC protocol for duty-cycled wireless sensor networks," in *Proc. 4th Int. Conf. Embedded Netw. Sensor Syst.*, 2006, pp. 307–320.
- [18] H. Ayadi, A. Zouinkhi, T. Val, B. Boussaid, and M. N. Abdelkrim, "Multi operating mode for energy adaptability in wireless sensor network," in *Proc. 25th Medit. Conf. Control Autom. (MED)*, Jul. 2017, pp. 974–979.
- [19] C. H. S. Oliveira, Y. Ghamri-Doudane, and S. Lohier, "A duty cycle self-adaptation algorithm for the 802.15.4 wireless sensor networks," in *Proc. Global Inf. Infrastruct. Symp. (GIIS)*, Oct. 2013, pp. 1–7.
- [20] M. Neugebauer, J. Plonnigs, and K. Kabitzsch, "A new beacon order adaptation algorithm for IEEE 802.15.4 networks," in *Proc. IEEE 2nd Eur. Workshop Wireless Sensor Netw.*, Feb. 2005, pp. 302–311.
- [21] M. Salayma, W. Mardini, Y. Khamayseh, and M. B. Yasin, "Optimal beacon and superframe orders in WSNs," *Topology*, vol. 6, p. 8, Jun. 2013.
- [22] J. Hurtado-López and E. Casilari, "An adaptive algorithm to optimize the dynamics of IEEE 802.15.4 networks," in *Proc. Int. Conf. Mobile Netw. Manage. Cork, Republic of Ireland: Springer*, 2013, pp. 136–148.
- [23] M. Salayma, A. Al-Dubai, I. Romdhani, and M. B. Yassein, "Battery aware beacon enabled IEEE 802.15.4: An adaptive and cross-layer approach," in *Proc. IEEE Fed. Conf. Comput. Sci. Inf. Syst. (FedCSIS)*, Sep. 2015, pp. 1267–1272.
- [24] Y. S. Kaviani and H. Rasouli, "Adaptive IEEE 802.15.4 MAC protocol for wireless sensor networks," in *Technological Breakthroughs in Modern Wireless Sensor Applications*. Hershey, PA, USA: IGI Global, 2015, pp. 109–123.
- [25] A. Varga, "Omnet++," in *Modeling and Tools for Network Simulation*. Berlin, Germany: Springer, 2010, pp. 35–59.

Hayfa Ayadi, photograph and biography not available at the time of publication.

Ahmed Zouinkhi, photograph and biography not available at the time of publication.

Thierry Val, photograph and biography not available at the time of publication.

Adrien van den Bossche, photograph and biography not available at the time of publication.

Mohamed Naceur Abdelkrim, photograph and biography not available at the time of publication.