



**HAL**  
open science

## Middle Palaeolithic Lithic Technologies

David Hérisson

► **To cite this version:**

David Hérisson. Middle Palaeolithic Lithic Technologies. École thématique. Technologie de la pierre taillée préhistorique : méthodologie et initiation pratique, Pincevent, France. 2019. hal-02316472

**HAL Id: hal-02316472**

**<https://hal.science/hal-02316472>**

Submitted on 28 May 2020

**HAL** is a multi-disciplinary open access archive for the deposit and dissemination of scientific research documents, whether they are published or not. The documents may come from teaching and research institutions in France or abroad, or from public or private research centers.

L'archive ouverte pluridisciplinaire **HAL**, est destinée au dépôt et à la diffusion de documents scientifiques de niveau recherche, publiés ou non, émanant des établissements d'enseignement et de recherche français ou étrangers, des laboratoires publics ou privés.

# Middle Palaeolithic Lithic Technologies

David Hérisson

CNRS-UMR7041 ArScAn, Equipe AnTET  
Maison de l'Archéologie et de l'Ethnologie  
Université Paris X Nanterre



[@david\\_herisson](https://twitter.com/david_herisson)

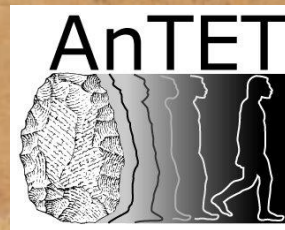
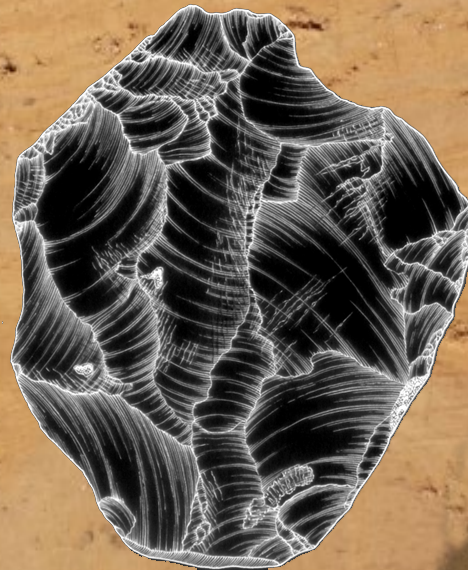



# Some words on Middle Palaeolithic...

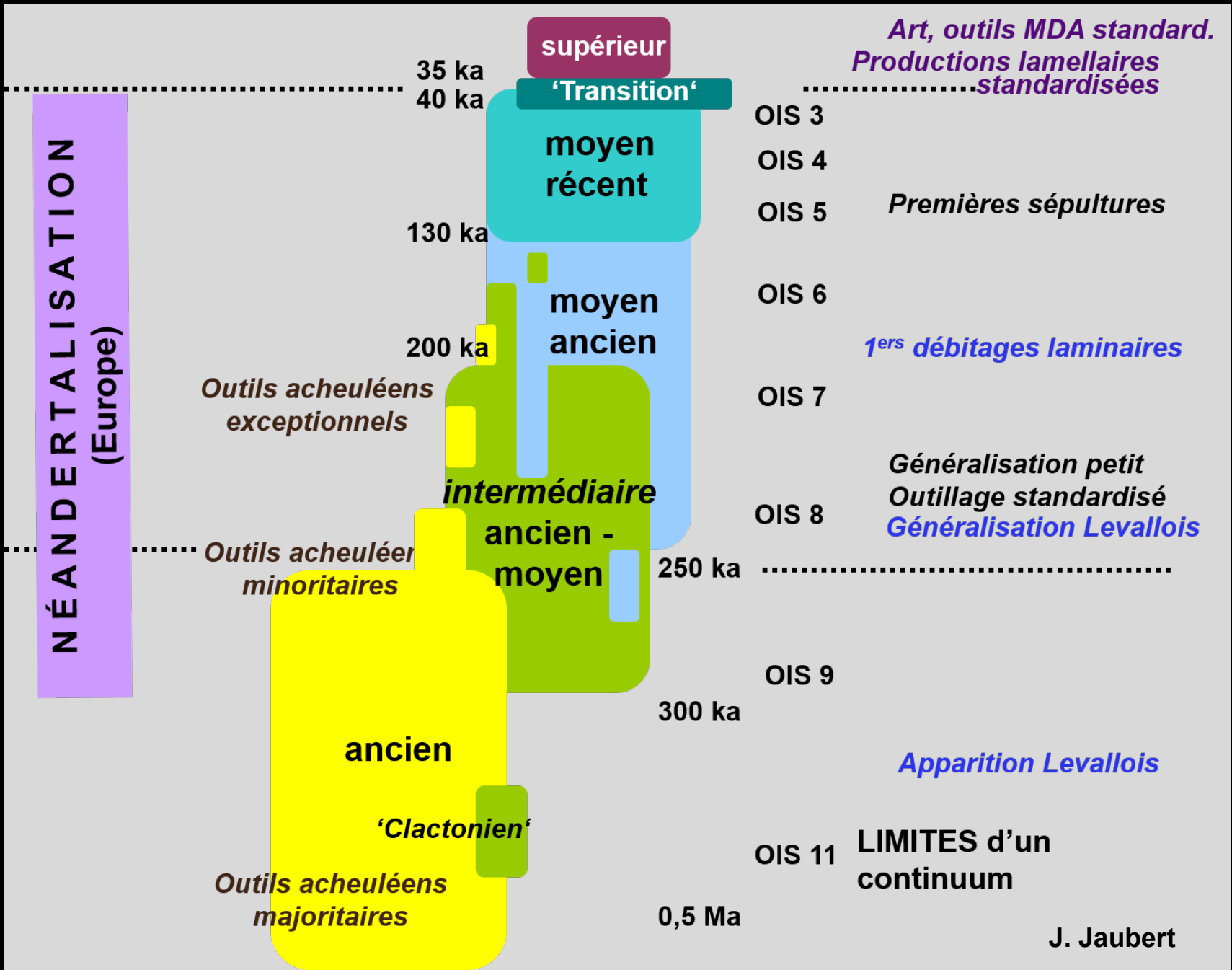

# Historiography

## Before 1872 : pioneers' time

- 1808 : *Les Peyrards*, E. Requier
- 1815-16 : *Combe-Grenal*,  
*Pech de l'Azé* F. Jouannet
- 1827 : *grotte Tournal*, Bize  
F. Tournal
- 1831 : terrasses de la Somme  
J. Boucher de Perthes
- 1865 : grottes de *La Chaise*  
abbés Bourgeois et Delaunay

## 1861 - 1872 : the time of recognition

- 1863-64 : É. Lartet fouille au *Moustier* :  
*âge de Saint-Acheul et du Moustier*
- 1867 : chronologie relative de  
**G. de Mortillet** (M.A.N.)
- 1872 : *Classification des  
diverses périodes de l'Âge de la  
Pierre : Mo(u)stérien*

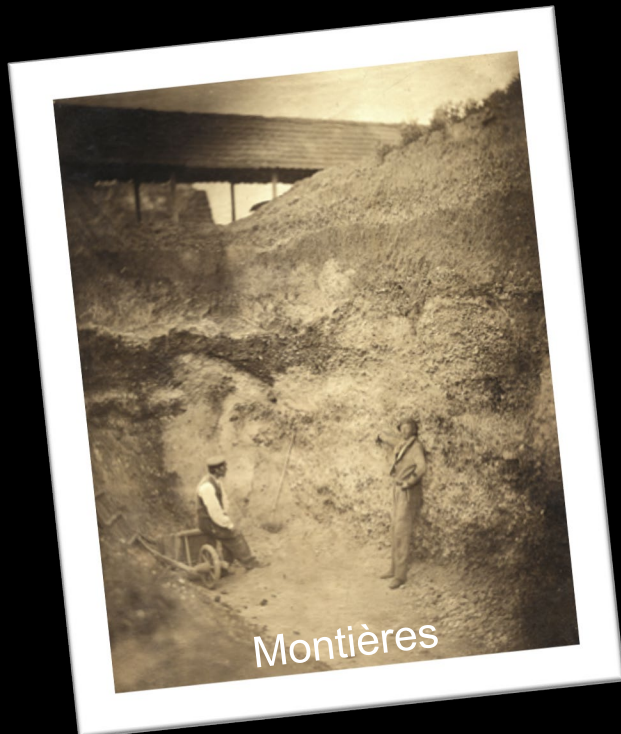

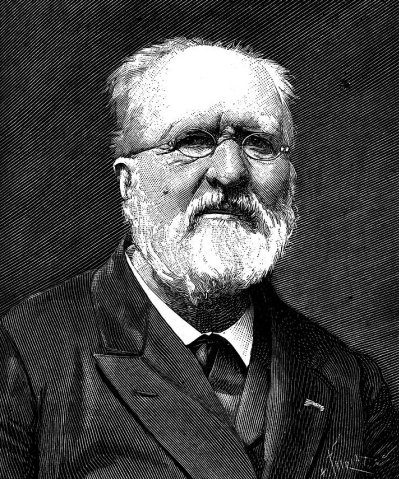

# CLASSIFICATION

DES

## DIVERSES PÉRIODES DE L'ÂGE DE LA PIERRE

2° Époque du Moustier, caractérisée par des pointes de pierre retaillées d'un seul côté (fig. 4) et par de grands racloirs (fig. 3). Le véritable grattoir fait défaut. L'industrie de cette époque se rencontre dans les alluvions quaternaires des bas niveaux, dans des brèches, des stations en plein air et des grottes;

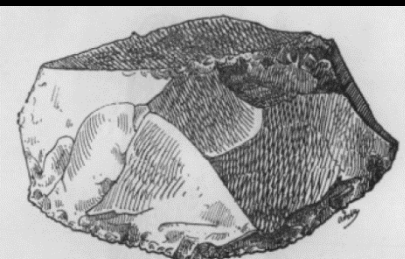

Fig. 3. Racloir en silex du Moustier.

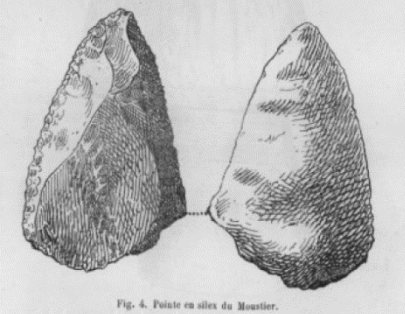

Fig. 4. Pointe en silex du Moustier.

PIERRE TAILLÉE ARCHÉOLITHIQUE OU PALÉOLITHIQUE	INSTRUMENTS UNIQUEMENT EN PIERRE TAILLÉE	<b>SOLUTRÉEN</b> Époque de Solutré. TYPES : Pointes de silex en feuille de laurier taillées de deux côtés. Fig. 6 et 7.	Stations à l'air libre, abris et grottes; Solutré [Saône-et-Loire]; Laugerie-Haute, Badegols, Saint-Martin d'Excideuil [Dordogne].	CLIMAT FROID ET SEC	Homme brachycéphale et mésati-céphale, se rapprochant de nos races actuelles. La Lesse, Cromagnon, Laugerie-Basse, Baoussé, Roussé, Solutré (partie).
		<b>MOUSTIÉRIEN</b> Époque du Moustier TYPES : Pointes de silex retaillées d'un seul côté et racloirs. Fig. 3 et 4.	Grottes et stations en plein air: Moustier [Dordogne]; Chez-Pouré [Corrèze]; la Martinière et l'Ermitage [Vienne]; la Mère-Grand [Saône-et-Loire]; Buoux [Vaucluse]; Néron [Ardèche]; Goudenans-les-Moulins [Doubs]; Cœuvres [Aisne]; Brèches de Genay et Ménétreux-le-Pitois [Côte-d'Or]; Alluvions des bas niveaux: Grenelle, Levallois, Clichy [Seine]; le Pecq [Seine-et-Oise]; Montguilain [Oise].	GLACIAIRE : CLIMAT FROID ET HUMIDE	Grand développement de l'ours des cavernes. Rhinocéros. Homme dolichocéphale, type assez inférieur. Engis, l'Olmo.
		<b>ACHEULÉEN</b> Époque de Saint-Acheul. TYPES : Grands instruments de pierre en forme d'amande. Fig. 1.	Alluvions des hauts niveaux: Saint-Acheul, Abbeville, Thenne [Somme]; Sotteville-les-Rouen [Seine-inférieure]; Vaudricourt [Pas-de-Calais]; San-Isidro [Madrid]. Plateaux: Beaumont [Vienne]; Tilly [Allier]; La Ganterie [Côtes-du-Nord]; vallées de la Sausse et de la Ceillonne [Haute-Garonne].	PRÉGLACIAIRE : CLIMAT TEMPÉRÉ	Hippopotame. Eléphant antique. Homme, type le plus inférieur. Néanderthal, Egusheim, la Naulette, Denise.

# Historiography

## 1880 - 1915: the time of the glorious years

Multiplication of excavations and important discoveries:

- 1880 *Külna* (Tch.)
- 1895 *Krapina* (Croatie)
- 1905 *Le Moustier* (M. Bourlon)
- 1908 *La Chapelle-aux-Saints*
- 1908-14 *abri inf du Moustier*
- 1909 *Pech de l'Azé I*
- 1909 et suivantes *La Ferrassie*
- 1909 *Abri Romani* (Esp) *Tata* (H)
- 1910-14 *El Castillo* (Esp)
- 1911 et suivantes *La Quina*
- 1913 *Somme* (V. Commont)
- 1916 « *Micoquien* » O. Hauser

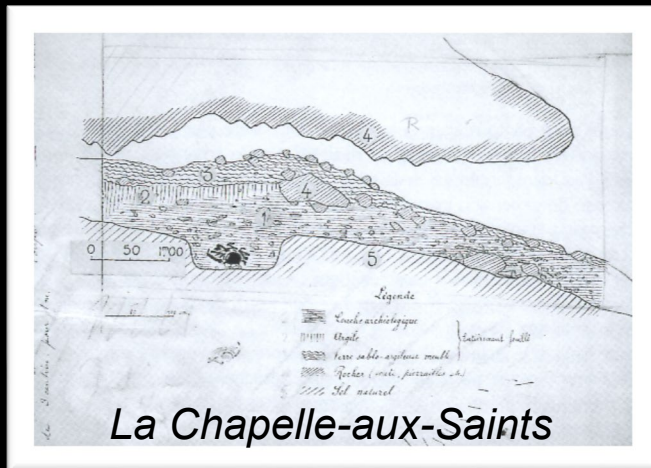

After J. Jaubert, modified

# Historiography

## Between the two WW:

### Emergence of new fieldworks

- ❑ Russie, Caucase, Asie Centrale
  - *Kiik Koba* (Crimée) Bonch-Osmolovski
  - *Teshik-Tash* (Uzb.) A.P. Okladnikov
- ❑ Moyen-Orient
  - *El Tabun* D. Garrod
  - *Es-Skhul* T.D. Mc Cown
  - *Qafzeh* R. Neuville et M. Stékélys

### Excavation of numerous reference sites:

- *Mas-Viel* (46), *Mont-Dol* (35), *La Chaise* (16)
- *Pech de l'Azé* (R.Vaufrey), *La Micoque* (D.Peyrony), *abri Chadourne*...
- Publications D. Peyrony: *Le Moustier* (1930), *La Micoque* (1938)
- => Moustérien de tradition acheuléenne, Moustérien typique

### New sites, eponym regions:

- Szélétien, 1937 (I.L. Cervinka), Pontinien, 1939 (A. Blanc, Italie)

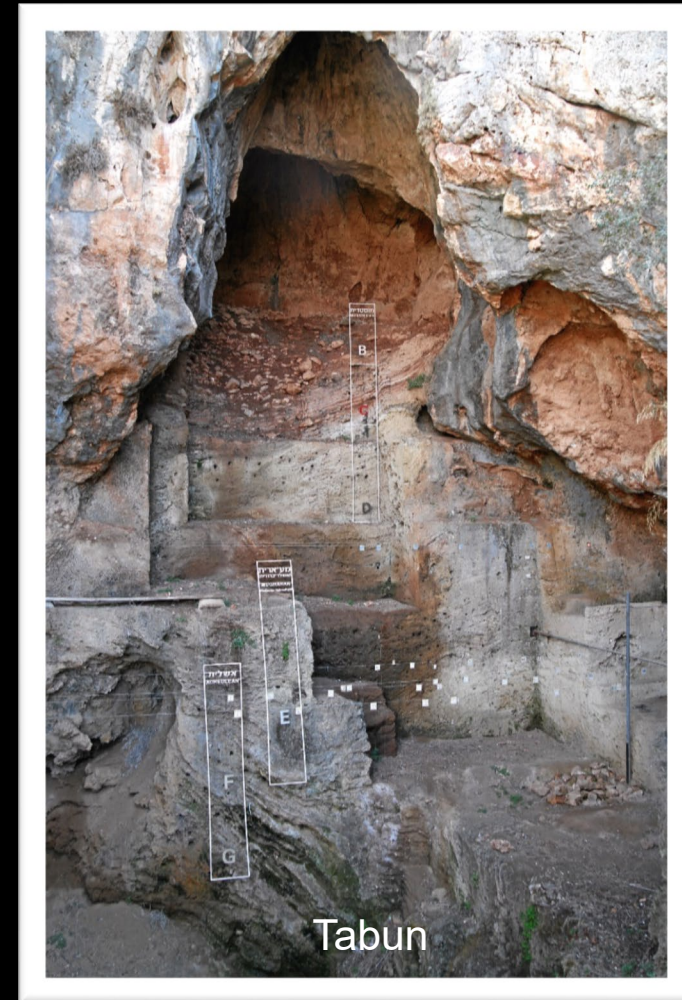



# Historiography

50-60's : « méthode Bordes »

François Bordes  
(1919-1981)



- *L'Anthropologie, Société préhistorique française*
- 1949 diagrammes cumulatifs Bordes
- 1950 : *Évolution buissonnante du Moustérien*
- ⇒ **Charentien Quina, Ferrassie, Moustérien à denticulés**

- 1950-52 *Pech Azé*
- 1953-65 *Combe-Grenal*
- 1953-65 *La Quina* (Henri-Martin)
- 1946-63 *Grottes d'Arcy*
- 1957 Sites méditerranéens H. de Lumley (*Les Peyrards, Hortus...*)

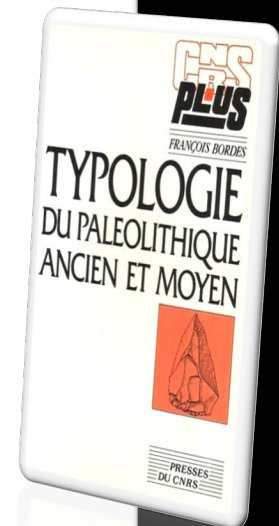
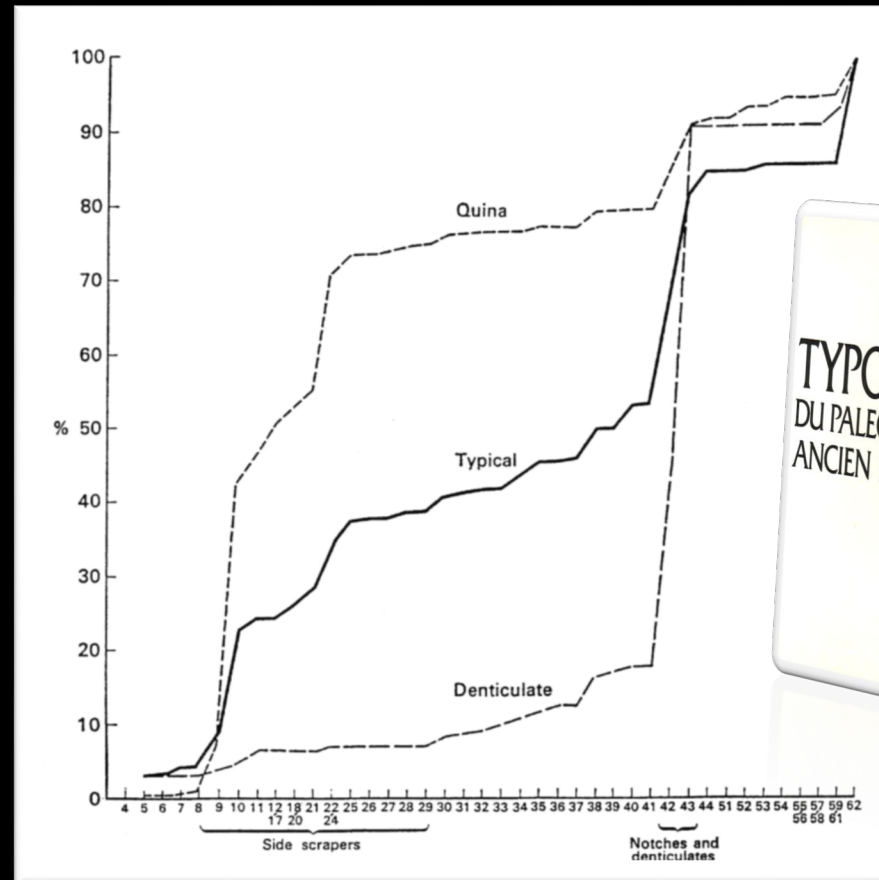

After J. Jaubert, modified

# Historiography

## 60's: theories and polemics' time

1950-60 F. Bordes  
'cultural' thesis

1965-69 P. Mellars  
'chronological' thesis

1966 : S. & L.R. Binford  
'functional' thesis

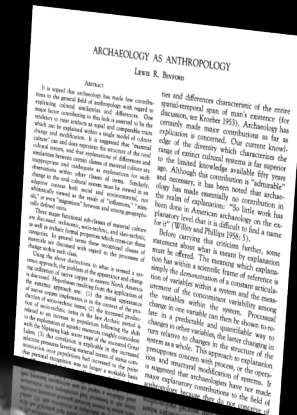
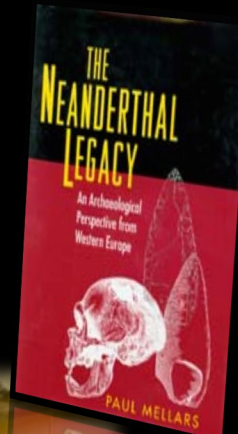
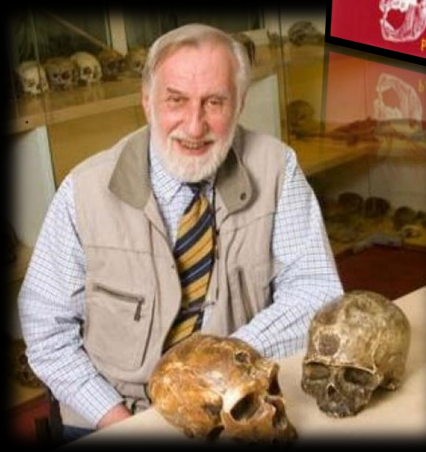
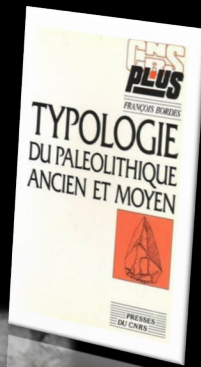

# Historiography

## 70's: regional synthesis, monographs

- **Regional synthesis**

J. Combier (Ardèche),  
J.-M. Le Tensorer (Agenais),  
A. Debénath (Charente),  
A. Tuffreau (Nord),  
J.-L. Monnier (Bretagne)...

- **Monographs**

– *Le Lazaret*, 1969  
– *Hortus* 1972  
– UISPP Nice 1976

- **New interpretations (USA)**

– N. Rolland 1977  
– H. Dibble 1984

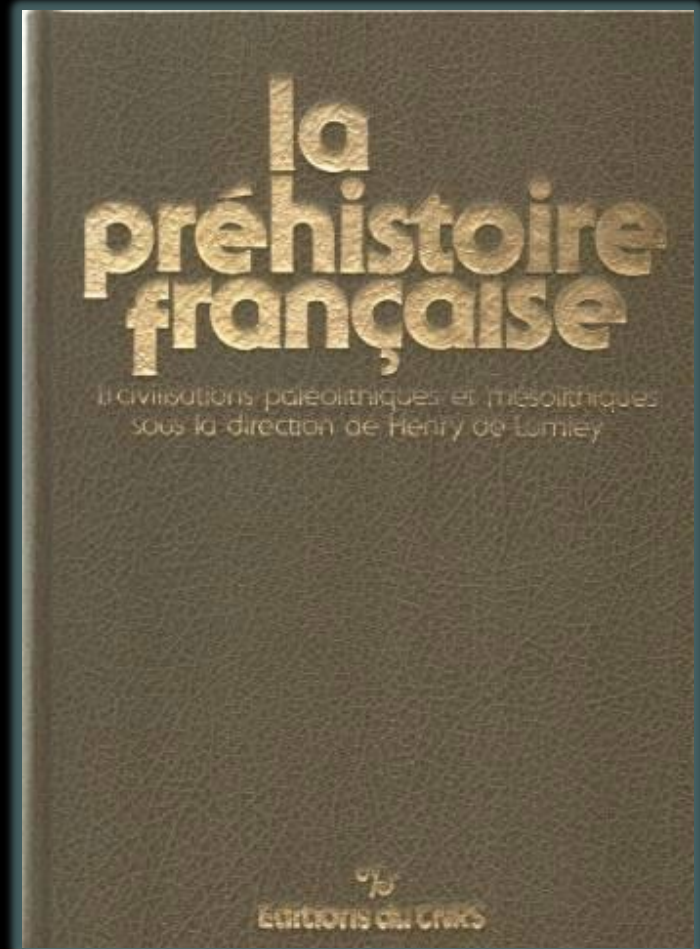

# Historiography

From 70's: methodological turning points...

...emergence of rescue archaeology...

**Biache-Saint-Vaast (1976), A. Tuffreau dir.**

1100 m<sup>2</sup> fouillés à la main



# Historiography

From 70's: methodological turning points...

... palaeodosimetric datings ...

Martin Aitken (1922-2017)



Yuji Yokoyama



Hélène Valladas



TL

OSL

ESR

IRSL



U/Th

ESR-U/Th

RPE

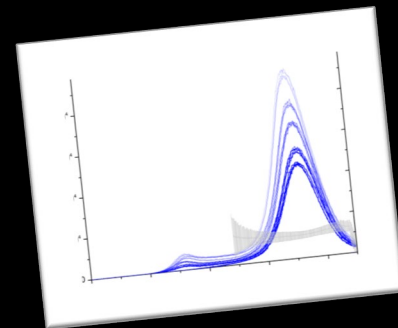

# Historiography

From 70's: methodological turning points...

...emergence of lithic technological approach

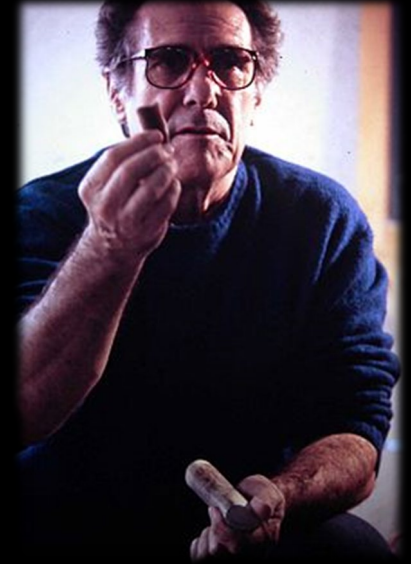
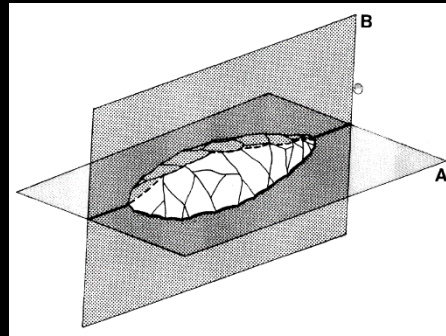
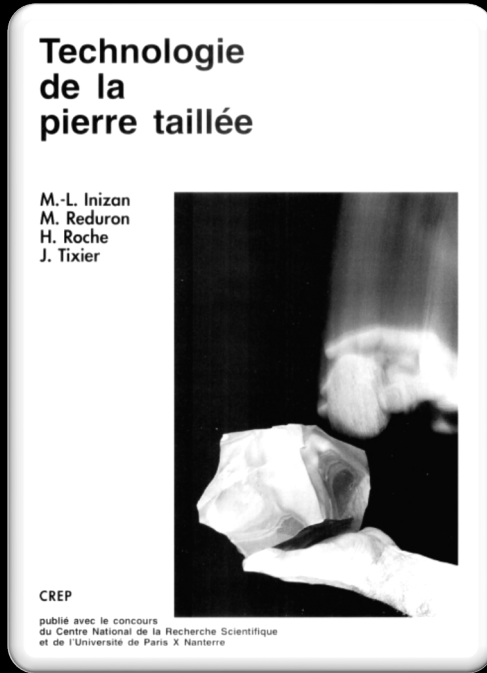

**Jacques Tixier  
(1925-2018) & al.**

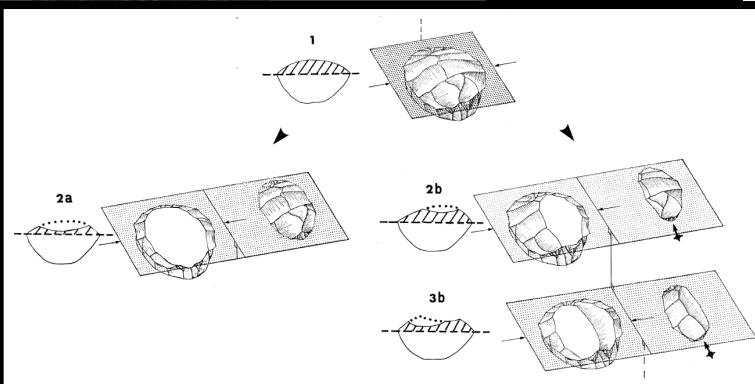
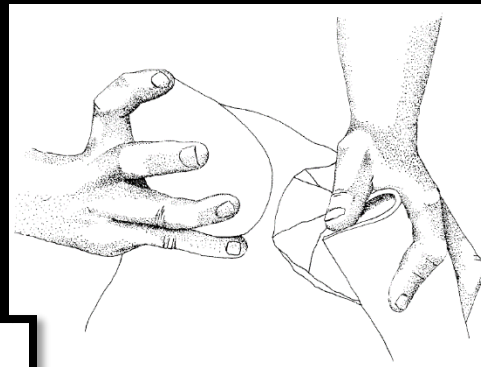

**E. Boëda. *Le concept Levallois :  
variabilité des méthodes*, 1994.**



# **Middle Palaeolithic Lithic Technologies**



# Diversity of Lithic Production Systems During the Middle Paleolithic in France

Are There Any Chronological Trends?

Anne Delagnes

Institut de Préhistoire et de Géologie du Quaternaire UMR 5199-PACEA/Université Bordeaux I  
FRANCE a.delagnes@ipq.u-bordeaux1.fr

Liliane Meignen

C.N.R.S./CEPAM, Sophia Antipolis, Valbonne FRANCE meignen@cepam.cnrs.fr

①

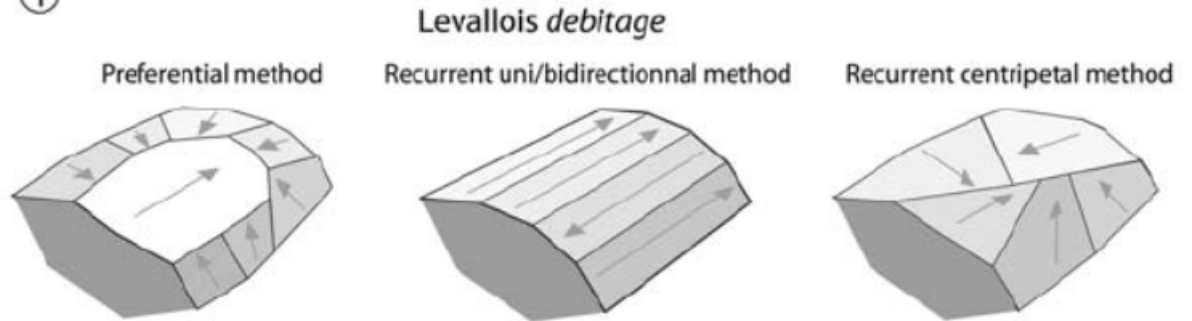

Laminar *debitage*

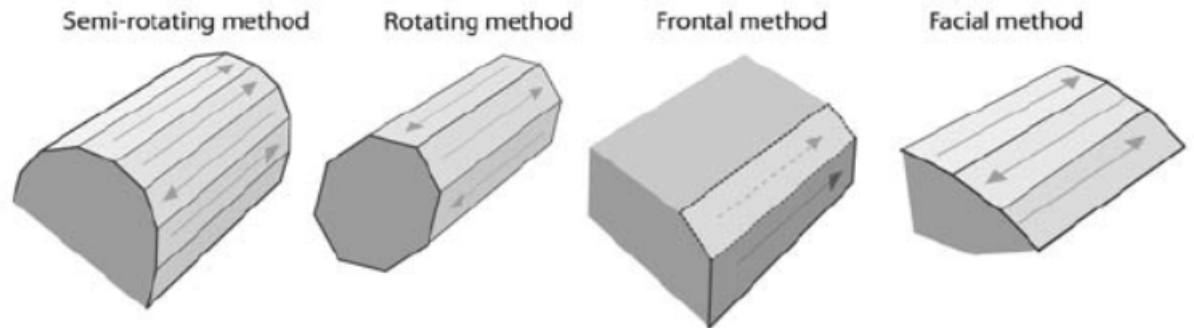

②

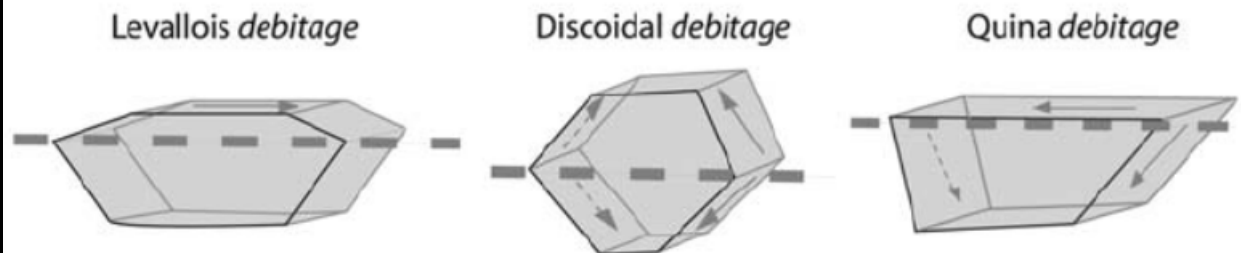

# **Levallois concept**

# Levallois concept

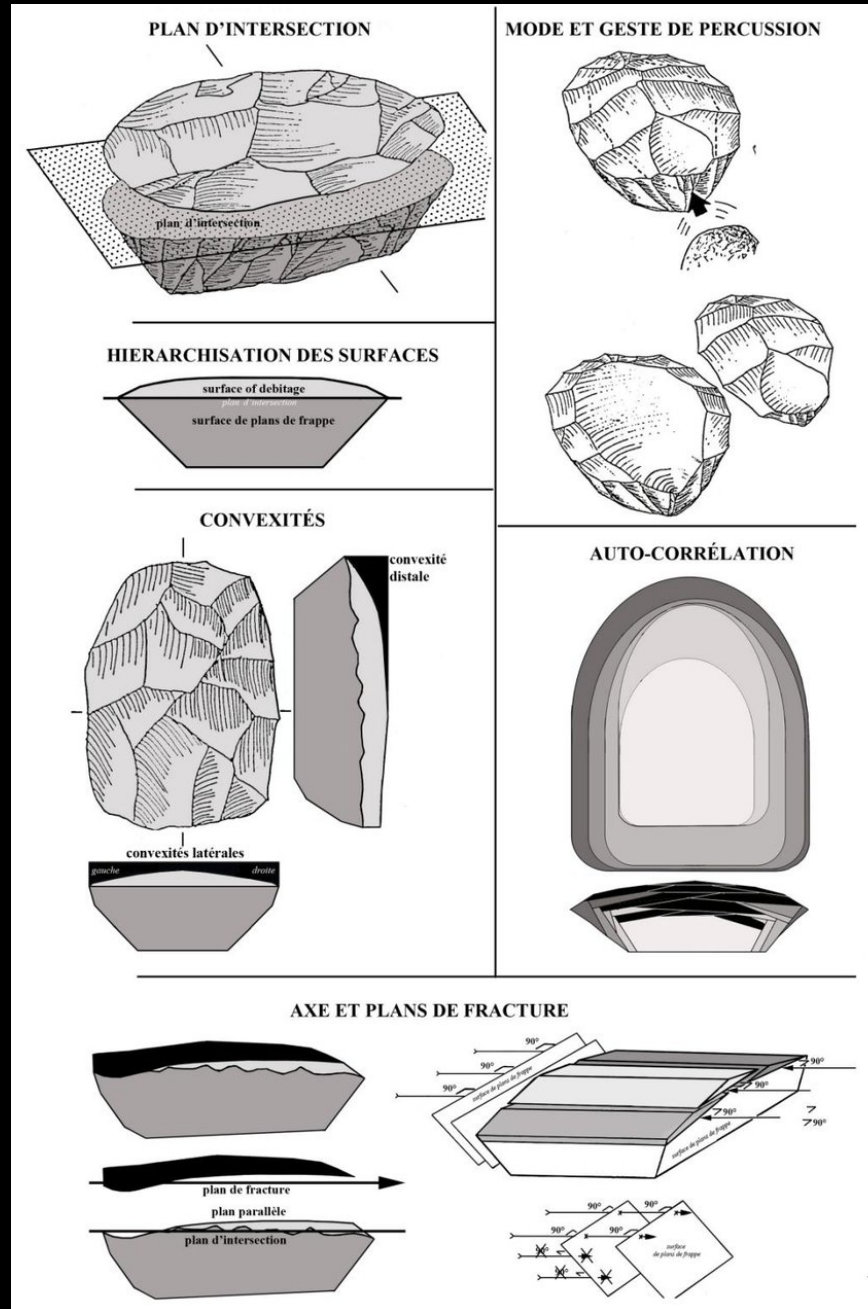

Boëda, 1994,  
Boëda, 2013

# Levallois concept

## Criterion 1: plane of intersection

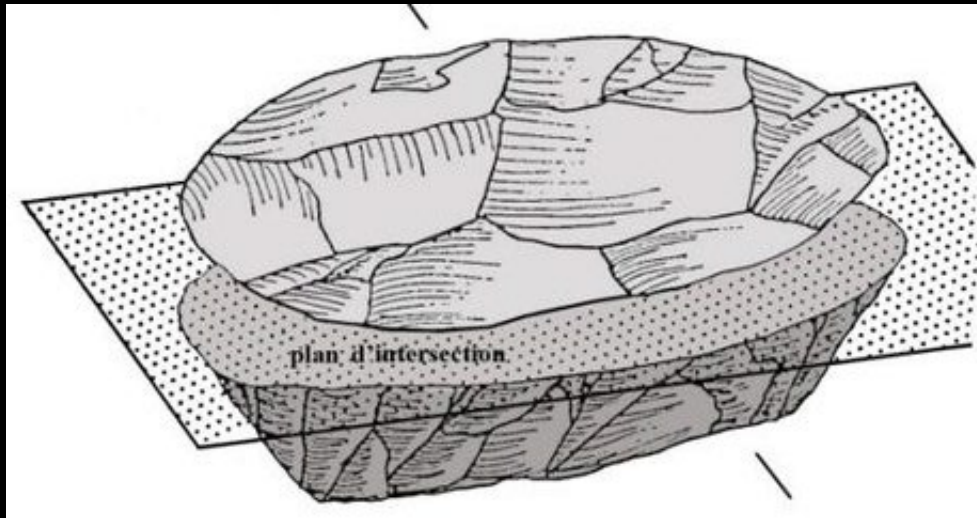

## Criterion 3: predetermination with lateral and distal convexities

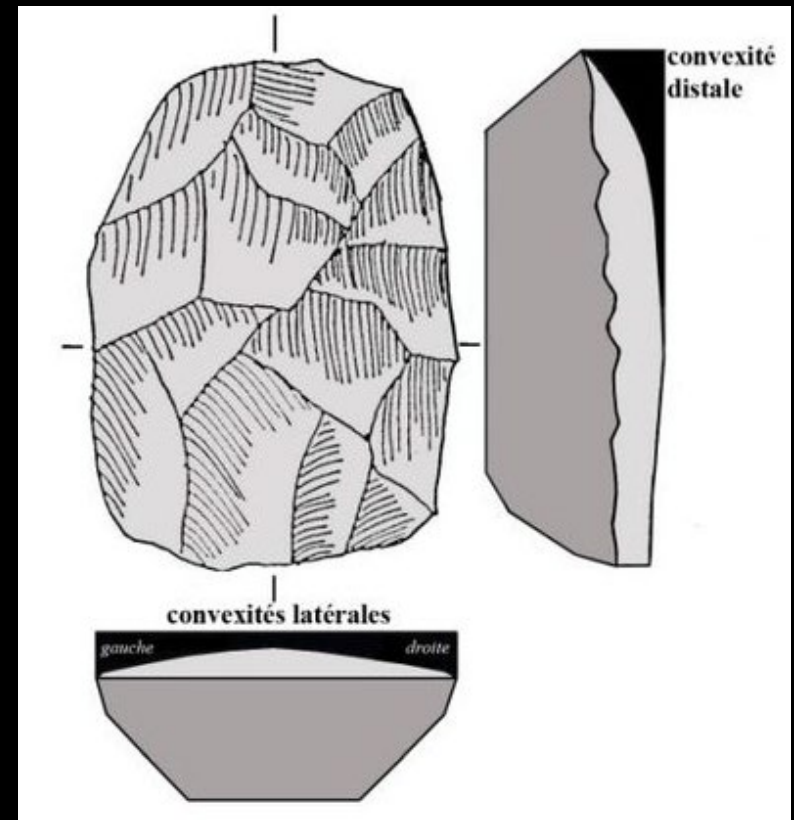

## Criterion 2: hierarchically related surfaces

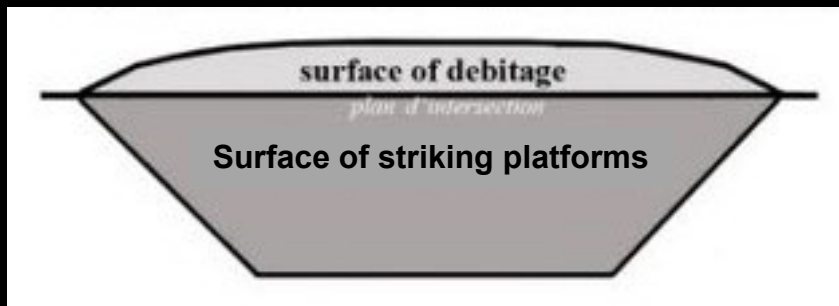

# Levallois concept

## MODE ET GESTE DE PERCUSSION

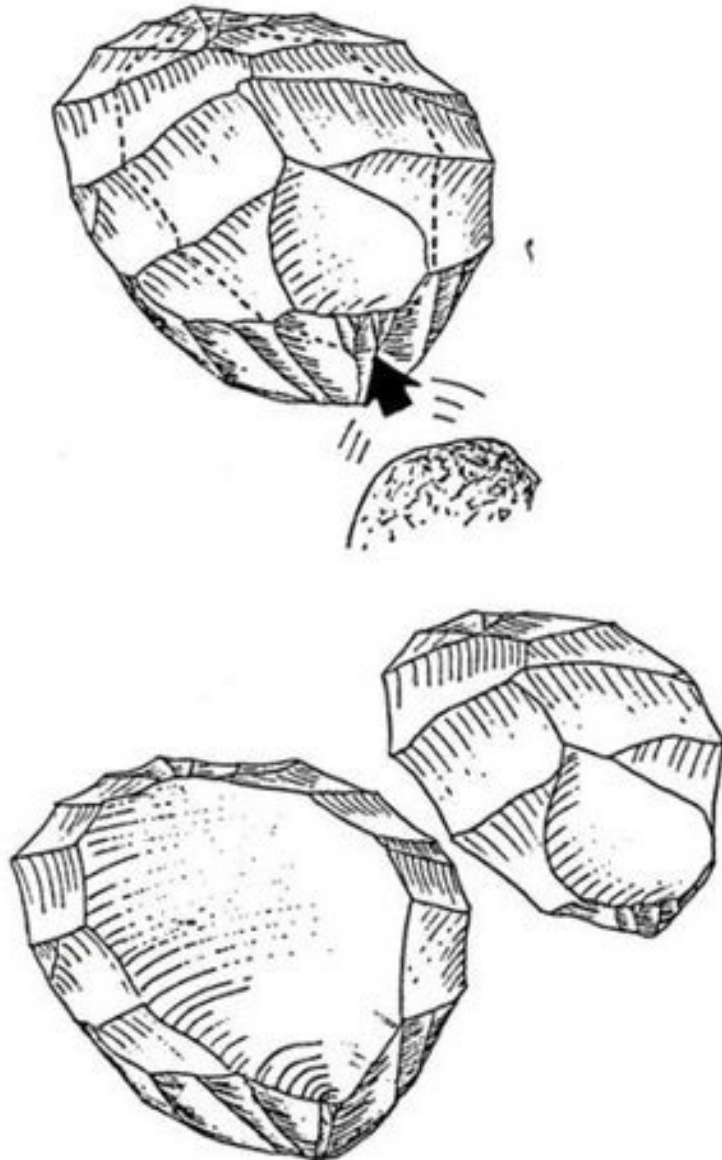

**Criterion 4: direct,  
hard hammer percussion**

Boëda, 1994,  
Boëda, 2013

# Levallois concept

Criterion 5: axes of percussion are perpendicular to the hinge

## AXE ET PLANS DE FRACTURE

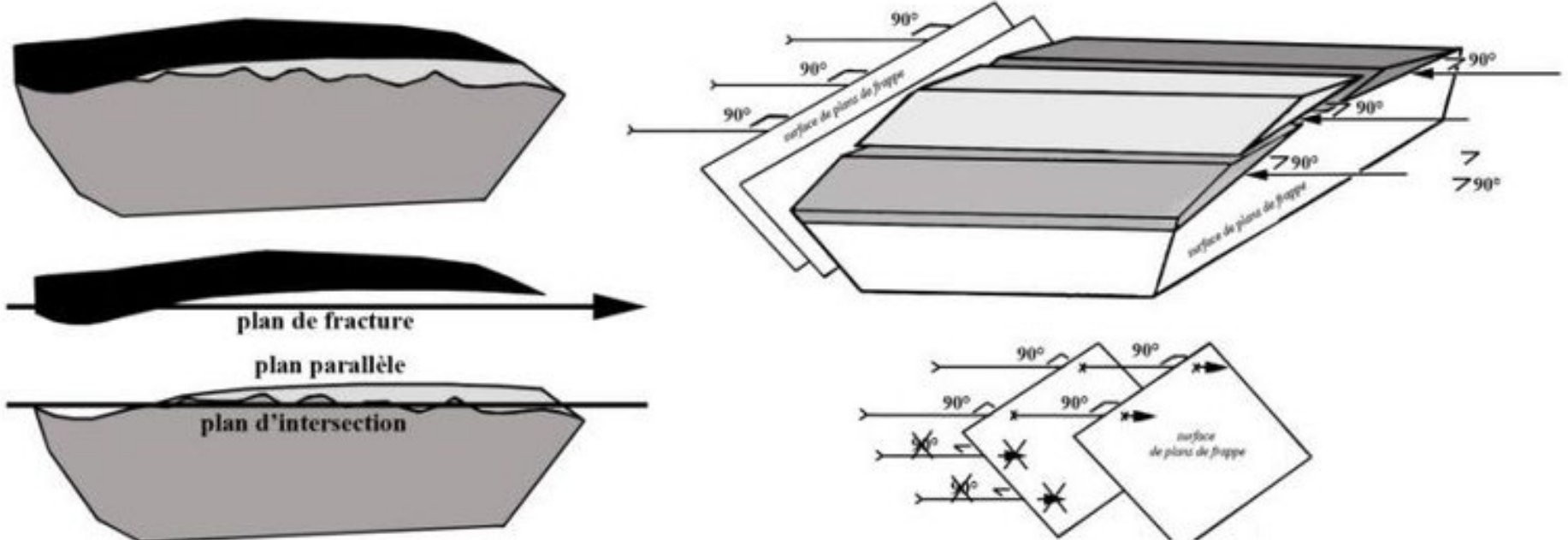

# Levallois concept

## AUTO-CORRÉLATION



## Criterion 6: auto-correlation

allows to:

- correct the accidents during the production phase
- maintain the predetermination criteria

After Boëda, 2013

# Levallois methods

Method of initialisation: centripetal  
Method of production: preferential

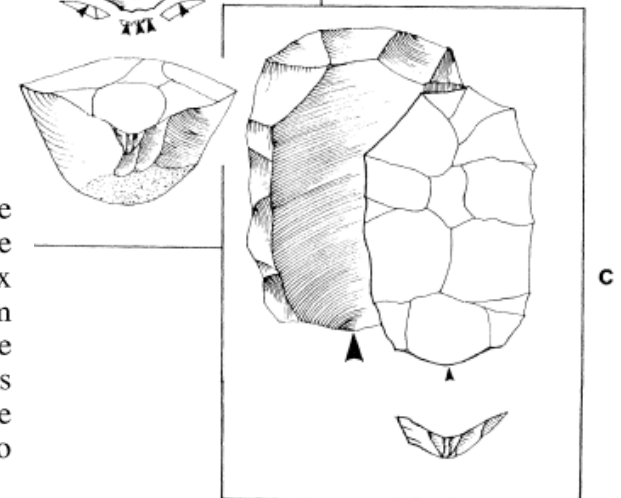
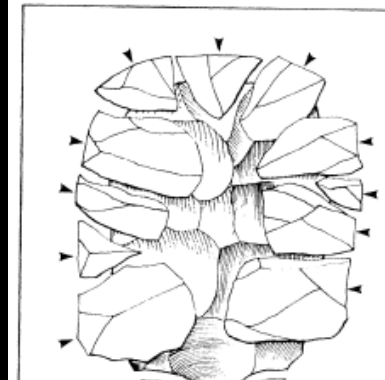
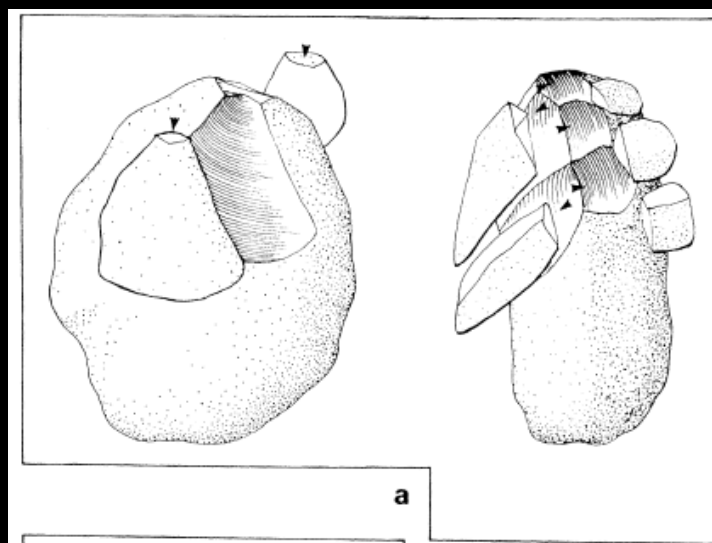
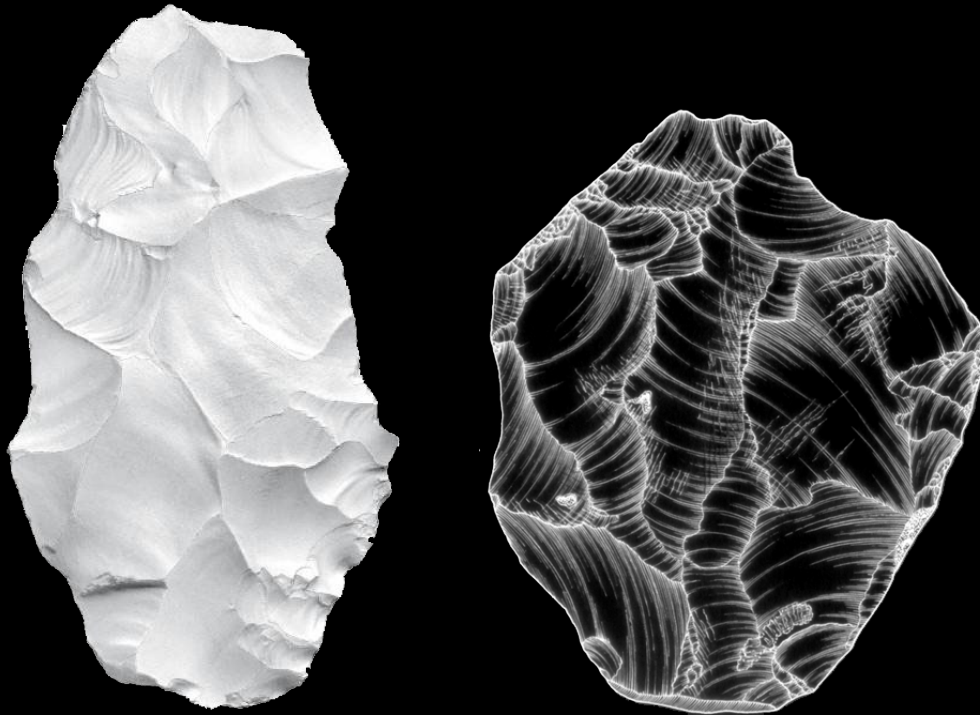

- Levallois debitage of a preferential flake (fig. 22 : 2a, fig. 23 and fig. 26 : 1)

The aim is the manufacture of a single flake from each prepared debitage surface. The butt of the flake is small relative to the total surface that is in principle planned for it, and the flake spans most of the debitage surface. Figure 23a shows the creation of the two convex surfaces by means of centripetal removals, 23b showing the preparation of the striking platform (also carried out by means of centripetal removals) and the final shaping out of the debitage surface. In 23c, the Levallois flake removal operation is shown. If the volume of the core allows the manufacture of another flake, the entire process must be gone through once again before the second flake is removed. When within a single assemblage the products obtained correspond to a single flake for each prepared surface, the method is referred to as “lineal”.



# Levallois methods

Method of initialisation: centripetal

Method of production: recurrent centripetal

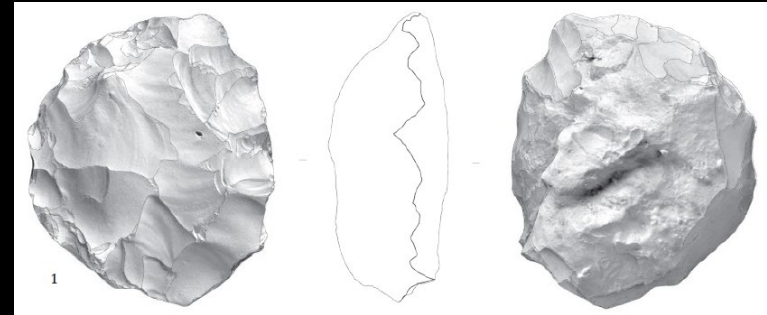
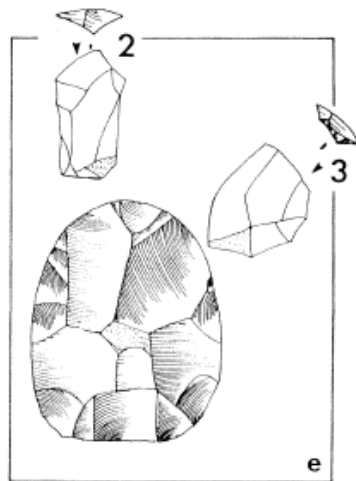
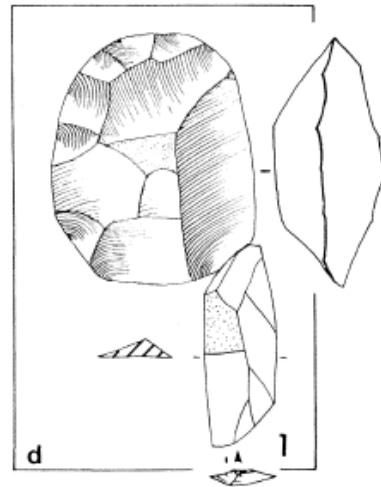
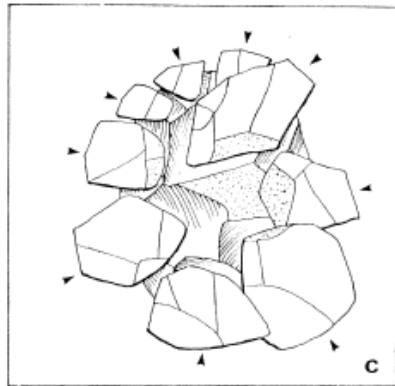
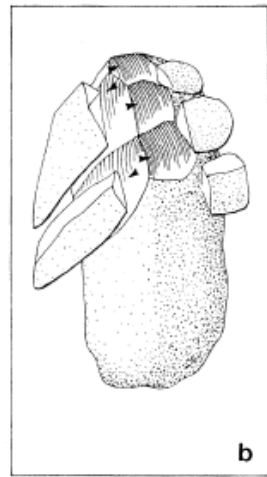
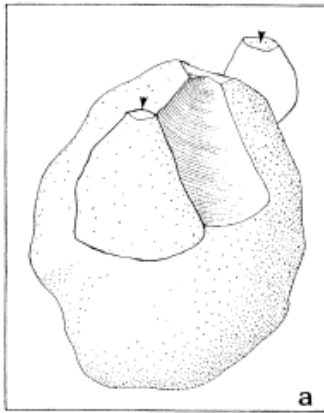

0  
5cm

### 3. Recurrent centripetal Levallois method (fig. 24)

The margin of the entire surface selected as the striking platform can be used, but confusion must be avoided with discoidal debitage : the specifically Levallois character of the method lies in the debitage surface being exploited in such a way as to ensure that it remains always in the same debitage plane.

# Levallois methods

Method of initialisation: centripetal

Method of production: recurrent unipolar

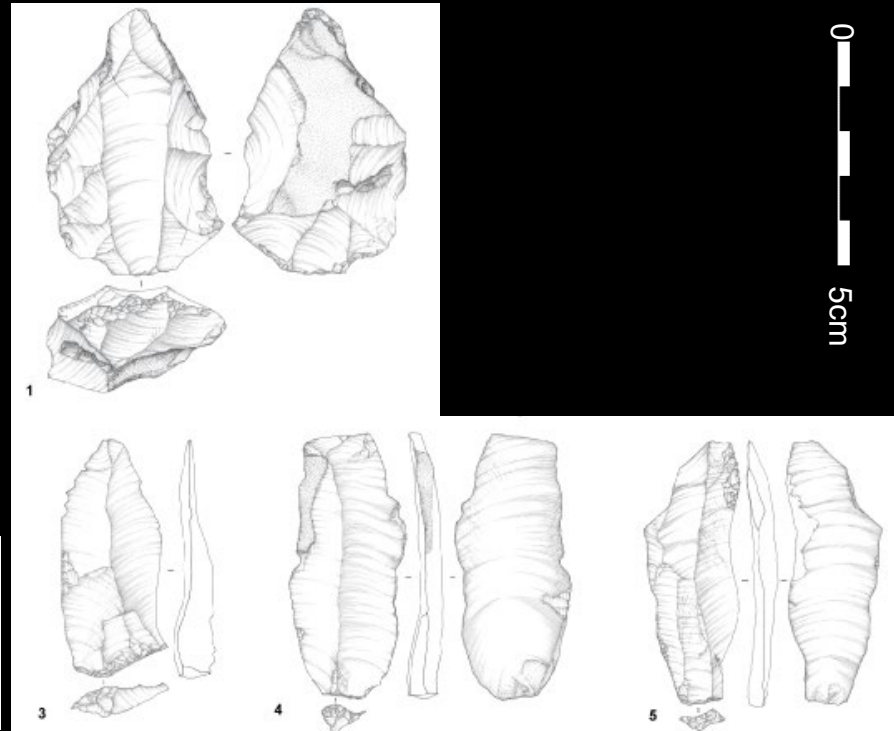

## 1. Recurrent unipolar Levallois method

The flakes have a single direction of removal, and tend to be elongated. The striking platform is small. If the directions of the removals converge slightly, the flakes will be triangular in shape. Levallois points often proceed from this type of knapping scheme, and more rarely from bipolar preparation. Such a method is documented in the Sudano-Egyptian region<sup>64</sup> and in the Near East<sup>65</sup> for instance (fig. 26 : 2).

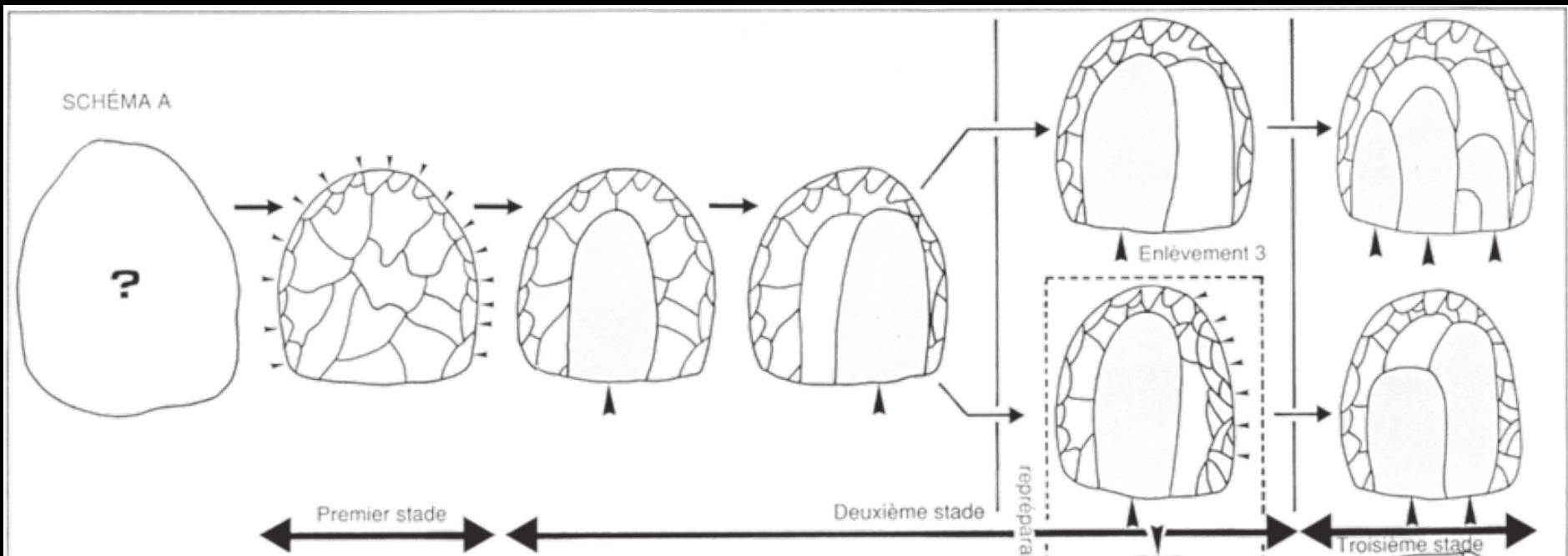

# Levallois methods

Method of initialisation: centripetal  
Method of production: recurrent bipolar



## 2. Recurrent bipolar Levallois method (fig. 22 : 4b)

Flakes that originate from two opposed preferential striking platforms can be observed, the direction of removal being visible on the upper faces of the flakes. Levallois blades are traditionally achieved by means of such a method : it can be noted that in Levallois blade debitage, the ridges created by the intersection of the two convex surfaces do not serve as a crested blade (see under : blade debitage).

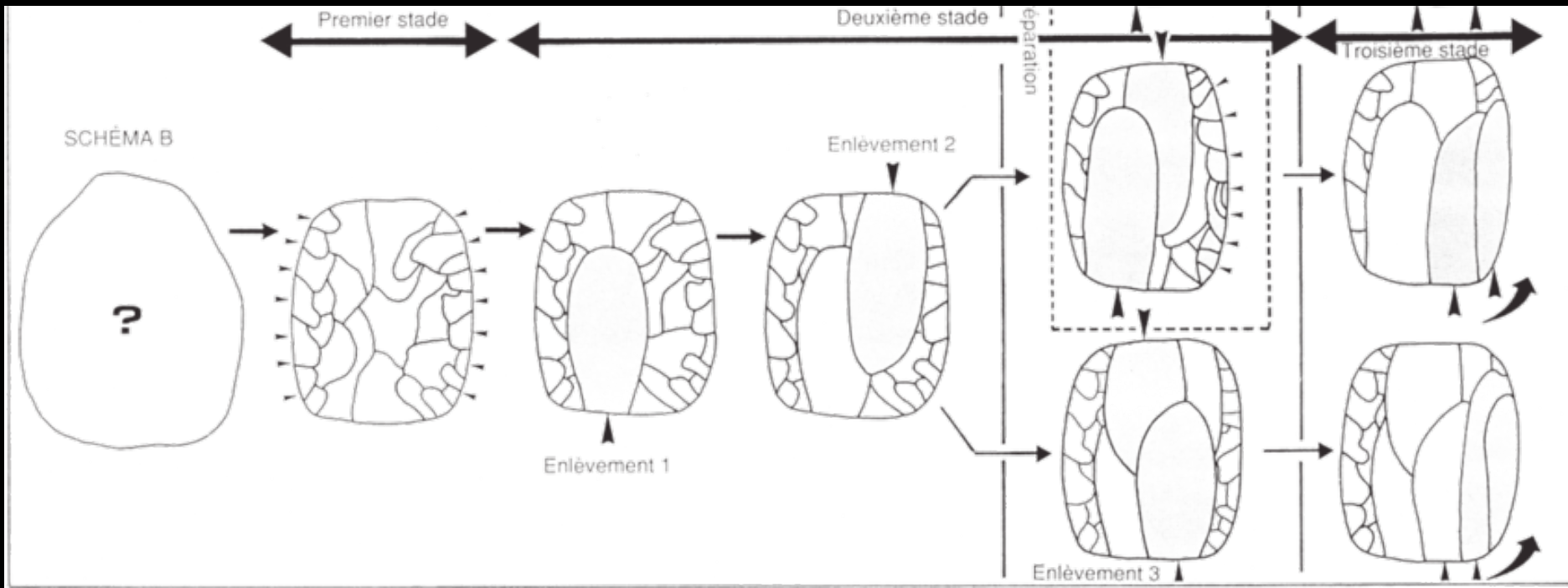

# Levallois methods

Method of initialisation: unipolar convergent

Method of production: preferential

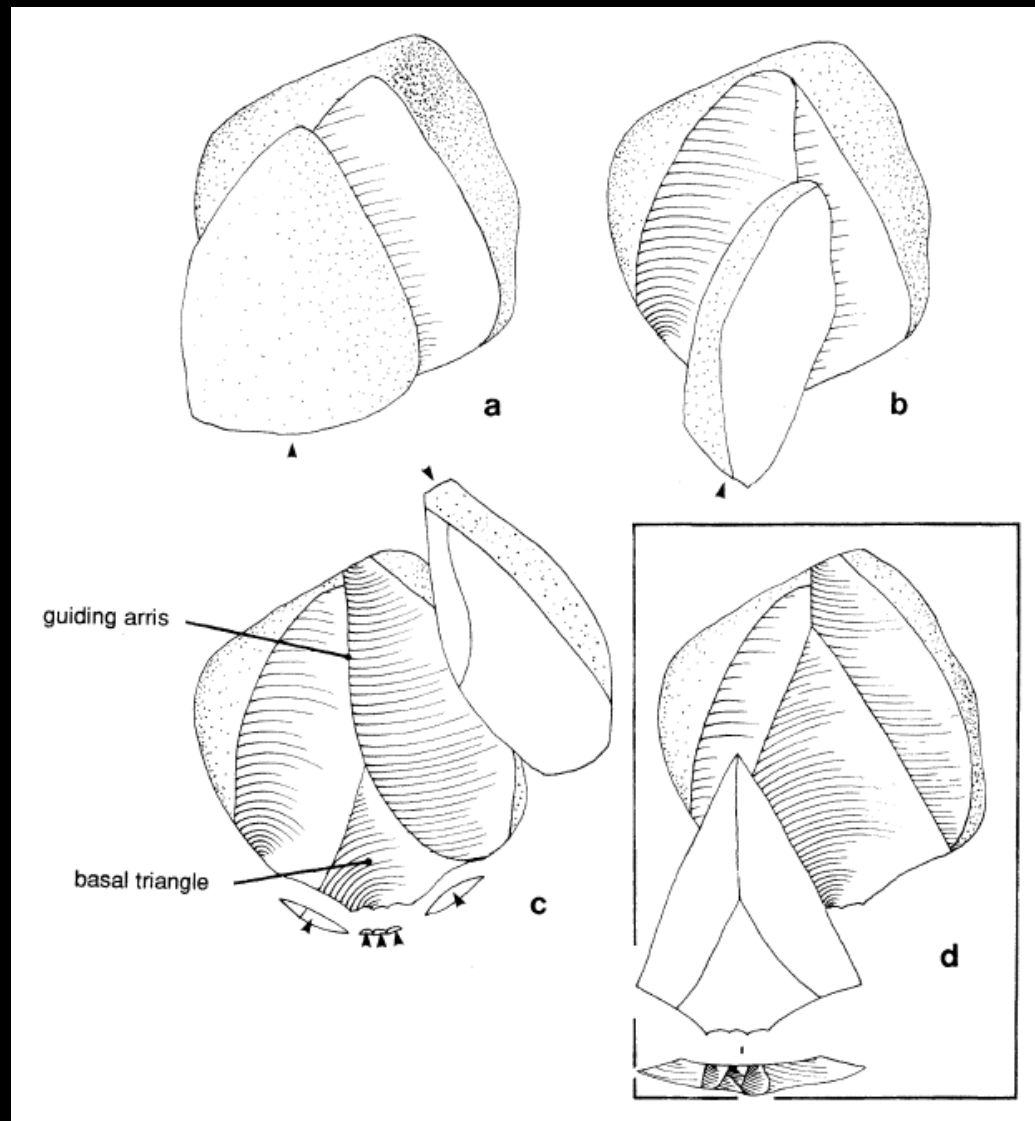
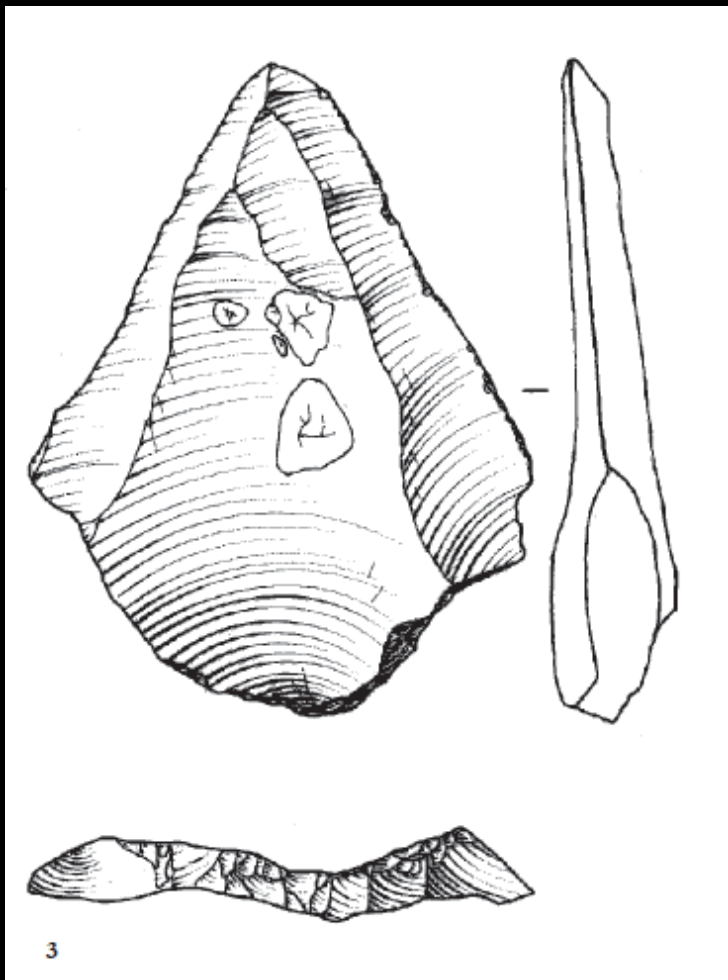

# Levallois methods



0 10cm

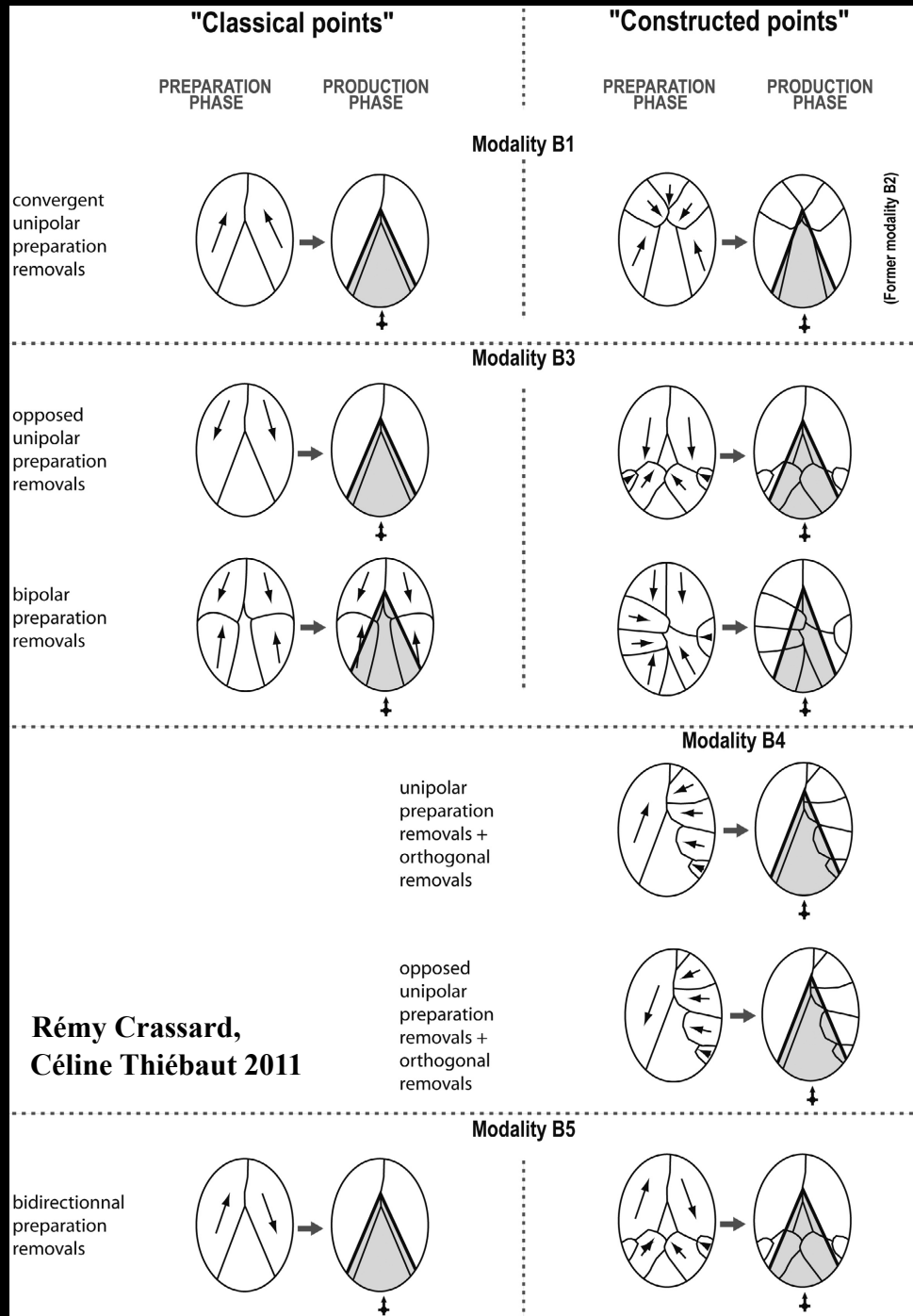

Rémy Crassard,  
Céline Thiébaud 2011

**Discoid debitage**

# Discoid debitage

Levallois *debitage*



Discoidal *debitage*

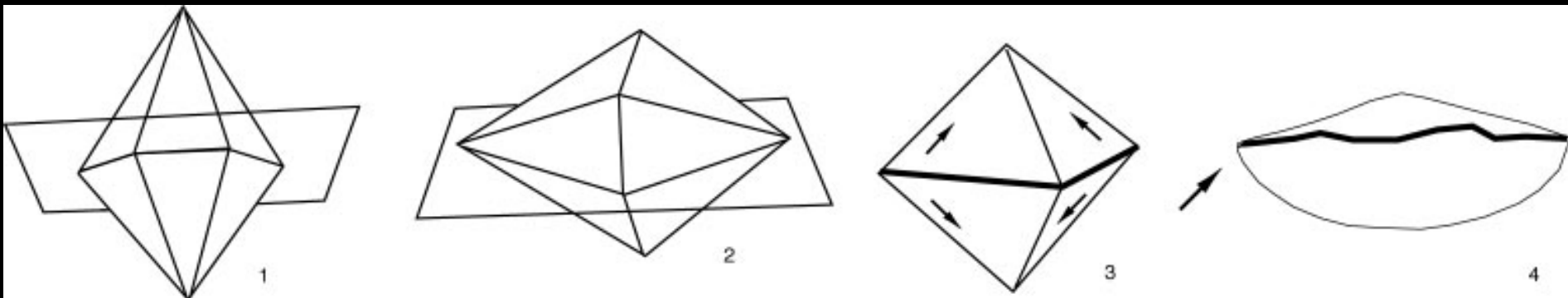
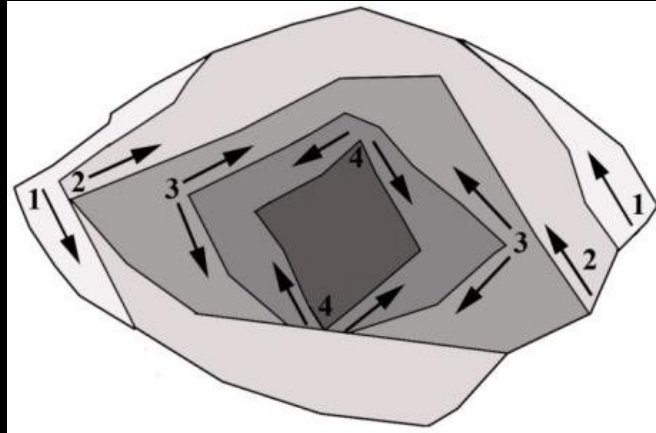
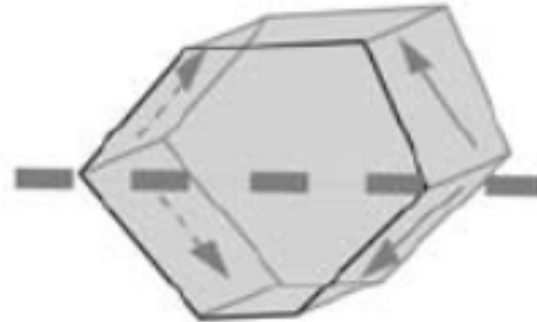

# Discoid debitage

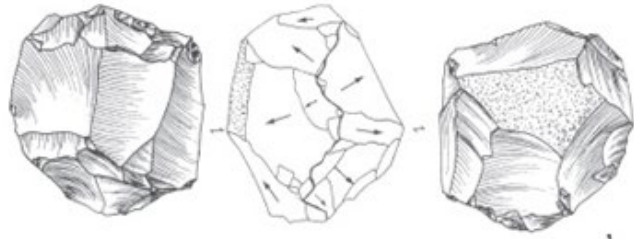

1

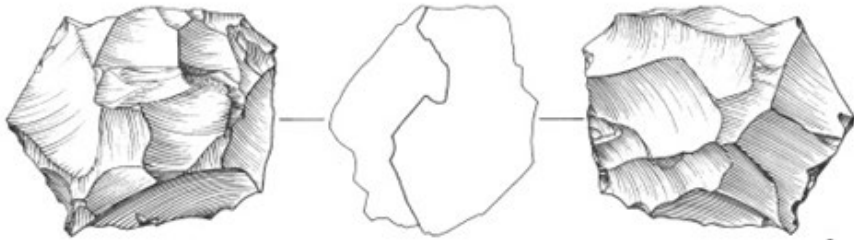

2

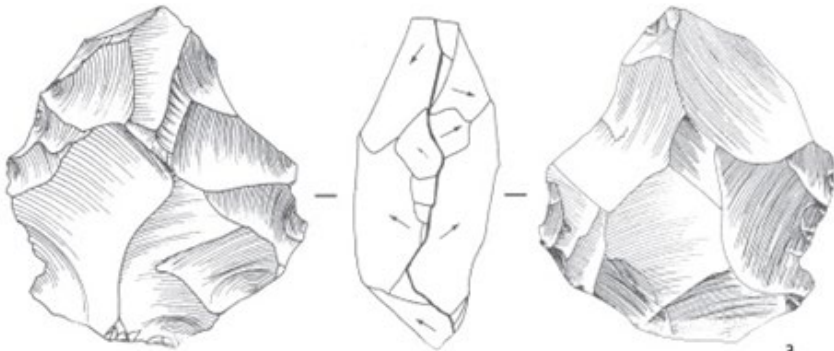

3

0 5cm

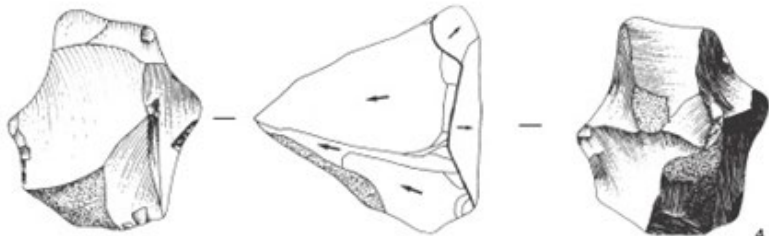

4

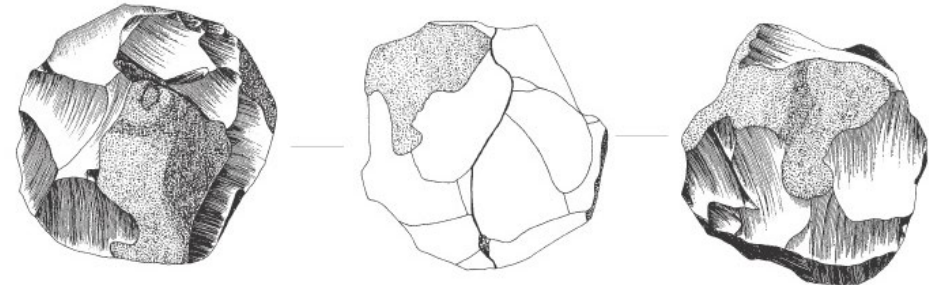
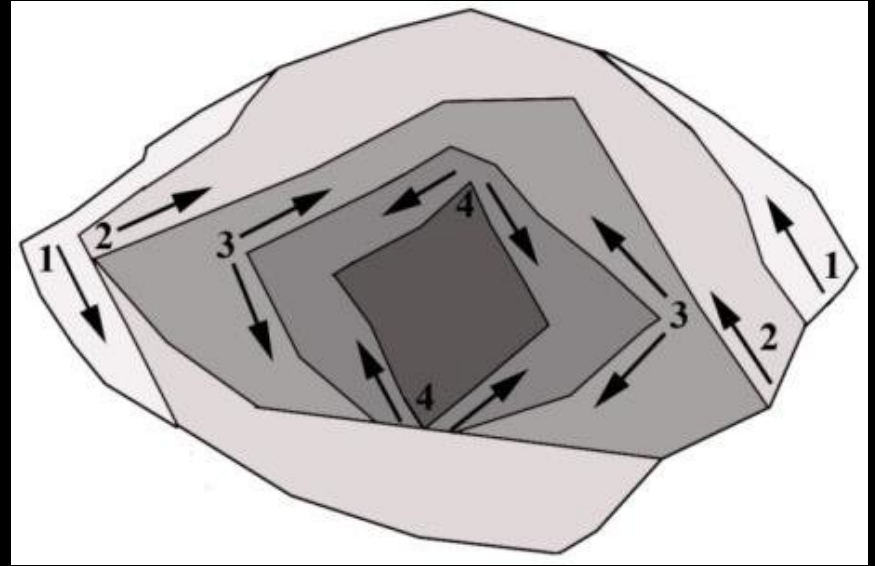

0 5cm



Planche 44 : 1. à 3. Nudéus discoïde à deux surfaces convexes.

4. Nudéus discoïde présentant une surface assez plane ; la seconde est pyramidale.

Planche 45 : nucléus discoïde à deux surfaces convexes exploitées alternativement. Les plages corticales présentes sur les deux surface productives permettent d'estimer la morphologie initiale du bloc de silex.

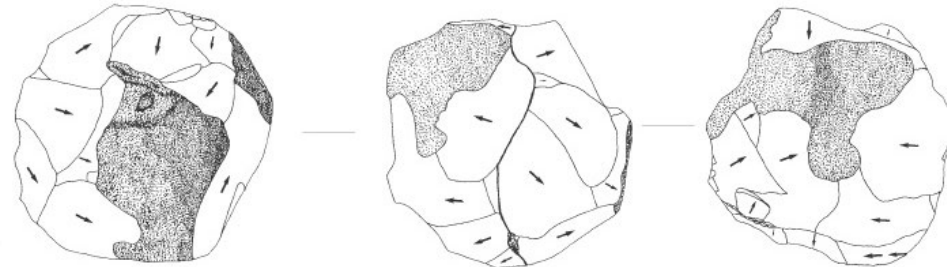

# Discoïd debitage

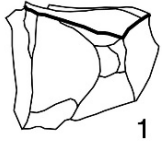

1  
Nucléus discoïds à deux surfaces perpendiculaires.

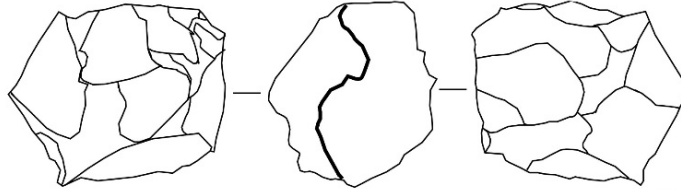

2  
Nucléus discoïde à deux surfaces exploitées alternativement.

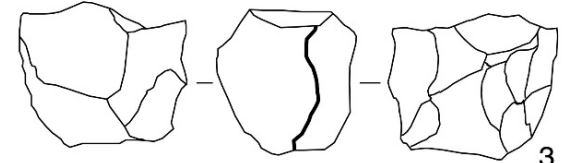

3  
Nucléus discoïde à deux surfaces exploitées alternativement de forme pyramidale.

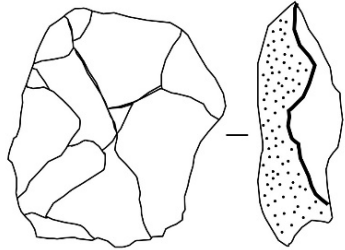

6  
Nucléus discoïde uniface.

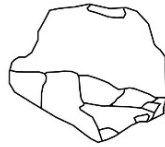

7  
Nucléus discoïde sur éclat.

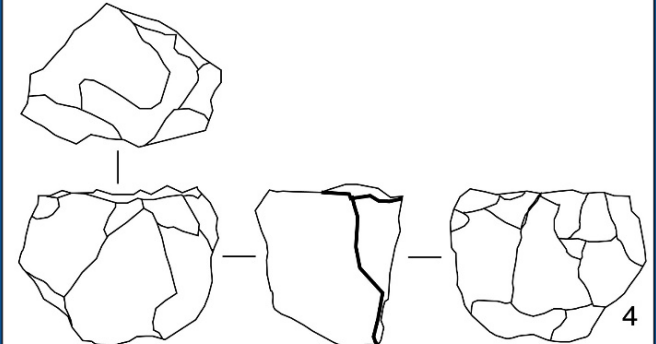

4  
Nucléus discoïde à deux surfaces exploitées alternativement + création d'une troisième surface.

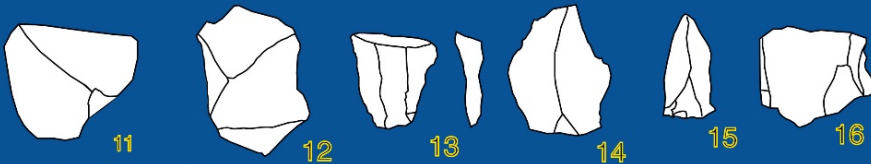

11 et 12. Eclats à dos.  
13. Eclat à profil brisé.  
14. Eclat régulier.  
15. Eclat allongé.  
16. Eclat large.

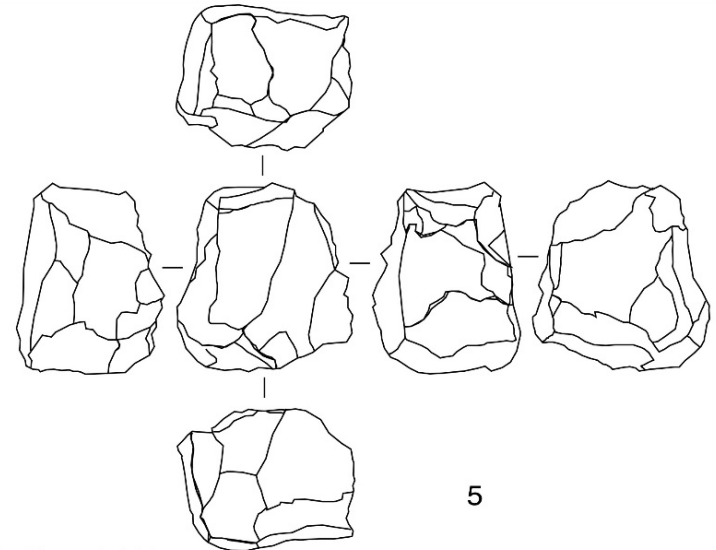

5  
Nucléus polyédrique

# Discoid débitage

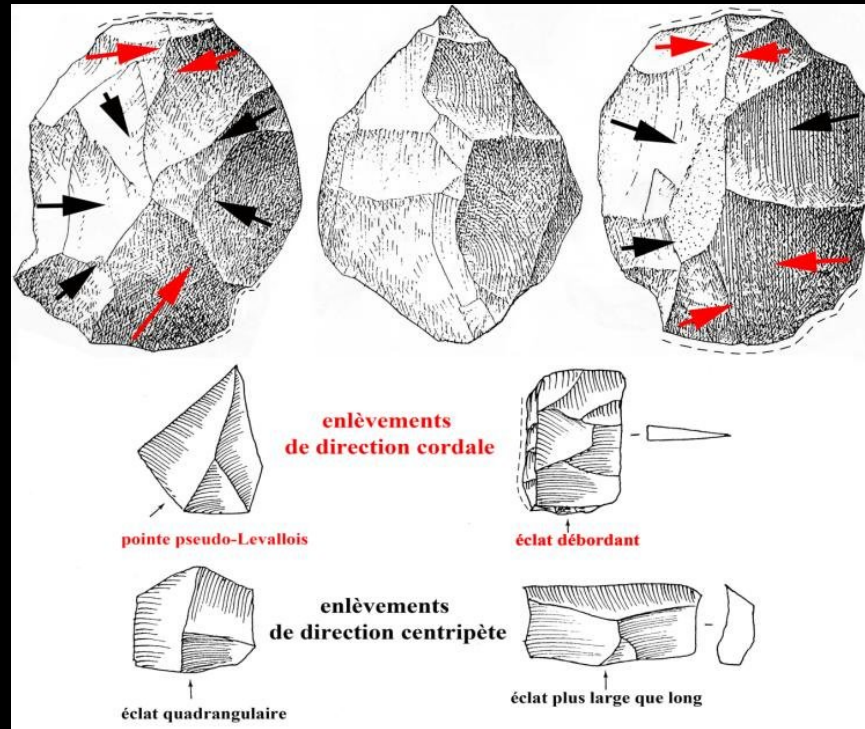

Locht, 2004 thèse

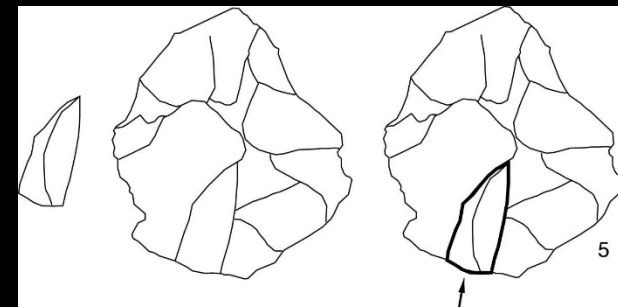
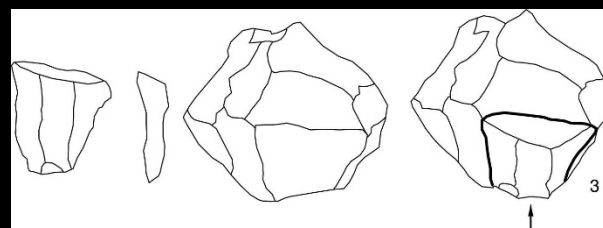
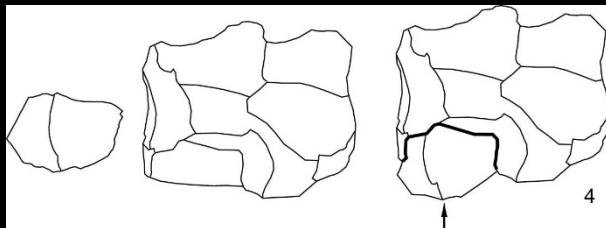
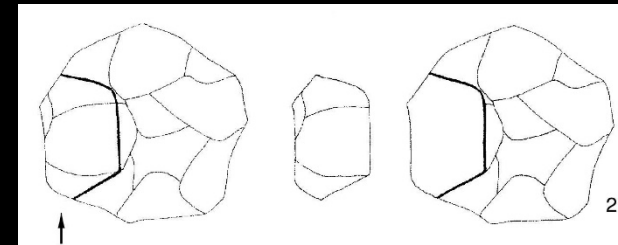
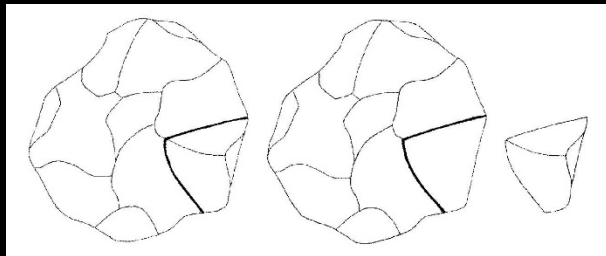

# **Blade debitage**

# Blade debitage

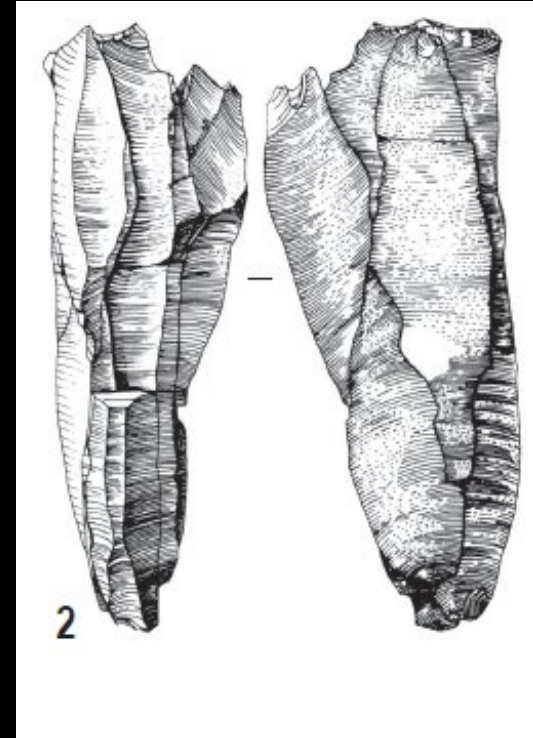
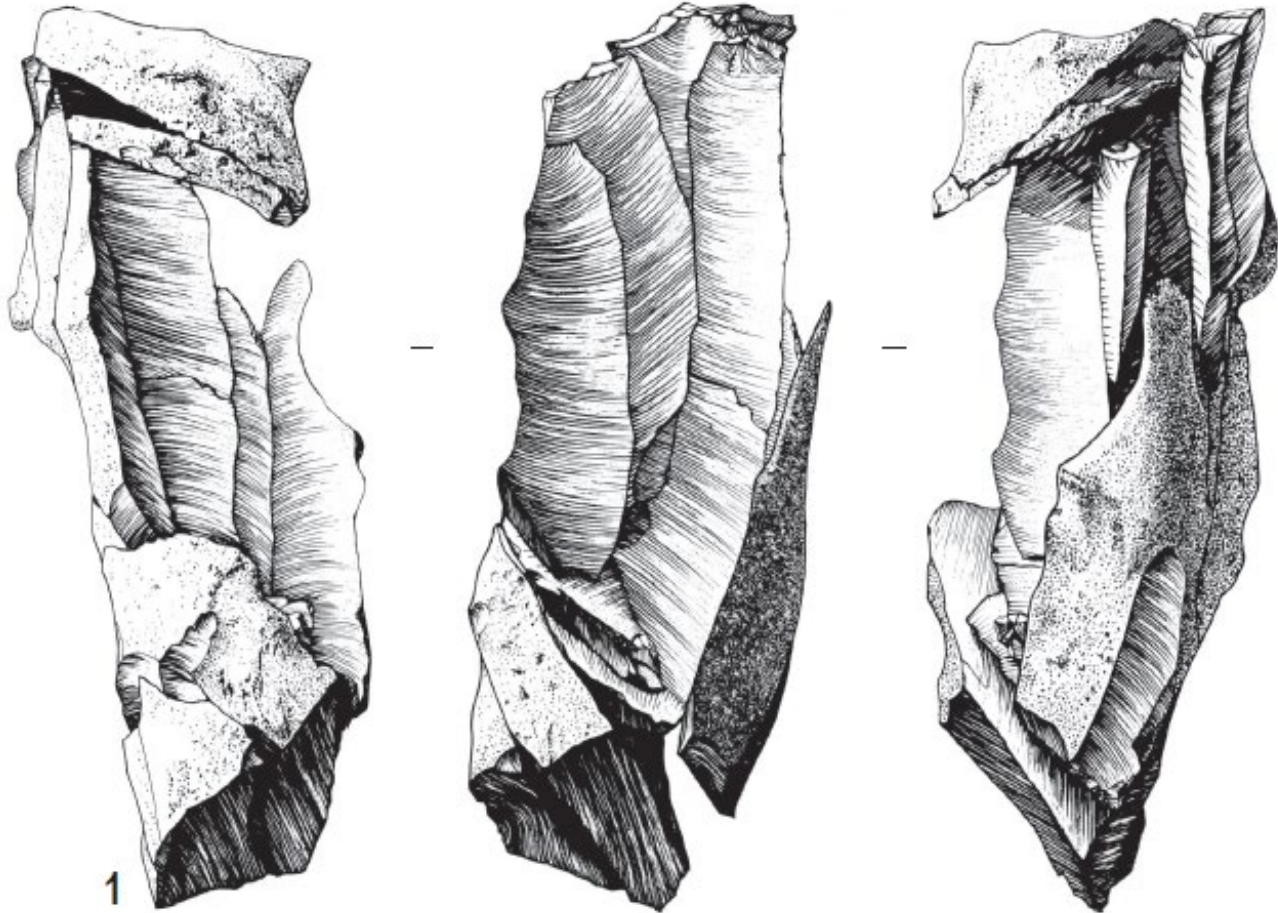

# Blade debitage

construction volumétrique du nucléus				
Volume exploitée /surface productionnelle		type de démarrage		
plus longue/plus étroite	plus longue/plus large	lame d'entame	crête axiale	crêtes latérales et/ou dorsal
Cantalouette IV				
La Mouline				
Tamniès				
Fresnoy-au-Val				
Bettencourt-Saint-Ouen N2b				
Fitz-James				
Bettencourt-Saint-Ouen N3b				
Vallée de la Vanne				
Garris 2				
Cantalouette IV niv.1				

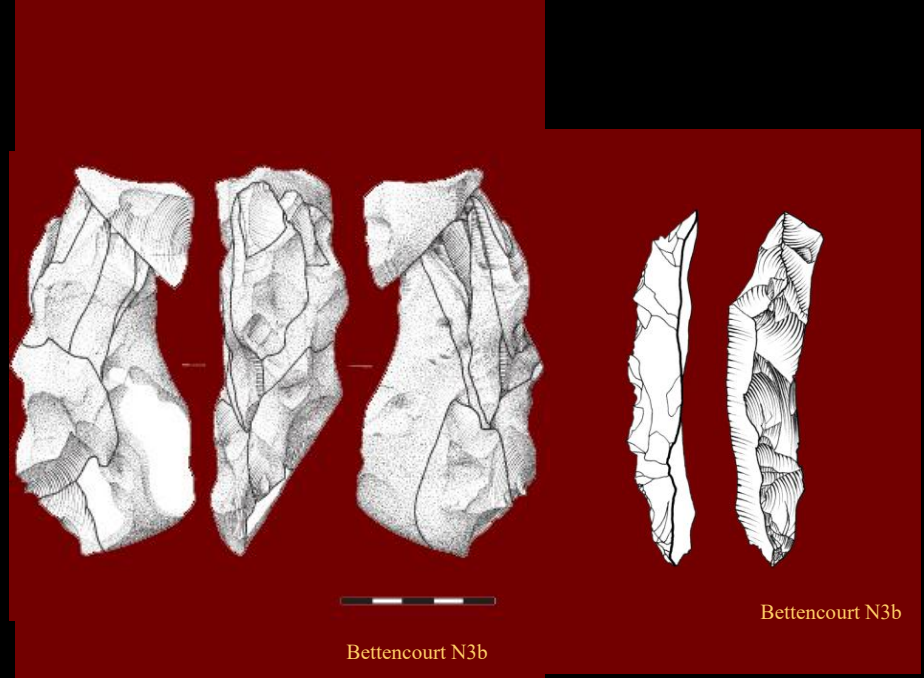
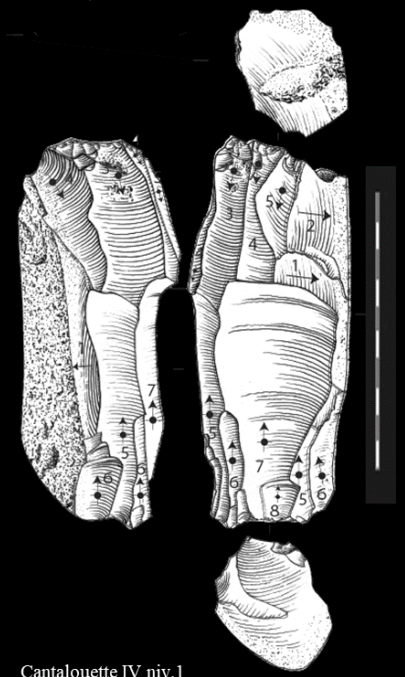
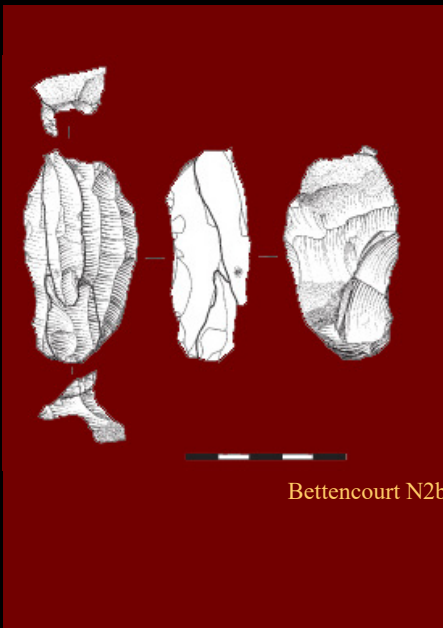

# Blade debitage

Cantalouette IV  
 La Mouline  
 Tamniès  
 Fresnoy-au-Val  
 Bettencourt-Saint-Ouen N2b  
 Fitz-James  
 Bettencourt-Saint-Ouen N3b  
 Vallée de la Vanne  
 Garris 2  
 Cantalouette IV niv.1

Gestion du débitage					
production			évolution du débitage		
unipolaire		"bipolaire" parallèle	tournant	semi- tournant	frontal
parallèle	convergent				
		■	■	■	
		■		■	
■		■	■	■	
■		■	■	■	
■		■		■	
■		■		■	
	■				■
	■				■

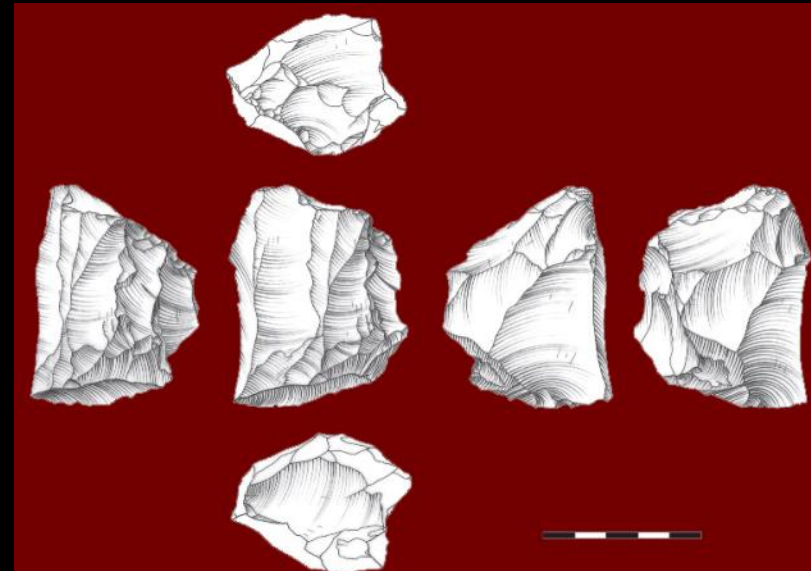
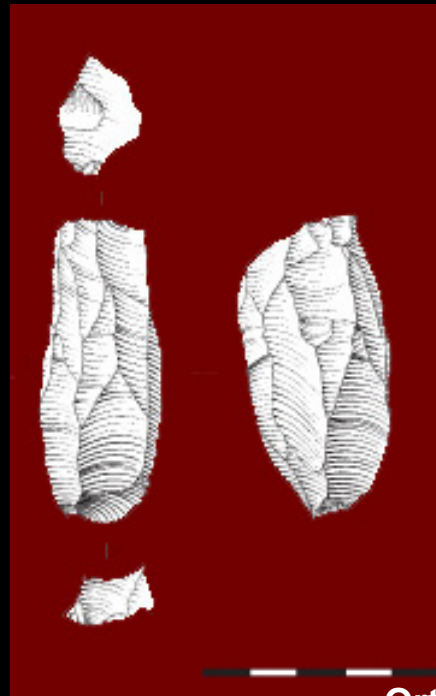
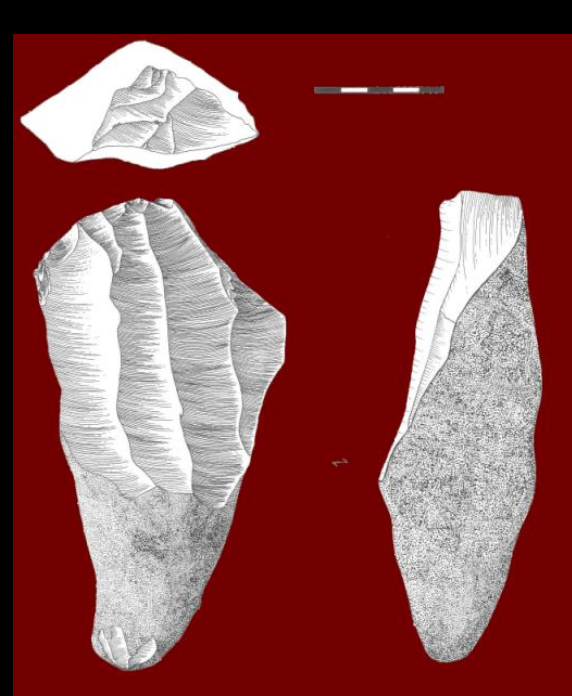

# Blade debitage

## réaménagement

convexités latérales/carénage

convexité distale/cintrage

néo-crêtes

produits de flancs

néo-crêtes

plan de frappe opposé

Cantalouette IV  
 La Mouline  
 Tamniès  
 Fresnoy-au-Val  
 Bettencourt-Saint-Ouen N2b  
 Fitz-James  
 Bettencourt-Saint-Ouen N3b  
 Vallée de la Vanne  
 Garris 2  
 Cantalouette IV niv.1

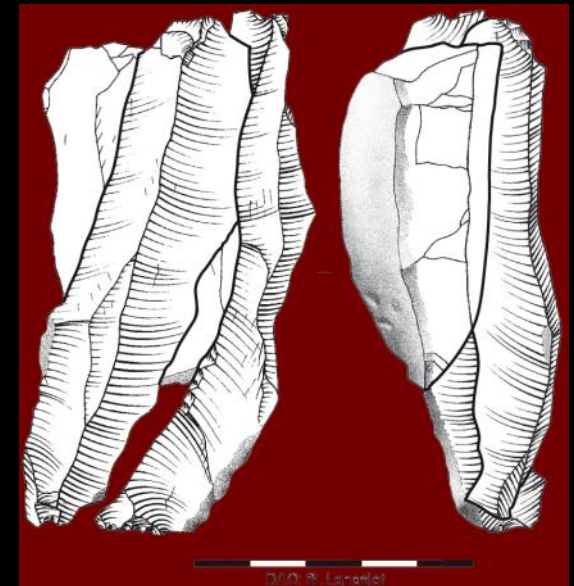
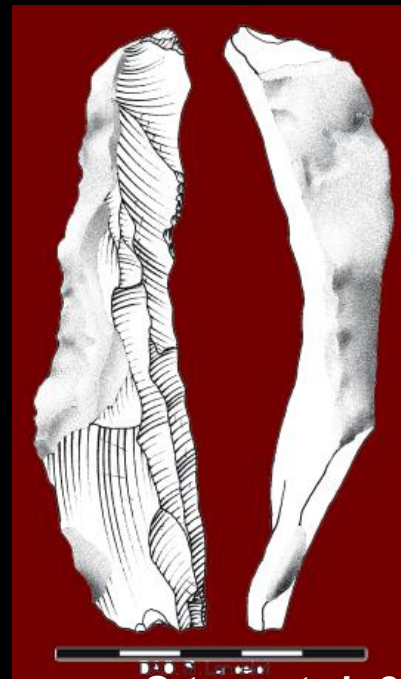
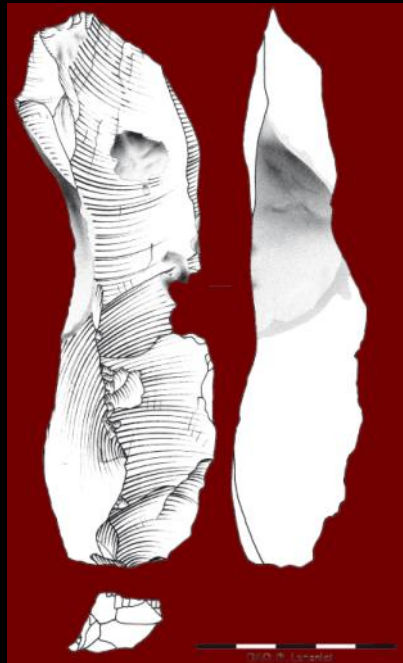
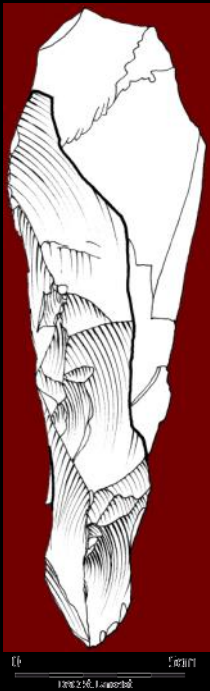
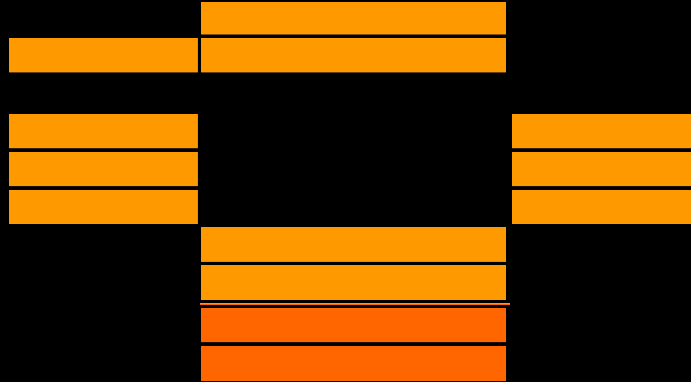

# Blade debitage

Plan de frappe et procede de preparation							
plans de frappe			du point de percussion			autres préparations (angle de chasse)	
plan lisse	éclats de ravivage	tablettes	talon facetté	talon facetté oblique	éperons	abrasion corniche	repise des nervures
Cantalouette IV							
La Mouline			?				
Tamniès							
Fresnoy-au-Val							
Bettencourt-Saint-Ouen N2b							
Fitz-James							
Bettencourt-Saint-Ouen N3b							
Garris 2							
Cantalouette IV niv.1			?				

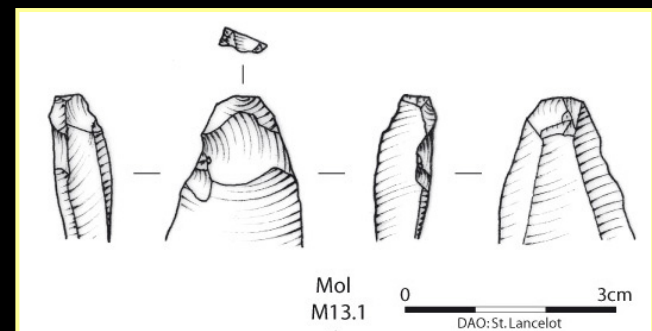
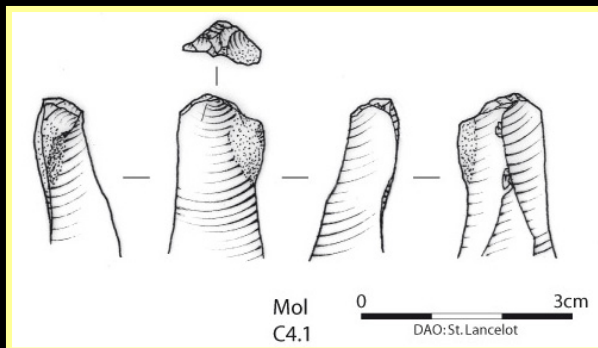
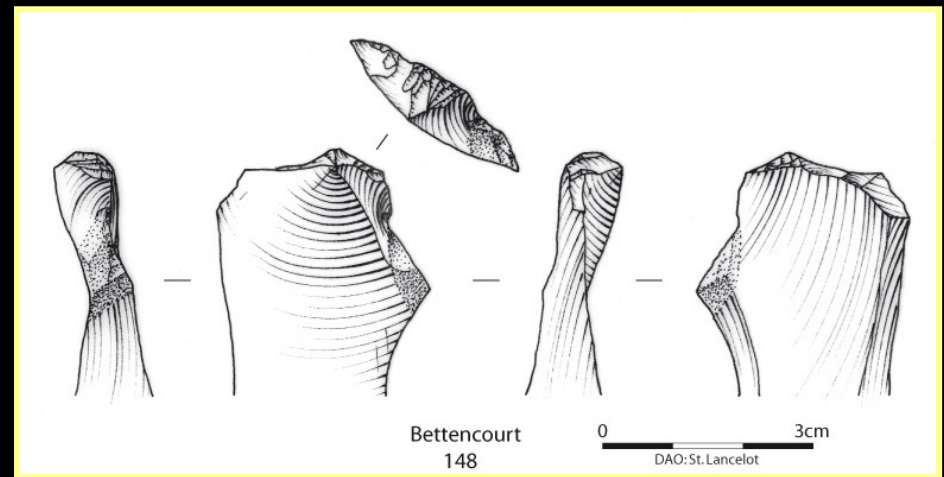
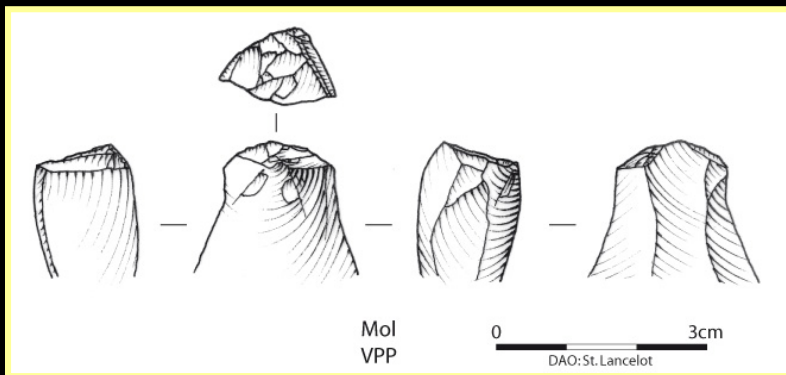



# Blade débitage

	Plan de frappe et procede de preparation							
	plans de frappe			du point de percussion			autres préparations (angle de chasse)	
	plan lisse	éclats de ravivage	tablettes	talon facetté	talon facetté oblique	éperons	abrasion corniche	repise des nervures
Cantalouette IV								
La Mouline				?				
Tamniès								
Fresnoy-au-Val								
Bettencourt-Saint-Ouen N2b								
Fitz-James								
Bettencourt-Saint-Ouen N3b								
Garris 2								
Cantalouette IV niv.1				?				

Point de contact recherché par le tailleur

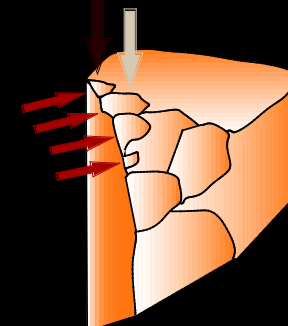

D'après L. Klaric 2003

Ajout d'un facettage latéralisé oblique  
 Pour déplacer le futur point de contact  
 Vers le centre de la table et/ou  
 Renforcer la zone d'impact

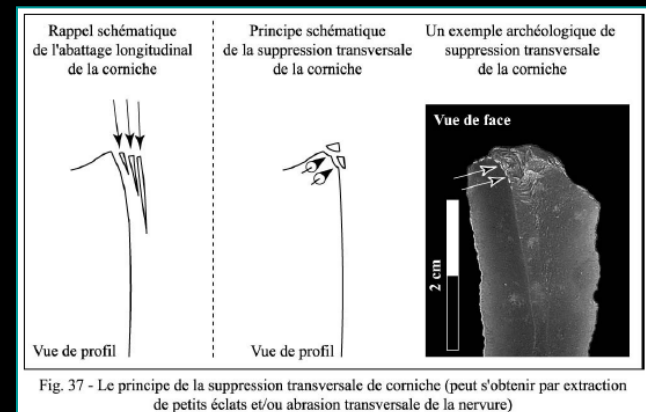
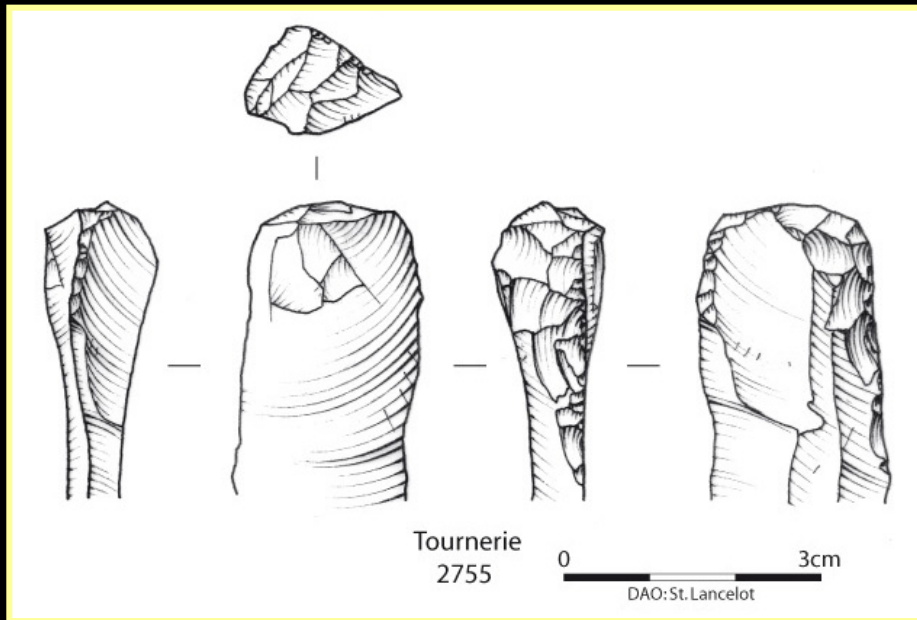

Fig. 37 - Le principe de la suppression transversale de corniche (peut s'obtenir par extraction de petits éclats et/ou abrasion transversale de la nervure)

L. Klaric 2003

# Blade débitage

- Principales caractéristiques morphologiques des produits laminaires

	produits laminaires						
	rectiligne	courbe	bords parallèles	bords convergents	parallélo-convergent	nervures parallèles	nervures irreg
Cantalouette IV							
La Mouline							
Tamniès							
Fresnoy-au-Val							
Bettencourt-Saint-Ouen N2b							
Fitz-James							
Bettencourt-Saint-Ouen N3b							
Garris 2							
Cantalouette IV niv.1							

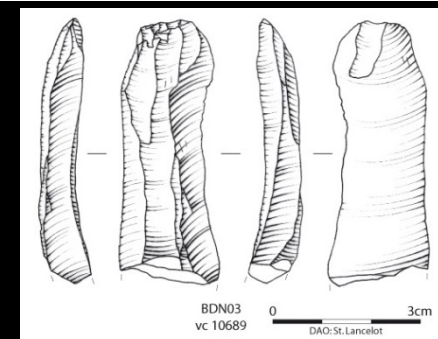
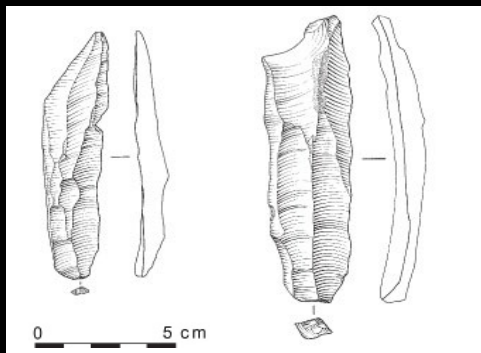
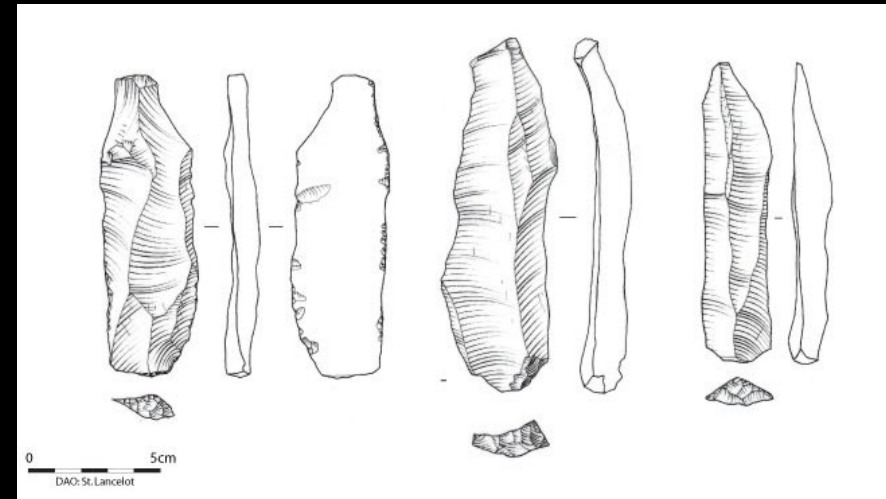
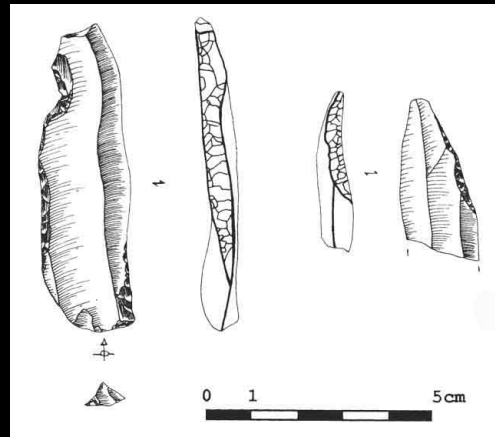
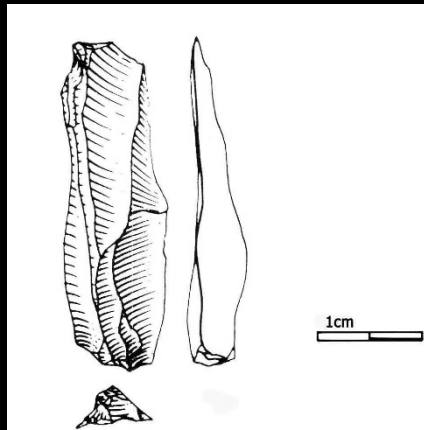

*Phénomène de réduction de  
la chaîne opératoire  
laminaire  
(série C 12)*





*Phénomène de réduction de  
la chaîne opératoire  
laminaire  
(échantillon de la série C)*



**Quina debitage**

# Quina debitage

Chapter 17

## QUINA PROCUREMENT AND TOOL PRODUCTION

Peter Hiscock<sup>1</sup>, Alain Turq<sup>2</sup>, Jean-Philippe Faivre<sup>3</sup>, and  
Laurence Bourguignon<sup>4</sup>

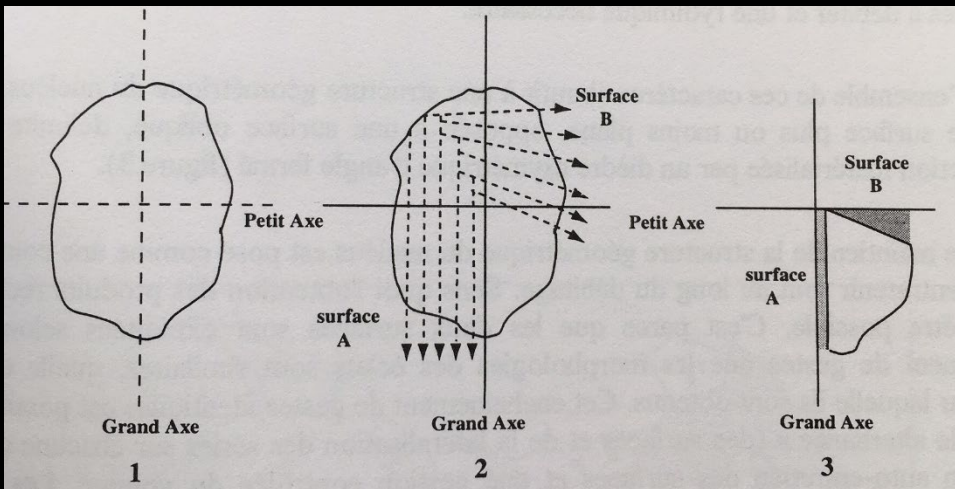
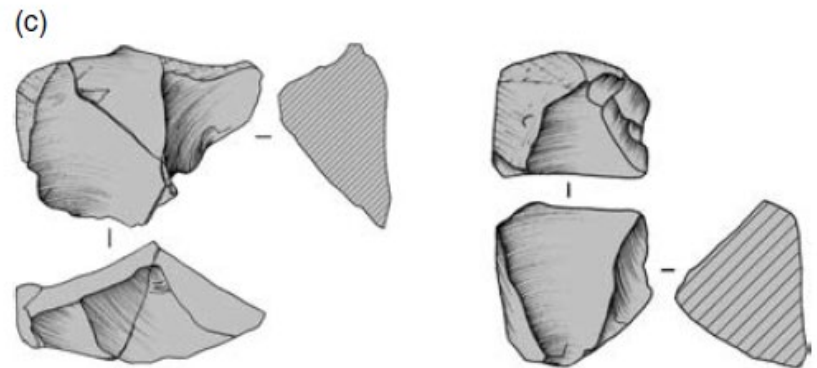
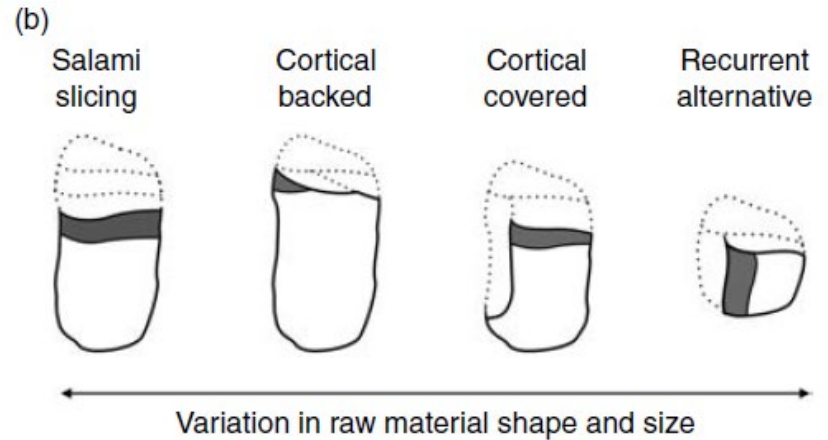
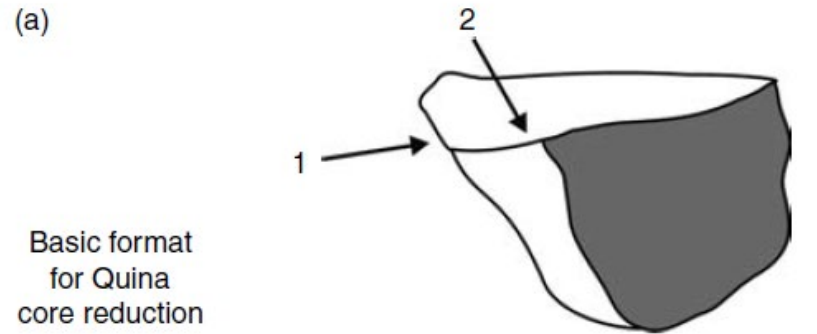
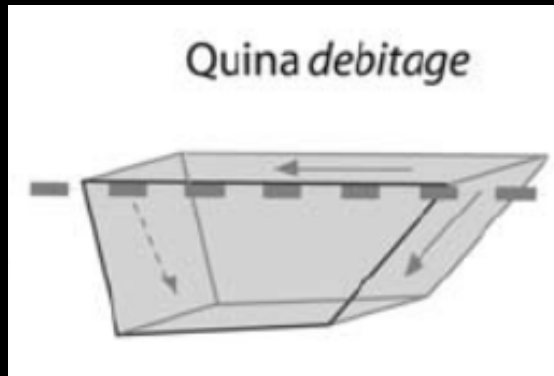

# Quina debitage

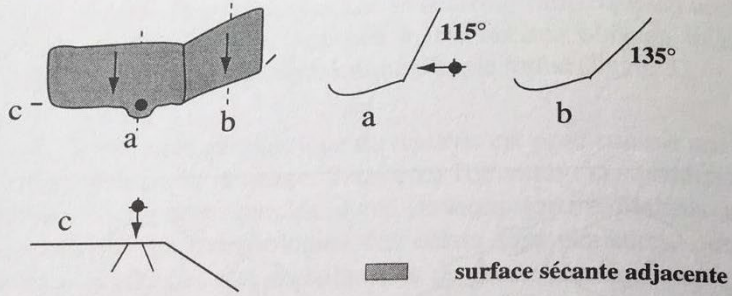

surface A

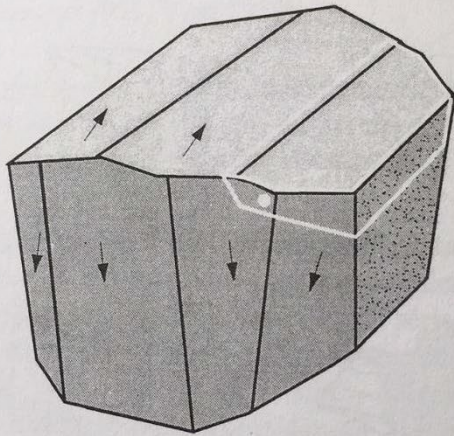

surface B

Axe de percussion     
  Point de percussion

Direction des enlèvements antérieurs

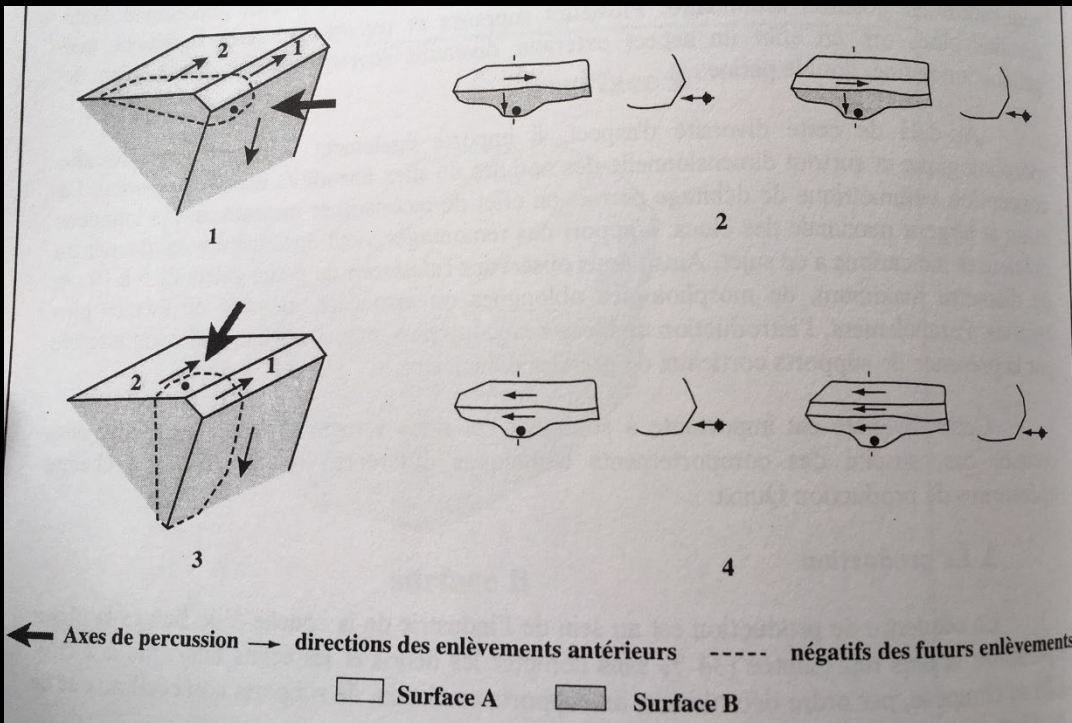
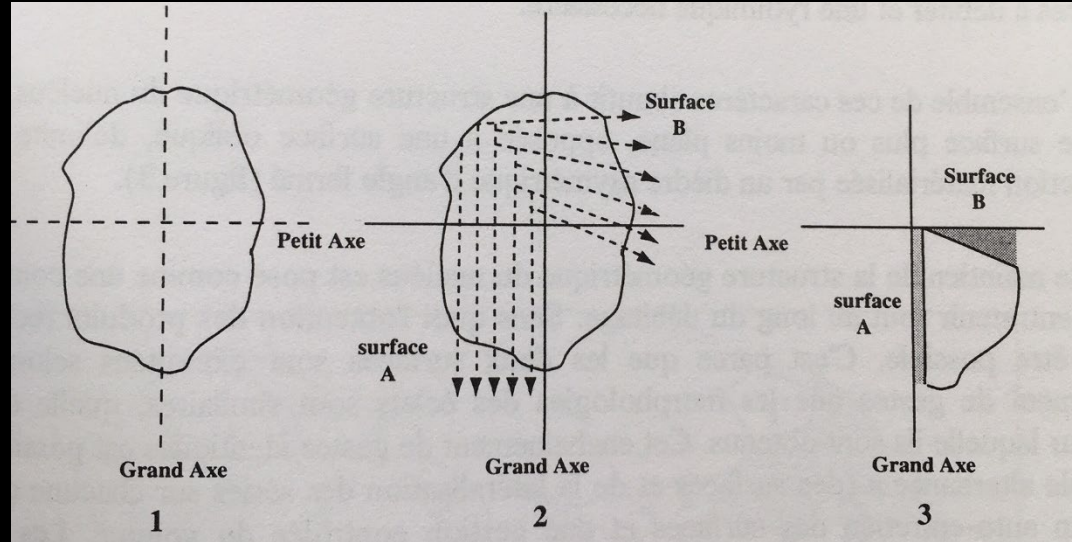

# Quina debitage

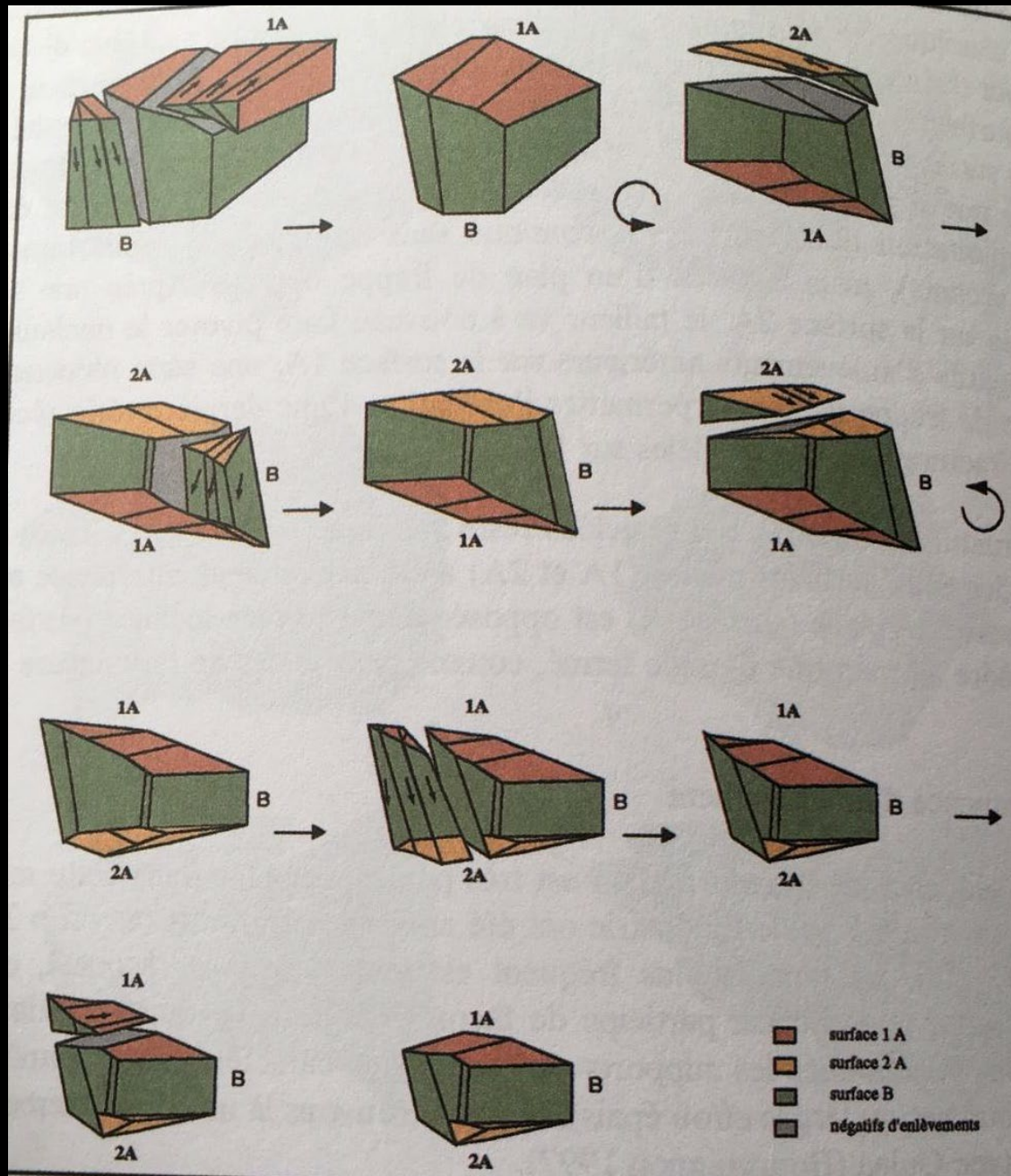



**Figure 17.3** Examples of Quina flake selection and retouching from Combe Grenal (layers 17 and 20). Arrows show the sequence of reduction. (a) Unretouched flakes removed from cores, (b) Similar flakes with retouching, (c) Smaller flakes struck from retouched flakes of the kind portrayed in b, and (d) Small flakes from c that have subsequently been retouched. (Drawings by Jean-Philippe Faivre.)

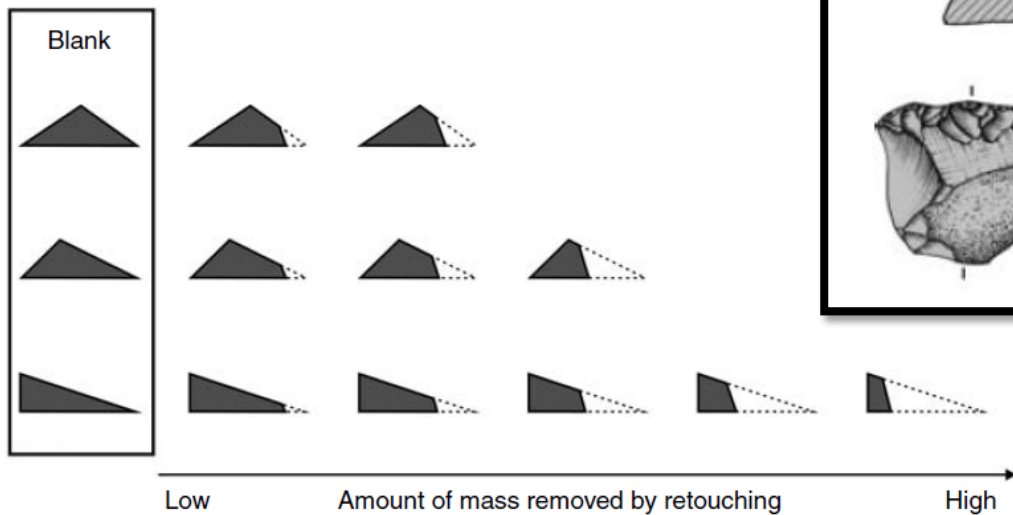
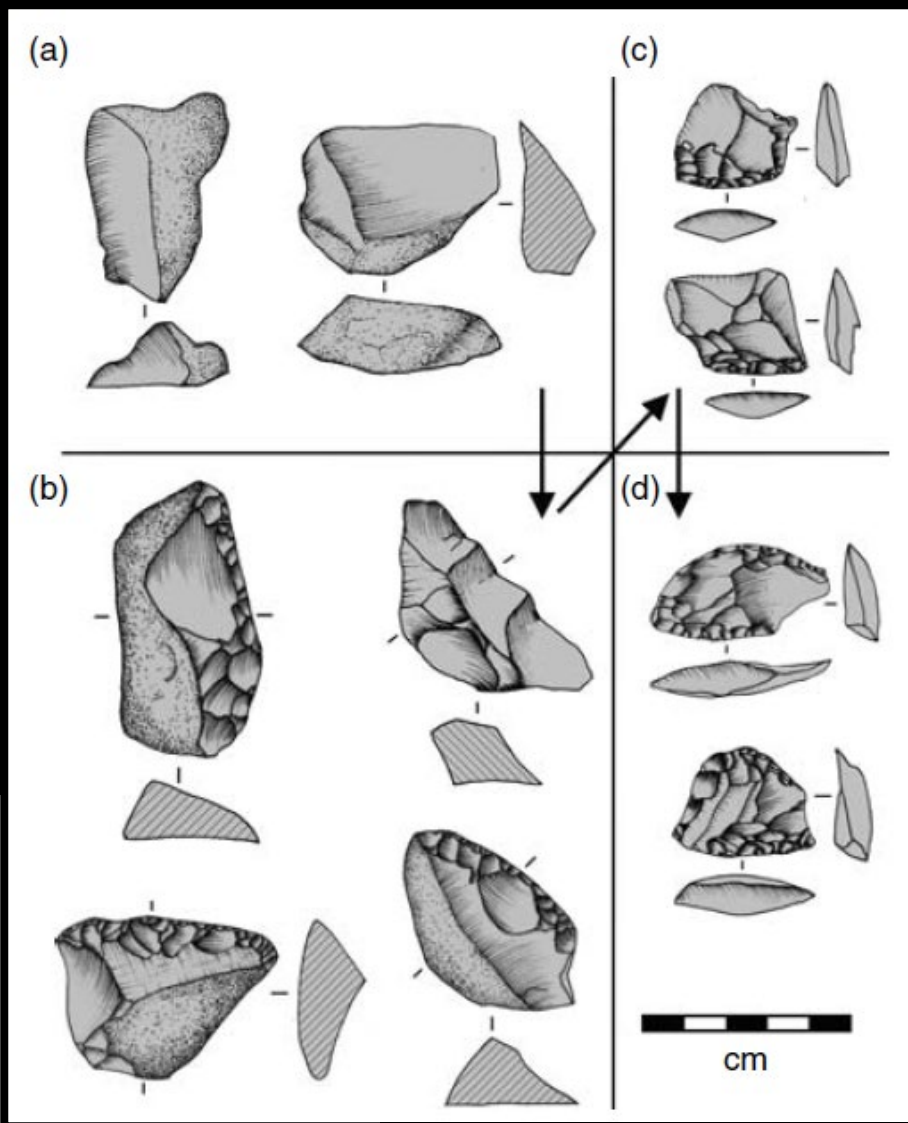

**Figure 17.6** Notional illustration of the relationship of blank cross-section and extent of reduction for dorsally retouched Quina scrapers (after Turq 1992: Figure 6.2).

# Saint-Amand-les-Eaux

MIS 3 – 49 ka  
Ph. Feray dir.



# MIS 4/3 : 70-45 ka

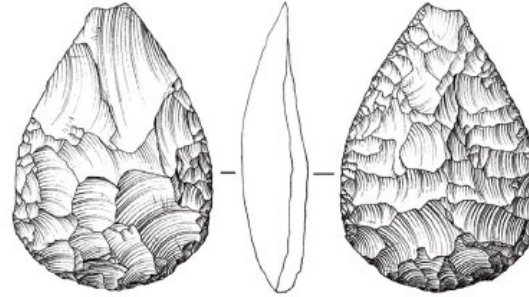

Ploisy N1

0 5 cm  
D.A.O. : S. Lancelot

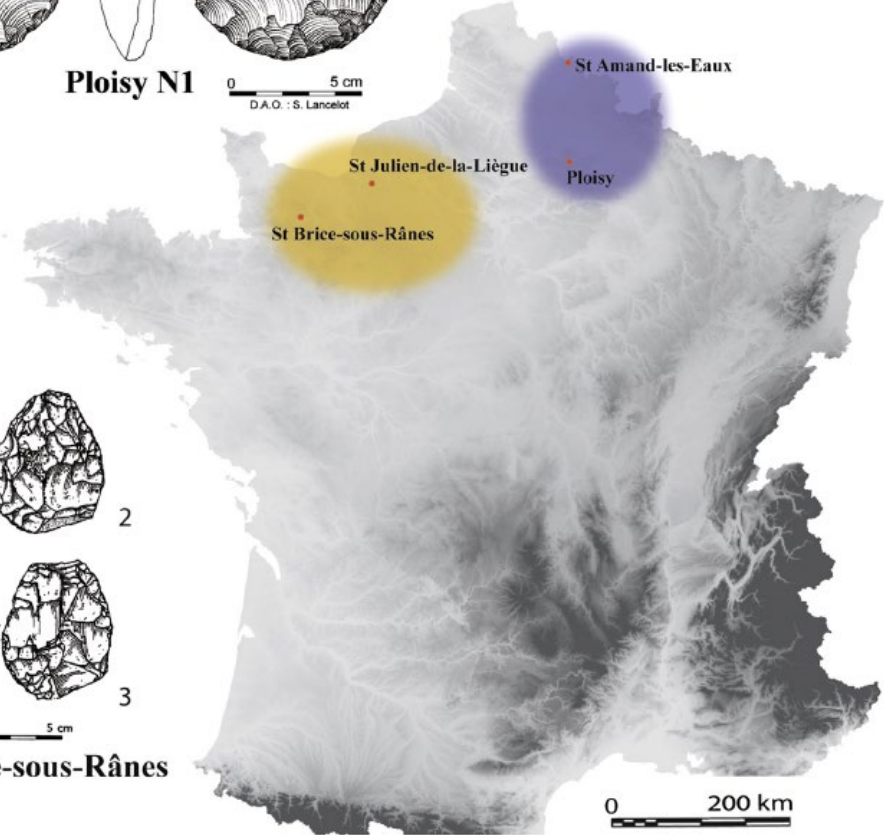

Saint-Brice-sous-Rânes



Mousterien of Acheulean tradition



Final Mousterian with bifaces

Locht et al., 2017 *QI*.



**Unknown or rare  
Middle Palaeolithic  
Lithic Technologies**

**Des lames sans laminaire... Le débitage Pyramidal sur le site paléolithique moyen de la Garenne à Saint-Firmin-des-Prés (Loir-et-Cher)**

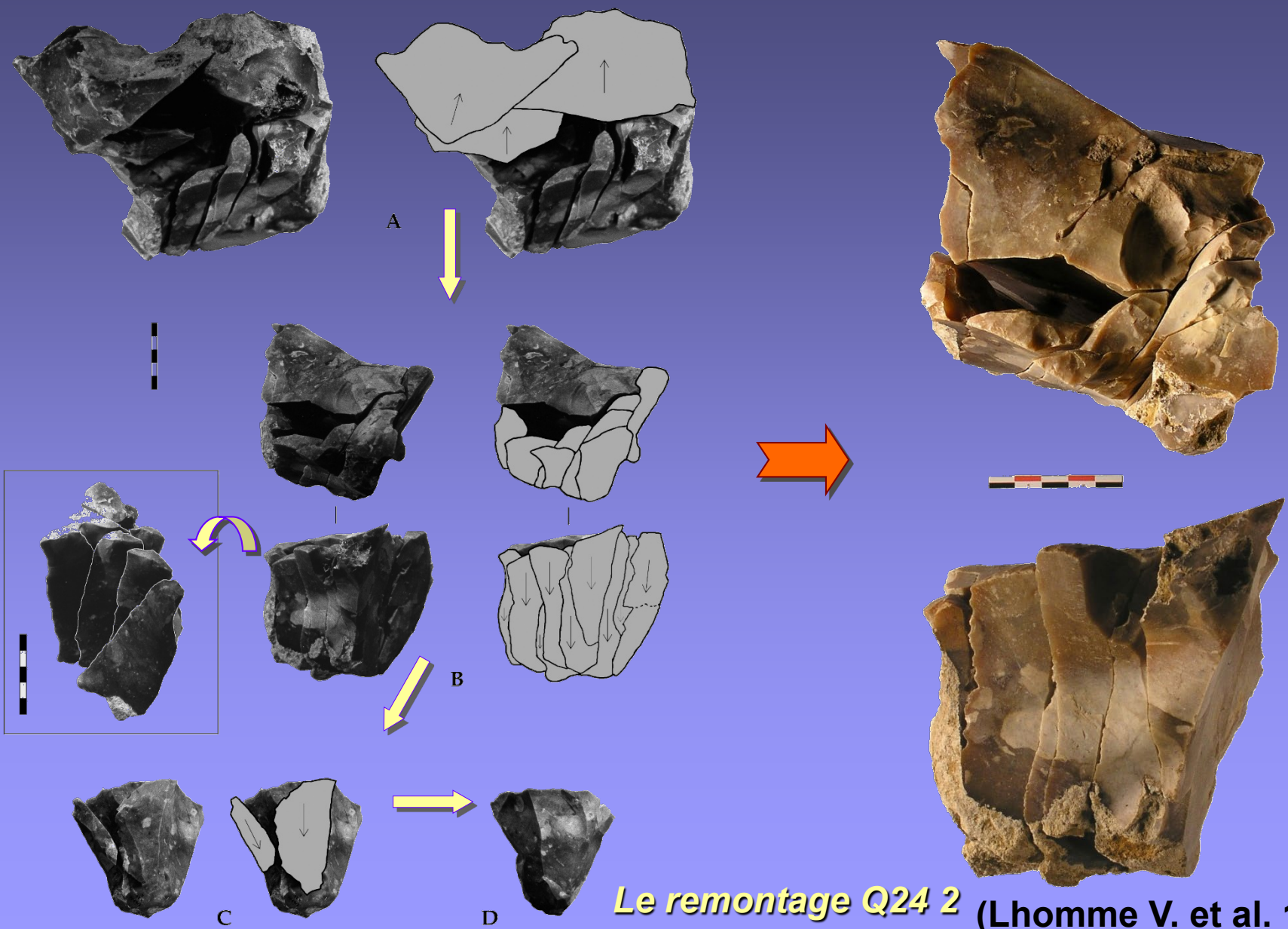

**Le remontage Q24 2 (Lhomme V. et al. 1999)**

**Des lames sans laminaire... Le débitage Pyramidal sur le site paléolithique moyen de la Garenne à Saint-Firmin-des-Prés (Loir-et-Cher)**

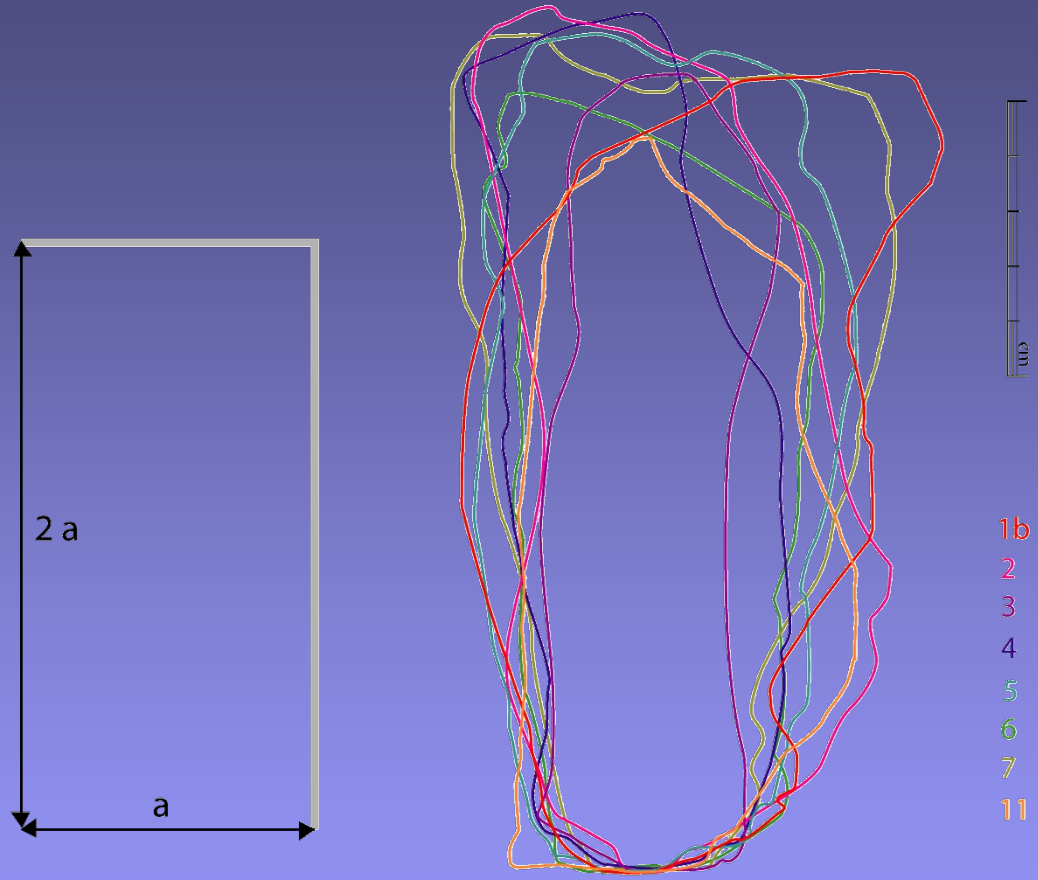

- 1b
- 2
- 3
- 4
- 5
- 6
- 7
- 11

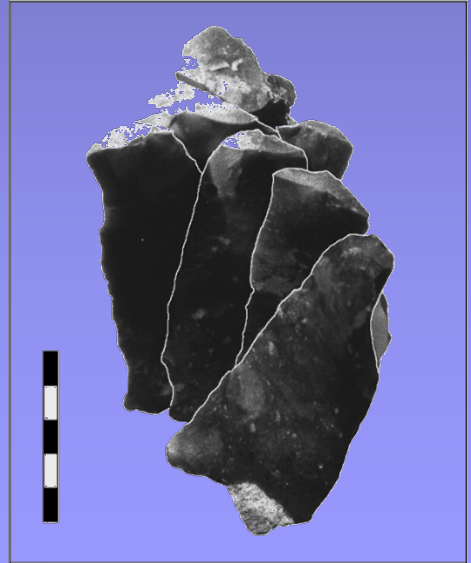
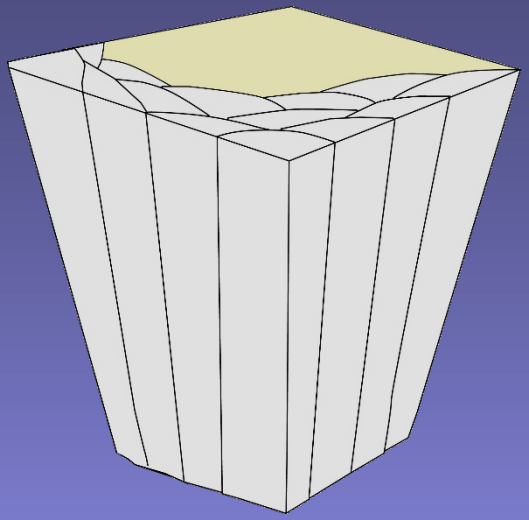

**Production du nucléus Q24 2**

# Pyramidal debitage

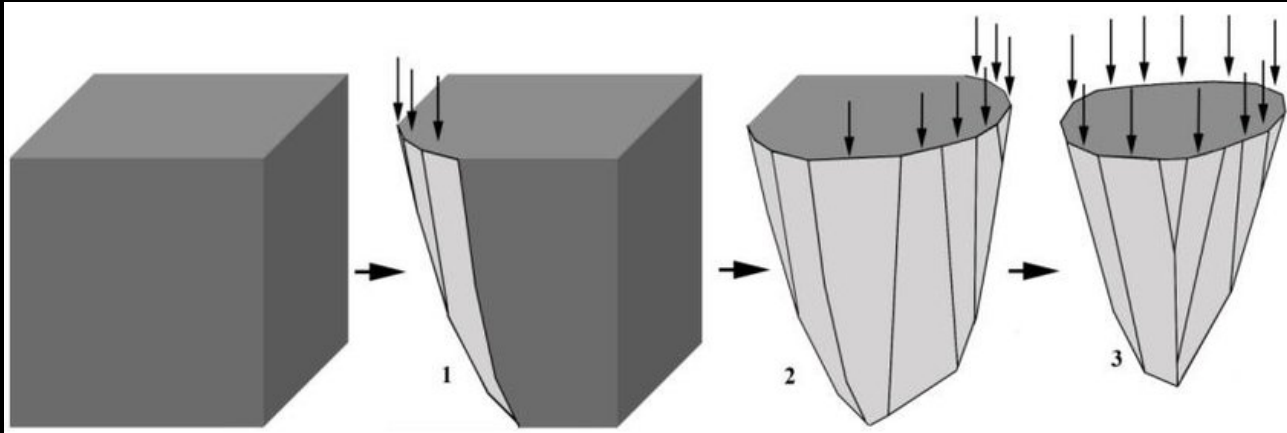

Nucléus pyramidal avec son potentiel d'évolution 1 quart pyramidal, 2 semi-pyramidal, 3 pyramidal en fin de potentiel

*Boker Tachtit*

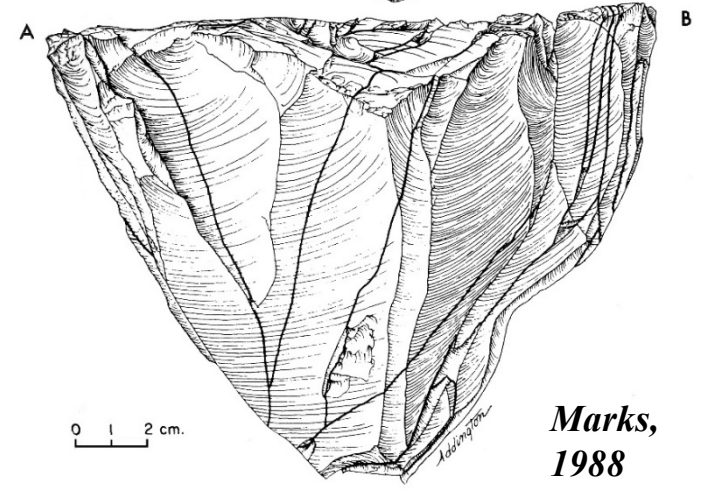
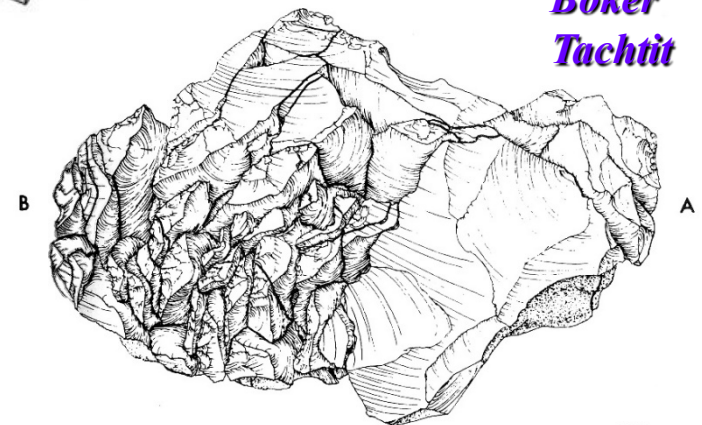

*Marks, 1988*

# The Villiers-Adam case

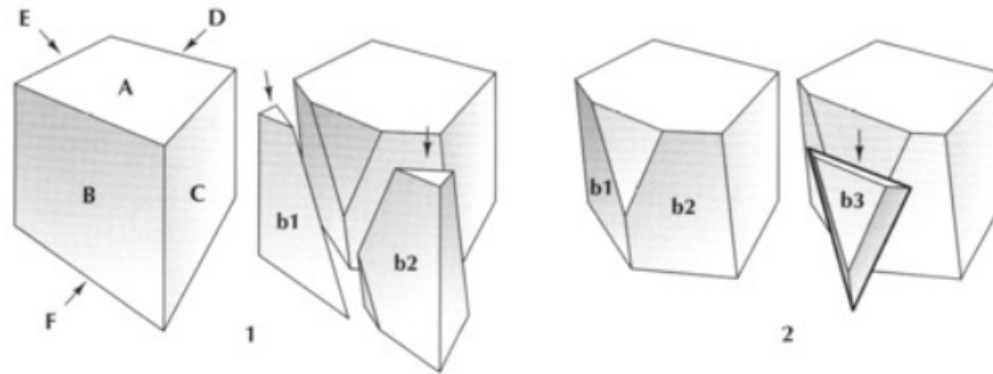

Fig. 48 – Débitage unipolaire convergent simple sur une surface (dessin P. Raymond).

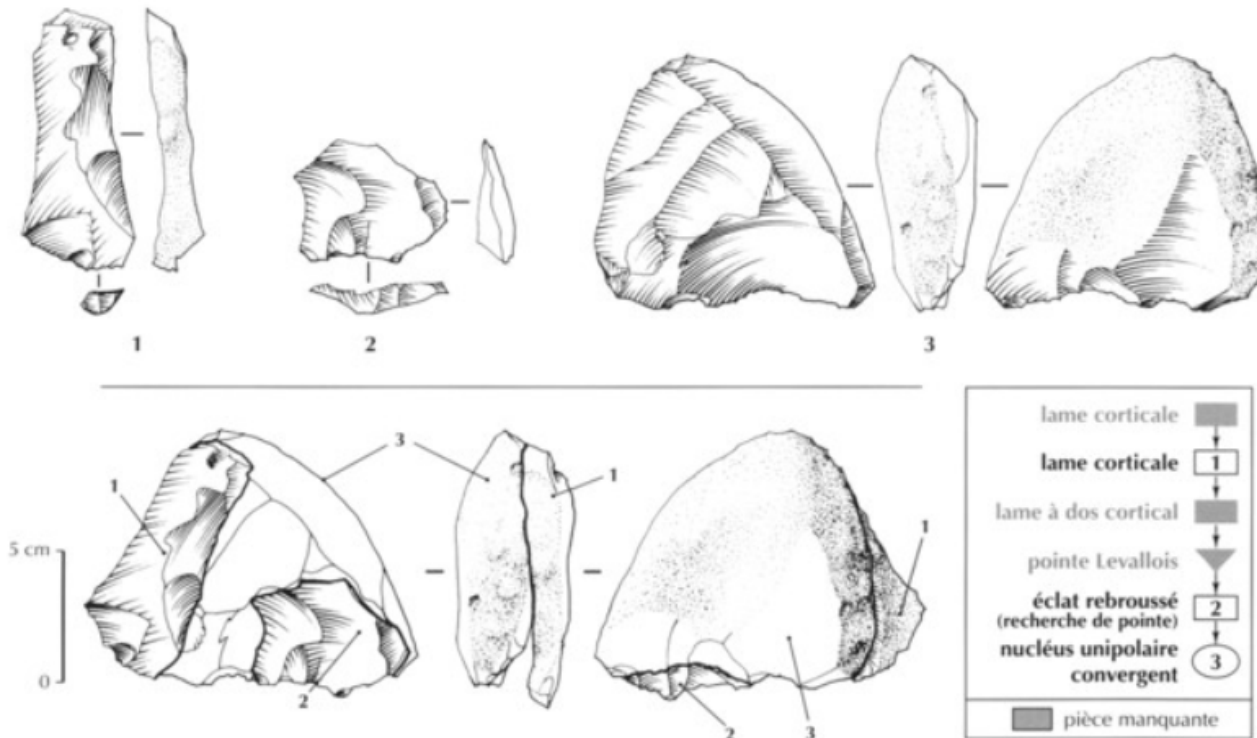

Fig. 49 – Remontage II (dessin P. Raymond).



# The Villiers-Adam case

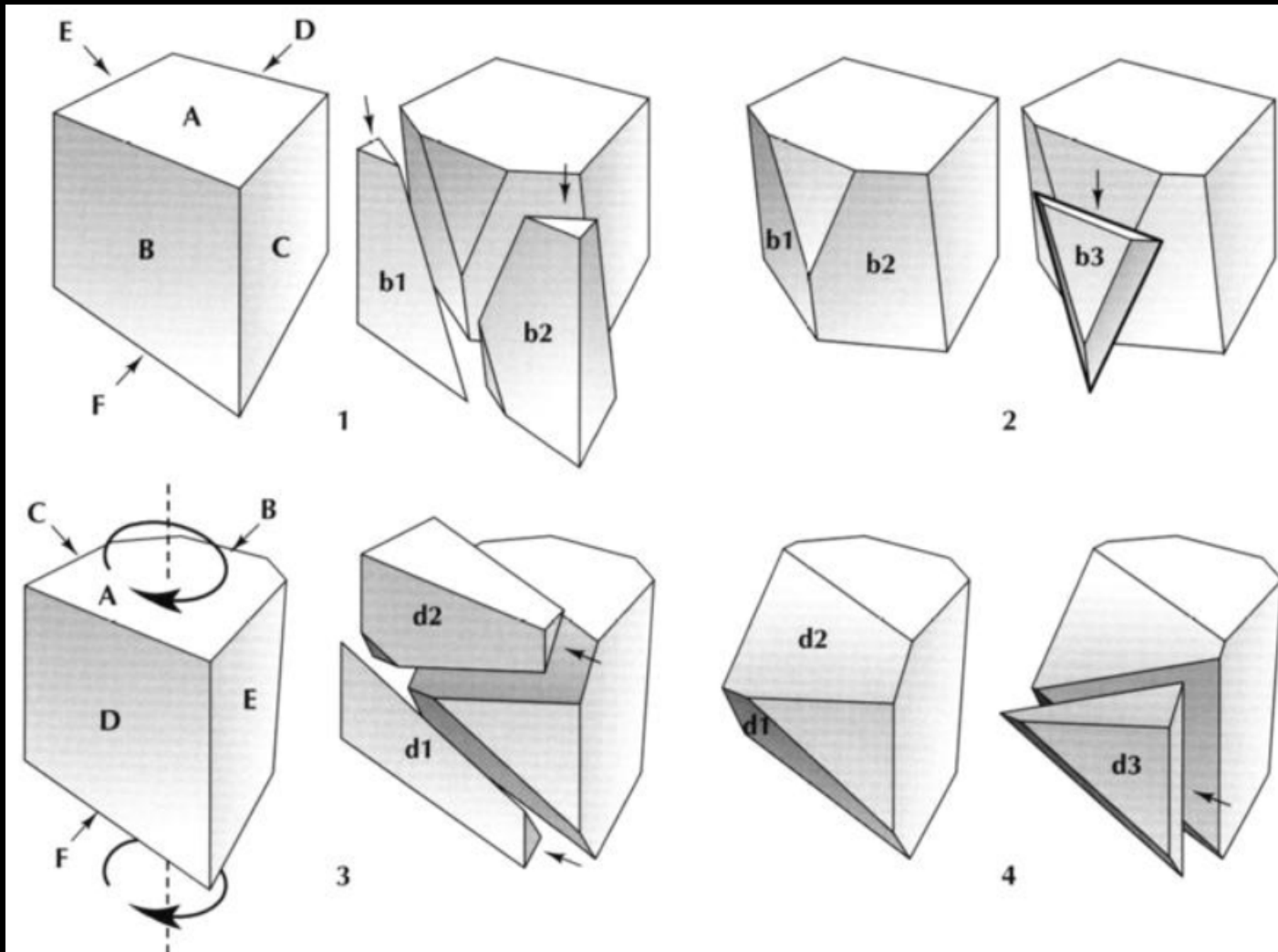

Fig. 54 – Débitage unipolaire convergent : schéma d'un bloc à deux surfaces s'inscrivant dans des plans parallèles (dessin P. Raymond).

# The Villiers-Adam case

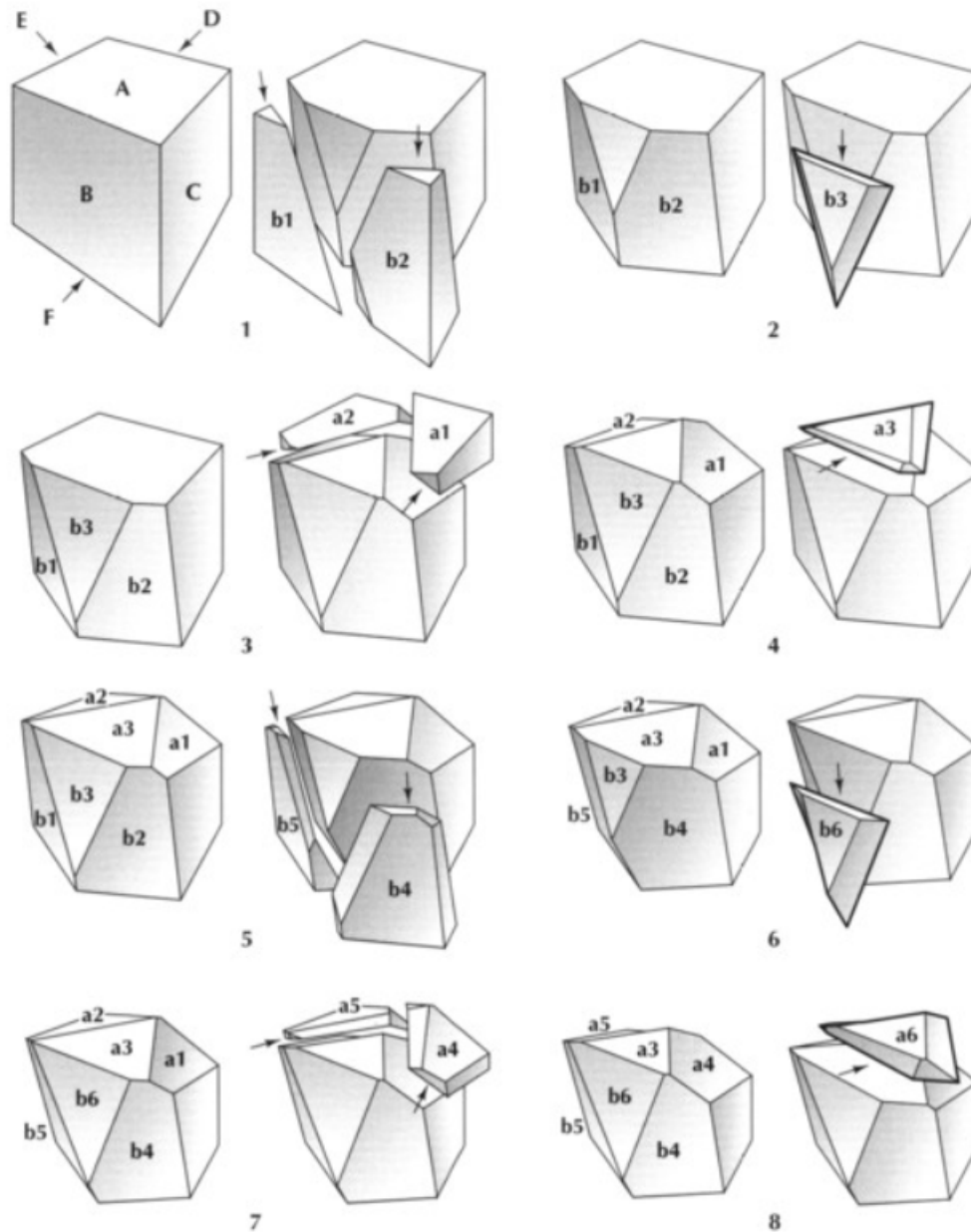

Fig. 57 – Débitage unipolaire convergent : schéma d'un bloc à deux surfaces perpendiculaires ou sécantes exploitées de façon alternative (dessin P. Raymond).

# The Villiers-Adam case

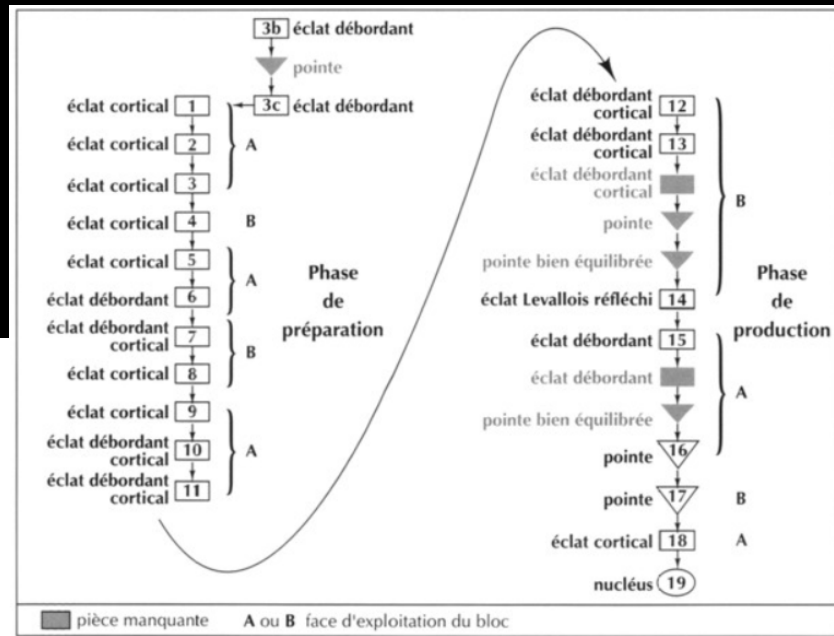
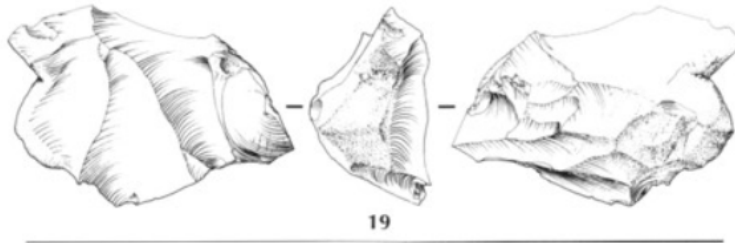
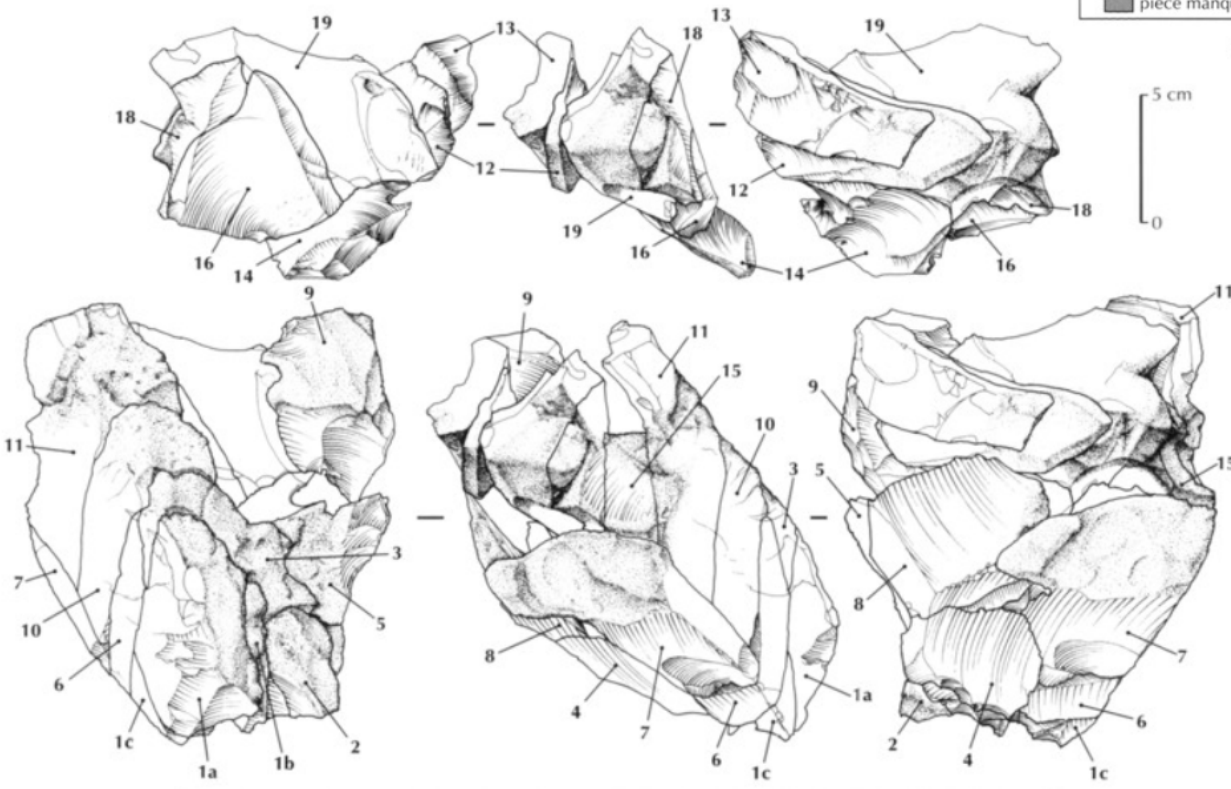

Fig. 59 – Remontage de l'ensemble 5 (dessin P. Raymond).





# Production organisation

# Production organisation

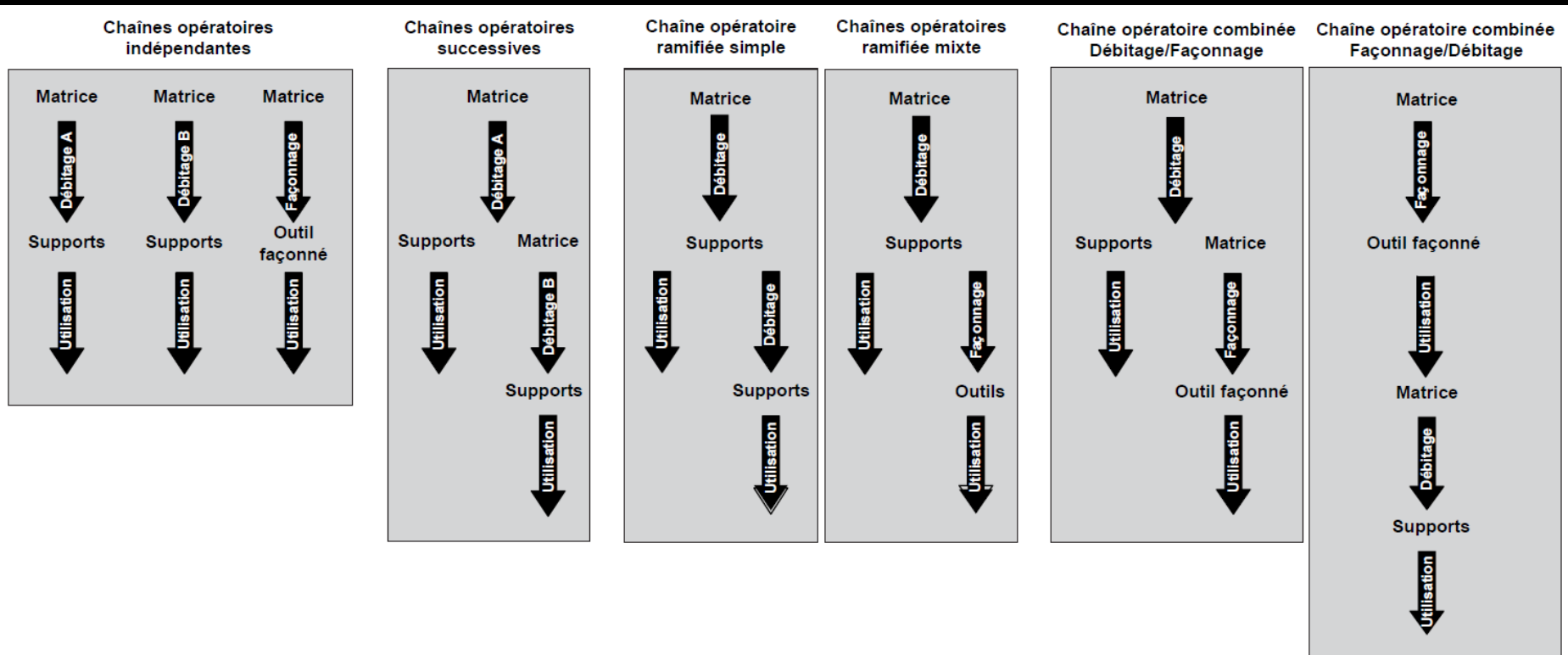
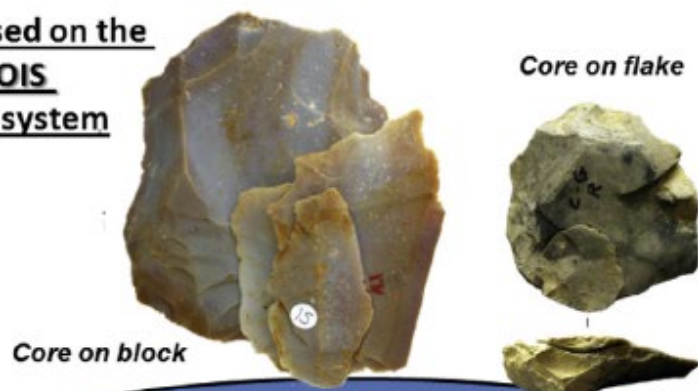

Figure 8 : Schémas synthétiques des principaux cas de figure d'indépendance, de succession ou de combinaison entre chaînes opératoires de débitage et de façonnage.

**TCL based on the LEVALLOIS flaking system**



« Core reduction sequences »

End-products with a wide range of determined functional characters

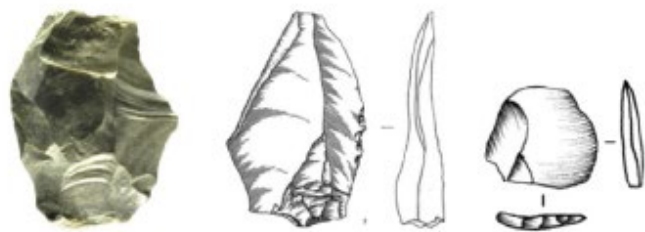

A wide range of retouched tools

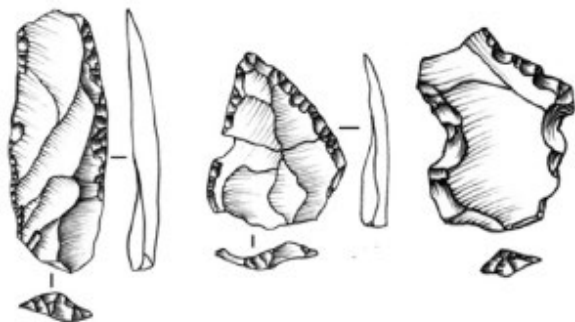

**Core on block**



**TCL based on the CHORDAL DISCOID flaking system**

« Core reduction sequences »

End-products with the same determined functional aspects

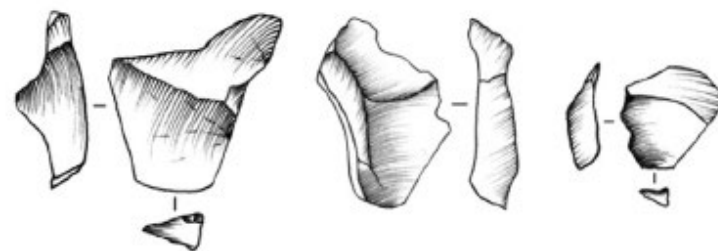

Few and poorly diversified retouched tools

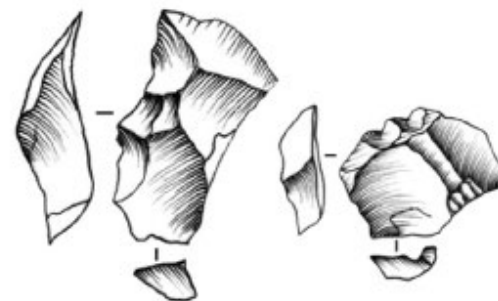

**TCL based on  
the QUINA  
flaking system**

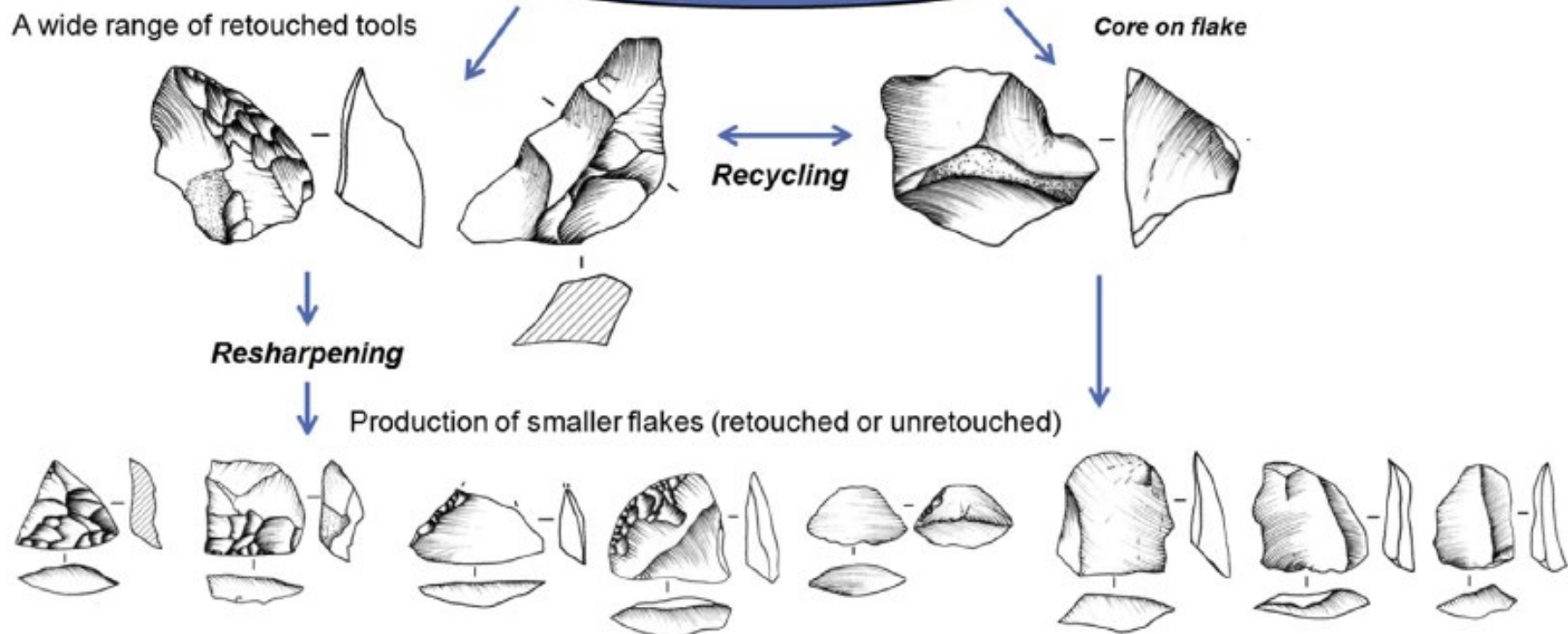
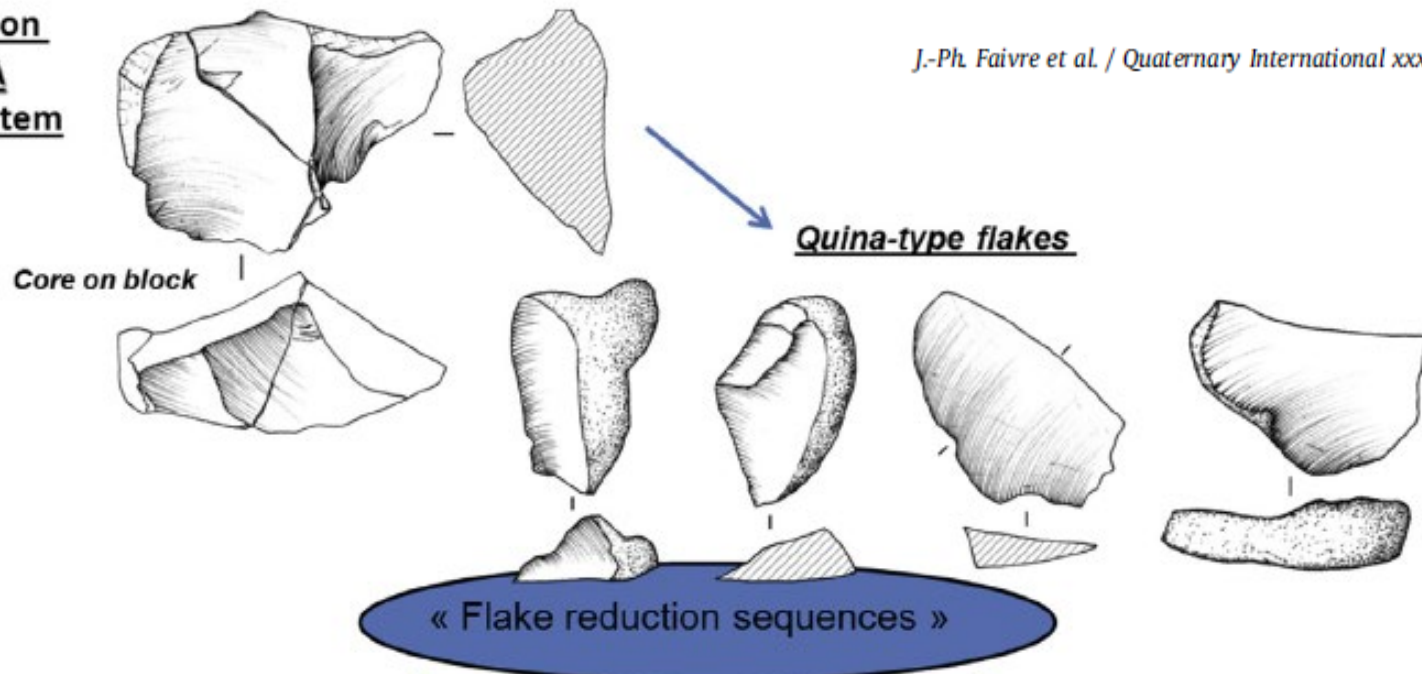



# Secondary production

## Champ Bossuet

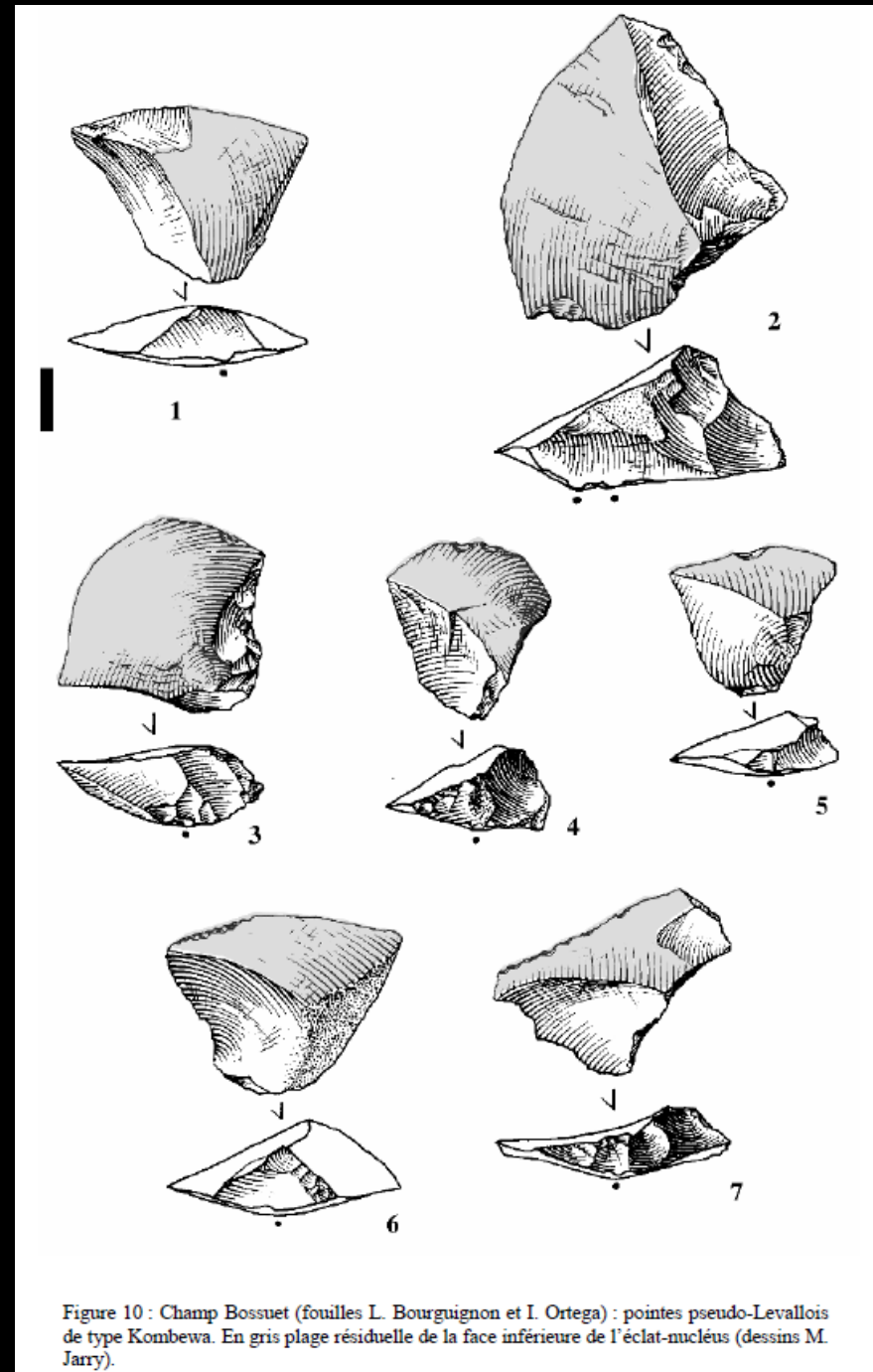
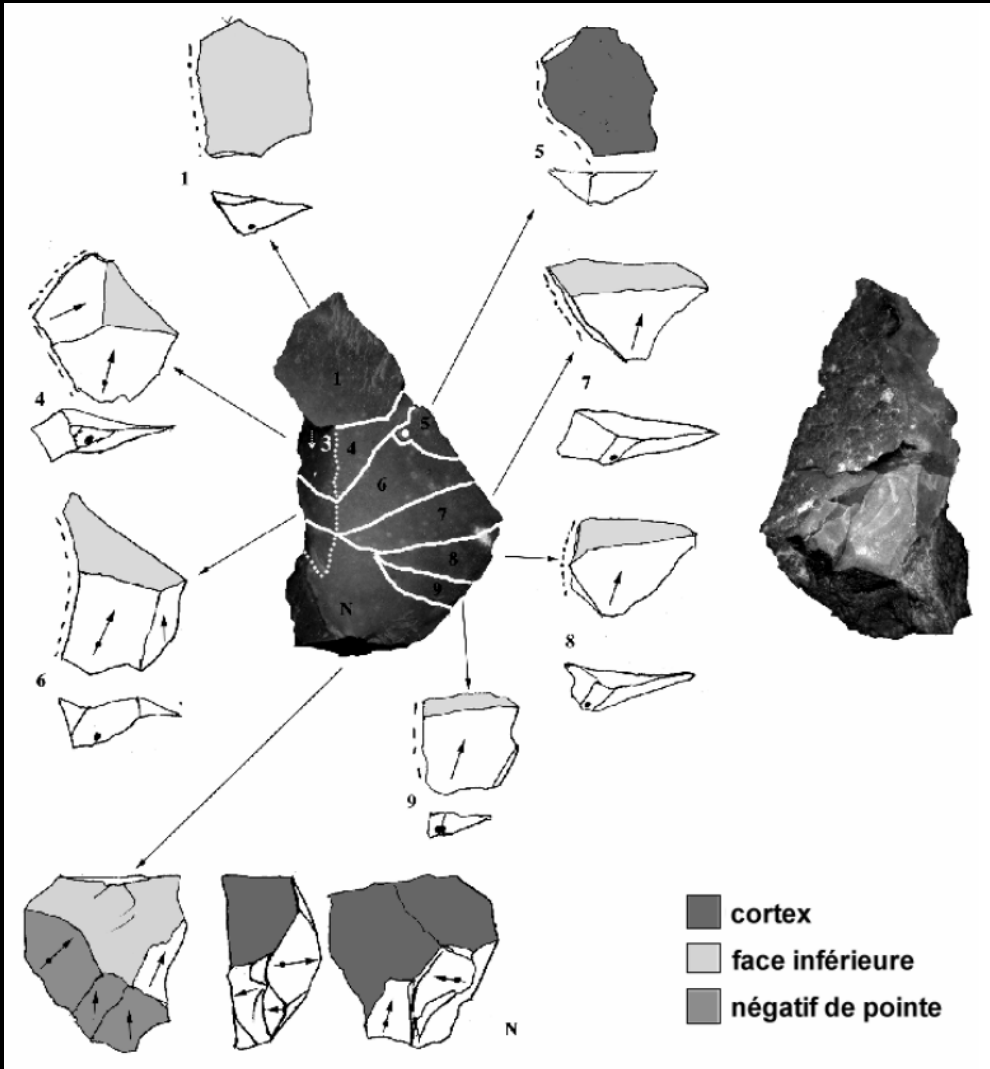
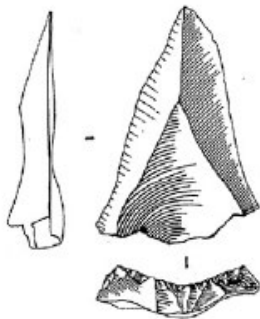

Figure 10 : Champ Bossuet (fouilles L. Bourguignon et I. Ortega) : pointes pseudo-Levallois de type Kombewa. En gris plage résiduelle de la face inférieure de l'éclat-nucléus (dessins M. Jarry).

# Production organisation Le Pucheuil

Primary production



1



by-products recycling

secondary productions



2



3

# Secondary production Le Pucheuil

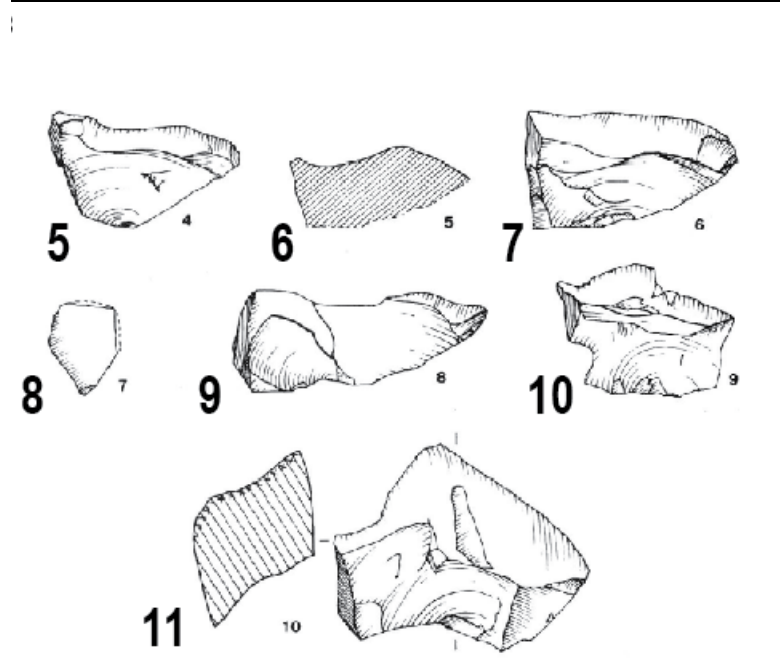
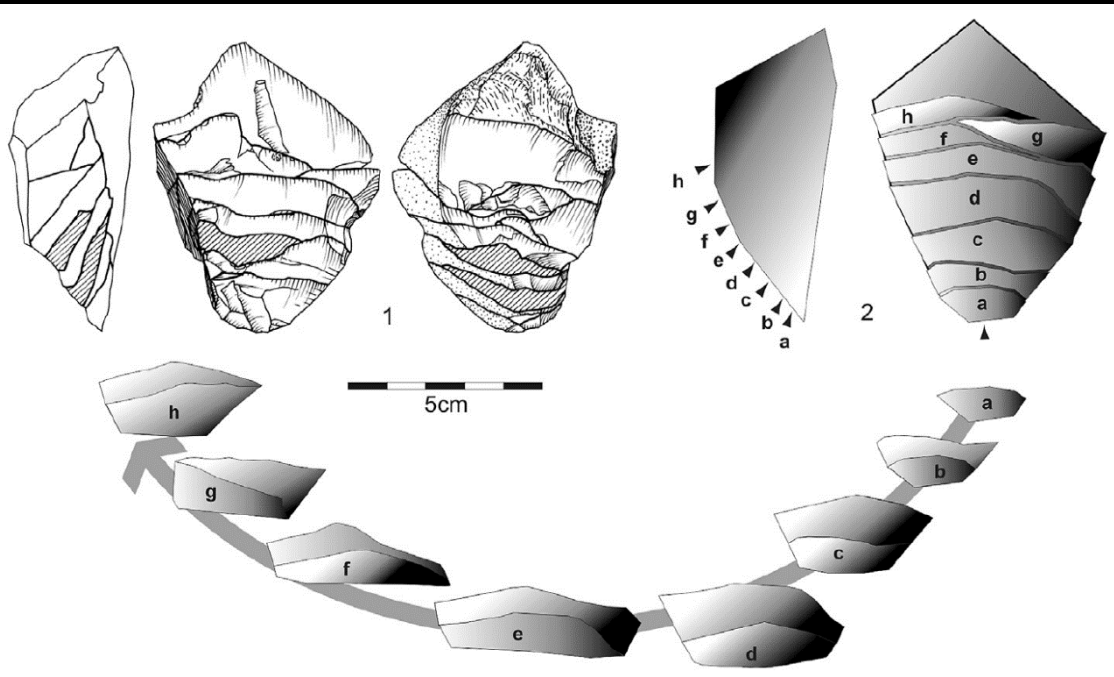
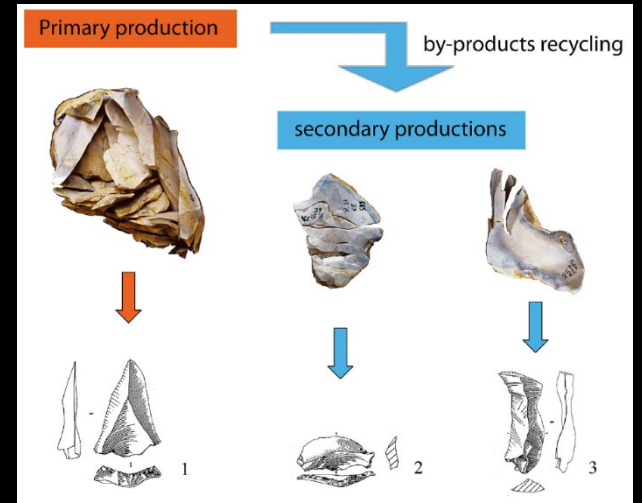

# Secondary production

Lazuén,  
Delagnes  
2014  
JAS

Pucheuil série B

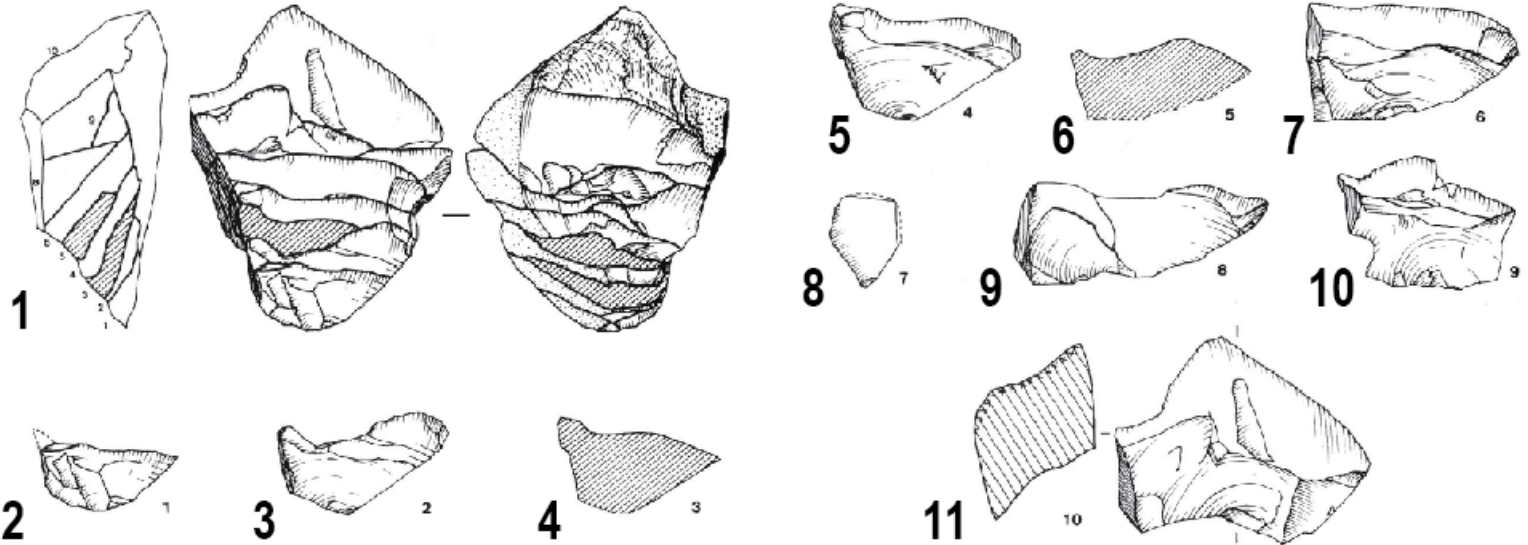

## Therdonne N3

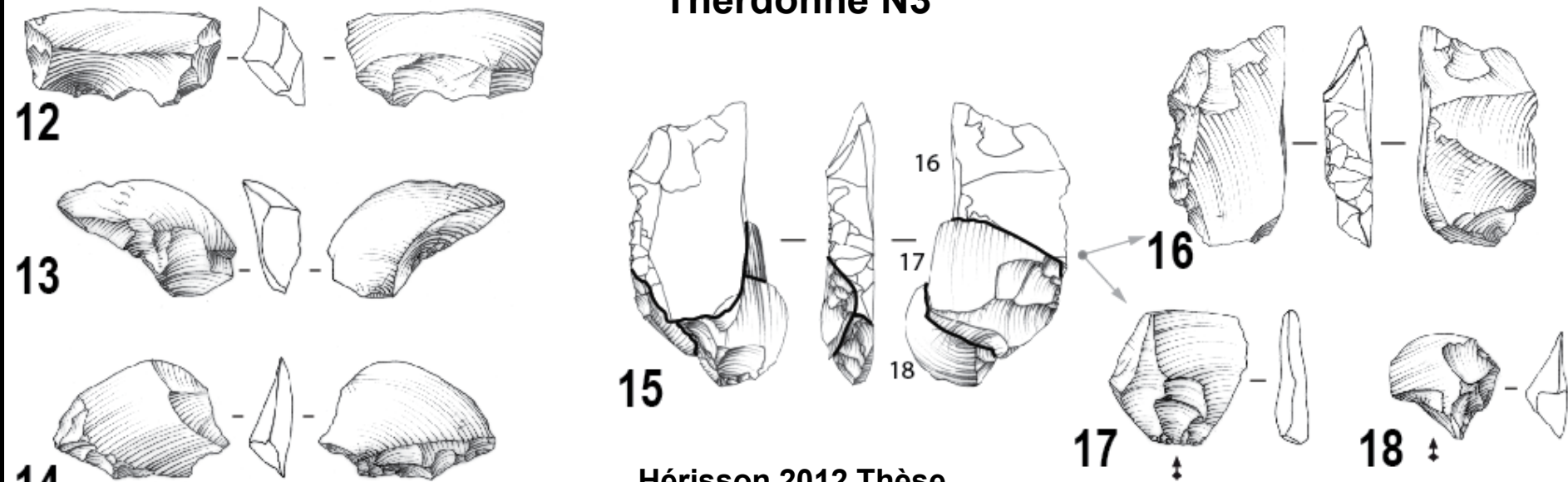

Hérisson 2012 Thèse

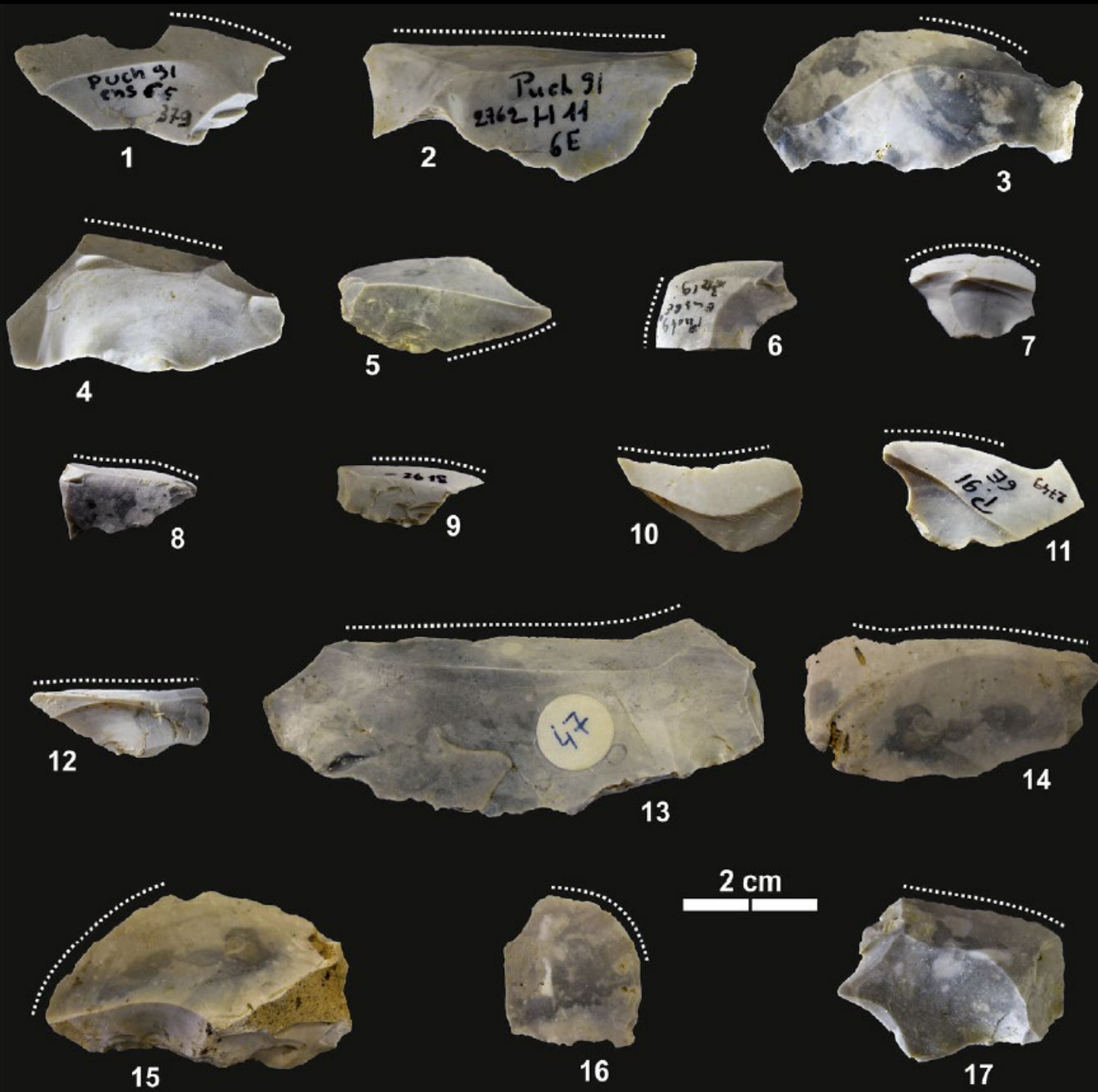

Lazuén,  
Delagnes  
2014  
JAS

# Secondary production



Biache E

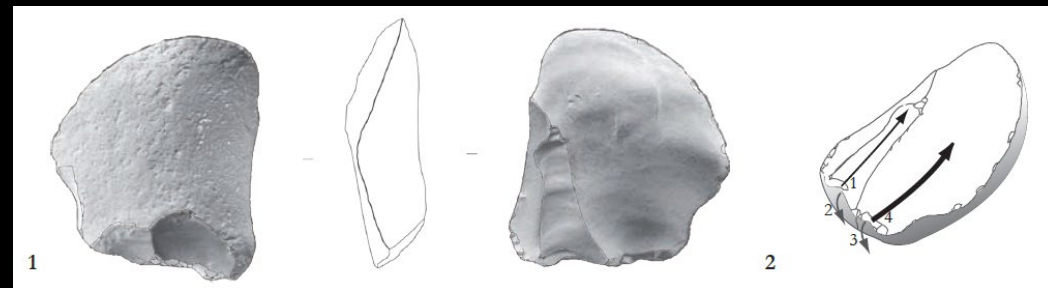
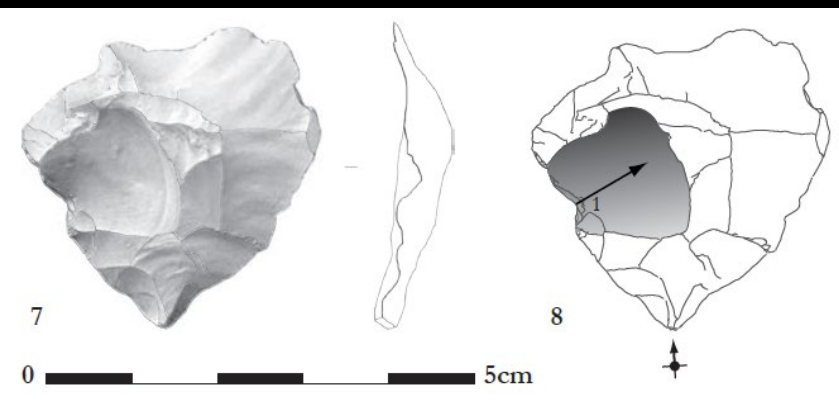

# The Fragmented Character of Middle Palaeolithic Chaînes Opératoires



Journal of Human Evolution  
Volume 65, Issue 5, November 2013, Pages 641-655



## The fragmented character of Middle Palaeolithic stone tool technology

Alain Turq <sup>a</sup>✉, Wil Roebroeks <sup>b</sup>✉, Laurence Bourguignon <sup>c</sup>✉, Jean-Philippe Faivre <sup>d</sup>✉

[Show more](#)

<https://doi.org/10.1016/j.jhevol.2013.07.014>

[Get rights and content](#)

# MIS 7/6 (191-170ka)



## Therdonne

MIS 7/6 (ca 178 ka)

1 occupation 305 m<sup>2</sup>

46 163 lithic artefacts

156 refittings (544 pieces)

Blocs de matière première



Eclats Levallois préférentiels

Importation

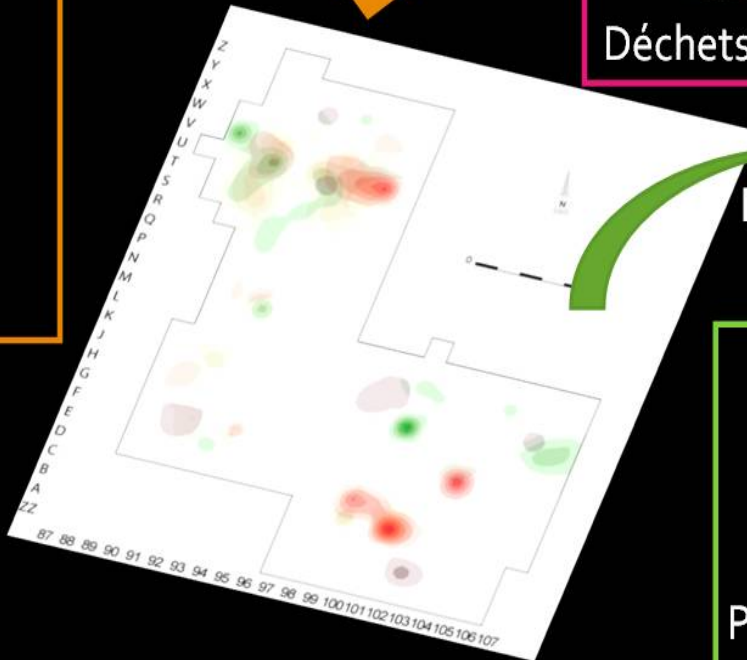

In situ



Déchets de production et outils abandonnés

Exportation



Pointes Levallois

Nucléus Levallois à pointes



# MIS 4/3 : 70-45 ka

Hermies MIS 4 –65 ka  
L. Vallin dir.

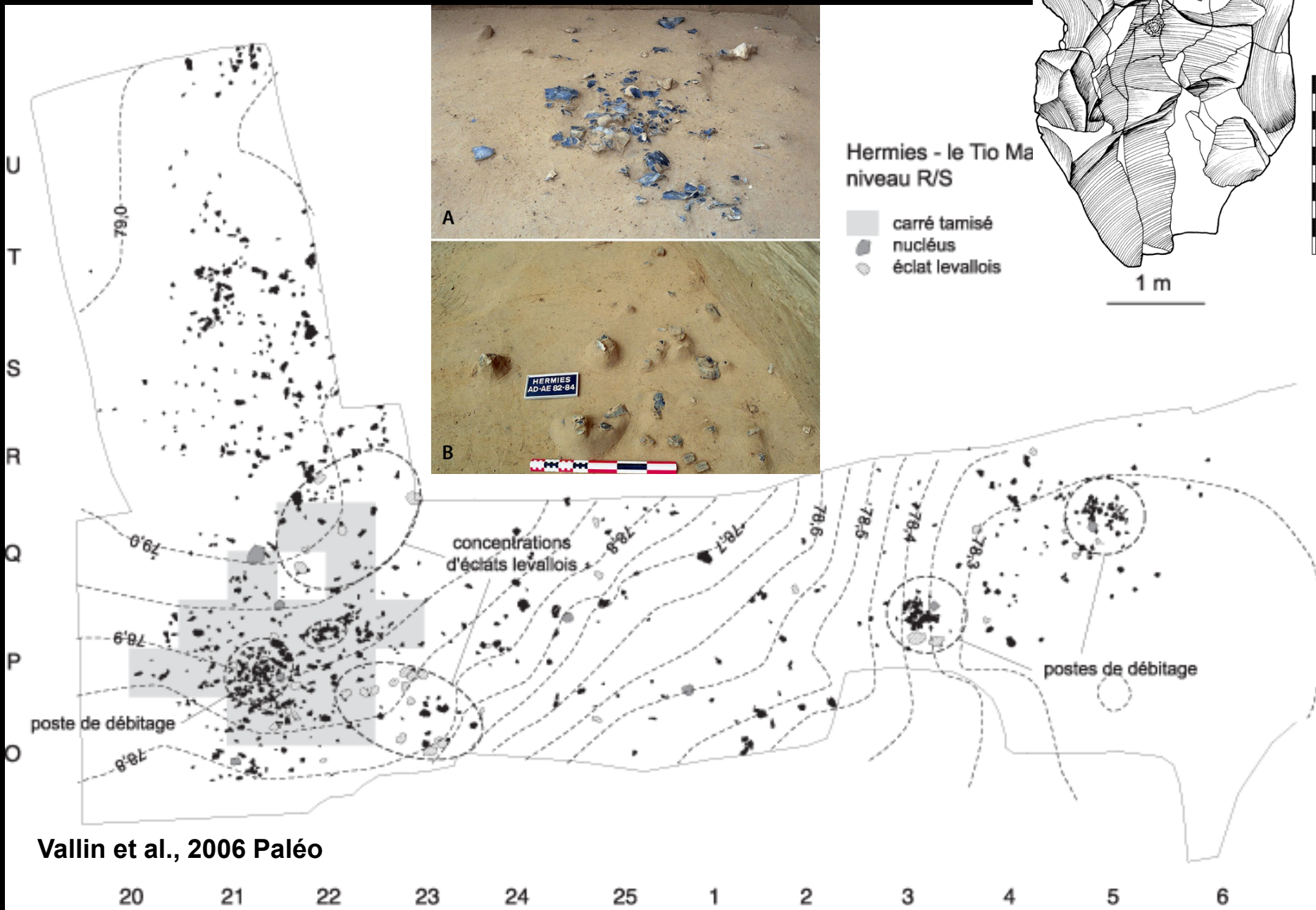

# MIS 4/3 : 70-45 ka

Havrincourt 1 (2010)

MIS 4 –65 ka

E. Goval dir.

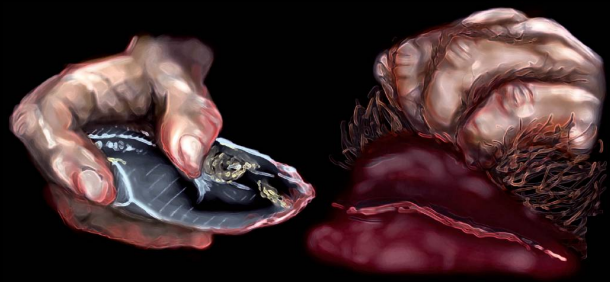

photographies prises face inférieure

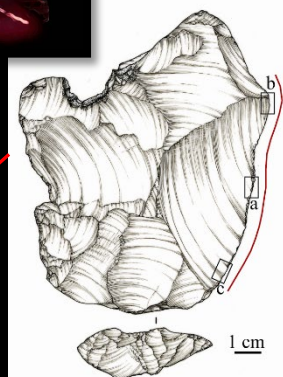

Esquillements liés à la coupe de matière tendre à mi-dure (percussion ?)

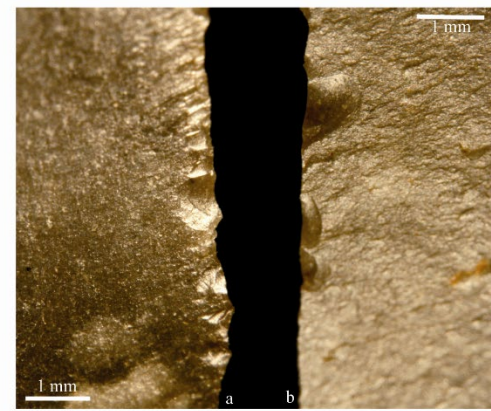
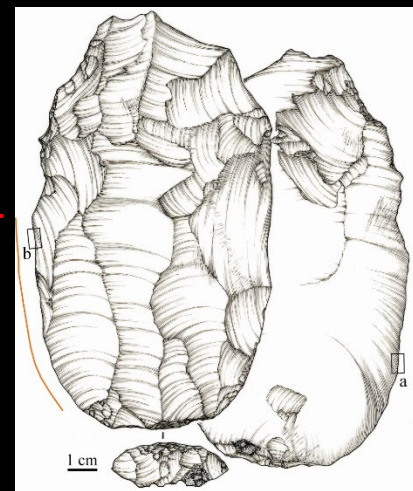
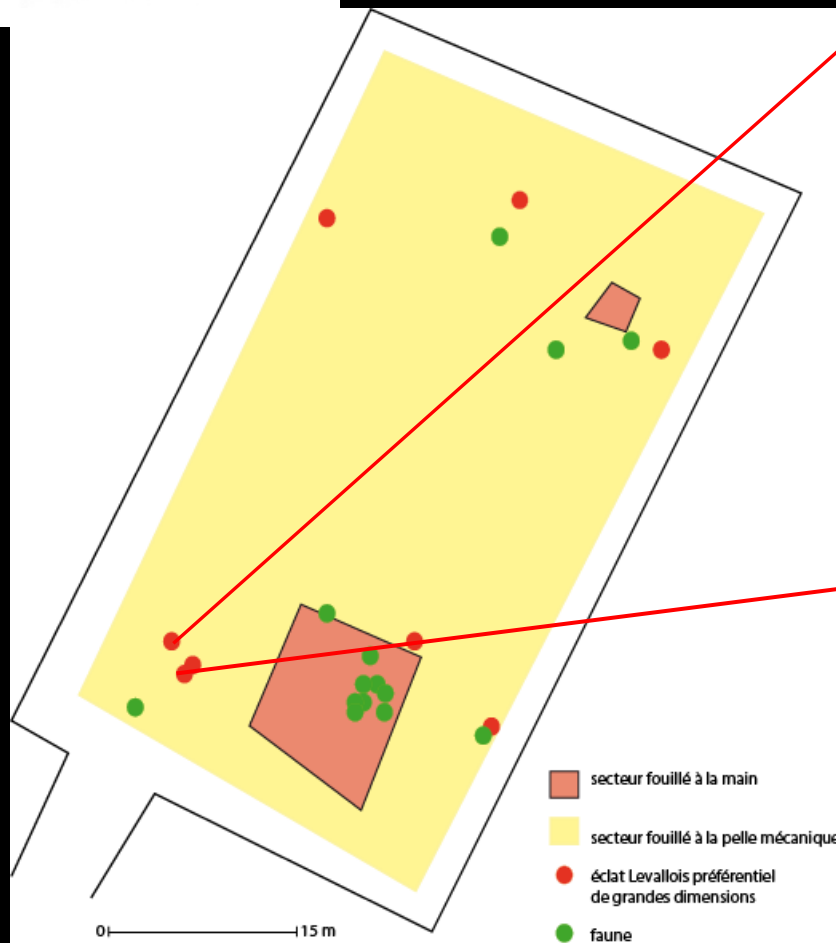

Esquillements liés à la coupe de matière tendre

# MIS 4/3 : 70-45 ka

Havrincourt

Hermies



secteur 1

<2 km

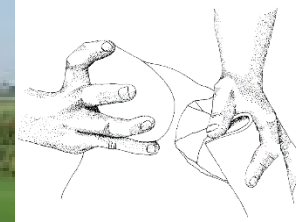

400 mètres

secteur 2

Havrinvourt

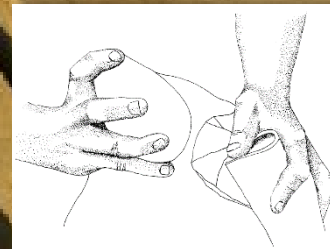



@david\_herisson

david.herisson@cnr.fr

