



HAL
open science

**Accounting for techno-economic parameters
uncertainties for robust design of remote microgrid**
Amélia Nadal, Alain Ruby, Cyril Bourasseau, Delphine Riu, Christophe
Bérenguer

► **To cite this version:**

Amélia Nadal, Alain Ruby, Cyril Bourasseau, Delphine Riu, Christophe Bérenguer. Accounting for techno-economic parameters uncertainties for robust design of remote microgrid. *International Journal of Electrical Power & Energy Systems*, 2020, 116, pp.105531. 10.1016/j.ijepes.2019.105531 . hal-02304447

HAL Id: hal-02304447

<https://hal.science/hal-02304447v1>

Submitted on 3 Oct 2019

HAL is a multi-disciplinary open access archive for the deposit and dissemination of scientific research documents, whether they are published or not. The documents may come from teaching and research institutions in France or abroad, or from public or private research centers.

L'archive ouverte pluridisciplinaire **HAL**, est destinée au dépôt et à la diffusion de documents scientifiques de niveau recherche, publiés ou non, émanant des établissements d'enseignement et de recherche français ou étrangers, des laboratoires publics ou privés.



Distributed under a Creative Commons Attribution - NonCommercial - NoDerivatives 4.0
International License

Accounting for techno-economic parameters uncertainties for robust design of remote microgrid

Amélie NADAL^{*1,2,3}; Alain RUBY¹; Cyril BOURASSEAU¹; Delphine RIU²; Christophe BERENGUER³

1. Univ. Grenoble Alpes, CEA, LITEN, DTBH, 38054 Grenoble, France

2. Univ. Grenoble Alpes, CNRS, Grenoble INP**, G2Elab, 38000 Grenoble, France

3. Univ. Grenoble Alpes, CNRS, Grenoble INP**, GIPSA-lab, 38000 Grenoble, France

* Corresponding author: amelia.nadal@grenoble-inp.fr, amelia.nadal@cea.fr

** Institute of Engineering Univ. Grenoble Alpes

Highlights

- Uncertain techno-economic parameters must be included when sizing remote microgrids
- Two approaches are set up to assess these uncertainties
- Propagation of uncertain parameters allows the assessment of design robustness
- Global sensitivity analysis identifies most influential techno-economic parameters
- Robust optimization reduces variance of techno-economic performance indicators

Abstract

This paper presents two different approaches to deal with uncertainties in the design optimization of renewable hybrid power systems in order to enhance the decision-making. The first one, Sensitivity Analysis Approach (denoted as SAA), takes the uncertainties into account after the optimization of the system. It permits first to evaluate the sensitivity on the static performances of the optimized system through uncertainty propagation. Secondly, it permits to identify the most influential uncertain parameters through Global Sensitivity Analysis (denoted GSA). The second approach, called Robust Optimization (RO), integrates a Monte Carlo (MC) simulation into the process of optimization conducted with a Genetic Algorithm (GA). The two approaches have been set up and applied to a remote power system or microgrid, under uncertainties on techno-economic parameters. This illustrative case study is the electrical supply of a stand-alone application located in Nigeria, using photovoltaic production associated to a hybrid energy storage with a bank of batteries and a complete hydrogen chain (with an electrolyzer, a gas tank and a Fuel Cell (FC). Classically, the main source of uncertainties of such a system is associated to the temporal variation of renewable energy sources and load demands. Instead, this paper focuses on uncertainties of techno-economic parameters to improve the reliability of

1 the optimization process for a stand-alone power system. Moreover, from a precise analysis of the state-
2 of-the-art of such uncertainties, the authors propose to investigate complementarities of Sensitivity
3 Analysis Approach and Robust Optimization. This study also aims to propose a methodological
4 framework for any designer. The results show the high interest to take into account such uncertainties
5 for the decision-making and the ability of RO to limit their impact on system performance indicators.

6 Keywords

- Hybrid energy system modeling
- Uncertainty modeling and propagation
- Global Sensitivity Analysis
- Robust design optimization
- Monte Carlo simulation

1. Introduction

Nowadays, energy systems are getting more and more complex, and difficult to assess because of (i) the variability of the renewable power sources and the load demand, (ii) the resultant necessity of storage systems and hybridization and (iii) the presence of different and new energy vectors such as hydrogen [1]. Classically, these systems are designed and optimized with simulation software as Odyssey [2–4], which enables the optimization of the design and the energy management system by minimizing the cost of energy while maximizing the load satisfaction on a one-year simulation. Odyssey is a simulation-optimization platform developed by the French Alternative Energies and Atomic Energy Commission (CEA). It permits comprehensive techno-economic assessments of energy systems comprising renewable energy sources and energy storage units. The precision of the technical model is rather high, as Odyssey can for instance account for performance degradation in batteries or electrolyzer and fuel cell stacks, and components replacement during system simulation.

Besides, many parameters of any power system are uncertain, e.g. economic properties [5], static component performances [6] as well as time series of production and load profiles [7,8]. Their impacts are often evaluated by performing sensitivity computations on a limited set of key parameter variations [3,9], using simulation software like Odyssey. As a result, the impact of uncertainties will mostly be alleviated by oversizing the system to meet the demand. This obviously increases the cost of the final energy supply.

To improve the techno-economic performance of the system, it is essential to better quantify the impact of uncertainties [6,10] and make the system as robust as possible with respect to uncertainties [8,11]. Several methods can be used, depending on the nature of uncertain parameters. They have been applied in various contexts, but few have been exhaustively applied for techno-economic studies to such energy power systems as remote microgrid with renewable and hybridization of storage systems.

The classical uncertainty source studied in the literature for this type of system is the variability of the time series (renewable energy production and load demand). The objective is to implement existing methods to account for techno-economic uncertain parameters, which has never been done before. The methods constitute two complementary approaches: Sensitivity Analysis Approach (SAA) and Robust

1 Optimization (RO). They highlight that these static uncertain sources have a strong impact on
2 optimization results. Therefore, the consideration of these uncertain parameters is of high interest for
3 decision-making. This work demonstrates also that RO can limit their impact on system performance
4 indicators.

5 The quantification of sources of uncertainty is a common step of both approaches. In this work,
6 uncertainty sources are associated to any techno-economic parameter, with a Probability Distribution
7 Function (denoted PDF). The SAA has two distinct aims: a first propagation quantifies the impact of
8 uncertainties on the outputs and the GSA quantifies the responsibility of each uncertain parameter in the
9 variance of the output. The other approach, namely RO, consists in including Monte Carlo (MC)
10 simulation in a Genetic Algorithm (GA) with an innovative optimization criteria.

11 These approaches have the ambition to be generic and applicable to any black box energy system
12 simulation tool involving uncertain input parameters, in order to propose a general framework for
13 designers. Thus, the contributions of the two approaches and the highlight of their complementarity
14 bring new elements in the decision-making process of such systems.

15 A typical remote and hybrid power system is presented in section 2. Then, Section 3 discusses the
16 methods associated to the two approaches, namely Sensitivity Analysis Approach and Robust
17 Optimization. Section 4 describes the application of the approaches to this remote power system. On
18 this basis, section 5 discusses their respective benefits and drawbacks. Lastly, section 6 concludes and
19 proposes some perspectives for future work.

20 2. Description of illustrative case study

21 The case study is a stand-alone power system located in Nigeria, using photovoltaic (PV) as the main
22 power source. In order to manage the time mismatch between PV production and load requirements, at
23 least one energy storage system is needed. A similar system was studied by Guinot et al. [3,4] and the
24 comparison between different system architectures showed the relevance of a hybrid storage including
25 a bank of lead-acid batteries and a complete hydrogen chain, consisting of an electrolyzer, a gas storage
26 tank and a Fuel Cell (FC). This article focuses only on electrical power flows. This system is schematized
27 in the Figure 1. The design of such a hybrid supply chain is particularly interesting as it implies a trade-
28 off between two competing technologies, i.e. the battery bank and the hydrogen storage. Each

1 component has specific technical and economic parameters, with associated levels of uncertainty.
 2 Hence, the sizing and the energy management of such a system is very likely to change according to
 3 some uncertainties.

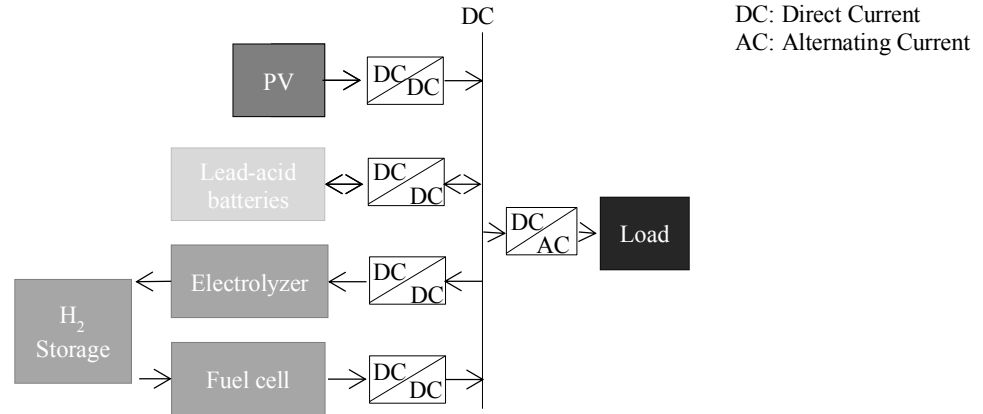

Figure 1: Case study architecture

6 A main DC bus connects a PV farm to an electrical load, which is to satisfy either with the PV
 7 production, or with the hybrid storage system also connected to this bus. This hybrid storage system is
 8 described Section 2.1.2.

9 2.1. Energy system description

10 The models of components describing the system are used in a black box perspective to remain
 11 independent of the particular tools used. However, the uncertain parameters contributing to the models
 12 have to be identified. Therefore, the models of components describing the system in Odyssey are listed
 13 in Table 1.

14 Table 1. Summary of used component models in studied energy system.

Component	Model
PV	From PV production profile
Electrolyser	Polynomial I-V Curve model
H ₂ tank	Pressure model with constant ambient temperature
FC	Polynomial Efficiency model
Battery bank	Efficiency model

15 Thanks to the Odyssey simulation software, during a one year simulation, operating rules will try to
 16 satisfy the electrical load at each sampling time. If the PV production is sufficient, the exceeding power
 17 is stored in the battery (priority #1) or converted in hydrogen (priority #2). If the PV production is not
 18 sufficient to satisfy the electrical load, electrical power is requested from the battery (priority #1) or

1 from the hydrogen supply chain (priority #2). The result of the one year simulation is then extrapolated
2 to a 20 year operation of the system to perform complete techno-economic analysis including discount
3 rate of 8% and aging of components.

4 An external loop of optimization using Genetic Algorithm (GA) allows optimizing several key
5 parameters as the rated power of electrolyser and fuel cell stacks, the battery capacity or the number of
6 PV modules.

7 The time series of PV production, component features and energy management strategy are detailed in
8 the following sections, along with the optimization process.

9 2.1.1 Load profile and photovoltaic production

10 The electrical load and the PV production are described with 5-min sampling time profiles with a
11 duration of one year. These profiles are the boundary conditions, i.e. fixed inputs of the system and they
12 will be considered as perfectly well known. The uncertainty relative to these two profiles are then not
13 considered at this step.

14 The electrical load profile of the remote power system has been generated by the duplication of a daily
15 load profile, with the application of a global random variation between -10% and +10%. The PV
16 production profile has been calculated using global and diffuse radiations and ambient temperature
17 measurements at Ilorin weather station in Nigeria.

18 2.1.2 Hybrid storage system

19 The hybrid storage system includes on one hand a bank of lead-acid batteries and on the other hand a
20 complete and reversible hydrogen chain, i.e. an electrolyzer, a pressurized tank to store the produced
21 hydrogen gas and a FC with Proton Exchange Membrane technologies for electrolyzer and FC.

22 The model of battery takes into account of its ageing through its capacity loss [3].

23 The electrolyzer is modeled with its polarization curve. Its ageing model assumes a linear increase of
24 each cell voltage with the operation time and the replacement occurs at a given amount of operating
25 hours [12].

26 The produced hydrogen is stored in a pressurized tank with a maximum pressure (30 bars) equal to the
27 output pressure of the electrolyzer; therefore no compressor is required in this application.

1 The FC is modeled with a polynomial model of its efficiency. Its ageing model is based on the efficiency
2 decrease and its replacement occurs at a given amount of operating hours.

3 It is important to note that the models for component characterization, ageing or replacement conditions
4 are non-linear models. This has a strong impact on the design methodology and the choice of
5 optimization tools that can be used to evaluate and optimize the considered system. For instance,
6 classical Stochastic Programming, that requires linear models, is not exploitable as linearization is not
7 always obvious or even possible. That is why stochastic methods will often be applied on simplified
8 models of the system, which do not account for precise ageing and replacement models, or even start-
9 up or shutdown durations. These parameters must not be ignored in the case of stand-alone energy
10 systems to get as accurate as possible the system design and operation.

11 2.1.3 Energy management strategy

12 The energy management strategy consists of classical logical rules based on the on/off switches between
13 the electrolyzer and the Fuel Cell according to the State Of Charge (SOC) of the batteries bank. It was
14 originally described by Ulleberg [13] and further investigated by other authors [2,14,15].

15 2.2. Optimization criteria and variables

16 Several performance indicators can be used to assess hybrid energy systems, characterizing them
17 technically and economically. In this case study, economic performance are levelized on a 20 years-
18 operation and with a discount rate of 8% [3]. Two performance indicators are considered as optimization
19 criteria. The first one is the Levelized Electricity Cost (denoted LEC, in €/MWh), defined as the ratio of
20 the total levelized cost of the system divided by the levelized amount of electricity provided to the load.
21 The second one is a technical indicator representing how the system meets the demand: the Unmet Load
22 (denoted UL) represents the percentage of energy based amount of unsatisfied load. The objective of
23 the optimization is to minimize jointly these two criteria. The optimization algorithm used is inspired
24 by the Genetic Algorithm SPEA 2 (Strength Pareto Evolutionary Algorithm 2) originally developed by
25 Zitzler et al. [16] and implemented in the Odyssey software. Such a tool of optimization is well adapted
26 to take into account non linear models of aging and replacement associated to the components of the
27 case study.

28 The optimization variables are the different sizes of components. They are presented in Table 2.

1 *Table 2. Optimization variables (component sizes).*

Variable	Unit	Optimization borders	
		Minimum	Maximum
Number of PV Modules	-	450	1700
Number of Battery Units	-	110	150
Number of electrolyzer cells	-	5	35
Fuel Cell Stack Max Power	W	2500	100.000
Volume of pressure tank	m ³	1	80

2 Each PV module has a peak power of 1 kWp, each battery unit has a rated capacity of 10 kWh and each
 3 electrolysis cell has a maximum power of 1.95 W. The simulation software may then integrate
 4 discontinuous variables in order to take into account these rated values.

5 2.3 Optimization results without uncertainties

6 Results of the optimization presented in this section, denoted as Non-Robust Optimization (NRO) are
 7 not the main point of this work but the starting point of the Sensitivity Analysis Approach (SAA). The
 8 NRO is namely part of this approach. The NRO results serve also as a comparison reference to evaluate
 9 the Robust Optimization (RO).

10 Due to the competition between optimization criteria as LEC and UL, the optimization results take the
 11 shape of a Pareto front as seen Figure 2. The Pareto front is, in a multi-objective optimization, the set of
 12 solutions that are Pareto optimal, i.e. the best solution for one of the criteria. In techno-economic
 13 optimization of power systems, the LEC and the UL criteria are in competition because by increasing
 14 the component sizes and consequently the LEC, the UL is reduced and inversely.

15 On this Pareto front, four different design points are selected corresponding to different indicators values
 16 (LEC and UL). These points, named from their UL value, are distributed on the Pareto front, in order to
 17 study the influence of the uncertainties on the overall Pareto front. The design variables values
 18 corresponding to these four selected configurations (named hereinafter as Case 0, Case 01, Case 05 and
 19 Case 1) are given in Table 3.

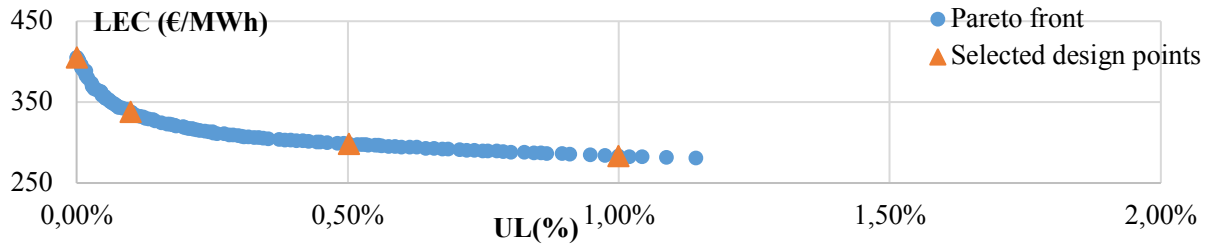

Figure 2: Pareto front of performance indicators LEC and UL resulting from NRO.

These optimization results highlight a low utilization of the hydrogen chain, i.e. the components of the hydrogen chain (electrolyzer, gas storage and FC) have small optimized capacities. Indeed, the hydrogen chain is useful to reach the full autonomy; this is why its components have the biggest sizing in Case 0 in which there is no unmet load. However, this specificity has no impact on the application of the approaches presented in this paper.

Table 3. Selected optimal designs and their corresponding performance indicators (LEC and UL).

Case	0	01	05	1
Number of Modules PV	735	735	660	600
Number of Battery Units	146	145	135	138
Number of electrolyze cells	8	5	5	5
Fuel Cell Stack Max Power (W)	43500	10500	5000	5000
Volume of pressure tank (m ³)	31	16	3.5	3.5
Unsatisfied load (%)	0	0.1	0.5	1
LEC (€/MWh)	404.9	336.1	295.5	280.2

Such results are very typical in Non-Robust Optimization (NRO) processes. However, they do not consider the uncertainty level associated to the input parameters. For that, two different approaches, namely Sensitivity Analysis Approach and Robust Optimization, are presented in the next sections.

3. Description of methods for uncertainty analysis

The most widespread method to assess the influence of uncertain parameters on optimization results is the parametric sensitivity analysis [9,17,18]. This approach is suitable for problems with few uncertain parameters, where various possible combinations of deterministic inputs values can be tested. This parametric sensitivity analysis can be easily applied, but brings limited information as it does not quantify the global uncertainty of the model outputs. Moreover, this approach does not quantify the responsibility of the uncertain parameters in the variability of the model output. This is exactly what the global sensitivity analysis (GSA) is intended and dedicated for [19]. The results of the GSA will be

1 useful for instance to determine which uncertainties should be reduced or better quantified to improve
2 the system performance or robustness. It does not directly act on the system sizing.

3 In order to integrate the uncertainties with the sizing of the system, the use of so-called Robust
4 Optimization is needed.

5 For both approaches applied to the sizing of renewable power energy systems, the whole set of uncertain
6 parameters is often not taken into account and the analysis of uncertainty is classically reduced to the
7 assessment of time series [20,21]. In addition, models of uncertainties are often very basic [6,10].

8 This section presents the chosen methods to address these weaknesses.

9 3.1. Uncertainty characterization methodology

10 Previous efforts to assess the influence of uncertain parameters on optimization results of renewable
11 energy systems often do not consider the whole set of uncertain parameters. However, it is crucial to
12 take into account all parameters in the analysis, especially the techno-economic ones [22]. Thus, as the
13 uncertainty characterization is a common step of the two approaches studied in this article (SAA and
14 RO), the methodology to characterize the uncertainty associated to parameters is detailed in this section.
15 The uncertainty is represented by a Probability Density Function (PDF) associated to the static uncertain
16 input parameter value. Uncertainties associated to the time series are not considered in this paper.

17 The characterization method is described by the following steps:

- 18 1. First, a literature research is conducted to identify existing, validated or accepted uncertainty
19 probabilistic models for the different parameters of the considered energy system.
- 20 2. If no PDF was found in the literature, a uniform law is attributed to the parameter value
21 with minimal and maximal values deduced from the literature. The uniform law is chosen
22 to represent the equiprobability between the parameter values.
- 23 3. The parameters for which only a rated value has been found out, i.e. the parameters for
24 which neither a probability density function nor minimal/maximal values have been found
25 out, are separated in two categories as suggested by Moret [22]:
 - 26 a. Parameters associated to the ageing of the component. For them, the PDF is a uniform
27 density function, centered on the rated value, with an amplitude of 50%.

- 1 b. Parameters not associated to any ageing, for which uncertainties are modeled with a
2 uniform density function, centered on the nominal value, with an amplitude of 5%.

3 This characterization methodology permits systematic attribution of PDF to any static uncertain
4 parameter required for SSA and RO. It is applied to the illustrative case study in section 4.1.

5 3.2. Sensitivity Analysis Approach methodology

6 The Sensitivity Analysis Approach (SSA) has two aims. The first one is to quantify the impact of
7 parameter uncertainties on the model outputs, which is realized through uncertainty propagation. The
8 second one is to identify the most influential uncertain parameters and to quantify the influence of one
9 uncertain parameter on the output variance, which is realized through GSA.

10 3.2.1 Uncertainty propagation

11 Once each uncertain parameter is characterized, the propagation of uncertainties allows the analysis of
12 the change in performance indicators with respect to these uncertainties. From the probability
13 distribution associated to each uncertain parameter, the methodology consists of a Monte Carlo (MC)
14 propagation, i.e. the sampling of the uncertain parameters (considered as independent) and the
15 evaluation of the corresponding design performances, calculated with the Odyssey simulation software.
16 In this work, the MC launcher provided by the Uranie software [23] is coupled to Odyssey executable.
17 The “Uncertainty and Sensitivity” platform Uranie developed by the CEA aims to capitalize all methods
18 and algorithms about uncertainty and sensitivity in the same framework. Uranie is based on the data
19 analysis framework ROOT (<http://root.cern.ch>), an object-oriented computing system developed at
20 CERN.

21 The performance sampling sets that are obtained permit the calculation of statistical values on
22 performances to better understand and assess the impacts of uncertainties on the outputs of the system.
23 The statistical quantities (mean, variance, confidence interval...) or the representation of the
24 performance distributions (with scatter plots or histograms) contribute to facilitate the decision-making
25 process for designers and improve the confidence in the results. Some of these elements resulting from
26 this coupling for the illustrative case study are investigated in section 4.2.1.

27 3.2.2. Global Sensitivity Analysis

28 The aim of the sensitivity analysis is to identify the most influential uncertain parameters and to quantify
29 the influence of one uncertain parameter on the output variance. In particular, the GSA considers the

1 variability of the uncertain inputs on their whole variation domain simultaneously. GSA methods are
2 mature, frequently improved [24] and are used in various domains as life cycle assessment [25] or
3 Building Performance Simulation [26]. In the field of power system design, Moret et al. [22] and
4 Mavromatidis et al. [21] have used two-stage GSA to deal with a large number of uncertain parameters,
5 for respectively national or local (i.e. at neighborhood scale) energy planning. This two-stage GSA was
6 first proposed by Campolongo et al. [27].

7 *First stage: factor fixing*

8 The stage of factor fixing aims to identify non-influential parameters, i.e. uncertain input parameters
9 that have a negligible effect on the system performance output. For that, the Morris method [28] is a
10 relevant screening and qualitative method allowing classifying the uncertain parameters in three
11 categories:

- 12 - parameters with negligible effect,
- 13 - parameters with linear effect and without interaction,
- 14 - parameters with nonlinear effect and/or interactions (without distinction of these two effect
15 types). The fact that there is no distinction between the parameters with nonlinear effects and/or
16 interactions has no consequence because the aim of this stage is only to determine the
17 parameters with a negligible effect, in order to further focus the study on parameters with a
18 significant effect.

19 The Morris method generalizes One-factor-At-a-Time (OAT) protocols and lies between local and
20 global methods [22]. The method consists in repeating r times the OAT principle choosing randomly
21 the starting point, building so r trajectories and calculating for each trajectory the elementary effect (EE)
22 for each uncertain entry parameter.

23 Considering the following mathematical framework:

$$f : \mathbb{R}^d \rightarrow \mathbb{R} \tag{Equation 1}$$

$$X \mapsto Y = f(X)$$

24 Y is the scalar output of the model, built with d uncertain parameters gathered in the X vector. So,

$$X = \begin{pmatrix} X_1 \\ X_2 \\ \vdots \\ X_d \end{pmatrix}.$$

Denoting Δ_i the chosen variation in the trajectory of parameter X_i , the EE is calculating as follows:

$$EE_i = \frac{f(X_1, \dots, X_i + \Delta_i, \dots, X_d) - f(X_1, \dots, X_i, \dots, X_d)}{\Delta_i} \quad \text{Equation 2}$$

The major advantage of this method is its low computational requirements. In fact, the Morris method requires $N = r * (d + 1)$ code computations, with r the number of trajectories, $r \in \llbracket 4; 10 \rrbracket$ [19]. The approximation made by fixing non-influential factor can be calculated with a methodology presented by Sobol et al. [29].

Second stage: factor prioritization

Factor prioritization aims to rank the most influential parameters on the output variance. A quantitative appreciation of their influence can be obtained by using variance-based methods. Sobol [30] showed that variance decomposition can be obtained, if the d uncertain parameters X_i are aleatory and mutually independent and is expressed as:

$$Var[Y] = \sum_{i=1}^d V_i(Y) + \sum_{i<j} V_{ij}(Y) + \sum_{i<j<k} V_{ijk}(Y) + \dots + V_{12\dots d}(Y) \quad \text{Equation 3}$$

Where

$$V_i(Y) = Var[\mathbb{E}(Y|X_i)] \quad V_{ij}(Y) = Var[\mathbb{E}(Y|X_i X_j)] - V_i(Y) - V_j(Y) \quad \text{Equation 4}$$

The sensitivity indices are:

$$S_i = \frac{Var[\mathbb{E}(Y|X_i)]}{Var(Y)} = \frac{V_i(Y)}{Var(Y)} \quad S_{ij} = \frac{V_{ij}(Y)}{Var(Y)} \quad S_{ijk} = \frac{V_{ijk}(Y)}{Var(Y)} \quad \text{Equation 5}$$

The total sensitivity indices [31] transcribe all the effects of an uncertain input on the output:

$$S_{T_i} = S_i + \sum_{j \neq i} S_{ij} + \sum_{j \neq i, k \neq i, j < k} S_{ijk} + \dots \quad \text{Equation 6}$$

These sensitivity indices, denoted as “measures of importance”, are ranged from 0 to 1 and are easily interpretable, what makes them very relevant among designers. They directly represent the part of the output variance that could be avoided if the parameter X_i could be fixed, i.e. if the parameter X_i would be known with certainty.

1 The estimation method that is used for this study is the one proposed by Saltelli [32], where the number
2 of model evaluations is $N = n_S * (d + 2)$, with n_S the Monte Carlo sampling size.

3 The application of the Morris method followed by the calculation of the total sensitivity indices gives
4 to the user the absolute and relative influence of each uncertain input parameter on the variance of the
5 outputs. As far as hybrid energy system design is concerned, it is of strong interest as it gives a better
6 knowledge about inherently very uncertain systems. More precisely it allows to quantify information on
7 (i) the design risks and (ii) the uncertain input parameters playing on this risk, e.g. parameters linked to
8 non-fully mature components. The application of the GSA results are presented section 4.2.2.

9 In this work, the presented SAA methods are applied to the static techno-economic parameters in a
10 hybrid stand-alone power system, which has never been referenced up to now.

11 3.3. Robust Optimization methodology

12 While SAA evaluates the robustness of the optimal solution a posteriori, Robust Optimization takes into
13 account the probability distributions of uncertain parameters during the optimization process itself. It
14 permits integrating the uncertainty of a system in its design process.

15 A lot of techniques exist to perform this. For instance, Zakariazadeh et al. [33], Pazouki and Haghifan
16 [34] and Mavromatidis et al. [35] investigate a two-stage Stochastic Programming, by representing the
17 uncertainties on time series with the use of scenarios. To surpass the need to provide the probability
18 distribution functions of the underlying stochastic parameters, a robust approach has been proposed
19 where the random parameters belong to uncertainty sets in Bertsimas and Sim [36]. In the energy field,
20 Moret et al. [37] adapted and used it in Strategic Energy Planning. Recently, Maggioni et al. [38]
21 compared these approaches with Stochastic Programming. However, this approach uses a different
22 modeling of the uncertainty than the GSA methods cited before. This paper proposes then a comparison
23 between two methodologies, taking into account that the modeling of the uncertainties should be the
24 same in the two approaches. Another constraint of the Stochastic Programming is the necessity to
25 formulate a linear model which cannot be applied in our black box simulation perspective. Moreover,
26 this approach is not suitable for multi-objective optimization.

27 To deal with multi-criteria optimization using nonlinear models, metaheuristic algorithms can be used.
28 Besides this advantage, the metaheuristic algorithms like Genetic Algorithm (GA) or Particle Swarm

1 Optimization (PSO) are based on the exploration of the problem variables space including randomness
 2 during the search for optimality, limiting so the number of model evaluations. By combining these
 3 methodologies with the Monte Carlo (MC) simulation, the definition domains of uncertain parameters
 4 can be explored, performing so a Robust Optimization (RO). For instance, Maleki et al. [39] uses MC
 5 simulation and PSO algorithm to optimize an off-grid hybrid renewable system taking into account the
 6 resource and load uncertainties. The combination of the GA and the MC simulation, which is compatible
 7 with a multi-criteria optimization, offers a techno-economic optimization framework in this study. It
 8 was first proposed by Cantoni et al. [40] and further investigated by Marseguerra et al. [41]. Recently,
 9 Roberts et al. [20] used it to optimize a renewable based hybrid power system considering as uncertain
 10 the time series (renewable productions and load) and the components availability. In [20], the
 11 optimization criteria are based on the worst performance indicator (worst case observed in one sample),
 12 while in our paper one of the optimization criteria measures the variability of one performance indicator
 13 during the optimization itself.

14 The added value of this method, in comparison to the classical genetic algorithm, is the improvement of
 15 the calculation of the optimization criteria. Instead of being direct outputs of the model, these criteria
 16 are calculated as statistical values. Figure 3 illustrates how the proposed RO works, i.e. a GA including
 17 a MC simulation (dotted arrows) in comparison to a classical genetic algorithm.

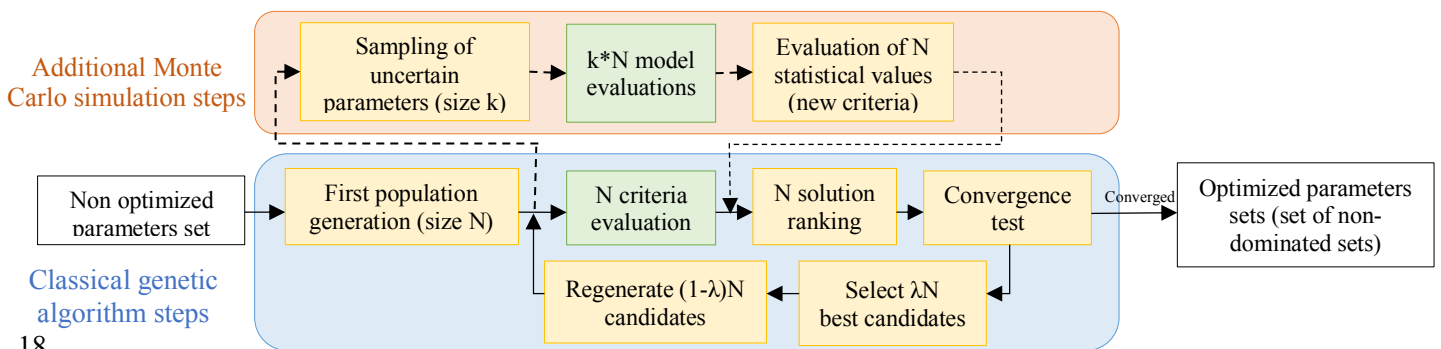

18
 19 *Figure 3: Principle of the GA including MC simulation.*

20 MC simulation is conventionally used to estimate the expected values of the model output with
 21 uncertainties in the renewable sources and load. However, any statistically calculable value can be used
 22 as an optimization criterion, depending on the objective of the user. The new optimization criteria used
 23 for this work combines the mean and the variability of each performance indicator:

$$\text{Optimization Criteria} = \mu + \alpha * \sigma$$

Equation 7

1 where μ denotes the mean of the output indicator, σ , the standard deviation and α , a non-strictly positive
2 factor. By varying the value of α , the user can express the weighting function that the user requires
3 between the performance and their dispersion. If the dispersion is not a critical point at all, α can be null.
4 The more important the dispersion is, the highest should be the value of α .

5 With this construction of criteria, the presented RO method is suited for proposing a robust design to
6 the uncertainties. This method gives users the opportunity to design a system considering the
7 uncertainties while choosing the nature of their impact on the resulting performance indicators. This
8 makes robust optimization a powerful tool as it is not always possible to reduce the uncertainty of input
9 parameters in the field of hybrid energy system.

10 It seems that application of RO method to a stand-alone hybrid energy system has never been referenced
11 up to now. In this work, we have adapted this approach and applied it on the case study (see section 4.3).

12 4. Application to the illustrative case study

13 Neither the Sensitivity Analysis Approach nor the Robust Optimization have been applied to a stand-
14 alone hybrid power system in order to account for the static techno-economic parameter used in its
15 modeling. In this section, the described methods are then applied to the case study presented in section
16 2.

17 4.1. Uncertainty characterization

18 For most of studies on hybrid power systems, time series are the only uncertainty considered. In the
19 present paper, we have chosen to focus on a fairly rare case study where the uncertainty sources are all
20 the techno-economic parameters. In our case study, 24 static input techno-economic have then been
21 identified as uncertain parameters. The uncertainty characterization method presented previously in
22 paragraph 3.1 is applied and Table 4 summarizes the uncertain parameters of the system components
23 considered in the study, with their associated PDF.

24 Due to the variety of the state-of-the art and the non-maturity of several system components as the
25 hydrogen chain, the attribution of PDF is a complex exercise. However, this is an unavoidable step for
26 the accuracy of the presented approaches [22].

1 Table 4. Uncertain parameters and associated probability distributions (with Uniform (U), Beta (β) or Weibull (W) laws) for
 2 our case study.

Component	Parameter	Unit	PDF	Reference
PV	CAPEX	€/Wp	β [$\alpha = 1.8$; $\beta = 6$; Min = 0.374; Max = 3.165]	[42]
	OPEX	% CAPEX	U [2; 10]	CEA data*
	Replacement cost	% CAPEX	U [16.5; 22.5]	[42]
	Replacement time	h	W [$\alpha = 5.3759$; $\beta = 30$; Min = 0]	[43]
Electrolyser	CAPEX	€/W	U [6.5; 13.1]	CEA data*
	OPEX	% CAPEX	U [2; 10]	CEA data*
	Replacement cost	% CAPEX	U [9; 37]	[12]
	Degradation	μ V/Operating h	U [0.4; 15]	[12]
	Replacement time	Operating h	U [30000; 90000]	[12]
	Cell voltage**	-	U [1.39; 1.54]	CEA data*
H ₂ tank	CAPEX**	€/m ³	U [18,055; 28,239]	CEA data*
	OPEX	% CAPEX	U [2; 10]	CEA data*
FC	CAPEX	€/W	U [2.2; 8]	CEA data*
	OPEX	% CAPEX	U [2; 10]	CEA data*
	Replacement cost	% CAPEX	U [30; 36]	[2]
	Efficiency**	-	U [0.30; 0.34]	CEA data*
	Degradation	%/h	U [0.45; 1.35]	[44]
	Replacement time	Operating h	U [10000; 20000]	[45]
Battery bank	CAPEX	€/Wh	β [$\alpha = 1.31$; $\beta = 3.5$; Min = 0.102; Max = 0.354]	[46]
	OPEX	% CAPEX	U [2; 10]	CEA data*
	Charge efficiency	-	β [$\alpha = 1$; $\beta = 4$; Min = 0.8; Max = 0.9]	[32]
	Discharge efficiency	-	β [$\alpha = 1$; $\beta = 4$; Min = 0.8; Max = 0.9]	[32]
	Self-discharge	W	U[3.75E-5; 1.4E-4]	[47]
	Capacity loss	Wh/h	U [1.4E-5; 4.2E-5]	[48]

* CEA expert interviews

CEA: French Alternative Energies and Atomic Energy Commission

CAPEX: CAPital EXpenditure

OPEX: OPerating EXpenditure

3

4.2. Application of Sensitivity Analysis Approach

The SAA evaluates the robustness of the optimal solution a posteriori. Thus, the different designs investigated with this approach (Case 0, Case 01, Case 05 and Case 1) arise from the NRO. In the case study, the output performance indicators are the LEC and the UL. Uncertainty propagation then evaluates their robustness and GSA identifies the most influential uncertain parameters on their variance.

4.2.1 Uncertainty propagation

For each design (Case 0, Case 01, Case 05 and Case 1) described in section 2, the simulation is iterated for a 300 Monte Carlo history.

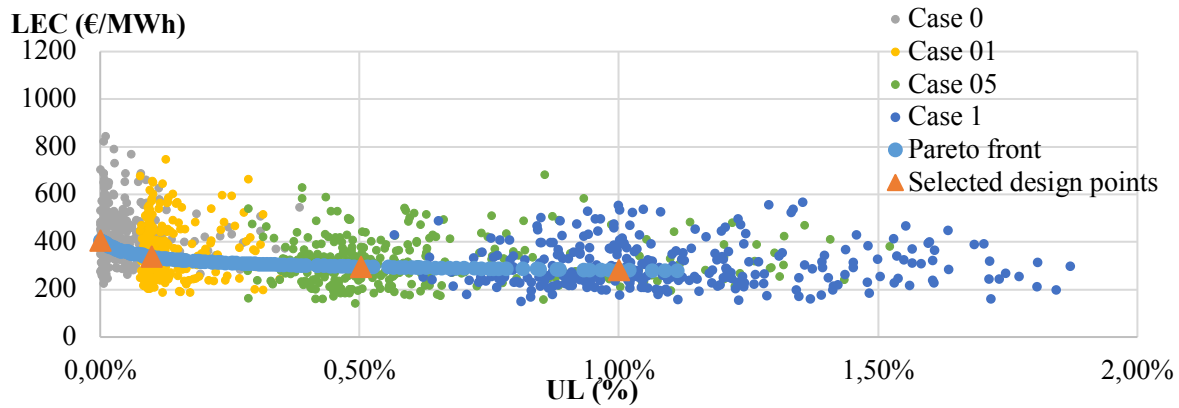
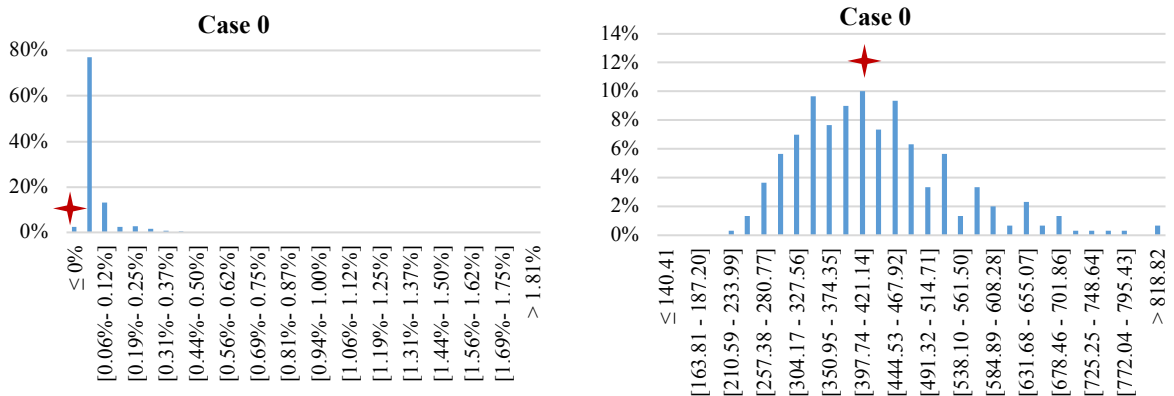
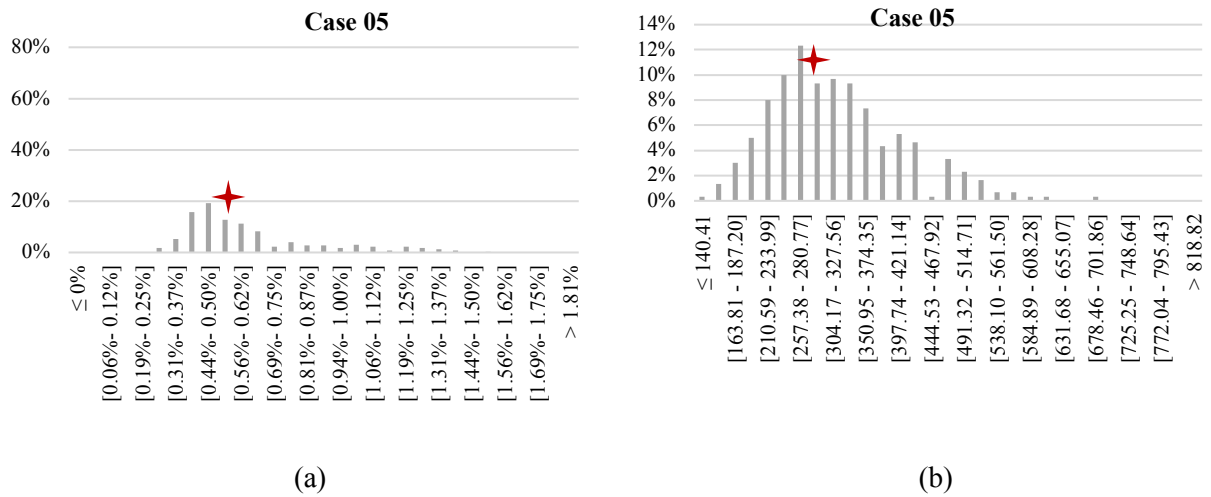

Figure 4: Performance indicators LEC and UL for the four selected design configurations with propagation of uncertainties.

Figure 4 shows the resulting performance indicators LEC and UL with the Pareto front resulting from the NRO. The scatterplots show that considered uncertain parameters have a strong impact on the performance indicators. Several realizations have better performances (i.e. lower LEC and UL) but a lot of configurations have lower performances (i.e. higher LEC and UL) than expected. Depending on the considered design, the scatter plots do not have the same shape, as well as the histograms of the Figure





1 *Figure 5: Distribution after uncertainty propagation of the performance indicators UL in % (a) and LEC in €/MWh (b).*

2 The histograms of the performance indicators UL and LEC show the repartitions of the values which
 3 differ between the cases 0 and 05. (The designs of the cases 01 and 1 have similar shapes than
 4 respectively 0 and 05). The reference intervals of the LEC and the UL values are identified in Figure 5
 5 with a red star. The reference value is not necessary situated in the interval with the maximal probability
 6 to be represented (e.g. in Case 0 for UL). It shows that taking a decision with only the reference value
 7 is a very risky choice.

8 For an optimal analysis of the results, it is interesting to highlight the confidence interval¹. The 90%
 9 confidence interval for the UL is four times narrower for the cases 0 (and 01) than for the cases 05 (and
 10 1). It means that case 0 will be four times more robust to uncertainties than other cases. This can be
 11 explained by the fact that these designs include oversized components for rated conditions. In cases
 12 where the uncertainties reduce the performances of the system, the oversizing limits the created
 13 unsatisfied load.

14 By contrast, the width of the 90% confidence interval for the LEC is smaller with the augmentation of
 15 the associated UL, i.e. the case 0 has the biggest confidence interval for the LEC and the case 1 the
 16 smallest one. This means that the design of the case 0 is the most robust to uncertainties, compared with
 17 the other designs. This can be explained with the fact that in this study, the LEC is principally linked to
 18 the investment cost of the system, which is bigger for oversized designs (cases 0 and 01) than for the

¹ The 90% confidence interval of a variable represents the interval in which the value of a variable has 90% of chance to be situated.

1 other designs. So, the uncertainties on economic parameters are mostly influential on the more expensive
2 designs, i.e. the designs of the cases 0 and 01.

3 The graphical representation and statistical quantities that can be calculated thanks to uncertainty
4 propagation are then relevant and useful tools for the decision-maker.

5 4.2.2 Global Sensitivity Analysis

6 To go further in the analysis of the optimal configuration obtained with NRO, the GSA is also a powerful
7 tool, applied in this paper to the design cases denoted 0, 01, 05 and 1. It quantifies (qualitatively and
8 quantitatively) the responsibility of the uncertainty of one uncertain inputs in the variability of the
9 performances indicators. This indicator is very useful in order to drive further investigation to gather
10 information on the most uncertain input parameters and to make effort to reduce their dispersions.

11 *First stage: factor fixing*

12 The Morris method, applied to each design case, allows to select among the uncertain parameters the
13 one with a non-negligible influence on the output performance indicators (UL and LEC). In Table 5 the
14 notation “+” means that the uncertain parameter has a non-negligible influence on the output, based on
15 the Morris method, realizing the first stage (i.e. factor fixing) of the Global Sensitivity Analysis (GSA).
16 Therefore, this uncertain parameter is kept for the rest of the second stage of the GSA (i.e. factor
17 prioritization). On the contrary, the notation “-” means that the uncertain parameter has a negligible
18 influence on the output. Therefore, this uncertain parameter is not kept for the rest of the second stage
19 of the GSA.

20 We can observe that the eliminated parameters are not the same for LEC and UL indicators. In this work,
21 the UL is uncorrelated from the economic parameters, so the Morris method naturally eliminates the
22 uncertain economic parameters for the calculation of the sensitivity indices for the UL. On the contrary,
23 the LEC is not influenced only by economic parameters, since it depends also on the electricity
24 production. For the sensitivity indices calculation related to the LEC, the most influential uncertain
25 technical parameters are not eliminated by the Morris method.

26

1 *Table 5. Morris method results on the case study.*

Component	Parameter	LEC	UL
PV	CAPEX	+	-
	OPEX	+	-
	Replacement cost	-	-
	Replacement time	-	-
Electrolyzer	CAPEX	+	-
	OPEX	+	-
	Replacement cost	-	-
	Degradation	-	+
	Replacement time	+	-
	Cell voltage	-	+
H ₂ tank	CAPEX	+	-
	OPEX	+	-

Component	Parameter	LEC	UL
FC	CAPEX	+	-
	OPEX	+	-
	Replacement cost	-	-
	Efficiency	-	+
	Degradation	-	+
	Replacement time	-	-
Battery bank	CAPEX	+	-
	OPEX	+	-
	Charge efficiency	+	+
	Discharge efficiency	+	+
	Self-discharge	-	+
	Capacity loss	+	+

2

3 *Second stage: factor prioritization*

4 The normalized total sensitivity indices shown in Figure 6 indicate the ratio of the output variance that
 5 is explained by an uncertain parameter and its interaction effects with other uncertain parameters.

6 Analysis of Unmet load

7 Considering the unmet load variance, the sensitivity indices represented in Figure 6 indicate that the
 8 most influential uncertain parameter, whatever the case, is the capacity loss of the battery, followed by
 9 its discharge efficiency. The importance of these two parameters, both related to the battery bank, shows
 10 the major role played by this component in the load satisfaction.

11 The discharge efficiency is much more influential than the charge efficiency because, whatever the
 12 considered case, the PV farm is oversized and therefore the solar production is in excess, limiting the
 13 role of the charge efficiency. This last parameter takes a bigger importance only in cases 05 and 1,
 14 (responsibility of respectively 3 and 5% of the unmet load variance), where the PV sizing is smaller
 15 (Table 3).

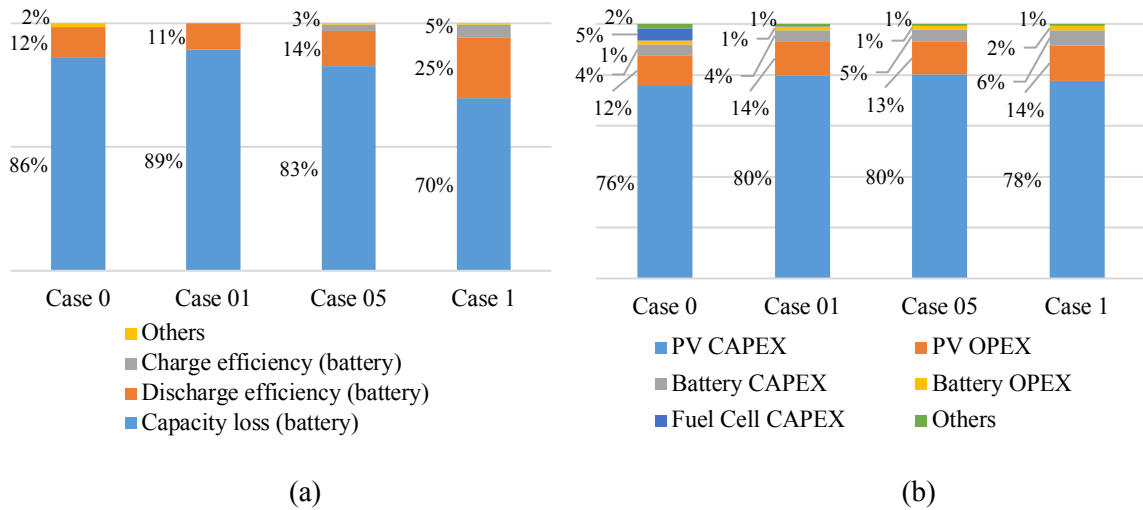

Figure 6: Normalized Sobol indices (total order) calculated for the four selected designs, related to the UL (a) and to the LEC (b).

The obvious ascendancy of the battery on the hydrogen chain is due to their respective sizing and associated strategy of energy management. Table 6 illustrates that the hydrogen chain (i.e. the FC) supplies a negligible electric power, even in the case 0, in which the FC has the biggest sizing (Table 3), i.e. for which the hydrogen chain is the most favorable.

Table 6. Levelized total powers supplied by the hydrogen chain and the battery bank for optimal selected designs.

	Electrical Storage Bank DISCHARGE Power (MWh)	Fuel Cell Stack Power (MWh)
Case 0	213.92 (98%) ²	4.09 (2%)
Case 01	210.97 (99%)	1.84 (1%)
Case 05	210.78 (99%)	1.45 (1%)
Case 1	210.89 (99%)	1.33 (1%)

This identification helps reconsider the hybrid energy system, recognise potential weaknesses that could have been neglected (e.g. battery capacity loss) or differentiate parameter with a priori similar use (e.g. charge and discharge efficiency).

² The percentages correspond to share of supplied power provided by the hydrogen chain and the battery bank to satisfy the load.

1 Analysis of Levelized Electricity Cost

2 The Sobol sensitivity indices indicate that whatever the case, the most influential uncertain parameter
3 on the LEC variance is the PV CAPEX, far ahead of the PV OPEX parameter and to a lower degree the
4 CAPEX of the battery bank. This information is crucial because it helps understanding and managing
5 the LEC variance, which a central decision-tool.

6 The hydrogen chain plays a significant role in the LEC variance only in the case 0, i.e. with its largest
7 design. Indeed, 26% of the total cost corresponds to the chain and especially 19% for the FC (Figure 7).

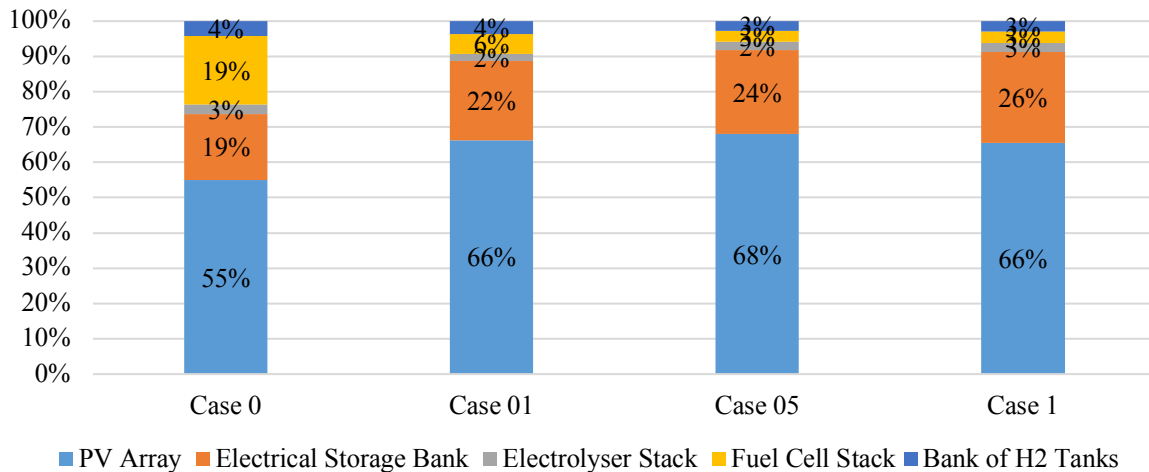

8

9

Figure 7: Cost distributions for the four selected designs.

10 Moreover, if the Sobol index of a given parameter is linked to the cost weight of the corresponding
11 component (studied in section 2), there is no direct proportional link because of the influence of the
12 probability distribution of the input parameters values. For instance, the battery bank that plays an
13 important role in the system cost (between 19% and 26%) has a relatively small impact (inferior than
14 8%) on the LEC variance.

15 4.3. Robust Optimization application

16 The application of the RO to the case study aims to minimize the LEC and the UL, but also the variability
17 of the UL. In other words, the goal is to get a more reliable value for UL, with the risk of getting a bigger
18 value of this indicator but also a bigger and eventually more volatile LEC value. This illustrates the
19 potential choice for the user when designing the system, to get more or less reliability for a bigger or
20 smaller risk of unsatisfying load.

21 RO has the same optimization variables and optimization borders than NRO i.e. the component sizes
22 and their optimization borders are summarized in Table 2.

1 RO optimization criteria to minimize are μ_{LEC} ($\alpha = 0$) and $\mu_{UL} + \alpha * \sigma_{UL}$ ($\alpha = 2.92$), calculated thanks
 2 to MC simulation. The α value of 2.92 has been calculated so that the mean value and the standard
 3 deviation have the same weight (see Equation 8). For that, the mean values (μ_i) and the standard
 4 deviations (σ_i) of the UL have been calculated for each selected design point (cases 0, 01, 05 and 1)
 5 after the uncertainty propagation (NRO). The coefficient α is then adapted in order to balance the
 6 Equation 8:

$$\sum_1^4 \mu_i = \alpha * \sum_1^4 \sigma_i \quad \text{Equation 8}$$

7 The technical characteristics of the performed robust optimization are given in the Figure 8. This
 8 optimization has been performed on 34 threads on an Intel^(R) Core^(TM) i7-7700 CPU processor.

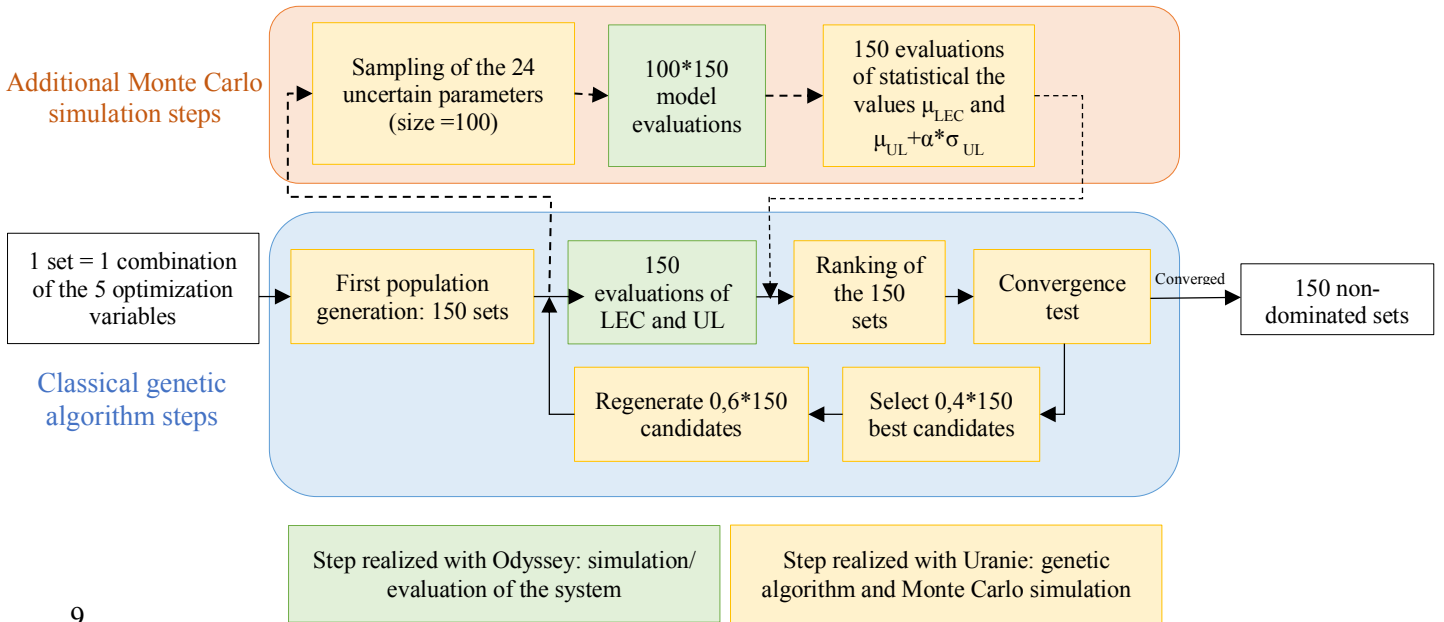

9
 10 *Figure 8: Application of the robust optimization principle to the case study.*

11 The RO results take the shape of a Pareto front whose points correspond to pairs of optimization criteria
 12 μ_{LEC} (Equation 7 with $\alpha = 0$) and $\mu_{UL} + \alpha * \sigma_{UL}$ (Equation 7 with $\alpha = 2.92$) for optimized design of the
 13 system. For each of these designs, the system is re-evaluated with the set of nominal values for the
 14 uncertain parameters, in order to obtain the performance indicators UL and LEC for the robust-
 15 optimized designs. The nominal values of the uncertain parameters are values used in the NRO of the
 16 classical approach. Figure 9 shows the resulting UL and LEC pairs (RO optimal designs), on the same
 17 chart than the Pareto front resulting from the NRO. It also shows that the performances are comparable
 18 but the associated designs obtained with the NRO and with the RO change, in other words that different

1 designs lead to the same performance indicators, but not necessary with the same level of robustness.
 2 The LEC indicators arisen from RO are higher than LEC from NRO for high autonomous manner, i.e.
 3 when UL is close to 0.

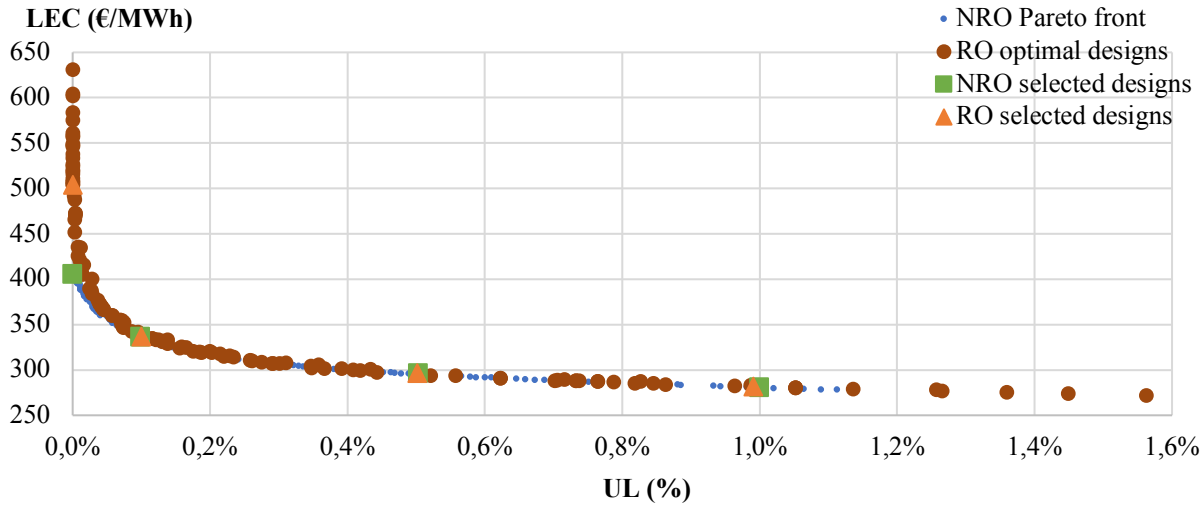

4
 5 *Figure 9: Performance indicators (LEC and UL) for optimal designs resulting from RO and NRO.*

6 To compare the results, the designs resulting from RO with similar UL performance than the NRO
 7 reference cases are selected (triangles and squares in Figure 9). The designs corresponding to the UL
 8 0%, 0.1%, 0.5% and 1% are detailed in Table 7.

9 *Table 7. Selected optimal designs and their performance indicators LEC and UL for RO and NRO.*

UL (selection performance indicator)	0%		0,1%		0,5%		1%	
Optimization	NRO	RO	NRO	RO	NRO	RO	NRO	RO
Number of Modules PV	735	1081	735	726	660	637	600	586
Number of Battery Units	146	150	145	150	135	150	138	150
Number of electrolyze cells	8	5	5	5	5	6	5	5
Fuel Cell Stack Max Power (W)	43500	42306	10500	9866	5000	2779	5000	2618
Volume of pressure tank (m ³)	31	25	16	19	3.5	3	3.5	8
Resulting LEC (€/MWh)	404.9	504.2	336.1	337.1	295.5	296.6	280.2	281.8

10 The main differences are related to the sizes of the PV farm and the battery bank. In fact, to achieve the
 11 same UL, except for the case 0, the robust optimization proposes designs with a smaller number of PV
 12 modules than those resulting from the NRO. The RO always maximizes the number of battery units,
 13 reaching the upper limit defined at the beginning of the optimization, which is never the case of the
 14 NRO. The sizing of each component of the hydrogen chain resulting from the RO, does not have a clear
 15 different conclusion with the NRO. This means that for a better reliability of the UL, the best trade-off

1 consists in increasing the battery size and not the hydrogen chain or the PV farm. The oversizing to limit
 2 the impact of uncertainties is therefore well quantified for the designer.

3 To evaluate if the proposed designs are more robust than the ones arising from the classical optimization,
 4 a new uncertainty propagation is performed. The mean values and the standard deviations of the LEC
 5 and UL indicators are then calculated and compared (see Table 8) with the corresponding ones resulting
 6 from the NRO as:

$$7 \quad \text{Comparison (\%)} = \frac{\sigma_{RO} - \sigma_{NRO}}{\sigma_{NRO}}$$

8 *Table 8. Comparison of the performance indicators (mean values and standard deviations) between RO and NRO.*

		UL	LEC
Mean	Case 0	-95%	+22%
	Case 01	-10%	NE
	Case 05	-14%	NE
	Case 1	-4%	NE
Standard deviation	Case 0	-95%	+39%
	Case 01	-38%	-1%
	Case 05	-56%	-4%
	Case 1	-31%	-2%

9 *NE: Negligible Evolution, i.e. < 1%*

10 This table confirms that robust optimization reduces the mean and the variance of the output indicators,
 11 without changing the probability distribution of the uncertain input parameters. In Table 8, the UL
 12 variance is reduced for any considered UL level (cases 0, 01, 05 and 1), as expected because it was part
 13 of its objective functions.

14 Additionally, this reduction has consequences on the other statistical values, as for the case 0. In fact,
 15 the increase of robustness of the UL has a strong impact on the LEC whose mean value and standard
 16 deviation increase. Indeed, to increase the robustness of the UL and reach the autonomy, the sizes of the
 17 components (PV installation and battery bank) are increased. As a first consequence, the LEC increases
 18 – which can be observed by the growth of its mean value. As a second consequence the LEC variance
 19 increases, because each variation on economic parameters has a stronger impact. However, this
 20 evolution is specific to the design obtained to provide a complete satisfaction of the load. For any other

1 design, the performances of the robust design have similar mean value and a lower variability. Focusing
 2 to the case 1, illustrated on Figure 10, with a small increase of the LEC, the load satisfaction and its
 3 robustness can be improved as μ_{UL} and σ_{UL} decrease.

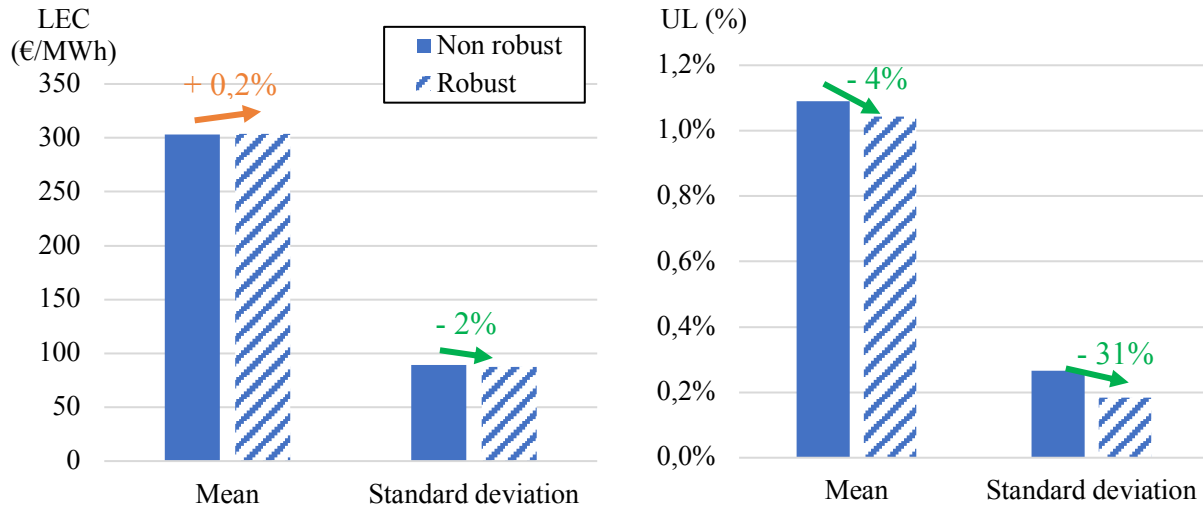

4
 5 *Figure 10 : Comparison for the case 1 of mean value and standard deviation of UL and LEC*
 6 *between the robust and the non-robust designs.*

7 As illustrated on Figure 10, RO succeeds in designing a system taking into account the uncertainties,
 8 while limiting their impact on the system performance indicators (UL and LEC).
 9 RO application to the case study permits also to propose targeted oversized (mainly about the battery
 10 size), leading to more robust design.

11 5. Discussion: Respective contributions of the two approaches

12 Finally, SAA and RO both include the modeling of the system and rely on the uncertainty quantification,
 13 which cannot be avoided. These approaches bring results of heterogeneous nature: namely SAA
 14 proposes statistical values on output results and responsibility shares of uncertain input parameters in
 15 their variability, while RO furnish set of optimization variables. They provide complementary
 16 information for decision-making for robust design of remote microgrid.
 17 However, SAA has no feedback on the optimization process. It mainly brings information on the
 18 following points of interest: (i) what is the impact of the uncertain parameters on the performance
 19 indicators of one system? (ii) which of these uncertain parameters are the most relevant to be better
 20 known to reduce this impact?

1 First, the uncertainty propagation step of the SAA allows the user to estimate the variability of the
 2 performance indicators with their ranges and distributions. In comparison, the classical approach, i.e.
 3 the consideration of the parameters uncertainty only taking into account their range of variations (i.e.
 4 without proper uncertainty quantification step) can provide only the variation ranges of the performance
 5 indicators.

6 Secondly, GSA allows identification of the most influential uncertain parameters on the performance
 7 indicators of the system. In our case study, it turns out that that they are the battery capacity loss for the
 8 UL and the PV CAPEX for the LEC. Therefore, if we propose to reduce by 50% the uncertainty of these
 9 two parameters, the variance of the UL and the LEC should be consequently reduced after a new
 10 uncertainty propagation on the same system designs.

11 The theoretical uncertainty reduction is the division of the probability law support intervals by two but
 12 keeping the same shape of distribution and the same mean value. The resulting new PDF are expressed
 13 in Table 9.

14 *Table 9. Changes of PDF of the most influential parameters identified by the sensitivity analysis.*

Uncertain parameter	Initial PDF	New PDF
Battery capacity loss	U [1.4E-5; 4.2E-5]	U [2.1E-5; 3.5E-5]
PV CAPEX	β [$\alpha = 1.8$; $\beta = 6$; Min = 0.374; Max = 3.165]	β [$\alpha = 1.8$; $\beta = 6$; Min = 0.687; Max = 2.0825]

15
 16 To evaluate the impact of the PDF modification, a new uncertainty propagation is performed. The
 17 standard deviations are calculated and compared (see Table 10) with the corresponding ones resulting
 18 from the initial uncertainty propagation with the same formula than in Table 8.

19 *Table 10. Comparison of standard deviations of performance indicators (LEC and UL) changing the laws of two parameters
 20 identified by the sensitivity analysis.*

		UL	LEC
Standard deviation	Case 0	-67.2%	-38.9%
	Case 01	-67.8%	-38.4%
	Case 05	-54.6%	-37.6%
	Case 1	-41.3%	-39.6%

21

1 For UL and LEC, the variability is much reduced playing on only the PDF of two uncertain parameters.
2 For the UL, the reduction of the standard deviation evolves like the Sobol sensitivity index representative
3 for the battery capacity loss: the impact of the PDF change is the biggest for the design where the Sobol
4 index value is the biggest (case 01).
5 This uncertainty propagation shows that the sensitivity analysis helped identifying the key parameters
6 that the user has to know more accurately in order to reduce the variability of the output. In the case
7 study, the standard deviations of performance indicator are reduced from nearly 40% for the LEC and
8 around a half for the UL, by reducing the uncertainty on only two uncertain parameters. In practice, such
9 an information can be very profitable in order to drive further investigation to gather information on the
10 most uncertain input parameters and to make effort to reduce their dispersions.
11 RO is not suited for the same use: the SAA indicates to the user on which uncertain parameters the focus
12 would be the most interesting, whereas the RO has a practical feedback on the design optimization
13 process. This second approach duly notes that the knowing level cannot always be improved and favor
14 more reliable component. As illustrated in section 4.3, RO permits to limit the uncertainty on a targeted
15 model output.
16 Due to their different natures, the two approaches meet different difficulties and limitations.
17 SAA brings a better knowledge on the uncertainty impact and allows us to identify the key parameters,
18 but it has no practical impact on the system optimization results. The most practical development of this
19 method is then to improve the uncertainty quantification. This improvement is not always possible, in
20 particular when dealing with non-fully mature components, as it is often the case in modern hybrid
21 energy systems with new sustainable technologies.
22 The main limitation of RO is that it requires significant computational resources and/or time. In fact 34
23 CPU-threads has allowed us to perform the 618,000 model evaluations needed in RO in 33 hours in this
24 case study. This important number of model evaluations is due to GA parametrization and convergence
25 speed. GA parametrization population is settled by the population size of the GA and the sampling size
26 of the MC simulation. Convergence speed is fixed by the number of generations needed to converge,
27 which is not decided by the user but imposed by the algorithm. For the same optimization problem, this

1 number of generations is much more important for RO than for NRO. So, as Roberts et al. [20] remarked,
2 when the computational resources or time are limited, other approaches can be better adapted.
3 Another limitation of RO is that it does not necessary reduce the impact of the uncertainty on all the
4 performance indicators of the system but it orients the kind of impact of the uncertainty on the targeted
5 ones. In this work, the variability of UL is reduced, at the price to increase slightly the LEC. It means
6 that the user must accept to let other outputs be deteriorated in order to improve the robustness of some
7 particular ones. This is why in this kind of approach, uncertainty propagation is still required, not only
8 to measure the improvements of the design, but also to estimate potential losses created by RO.

9 6. Conclusion and perspectives

10 This work shows how techno-economic uncertain parameters can be taken into account for designing
11 remote power systems using two approaches: Sensitivity Analysis Approach and Robust Optimization.
12 To take into account these uncertainties in a decision-making process, these complementary approaches
13 are implemented and applied, considering economic and technical parameters of the model as sources
14 of uncertainty.

15 Both approaches start with the inventory of all the techno-economic uncertain parameters of the system.
16 The next shared step to the two approaches is the uncertainty quantification which consists of the
17 attribution of a probability distribution function to each uncertain parameter value. Both also include the
18 modeling of the system, which has been considered here as available thanks to the Odyssey software.
19 The sensitivity analysis approach then uses the result of the non-robust optimization; from the selected
20 designs picked out from the Pareto front. The uncertainties are propagated and a two-stage GSA is
21 performed. Both these steps are implemented through the coupling between Odyssey and Uranie
22 software. This approach brings information on the impact of the uncertainties on the output of the system
23 results and identifies the most influential uncertain parameters in the output dispersion. As for RO,
24 performed thanks to the combination of a GA and MC simulations, this second approach permits to
25 orient the kind of impact of the uncertainty to improve the robustness of chosen performance indicators.
26 The difference of nature of these two approaches constitute their complementary. In fact, they bring
27 different type of results for different needs of the user: the sensitivity analysis approach performed after
28 the optimization gives key information on system parameters that can be used in RO.

1 The applicability of these existing methods is demonstrated on our case study. The two compared
2 approaches are illustrated on the design optimization of the electrical feeding of a stand-alone
3 application located in Nigeria, using PV as the main power source. The GSA teaches us that the most
4 influential uncertain parameter in the UL dispersion is the battery capacity loss and the most influential
5 uncertain parameter in the LEC dispersion is the PV CAPEX. The robust optimization is carried out
6 with the objectives to reduce LEC and UL globally and the dispersion of UL. The obtained
7 configurations are evaluated through uncertainty propagation: it reveals the ability of RO to find
8 optimized configurations responding to targeted robustness criteria. The presented approaches can be
9 applied to any other energy system design, in order to improve the decision-making regarding to the
10 uncertainty impact on it.

11 Regarding future work, several perspectives are considered. First, the GSA and RO could be used
12 including uncertainties on the renewable production resource or energy demand patterns. Next, the
13 contribution of SAA is very useful to reduce the security margins implied by RO, which are expensive.
14 It would be an interesting further work to quantify the avoided over-design of capacities thanks to GSA-
15 targeted uncertainty-source reduction. Finally, the optimization of the operation of the system,
16 complementary to the optimization of its design is also a considered improvement of this work.

1 References

- 2 [1] Tezer T, Yaman R, Yaman G. Evaluation of approaches used for optimization of stand-alone hybrid renewable
3 energy systems. *Renewable and Sustainable Energy Reviews* 2017;73:840–53. doi:10.1016/j.rser.2017.01.118.
- 4 [2] Guinot B, Champel B, Montignac F, Lemaire E, Vannucci D, Sailler S, et al. Techno-economic study of a PV-
5 hydrogen-battery hybrid system for off-grid power supply: Impact of performances' ageing on optimal system
6 sizing and competitiveness. *International Journal of Hydrogen Energy* 2015;40:623–32.
7 doi:10.1016/j.ijhydene.2014.11.007.
- 8 [3] Guinot B, Bultel Y, Montignac F, Riu D, Pinton E, Noirot-Le Borgne I. Economic impact of performances
9 degradation on the competitiveness of energy storage technologies – Part 1: Introduction to the simulation-
10 optimization platform ODYSSEY and elements of validation on a PV-hydrogen hybrid system. *International*
11 *Journal of Hydrogen Energy* 2013;38:15219–32. doi:10.1016/j.ijhydene.2013.08.125.
- 12 [4] Guinot B, Bultel Y, Montignac F, Riu D, Noirot-Le Borgne I. Economic impact of performances degradation on the
13 competitiveness of energy storage technologies – Part 2: Application on an example of PV production guarantee.
14 *International Journal of Hydrogen Energy* 2013;38:13702–16. doi:10.1016/j.ijhydene.2013.08.023.
- 15 [5] Mavrotas G, Florios K, Vlachou D. Energy planning of a hospital using Mathematical Programming and Monte
16 Carlo simulation for dealing with uncertainty in the economic parameters. *Energy Conversion and Management*
17 2010;51:722–31. doi:10.1016/j.enconman.2009.10.029.
- 18 [6] Mavromatidis G, Orehounig K, Carmeliet J. A review of uncertainty characterisation approaches for the optimal
19 design of distributed energy systems. *Renewable and Sustainable Energy Reviews* 2018;88:258–77.
20 doi:10.1016/j.rser.2018.02.021.
- 21 [7] Dufo-López R, Pérez-Cebollada E, Bernal-Agustín JL, Martínez-Ruiz I. Optimisation of energy supply at off-grid
22 healthcare facilities using Monte Carlo simulation. *Energy Conversion and Management* 2016;113:321–30.
23 doi:10.1016/j.enconman.2016.01.057.
- 24 [8] Zheng Y, Jenkins BM, Kornbluth K, Træholt C. Optimization under uncertainty of a biomass-integrated renewable
25 energy microgrid with energy storage. *Renewable Energy* 2018;123:204–17. doi:10.1016/j.renene.2018.01.120.
- 26 [9] Dufo-López R, Fernández-Jiménez LA, Ramírez-Rosado IJ, Artal-Sevil JS, Domínguez-Navarro JA, Bernal-
27 Agustín JL. Daily operation optimisation of hybrid stand-alone system by model predictive control considering
28 ageing model. *Energy Conversion and Management* 2017;134:167–77. doi:10.1016/j.enconman.2016.12.036.
- 29 [10] Moret S, Codina Gironès V, Bierlaire M, Maréchal F. Characterization of input uncertainties in strategic energy
30 planning models. *Applied Energy* 2017;202:597–617. doi:10.1016/j.apenergy.2017.05.106.
- 31 [11] Gabrielli P, Furer F, Mavromatidis G, Mazzotti M. Robust and optimal design of multi-energy systems with
32 seasonal storage through uncertainty analysis. *Applied Energy* 2019;238:1192–210.
33 doi:10.1016/j.apenergy.2019.01.064.
- 34 [12] Bertuccioli L, Chan A, Hart D, Lehner F, Madden B, Standen E. Study on development of water electrolysis in the
35 European Union. E4tech Sàrl and Element Energy Ltd; 2014.
- 36 [13] Ulleberg Ø. The importance of control strategies in PV–hydrogen systems. *Solar Energy* 2004;76:323–9.
37 doi:10.1016/j.solener.2003.09.013.
- 38 [14] Carapellucci R, Giordano L. Modeling and optimization of an energy generation island based on renewable
39 technologies and hydrogen storage systems. *International Journal of Hydrogen Energy* 2012;37:2081–93.
40 doi:10.1016/j.ijhydene.2011.10.073.
- 41 [15] Dursun E, Kilic O. Comparative evaluation of different power management strategies of a stand-alone
42 PV/Wind/PEMFC hybrid power system. *International Journal of Electrical Power & Energy Systems* 2012;34:81–
43 9. doi:10.1016/j.ijepes.2011.08.025.
- 44 [16] Zitzler E, Laumanns M, Thiele L. SPEA2: Improving the strength pareto evolutionary algorithm. Eidgenössische
45 Technische Hochschule Zürich (ETH), Institut für Technische Informatik und Kommunikationsnetze (TIK); 2001.
46 doi:10.3929/ethz-a-004284029.
- 47 [17] Kalinci Y, Hepbasli A, Dincer I. Techno-economic analysis of a stand-alone hybrid renewable energy system with
48 hydrogen production and storage options. *International Journal of Hydrogen Energy* 2015;40:7652–64.
49 doi:10.1016/j.ijhydene.2014.10.147.
- 50 [18] Meschede H, Dunkelberg H, Stöhr F, Peesel RH, Hesselbach J. Assessment of probabilistic distributed factors
51 influencing renewable energy supply for hotels using Monte-Carlo methods. *Energy (Oxford)* 2017;128:86–100.
- 52 [19] Saltelli A, Tarantola S, Campolongo F, Ratto M. *Sensitivity Analysis in Practice: A Guide to Assessing Scientific*
53 *Models*. New York, NY, USA: Halsted Press; 2004.
- 54 [20] Roberts JJ, Marotta Cassula A, Silveira JL, da Costa Bortoni E, Mendiburu AZ. Robust multi-objective optimization
55 of a renewable based hybrid power system. *Applied Energy* 2018;223:52–68. doi:10.1016/j.apenergy.2018.04.032.
- 56 [21] Mavromatidis G, Orehounig K, Carmeliet J. Uncertainty and global sensitivity analysis for the optimal design of
57 distributed energy systems. *Applied Energy* 2018;214:219–38. doi:10.1016/j.apenergy.2018.01.062.
- 58 [22] Moret S. *Strategic energy planning under uncertainty*. École Polytechnique fédérale de Lausanne, 2017.
59 doi:10.5075/epfl-thesis-7961.
- 60 [23] Bouloré A, Struzik C, Gaudier F. Uncertainty and sensitivity analysis of the nuclear fuel thermal behavior. *Nuclear*
61 *Engineering and Design* 2012;253:200–10. doi:10.1016/j.nucengdes.2012.08.017.

- 1 [24] Borgonovo E, Plischke E. Sensitivity analysis: A review of recent advances. *European Journal of Operational*
2 *Research* 2016;248:869–87.
- 3 [25] Groen EA, Bokkers EAM, Heijungs R, de Boer IJM. Methods for global sensitivity analysis in life cycle
4 assessment. *Int J Life Cycle Assess* 2017;22:1125–37. doi:10.1007/s11367-016-1217-3.
- 5 [26] Tian W. A review of sensitivity analysis methods in building energy analysis. *Renewable and Sustainable Energy*
6 *Reviews* 2013;20:411–9. doi:10.1016/j.rser.2012.12.014.
- 7 [27] Campolongo F, Tarantola S, Saltelli A. Tackling quantitatively large dimensionality problems. *Computer Physics*
8 *Communications* 1999;117:75–85. doi:10.1016/S0010-4655(98)00165-9.
- 9 [28] Morris MD. Factorial Sampling Plans for Preliminary Computational Experiments. *Technometrics* 1991;33:161–
10 74. doi:10.2307/1269043.
- 11 [29] Sobol' IM, Tarantola S, Gatelli D, Kucherenko SS, Mauntz W. Estimating the approximation error when fixing
12 unessential factors in global sensitivity analysis. *Reliability Engineering & System Safety* 2007;92:957–60.
13 doi:10.1016/j.rser.2006.07.001.
- 14 [30] Sobol IM. Sensitivity estimates for non linear mathematical models 1993.
- 15 [31] Homma T, Saltelli A. Importance measures in global sensitivity analysis of nonlinear models. *Reliability*
16 *Engineering and System Safety* 1996;52:1–17. doi:10.1016/0951-8320(96)00002-6.
- 17 [32] Saltelli A. Making best use of model evaluations to compute sensitivity indices. *Computer Physics Communications*
18 2002;145:280–97. doi:10.1016/S0010-4655(02)00280-1.
- 19 [33] Zakariazadeh A, Jadid S, Siano P. Stochastic operational scheduling of smart distribution system considering wind
20 generation and demand response programs. *International Journal of Electrical Power & Energy Systems*
21 2014;63:218–25. doi:10.1016/j.ijepes.2014.05.062.
- 22 [34] Pazouki S, Haghifam M-R. Optimal planning and scheduling of energy hub in presence of wind, storage and
23 demand response under uncertainty. *International Journal of Electrical Power & Energy Systems* 2016;80:219–39.
24 doi:10.1016/j.ijepes.2016.01.044.
- 25 [35] Mavromatidis G, Orehounig K, Carmeliet J. Design of distributed energy systems under uncertainty: A two-stage
26 stochastic programming approach. *Applied Energy* 2018;222:932–50. doi:10.1016/j.apenergy.2018.04.019.
- 27 [36] Bertsimas D, Sim M. The Price of Robustness. *Oper Res* 2004;52:35–53. doi:10.1287/opre.1030.0065.
- 28 [37] Moret S, Bierlaire M, Maréchal F. Robust optimization for strategic energy planning. *Informatica* 2016;27:625–48.
29 doi:10.15388/Informatica.2016.103.
- 30 [38] Maggioni F, Potra FA, Bertocchi M. A scenario-based framework for supply planning under uncertainty: stochastic
31 programming versus robust optimization approaches. *Comput Manag Sci* 2017;14:5–44. doi:10.1007/s10287-016-
32 0272-3.
- 33 [39] Maleki A, Khajeh MG, Ameri M. Optimal sizing of a grid independent hybrid renewable energy system
34 incorporating resource uncertainty, and load uncertainty. *International Journal of Electrical Power & Energy*
35 *Systems* 2016;83:514–24. doi:10.1016/j.ijepes.2016.04.008.
- 36 [40] Cantoni M, Marseguerra M, Zio E. Genetic algorithms and Monte Carlo simulation for optimal plant design.
37 *Reliability Engineering & System Safety* 2000;68:29–38. doi:10.1016/S0951-8320(99)00080-0.
- 38 [41] Marseguerra M, Zio E, Podofillini L. Genetic Algorithms and Monte Carlo Simulation for the Optimization of
39 System Design and Operation. Undefined 2007. /paper/Genetic-Algorithms-and-Monte-Carlo-Simulation-for-
40 Marseguerra-Zio/33229f47187eb330748a50a00a8d10fd97e85644 (accessed August 20, 2018).
- 41 [42] The Power to Change: Solar and Wind Cost Reduction Potential to 2025. IRENA. 2016.
- 42 [43] Weckend S, Wade A, Heath G. End-of-Life Management: Solar Photovoltaic Panels. *International Renewable*
43 *Energy Agency and International Energy Agency Photovoltaic Power Systems*; 2016.
- 44 [44] Saur G, Kurtz JM, Dinh HN, Ainscough CD, Onorato S. State-of-the-Art Fuel Cell Voltage Durability and Cost
45 Status: 2018 Composite Data Products. National Renewable Energy Lab. (NREL), Golden, CO (United States);
46 2018. doi:10.2172/1454755.
- 47 [45] Chardonnet C, De Vos L, Genoese F, Roig G, Bart F, De Lacroix T, et al. Study on early business cases for H2 in
48 energy storage and more broadly power to H2 applications. Brussels, Belgium: Tractebel and Hiniçio; 2017.
- 49 [46] Battke B, Schmidt TS, Grosspietsch D, Hoffmann VH. A review and probabilistic model of lifecycle costs of
50 stationary batteries in multiple applications. *Renewable and Sustainable Energy Reviews* 2013;25:240–50.
51 doi:10.1016/j.rser.2013.04.023.
- 52 [47] Electricity Storage and Renewables: Costs and Markets to 2030. IRENA. Abu Dhabi: 2017.
- 53 [48] Riffonneau Y, Barruel F, Bacha S. Problématique du stockage associé aux systèmes photovoltaïques connectés au
54 réseau. *Conférence Internationale sur Les Energies Renouvelables ICRE'07*, Bgayet, Algeria: 2007.