



HAL
open science

Game theory based distributed clustering approach to maximize wireless sensors network lifetime

Sara Kassan, Jaafar Gaber, Pascal Lorenz

► **To cite this version:**

Sara Kassan, Jaafar Gaber, Pascal Lorenz. Game theory based distributed clustering approach to maximize wireless sensors network lifetime. *Journal of Network and Computer Applications (JNCA)*, 2018, 123, pp.80 - 88. hal-02299974

HAL Id: hal-02299974

<https://hal.science/hal-02299974>

Submitted on 29 Sep 2019

HAL is a multi-disciplinary open access archive for the deposit and dissemination of scientific research documents, whether they are published or not. The documents may come from teaching and research institutions in France or abroad, or from public or private research centers.

L'archive ouverte pluridisciplinaire **HAL**, est destinée au dépôt et à la diffusion de documents scientifiques de niveau recherche, publiés ou non, émanant des établissements d'enseignement et de recherche français ou étrangers, des laboratoires publics ou privés.

Game Theory based distributed clustering approach to maximize Wireless Sensors Network lifetime

¹Sara Kassan, ²Jaafar Gaber, ¹Pascal Lorenz

¹Univ. Haute-Alsace UHA, 34 rue Grillenbreit, 68000 Colmar Cedex France, email: {sara.kassan, pascal.lorenz}@uha.fr

²FEMTO-ST Institute, Univ. Bourgogne Franche-Comté UBFC, Univ. Technology Belfort- Montbéliard UTBM, 13 rue E.T.Mieg, 90010 Belfort Cedex France, email: jaafar.gaber@utbm.fr

Abstract— One of the most significant difficulty in Wireless Sensors Network (WSN) is the development of an effective topology control method that can support the quality of the network, respect the limited memory and at the same time increase the lifetime of the network. This paper introduces a new approach by mixing a non-cooperative Game Theory technique with a decentralized clustering algorithm to address the problem of maximizing the network lifetime. More precisely, this approach uses Game Theory techniques to control the activities of a sensor node and its neighbors to limit the number of the forwarding messages and to maximize the lifetime of the sensor's battery. In other words, the approach will decrease the energy consumed by the WSN by decreasing the number of forwarded packets and improve the network lifetime by harvesting energy from the environment. The simulations results show that the performances in terms of energy saving and increasing the number of data packets received by base station outperforms those with distributed based clustering algorithms without GT, such as low energy and location based clustering LELC and LEACH algorithms.

Keywords—WSN; sensor lifetime; energy harvesting; clustering protocols; game theory; equilibrium

1. INTRODUCTION

The WSN has required an important attentiveness in these years. It is implicated widely in different domains, such as health care, ecosystem monitoring, environmental assessing, target tracking, maintaining control, and urban areas applications [1] [2] [3]. The major activities of a sensor node are capturing the data information in its urban environment, aggregate it and forward it to reach the sink using routing protocols. Moreover, the finite batteries capacity implies a limited lifetime of the sensor nodes and their applications. For this problem, several solution techniques have been proposed to prolong the network lifetime. Some of these solutions are based on topology control, routing protocols, data aggregation, forecasting approaches and others [4] [5] [6] [7] [8]. The main tasks of our study is to extend the network lifetime by decreasing the wasted energy during the sensor node activities, and compensate the loss of energy by harvesting environmental energy in the sleeping mode. Our proposed method is based on a non-cooperative MGET in a clustering hierarchical structure.

This approach is divided in two phases. The first one consists to select dynamically the clusters and their clusters heads based on sensors energy and location [9]. In the second phase, the sensor node aggregates the sensing messages by a compression method to save sensor's energy and memory and decided to stay out of the communication to charge its battery in the sleeping mode or to enter the market game and send the message to its neighbors. The suitable decision of the sensor node depends on the probability obtained by maximizing its utility.

In this paper, the rest main contributions are structured as follows:

Section II presents the categories of clustering protocols. In addition, it shows the different types of the GTs, their applications in WSN and the GT principle. In section III, we explain the energy consumed by the different activities of an arbitrary sensor node and the model of sensor's rechargeable battery. In section IV, we adapt a non-cooperative game theory in a decentralized clustering protocol to prolong the WSN lifetime, decrease the wasted energy in the network and increase the number of data information arrived to the BS. The simulation results are presented and investigated in V. Finally, we conclude the paper in section VI.

2. Related work

2.1. Clustering

Clustering protocols are one of the effective techniques of broadcasting for organizing the network and improving its lifetime and . Election of cluster heads (CHs) play a significant role in energy consumption management [10]. Clustering protocols can be categorized in two classes: Centralized [11] and distributed clustering algorithms [12].

2.1.1. Centralized clustering

In centralized clustering, the BS is the organizer to form clusters. At the start of each round, sensors nodes have to transmit their location information and energy status to the BS. The BS will collect all information from all the sensors nodes in the network, select Cluster Heads (CH), and form clusters. This type of clustering is not a very suitable way to do clustering for a large number of sensors or large network wide.

For example, BCDCP (Base-Station Controlled Dynamic Clustering Protocol) is a centralized clustering protocol with a unique BS that is capable of complex computation, the CHs are selected by the BS randomly and all the routes and paths for transmission and reception of data information are selected by the BS [13]. Each node needs to transmit data messages regarding its location and residual energy to the BS during the formation of clusters. Therefore, BCDCP increases the design complexity and the energy consumption of the nodes in the large-range networks. BCSP (Base station Centralized Simple Clustering Protocol) is a protocol where in the BS does not collect any information about location of the sensor nodes but utilizes information about remaining energy of each sensor node and the number of CHs depending on the circumstance of the sensor network [14]. Each node should send its current energy information along with the sensing information, increasing the overhead. The drawback of this protocol is that due to its centralized implementation, it is not so appropriate for sensor networks with a large number of nodes. In addition, without any location information, BCSP cannot guarantee a uniform distribution of CHs nodes and their clusters.

2.1.2. Distributed clustering

Distributed clustering techniques eliminate the need of a centralized station to create CHs and clusters. The low energy and hierarchical structure models are generally used to create clusters and select CHs in two levels. At the first level, there is a selection of CHs and at the second level, the data messages are transferred by sensor nodes to BS via CHs. BS just receives messages and does not control the creation of clusters. EEMDC (Energy Efficient Multi level and Distance aware Clustering) is that extends the WSN lifetime while providing more stability and reliability to the network [15]. This routing protocol splits the network area into three logical layers. After the partition of the network area, the hotspot problem is fixed, the distance between the nodes and the CH and between the CH and the BS are taken into account when considering the hop-count value of the nodes. In addition, CHs are elected by acquiring the average leftover energy of the nodes, and the data messages are delivered to the BS using the shortest distance path to the BS. ICCBP (Inter Cluster Chain Based Protocol) is a new clustering algorithm that uses multi-hop and intra-cluster communication with updating CHs when the existing CHs dissipate their energy [16]. In [17], a new structure to construct clusters and establish connections between sensors is proposed. In this protocol, the distance between CHs depends on a threshold calculated by the signal message transmission to insure the connections between clusters. In addition, this protocol creates a virtual wireless sensor networks. LEACH (Low-Energy Adaptive Clustering Hierarchy) protocol is one of the most popular decentralized clustering protocol based on the homogeneous WSNs [18]. LEACH is a dynamic clustering method that update clusters and head clusters (CH) each round. Each round starts with a setup phase and finishes with steady state. In the setup phase, it rotates the CHs role among all sensor nodes to expend energy uniformly. Each sensor will pick a random number between 0 and 1. If this number is less than a threshold, $T(n)$ that will be defined, the sensor node becomes a CH for the current round. The threshold is set as follows:

$$T(n) = \begin{cases} \frac{p}{1 - p \left(r \times \text{mod} \frac{1}{p} \right)} & \text{for } n \in G \\ 0 & \text{Otherwise} \end{cases} \quad (1)$$

where p is the cluster head probability in the network, r is the current round of election and G is the set of nodes that were not cluster head in the last round. In this paper, we use the clustering approach based on LEACH protocol with strategy based on location and residual energy of a sensor node to select the CHs [19].

2.2. Game Theory

The Game Theory (GT) is extensively applied in economics to maximize the outcomes by using the mathematical models such as the strategic game theory for the differential information economy which players suggest net trades and prices [20]. In the recent years, GT is increasingly applied in WSN for different objectives, such as communication security, energy efficiency, control power transmission, data collection and pursuit evasion [21] [22] [23]. In this section, we review the GT used to enhance the energy conservation and extend the network lifetime. The GT can be classified in two top main categories: cooperative and non-cooperative games.

2.2.1. Cooperative Game Theory based approach

To decrease the energy consumed in the network, some sensor nodes cooperate to form coalitions. The coalitional game is considered as one of the most significant type of cooperative game theory. In [24], a power control game theoretic model is proposed to optimize the trade-off between energy consumption, and data packets transmission performance. It takes in consideration the individual utility of each sensor player. A novel approach is proposed in [25] to identify the overlapping community form in social networks. This approach is based on the shapely values mechanism. It activates with a weight function to find the stable coalitions of underlying community form of the network. The shapely values and the weight function are updated by the community detection algorithm using the local information. Another type of cooperative game is the bargaining game theory. To achieve the two opposite objectives, which are prolonging the WSN lifetime and maintaining the quality of the sensors activities in parallel, a Kalai-Smordinsky Bargaining Solution is used to find the best distribution among coalition members in [26].

2.2.2. Non-Cooperative Game Theory based approach

For the non-cooperative game theory, sensor nodes react selfishly to preserve their residual energy by refusing to receipt a data information and forward it in multi-hop network. The optimal responses for energy efficient non-cooperative game theoretic are obtained when each sensor player improves its strategy to maximize its utility, given the strategies of other sensors players. In [27], a non-cooperative game theory model is proposed to control the transmit power levels and the Nash Equilibrium solution exists and attained according to the channel condition and power level. In addition, a non-cooperative game theory is used in the election of the CHs for the clustering model in [28]. In this game model, the sensor node decides to declare

itself as a CH or not by calculating the optimal probability in the mixed strategy that depends on the maximizing of its payoff.

In addition to the non-cooperative and cooperative game theories, the repeated game theory is involved with a class of active games, in which a game is played for several times and the players have the ability to spot the result of the preceding game before attending the upcoming repetition [29]. In [30], a control scheme based on reinforcement learning and game theory is proposed as a routing game model to provide a packet-forwarding mechanism for underwater wireless sensors network and reduces the energy consumption.

In this paper, we propose a non-cooperative repeated game theory. Mostly, a game theory consists of a set of players, a set of strategies for each player and a set of corresponding utility functions. For a WSN, the sensors are the players, G is a particular game, where $N = \{S(1), S(2), \dots, S(P)\}$ is a finite set of the sensor nodes. $X = \{x(1), x(2), \dots, x(P)\}$ is the vector representation of the strategies taken by the sensors. $U = \{U(x(1)), U(x(2)), \dots, U(x(P))\}$ is the corresponding utility function of node j represented by U_j , U_j ($j = 1, 2, \dots, P$), corresponds to the utility value of each node. This value is obtained at the end of the decision taken by the sensor node $S(j)$. A strategy for a player is a whole organization of decisions in all possible states in the game. The players; sensors effort to act selfishly to maximize their consequences agreeing to their preferences. We have to formulate the utility functions in a way that will help node $S(j)$ to select a strategy that characterizes the best response to its strategies. Every different mixture of individual decisions of strategies can produce a different strategy profile. For a non-cooperative repeated game theory, the solution concept involving N players is obtained when each player has made the best response against the others players decision of probabilities. This solution is named mixed strategy Nash Equilibrium.

3. ENERGY MODEL

3.1. Energy consumption model for a sensor

The energy cost for a sensor depends on the energy consumed to achieve its activities. In this section, we present the different factors that play a main role in the consumption of energy. To determinate the residual energy of a node, it is required to find the total energy consumption of a node in the operating of one data packet information. The notations utilized for the factors causing energy consumption by a sensor node are described in Table 1.

Table 1: Notations definition

Notations	Definition
n	Number of sensor nodes in the network
S_i	Sensor node where $i = \{1, 2, \dots, n\}$
E_S	Sensing energy cost
E_P	Processing energy cost
E_T	Transmitting energy cost
E_R	Receiving energy cost
$E_{Switch-Radio}$	Switching state energy cost in the radio
$E_{Switch-MCU}$	Switching mode energy cost in the MicroController Unit (MCU)
V_{dc}	Voltage supply

C	Total energy consumption
$L(S_i)$	Number of bits information

• Sensing energy consumption

The sensing energy cost depends on the type of sensors. For example, the temperature sensors consumed less important energy than gas sensors. The sensor node can contain diverse sensors, and each one has its individual energy consumption attributes. Generally, the sensing energy consumption for a S_i can be expressed as follows:

$$E_S = L(S_i) \times V_{dc} \times I(S_i) \times T(S_i) \quad (2)$$

where $I(S_i)$ is the needed amount of current, and $T(S_i)$ is the duration to detect and collect $L(S_i)$ bits data information.

• Processing energy consumption

The sensor consumes energy to read the data message and to write it in its memory. The processing energy consumption could be calculated by [31]:

$$E_P = \frac{L(S_i) \times V_{dc}}{8} \times (I_{Write} \times T_{Write} + I_{Read} \times T_{Read}) \quad (3)$$

where I_{Write} and I_{Read} are the necessary amount current to write and read one byte data. T_{Write} and T_{Read} are the necessary duration to treat the $L(S_i)$ data information.

• Communicating energy consumption

The energy consumed to transmit and receive $L(S_i)$ is computed following the first-order wireless communication model for the radio hardware illustrated in fig.1 [32].

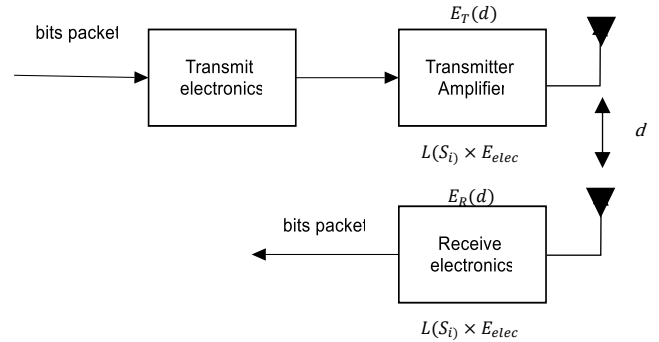

Figure 1. First order radio energy model

Transmitter expends energy to run the radio electronics and the power amplifier. The necessary energy required to transmit $L(S_i)$ bits data message is:

$$E_{T_i} = \begin{cases} L(S_i) \times E_{elec} + L(S_i) \times E_{fs} \times d^2 & \text{when } d < d_0 \\ L(S_i) \times E_{elec} + L(S_i) \times E_{mp} \times d^4 & \text{when } d > d_0 \end{cases} \quad (4)$$

where E_{elec} represents the energy consumed to transmit or receive 1 bit message, the constants E_{fs} and E_{mp} depend on the transmitter amplifier model. E_{fs} is for the free space model, E_{mp}

is for multipath model, d is the transmitter receiver distance and d_0 is a threshold distance calculated as follows:

$$d_0 = \sqrt{E_{fs}/E_{mp}} \quad (5)$$

And the energy consumed by the radio to receive $L(S_i)$ bits data information is defined by:

$$E_{R_i} = L(S_i) \times E_{elec} \quad (6)$$

- *Switching Radio sensor state energy consumption*

The sensor dissipates a significant amount of energy to change from a state (i.e., sensing, processing, transmitting and receiving) i to another j . For the switching states in the radio, the wasted energy can be determined as:

$$E_{Switch-Radio} = \frac{V_{dc}}{2} \times (I_{st_j} - I_{st_i}) \times T_{st_{i,j}} \quad (7)$$

where I_{st_j} is the current draw of the radio in the state switched to, and I_{st_i} is the current draw of the radio in the current state and $T_{st_{i,j}}$ is the necessary time for the radio to switch from state i to j .

- *Switching the microcontroller (MCU) mode energy consumption*

The sensor wastes energy by switching between the MCU modes. In this paper, we just take in consideration the active mode and the sleeping mode. This wasted energy is negligible compared to switching radio energy consumption. The energy cost for the computational MCU mode can be expressed as:

$$E_{Switch-MCU} = V_{dc} \times (I_{Active} \times T_{Active} + I_{Sleep} \times T_{Sleep}) \quad (8)$$

The total energy consumed by each sensor C is defined as follows:

$$C = E_S + E_P + E_{T_i} + E_{R_i} + E_{Switch-Radio} + E_{Switch-MCU} \quad (9)$$

3.2. Rechargeable battery model

The applications of the sensor node are limited by the availability of the power stored in its battery. If the sensor node expends all its energy, it is considered as dead. Moreover, it disturbs the dispatching of the information data to reach the sink. In view of the fact that the replacing of the sensor's battery by a new one and the redeployment of the sensors are very costly, it is not appropriate to change the sensor's battery. To overcome these problems, the sensors nodes can use energy harvesting supplies to recharge their batteries. However, the utilization of renewable energy depends on the network environmental conditions as solar, wind, hydrogen, and hybrid sources [33]. In this article, we considered that the sensor's battery can be recharged from the environment (see Fig.2).

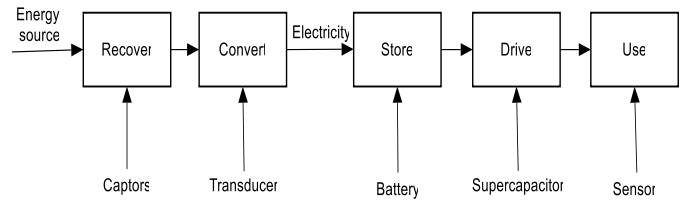

Figure 2. Energy harvesting for WSN model

4. THE PROPOSED APPROACH: GAME THEORY WITHIN CLUSTERING ALGORITHM FOR WSN

The distributed clustering algorithm uses round as unit, each round is made up of set-up phase and steady phase for the purpose of reducing unnecessary energy costs. Set-up phase is for the building of the clusters and the election of the CHs and steady phase is for the sensor's states (see Fig.3).

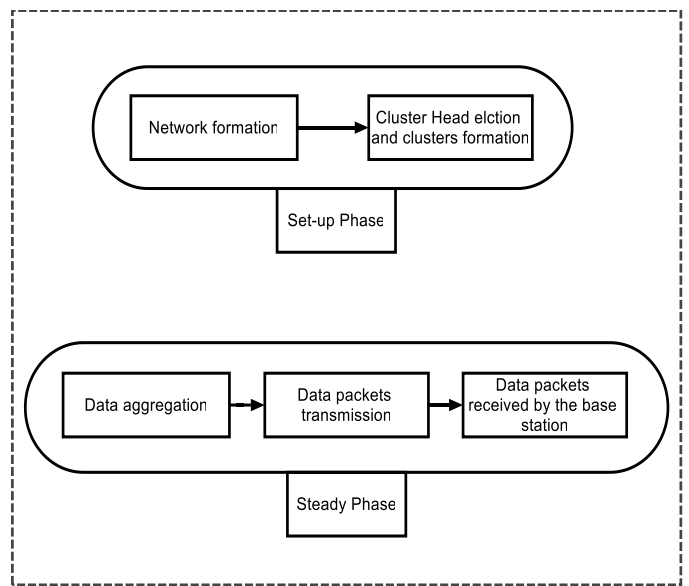

Figure 3. Set-up and steady phases

4.1. Set-up phase

It concerns the formation of the clusters and their heads for each round using sensor location and individual energy consumption [19]. Two CHs cannot be in the same cluster. For this reason, the distance between CHs should be bigger than a threshold distance. The remaining energy level in each sensor node plays an important role in increasing the lifetime of the network. CHs can ensure the link between sensors and the Base Station (BS). For a round, if a CHs is dead, the communications between the sensor nodes in its cluster and the BS are interrupted and no data information from this cluster can reach the BS. A sensor node that has a residual energy bigger than a threshold energy could become a CH for the actual round.

$$E(S_i) > \beta_{opt} \times E_{to\text{sink}} \quad (10)$$

where

$$\beta_{opt} = ((r_{max} - r) \lfloor r_{max} \times (E_{toSink} | E_0(S_i)) \rfloor) \quad (11)$$

where $E(S_i)$ is the residual energy of the sensor S_i , E_{toSink} is the necessary energy for a sensor to transmit a data information to the BS, β_{opt} is the maximum number of data messages that the sensor S_i can send to the BS, r_{max} is the maximum number of rounds (that corresponds to the network lifetime) and r is the actual round.

The proposed set-up phase is illustrated by a flowchart scheme in Fig.4.

For each round, the selection of the CHs is based on the location and residual energy and each non-CH sensor decides to belong the cluster that corresponds to the minimum distance between its location and the CH location. Each cluster has its unique CH that can be updated after each round epochs.

4.2. Steady phase

It corresponds to the data processing, transmitting and receiving between the sensors in the same cluster. This phase is divided in two stages: Data information aggregation and entry market game theory for the communication between neighbors' nodes in the same cluster.

• Data information aggregation

To save the maximum amount of energy consuming during sensors communications and to increase the limited available space in the memory, the data messages are compressed before their registration in the sensor's memory.

If we compress a message of $L(S_i)$ bits to a message of $L(S_i)/a$, the saving energy obtained by compressing the data information can be expressed as follows:

$$E_{saving_i} = [1 - 1/a] \cdot [E_P + E_T + E_R] - E_{compress} \quad (12)$$

where $E_{compress}$ is the energy cost to compress $L(S_i)$ bits data packet message.

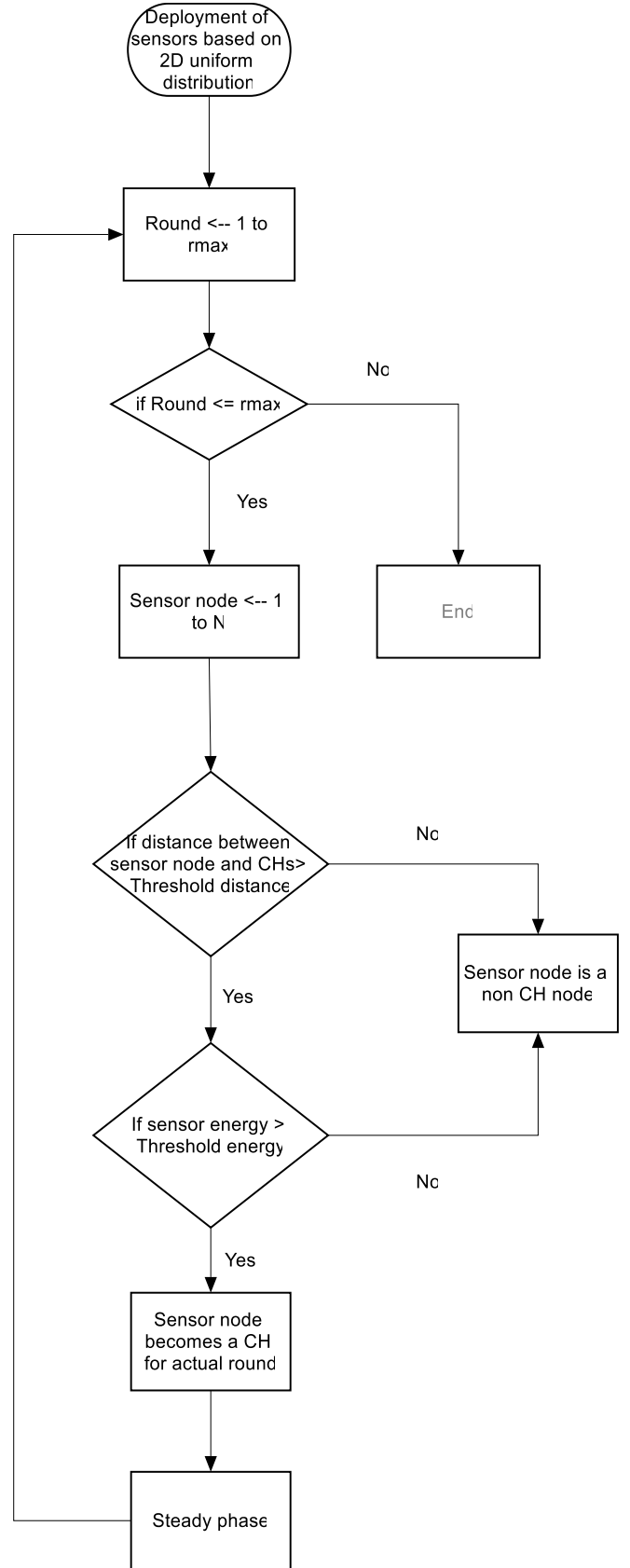

Figure 4. Flowchart for the set-up phase

- *The Game Theory based control*

At this stage, we propose a non-cooperative game theory based algorithm to control the energy consumed by the sensors in the network. This algorithm is called the Profitable Energy Market Game (PEMG) wherein each player has to decide if he wants to participate or to stay out of the market at each round. The market defines trading rules according to a strategy. In this work, the strategy has two actions: to enter the game or to stay out of the game. Each player (i.e. sensor) calculates a payoff that can affect or be affected by the payoffs of other players (i.e. its neighbors). The payoff is a function of the sensor's residual energy. More precisely, the payoffs depend on the players' strategies that stay in the sleeping mode to charge their batteries or enter the game to transmit the sensing data messages.

In what follows, a PEMG is deployed within each cluster. The players in each cluster i are $S_i(j)$ where $j = \{1, 2 \dots N_i\}$ is the current number of sensors in the cluster for the round r , $m_i(k)$ denotes the number of messages sent by a given player $S_i(k)$, M_j is the number of $S_i(j)$ neighbors and $U_i(j)$ is the individual utility function that will be presented later.

The player $S_i(j)$ can take one of two decisions denoted by $x_i(j)$ set to 0 or 1: Entering the game with $x_i(j) = 1$ and participate by sending messages or staying out of the game and harvesting energy to charge its battery with $x_i(j) = 0$. The sensor's decisions can be expressed as follows:

$$x_i(j) = \begin{cases} 1, & S_i(j) \text{ enters the game} \\ 0, & S_i(j) \text{ stays out the game} \end{cases} \quad (13)$$

In this paper, our game model in each cluster is defined by:

$$G_i = \{N_i, M_j, X_i(j)_{j \in N_i}, U_i(j)_{j \in N_i}\} \quad (14)$$

The utility function for a sensor node depends on the cost of the strategy decision taken and it can be expressed by:

$$U_i(x_i(j)) = \begin{cases} g_i(j) - C_i(j), & \text{if } x_i(j) = 0 \text{ and } \exists x_i(k) = 1 \\ g_i(j) + f_i(j), & \text{if } x_i(j) = 0 \text{ for all } j \in M_j \\ 0, & \text{if } x_i(j) = 1 \end{cases} \quad (15)$$

where $i \neq j$, the cost function $C_i(j)$ is the total energy consumed by $S_i(j)$ to send a message, the gain function $g_i(j)$ is its residual energy and $f_i(j)$ is the energy harvested to recharge the sensor's battery.

When a sensor player j selects the action *to enter the game* to transmit messages and its neighbors sensors not then the utility is $g_i(j) - C_i(j)$. The utility is $g_i(j) + f_i(j)$, if the sensor player j decides *not to enter the game* to harvest and charge its battery and that, one of its neighbors enters the game.

In our proposed non-cooperative market entry game, the best response dynamics for the sensors players can be acquired in the context that each sensor node updates its strategy in order to

maximize its utility, given the strategy of its neighbors (i.e., a mixed strategy).

To determine a mixed strategy equilibrium, we need to consider the expected utility of each player. If a randomly node j in the cluster i enters the market with a probability $P_i(j)$, the expected utility of the node j can be expressed as follows:

$$E[U_i(x_i(j))] = P_i(j) \times (g_i(j) - C_i(j)) + (1 - P_i(j)) \times (g_i(j) + f_i(j)) \times \left(1 - \prod_{k \neq j}^{M_j} (1 - P_i(k))\right) \quad (16)$$

It should be noted this expected utility of node j reaches its maximum when the battery of the sensor is full (i.e., the residual energy $g_i(j)$ is at its maximum) and the energy consumption $C_i(j)$ is 0.

The Figure fig.4 shows the variation of the expected utility function for a given sensor j , with the variation of the number of neighbors between 1 and 30 and the variation of the probability to enter the game, e.g., $P_i(j)$ is between 0.1 and 1. We consider that the neighbors have the same probability to enter the game $P_i(k) = 0.3, k \neq j$. Assuming in the simulation that the maximum energy capacity available is $0.5 j$, the result shown in fig.4 shows that the expected utility function has a maximum which is the maximum energy in the sensor's battery.

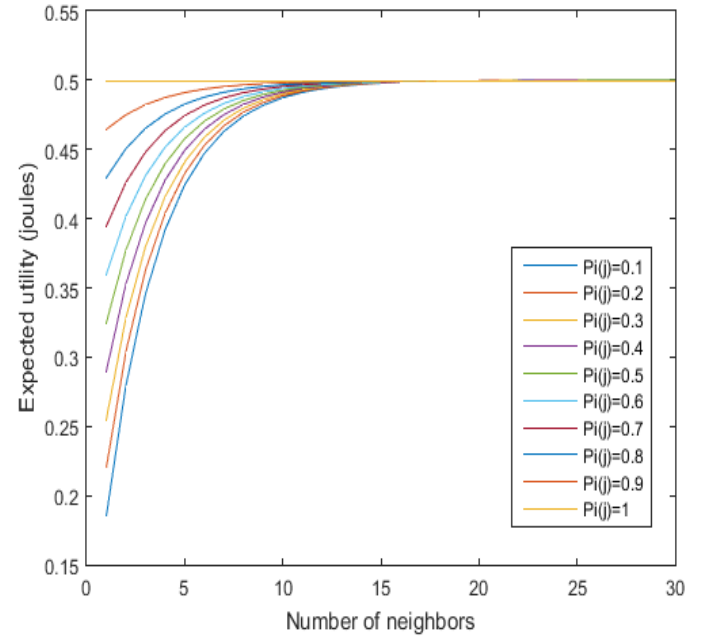

Figure 4. The expected utility function varies with the number of nodes neighbors and the probability $P_i(j)$ and has a maximum that corresponds to the maximum battery capacity.

Since the best response for a sensor node is when its utility reaches its maximum, we derive the expected utility function and the derivation is obtained by:

$$\frac{\partial E[U_i(x_i(j))]}{\partial P_i(j)} = -(C_i(j) + f_i(j)) + (g_i(j) + f_i(j)) \times \prod_{k \neq j}^{M_j} (1 - P_i(k)) \quad (17)$$

Setting the derivation to zero, we get the maximum as follows:

$$\frac{(C_i(j) + f_i(j))}{(g_i(j) + f_i(j))} = \prod_{k \neq j}^{M_j} (1 - P_i(k)) \quad (18)$$

Letting $\alpha_i(j) = \frac{(C_i(j)+f_i(j))}{(g_i(j)+f_i(j))}$ and $q_i(k) = (1 - P_i(k))$, we obtain a system of M_j equations from eq. 18 that can be written as:

$$\begin{cases} \alpha_i(1) = q_i(2) \times q_i(3) \times \dots \times q_i(M_j) \\ \alpha_i(2) = q_i(1) \times q_i(3) \times \dots \times q_i(M_j) \\ \vdots \\ \alpha_i(M_j - 1) = q_i(1) \times \dots \times q_i(M_j - 2) \times q_i(M_j) \\ \alpha_i(M_j) = q_i(1) \times \dots \times q_i(M_j - 2) \times q_i(M_j - 1) \end{cases} \quad (19)$$

which can be rewritten as:

$$\left(\prod_{j=1}^{M_j} (q_i(k)) \right)^{M_j-1} = \prod_{j=1}^{M_j} (\alpha_i(j)) \quad (20)$$

since $q_i(k) = (1 - P_i(k))$, the eq. 20 becomes :

$$\left(\prod_{j=1}^{M_j} (1 - p_i(k)) \right)^{M_j-1} = \prod_{j=1}^{M_j} (\alpha_i(j)) \quad (21)$$

The optimal probability for a given sensor node j in the cluster i to enter the market game can be then expressed as follows:

$$P_i(j) = 1 - \frac{\sqrt[M_j-1]{\prod_{k=1}^{M_j} (\alpha_i(k))}}{\alpha_i(j)} \quad (22)$$

The maximum utility for a sensor player depends on its strategy and also on the combination decisions of all other neighbors players.

The utility matrix for sensor player $S_i(j)$ is shown in Table 2. For the calculation of the utility matrix for each cluster game, the resulting utility coming from the combination of the actions taken by the players (to enter the market game or not to enter the market game) are taken into consideration as indicated by eq.15. If a node player j in the cluster i enters the market, its utility will be $(g_i(j) - C_i(j))$ regardless of the action of its neighbors in this cluster. If none of the nodes in the same cluster enters the market, this means that all the nodes j and their neighbors' nodes are out of energy and cannot find any available energy sources to harvest and charge their batteries.

For this reason, these sensors receive a payoff equal to 0. It is assumed that $(C_i(j) < g_i(j))$, so that at least a node would enter the market if no other sensor node does. However, if one node enters the market, then each of its neighbors would prefer to be selfish and would maximize its residual energy by charging its battery.

Table 2: Symmetric entering market game matrix

	All $S_i(k)$ do not enter the market	At least one enters the market
$S_i(j)$ enters the market	$g_i(j) - C_i(j)$	$g_i(j) - C_i(j)$
$S_i(j)$ doesn't enter the market	0	$g_i(j) + f_i(j)$

Let $X = \{x_i(1), \dots, x_i(M_j)\}$ be the vector representation of the strategies played by the sensors.

The utility matrix for $S_i(j)$ can be written as follows:

$$U_i(j) = \begin{bmatrix} (g_i(j) - C_i(j)) & (g_i(j) - C_i(j)) \\ 0 & (g_i(j) + f_i(j)) \end{bmatrix} \quad (23)$$

In a symmetrical market game, the strategy that a sensor player and its neighbors decide to enter the game market, i.e., $X = \{1 \dots 1\}$, or the strategy that a sensor player and its neighbors decide to charge their battery in the sleeping mode, i.e., $X = \{0 \dots 0\}$, are not Nash equilibria. Indeed, it is impossible for each node to find out a best response to the strategy decisions. Namely, no pure-strategy Nash Equilibrium exists in our game. However, to permit the entry market game to have symmetrical Nash equilibria, the players can adopt mixed strategies. For any node, as $(g_i(j) - C_i(j)) > 0$, the sensors players do not have a dominant strategy. We assumed that each sensor player is allowed to choose its strategy decisions randomly following a probability distribution. In other words, there are M_j mixed strategies Nash equilibria in the game and the best responses are obtained when the utility of a node j to enter the market is equal to the utility of the node j to stay out of the market and thus we can compute the equilibrium probability from the table 2 by:

$$U_i(x_i(j) = 0) = U_i(x_i(j) = 1) \quad (24)$$

$$(g_i(j) - C_i(j)) \times p = (g_i(j) + f_i(j)) \times (1 - (1 - p)^{M_j-1}) \quad (25)$$

Therefore, from the above eq. 25, we can calculate the equilibrium probability P_E to enter the game for a M_j Nash equilibrium with a mixed strategies as follows:

$$P_{E_i}(j) = 1 - \left(1 - \frac{(g_i(j) - C_i(j))}{(g_i(j) + f_i(j))} \right)^{\frac{1}{M_j-1}} \quad (26)$$

since we have $0 < \frac{(g_i(j)-C_i(j))}{(g_i(j)+f_i(j))} < 1$. Subsequently, from the eq. 26, we can notice that the probability decreases when the

number of neighbors players increases. For example, in the limiting cases, while $(M_j - 1)$ is varying from 1 to infinity, the probability of entering the market game will be changing from 1 to 0.

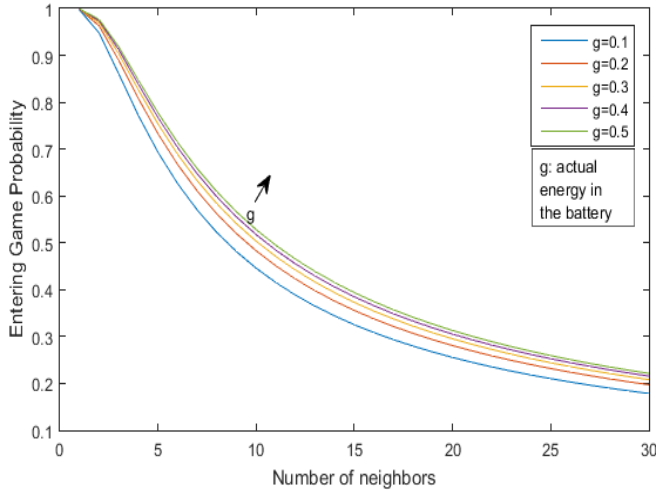

Figure 5. Entering game probability varies with the number of nodes neighbors for a Nash Equilibrium mixed strategies

Fig. 5 depicts the entering game probability that is given in Eq. 26 with increasing number of neighbors of the source, from 1 to 30, for different values of actual energy in the battery $g_i(j)$. When the number of neighbors decreases (from 30 to 1) when some neighbors nodes dead, the forwarding entering game probability increases.

5. SIMULATION RESULTS

For our experiments, we used 200 sensor nodes in our network, where nodes are randomly distributed in 1000x1000 m² area. The BS is deployed at the center of the area. For the simulations, a sensor node considers another sensor as a neighbor if the distance that separate them is lower than a threshold D . This threshold D is the maximum radius with which a sensor can receive a fixed number of bits for a fixed power transmission.

Table 3: Simulation parameters

Parameter	value
Network area (m ²)	100×100
BS location	(50, 50)
Number of sensor nodes n	200
Initial energy (J) E_0	0.5
E_{elec} (nJ/bit)	50
parameters of amplifier energy consumption E_{mp} (pJ/bit/m ⁴) and E_{fs} (pJ/bit/m ²)	0.0013 and 10
Data aggregation energy (J)	5×10^{-12}
Size of data packet (bits) F	4000
Number of bits transmitted by sensor (bits) L	2500
Compression percentage (%)	20

Parameter	value
Round epochs τ_{max}	5000, 10000
Proper percentage of CH nodes (%) p	5
Distance (m) D	10

In Fig.6, we compare the energy consumed by the network for 7000 rounds by comparing our proposed approach with other protocols from the literature: the LEACH clustering protocol [18] and a clustering based protocol [19]. The results show that these Leach protocol consumes all its energy after 2000 rounds. An improved version of Leach via a low energy and location based clustering approach (LELC) presented in [19] stills have energy for 5000 rounds. Fig.6 shows also the results of the two versions of the proposed PEMG with Game Theory (GT), Popt GT and Pnash GT, according respectively to Eq.22 (optimal probability) and Eq.26 (Nash equilibrium probability). The either PEMG versions extend the lifetime of the network beyond 7000 rounds. The results show also that Popt GT consumes less energy than the PEMG with Nash probability Pnash GT.

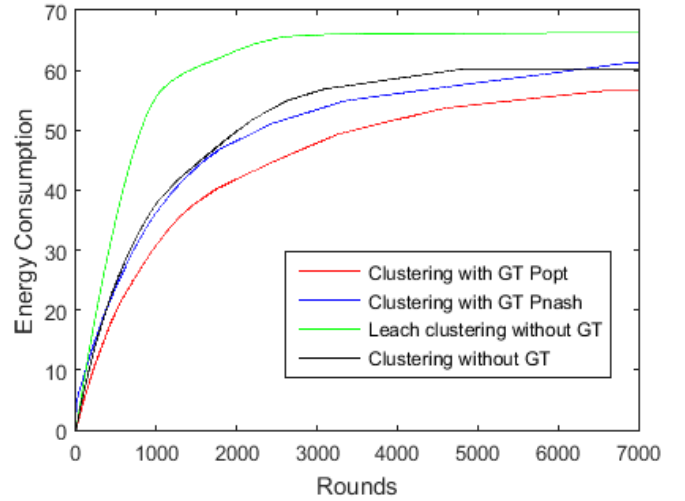

Figure 6. Energy Consumption by the network

The figure fig.7 shows the evolution of number of dead sensors. For Leach clustering protocol, the majority of sensor nodes are died before 2000 rounds of time. At the same time, with LELC clustering protocol, the number of dead sensors is less than the half of the number of dead sensor nodes in Leach protocol. Moreover, when the WSN is dead, after 5000 rounds, the number of dead nodes is 120. It stills less than the dead nodes in Leach protocol after 2000 rounds.

In the case of Pnash GT, the number of dead nodes is the half of the total number after 7000 rounds (i.e., 50%), while in the case of Popt GT and LELC without GT, 60% of the initial number of sensors are dead. This is mainly because of our GT based protocols provide the harvesting option to the sensors. Moreover, with Popt GT, the strategy taken by a sensor privilege the action to enter the market and thus sending messages, i.e., maximizing the strategy of communicating messages via Popt maximization. However, for Pnash GT, all the strategies taken by the sensor are equally probable.

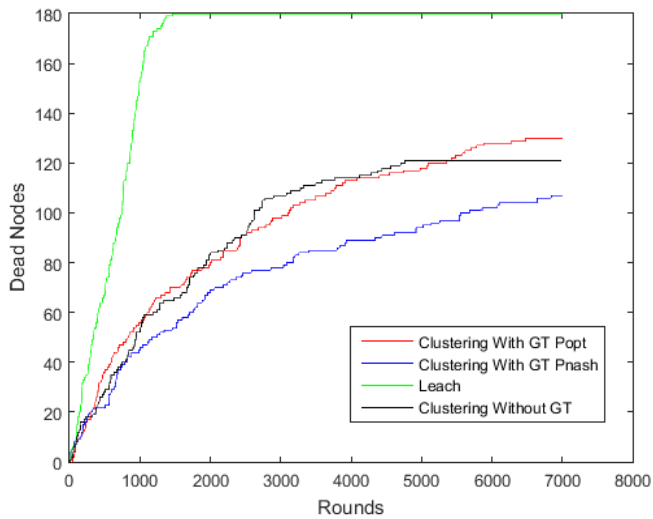

Figure 7. Dead Nodes in the network

The simulation results reported in Fig.8 show that the number of packets received by the BS for PEMGT with Pnash in our clustering protocol is more important than all the other approaches and that the network is still active after 7000 rounds. However, in the case of clustering without any GT, the network lifetime is limited to 5000 rounds. In addition, the small difference in energy consumed by the network between Pnash and Popt in PEMGT is justified by the number of packets information that reach the BS and the extension of the network lifetime.

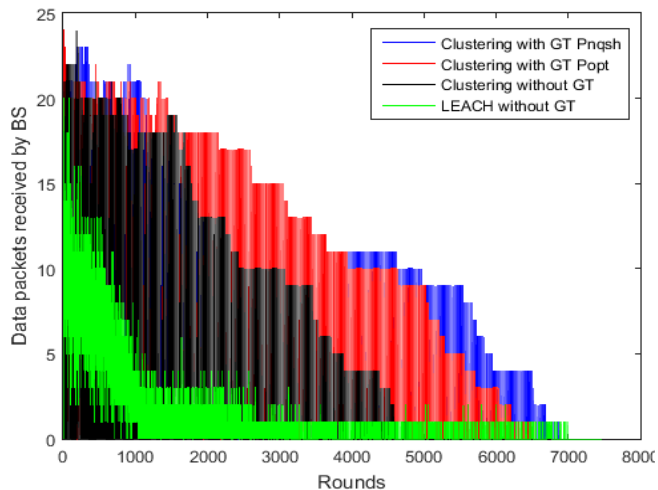

Figure 8. Number of Data Packets received by the BS. With Pnash GT, the network is still active as the packets continue to be received by BS beyond the other protocols.

6. CONCLUSION

In this paper, a clustering based protocol using a non-cooperative game theory (GT) approach is proposed with the aims to prolong WSN lifetime. The GT permits to a sensor to decide between two actions: to enter the game and transmit a message or to stay out the game and harvest to charge its battery. For the network organization, a clustering protocol

based on sensors locations and energy consumptions is used and a GT based algorithm is deployed within each cluster. The objective is to find out the Nash Equilibrium (NE) solution for mixed strategies. The simulation results show that the proposed approaches outperforms those without GT in terms of energy consumption, nodes and network lifetimes. In other words, combining a GT based approach with a clustering protocol provides an efficient solution for energy harvesting to prolong WSNs lifetime. The future work will focus on the control of the energy harvesting process in the sensors.

ACKNOWLEDGMENT

The authors would like to thank the editors and reviewers for their valuable comments on earlier versions of this paper.

REFERENCES

- [1] H. Alemdar and C. Ersoy, "Wireless sensor networks for healthcare: A survey," *Computer networks*, Elsevier, vol. 54, no. 15, pp. 2688-2710, October 2010.
- [2] J.J. Fernández-Lozano, M. Martín-Guzmán, J. Martín-Ávila, and A. García-Cerezo, "A Wireless Sensor Network for Urban Traffic Characterization and Trend Monitoring", *Sensors*, MDPI, vol. 15, no. 10, pp. 26143-26169, 2015.
- [3] L. Muduli, D. P. Mishra and P. K. Jana, "Application of wireless sensor network for environmental monitoring in underground coal mines: A systematic review," *Journal of Network and Computer Applications*, Elsevier, vol. 106, pp.87-97, March 2018.
- [4] O. Yalgashev, J. Gaber, M. Bakhouya, A. Nait-Sidi-Moh, "Wireless sensors networks: basics and fundamentals," the book *Cyber-Physical System Design with Sensor Networking Technologies*, ISBN, pp. 978-1, 2016.
- [5] Muhsin Atto, Chris Guy, "Routing Protocols for Structural Health Monitoring of Bridges Using Wireless Sensor Networks," *Network Protocols and Algorithms*, vol. 7, no. 01, pp. 01-23, 2015.
- [6] A. A. Aziz, Y. A. Sekercioglu, P. Fitzpatrick and M. Ivanovich, "A Survey on Distributed Topology Control Techniques for Extending the Lifetime of Battery Powered Wireless Sensor Network," *IEEE communications surveys & tutorials*, vol. 15, no. 01, pp.121-144, 2013.
- [7] A. Syarif, A. Abouaissa and P. Lorenz, "Operator calculus approach for route optimizing and enhancing wireless sensor network," *Journal of Network and Computer Applications*, Elsevier, vol. 97, pp. 1-10, November 2017.
- [8] E. Fasolo, M. Rossi, J. Widmer and M. Zorzi, "In-network aggregation techniques for wireless sensor networks: a survey," *IEEE Wireless Communications*, vol. 14, no. 2, pp. 70-87, April 2007.
- [9] I. Ullah, R. Ahmad and D. Kim, "A Prediction Mechanism of Energy Consumption in Residential Buildings Using Hidden Markov Model," *Energies*, vol. 11, no.02, pp. 1996-1073, February 2018.
- [10] J Lloret, M Garcia, D Bri, JR Diaz, "A cluster-based architecture to structure the topology of parallel wireless sensor networks," *Sensors*, MDPI, vol. 9, no. 12, pp.10513-10544. 2009.
- [11] S. Muruganathan, D. C. F. Ma and R. I. Bhasin, "A centralized energy-efficient routing protocol for wireless sensor networks," *IEEE Communications Magazine*, vol. 43, no. 3, pp. 08-13, 2005.
- [12] I. Bukhari, A. Harwood and S. Karunasekera, "Optimum Benefit Protocol: A fast converging, bandwidth-efficient decentralized similarity overlay," *Journal of Parallel and Distributed Computing*, vol. 109, pp.129-141, 2017.
- [13] S. Mehta, S. Vhatkar and M. Atique, "Comparative Study of BCDCP protocols in Wireless sensor network," in *International Conference and Workshop on Emerging Trends in Technology*, Maharashtra, India, 2015.
- [14] M. A. Jan, P. Nanda, and X. He, *Energy Evaluation Model for an Improved Centralized Clustering Hierarchical Algorithm in WSN*, International conference on *Wired/Wireless Internet Communication (WWIC)*, Springer, vol. 7889, pp.154-167, Berlin, Heidelberg, 2013.

- [15] A. Mehmood, S. Khan, B. Shams and J. Lloret, "Energy-efficient multi-level and distance-aware clustering mechanism for WSNs," *International Journal of Communication Systems* 28 (5), 972-989, 2015.
- [16] S. Rani, R. Talwar, J. Malhotra, S. H. Ahmed, M. Sarkar and H. Song, "ICCBP: Inter Cluster Chain Based Protocol with Cross Layer Interaction for Randomly Deployed Wireless Sensor Networks," *Ad hoc and Sensor Wireless Networks*, vol. 36, pp. 257-284, 2017.
- [17] N. Mittal, U. Singh and B. S. Sohi, "Harmony Search Algorithm Based Threshold-sensitive Energy-Efficient Clustering Protocols for WSNs," *Ad hoc and Sensor Wireless Networks*, vol. 36, pp. 149-174, 2017.
- [18] F. Xiangning and S. Yulin, "Improvement on LEACH Protocol of Wireless Sensor Network," *International Conference on Sensor Technologies and Applications (SENSORCOMM 2007)*, pp. 260-264, Valencia, 2007.
- [19] S. Kassan, P. Lorenz and J. Gaber, "Low energy and location based clustering protocol for Wireless Sensor Network," *International Conference on communication*, Kansas, 2018.
- [20] G. Fugarolas-Alvarez-Ude, C. Hérves-Beloso, E. Moreno-García and J. P. Torres-Martínez, "A market game approach to differential information economies," *Economic Theory*, vol. 38, no. 2, pp. 321-330, February 2009.
- [21] S. Shen, H. Ma, E. Fan, K. Hu, S. Yu, J. Liu and Q. Cao, "A non-cooperative non-zero-sum game-based dependability assessment of heterogeneous WSNs with malware diffusion," *Journal of Network and Computer Applications*, Elsevier, vol. 91, pp. 26-35, August 2017.
- [22] T. Alskaf, M. G. Zapata, and B. Bellalta, "Game Theory for Energy Efficiency in Wireless Sensor Networks: Latest Trends," *Journal of Network and Computer Applications*, vol. 54, pp. 33-61, 2015.
- [23] H. Y. Shi, W. L. Wang, N. M. Kwok and S. Y. Chen, "Game Theory for Wireless Sensor Networks: A Survey," *Sensors*, vol. 12, pp. 9055-9097, 2012.
- [24] sD. Wu, Y. Cai, L. Zhou and J. Wang, "A Cooperative Communication Scheme Based on Coalition Formation Game in Clustered Wireless Sensor Networks," *IEEE Transactions on Wireless Communications*, vol. 11, no. 3, pp. 1190-1200, March 2012.
- [25] A. Jonnalagadda, L. Kuppasamy, "A cooperative game framework for detecting overlapping communities in social networks," *Physica A: Statistical Mechanics and its Applications*, vol. 491, pp. 498-515, 2018.
- [26] C. D. Truong, M. A. Khan, F. Sivrikaya and S. Albayrak, "Cooperative game theoretic approach to energy-efficient coverage in wireless sensor networks," *Seventh International Conference on Networked Sensing Systems (INSS)*, Kassel, pp. 73-76, 2010.
- [27] S. Sengupta, M. Chatterjee and K. Kwiat, "A Game Theoretic Framework for Power Control in Wireless Sensor Networks," *IEEE Transactions on Computers*, vol. 59, no. 2, pp. 231-242, February. 2010.
- [28] L. Yang, Y. Lu, L. Xiong, Y. Tao and Y. Zhong, "A Game Theoretic Approach for Balancing Energy Consumption in Clustered Wireless Sensor Networks," *Sensors*, vol. 17, pp. 2654, 2017.
- [29] D. T. Hoang, X. Lu, D. Niyato, P. Wang, D. I. Kim and Z. Han, "Applications of Repeated Games in Wireless Networks: A Survey," *IEEE Communications Surveys & Tutorials*, vol. 17, pp. 2102 - 2135, 2015.
- [30] S. Kim, "A better-performing Q-learning game-theoretic distributed routing for underwater wireless sensor networks," *International Journal of Distributed Sensor Networks*, Sage Journals, vol. 14, no.01, pp. January 2018.
- [31] B. Pati, J. L. Sarkar and C. R. Panigrahi, "An Energy-Efficient Approach to Select Cluster-Head in Wireless Sensor Networks," *Arabian Journal for Science and Engineering*, Springer, vol. 42, no.02, pp. 669-676, 2017.
- [32] W. R. Heinzelman, A. Chandrakasan and H. Balakrishnan, "Energy-Efficient Communication Protocol for Wireless Microsensor Networks," *Hawaii International Conference on System Sciences*, Hawaii, 2000.
- [33] C. Knight, J. Davidson and S. Behrens, "Energy Options for Wireless Sensor Nodes," *Sensors*, MDPI, vol. 8, pp. 8037-8066, 2008.

