



HAL
open science

PRINCIPLES OF KELVIN PROBE FORCE MICROSCOPY AND APPLICATIONS

Laurent Nony

► **To cite this version:**

Laurent Nony. PRINCIPLES OF KELVIN PROBE FORCE MICROSCOPY AND APPLICATIONS. Doctoral. 2nd German-French summer school on noncontact-AFM Osnabrück, 12th-16th of September 2016, Germany, Germany. 2016. hal-02299042

HAL Id: hal-02299042

<https://hal.science/hal-02299042>

Submitted on 27 Sep 2019

HAL is a multi-disciplinary open access archive for the deposit and dissemination of scientific research documents, whether they are published or not. The documents may come from teaching and research institutions in France or abroad, or from public or private research centers.

L'archive ouverte pluridisciplinaire **HAL**, est destinée au dépôt et à la diffusion de documents scientifiques de niveau recherche, publiés ou non, émanant des établissements d'enseignement et de recherche français ou étrangers, des laboratoires publics ou privés.

PRINCIPLES OF KELVIN PROBE FORCE MICROSCOPY AND APPLICATIONS

Laurent NONY

Aix-Marseille Université, Faculté des Sciences, site Etoile - Saint-Jérôme
IM2NP, UMR CNRS 7334
Marseille, France

laurent.nony@im2np.fr

2nd German-French summer school on noncontact-AFM
Osnabrück, 12th-16th of September 2016, Germany



Institut Matériaux Microélectronique Nanosciences de Provence
UMR CNRS 7334, Universités Aix-Marseille et Sud Toulon-Var



Outline

I. INTRODUCTION

- Electrostatic forces & Contact Potential Difference (CPD)

II. PRINCIPLES OF KPFM

- Concepts
- FM-KPFM operational mode

III. ELECTROSTATIC MODELS

- Generic approach to F^{el}
- Examples of models



IV. EXAMPLES OF APPLICATIONS

- Long-range regime
- Short-range regime

CONCLUSION

Before starting...

☐ There will be color...

- ✓ Slides marked with  are to be understood
- ✓ Slides marked with  can conceptually be accepted and be understood later
- ✓ Slides marked with  address more complex concepts. Use the related references to get into them and take your time

☐ Slides including the symbol won't be addressed during that

lecture (section IV)

- ✓ They may contain relevant information for you, though
- ✓ They remain included in the flow of slides as they are thematically relevant

I. Introduction



Institut Matériaux Microélectronique Nanosciences de Provence
UMR CNRS 7334, Universités Aix-Marseille et Sud Toulon-Var



Electrostatic force: macroscopic concept

□ Parallel-plate capacitor:

□ Capacitance C :

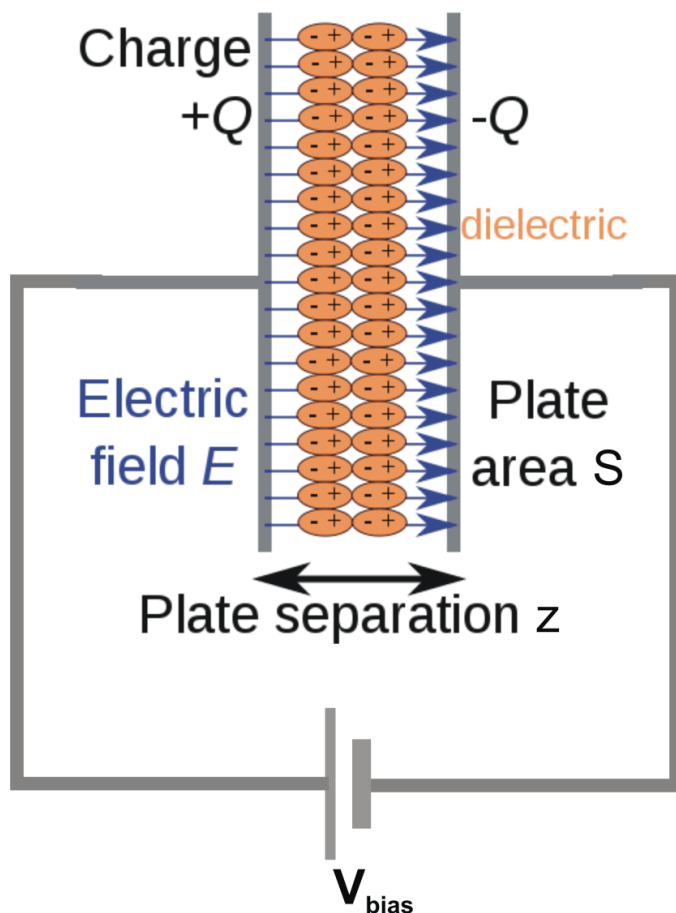

$$C = \frac{\epsilon_0 \epsilon_r S}{z} = \frac{Q}{V_{\text{bias}}}$$

(Eq. 1)

Electrostatic force: macroscopic concept



William Thomson (later Lord Kelvin of Largs):
1824 (Belfast, Ireland) - 1907 (Largs, UK)

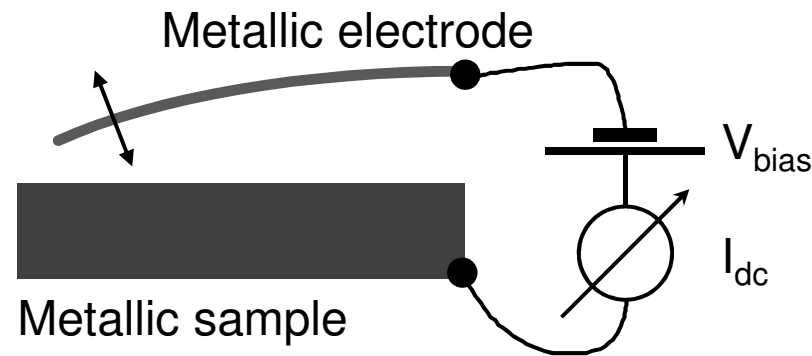

$$I_{\text{dc}} = \frac{dC}{dt} (V_{\text{bias}} - V_{\text{offs}})$$

*Lord Kelvin, *Phil. Mag.* **46**, 82 (1898)

Electrostatic force: macroscopic concept

- Electrostatic force acting on the plates of a charged parallel-plate capacitor (no inner charges or dipoles):

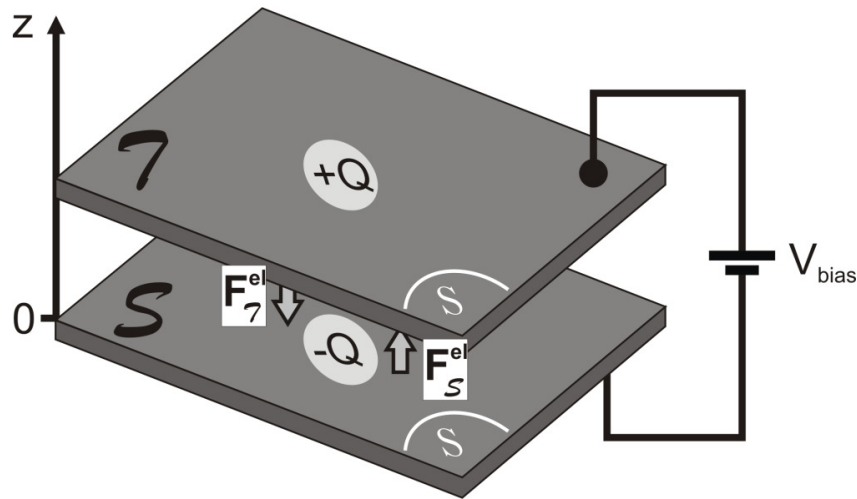

Electrostatic energy supplied to the capacitor:

$$W^{\text{el}} = -\frac{1}{2} Q V_{\text{bias}} = -\frac{1}{2} C V_{\text{bias}}^2 \quad (\text{Eq.2})$$

$$\mathbf{F}_{\mathcal{T}}^{\text{el}} = -\frac{\partial W^{\text{el}}}{\partial z} \hat{\mathbf{z}} = -\frac{1}{2} \left| \frac{\partial C}{\partial z} \right| V_{\text{bias}}^2 \hat{\mathbf{z}} \quad (\text{Eq.3})$$

Attractive!

Here:
$$\mathbf{F}_{\mathcal{T}}^{\text{el}} = -\frac{1}{2} \frac{\epsilon_0 \epsilon_r S}{z^2} V_{\text{bias}}^2 \hat{\mathbf{z}}$$

$\epsilon_r = 1, S = 1 \mu\text{m}^2, z \sim 2 \text{ nm}; V_{\text{bias}} = 0.1 \text{ V} \Rightarrow |\mathbf{F}^{\text{el}}| \sim 10 \text{ nN} !$

Electrostatic forces are conditionnally large!

Electrostatic force: macroscopic concept

- Electrostatic force acting on the plates of a charged parallel-plate capacitor (no inner charges or dipoles):

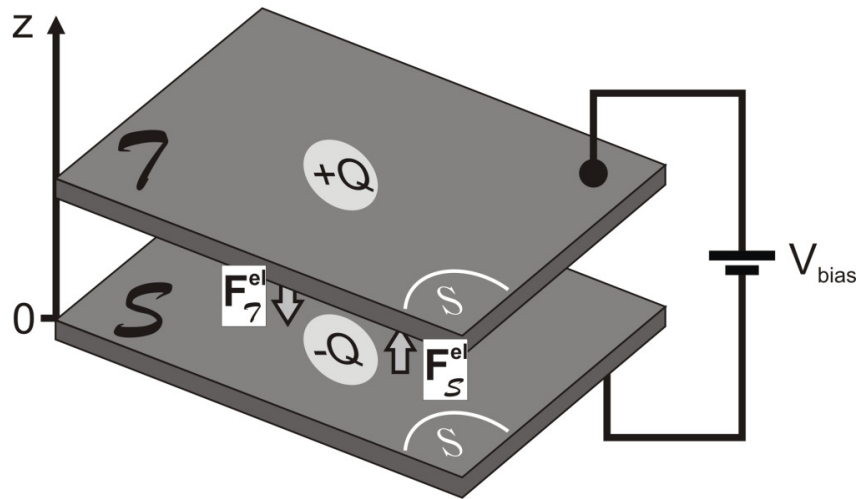

Electrostatic energy supplied to the capacitor:

$$W^{\text{el}} = -\frac{1}{2} Q V_{\text{bias}} = -\frac{1}{2} C V_{\text{bias}}^2 \quad (\text{Eq.2})$$

$$\mathbf{F}_{\mathcal{T}}^{\text{el}} = -\frac{\partial W^{\text{el}}}{\partial z} \hat{\mathbf{z}} = -\frac{1}{2} \left| \frac{\partial C}{\partial z} \right| V_{\text{bias}}^2 \hat{\mathbf{z}} \quad (\text{Eq.3})$$

Attractive!

Parabola-like behavior

Bias-free short-range components ~ 10 pN

~ -10 nN

Electrostatic force: macroscopic concept

- Electrostatic force acting on the plates of a charged parallel-plate capacitor (no inner charges or dipoles):

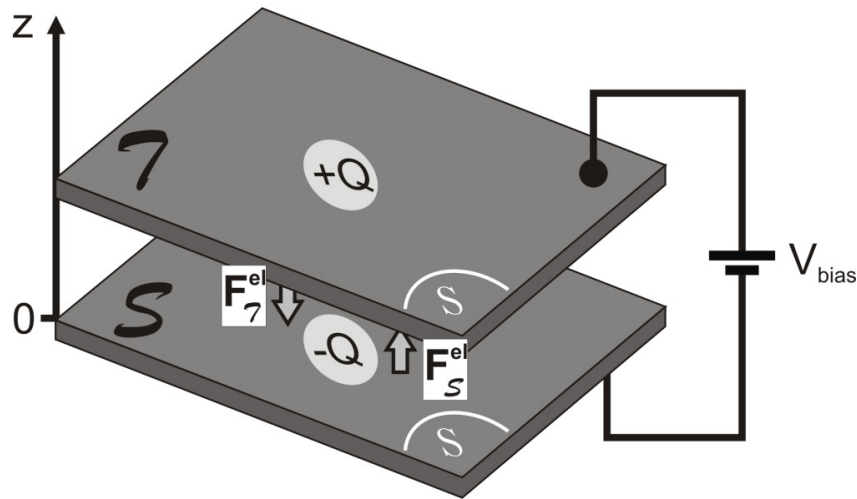

Electrostatic energy supplied to the capacitor:

$$W^{\text{el}} = -\frac{1}{2} Q V_{\text{bias}} = -\frac{1}{2} C V_{\text{bias}}^2 \quad (\text{Eq.2})$$

$$\mathbf{F}_{\mathcal{T}}^{\text{el}} = -\frac{\partial W^{\text{el}}}{\partial z} \hat{\mathbf{z}} = -\frac{1}{2} \left| \frac{\partial C}{\partial z} \right| V_{\text{bias}}^2 \hat{\mathbf{z}} \quad (\text{Eq.3})$$

- Electrostatic force acting on an electrode of any kind:

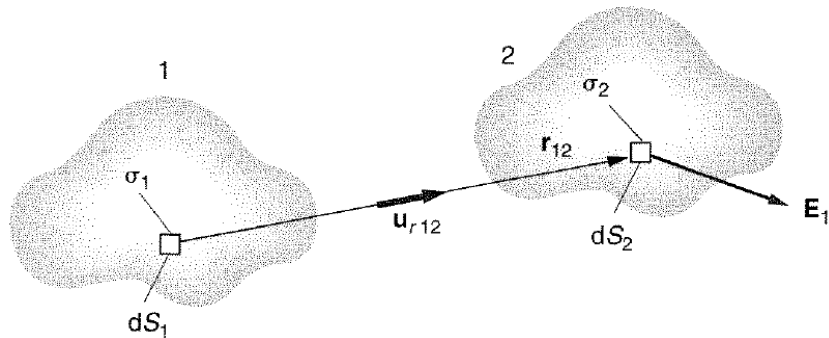

$$\mathbf{F}_{1 \rightarrow 2}^{\text{el}} = - \oint_{S_2} \sigma_2 dS_2 \mathbf{E}_1$$

Work function in metals

K. Wandelt, *Appl. Surf. Sci.* 111, 1 (1997)

"The work function ϕ of an **infinite homogeneous metal** surface is defined as the energy difference between... the Fermi level... and a final state... the so called vacuum level."

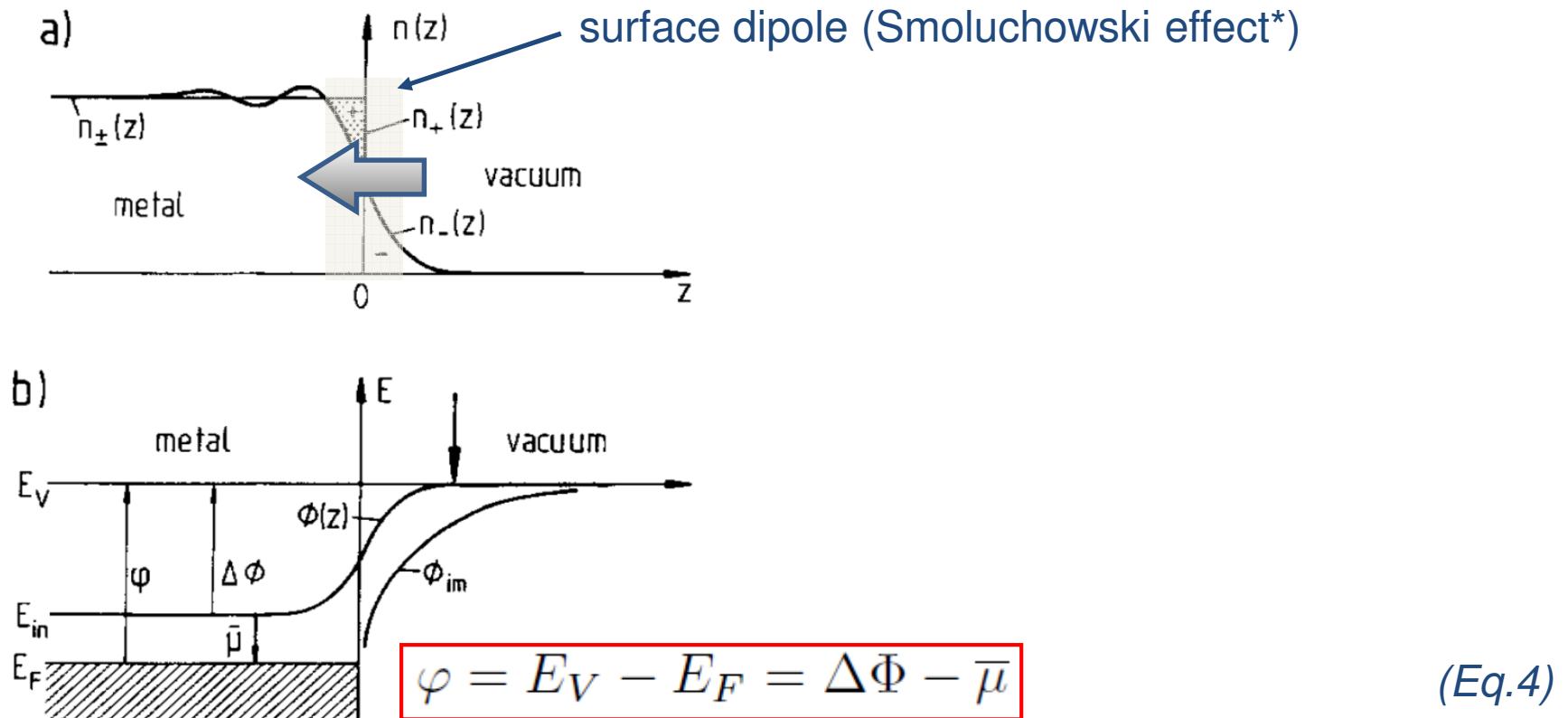

* *Physics of surfaces and interfaces*, H. Ibach, Springer 2006.

Electrostatic force and Contact Potential Difference (CPD)

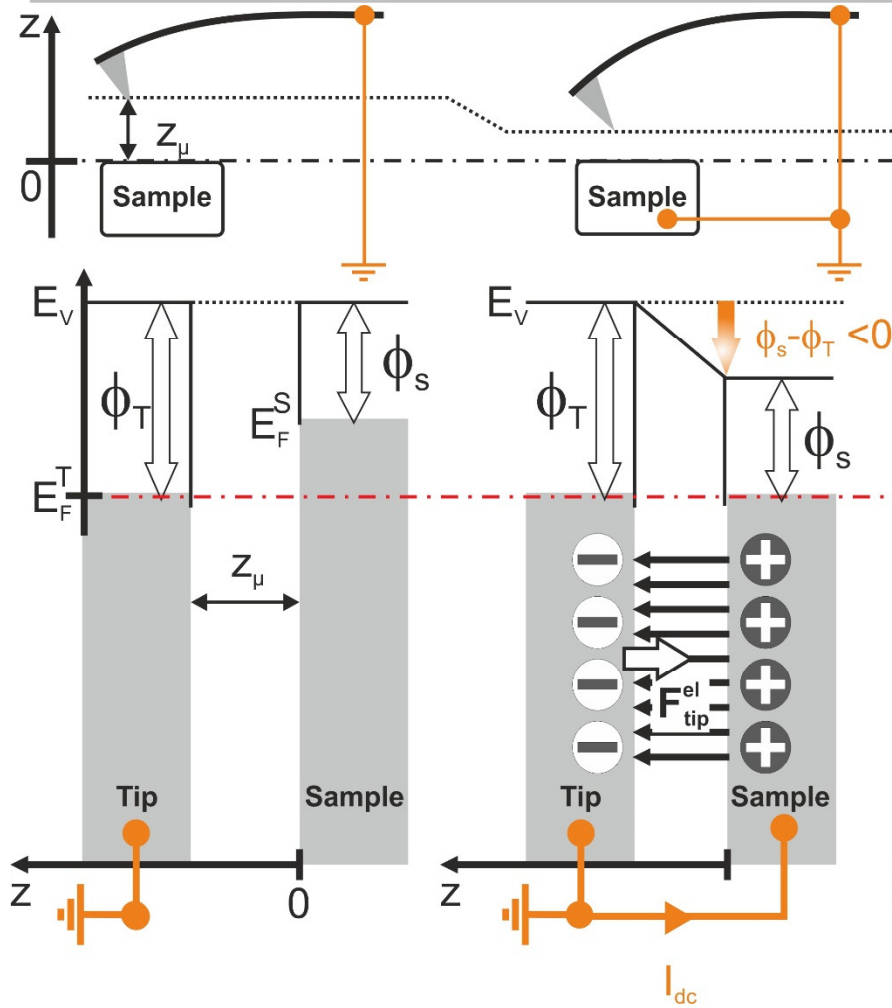

$$V_{CPD} = \frac{\Delta\Phi}{|e|} = \frac{\Phi_{sample} - \Phi_{tip}}{|e|}$$

(Eq.5)

NB: here, $V_{CPD} < 0$

Electrostatic force and Contact Potential Difference (CPD)

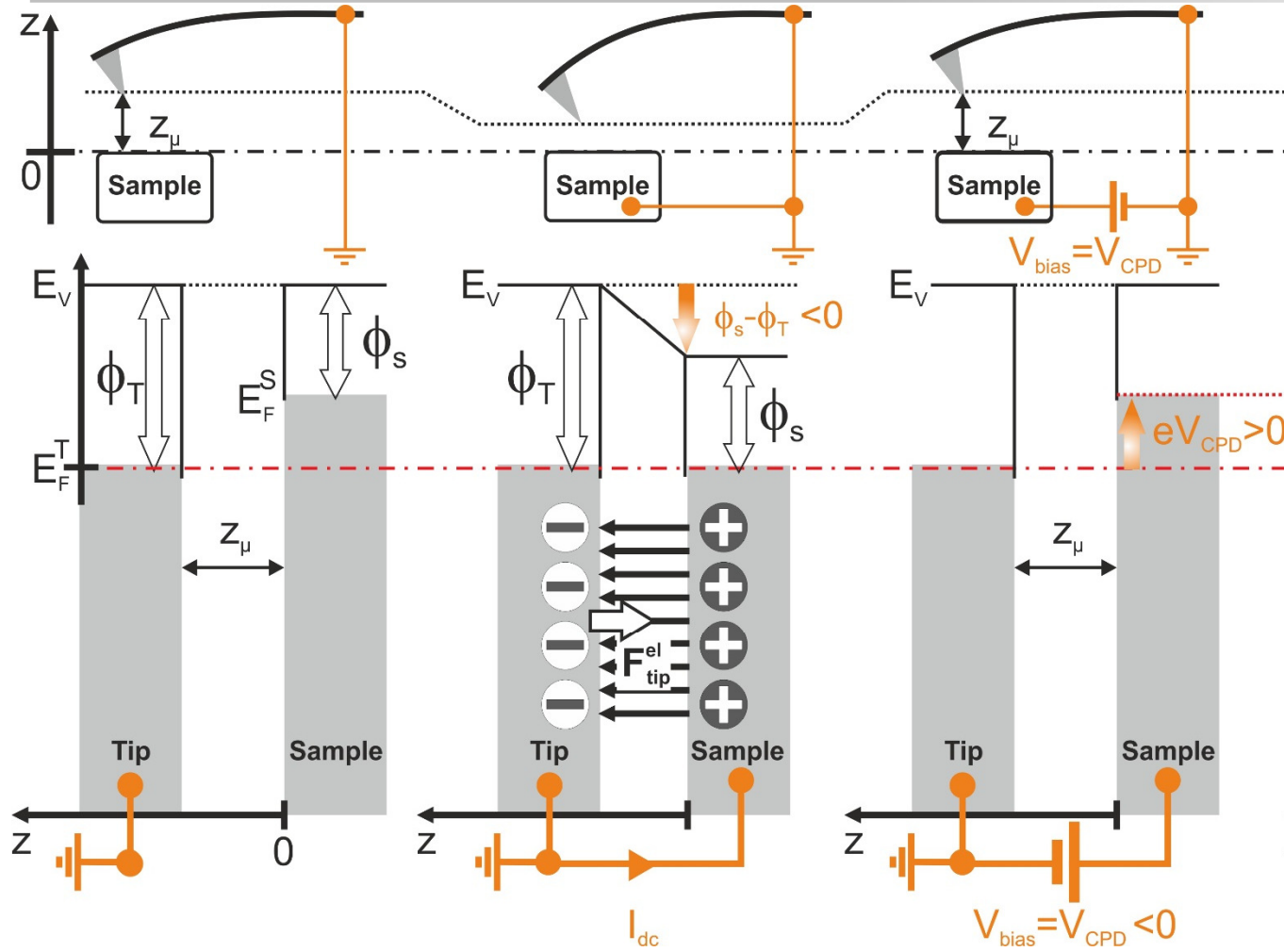

$V_{bias} = V_{CPD} \rightarrow$ electrostatic force compensation

Electrostatic force and Contact Potential Difference (CPD)

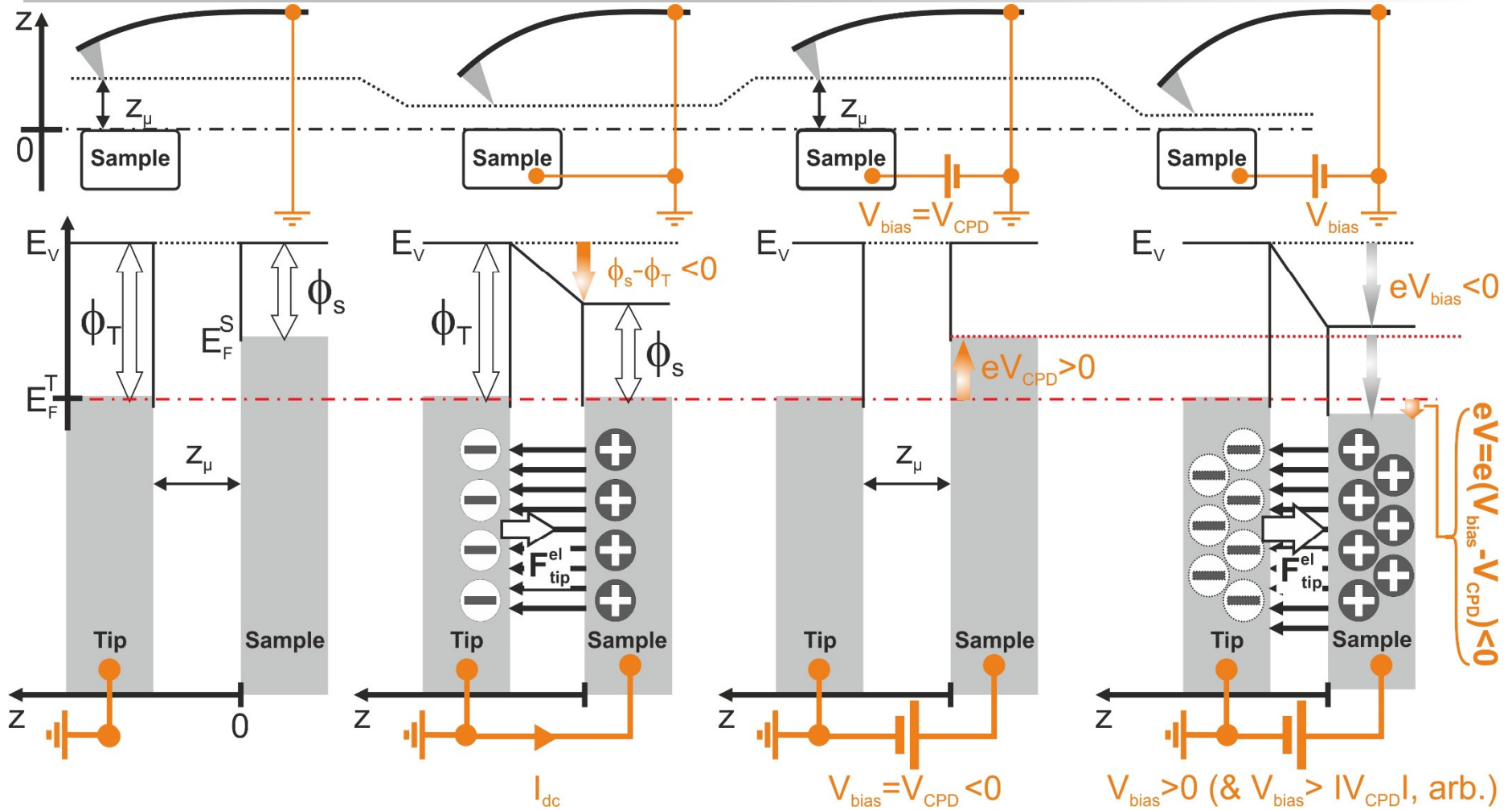

$$\mathbf{F}_{tip}^{el} = -\frac{\partial W^{el}}{\partial z} \hat{\mathbf{z}} = -\frac{1}{2} \left| \frac{\partial C}{\partial z} \right| V^2 \hat{\mathbf{z}} = -\frac{1}{2} \left| \frac{\partial C}{\partial z} \right| (V_{bias} - V_{CPD})^2 \hat{\mathbf{z}} \quad (Eq.6)$$

Electrostatic force and Contact Potential Difference (CPD)

$$\mathbf{F}_{\text{tip}}^{\text{el}} = -\frac{\partial W^{\text{el}}}{\partial z} \hat{\mathbf{z}} = -\frac{1}{2} \left| \frac{\partial C}{\partial z} \right| V^2 \hat{\mathbf{z}} = -\frac{1}{2} \left| \frac{\partial C}{\partial z} \right| (V_{\text{bias}} - V_{\text{CPD}})^2 \hat{\mathbf{z}} \quad (\text{Eq.6})$$

Void capacitor (=inner charge free)

- KPFM = detecting tip-surface **electrostatic forces** and compensate them with the proper dc bias on the sample while scanning* :

$$F_{\text{tip}}^{\text{el}} = 0 \Leftrightarrow V_{\text{bias}} = V_{\text{CPD}} \quad (\text{Eq.7})$$

- This is why KPFM may be used on **any kind of surfaces**: metals, semi-conductors & insulators, despite with the former, the concept of CPD is ambiguous...

* only if the tip is grounded and V is applied to the sample, $V_{\text{bias}} = -V_{\text{CPD}}$ otherwise

Electrostatic force and Contact Potential Difference (CPD)

$$\mathbf{F}_{\text{tip}}^{\text{el}} = -\frac{\partial W^{\text{el}}}{\partial z} \hat{\mathbf{z}} = -\frac{1}{2} \left| \frac{\partial C}{\partial z} \right| V^2 \hat{\mathbf{z}} = -\frac{1}{2} \left| \frac{\partial C}{\partial z} \right| (V_{\text{bias}} - V_{\text{CPD}})^2 \hat{\mathbf{z}} \quad (\text{Eq.6})$$

Void capacitor (=inner charge free)

- Therefore, KPFM was conceptually extended to a mean of measuring samples' CPD*:

$$F_{\text{tip}}^{\text{el}} = 0 \Leftrightarrow V_{\text{bias}} = V_{\text{CPD}} \quad (\text{Eq.7})$$

- **BUT** equations 6 & 7 are valid for a void capacitor, only:

- $F_{\text{tip}}^{\text{el}} \propto V^2$
- $V \rightarrow V(\cancel{x})$: *no charges and/or dipole present inside the capacitor, unless otherwise* $F_{\text{tip}}^{\text{el}} = 0 \Rightarrow V_{\text{bias}} \neq V_{\text{CPD}}$

* only if the tip is grounded and V is applied to the sample, $V_{\text{bias}} = -V_{\text{CPD}}$ otherwise

Electrostatic force and Contact Potential Difference (CPD)

$$\mathbf{F}_{\text{tip}}^{\text{el}} = -\frac{\partial W^{\text{el}}}{\partial z} \hat{\mathbf{z}} = -\frac{1}{2} \left| \frac{\partial C}{\partial z} \right| V^2 \hat{\mathbf{z}} = -\frac{1}{2} \left| \frac{\partial C}{\partial z} \right| (V_{\text{bias}} - V_{\text{CPD}})^2 \hat{\mathbf{z}} \quad (\text{Eq.6})$$

Void capacitor (=inner charge free)

- Charges or dipoles (ions, vacancies, clusters, charge transfer effects, polarization effects...) systematically occur at the tip-surface interface: **models required to interpret F^{el} and hence, the KPFM signal (« CPD »)**

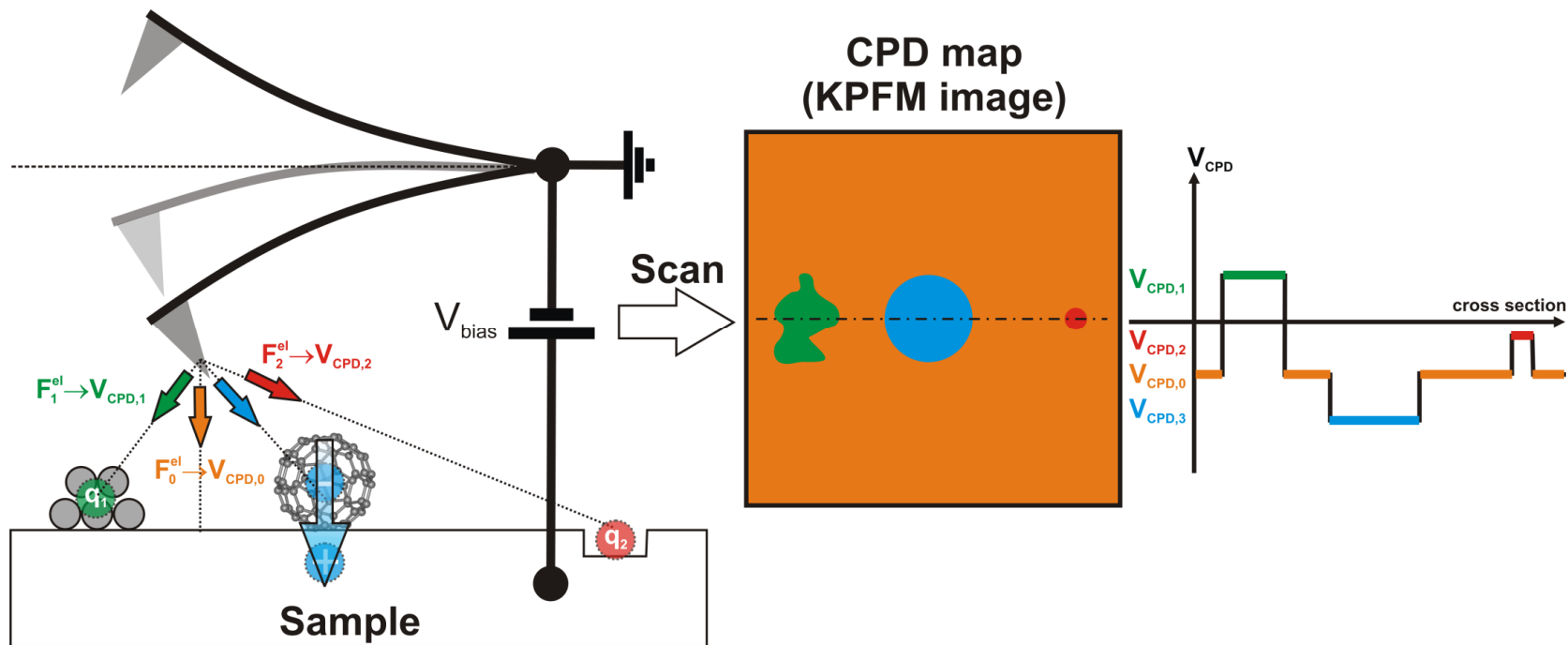

Work function in metals

K. Wandelt, *Appl. Surf. Sci.* 111, 1 (1997)

"The work function ϕ of an **infinite homogeneous metal** surface is defined as the energy difference between... the Fermi level... and a final state... the so called vacuum level."

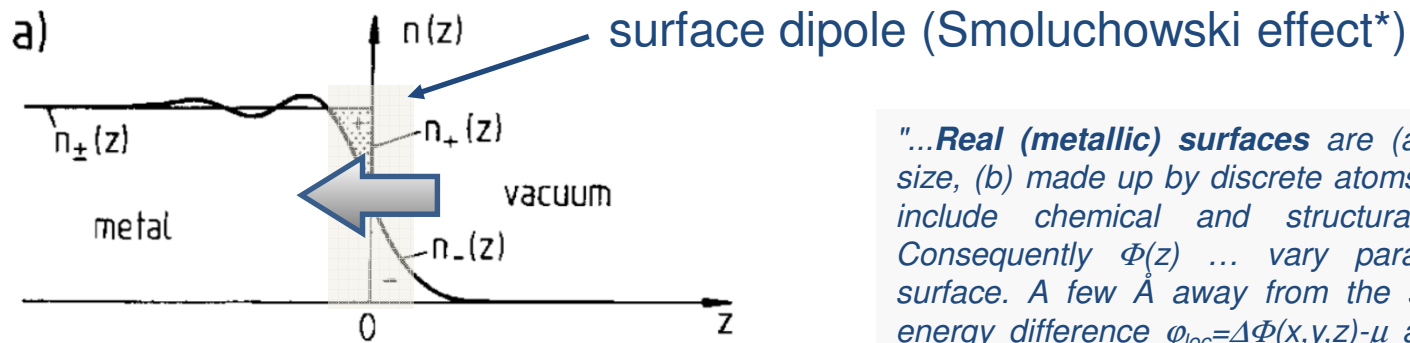

"...**Real (metallic) surfaces** are (a) of limited size, (b) made up by discrete atoms, (c) mostly include chemical and structural defects... Consequently $\Phi(z)$... vary parallel to the surface. A few Å away from the surface, the energy difference $\phi_{loc} = \Delta\Phi(x,y,z) - \bar{\mu}$ acquires the character of a **local work function**"

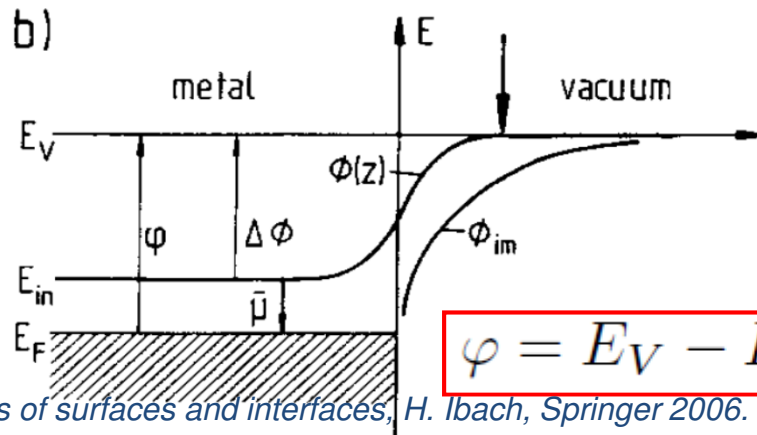

KPFM

Local Contact Potential Difference (LCPD)
= Short-Range Electrostatic forces

$$\phi = E_V - E_F = \Delta\Phi - \bar{\mu}$$

* *Physics of surfaces and interfaces*, H. Ibach, Springer 2006.

Long- and short-range electrostatic forces in KPFM

$$\vec{F}_{\text{tot}} = \vec{F}_{\text{LR}} = \left[\vec{F}_{\text{LR}}^{\text{el}} + \vec{F}_{\text{LR}}^{\text{vdW}} \right]$$

$$= -\frac{1}{2} \frac{\partial C}{\partial z} V^2 \hat{z}$$

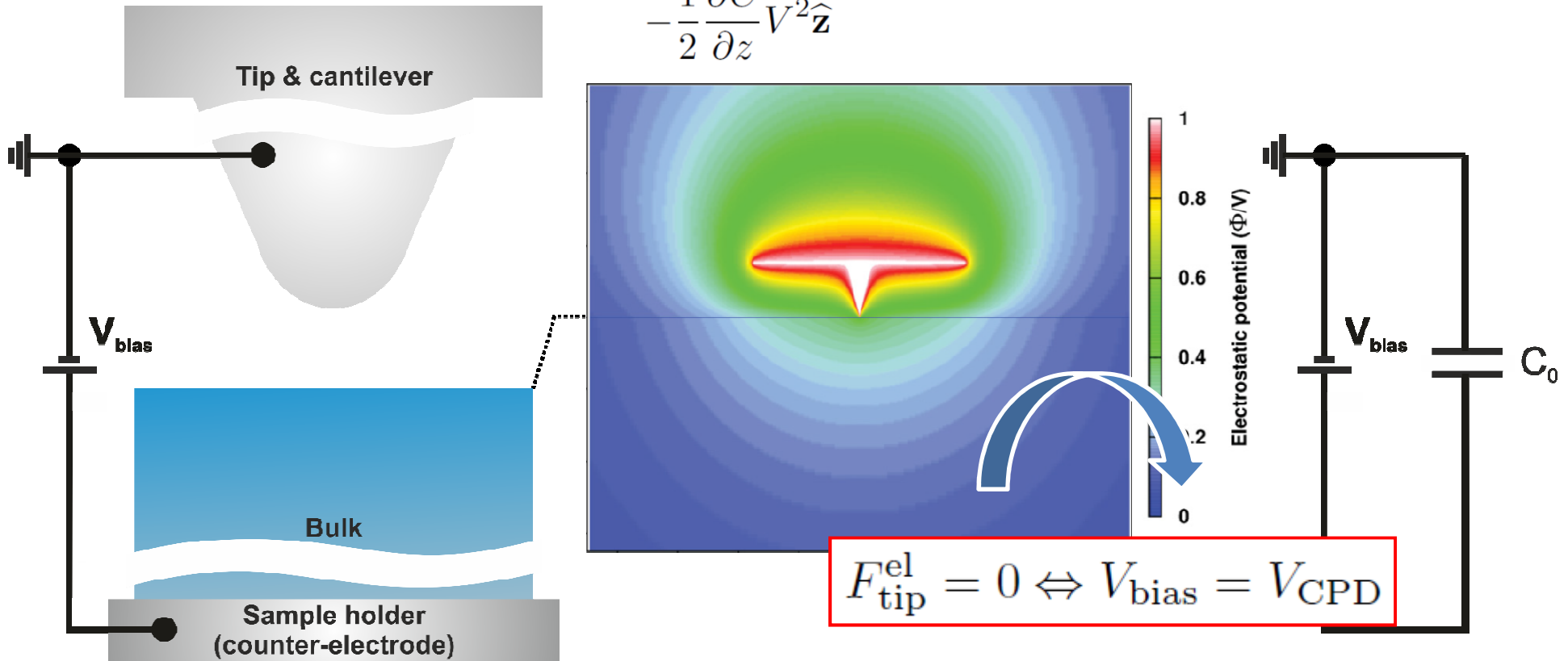

Long- and short-range electrostatic forces in KPFM

$$\vec{F}_{\text{tot}} = \vec{F}_{\text{LR}} = \left[\vec{F}_{\text{LR}}^{\text{el}} + \vec{F}_{\text{LR}}^{\text{vdW}} \right]$$

$$= -\frac{1}{2} \frac{\partial C}{\partial z} V^2 \hat{\mathbf{z}} + \dots$$

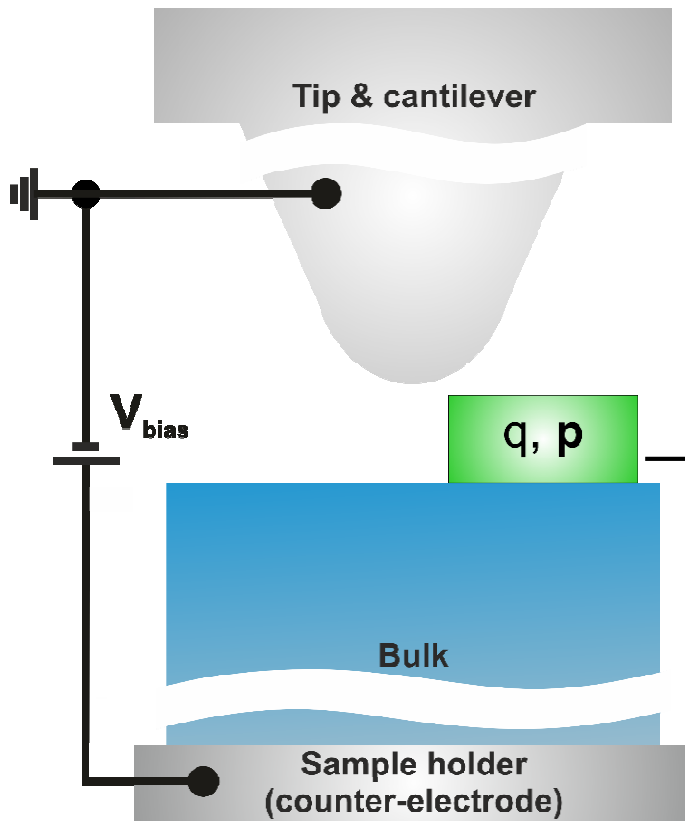

$$F_{\text{tip}}^{\text{el}} = 0 \Rightarrow V_{\text{bias}} \neq V_{\text{CPD}}$$

Mesoscopic objects (whose size is comparable or larger than the tip)

Long- and short-range electrostatic forces in KPFM

$$\vec{F}_{\text{tot}} = \vec{F}_{\text{LR}} + \vec{F}_{\text{SR}} = \left[\vec{F}_{\text{LR}}^{\text{el}} + \vec{F}_{\text{LR}}^{\text{vdW}} \right] + \left[\vec{F}_{\text{SR}}^{\text{el}} + \vec{F}_{\text{SR}}^{\text{vdW}} \right] \quad (\text{Eq.8})$$

$$-\frac{1}{2} \frac{\partial C}{\partial z} V^2 \hat{\mathbf{z}} + \dots$$

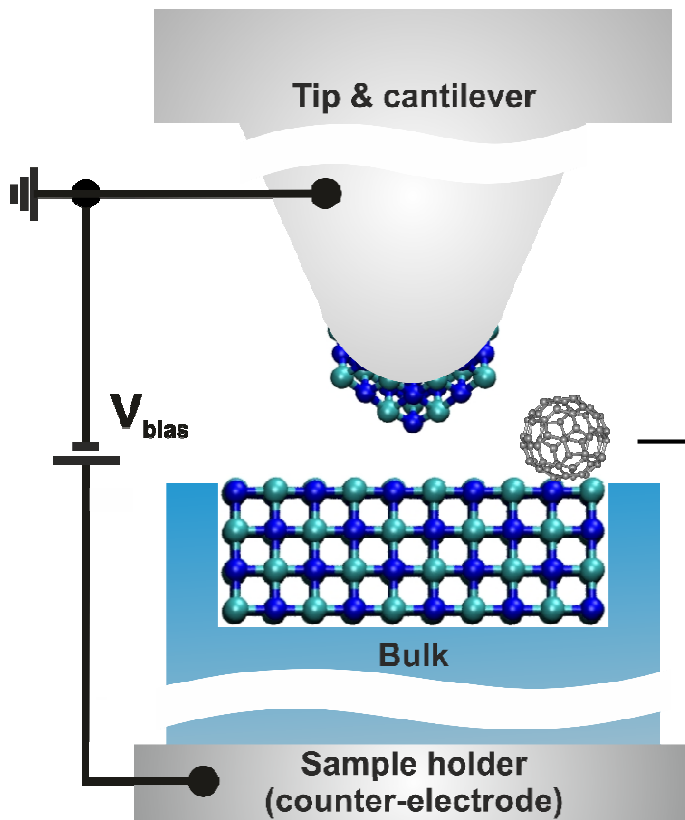

$$F_{\text{tip}}^{\text{el}} = 0 \Rightarrow V_{\text{bias}} \neq V_{\text{CPD}}$$

Sign of the charge & dipole orientation (tip grounded)*

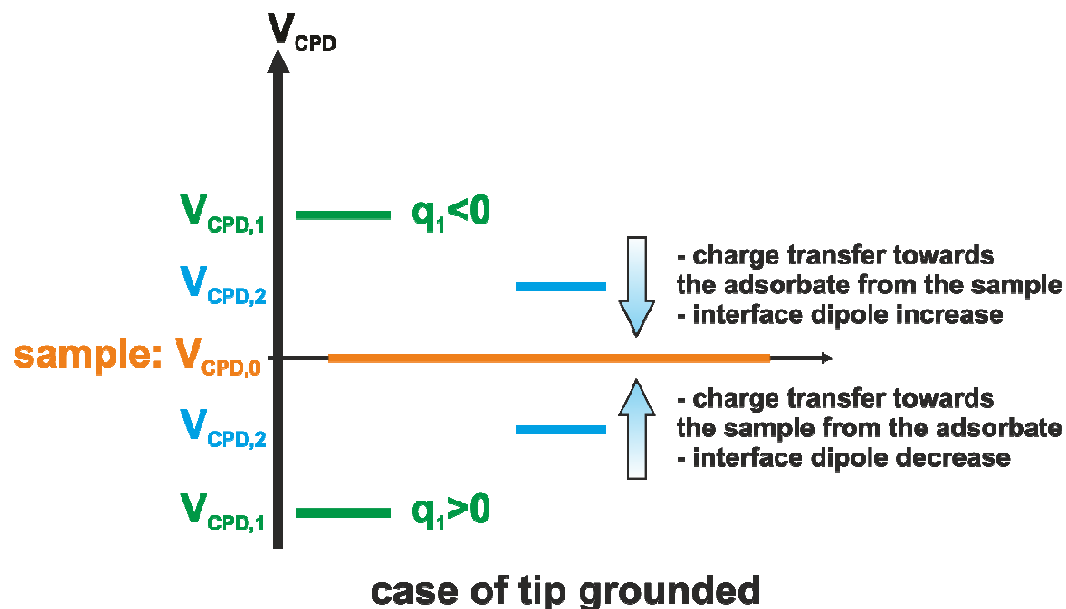
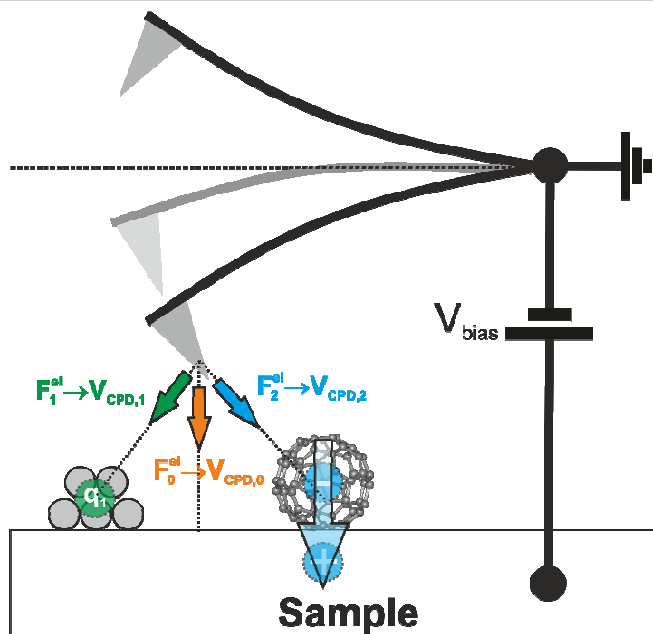

Local quantity α	Sign, orientation	CPD shift: $V_{CPD,\alpha} - V_{CPD,0}$	« Local WF interpretation » $\Phi_{sample,\alpha} - \Phi_{sample,0}$
Charge q	+	< 0	< 0 : decrease
	-	> 0	> 0 : increase
Dipole p	\uparrow	< 0	< 0 : decrease
	\downarrow	> 0	> 0 : increase

*consistent with most frequently reported results (see « References » section at the end of the slides)

Example

□ ZnPcCl₈ on Ag(111)*:

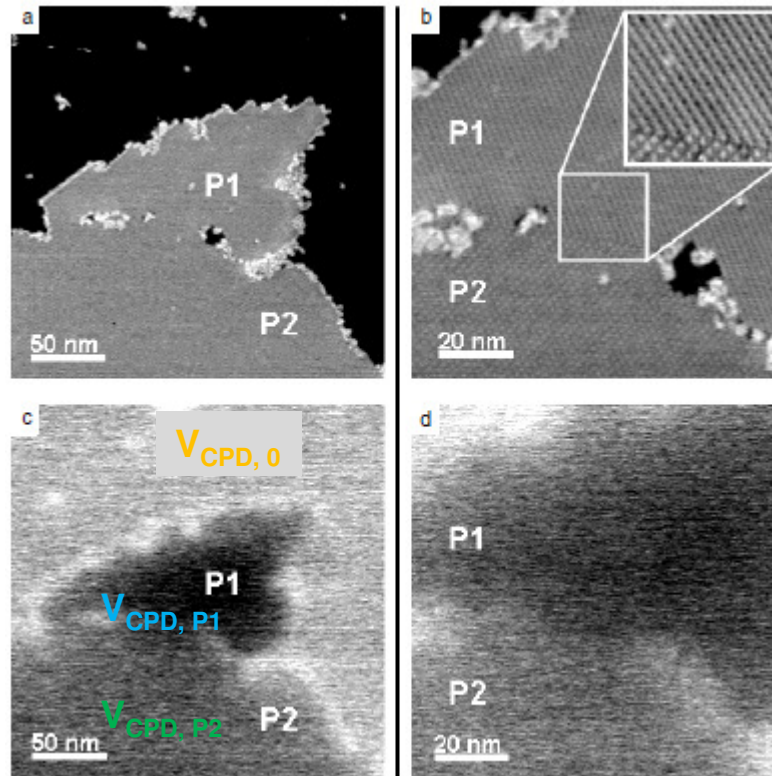
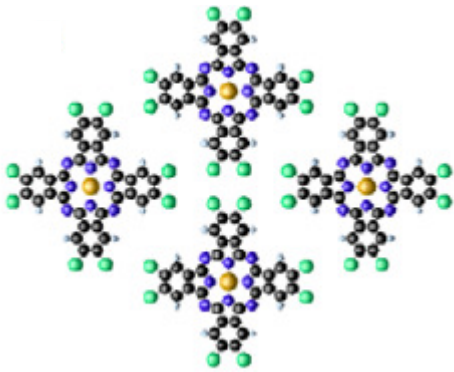

- $V_{CPD,0} = 4.73 \text{ V}$
- $V_{CPD,P1} = V_{CPD,ref} - 103 \text{ mV}$ → negative shift → layer gets « + » charged → interf. dip. decreased
- $V_{CPD,P2} = V_{CPD,ref} - 54 \text{ mV}$ → idem, but less than with P1

*P. Milde *et al.* Nanotechnology 19, 305501 (2008)

Summary of that section...

- KPFM = compensation of the electrostatic force(s) that occur between the tip and the surface forming a capacitor.
- For a « void capacitor », the electrostatic force writes:

$$\mathbf{F}_{\text{tip}}^{\text{el}} = -\frac{\partial W^{\text{el}}}{\partial z} \hat{\mathbf{z}} = -\frac{1}{2} \left| \frac{\partial C}{\partial z} \right| V^2 \hat{\mathbf{z}} = -\frac{1}{2} \left| \frac{\partial C}{\partial z} \right| (V_{\text{bias}} - V_{\text{CPD}})^2 \hat{\mathbf{z}}$$

- Therefore:

$$F_{\text{tip}}^{\text{el}} = 0 \Leftrightarrow V_{\text{bias}} = V_{\text{CPD}}$$

- But this is an insufficient approach with real samples as charges and/or dipoles are always present therein. Hence, the V_{bias} and z dependence of the total electrostatic force is to be quantified first to interpret the **KPFM signal, i.e. the « CPD »**
- The sign of the CPD shift tells us about the sign of the charge and/or of the surface dipole present on the surface

II. Principles of KPFM

Frequency shift in non contact-AFM

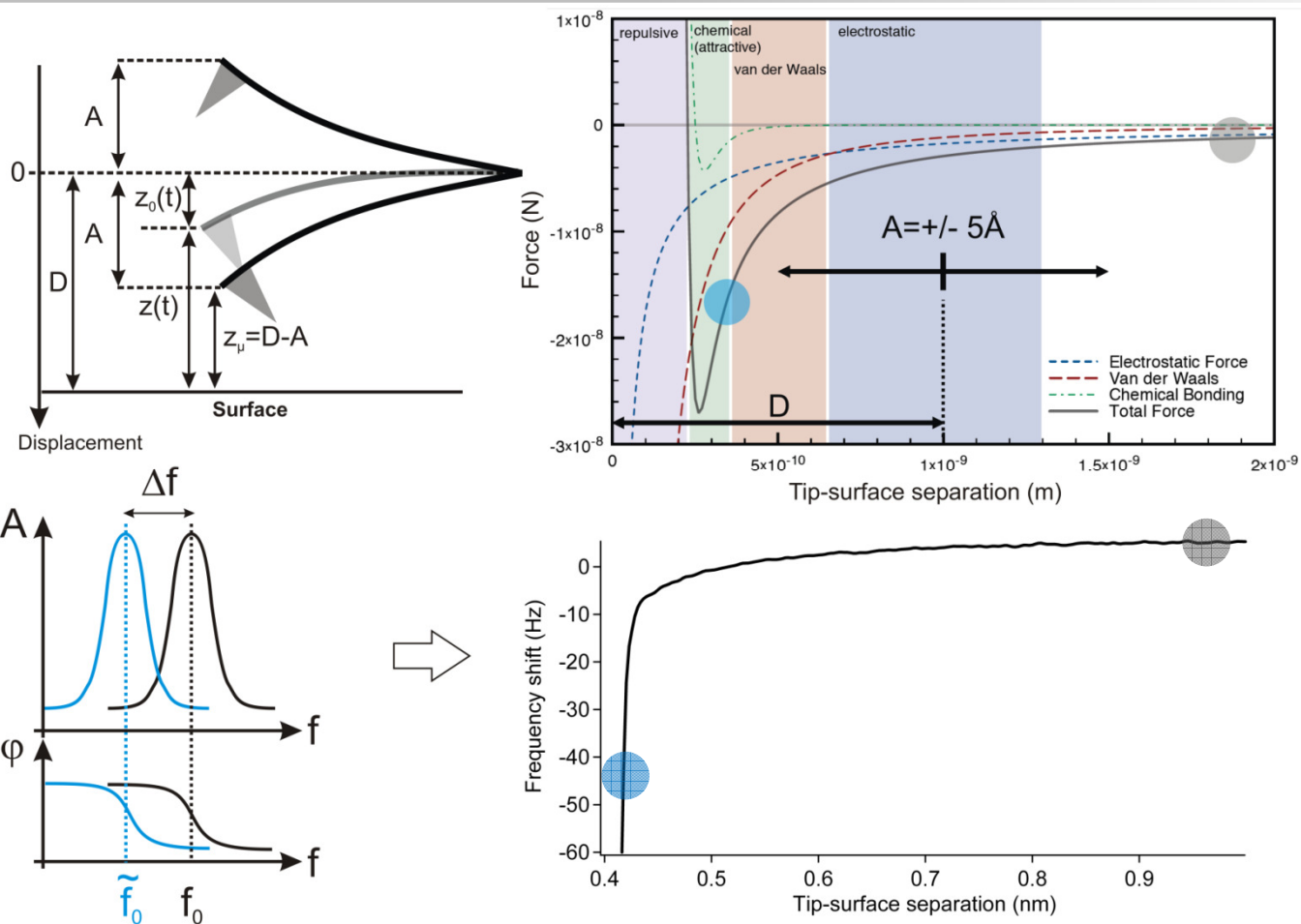

$$\frac{\Delta f(z_\mu)}{f_0} = \frac{\langle F_{int}^c \rangle}{k_0 A_0} = \frac{1}{2\pi k_0 A_0} \int_0^{2\pi} F_{int}^c(z_\mu + A_0 - A_0 \cos(u)) \cos(u) du \quad (Eq.9)$$

¹F.Giessibl, Phys. Rev. B 56, 16010 (1997); Phys. Rev. B 61, 9968 (2000)

Non contact-AFM

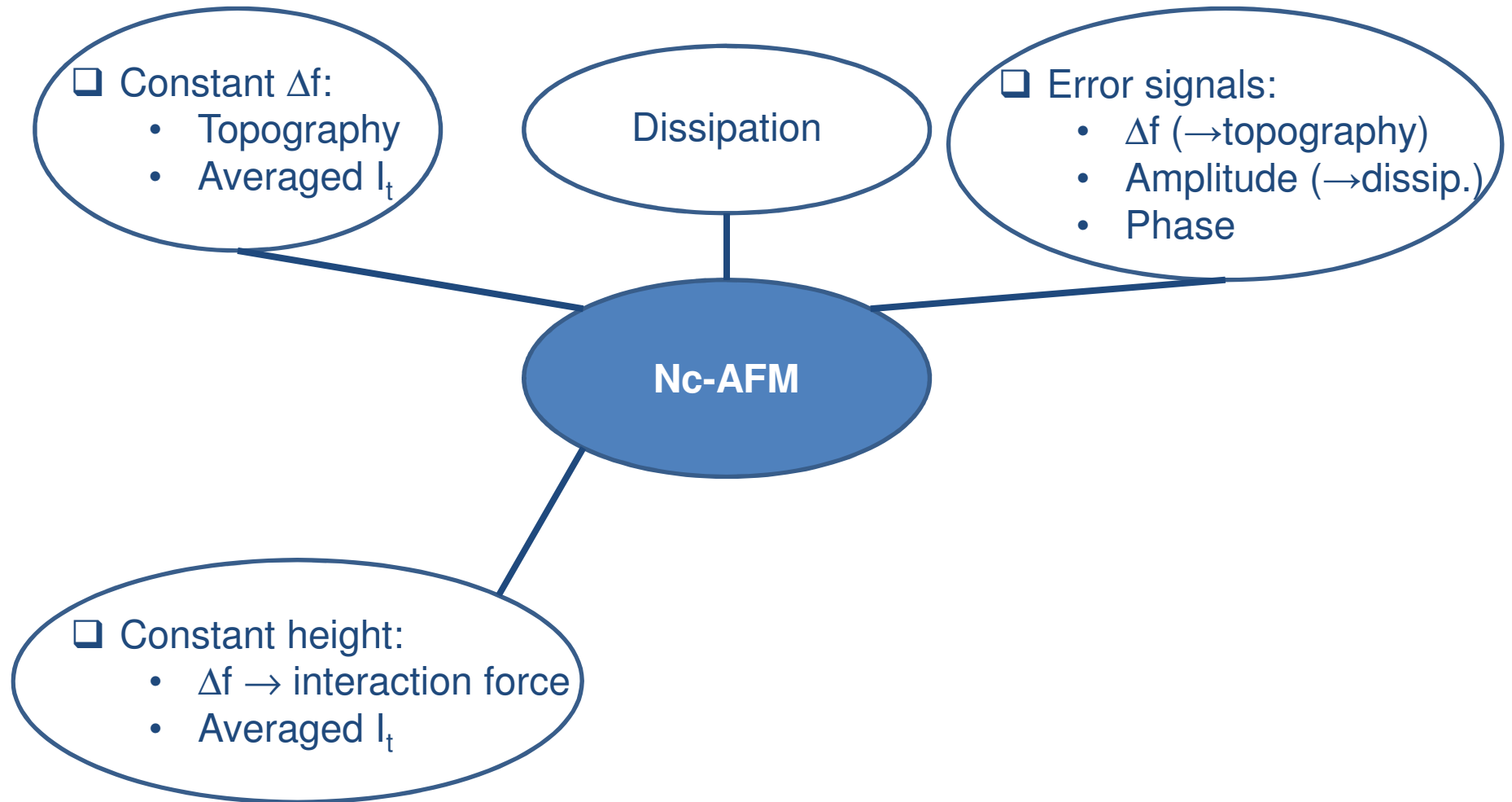

KPFM (in connection with nc-AFM)

$$\vec{F}_{\text{tot}} = \vec{F}_{\text{LR}} + \vec{F}_{\text{SR}} = \left[\vec{F}_{\text{LR}}^{\text{el}} + \vec{F}_{\text{LR}}^{\text{vdW}} \right] + \left[\vec{F}_{\text{SR}}^{\text{el}} + \vec{F}_{\text{SR}}^{\text{vdW}} \right]$$

4D vectorial field: X, Y, Z, V_{bias}

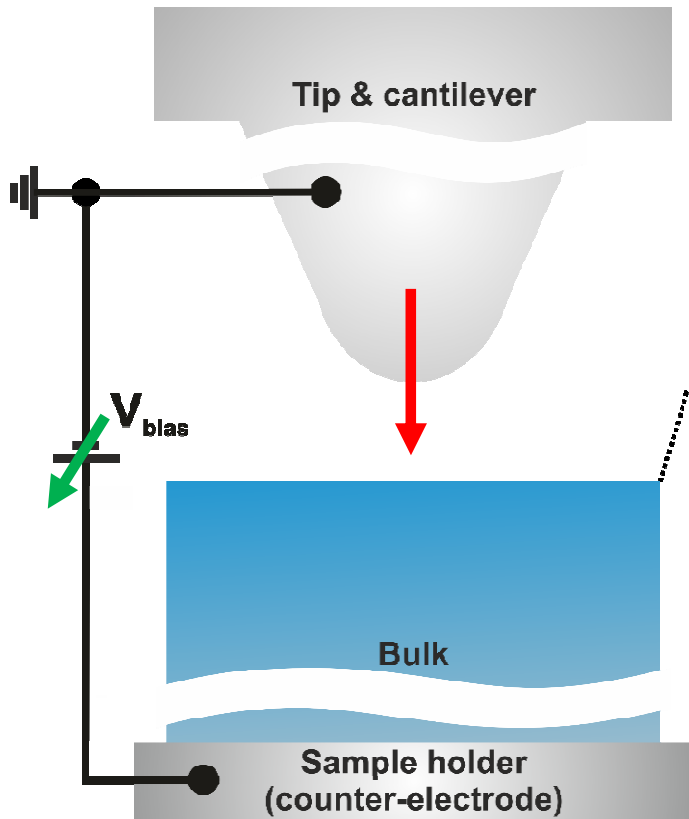

Constant X & Y, here

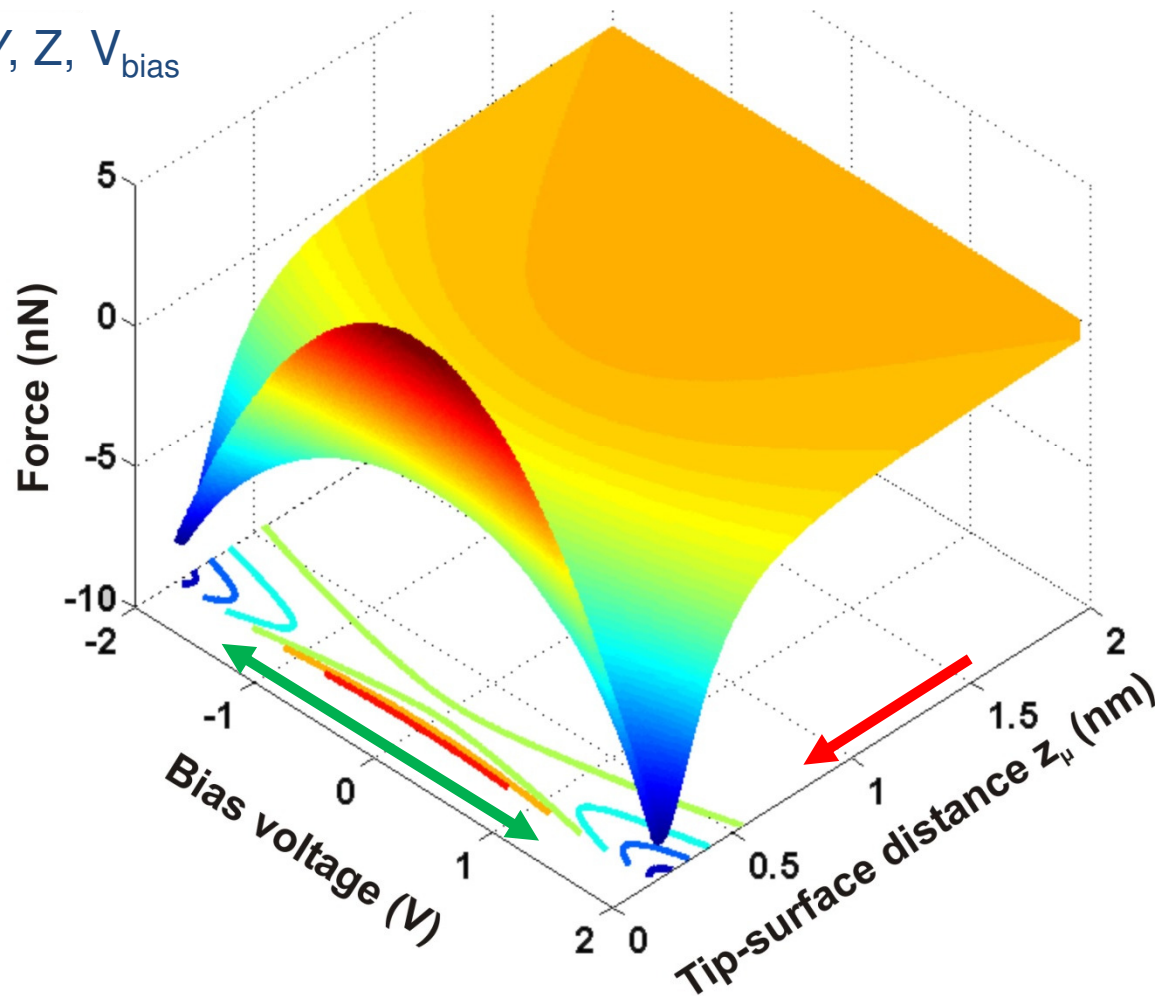

KPFM (in connection with nc-AFM)

The ideal way to get accurate forces & CPD measurements is to perform 4D force fields measurements*:

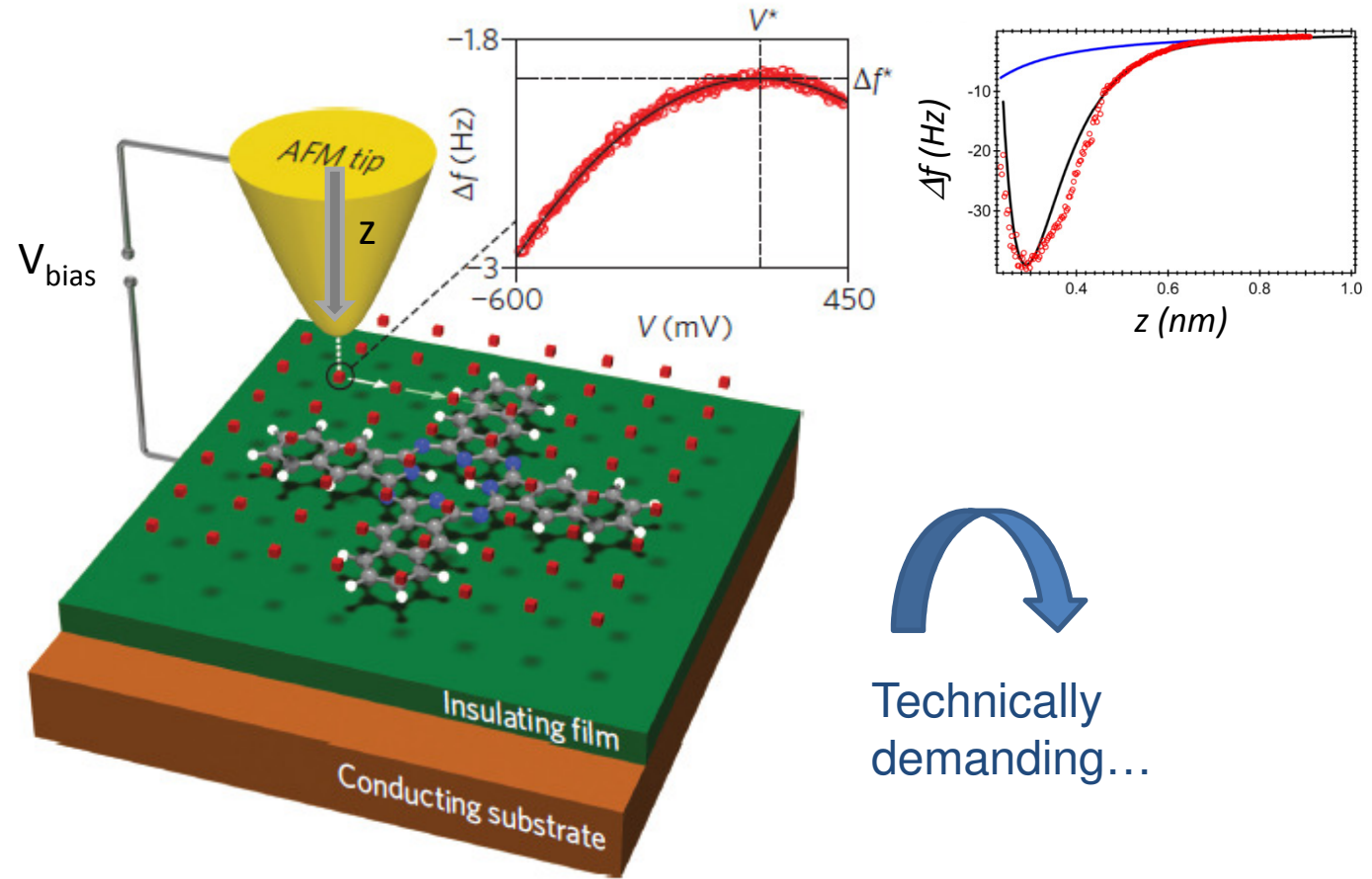

Technically demanding...

*scheme adapted from F.Mohn *et al.* Nature Nanotechnology **7**(4), 227–231 (2012)

Non contact-AFM

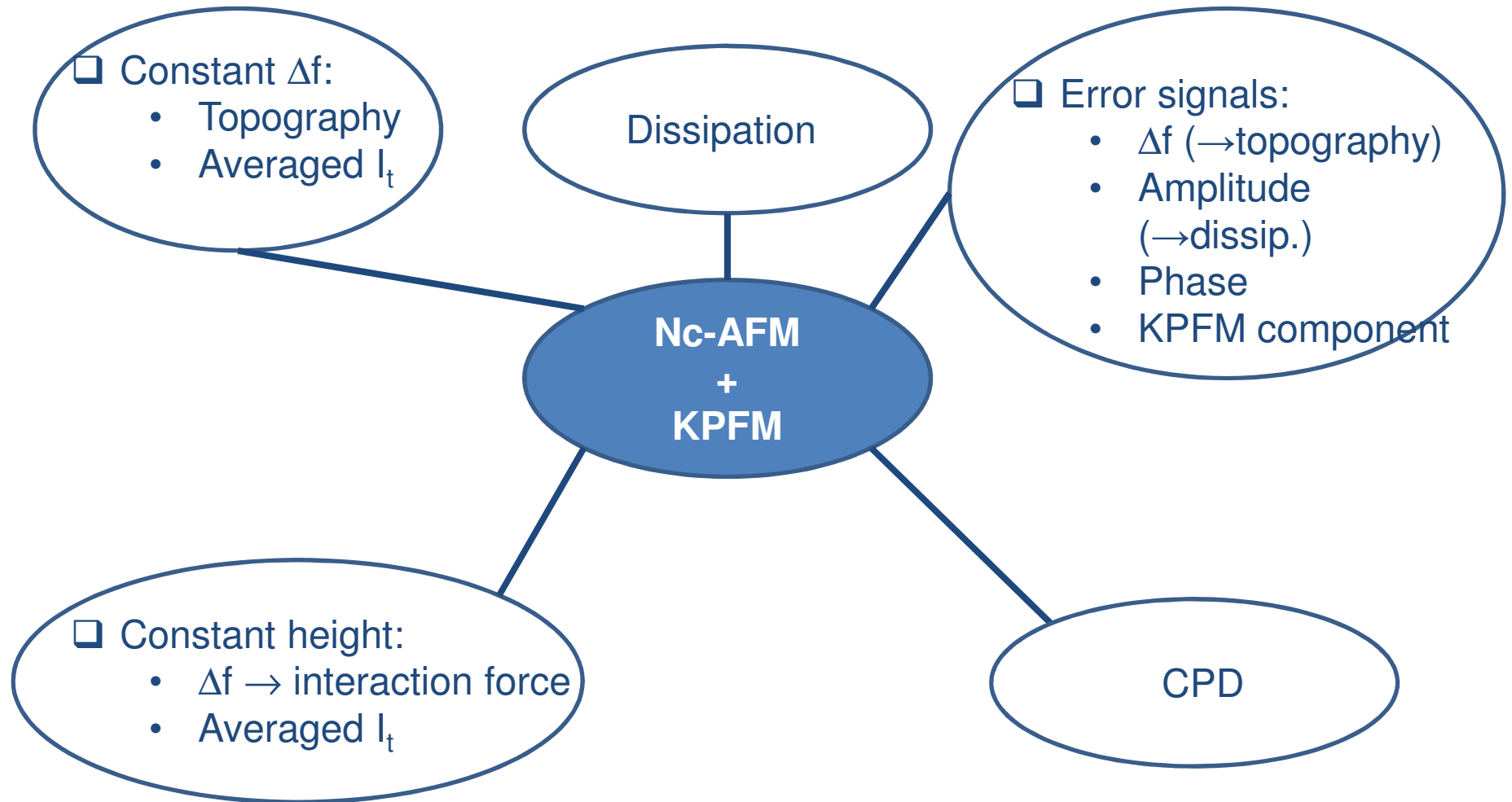

KPFM (in connection with nc-AFM)

Idea* : bias modulation \Rightarrow discrimination of the electrostatic force w.r.t. other interaction forces

Bias voltage applied between the tip and the surface :

$$V_{bias} = V_{dc} + V_{ac} \sin(2\pi f_{mod} t)$$

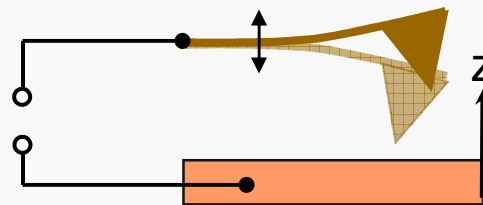

Noncontact-AFM:

Oscillation at f_0
(Force $\rightarrow \Delta f(z)$)

Attractive electrostatic force (tip, void capacitor):

$$F_{tip}^{el} = +\frac{1}{2} \frac{\partial C(z)}{\partial z} [V_{dc} - V_{CPD} + V_{ac} \sin(2\pi f_{mod} t)]^2 \quad (Eq.10)$$

*M. Nonnenmacher et al., APL **58**, 2921 (1991); J. Weaver et al. JVSTB **9**, 1559 (1991)

KPFM (in connection with nc-AFM)

Spectral components:

$$F_{\text{tip}}^{\text{el},0} = \frac{\partial C(z)}{\partial z} \left[\frac{1}{2} (V_{\text{dc}} - V_{\text{CPD}})^2 + \frac{V_{\text{ac}}^2}{4} \right] \quad (\text{Eq.11a})$$
$$F_{\text{tip}}^{\text{el},f_{\text{mod}}} = \frac{\partial C(z)}{\partial z} (V_{\text{dc}} - V_{\text{CPD}}) V_{\text{ac}} \sin(2\pi f_{\text{mod}} t) \quad (\text{Eq.11b})$$
$$F_{\text{tip}}^{\text{el},2f_{\text{mod}}} = \frac{\partial C(z)}{\partial z} \frac{V_{\text{ac}}^2}{4} \cos(2f_{\text{mod}} t) \quad (\text{Eq.11c})$$

- ❑ These superimpose to the interaction force between the cantilever and the surface
- ❑ Static deflection & induced vibrations of the cantilever at $f_0 + f_{\text{mod}}$ and $f_0 + 2f_{\text{mod}}$
- ❑ Detection and cancellation of the f_{mod} component by applying a proper dc voltage which matches the CPD



KPFM (in connection with nc-AFM)

Deflection power spectrum*, $f_{\text{mod}} = 2$ kHz

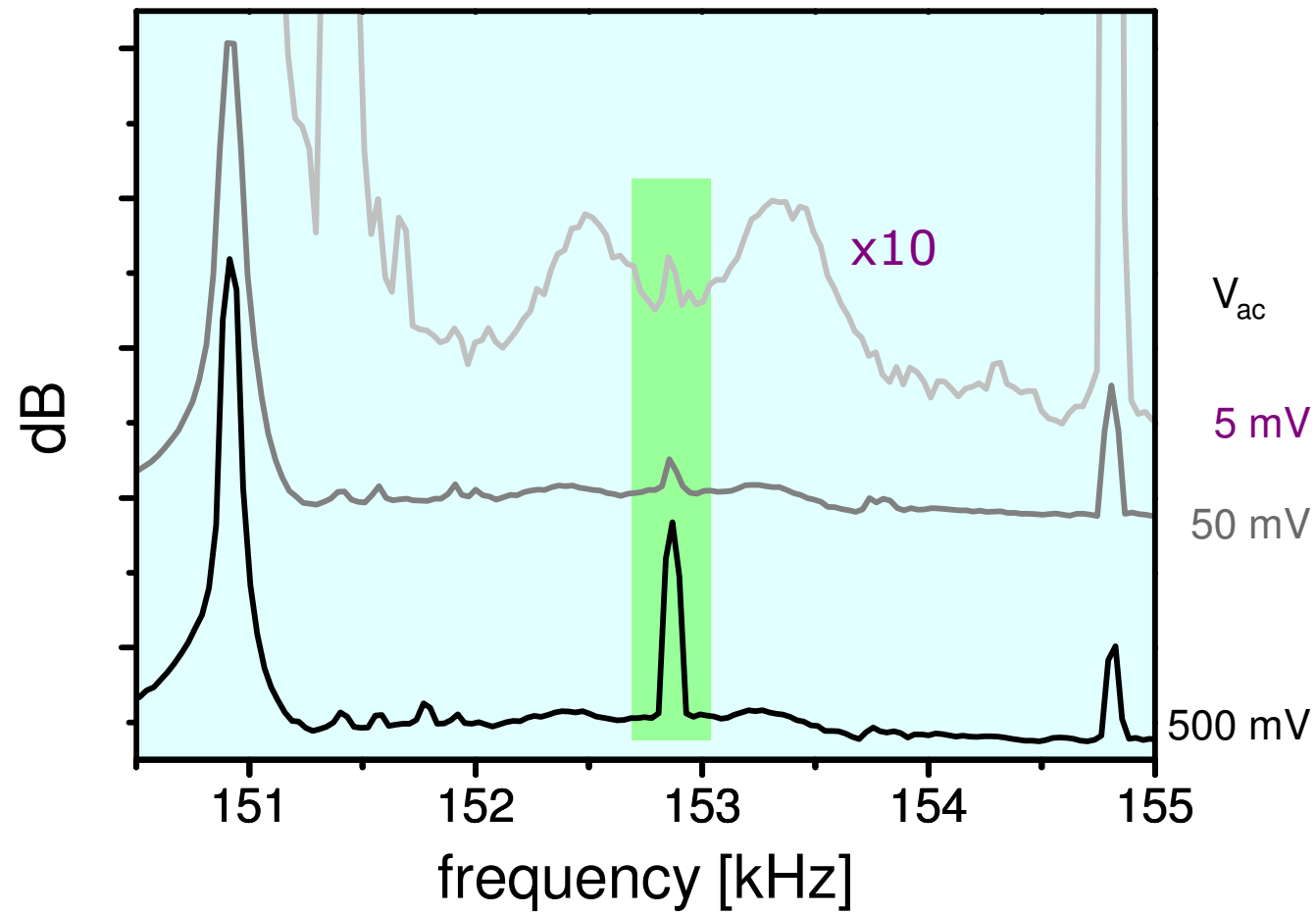

*U.Zerweck et al., Phys. Rev. B 71, 125424 (2005)

FM- & AM-KPFM

Frequency modulation (FM-KPFM) : $f_{mod} \sim 1$ kHz

Amplitude modulation (AM-KPFM) :

$$f_{mod} = f_1 \sim 6.3f_0$$

$\rightarrow f_{mod}$ matches the first bending eigenmode of the cantilever above the fundamental one

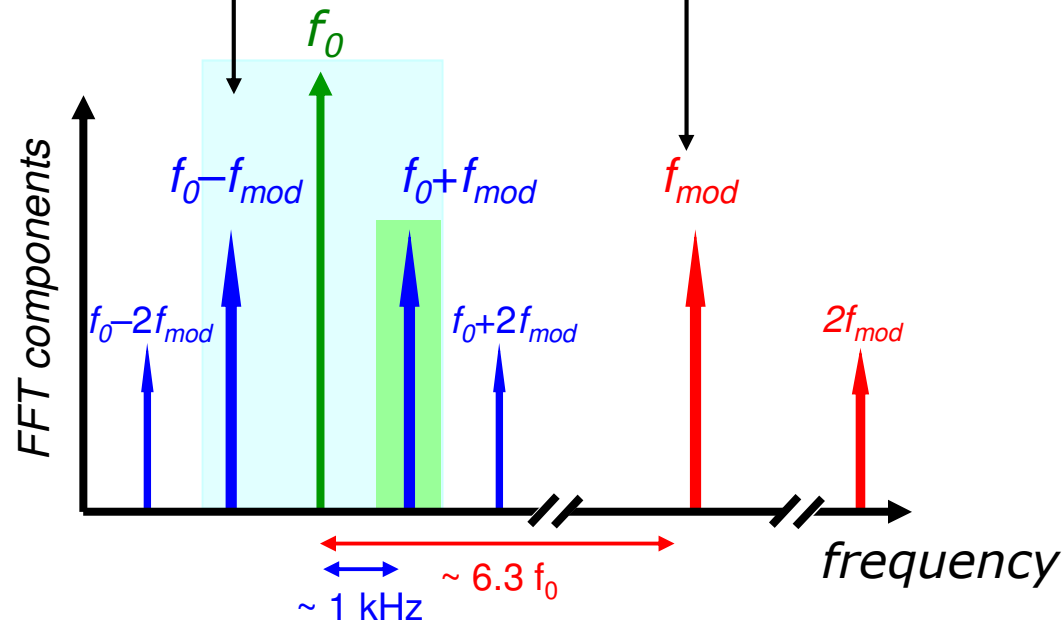
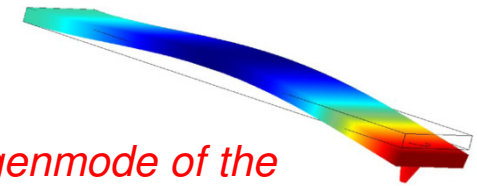

AM- vs. FM-KPFM

PHYSICAL REVIEW B 86, 075407 (2012)

Multiscale approach for simulations of Kelvin probe force microscopy with atomic resolution

Ali Sadeghi, Alexis Baratoff, S. Alireza Ghasemi, Stefan Goedecker, Thilo Glatzel, Shigeki Kawai, and Ernst Meyer

Department of Physics, University of Basel, Klingelbergstrasse 82, CH-4056 Basel, Switzerland

(Received 23 March 2012; revised manuscript received 21 June 2012; published 2 August 2012)

The distance dependence and atomic-scale contrast recently observed in nominal contact potential difference (CPD) signals simultaneously recorded by Kelvin probe force microscopy (KPFM) using noncontact atomic force microscopy (NCAFM) on defect-free surfaces of insulating as well as semiconducting samples have stimulated theoretical attempts to explain such effects. Especially in the case of insulators, it is not quite clear how the applied bias voltage affects electrostatic forces acting on the atomic scale. We attack this problem in two steps. First, the electrostatics of the macroscopic tip-cantilever-sample system is treated by a finite-difference method on an adjustable nonuniform mesh. Then the resulting electric field under the tip apex is inserted into a series of atomistic wavelet-based density functional theory (DFT) calculations. Results are shown for a realistic neutral but reactive silicon nanoscale tip interacting with a NaCl(001) sample. Bias-dependent forces and resulting atomic displacements are computed to within an unprecedented accuracy. Theoretical expressions for amplitude modulation (AM) and frequency modulation (FM) KPFM signals and for the corresponding local contact potential differences (LCPD) are obtained by combining the macroscopic and atomistic contributions to the electrostatic force component generated at the voltage modulation frequency, and evaluated for several tip oscillation amplitudes A up to 10 nm. For $A = 0.1 \text{ \AA}$, the computed LCPD contrast is proportional to the slope of the atomistic force versus bias in the AM mode and to its derivative with respect to the tip-sample separation in the FM mode. Being essentially constant over a few volts, this slope is the basic quantity that determines variations of the atomic-scale LCPD contrast. Already above $A = 1 \text{ \AA}$, the LCPD contrasts in both modes exhibit almost the same spatial dependence as the slope. In the AM mode, this contrast is approximately proportional to $A^{-1/2}$, but remains much weaker than the contrast in the FM mode, which drops somewhat faster as A is increased. These trends are a consequence of the macroscopic contributions to the KPFM signal, which are stronger in the AM-mode and especially important if the sample is an insulator even at subnanometer separations where atomic-scale contrast appears.

Frequency-Modulation KPFM

Electrostatic force \Rightarrow shift of the resonance:

1st order :
$$f'_0 = \frac{1}{2\pi} \sqrt{\frac{k - \partial F / \partial z}{m^*}} \approx f_0 \left(1 - \frac{1}{2k} \frac{\partial F}{\partial z} \right) \quad (\text{Eq. 12})$$

Bias modulation (f_{mod}) \Rightarrow Electr. force modulation (f_{mod}) \Rightarrow Δf modulation (f_{mod})

« FM-KPFM is sensitive to the electrostatic force gradient... »

Frequency-Modulation KPFM

Electrostatic force



shift of the resonance:

1st order :

$$f'_0 = \frac{1}{2\pi} \sqrt{\frac{k - \partial F / \partial z}{m^*}} \approx f_0 \left(1 - \frac{1}{2k} \frac{\partial F}{\partial z} \right)$$

(Eq. 12)

Bias modulation (f_{mod})



Electr. force modulation (f_{mod})



Δf modulation (f_{mod})

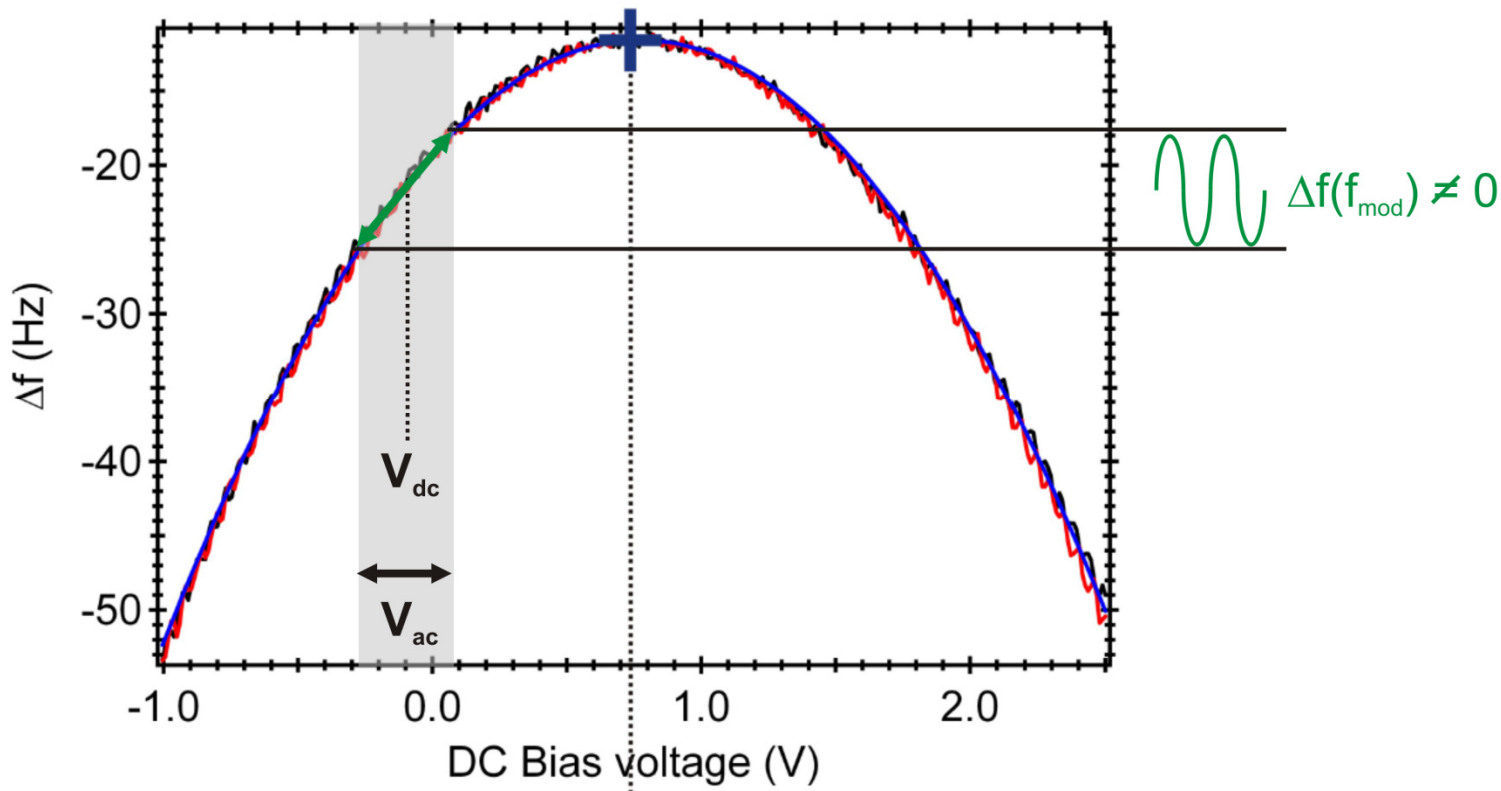

Frequency-Modulation KPFM

Electrostatic force \Rightarrow shift of the resonance:

1st order :
$$f'_0 = \frac{1}{2\pi} \sqrt{\frac{k - \partial F / \partial z}{m^*}} \approx f_0 \left(1 - \frac{1}{2k} \frac{\partial F}{\partial z} \right) \quad (\text{Eq. 12})$$

Bias modulation (f_{mod}) \Rightarrow Electr. force modulation (f_{mod}) \Rightarrow Δf modulation (f_{mod})

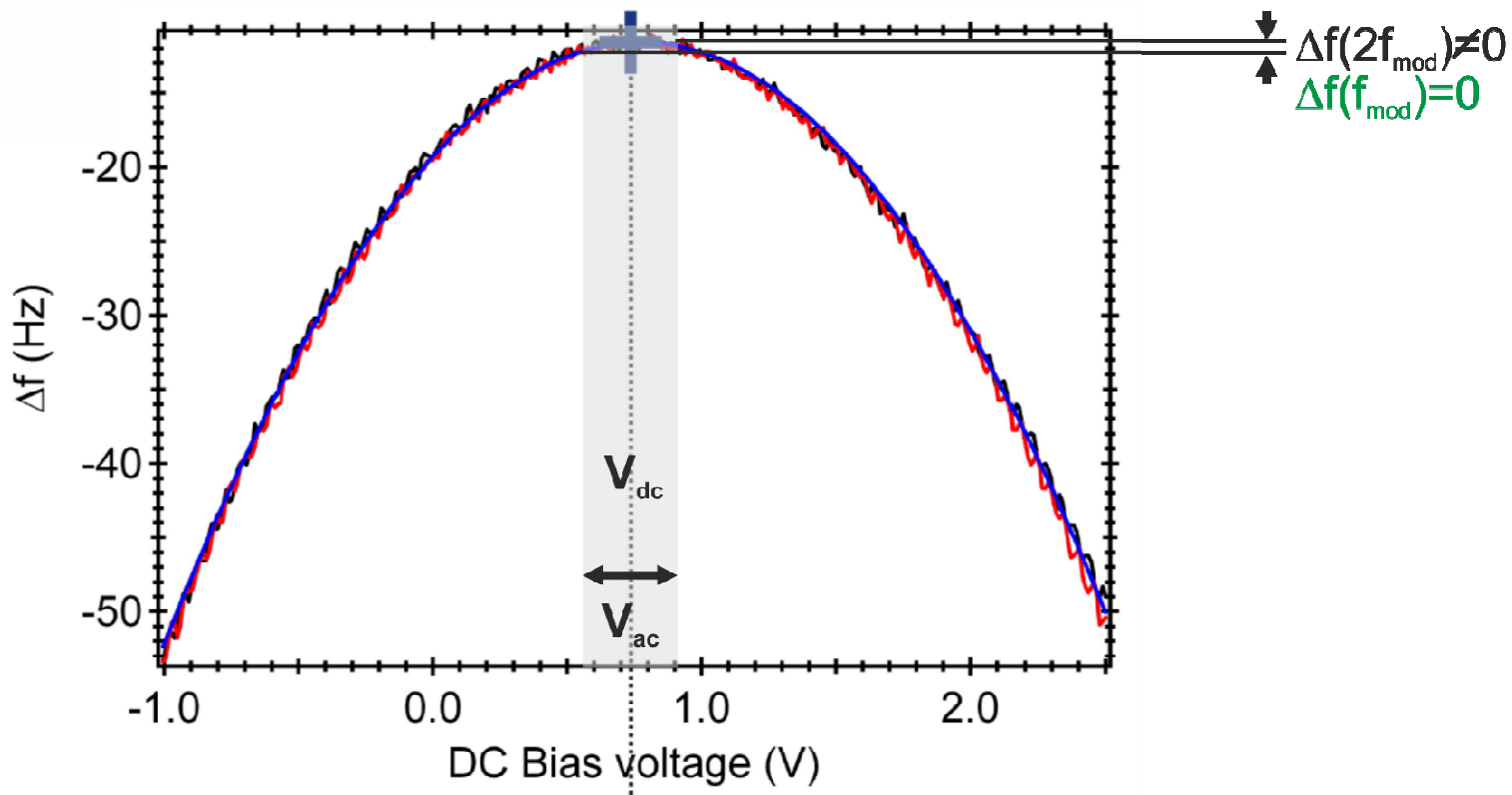

Frequency-Modulation KPFM

Electrostatic force \Rightarrow shift of the resonance:

1st order :
$$f'_0 = \frac{1}{2\pi} \sqrt{\frac{k - \partial F / \partial z}{m^*}} \approx f_0 \left(1 - \frac{1}{2k} \frac{\partial F}{\partial z} \right) \quad (\text{Eq. 12})$$

Bias modulation (f_{mod}) \Rightarrow Electr. force modulation (f_{mod}) \Rightarrow Δf modulation (f_{mod})

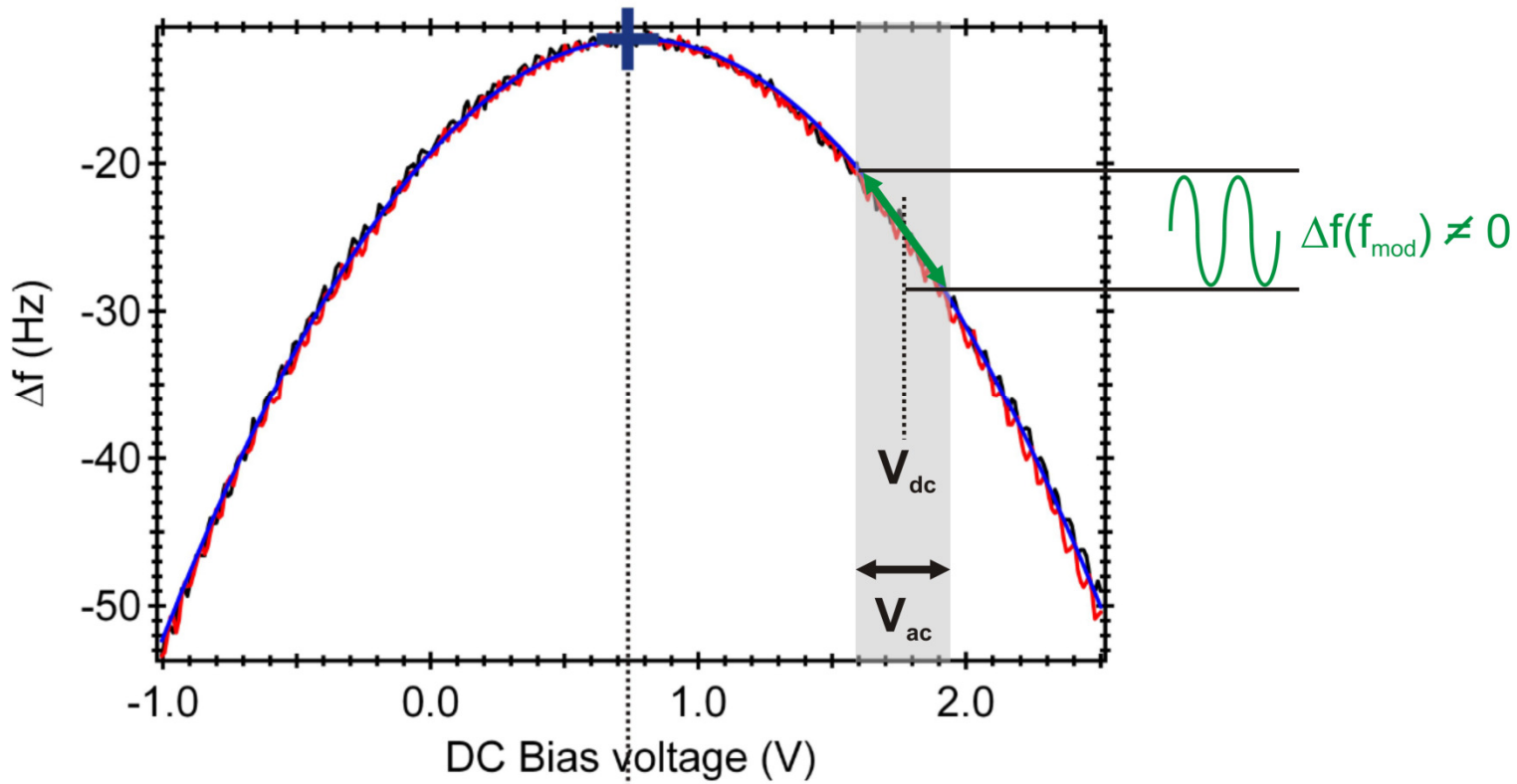

Frequency-Modulation KPFM

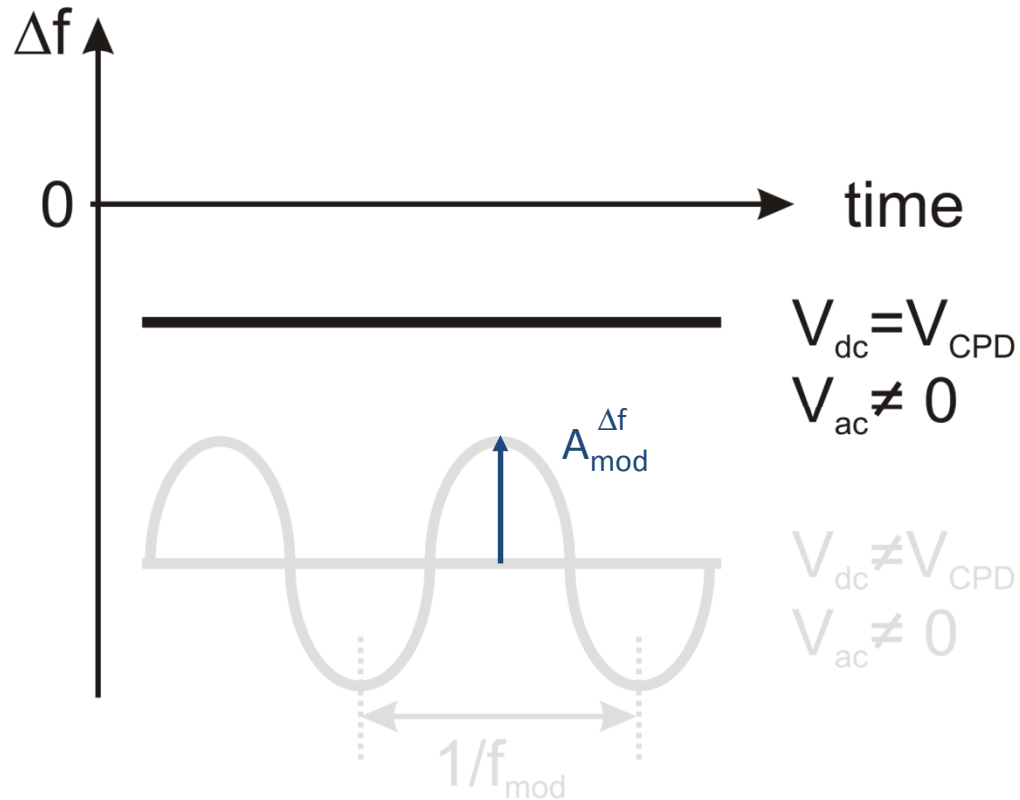

⇒ Detecting & compensating $A_{mod}^{\Delta f}$ by setting $V_{dc} = V_{CPD}$ continuously while scanning

Frequency-Modulation KPFM: experimental setup

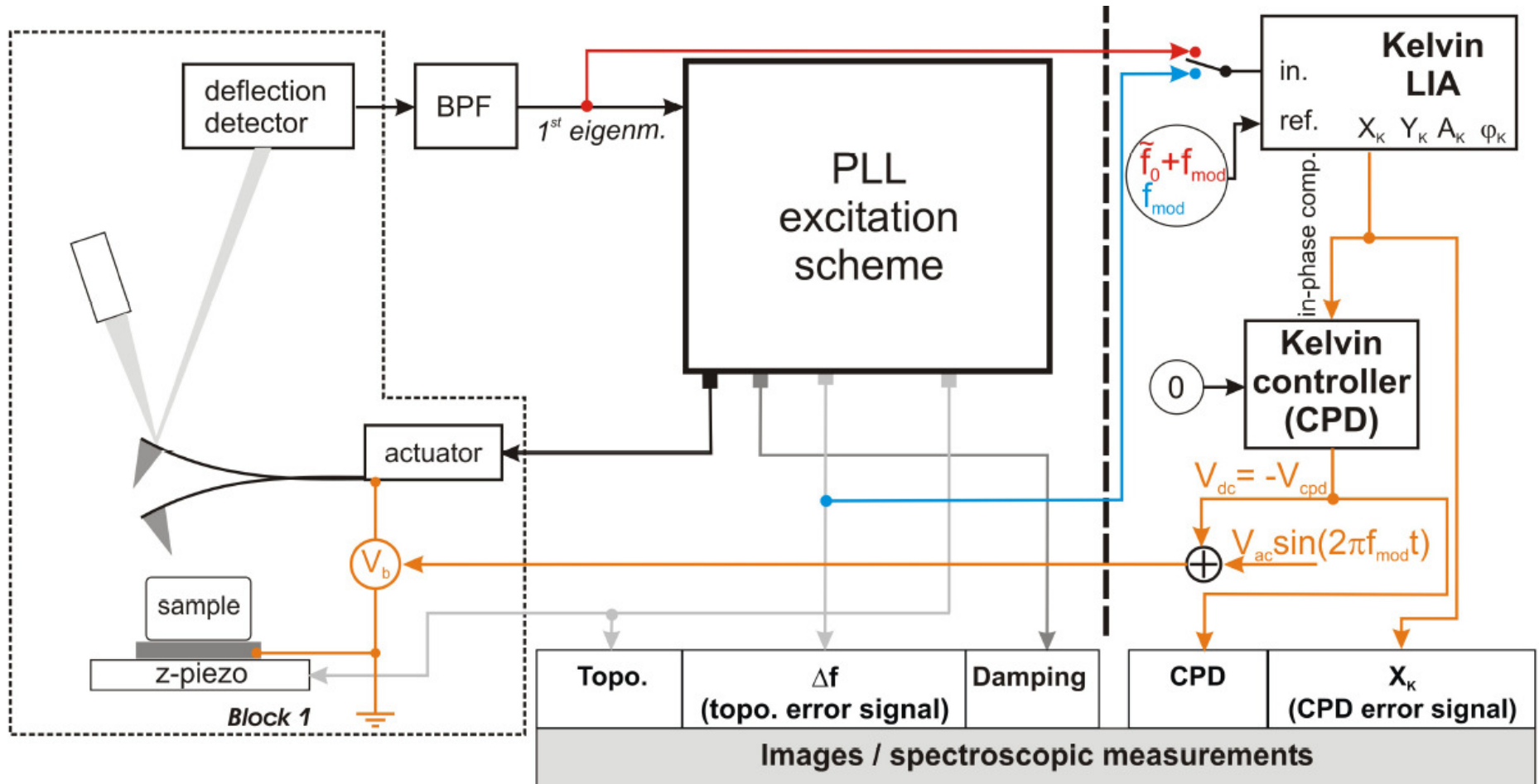

Frequency-Modulation KPFM: experimental setup

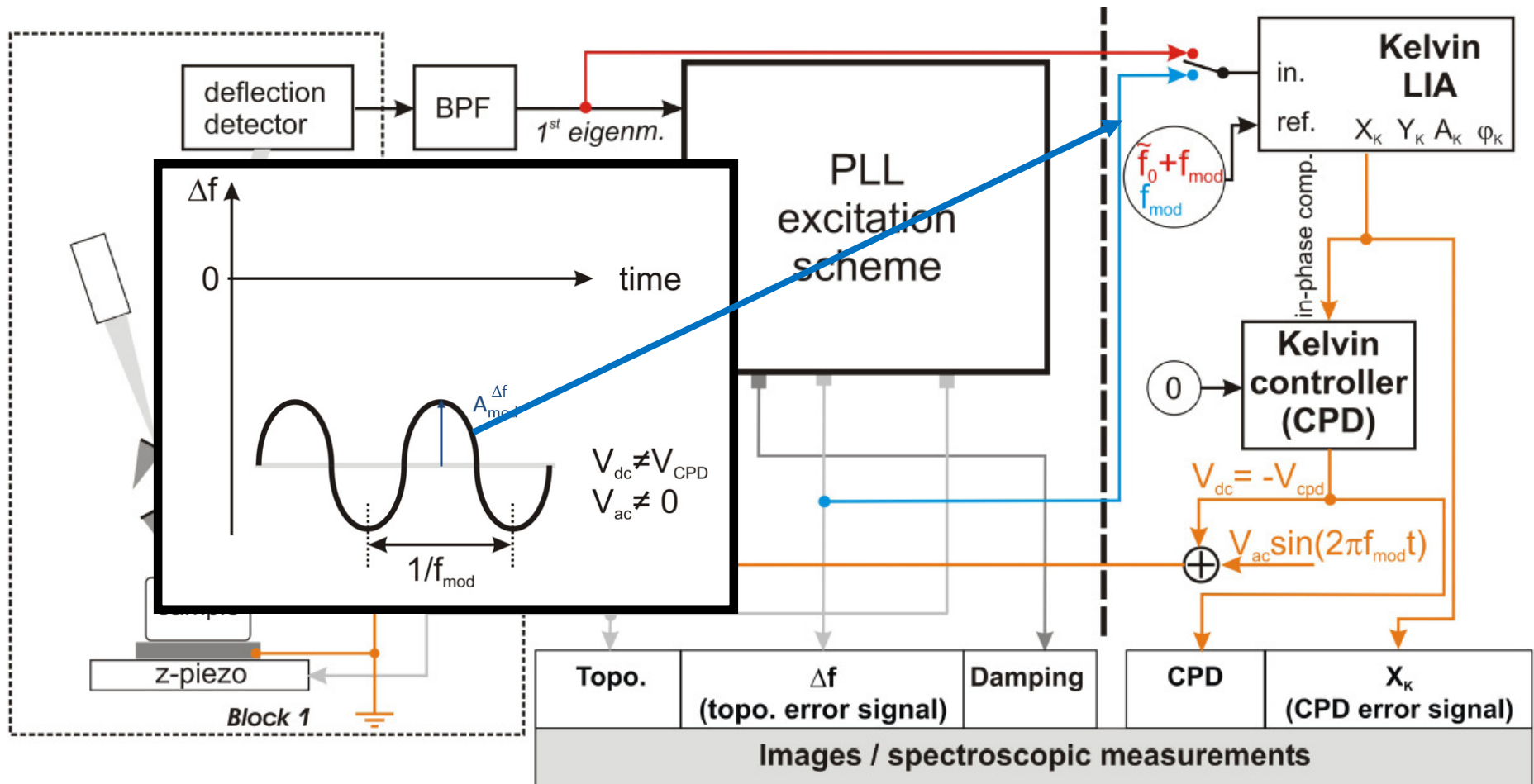

Frequency-Modulation KPFM: temporal considerations

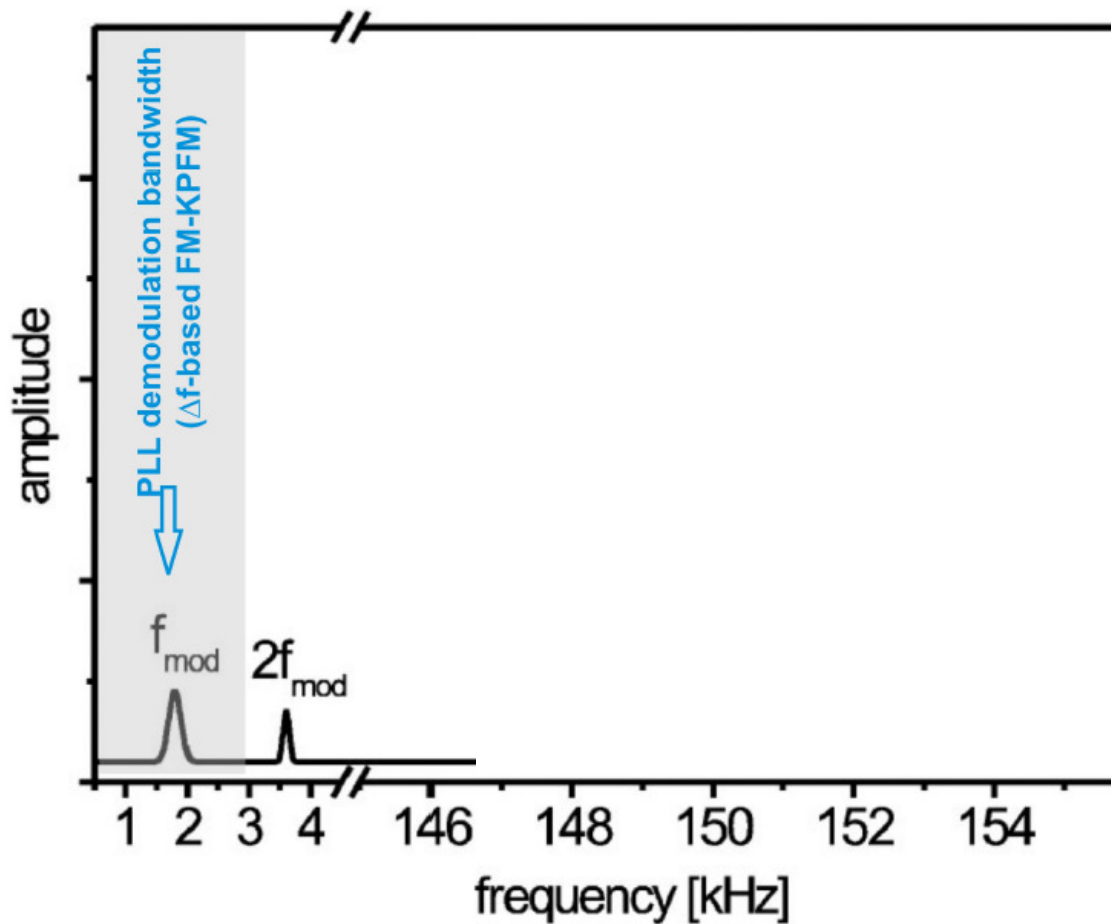

- f_{mod} has to be within the demodulation bandwidth of the PLL → compromise:
 - extending the PLL bandwidth → adds noise to Δf detection
 - must remain large enough to not influence the z regulation (usually requires to slow down the scans)
 - order of magnitude: 1 kHz

Frequency-Modulation KPFM: experimental setup

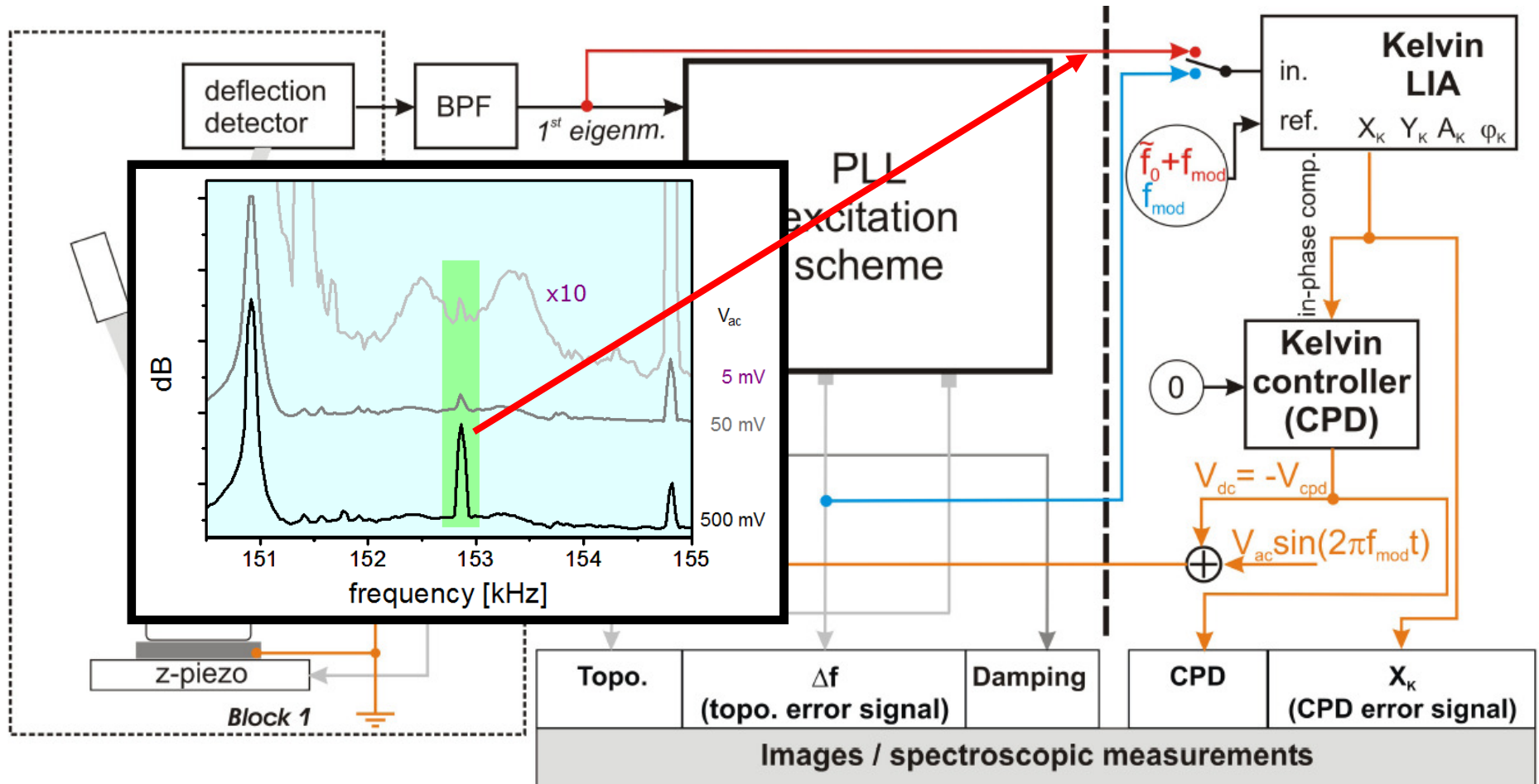

Frequency-Modulation KPFM: temporal considerations

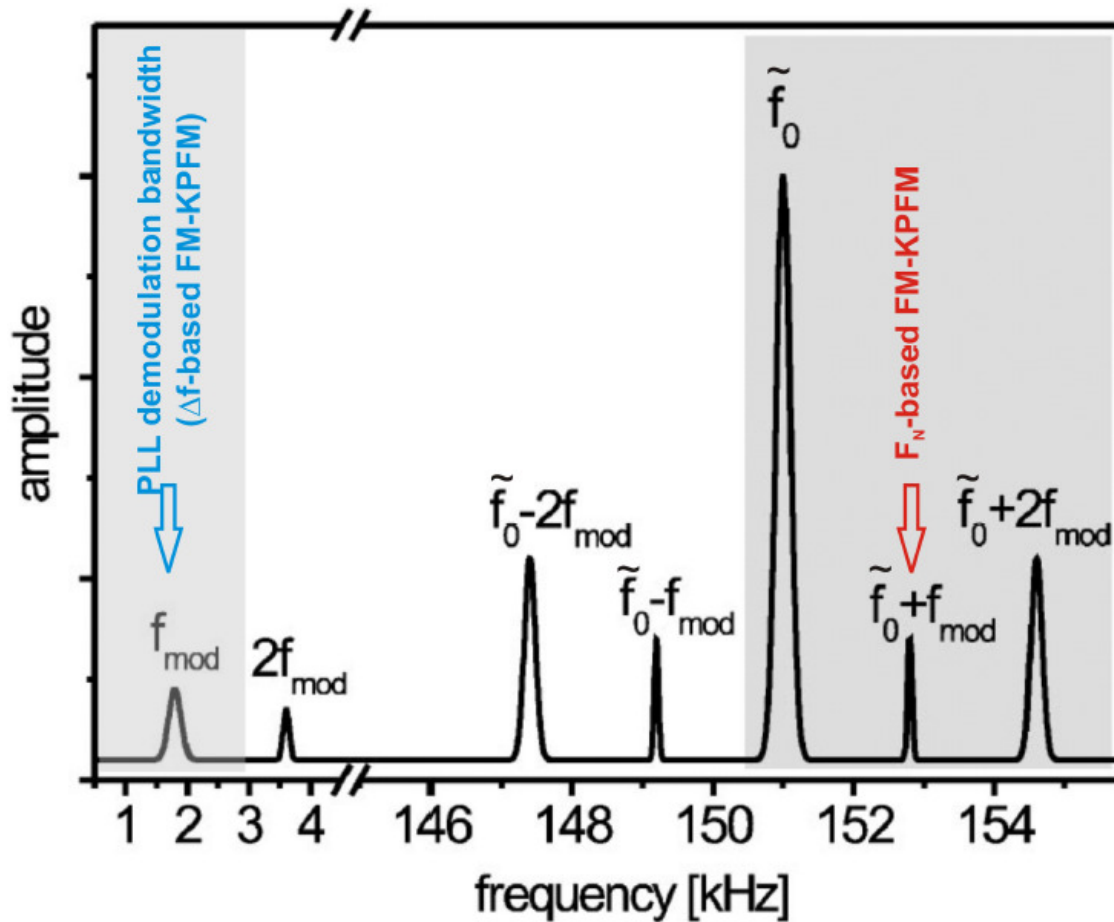

- f_{mod} has to be within the demodulation bandwidth of the PLL → compromise:
 - extending the PLL bandwidth → adds noise to Δf detection
 - must remain large enough to not influence the z regulation (usually requires to slow down the scans)
 - order of magnitude: 1 kHz
- To avoid this, the oscillating component may be used ($f_0 + f_{\text{mod}}$) as the Kelvin LIA input, but then the signal is to be amplified significantly for a proper detection

Frequency-Modulation KPFM: experimental setup

- Data from Th. Glatzel (E.Meyer's group, Basel) in [1]:

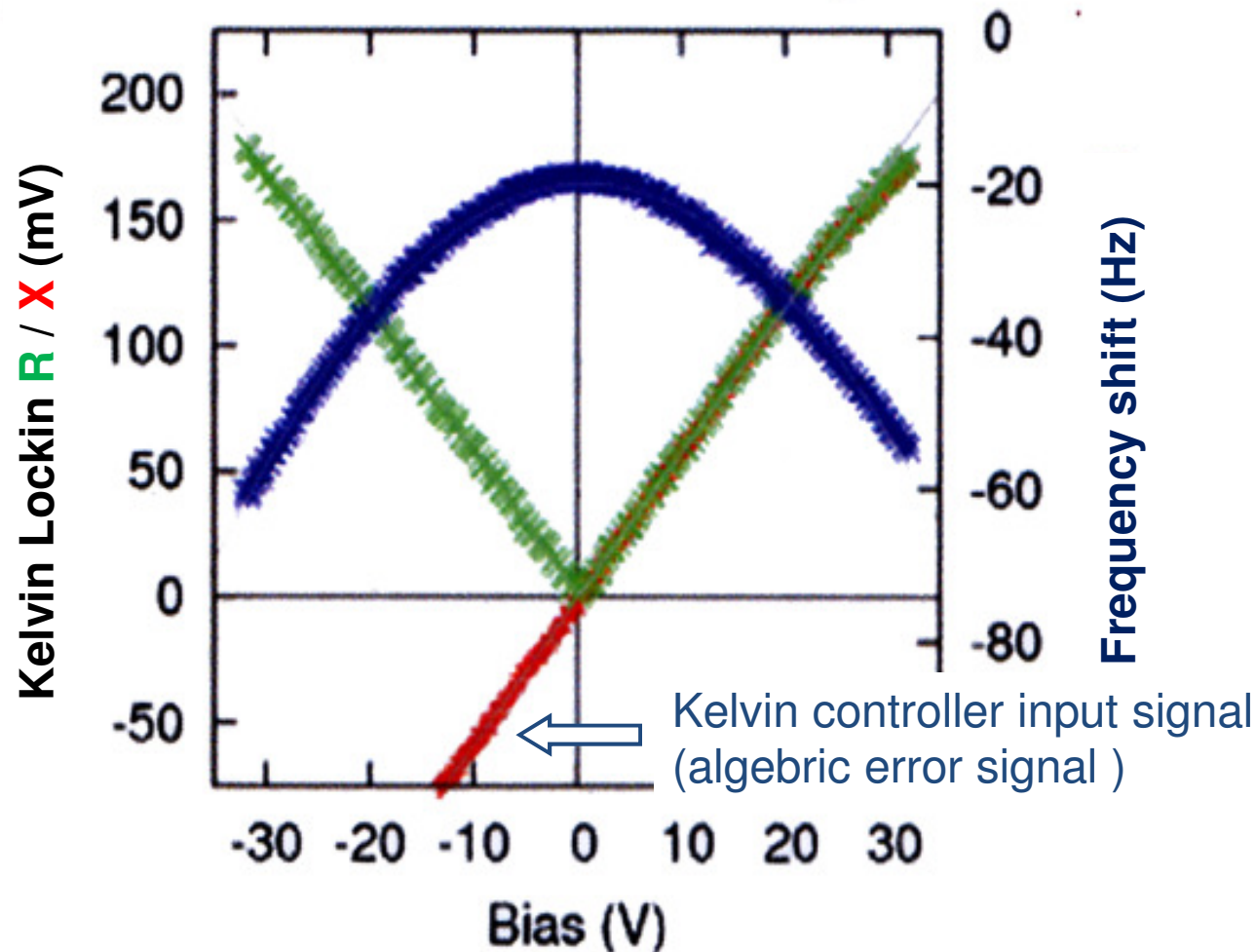

¹*Kelvin Probe Force Microscopy, Measuring & Compensating Electrostatic forces*, Springer Series in Surface Sciences (Th. Glatzel & S. Sadewasser Ed.)

Frequency-Modulation KPFM: experimental setup

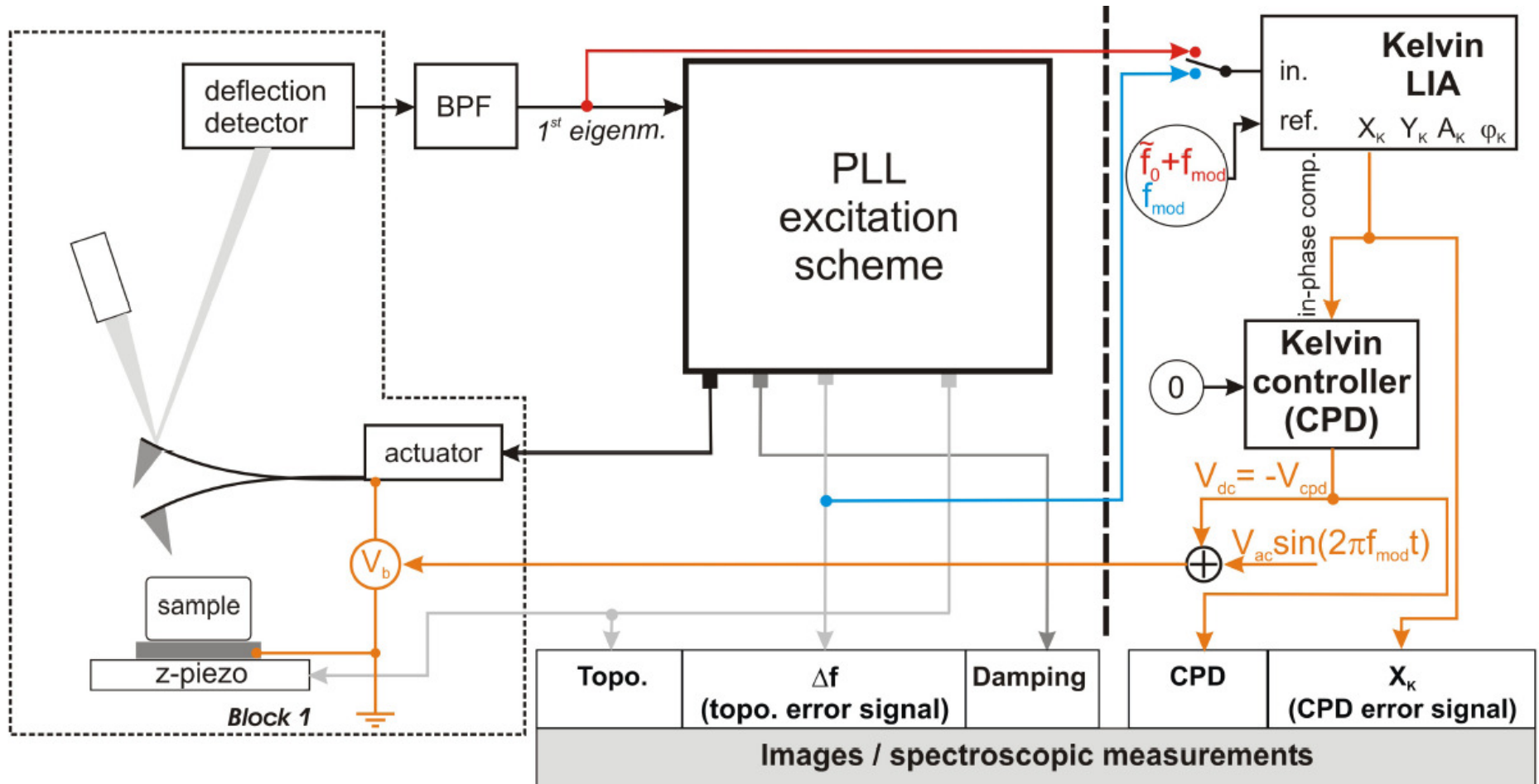

Summary of that section...

- Δf vs $V_{\text{bias}}^{\text{dc}}$ curves give a dc potential value (maximum of the parabola) that relates to the sample's CPD, actually not only concealing the CPD of the bulk material, but information about local charges, dipoles,..., as well
- FM-KPFM is a method where F^{el} , hence Δf , is modulated by the electrostatic force owing to the bias modulation (f_{mod})
- The f_{mod} spectral component of Δf is detected as the X component of the LIA (algebraic signal required)
- The PI controller supplies the proper dc bias that cancels that component, that is the « CPD »

III. Electrostatic models

Generic approach to F^{el}

- Electrostatic energy of an ensemble of point charges inside a capacitor¹:

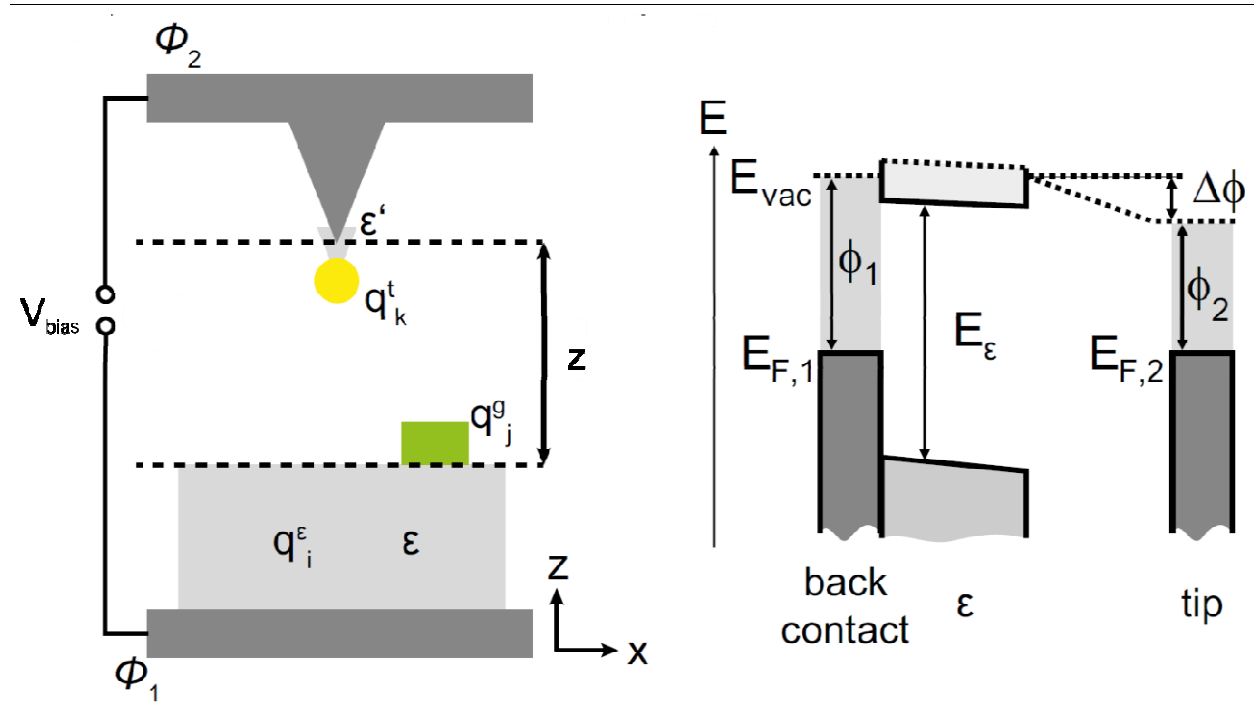

Picture adapted from [2]

$$W^{el} = -\frac{1}{2} C^{(0)} V_{\text{bias}}^2 + \sum_i q_i \phi^{(0)}(\mathbf{r}_i) + \frac{1}{2} \sum_i q_i \phi_{\text{im}}(\mathbf{r}_i) + W_{\text{Coulomb}} \quad (\text{Eq. 13})$$

¹ L. Kantorovich et al., *J. Phys. Cond. Mat.* 12, 795 (2000); L. Kantorovich et al. *Surf. Sci.* 445, 283 (2000)

² J.L. Neff, P. Rahe, *Phys. Rev. B* 91, 085424 (2015)

Generic approach to F^{el}

- Electrostatic energy of an ensemble of point charges inside a capacitor¹:

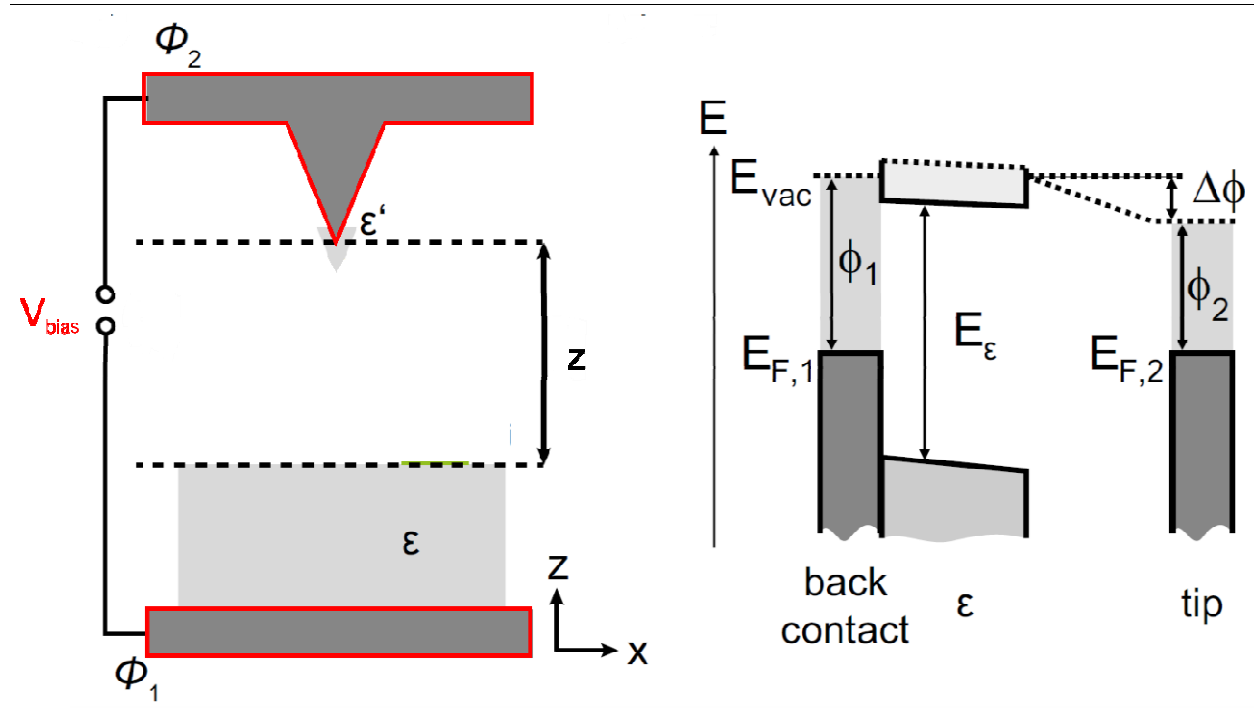

Picture adapted from [2]

$$W^{el} = -\frac{1}{2} C^{(0)} V_{bias}^2 + \sum_i q_i \phi^{(0)}(\mathbf{r}_i) + \frac{1}{2} \sum_i q_i \phi_{im}(\mathbf{r}_i) + W_{Coulomb} \quad (Eq.13)$$

¹ L. Kantorovich et al., *J. Phys. Cond. Mat.* 12, 795 (2000); L. Kantorovich et al. *Surf. Sci.* 445, 283 (2000)

² J.L. Neff, P. Rahe, *Phys. Rev. B* 91, 085424 (2015)

Generic approach to F^{el}

- Electrostatic energy of an ensemble of point charges inside a capacitor¹:

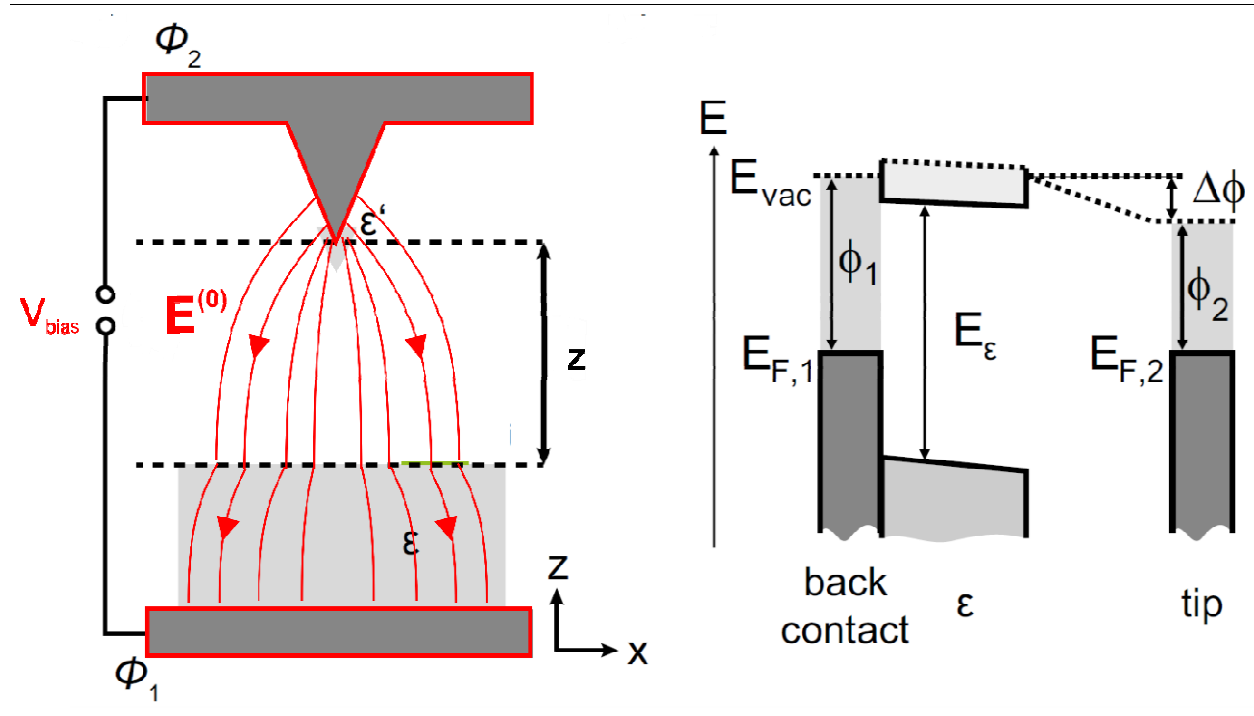

Picture adapted from [2]

$$W^{el} = -\frac{1}{2}C^{(0)}V_{\text{bias}}^2 + \sum_i q_i \phi^{(0)}(\mathbf{r}_i) + \frac{1}{2} \sum_i q_i \phi_{\text{im}}(\mathbf{r}_i) + W_{\text{Coulomb}} \quad (\text{Eq.13})$$

¹ L. Kantorovich et al., *J. Phys. Cond. Mat.* 12, 795 (2000); L. Kantorovich et al. *Surf. Sci.* 445, 283 (2000)

² J.L. Neff, P. Rahe, *Phys. Rev. B* 91, 085424 (2015)

Generic approach to F^{el}

- Electrostatic energy of an ensemble of point charges inside a capacitor¹:

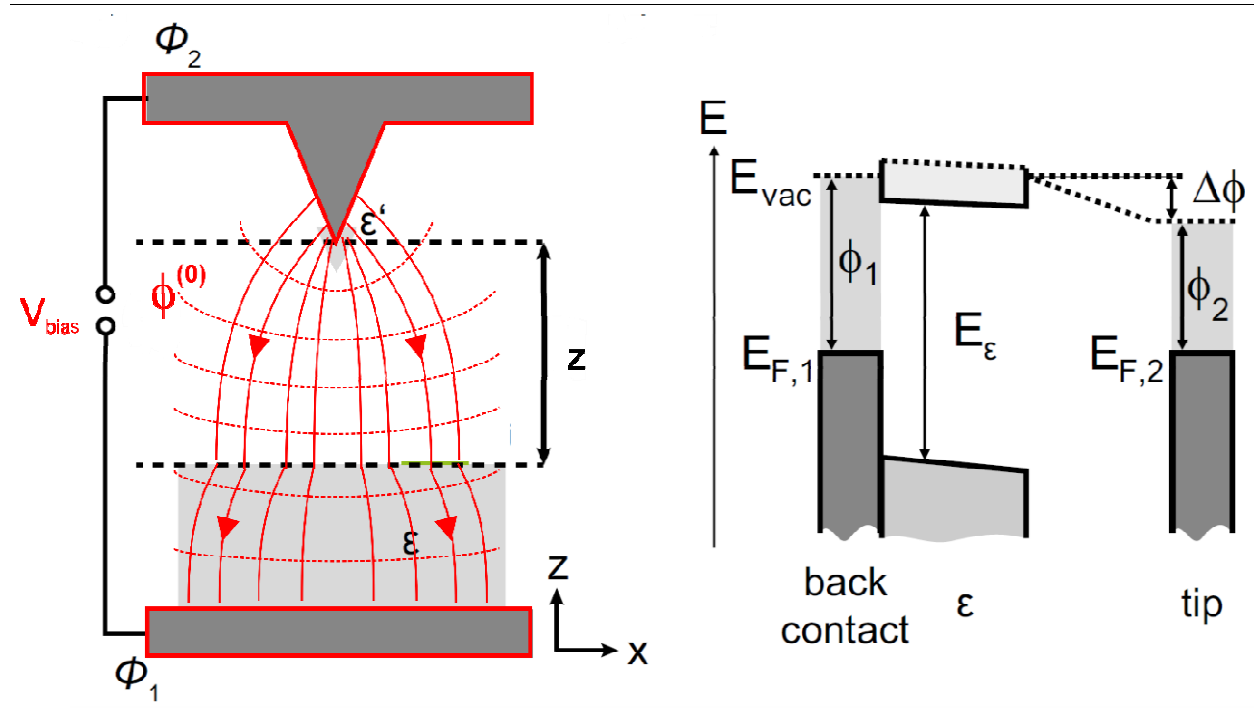

Picture adapted from [2]

$$W^{el} = -\frac{1}{2} C^{(0)} V_{\text{bias}}^2 + \sum_i q_i \phi^{(0)}(\mathbf{r}_i) + \frac{1}{2} \sum_i q_i \phi_{\text{im}}(\mathbf{r}_i) + W_{\text{Coulomb}} \quad (\text{Eq. 13})$$

¹ L. Kantorovich et al., *J. Phys. Cond. Mat.* 12, 795 (2000); L. Kantorovich et al. *Surf. Sci.* 445, 283 (2000)

² J.L. Neff, P. Rahe, *Phys. Rev. B* 91, 085424 (2015)

Generic approach to F^{el}

- Electrostatic energy of an ensemble of point charges inside a capacitor¹:

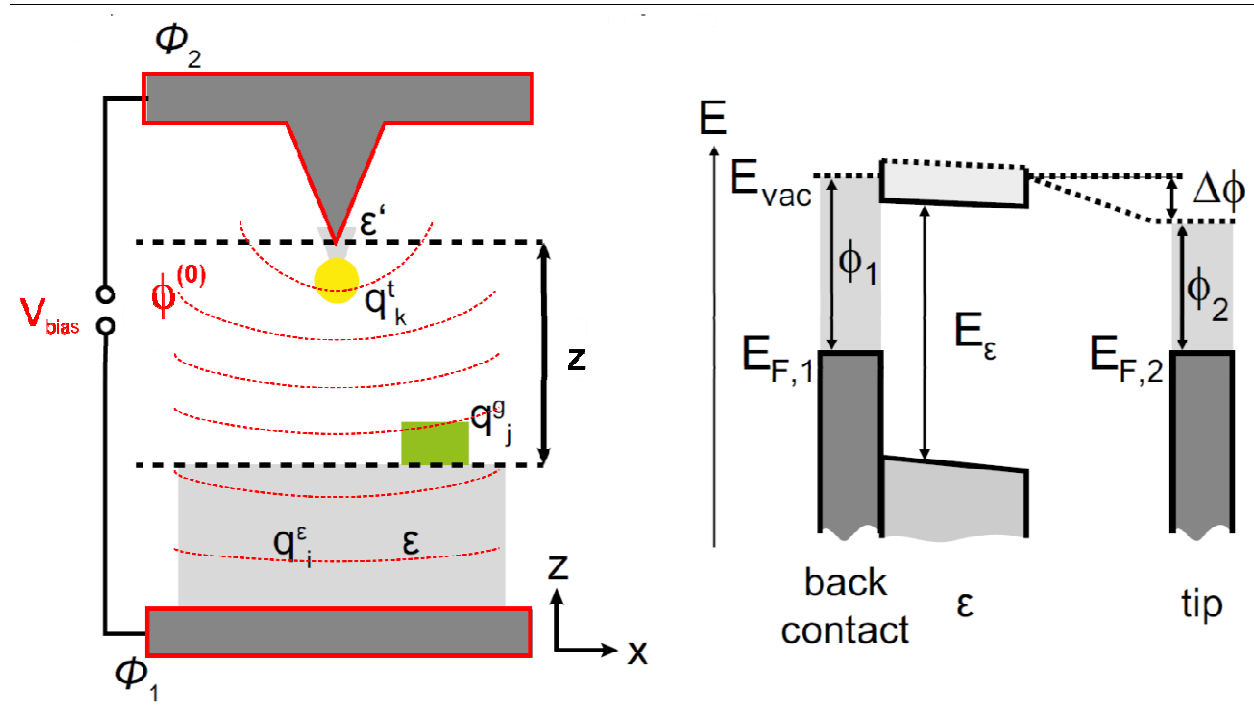

Picture adapted from [2]

$$W^{el} = -\frac{1}{2} C^{(0)} V_{\text{bias}}^2 + \sum_i q_i \phi^{(0)}(\mathbf{r}_i) + \frac{1}{2} \sum_i q_i \phi_{\text{im}}(\mathbf{r}_i) + W_{\text{Coulomb}} \quad (\text{Eq. 13})$$

¹ L. Kantorovich et al., *J. Phys. Cond. Mat.* 12, 795 (2000); L. Kantorovich et al. *Surf. Sci.* 445, 283 (2000)

² J.L. Neff, P. Rahe, *Phys. Rev. B* 91, 085424 (2015)

Generic approach to F^{el}

- Electrostatic energy of an ensemble of point charges inside a capacitor¹:

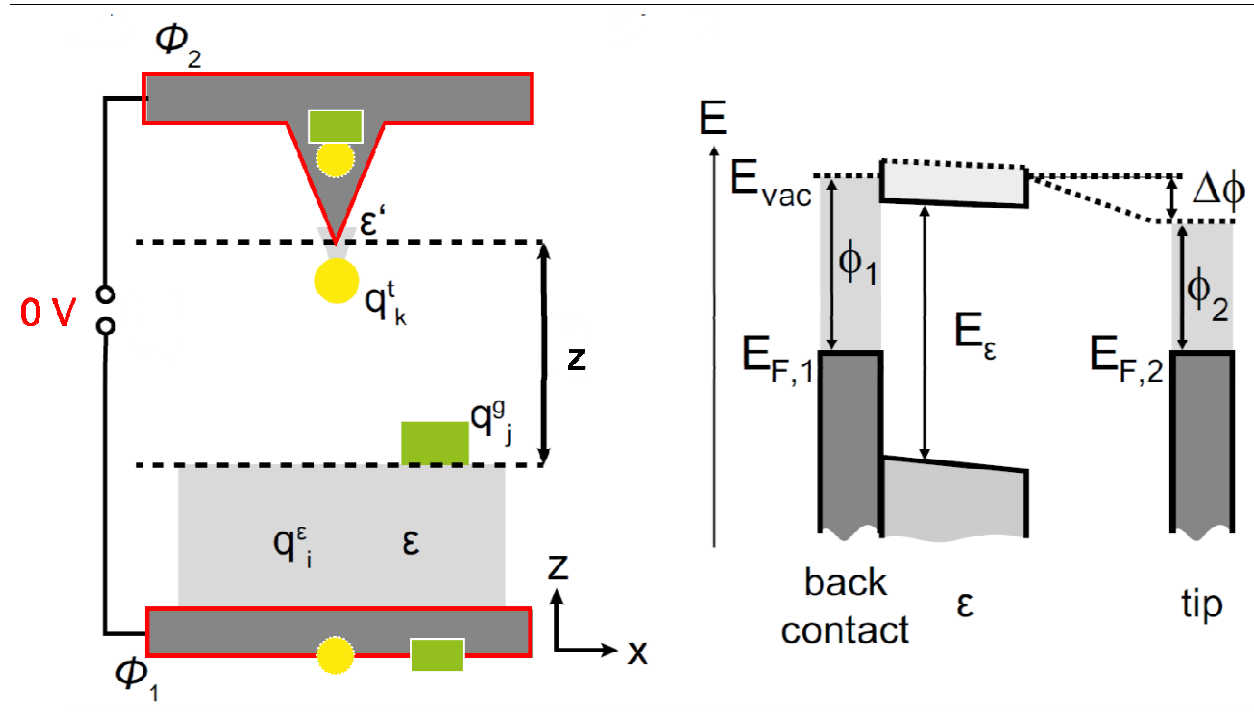

Picture adapted from [2]

$$W^{el} = -\frac{1}{2} C^{(0)} V_{\text{bias}}^2 + \sum_i q_i \phi^{(0)}(\mathbf{r}_i) + \frac{1}{2} \sum_i q_i \phi_{im}(\mathbf{r}_i) + W_{\text{Coulomb}} \quad (\text{Eq. 13})$$

¹ L. Kantorovich et al., *J. Phys. Cond. Mat.* 12, 795 (2000); L. Kantorovich et al. *Surf. Sci.* 445, 283 (2000)

² J.L. Neff, P. Rahe, *Phys. Rev. B* 91, 085424 (2015)

Generic approach to F^{el}

- Electrostatic energy of an ensemble of point charges inside a capacitor¹:

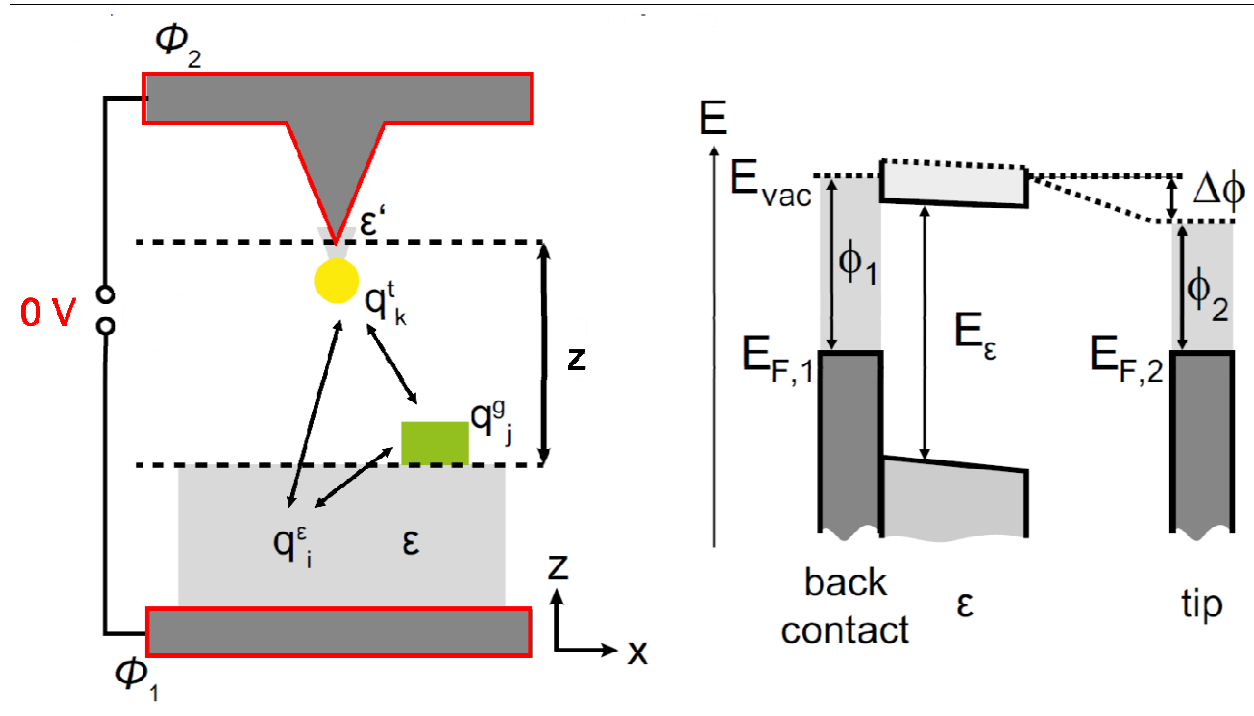

Picture adapted from [2]

$$W^{el} = -\frac{1}{2} C^{(0)} V_{\text{bias}}^2 + \sum_i q_i \phi^{(0)}(\mathbf{r}_i) + \frac{1}{2} \sum_i q_i \phi_{\text{im}}(\mathbf{r}_i) + W_{\text{Coulomb}} \quad (\text{Eq. 13})$$

¹ L. Kantorovich et al., *J. Phys. Cond. Mat.* 12, 795 (2000); L. Kantorovich et al. *Surf. Sci.* 445, 283 (2000)

² J.L. Neff, P. Rahe, *Phys. Rev. B* 91, 085424 (2015)

Generic approach to F^{el}

$$\vec{F}_{tot} = \vec{F}_{LR} + \vec{F}_{SR} = \left[\vec{F}_{LR}^{el} + \vec{F}_{LR}^{vdW} \right] + \left[\vec{F}_{SR}^{el} + \vec{F}_{SR}^{vdW} \right]$$

□ W^{el} requires to know the potential generated by the void capacitor upon biasing: **mesoscopic range (mm-nm)**

✓ Usually: finite elements methods + Poisson equation or Green's formalism + boundary conditions

□ Charges and dipoles yield *short-range electrostatic forces*: **microscopic range (nm-pm)**

✓ Ab initio computational methods, or analytic methods

PHYSICAL REVIEW B **86**, 075407 (2012)

Multiscale approach for simulations of Kelvin probe force microscopy with atomic resolution

Ali Sadeghi, Alexis Baratoff, S. Alireza Ghasemi, Stefan Goedecker, Thilo Glatzel, Shigeki Kawai, and Ernst Meyer
Department of Physics, University of Basel, Klingelbergstrasse 82, CH-4056 Basel, Switzerland

PHYSICAL REVIEW B **91**, 085424 (2015)

Insights into Kelvin probe force microscopy data of insulator-supported molecules

Julia L. Neff

Institut für Physikalische Chemie, Johannes Gutenberg Universität Mainz, Duesbergweg 10-14, 55099 Mainz, Germany

Philipp Rahe*

Department of Physics and Astronomy, The University of Utah, 115 South 1400 East, Salt Lake City, Utah 84112-0830, USA
(Received 1 September 2014; revised manuscript received 28 January 2015; published 24 February 2015)

Examples: 1- double capacitance model (mesoscopic model)

- A charge inside the capacitor¹:

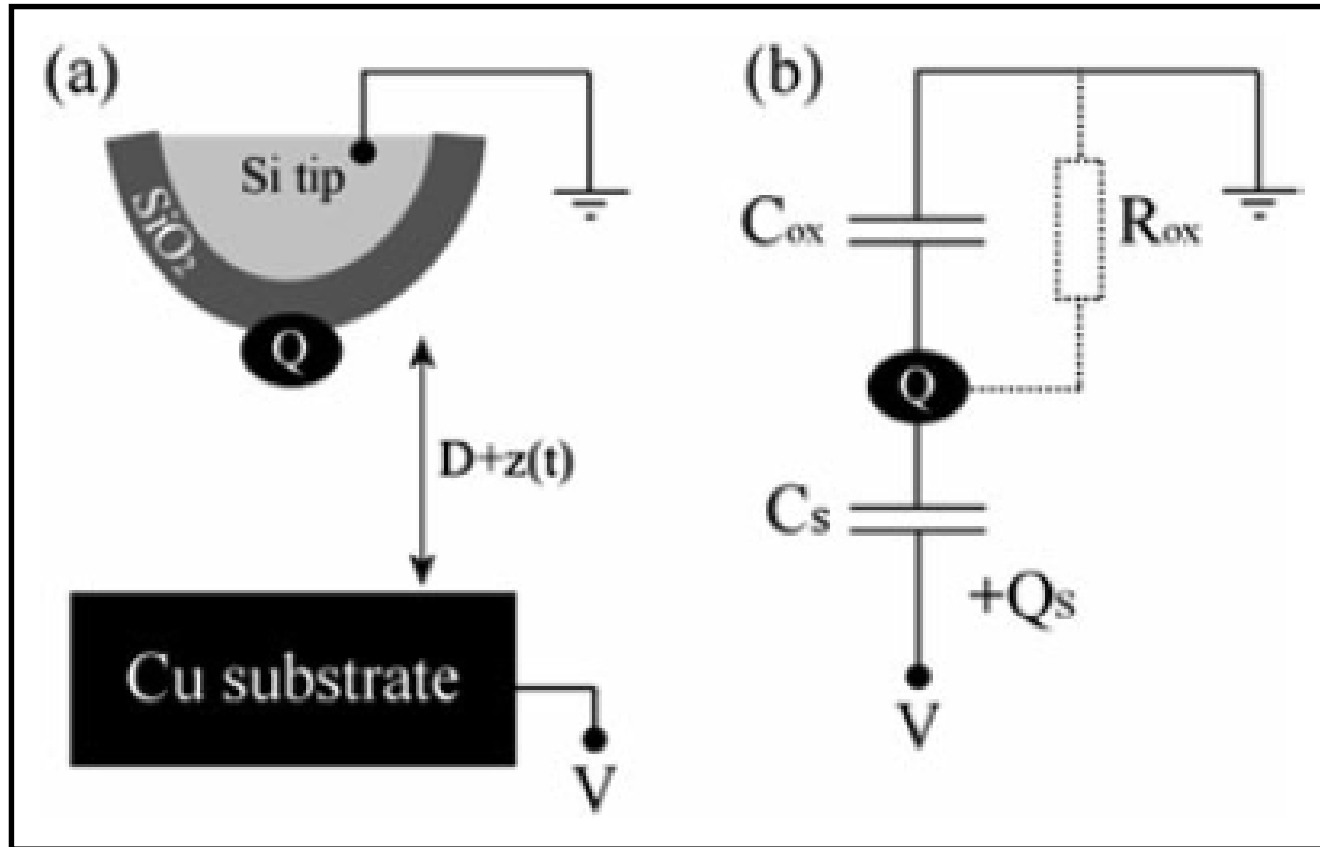

J. Polesel et al., Nanotechnology 15, S24 (2004)

Examples: 1- double capacitance model (mesoscopic model)

□ A charge inside the capacitor¹:

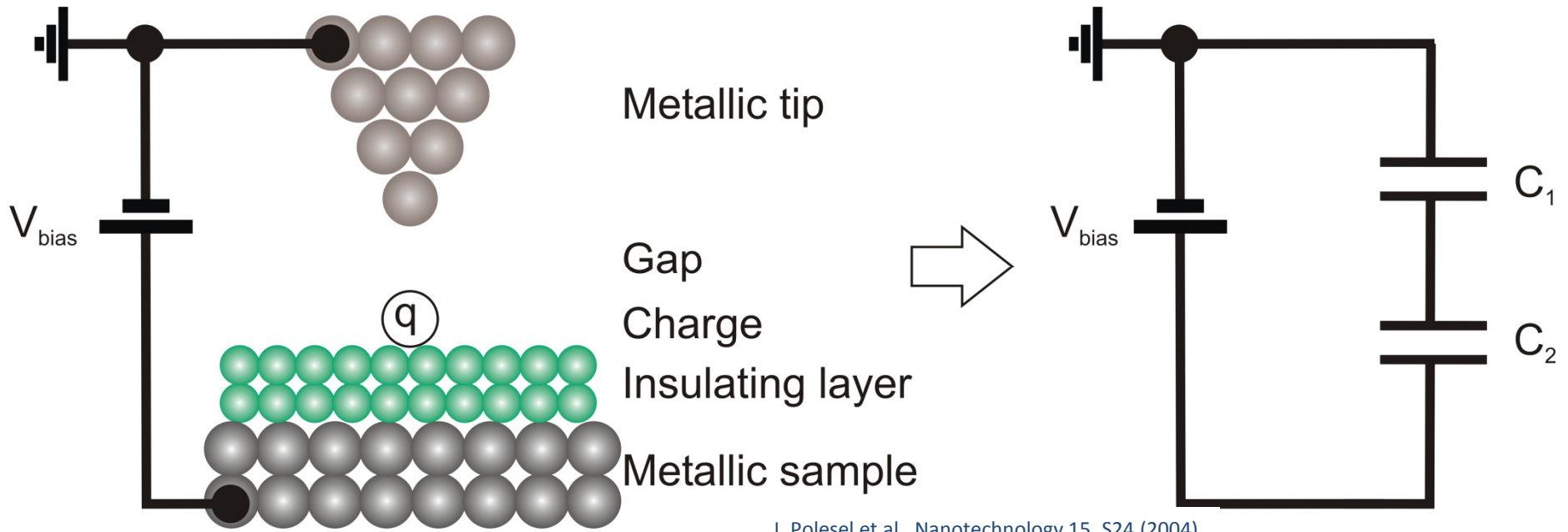

J. Polesel et al., Nanotechnology 15, S24 (2004)

$$F^{\text{el}} = \frac{1}{C_{\Sigma}^2} \frac{\partial C_1}{\partial z} \left(\frac{q^2}{2} + \frac{1}{2} C_2^2 V_{\text{bias}}^2 - C_2 q V_{\text{bias}} \right) \quad (\text{Eq.14})$$

¹Nanoelectronics and Information Technology: Advanced Electronic Materials and Novel Devices, edited by R. Waser (John Wiley & Sons, New York, 2003); R. Stomp et al., Pys. Rev. Lett. 94 , 056802 (2005); J. Polesel et al., Nanotechnology 15, S24 (2004)

Examples: 2- microscopic approach to F^{el} : polarizability

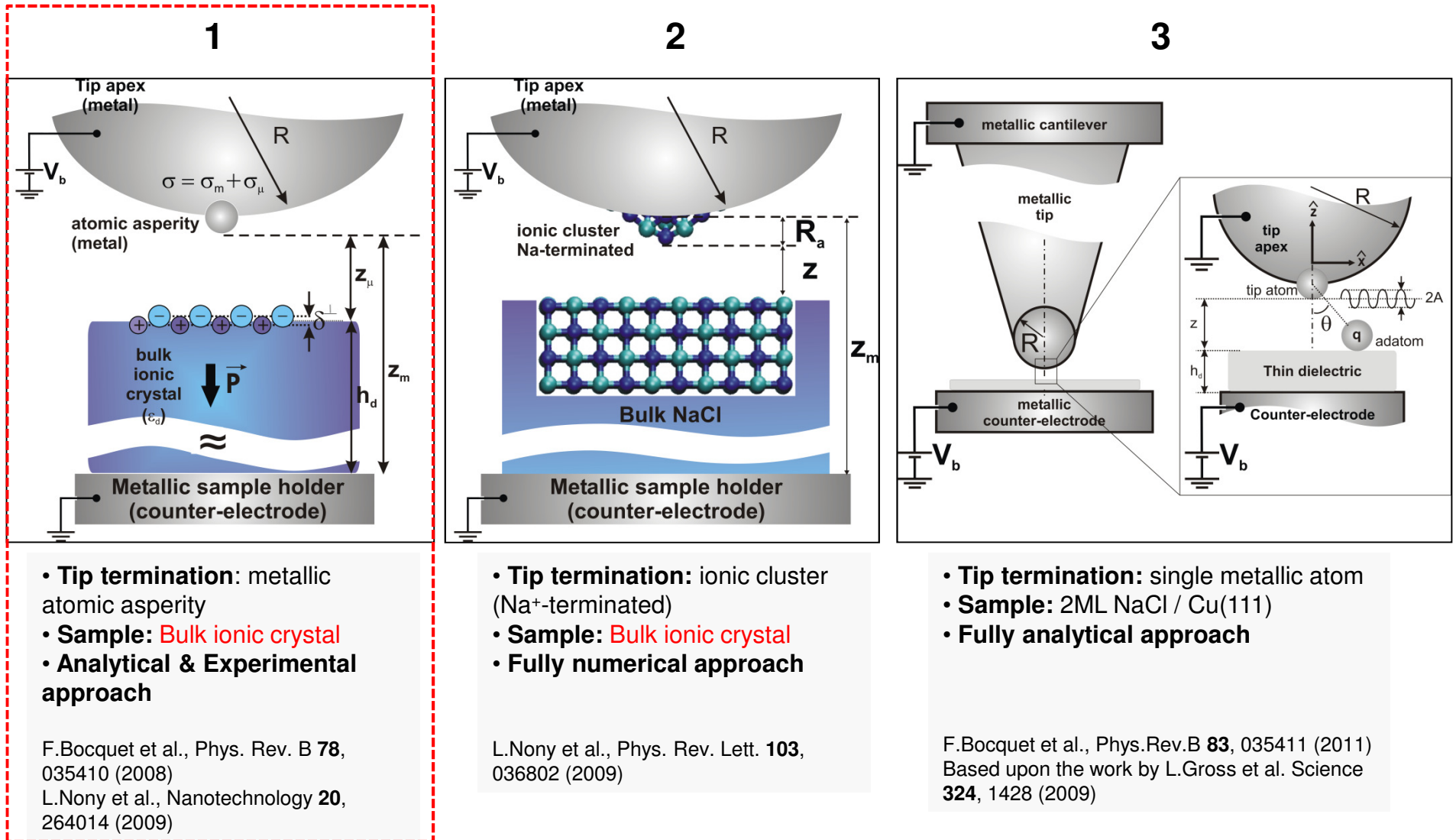

Examples: 2- microscopic approach to \mathbf{F}^{el} : polarizability

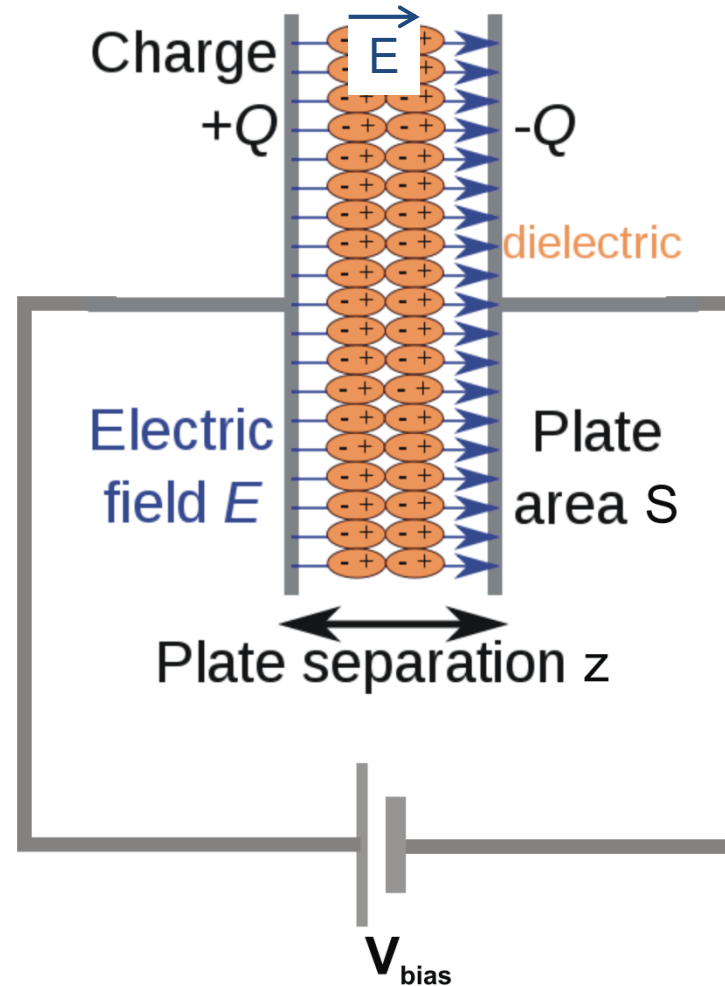

polarizability

$$\vec{p} = \alpha \epsilon_0 \vec{E}$$

Dipole moment of each part of dielectric within the capacitance:

Examples: 2- microscopic approach to F^{el} : polarizability

Interaction force : $F(z) = F_{lr}(z) + F_{es}(z) + F_{sr}(z)$ with $F_{es} = \int_{\text{tip}} \frac{\sigma^2}{2\epsilon_0} \hat{n} \cdot \hat{u}_z dS$

Building the analytic approach to F_{es} :

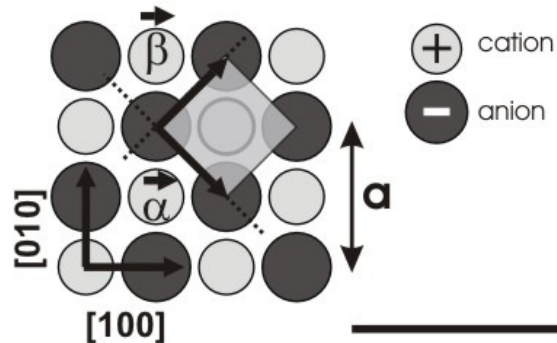

- ☑ Crystal surface has a perfect fcc structure, carrying **neither local charge nor dipole**
- ☑ The **Madelung potential expands at the surface²**, although decaying exponentially fast

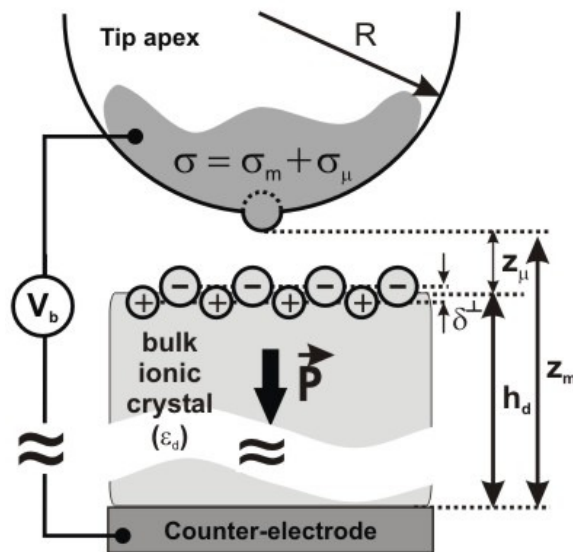

- ☑ **Tip apex**: microscopic structure (nano-asperity, area 1, radius R_a) + mesoscopic half-sphere (area 2, radius R): **METALLIC**
- ☑ **Sample**: topmost infinite layer of alternate point charges + bulk treated as a continuous medium
- ☑ Surface charge density that develops on the tip has 2 origins:
 - ☞ **capacitive contribution (mesoscopic): σ_m , connected with V_b**
 - ☞ **Madelung surface potential-mediated contribution (microsc.): σ_μ**
- ☑ **Description of the ionic polarization of the sample , self-consistency**
- ☑ Classical approach

¹ F. Bocquet *et al.*, Phys. Rev. B **78**, 035410 (2008); ² R. Watson *et al.*, Phys. Rev. B **24**, 1791 (1981)

Examples: 2- microscopic approach to F^{el} : polarizability

Superposition principle :

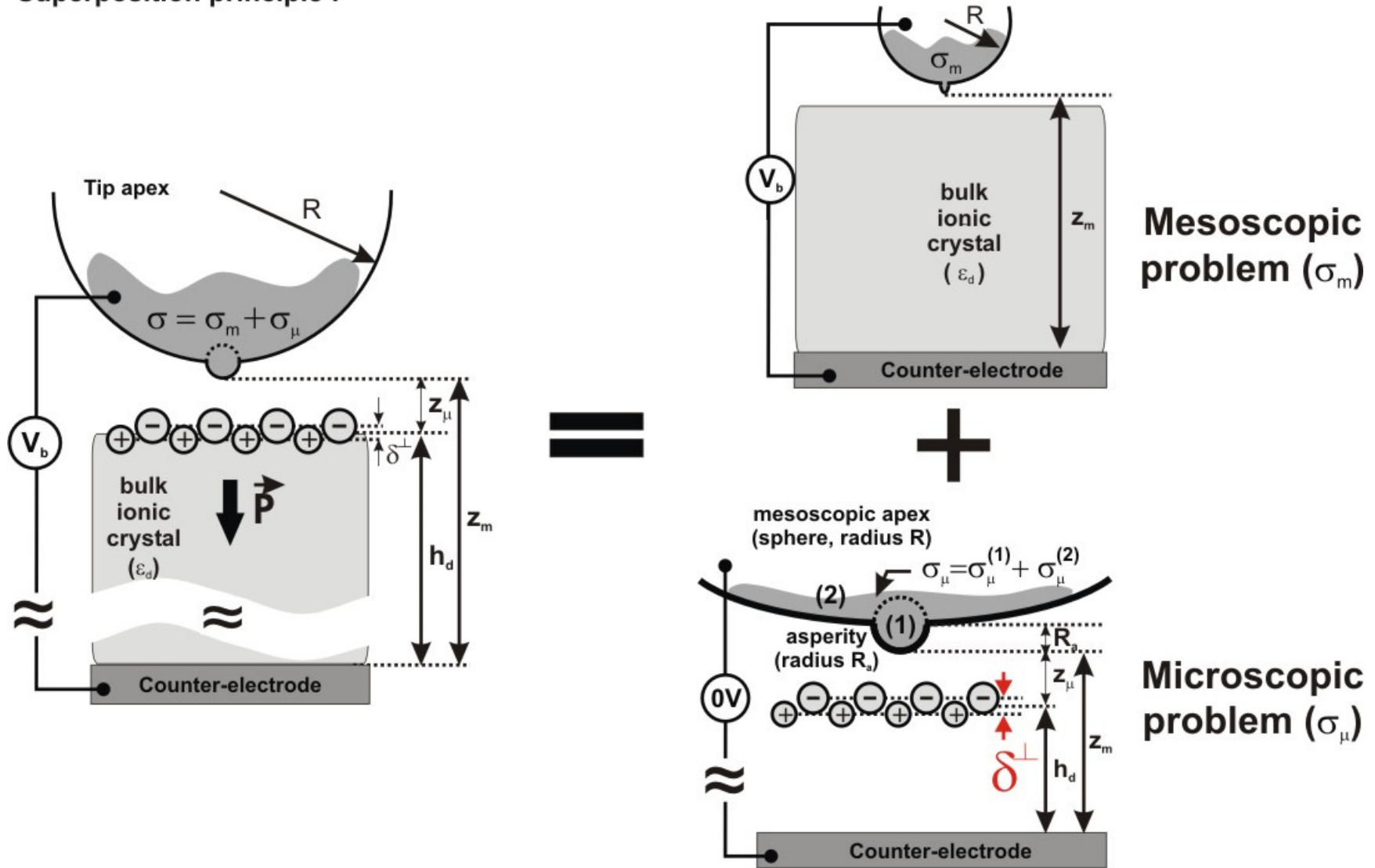

Examples: 2- microscopic approach to F^{el} : polarizability

Madelung surface potential¹:

$$V_s(x, y, z, \mu) = - \frac{q}{\pi \epsilon_0 a'} \cosh[\tilde{\delta}^\perp(V_b)] \tilde{\chi}(x, y) e^{-(2\pi/a')z, \mu}$$

Polarization, i.e. **Bias dependence**

Lateral periodicity (in plane)

$$\tilde{\chi}(x, y) = \cos\left[\frac{2\pi}{a'}(x - x_0)\right] + \cos\left[\frac{2\pi}{a'}(y - y_0)\right]$$

Distance dependence

"...when considering an infinite planar slab of point charges, the Madelung surface potential reaches its asymptotic value in a very short distance normal to the slab. Consequently, the ions within the crystal at a distance only one lattice constant from the surface have Madelung potentials, which are indistinguishable from those of the bulk."

¹ R.Watson *et al.*, Phys. Rev. B **24**, 1791 (1981)

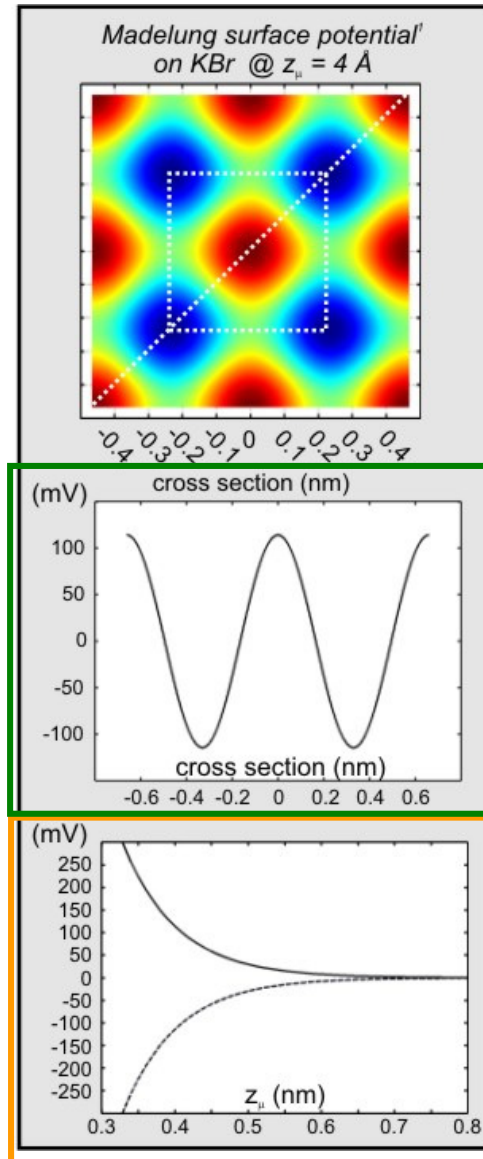

Examples: 2- microscopic approach to F^{el} : polarizability

$$F_{es} = \int_{\text{tip}} \frac{(\sigma_m + \sigma_\mu)^2}{2\epsilon_0} \hat{n} \cdot \hat{u}_z dS = F_m + F_{m\mu} + F_\mu$$

- F_m : negligible (counter-electrode too far)
- $F_{m\mu}^{(2)}$: capacitive coupling on the mesoscopic part of the tip decays fast; negligible compared to $F_{m\mu}^{(1)}$; tip enhancement effect
- $F_\mu^{(1)}$: negligible compared to $F_\mu^{(2)}$ (not obvious, geometry dependent)

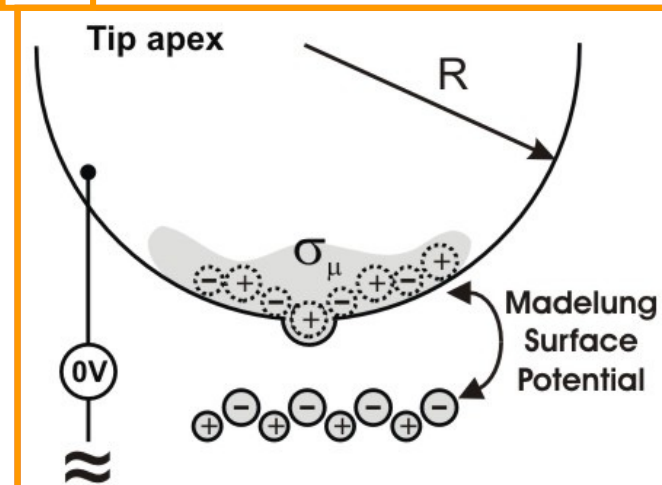

$$F_{es} = F_{m\mu}^{(1)} + F_\mu^{(2)}$$

- short-range
- Lateral periodicity of the MSP
- Proportional to V_b

- short-range
- V_b^2 dependence (required!!!) induced by the **polarization**
- No lateral periodicity

$$F_{es}(V_b) = B \times V_b \exp\left\{-\frac{2\pi}{a'} z_\mu\right\} \times [\cos(\tilde{x}_0) + \cos(\tilde{y}_0)] + (AV_b^2 + C) \times \exp\left\{-\frac{4\pi}{a'} z_\mu\right\}$$

with $V_b = V_{dc} + V_{ac} \sin(2\pi f_K t)$

short-range electrostatic force

Examples: 2- microscopic approach to F^{el} : polarizability

$$F_{es} = \int_{\text{tip}} \frac{(\sigma_m + \sigma_\mu)^2}{2\epsilon_0} \hat{n} \cdot \hat{u}_z dS = F_m + F_{m\mu} + F_\mu$$

- ☞ F_m : negligible (counter-electrode too far)
- ☞ $F_{m\mu}^{(2)}$: capacitive coupling on the mesoscopic part of the tip decays fast; negligible compared to $F_{m\mu}^{(1)}$; tip enhancement effect
- ☞ $F_\mu^{(1)}$: negligible compared to $F_\mu^{(2)}$ (not obvious, geometry dependent)

$$F_{es} = F_{m\mu}^{(1)} + F_\mu^{(2)}$$

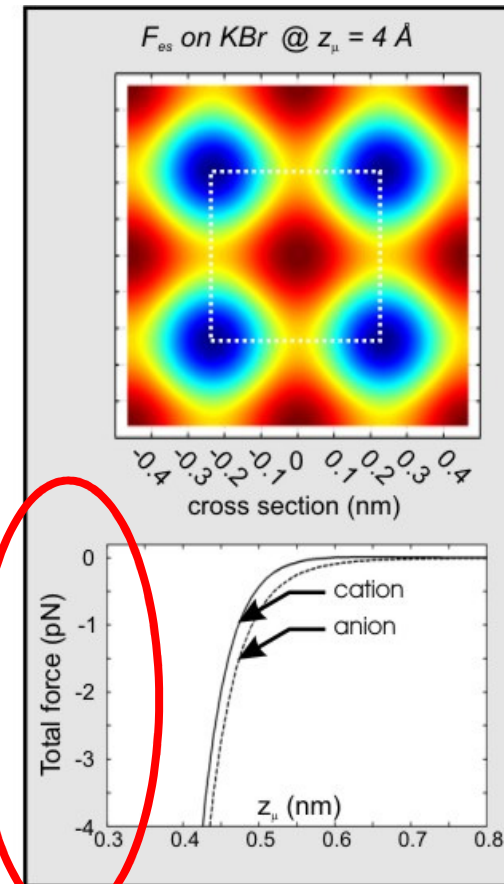

$$F_{es}(V_b) = B \times V_b \exp \left\{ -\frac{2\pi}{a'} z_\mu \right\} \times [\cos(\tilde{x}_0) + \cos(\tilde{y}_0)] + (AV_b^2 + C) \times \exp \left\{ -\frac{4\pi}{a'} z_\mu \right\}$$

with $V_b = V_{dc} + V_{ac} \sin(2\pi f_K t)$

short-range electrostatic force (Eq. 15)

Summary of the section...

- ❑ The quantitative interpretation of the KPFM signal requires sophisticated multiscale approaches: mesoscopic range (CPD), microscopic range (charges, dipoles, polarization effects...)
- ❑ Due to charges, dipoles, polarization effects,..., the electrostatic force is a function of the bias with the form:

$$F^{\text{el}} = AV_{\text{bias}}^2 + BV_{\text{bias}} + C$$

- ❑ Hence, the f_{mod} -modulated component has the form:

$$F^{\text{el}, f_{\text{mod}}} = [B + 2A(V_{\text{dc}} - V_{\text{CPD}})] V_{\text{ac}} \sin(2\pi f_{\text{mod}} t)$$

- ❑ Therefore:

$$V_{\text{dc}} = V_{\text{CPD}} - \frac{B}{2A}$$

- ✓ The measured « CPD » conceals the physics of the interface (parameters A & B): charges, dipoles, polarization effects...
- ✓ B and A are **tip geometry- and distance-dependent**...
- ✓ Extracting quantitative parameters (number of charges...) requires the void capacitor to be perfectly characterized

Summary of the section...

- The quantitative interpretation of the KPFM signal requires sophisticated multiscale approaches: mesoscopic range (CPD), microscopic range (charges, dipoles, polarization effects...)
- Due to charges, dipoles, polarization effects,..., the electrostatic force is a function of the bias with the form:

$$F^{\text{el}} = AV_{\text{bias}}^2 + BV_{\text{bias}} + C$$

- Hence, the f_{mod} -modulated component has the form:

$$F^{\text{el}, f_{\text{mod}}} = [B + 2A(V_{\text{dc}} - V_{\text{CPD}})] V_{\text{ac}} \sin(2\pi f_{\text{mod}} t)$$

- Therefore:

$$V_{\text{dc}} = V_{\text{CPD}} - \frac{B}{2A}$$

$$V_{\text{DC}}^{(c)} = V_{\text{cpd}} - \frac{C_1 a_1 e^{-\alpha z_{\text{min}}}}{2C_2 b_1 e^{-2\alpha z_{\text{min}}} + 4\pi C_2' A_0 / z_M^3}$$

L.Nony et al., Nanotechnology **20**, 264014 (2009)

$\Delta V_{\text{FM-KPFM}}$

$$= \frac{\Delta\phi}{e} + \frac{\sum_i q_i \int_{-A_0}^{A_0} \frac{\partial \tilde{\Phi}^{(0)}(\vec{r}_i)}{\partial d} \Big|_{d+A_0-\tau} \frac{\tau}{\sqrt{A_0^2 - \tau^2}} d\tau}{\int_{-A_0}^{A_0} \frac{\partial C^{(0)}}{\partial d} \Big|_{d+A_0-\tau} \frac{\tau}{\sqrt{A_0^2 - \tau^2}} d\tau}$$

J.Neff et al., PRB **91**, 085434 (2015)

Summary of the section...

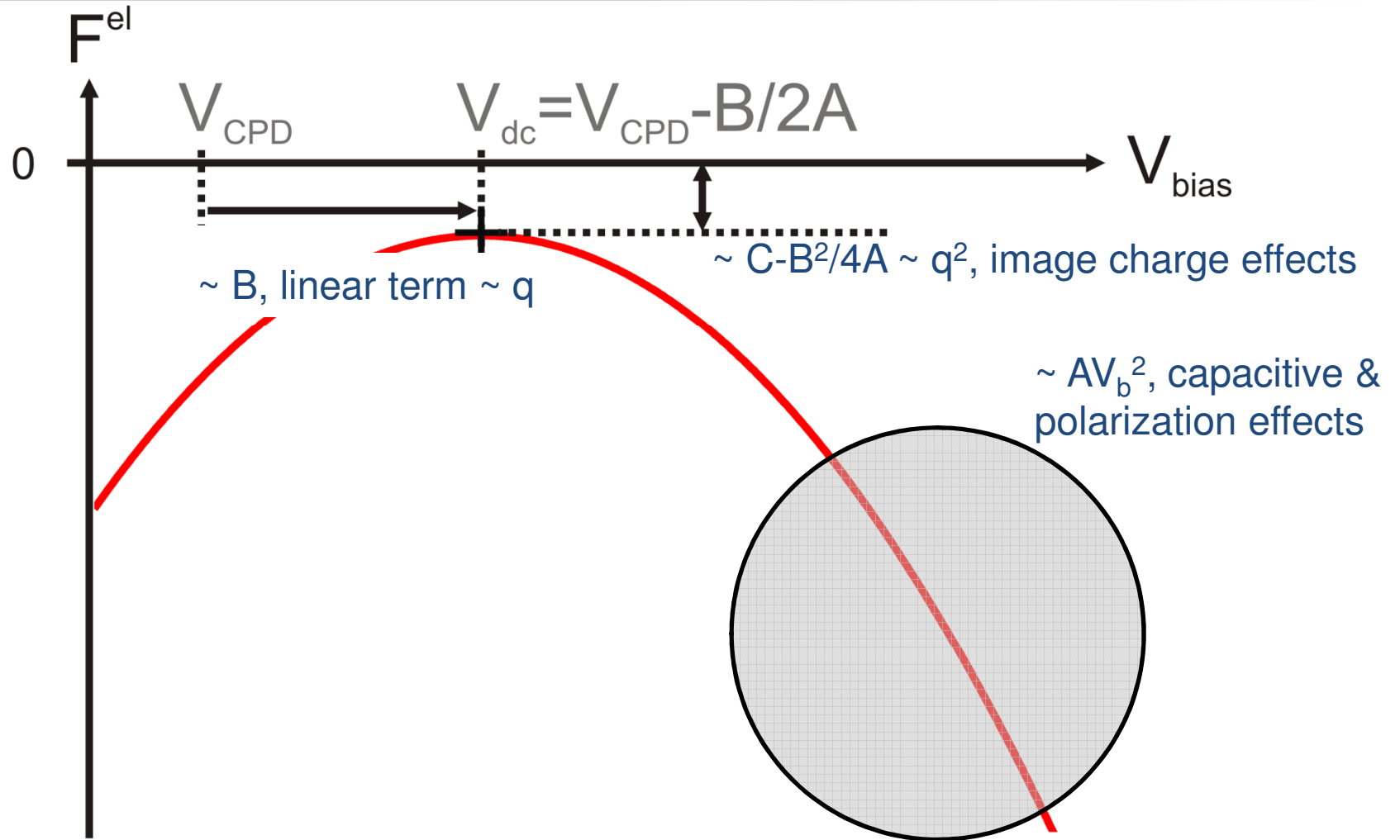

IV. Examples of applications

- Long-range regime
- Short-range regime

Huge amount of published results about KPFM...

- B.D. Terris et al., Phys. Rev. Lett. **63**, 2669 (1989)
- H. Jacobs et al. J. Appl. Phys. **84**, 1168 (1998)
- J. Colchero et al. Phys. Rev. B **64**, 245403 (2001)
- A. Gil et al. Nanotechnology **14**, 332 (2003)
- Y. Azuma et al., Phys. Rev. Lett. **96**, 016108 (2006)
- K. Sajewicz et al. Jap. J. Appl. Phys. **49**, 025201 (2010).
- **IBM Zurich lab.:** L. Gross et al. Science **324** :1428–1431 (2009); F. Mohn et al. Nature Nanotechnology **7**(4), 227–231 (2012); B. Schuler et al. *Nano Letters* **14**, 3342-3346 (2014); F. Albrecht et al. Phys. Rev. B **92**, 235443 (2015) ...
- **C. Barth:** C. Barth et al., New J. Phys. **12**, 093024 (2010); B. Hoff et al., J. Phys. Chem. C **118**, 14569 (2014); E. Palacios-Lidon et al., ACS Catalysis **4**, 1838 (2014); B. Hoff et al. Nanoscale **8**, 411-419 (2016)...
- **E. Meyer group**, Uni. Basel, Switzerland: T. Glatzel et al., Appl. Surf. Sci. **210**, 84 (2003); S. Kawai et al. Nanotechnology **21**, 245704 (2010); R. Pawlak et al. Nano Lett. **13**, 5803-5807 (2013); A. Henning et al., Beilstein Journal of Nanotechnology, **4**, 418-428 (2013); B. Eren et al., Appl. Phys. Lett, **108**, 041602 (2016)...
- **S. Gauthier**, CEMES, France: A. Hinaut et al., Beilstein journal of Nanotechnology **3**, 221-229 (2012)...
- **B. Grévin**, CEA France: Y. Luo et al. Adv. Mater. **19**, 2267-2273 (2007); E. Spadafora et al., Nano Lett. **10**, 3337 (2010); E. Spadafora et al. Appl. Phys. Lett. **99**, 233102 (2011); F. Fuchs et al., Phys.Rev.B **88**, 205423 (2013); F. Fuchs et al. ACS Nano **10**, 739–746 (2016)...
- **T. Mélin**, IEMN, France: T. Mélin et al., Phys. Rev. Lett. **92**, 166101 (2004); S. Barbet et al., J. Appl. Phys. **115**, 144313 (2014); H. Diesinger et al., Beilstein Journal of Nanotechnology **5**, 1-18 (2014); E. Palleau et al., Nanotechnology **21**, 225706 (2010); H. Diesinger et al., Ultramicroscopy **110**, 162-169 (2010)...
- **S. Sadewasser**, INL Portugal: S. Sadewasser et al., Phys. Rev. Lett. **103**, 266103 (2009); R. Baier et al., Phys. Rev. B **85**, 165436 (2012); F. Mesa, et al. J. Nanotechnol. **3**, 277-284 (2012)...
- **P. Grütter**, Mc Gill, Canada: R. Stomp et al., Phys. Rev. Lett. **94**, 056802 (2005); S.A. Burke et al., Nanotechnology **20**, 264012 (2009); Y. Miyahara et al. Phys. Rev. Appl. **4**, 054011 (2015)...
- **P. Jelineck group**, Praha, Czech Rep.: F. Albrecht et al. Phys. Rev. Lett. **115**, 076101 (2015); M. Ondráček et al. Nanotechnology **27**, 274005 (2016); P. Hapala et al., Nat. Commun. **7**, 11560 (2016)...
- **Sorry for the others...**

KPFM on metallic surfaces including adsorbates:

□ Thin insulating inorganic films :

KCl on Au(111)¹ (FM-KPFM):

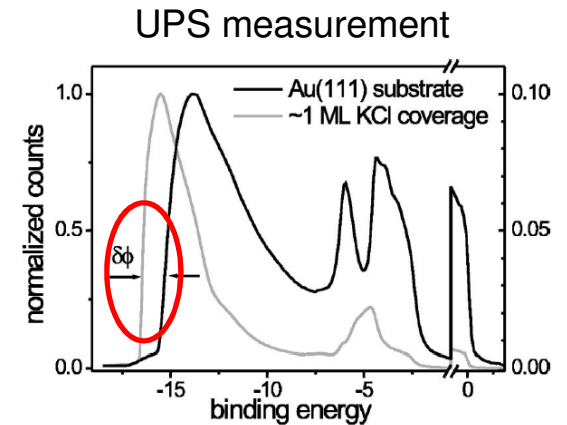
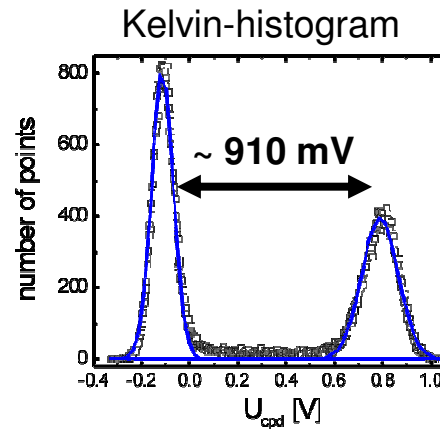
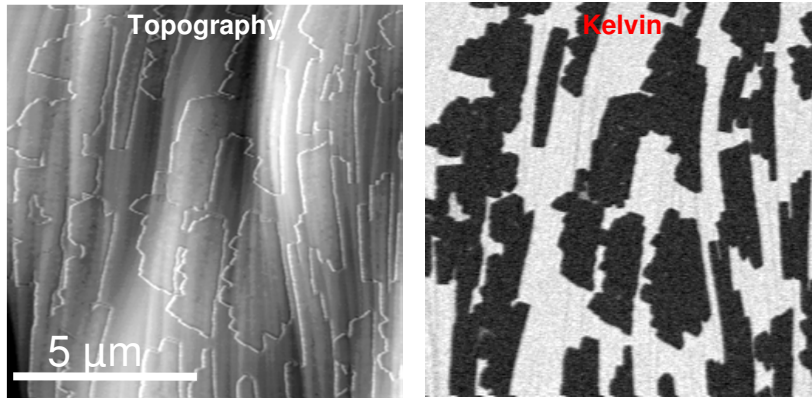

- KCl islands decrease the CPD: interface dipole decreased (c.t. to the sample)
- Quantitative measurement of the CPD in the LR regime when the adsorbates are larger than the tip radius

¹U. Zerweck *et al.*, Phys. Rev. B **71**, 125424 (2005);

KPFM on metallic surfaces including adsorbates:

□ Thin insulating inorganic films :

Ionic thin films on Au(111)¹ (FM-KPFM):

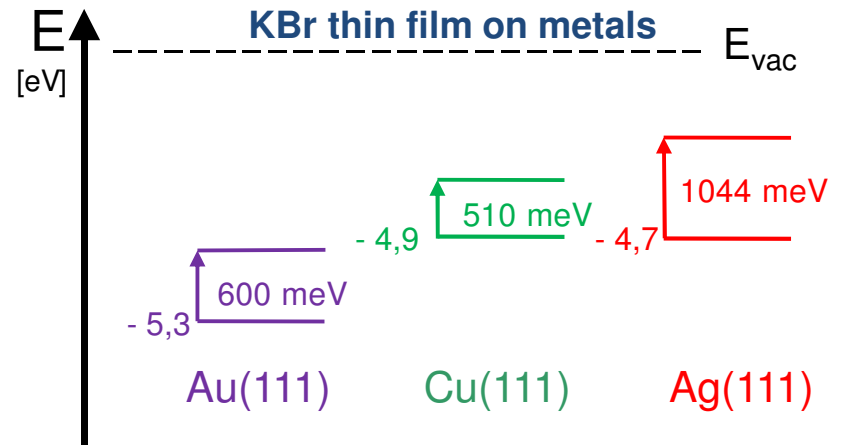
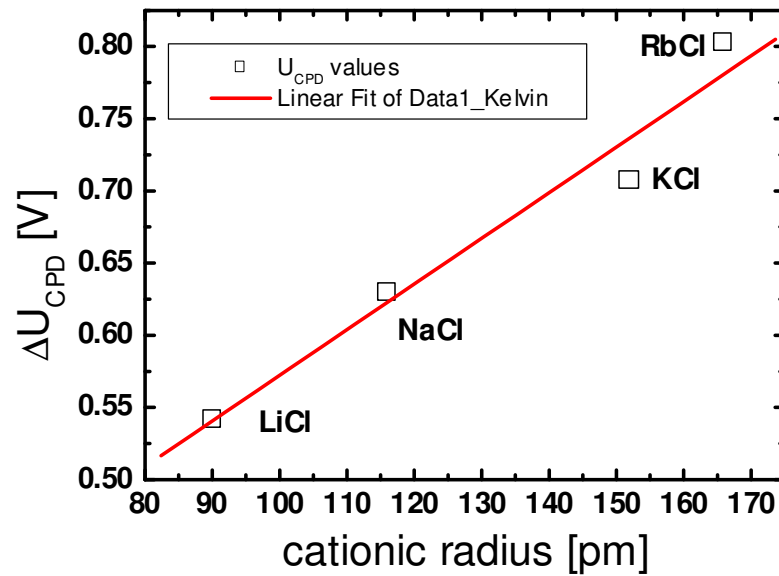

- Interface dipole varies with the nature of the metal
- Adsorption properties must change

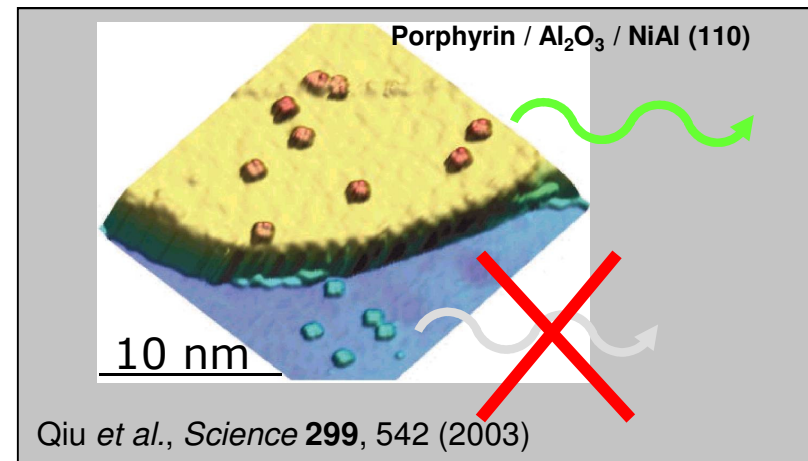

¹Ch. Loppacher *et al.*, *Nanotechnology* **15**, S9 (2004)

KPFM on metallic surfaces including adsorbates:

□ Molecular organic films :

CuPc on Au(111)¹ (FM-KPFM):

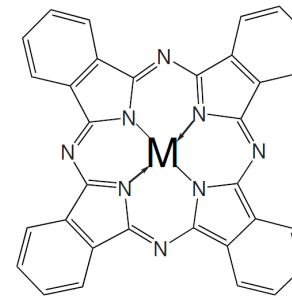
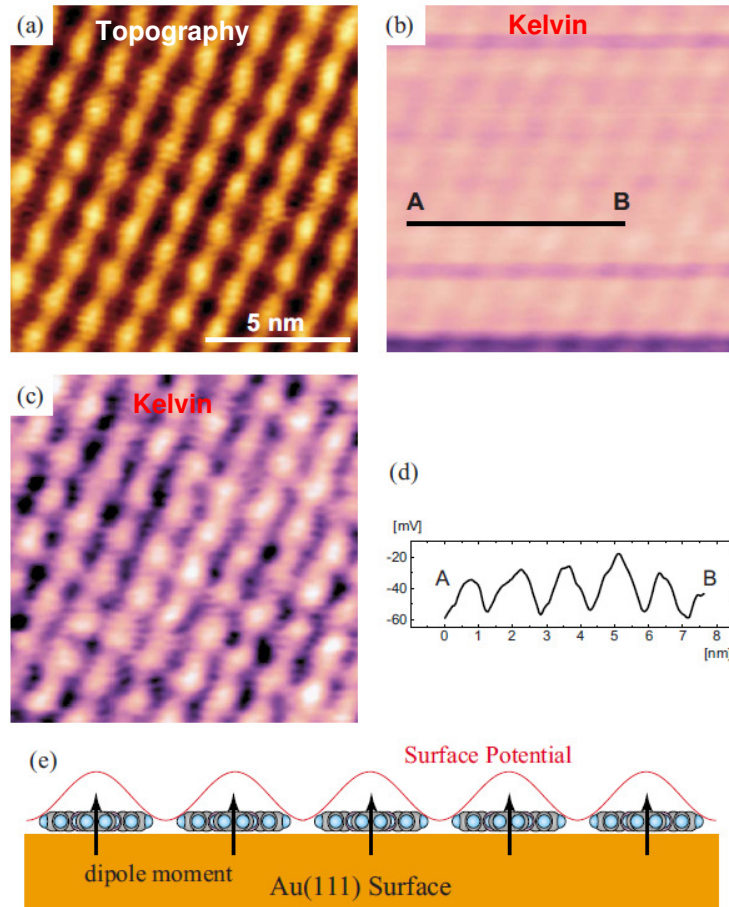

M=Cu, Co

- Molecular resolution in KPFM
- +30mV positive shift, increase of the interface dipole, c.t. to the layer
- Results interpreted in terms of electrostatic MS interaction

¹T. Ichii *et al.*, JAP **107** 024315 (2010);

KPFM on metallic surfaces including adsorbates:

□ Molecular organic films :

C_{60} on Ag(111)¹ (FM-KPFM):

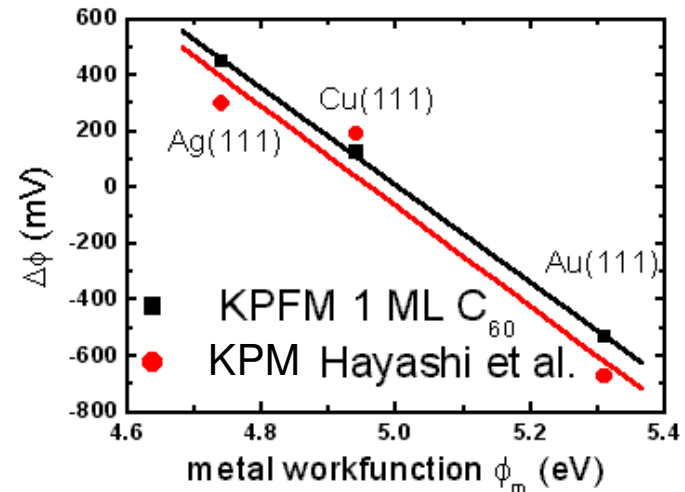
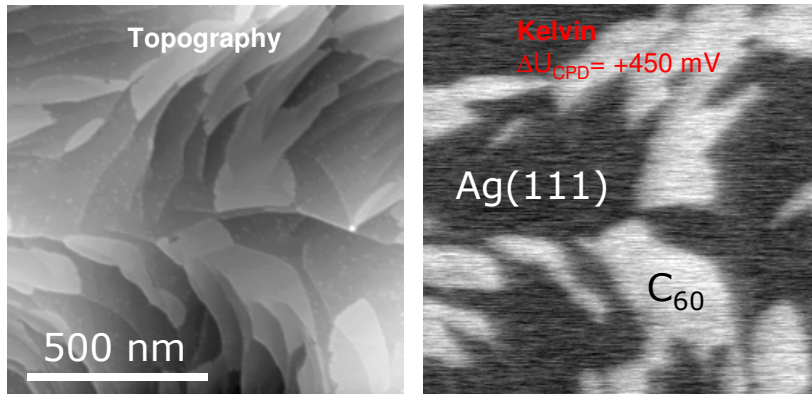

- C_{60} layers increase the CPD: interface dipole increase, c.t. to the molecules
- Behavior depends on the nature of the metal
- Results are compliant with macroscopic KPM

¹U. Zerweck *et al.*, Nanotechnology **18** 084006 (07); Hayashi *et al.*, JAP **92**, 3784 (02)



KPFM on bulk insulators

□ Mixed ionic crystals¹: NaCl(001)+1% KCl (FM-KPFM)

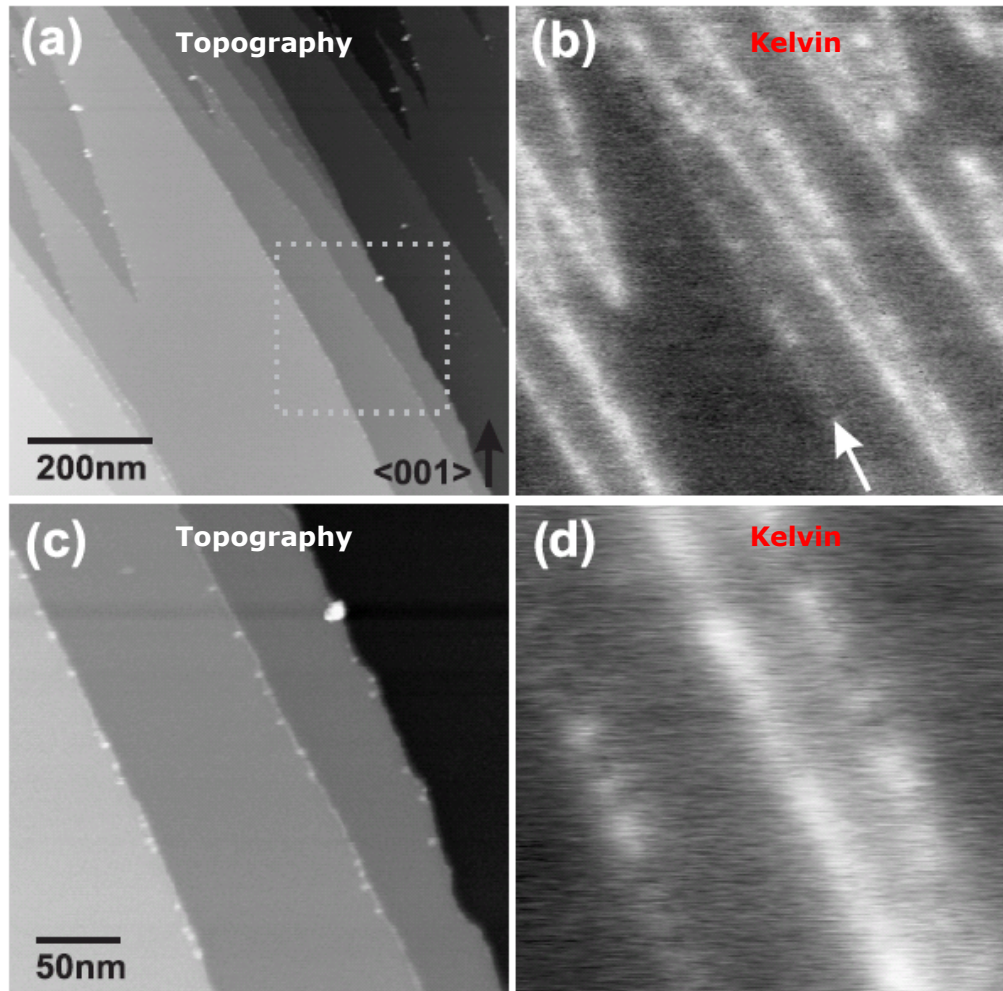

- Significant positive CPD shift at the step edges (+300 mV)
- Local (-) charges are heterogeneously trapped along the step edges : not intrinsic
- Similar behavior on other alkali halides (KCl)

Origin of these charges?

¹C. Barth *et al.*, *Nanotechnology* 17, S155 (2006)

KPFM on bulk insulators

□ $\text{KCl}(001)^1$: (FM-KPFM)

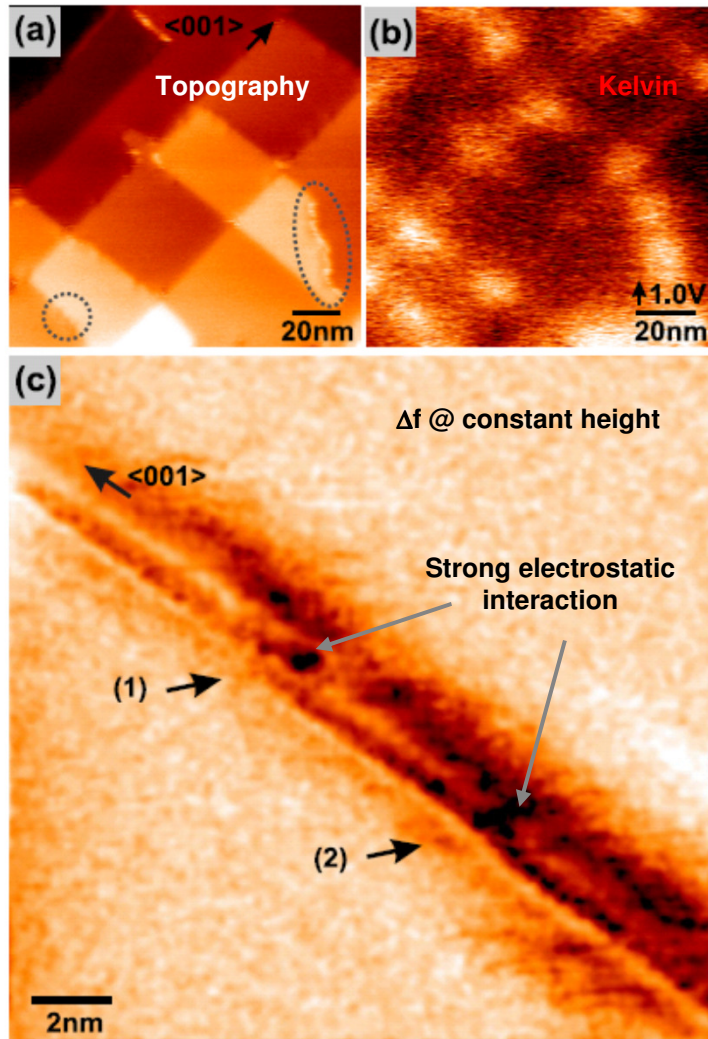

“Double layer surface“ effect²

- Ionic crystals are extrinsic : Ca^{2+} impurities nearby steps below the surface
- Global charge of the crystal is neutral $\rightarrow V^-$ centers (cationic vacancies)
- Net negative charge nearby (below) step edges and kink sites

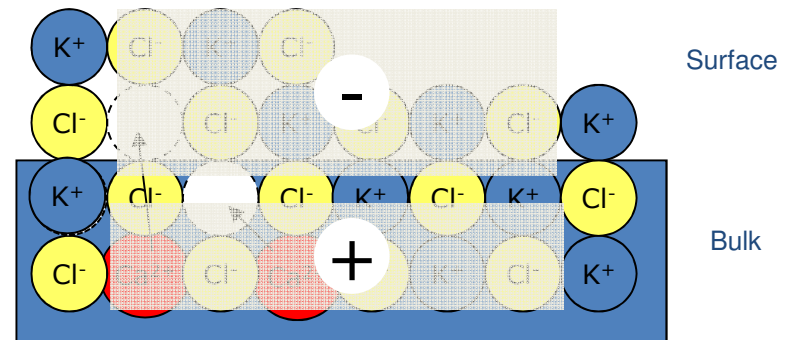

¹C. Barth et al., *Phys. Rev. Lett.* 98, 136804 (2007); ²J. Frenkel, *Kinetic Theory of Liquids*, (Clarendon Press, Oxford, 1946).

KPFM on bulk insulators including molecular films

□ Triphenylene derivative on KBr(001)¹: (FM-KPFM)

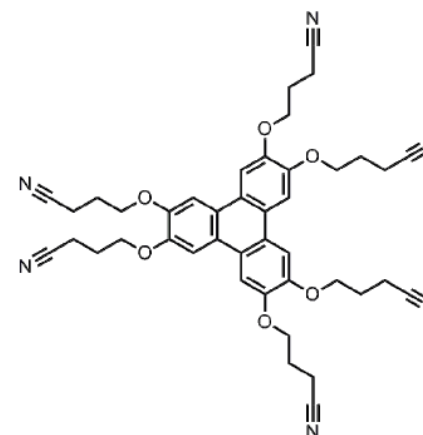
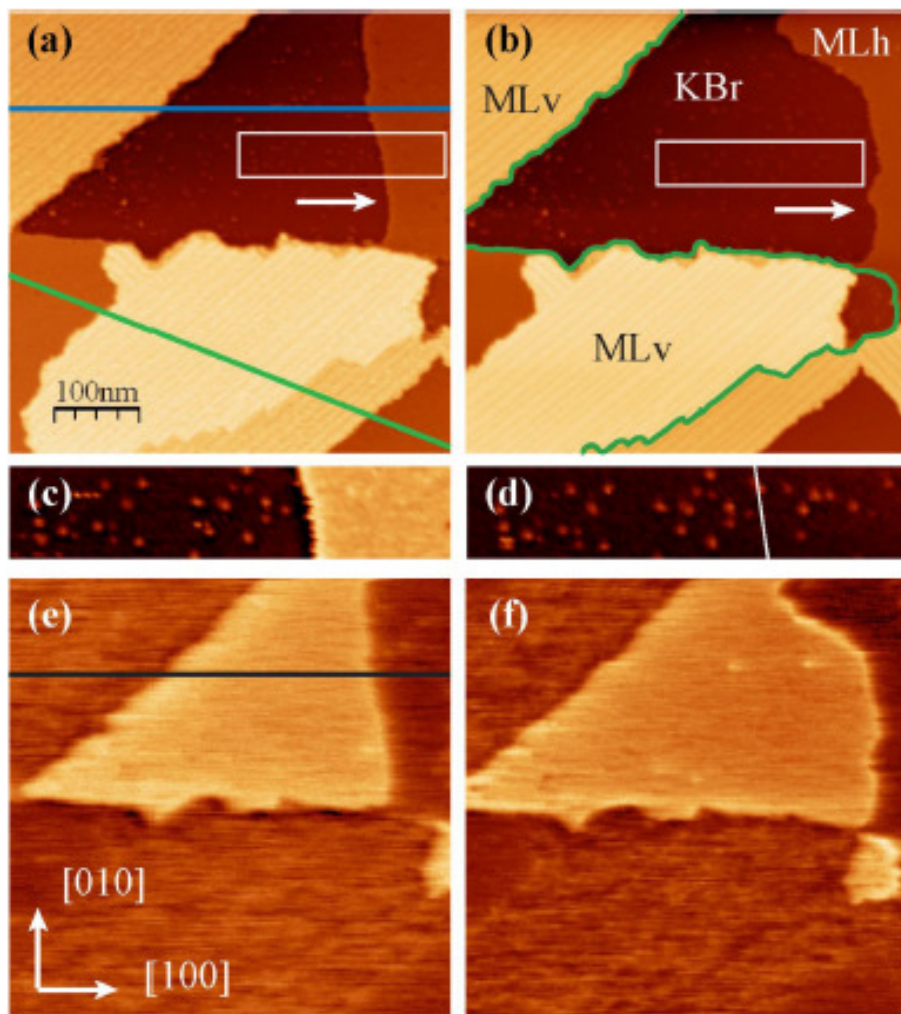

- Two kinds of adsorption: flat (h) and vertical (v)
- Both domains exhibit lower CPDs than KBr: surface dipole increase
- h-domains consist of molecules interacting electrostatically with the substrate via polar CN groups

¹A. Hinaut *et al.*, *J. Beilstein Nanotech.* **3**, 221 (2012)

IV. Examples of applications

- Long-range regime

- Short-range regime

High-resolution KPFM: semiconductor surfaces

➤ S. Kitamura *et al.*, Appl. Surf. Sci. **157**, 222 (2000) : Au/Si(111) 7x7

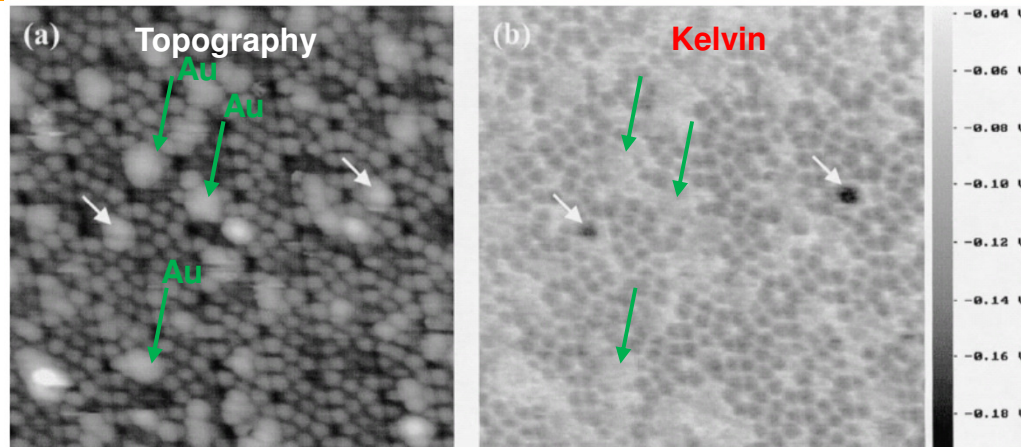

"The potential difference of atomic structures...**does not seem to reflect the work function** as we initially expected. It is therefore considered that the atomic potential difference reflects the local electron density on the surface."

➤ K. Okamoto *et al.*, Appl. Surf. Sci. **210**, 128 (2003) : Si(111)5√3x5√3-Sb

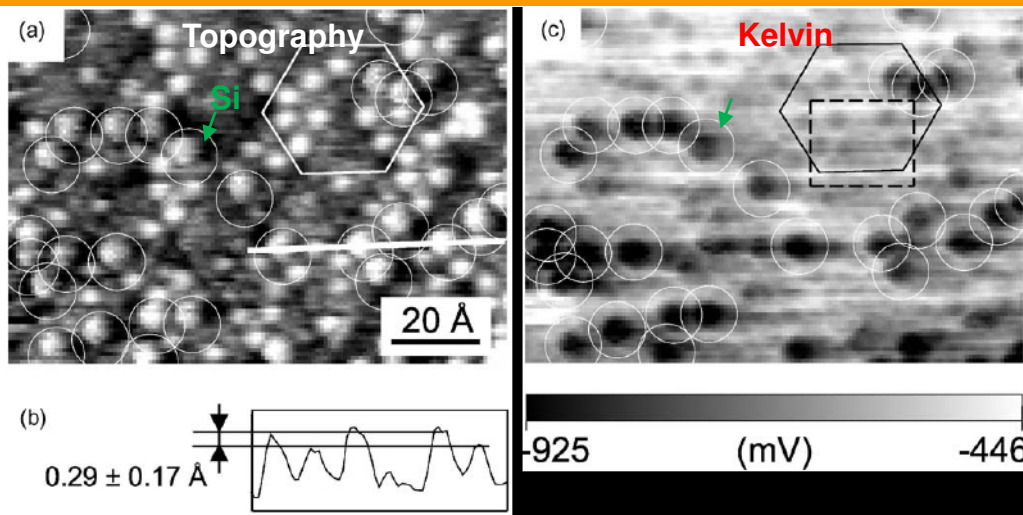

First attempt to identify species of individual atoms by KPFM

Potential of adatoms (surface potential) : $V_{Si} \sim V_{Sb} - 0.2V$
 : "This value disagrees with the theoretical work functions of Si and Sb in bulk state...Our result indicates that KPFM on atomic scale does not measure the energy of the HOMO level."

High-resolution KPFM: intramolecular resolution

nature
nanotechnology

LETTERS

PUBLISHED ONLINE: 26 FEBRUARY 2012 | DOI: 10.1038/NNANO.2012.20

Imaging the charge distribution within a single molecule

Fabian Mohn*, Leo Gross, Nikolaj Moll and Gerhard Meyer

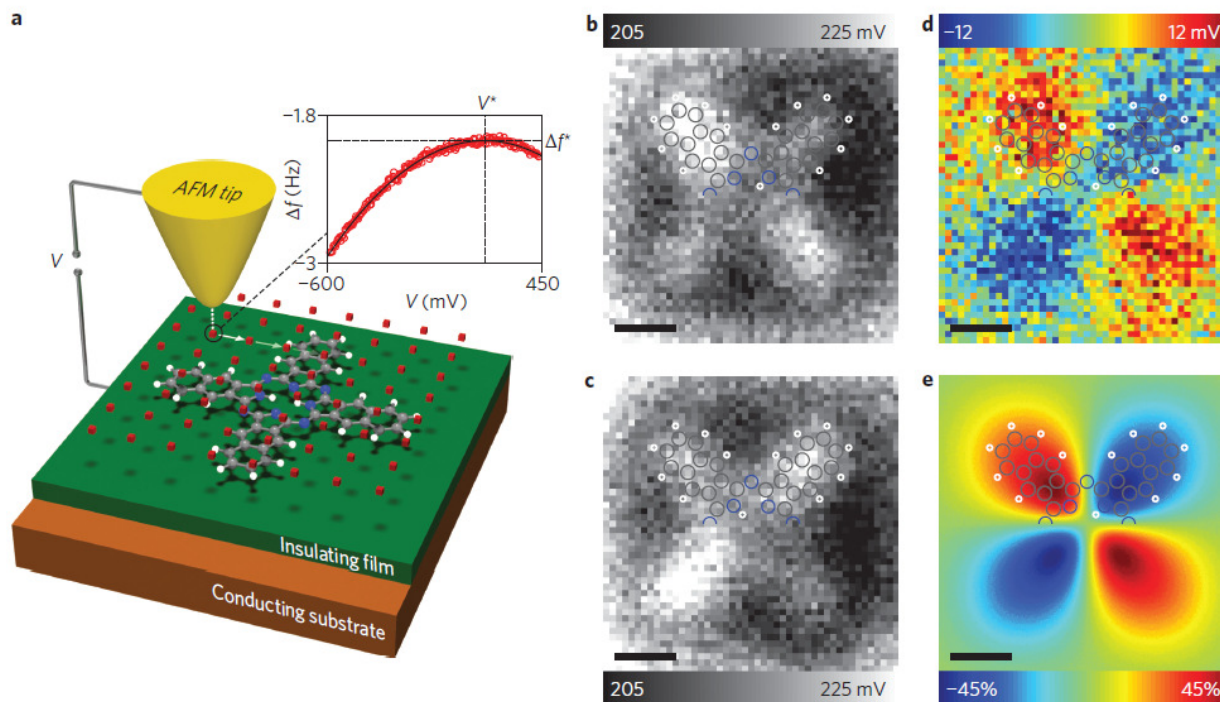

High-resolution KPFM: charge state of individual atoms

Measuring the Charge State of an Adatom with Noncontact Atomic Force Microscopy

Leo Gross,^{1*} Fabian Mohn,¹ Peter Liljeroth,^{1,2} Jascha Repp,^{1,3} Franz J. Giessibl,³ Gerhard Meyer¹
 12 JUNE 2009 VOL 324 SCIENCE

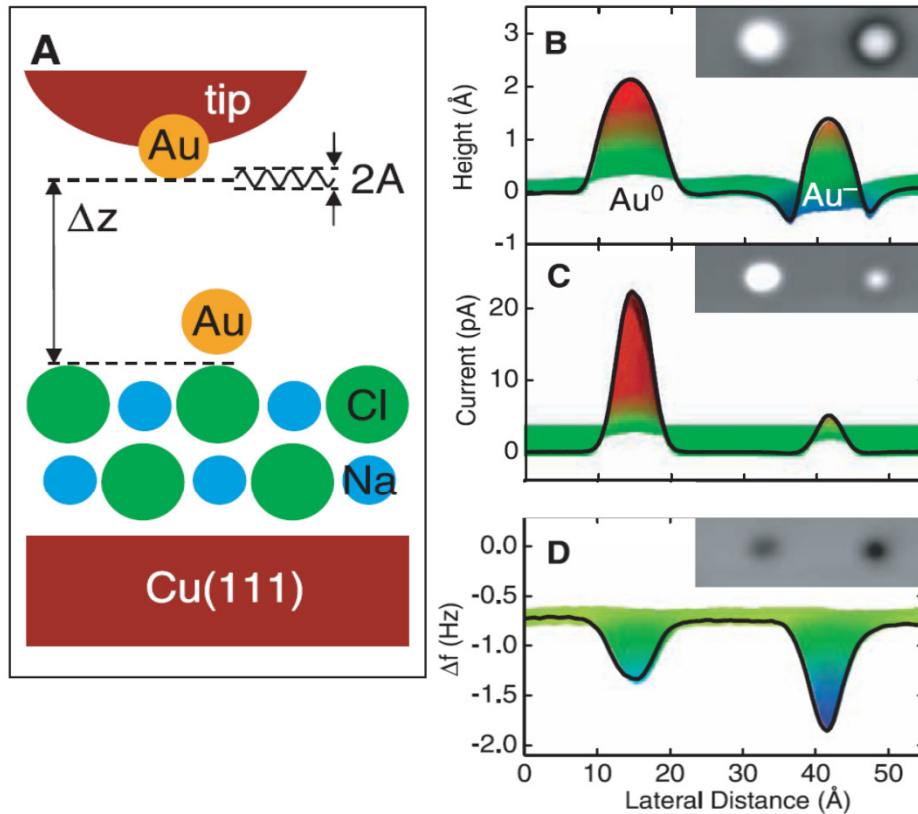

Topographic sensitivity to the charge state on the atomic scale

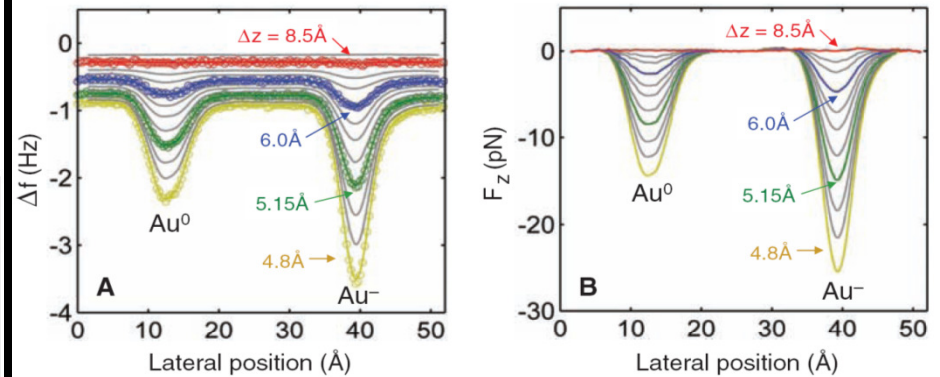

Spectroscopic sensitivity to the charge state on the atomic scale

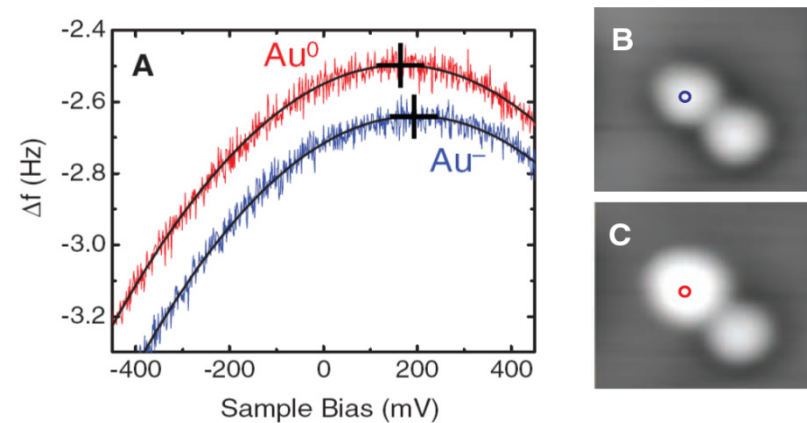

High-resolution KPFM: modelling

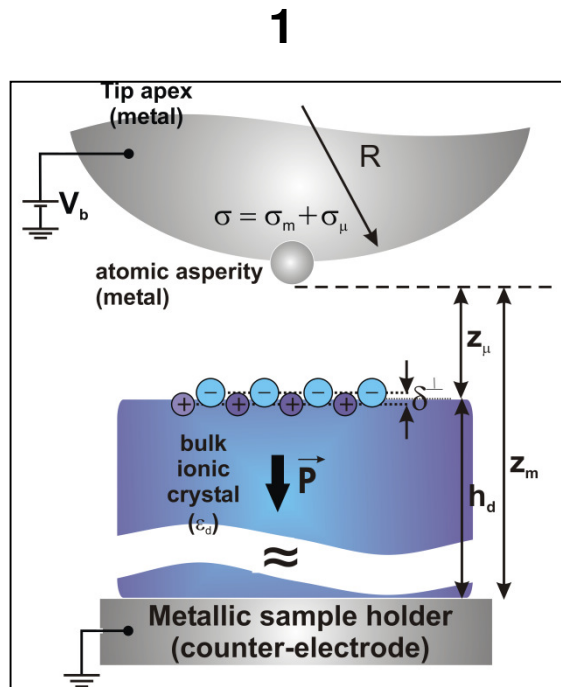

- **Tip termination:** metallic atomic asperity
- **Sample:** Bulk ionic crystal
- **Analytical & Experimental approach**

F.Bocquet et al., Phys. Rev. B **78**, 035410 (2008)
L.Nony et al., Nanotechnology **20**, 264014 (2009)

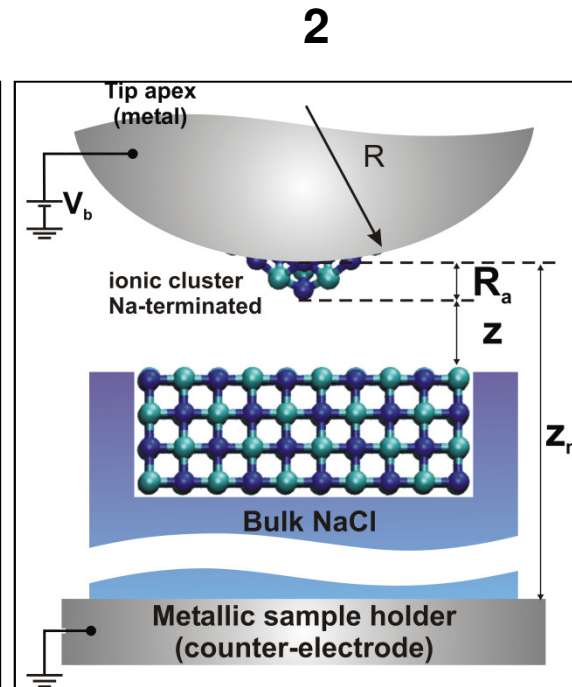

- **Tip termination:** ionic cluster (Na⁺-terminated)
- **Sample:** Bulk ionic crystal
- **Fully numerical approach**

L.Nony et al., Phys. Rev. Lett. **103**, 036802 (2009)

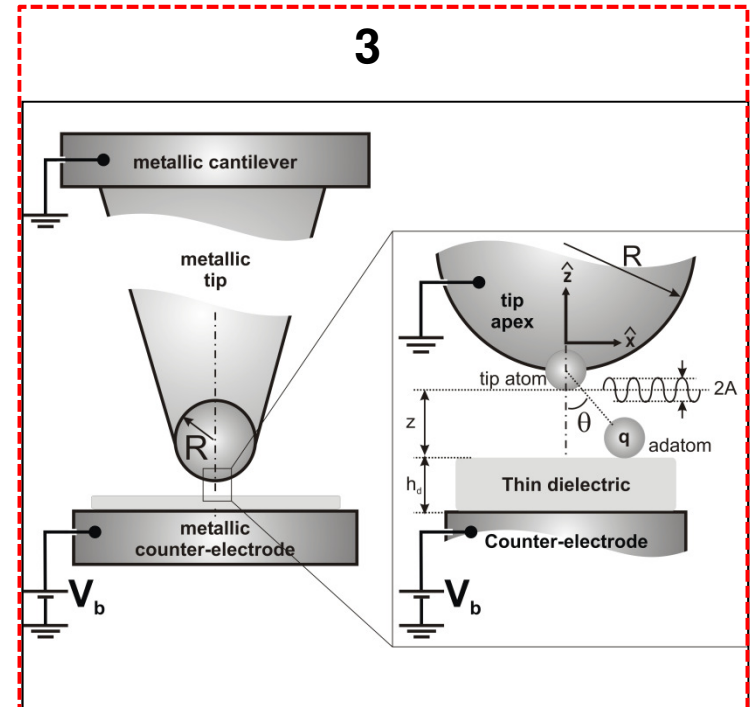

- **Tip termination:** single metallic atom
- **Sample:** 2ML NaCl / Cu(111)
- **Fully analytical approach**

F.Bocquet et al., Phys.Rev.B **83**, 035411 (2011)
Based upon the work by L.Gross et al. Science **324**, 1428 (2009)

Charge state of a single atom

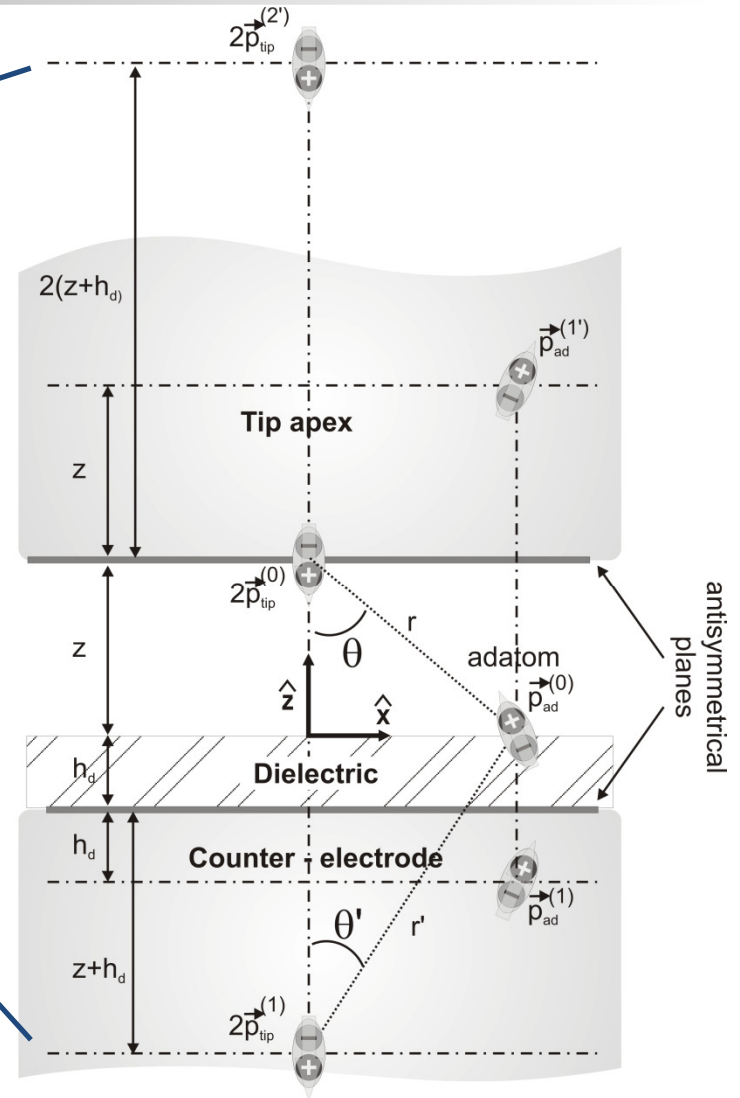
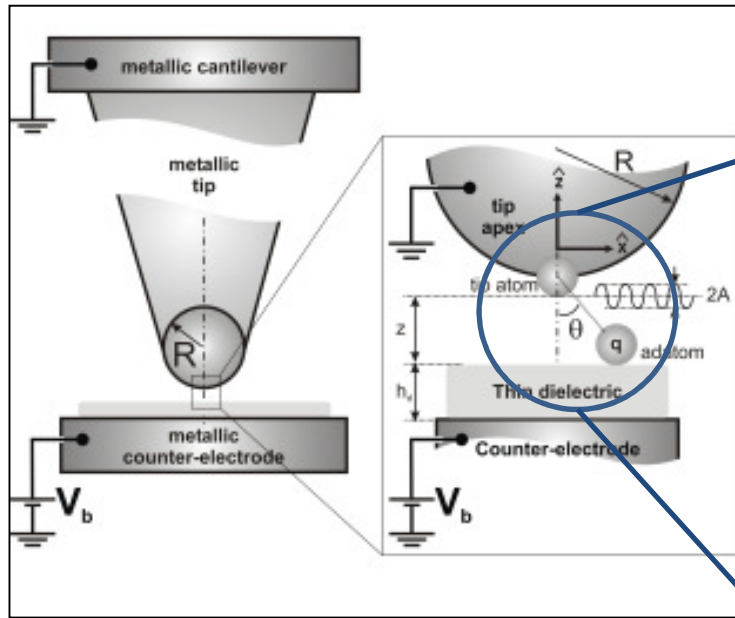

$$F_{SR}^{el} = -\frac{\partial}{\partial z} \left[-\frac{1}{2} \vec{p}_{tip} \cdot \vec{E}_{tip}^{ext} - \frac{1}{2} \vec{p}_{ad} \cdot \vec{E}_{ad}^{ext} \right]$$

Electrostatic energy of polarization-induced dipoles

Charge state of a single atom

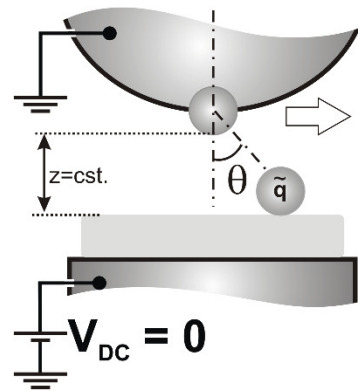

Polarizability for Gold: $\alpha=6.78\text{\AA}^3$

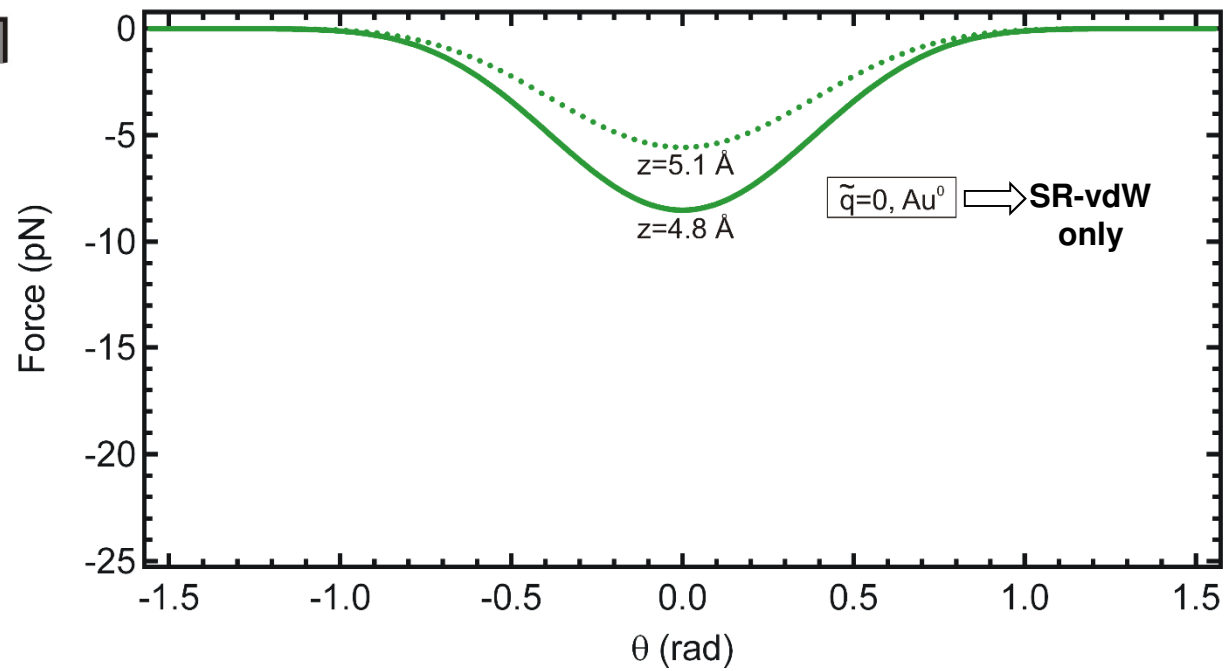

Charge state of a single atom

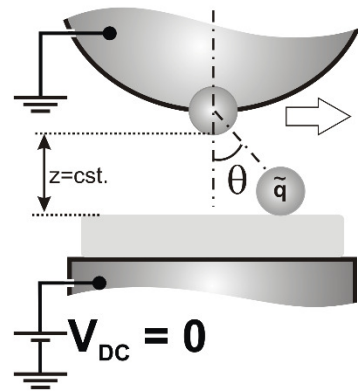

Polarizability for Gold: $\alpha=6.78\text{\AA}^3$

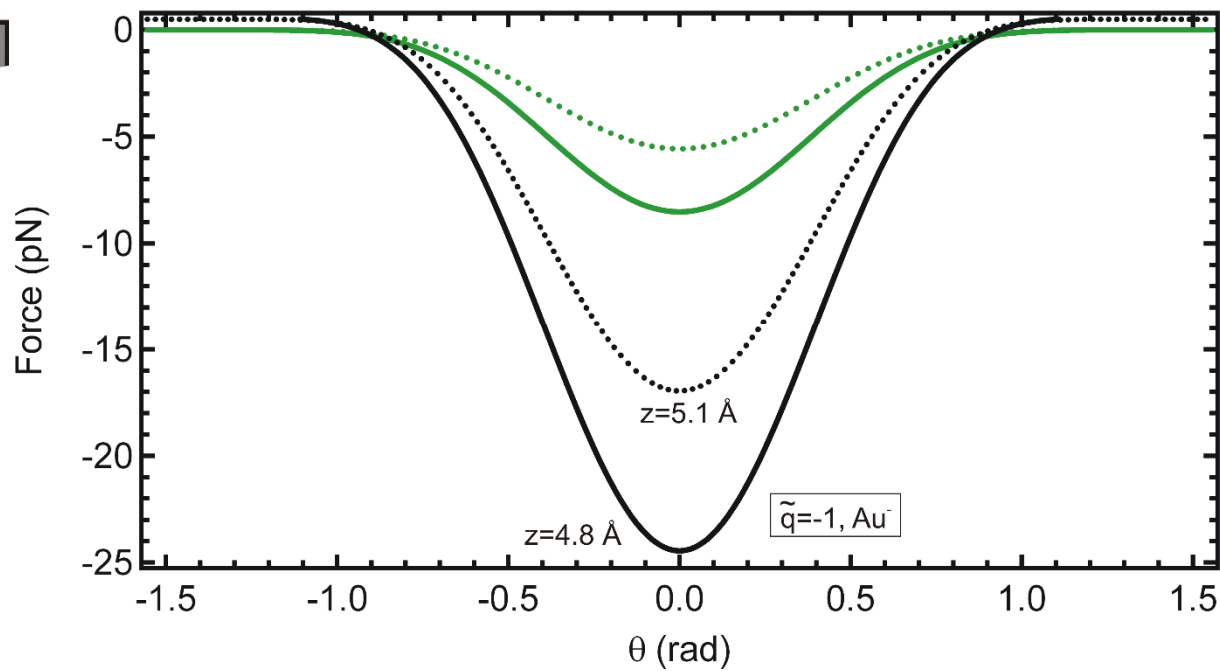

Charge state of a single atom

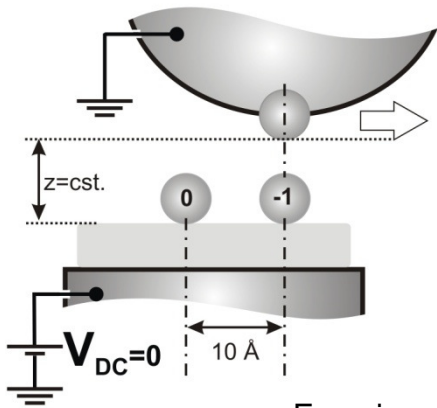

$$\text{Force} \rightarrow \Delta f = -\frac{f_0}{2k} \frac{\partial F}{\partial z}$$

Δf derived from the total force (LR+SR components, $z = 5.1 \text{ \AA}$, $R = 50 \text{ \AA}$)

Experimental data by L.Gross et al.

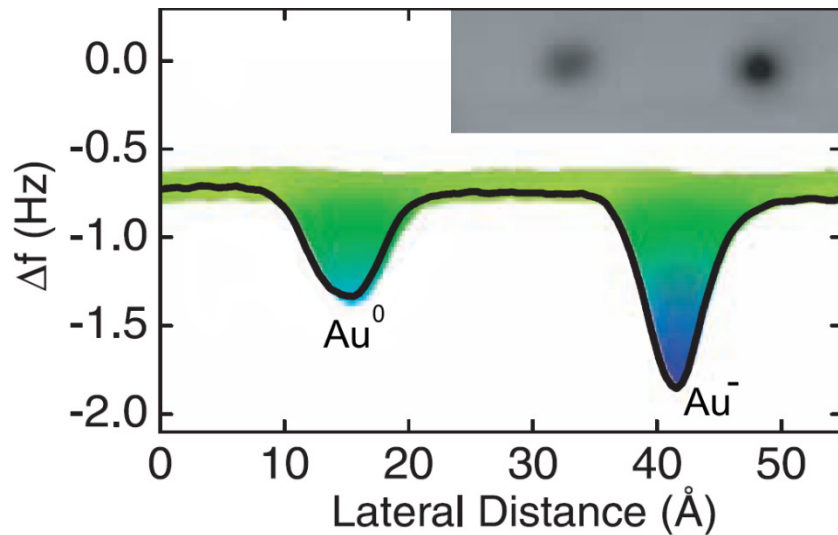

Cross section derived from the model

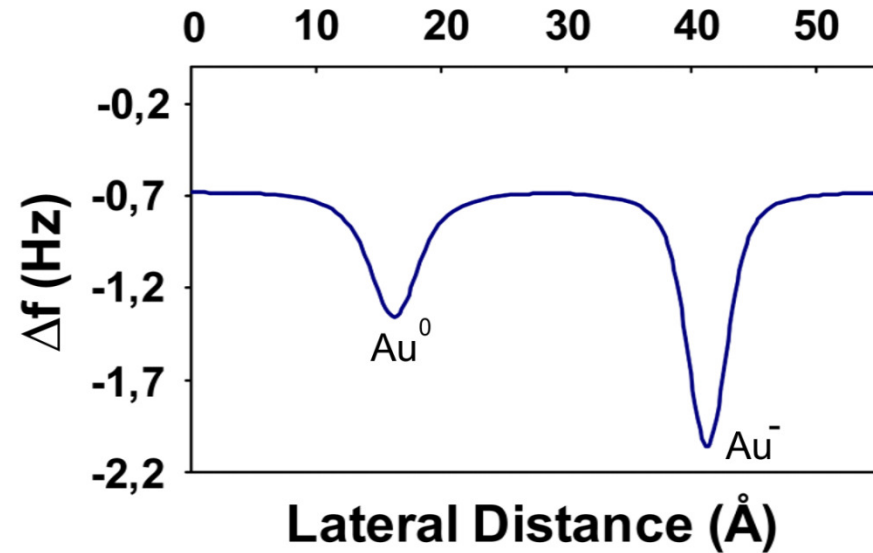

Charge state of a single atom

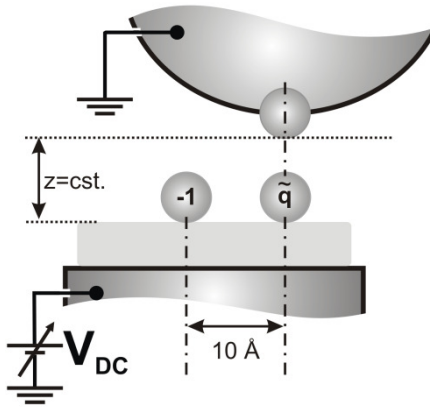

$$\text{Force} \rightarrow \Delta f = -\frac{f_0}{2k} \frac{\partial F}{\partial z}$$

Δf derived from the total force (LR+SR components, $z = 5.8 \text{ \AA}$, $R = 50 \text{ \AA}$)

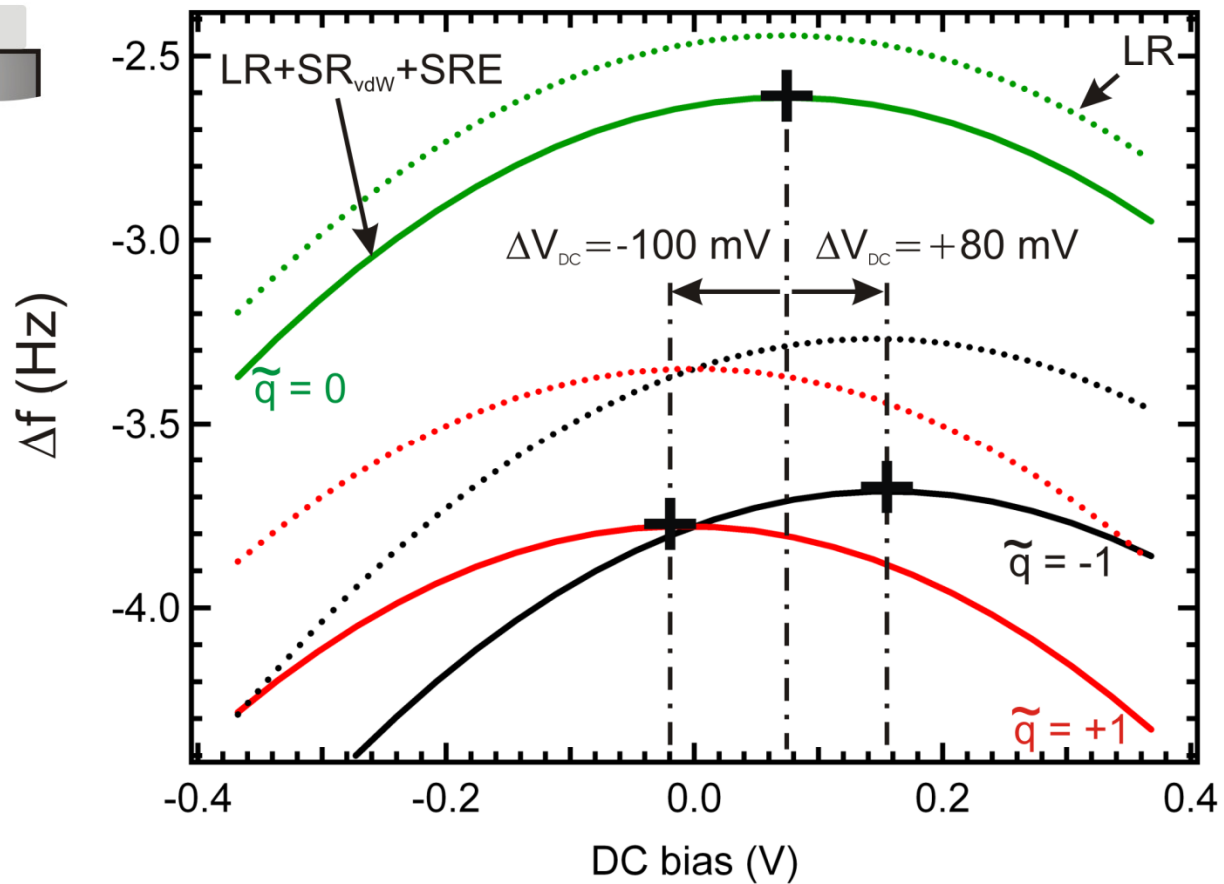

Conclusion



Institut Matériaux Microélectronique Nanosciences de Provence
UMR CNRS 7334, Universités Aix-Marseille et Sud Toulon-Var



Take home message

- ❑ Compensating electrostatic forces is required for high-resolution nc-AFM imaging → necessity for using KPFM
- ❑ Technic adds further complexity to the experimental setup but... 
- ❑ The sign of the charges or the dipole orientation of the species trapped within the capacitance which shift the CPD w.r.t. CPD_{ref} (background) is easy to determine
- ❑ In the long-range regime and with surface adsorbates whose size is larger than the tip apex, KPFM yields a consistent CPD map of the sample (consistent with UPS measurements)
- ❑ BUT getting quantitative numbers out of the experimental data is difficult (requires models) as the CPD is tip and distance dependent
- ❑ KPFM in the short-range regime is sensitive to short-range electrostatic forces which can qualitatively be understood from electronic & ionic polarizability

Additional key references used for this talk

- *Kelvin Probe Force Microscopy, Measuring & Compensating Electrostatic forces*, Springer Series in Surface Sciences (Th. Glatzel & S. Sadewasser Ed.)
- W. Melitz et al., *Kelvin Probe Force Microscopy and its application*, Surf. Sci. Rep. **66**, 1-27 (2011).

Acknowledgements

Ch. Loppacher (Pr.), F. Bocquet (MC), L.Nony (MC), F. Para (IE), A. Amrous (PhD)

