



HAL
open science

Impact of RPL objective functions on energy consumption in Ipv6 based wireless sensor networks

Abdelhadi Eloudrhiri Hassani, Aïcha Sahel, Abdelmajid Badri

► To cite this version:

Abdelhadi Eloudrhiri Hassani, Aïcha Sahel, Abdelmajid Badri. Impact of RPL objective functions on energy consumption in Ipv6 based wireless sensor networks. Colloque sur les Objets et systèmes Connectés, Ecole Supérieure de Technologie de Casablanca (Maroc), Institut Universitaire de Technologie d'Aix-Marseille (France), Jun 2019, CASABLANCA, Morocco. hal-02298879

HAL Id: hal-02298879

<https://hal.science/hal-02298879v1>

Submitted on 27 Sep 2019

HAL is a multi-disciplinary open access archive for the deposit and dissemination of scientific research documents, whether they are published or not. The documents may come from teaching and research institutions in France or abroad, or from public or private research centers.

L'archive ouverte pluridisciplinaire **HAL**, est destinée au dépôt et à la diffusion de documents scientifiques de niveau recherche, publiés ou non, émanant des établissements d'enseignement et de recherche français ou étrangers, des laboratoires publics ou privés.

Impact of RPL objective functions on energy consumption in Ipv6 based wireless sensor networks

Abdelhadi Eloudrhiri Hassani, Aicha Sahel, Abdelmajid Badri

E-mails : eloudrhiri.abdelhadi@gmail.com, sahel_ai@yahoo.fr, abdelmajid_badri@yahoo.fr

Adress : Laboratory EEA&TI FSTM, Hassan II University of Casablanca, Morocco

ABSTRACT : With the arrival of the internet of things concept, a new vision of wireless sensor networks has been adopted allowing them to be addressed with ipv6 addresses, thus forming 6LowPAN networks. It is categorized as a new technology being developed and improved. This causes issues about the networks performance to create the communication path and collecting data. Therefore, IETF has proposed an IPv6 based routing protocol with low cost and power constraints RPL that builds a Destination Oriented Directed Acyclic Graph (DODAG) based on a set of metrics and constraints via a specific Objective Functions (OFs). This objective function selects the best parents and construct the routes. Our research is focus on performance analysis of two objective functions that are Minimum Rank with Hysteresis Objective Function (MRHOF) and Objective Function Zero (OFO) in a small area under a large scenarios and topologies. This comparison is focused on energy consumption of the network in the given scenrios to distinguish which objective function is the most optimal to guarantee long life expectancy of the sensor networks especially in static environment.

Keywords : WSN, IoT, 6LowPAN, IEEE 802.15.4, RPL, MRHOF, OF0, Cooja, Contiki OS.

INTRODUCTION

Internet of Things (IoT) is a recent paradigm that enables the communication between things in a ubiquitous way through different technologies. IoT scenarios can cover different application such as urban sensor, industrial monitoring and home automation. In order to allow an IoT application to achieve its objectives, it is necessary that a routing protocol can provide data communication with best performances. The routing protocols should take into consideration an important requirement that is the power consumption that allows a long lifetime of the IoT network.

Otherwise, IoT is based on Low-Power Wireless Personal Area Networks (LoWPAN), that are embedded devices with constrained in term of energy, processing and memory. With the arrival of IPV6 era, the Internet Engineering TaskForce (IETF) defined IPv6 addressing on LoWPAN networks (6LowPAN) which allows these devices to be connected to the internet, thus supporting the integration vision of wireless sensor network (WSN) into the internet of things. For that the IETF defined a new routing protocol for low-power and lossy networks RPL (IPv6 routing protocol for low-power and Lossy networks).

RPL protocol uses routing algorithms and Destination Oriented Directed Acyclic Graph (DODAG) in order to build a graph-based topology. The DODAG uses an objective function as a path selection mechanism to the root node that collect all data into the WSN. RPL offers two objective functions ; Minimum Rank with Hysteresis Objective Function (MRHOF) uses the minimum Expected Transmission Count (ETX) metric on the path to the route. In the other hand, objective function zero (OFO) is based on the minimum number of hops on the path to the route.

Our primary purpose in this paper is to provide a large study of the two objective functions MRHOF and OF0 in two kind of topologies in order to have an idea of suitability performance of RPL in each scenario.

The rest of this paper is organized as follow. In section II we give a overview of the routing protocol RPL, Section III : the methodology, Section IV we present results that we obtain and a discussion of performances in each scenario and finally a conclusion is given in Section V.

IPV6 ROUTING PROTOCOL FOR LOW POWER AND LOSSY NETWORKS (RPL)

Topology construction

RPL is the IPv6-based vector distance routing protocol designed for sensor node in network. It's also designed to integrate the routing protocol at the standard of IEEE 802.15.4 with the IPv6-based IP protocol in order to cope with the heterogeneity in the IoT concept [1].

RPL has to discover links and then select peers in such a way that no cycles are present. To this end, a Directed Acyclic Graph (DAG) built according to one or more Destination Oriented DAGs (DODAGs), one DODAG per root using an Objective Function (OF) to reach specific objectives [2]. RPL use ICMPv6 control messages to form and manage the nodes that constitute the WSN. Tree messages are present : DODAG Information Object (DIO), DODAG Information Solicitation (DIS) and the DODAG Destination Advertisement Object (DAO).

In order to build a DODAG, the root sends periodically DIO to its neighbors containing several parameters such as rank, metric, routing cost and DODAGID. Then neighbours nodes decide to join DODAG accor-

ding to the OF. The algorithm of rank calculation is illustrated in fig1.

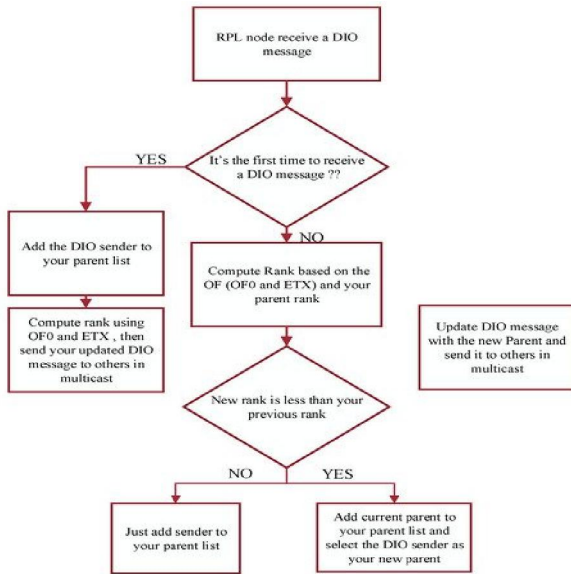

fig 1 : Process of calculation rank node

The process of building DODAG continue with nodes that decide to join the DODAG. Once this process is completed, each node has a routing table to its parent, hop-by-hop take to the root node. Also , the node may sends a DIS used to request information from its neighbors when waiting for DIO message. In order to maintain the network more stable, RPL uses the Trickle algorithm, to periodically refresh the DODAG. The DAO are transmitted according to two mode of operation (MOP); storing mode and non-storing mode. In the first one, once the neighbors nodes receipt the DAO from the sensors, RPL maintain a routing table containing all reachable destinations. In second mode, the DAO messages are directly unicast to the root [3]. The structure of RPL and its creation has been illustrated in fig.2.

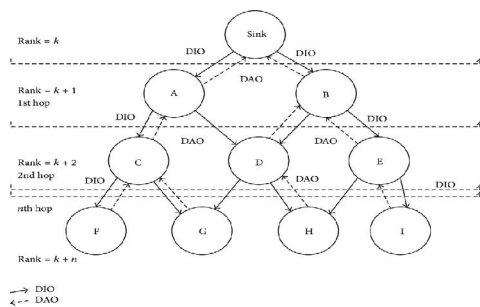

fig 2 : Process of DODAG construction with RPL

Path selection mechanism by objective function

The Objective Function is used to define one or more metrics to help nodes to translate these metrics

into ranks. It is responsible for selecting the routes in a DODAG. Rank computation is fulfilled using the OF depending on routing metrics as a reference like link quality and delay, and the other side to express the distance between a node in the network and the DODAG root [11]. RPL can separate the OFs from the core of the protocol which allows it to meet the different optimization criteria required. Each DODAG instance in RPL's DAG is associated with a particular OF. Otherwise, two objective functions are defined in RPL : Objective Function Zero (OF0) and Minimum Rank Hysteresis Objective Function (MRHOF). MRHOF is an objective function that use minimum value of Expected Transmission Count (ETX) on parent node selection. ETX is an expected number of transmission that required for it to be received without error at its destination [4]. OF0 is an objective function that use minimum value of hop to reach root node. Each node will calculate rank based on the hop value to the root node. The fewer number of jumps will get higher priority link to be selected by OF0. Rank value on child node is always higher than the parent node.

METHODOLOGY

The performance analysis of the objective functions implemented in RPL has been evaluated under Cooja [5]. It's a cross approach that allows to emulate the hardware and software levels of a mote or node based on Contiki OS [6] [7]. It's a lightweight, highly portable open source operating system, it is dedicated for WSNs applications. It's known as being the king of operating systems for environment monitoring applications.

Otherwise, four algorithms are used in our simulation : udp-sink.c, udp-send.c, rpl-config.h, of0.c and mrhof.c, distributed as open source codes, that we modified according to the aims of our study. Collect View allowed us in the other hand to collect the parameters that we want to exploit.

Network setup

In this study we have simulated two topologies with a single sink node: Linear and Random. The nodes are distributed in a squared area with a side $L=100$ meters, and the sink placed 30 meters near the area monitored by senders motes.

We have designed our RPL network with the two objective functions MRHOF and OF0, and two densities (10 and 37 nodes) including the sink mote.

Likewise, we varied the RX value (50, 75, and 100%) and study the performance of the routing protocol in term of power consumption.

The default parameters used in our study are represented in Tab.1.

Parameters	Value
Radio model	Unit Graph Disc Model – Distance Loss
Hardware platform	Skymote
Transmission/Interference range	50m / 55m
Transmission ratio Tx (%)	100
Reception ratio Rx (%)	50, 75, 100
Topologies	Linear, random
Mode of operation	Storing mode
Traffic communication	MPTP
Objective function (OFs)	MRHOF-ETX, OF0
Number of sender nodes	10,37
Number of sink nodes	1
Simulation time	10 minutes
Squared area (m)	100*100

Tab.1 : Parameters of simulation

Metrics evaluated

In this paper, we are interested to evaluate the RPL performance in term of power consumption.

The power consumption indicates the energy measured from nodes in the network over the network lifetime [11]. It's the sum of power used in each node on the network. There are four types in power measurement : Low Power Mode (LPM), CPU power, radio listen, and radio transmit. Power consumption is a total of all calculation off all type above. LPM is a power consumption parameter that indicates the power used when in sleep condition. CPU power is a power parameter that indicates the level of node processing. While radio listen and transmit is parameter related with node communication (transmit and receive).The formula used to calculate the energy of nodes according to the following equation.

$$Energy (mJ) = (Transmit * 19.5 mA + Listen * 21.5 mA + CPU time * 1.8 mA + LPM * 0.0545 mA) * 3 V / (32768)$$

Simulation network topologies :

The deployment of wireless sensors in streets of any city will be close to linear and random topologies as shown in Fig.1 and Fig.2. We have two types of nodes. The node with the green color represents the sink mote, and it's placed 30m near of all the other nodes. On the other hand, the nodes with the yellow color represent the senders motes, placed in a area with side 100m.



Fig.3 : Linear topology with 37 nodes

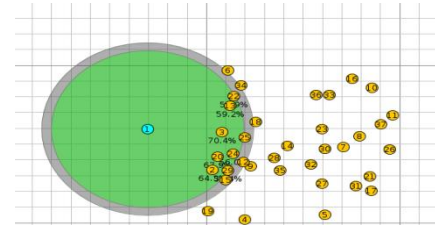

Fig.4 : Random topology with 37 nodes

RESULTS AND DISCUSSION

Performance analysis of Power Consumption (PC) :

According to Fig. 5-8, we can conclude that both topologies, OF0 perform better than MRHOF-ETX in term of power consumption and this comes back to the fact that the MRHOF-ETX prefer long paths with more stable link qualities than short paths with poor link qualities which leads more nodes in the routing of a packet and therefore higher power consumption for transmission radio. In addition to that, the calculation algorithm of the metric ETX for MRHOF is more complex than OF0 which is based on the rank of the node. Also, OF0 is based on minimizing the number of hops to the root what leads to less retransmission of packets hop by hop and less usage of radio. Otherwise, we can see from Fig. 9-16 that the average power consumption is widely spent in listening for both objective functions that can be explained by the number of packets that circulate in the network, so each node consumes more energy in listening to the channel in order to receipt or transmit a packet to avoid the collisions .

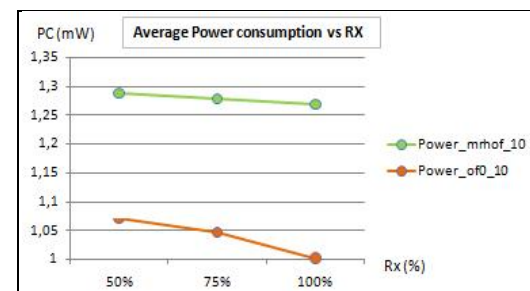

Fig.5 : Average PC vs RX in linear topology for 10 nodes

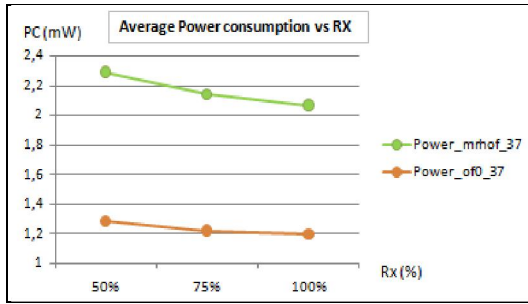

Fig. 6 : Average PC vs RX in linear topology for 37 nodes

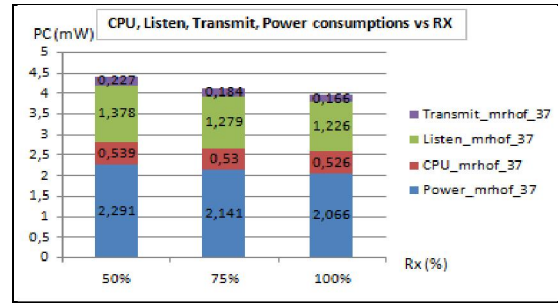

Fig. 10 : MRHOF CPU, Listen, Transmit and total Power Consumptions vs RX in linear topology for 37 nodes

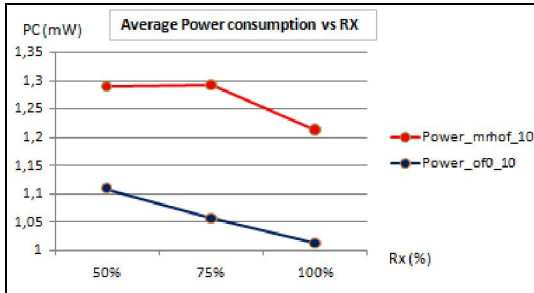

Fig. 7 : Average PC vs RX in random topology for 10 nodes

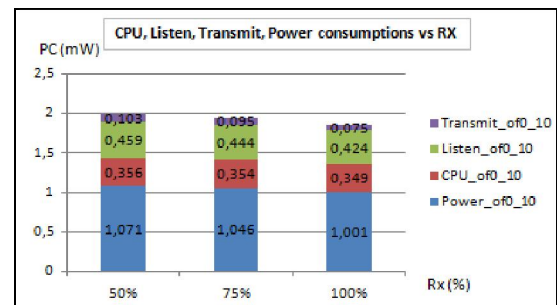

Fig. 11 : OF0 CPU, Listen, Transmit and total Power Consumptions vs RX in linear topology for 10 nodes

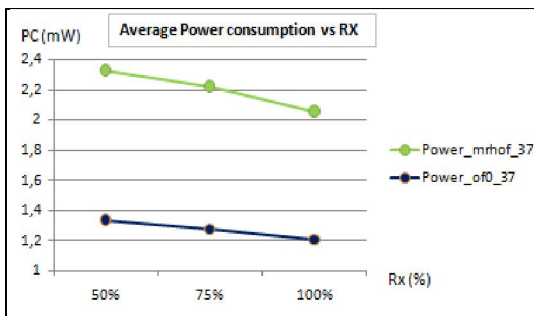

Fig. 8 : Average PC vs RX in random topology for 37 nodes

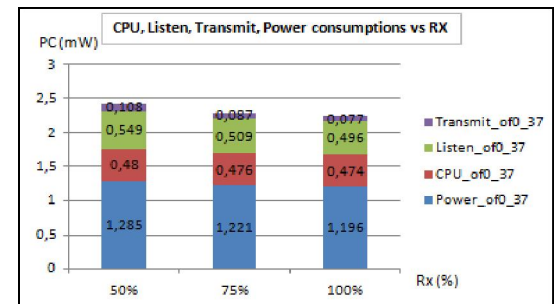

Fig. 12 : OF0 CPU, Listen, Transmit and total Power Consumptions vs RX in linear topology for 37 nodes

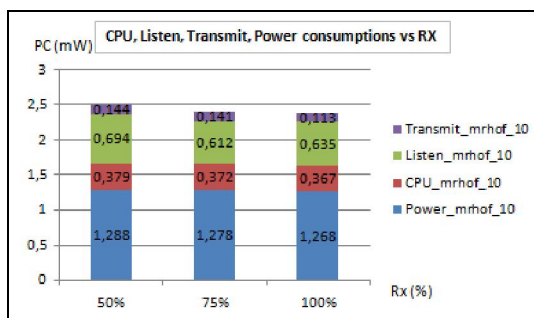

Fig. 9 : MRHOF CPU, Listen, Transmit and total Power Consumptions vs RX in linear topology for 10 nodes

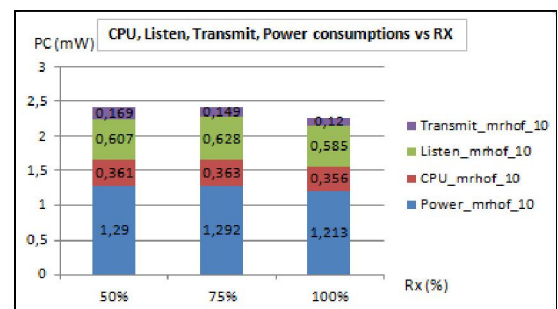

Fig. 13 : MRHOF CPU, Listen, Transmit and total Power Consumptions vs RX in random topology for 10 nodes

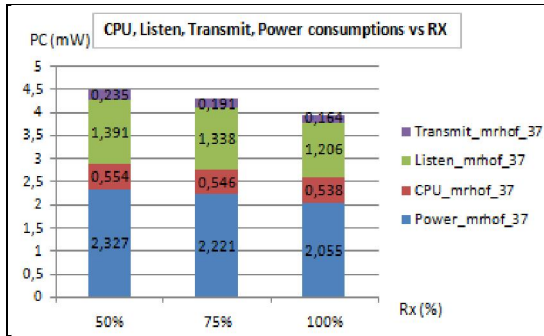

Fig. 14 : MRHOF CPU, Listen, Transmit and total Power Consumptions vs RX in random topology for 37 nodes

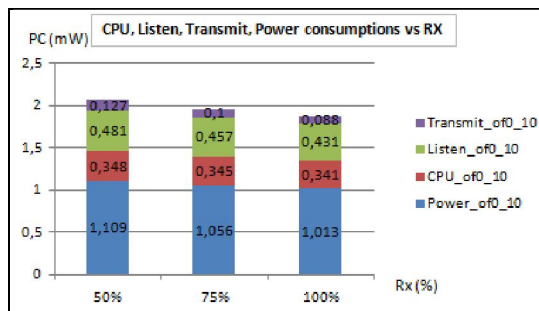

Fig. 15 : OF0 CPU, Listen, Transmit and total Power Consumptions vs RX in random topology for 10 nodes

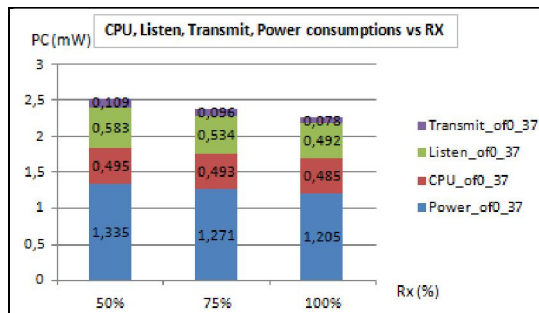

Fig. 16 : OF0 CPU, Listen, Transmit and total Power Consumptions vs RX in random topology for 37 nodes

CONCLUSION

Wireless sensor Networks have crucial constraints like low computing performance, memory and energy in these devices which make the routing in these kinds of networks more rigid, that's why the routing protocol must have the best performances.

In our work, we evaluated the two objectives functions MRHOF-ETX and OF0 of RPL in two topologies under different parameters and constraints which allowed us to see that OF0 perform better than MRHOF-ETX in term of power consumption. Finally, we can conclude that for applications which monitor a small area, we must choose OF0 as an objective function for RPL.

So as a future work, we prospect to design a new objective function to minimize more the power consump-

tion of the network thus extend the lifetime of the network.

Acknowledgment

This work was supported by the TIC center of university Hassan II Casablanca as a part of the "Big Data& Connected Objects" research project.

References

- [1] Nyoman Rudy Hendrawan, Gusti Ngurah Wikranta Arsa, "Zolertia Z1 Energy Usage Simulation with Cooja Simulator", *1st International Conference on Informatics and Computational Sciences (ICICoS), Bali (Indonesia), 2017*.
- [2] Walid Khallef, Miklos Molnar, Abderrahim Benslimane, Sylvain Durand, "Multiple Constrained QoS Routing with RPL", *IEEE ICC 2017 Ad-Hoc and Sensor Networking Symposium, 2017*.
- [3] Ibtissem zaatouri, Nouha Alyaoui, Awatef Benfradj Guiloufi, Abdennaceur Kachouri, "Performance Evaluation of RPL Objective Functions for multi-Sink", *18th international conference on Sciences and Techniques of Automatic control & computer engineering - STA'2017, Monastir (Tunisia), December 21-23, 2017*.
- [4] H.Lamaazi, N. Benamar, M.I. Imaduddin, A.J. Jara, "Performance Assessment of the Routing Protocol for Low Power and Lossy Networks", *International Conference of Marrakech, Marrakech (Morocco), 2017*.
- [5] R.Sharma, T. Jayavignesh, "Quantitative Analysis and Evaluation of RPL with Various Objective Functions for 6LoWPAN", *Indian Journal of Science and Technology, Vol 8,19 (2015)*.
- [6] M. Qasem, H. Altawssi, M. B. Yassien and A. Al-Dubai, "Performance Evaluation of RPL Objective Functions", in *Computer and Information Technology; Ubiquitous Computing and Communications; Dependable, Autonomic and Secure Computing; Pervasive Intelligence and Computing, IEEE International Conference, Liverpool (England), 2015*.
- [7] Y.B. Zikria, M.K. Afzal, F. Ishmanov, S.W. Kim, H. Yu, "A survey on routing protocols supported by the Contiki Internet of things operating system", *Future Generation Computer Systems, pp. 200-219, 2017*.
- [8] Bardia Safaei, Amir Mahdi Hosseini Monazzah, Taha Shahroodi, Alireza Ejlali, "Objective Function: A Key Contributor in Internet of Things Primitive Properties", *Real-Time and Embedded Systems and Technologies (2018)*.
- [9] Shambhavi Mishra, Pawan Singh, Deepak Arora, Krishna Kant Agrawal, "Analyzing and Evaluating the Performance of 6LoWPAN and RPL Using CONTIKI", in *Proceedings of the International Conference on Intelligent Sustainable Systems (ICISS) IEEE Xplore Compliant, 2017*.
- [10] O. Gnawali, "Levis P. The ETX objective function for RPL", *RFC-2119*.
- [11] Shima A. Abdel Hakeem, Anar A. Hady, HyungWon Kim, "RPL Routing Protocol Performance in Smart Grid Applications Based Wireless Sensors: Experimental and Simulated Analysis", *Electronics 8 journal, Vol. 2, (2019). DOI : 10.3390/electronics8020186*.