



HAL
open science

Water Wave Micro-Energy Mini-Boat Harvester

Sébastien Rigourd, Stephane Carras, Benoit Agnus, Blaise Elysée Guy Ravelo,
Serge de Blasi

► **To cite this version:**

Sébastien Rigourd, Stephane Carras, Benoit Agnus, Blaise Elysée Guy Ravelo, Serge de Blasi. Water Wave Micro-Energy Mini-Boat Harvester. 2019. hal-02298602v1

HAL Id: hal-02298602

<https://hal.science/hal-02298602v1>

Preprint submitted on 27 Sep 2019 (v1), last revised 5 Oct 2019 (v2)

HAL is a multi-disciplinary open access archive for the deposit and dissemination of scientific research documents, whether they are published or not. The documents may come from teaching and research institutions in France or abroad, or from public or private research centers.

L'archive ouverte pluridisciplinaire **HAL**, est destinée au dépôt et à la diffusion de documents scientifiques de niveau recherche, publiés ou non, émanant des établissements d'enseignement et de recherche français ou étrangers, des laboratoires publics ou privés.

Water Wave Micro-Energy Mini-Boat Harvester

Sébastien Rigourd¹, Stephane Carras¹, Benoît Agnus², Blaise Ravelo³ and Serge De Blasi⁴

¹ FILIX SAS, Rue Saint-Aventin, F-10150 Creney-prés-Troyes, France

² SCIENTEAMA, 27 Rue des Glengarrians, F-14610 Villons Les Buissons, France

³ Normandy University UNIROUEN, ESIGELEC, IRSEEM EA 4353, F-76000 Rouen, France

⁴ TERA, F-29100 Douarnenez, France

*corresponding author, E-mail: blaise.ravelo@yahoo.fr

Abstract

This paper introduces an original research work on experimental demonstration of micro-energy harvesting from water wave. To implement this demonstrator, commercial piezo-electric elements are used as an electromechanical aquatic energy transducer. The proof-of-concept is constituted by electrical micro-energy sensor circuit implemented on a mini-boat external surface. The water wave is generated by the valve oscillating motion placed in a water tank. Because of the wave interaction with the piezo, it was shown that the electrical circuit placed on the micro-boat surface generates instantaneous electrical power with microwatt amplitude under some Volts amplitude instantaneous voltage. The influence of the boat orientation in function of the water wave propagation direction is investigated.

Keywords: Water wave, micro-energy harvester, piezoelectric, electrical circuit, experimentation, electromechanical energy transducer.

1. Introduction

The future embedded and wearable electronic devices trend to operate permanently with smart networks as 5G technology [1-2]. These modern electronic infrastructures still require technological challenges notably on the power supply design and implementation. One of the deployed solutions to overcome this challenging roadblock is focused on the micro-energy harvester development [3]. Since two decades, different natures of energy harvesters available in the urban cities and environments have been identified and investigated in function of available ambient sources [3]. With the technological progress, some of classical energy scavengers, as the hybrid energy harvesting device for generating electricity from heat and light from Fujitsu® are so far, industrialized [4]. Because of the generated electrical power level, the piezoelectric based mechanical harvester is the most popular according to different surveys as reported by IDTechEx® [5]. Different piezoelectric based harvesters have been implemented and commercialized. For example, the walking harvester device is industrialized by PowerWalk® [6].

Despite the progressive industrialization of mechanical harvesters, most of the sensational and prominent harvester concept as human motion based micro-energy harvesters are still under laboratory research concept study and test [7-9]. Such wearable electronic devices are classified in the biomechanical energy harvesting technologies [10]. Various types of mechanical energy sensors as electrostatic conversion concept for vibration energy harvesting [11], piezoelectric microfiber composite actuators [12], ultrasound flow sensor based on arrays of piezoelectric transducers [13], PZT nanofiber based nanogenerator [14] and textile-reinforced thermoplastic sensors [15] were proposed. In order to integrate the mechanical harvesters for certain applications as human motion [7-9], the flexible technology generator was introduced [16]. Among the flexible harvester solutions, because of its adaptability to 3D geometrical shape variation, the threads and textile-based structures [17-20] remain the

most integrable to the human body environment. Currently, it can be pointed out with the reported energy harvester state of the art [3,5] that the most popular mechanical harvesters operate with classical direct contacts.

However, among the existing mechanical harvesters available in the research literature, few works were available about the fluidic liquid motion and water-based energy harvesters [21-23]. The existing concept about this fluidic pressure based micro-energy harvester are still under laboratory research concept study and test [21,24]. For this reason, the present paper is focused on the development of mini-boat proof-of-concept (PoC) dedicated to the water wave micro-energy harvesting.

For the better understanding, the paper is organized in three main sections. Section 2 describes the design principle of the mini-boat harvester PoC. Section 3 deals with the experimental setup of the demonstrator and discusses about the electrical generated energy obtained results. Then, Section 4 summarizes the paper with a conclusion.

2. Description of the mini-boat electromechanical micro-energy harvester

The present section describes the operation principle of the proposed mini-boat water wave energy harvester. It is explained by introducing the synoptic system. Then, the specifications of each constituting block of the harvester are described.

2.1. General description of the water wave energy harvester PoC

Fig. 1 represents the global diagram of the water wave micro-energy PoC under investigation. It can be assumed as a cascaded system illustrating the different operations enabling the wave water motion converted into the electrical energy.

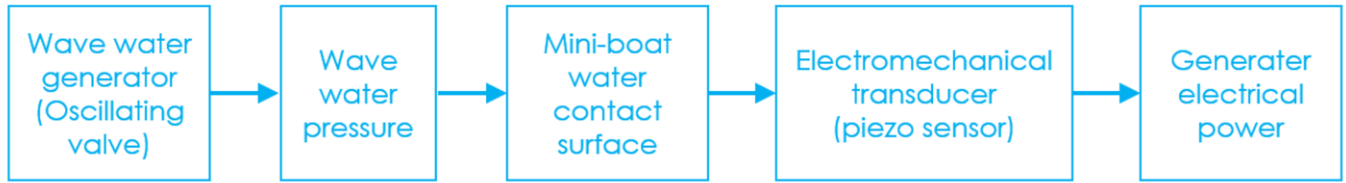

Figure 1: Synoptic diagram of the mini-boat electromechanical micro-energy harvester.

The proposed energy harvester PoC is comprised of:

- An oscillating valve or leaf system generating the water wave which moves with controlled frequency;
- The quantity of water wave pressure;
- The mini-boat geometrical surface and positioning with respect to the water wave propagation direction;
- The piezo-electric sensor acting as a transducer element which ensures the electromechanical energy conversion;
- And the generated electrical energy E from the water wave motion is intuitively proportional to the water wave amplitude force F_w and impacting on sensor velocity v_w :

$$E \propto (F_w, v_w). \tag{1}$$

2.2. Description of the water wave source

The experimental protocol of the proposed energy harvester PoC is performed in an aquatic water tank. Fig. 2(a) and Fig. 2(b) show the photographs of the aquatic water tank and the valve controller module respectively.



(a)



(b)

Figure 2: (a) Aquatic water tank and (b) control interface of valve oscillation frequency.

In order to be realistic, we have designed and fabricated by ourselves on the example of a speedboat. The fabricated PoC is a very common type of boat. Its particularities are that its length is three times greater than its width, that the “ventral” curvature primer ends at 30% of the front-rear distance from the bow and that the width decreases from 40% of the front-rear distance from the stern. The following dimensions have been adapted to the dimensions of the tank, indicated below, the boat will be 24 cm long and 8 cm wide, the reduction in width starts at 10 cm from the stern and the bow curvature starts at 7.5 cm from the same bow. By deeming the transport purposes, we have established that the tank would be 70 cm × 30 cm × 30 cm.

The water level filling the mini-boat would be of about 15 cm. The plate making the beats would be located 9 cm from the rear wall of the tank, would be fixed 7.5 cm opposite the top of the tank and would stop at 4.5 cm from the bottom. The plexiglass plate creating the waves is driven by a motor equipped with a dimmer which will then allow us to manage the frequency and intensity of the waves.

2.3. Mini-boat design

Fig. 3(a) and Fig. 3(b) introduce the SolidWorks® 3D design and the photograph of the fabricated mini-boat prototype, respectively. It integrates nine piezo-electric mounted in series placements onto the side and the rear faces as circular pellets with different diameters.

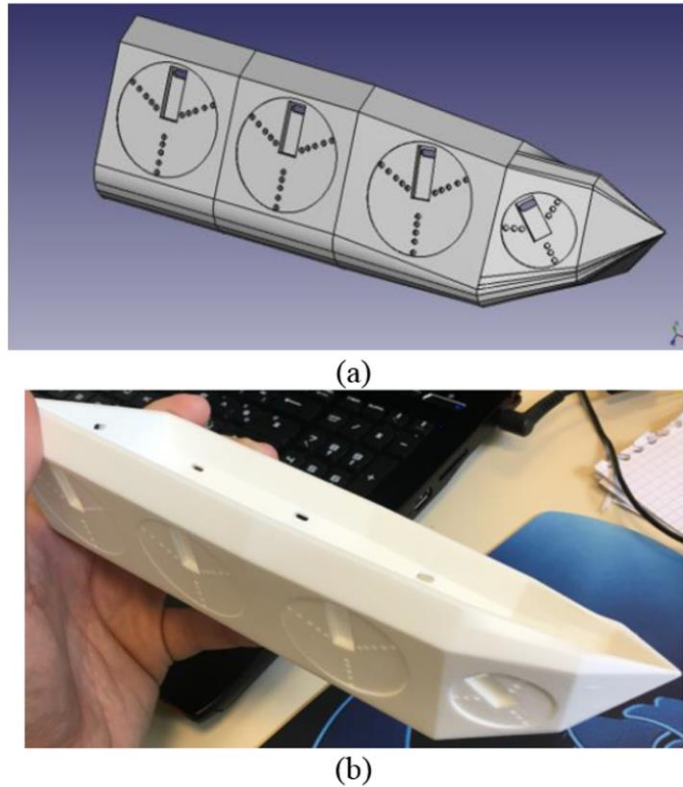
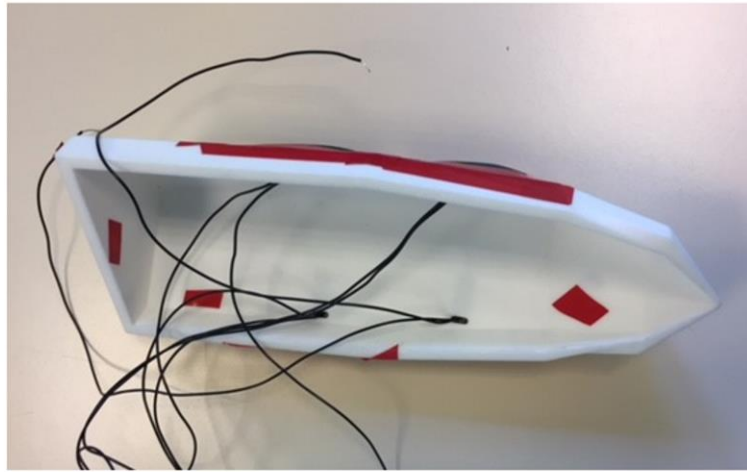

Figure 3: (a) SolidWorks® 3D design and (b) photograph of the fabricated mini-boat prototype.

Each piezo sensor is connected to the output copper conductor wires necessary for the induced electric energy measurements. The electrical wire connections are driven from the inside face. Fig. 4 depicts the top and bottom views showing the waterproof protection of piezo electric. These waterproofs are placed in the bottom of the mini-boat.



(a)



(b)

Figure 4: Photograph of the fabricated mini-boat prototype: (a) top and (b) bottom views.

2.4. Piezo-electric transducer

Fig. 5 presents the geometrical parameters of the piezo-electric elements used as electromechanical transducers. The hole positions are set for ensuring the electrical connection between the piezo and the electrical signal measurement equipment.

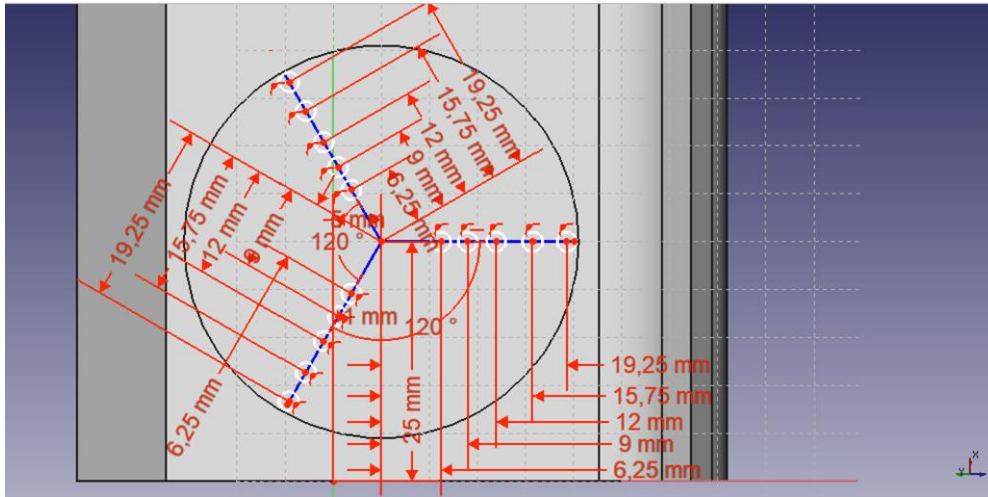

Figure 5: Geometrical dimensions of piezo placement on the mini-boat surface.

The overall characteristics of the employed piezoelectric sensors are addressed in Table 1. For the present study, our main focus is on the following sensor element parameters: piezo surface, buzzer diameter, operating frequency and the output impedance. According to the manufacturer model, the latter behaves as an RC-parallel network.

Table 1: Piezo-electric sensor characteristics.

Name	Ref. no.	Piezo surface	Buzzer diameter	Frequency	Output impedance
P1	AB4113B/668-1017-ND	41 mm	24.6 mm ²	1.3 kHz	200 Ω / 150 nF
P2	AB4141B/668-1624-ND		16.6 mm ²	4.1 kHz	1 kΩ / 100 nF

P3	AB3526B/668-1015- ND	35 mm	16.6 mm ²	2.6 kHz	300 Ω / 30 nF
P4	7BB-27-4/490-7713- ND				200 Ω / 20 nF
P5	AB2746B/668-1013- ND	27 mm	10.2 mm ²	4.6 kHz	250 Ω / 16 nF
P6	AB2022A/668-1270- ND			2.2 kHz	500 Ω / 80 nF
P7	AB2036B/668-1271- ND		5.7 mm ²	3.6 kHz	500 Ω / 25 nF
P8	AB2040B/668-1006- ND	20 mm		4 kHz	350 Ω / 25 nF
P9	AB2065B/66-1007-ND			6.5 kHz	500 Ω / 14 nF
P10	AB2027S/668-1008- ND		5.31 mm ²	7.2 kHz	300 Ω / 10 nF

3. Discussion on the experimental results with micro-energy harvesting from water wave source

The present section is focused on the description the experimental setup and the discussion on the obtained electrical signal generated results.

3.1.Experimental setup description

Fig. 6 illustrates the photograph of the performed wave water electromechanical micro-energy conversion. The Filix® maintenance team has developed a system to reproduce the effect of the motor

(holding a fixed heading). The wave generator system consists of a plexiglass part that is fixed in the boat hull and allows 360° rotation. The system also allows to manage the height at which the boat is fixed.

The photographs of the mini-boat oriented in the parallel direction with the water wave propagation direction are shown in profile view of Fig. 7.



Figure 6: Photographs of the water wave harvester experimental setup: (a) rear and (b) profile.



Figure 7: Profile view of the boat oriented in the parallel direction to the water wave propagation direction.

3.2. Discussion on the harvested electrical energy

This leaf system topped by a variable speed drive motor allows us to create waves with a frequency of appearance of one wave every second at most and one wave every five seconds.

3.2.1. Piezo-electric single test with water constant rate

To make the connections, without damaging the piezoelectric cells, the wires were soldered on copper tape. The experimentations have been performed in different steps. First of all, we wanted to characterize the piezoelectric cells. To do this, we release an object without initial velocity of known mass and contact surface into a tube of known height. We will not obtain any results during this characterization attempt since the observed phenomenon is a shock and not a pressure, the phenomenon must last a minimum in time for there to be a physical deformation of the piezoelectric cell. Then, we empirically characterized each piezo sensor sensitivity. This characterization will potentially bring us closer to the strength of a wave whose flow rate we can control. It is noteworthy that the tests in aqueous medium with straightening did not yield concluding result.

Table 2: Piezo-electric generated voltage amplitude simulated the test case of water constant rate.

Piezo	P1	P2	P3	P4	P5	P6	P7	P8	P9
V_P (V)	1.78	0.54	1.54	0.47	0.37	0.17	0.29	0.43	0.43

The characterization experimental setup is therefore highlighted by Fig. 8. A massive object was fallen on the piezo sensor with height of about $h=30$ cm.

Then, the induced electrical energy is measured with the voltage indicated by the multimeter.

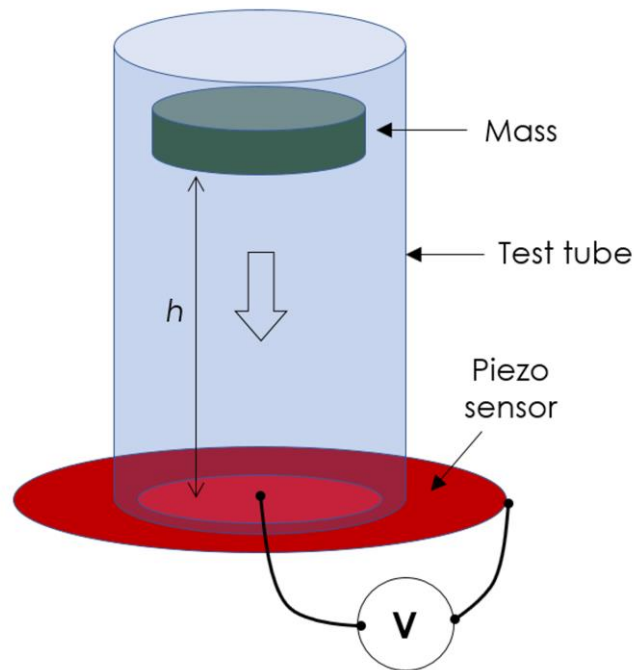

Figure 8: Piezo-electric single test configuration.

The present study is essentially focused on the fluctuating induced voltage amplitude. Table 2 presents the measured results with ten piezo sensors. To determine the optimal characteristics for our sensors, we have chosen a panel of 10 sensors that will allow us to evaluate the characteristics that influence the performance of the sensors in terms of energy recovery.

The values obtained were recorded in an experiment in which the different piezoelectric cells were placed under a continuous flow of known and stable flow and force. Thus, all the cells were exposed, previously covered in a waterproof manner, to a perpendicular flow rate of 0.2 l/s. In order to determine

the influence of the resonance frequency on the efficiency, we used four cells with the same diameter but different frequencies. Fig. 9 plots the obtained results from experimental measurements. We would like to propose an empirical model with low relative errors in term of standard deviation. By using Matlab fourth degree polynomial fitting, the empirical efficiency can be approximated as:

$$\xi = 10^{-4}(12f^4 - 202f^3 + 948f^2 - 909) \tag{2}$$

It should be emphasized that this fourth degree enables to achieve reduce considerably the standard deviation from the measured data and the fitting model.

In addition, we can observe that the cell surface is the parameter that most influences the yield. Indeed, the first cell is both the largest in terms of surface area but also has the lowest resonance frequency, yet it is the cell with the best efficiency. It should be pointed out that the sensor operating at 4.1 kHz frequency cell is actually defective. We therefore used only the 41 mm diameter cell presenting a resonance frequency of 1.3 kHz.

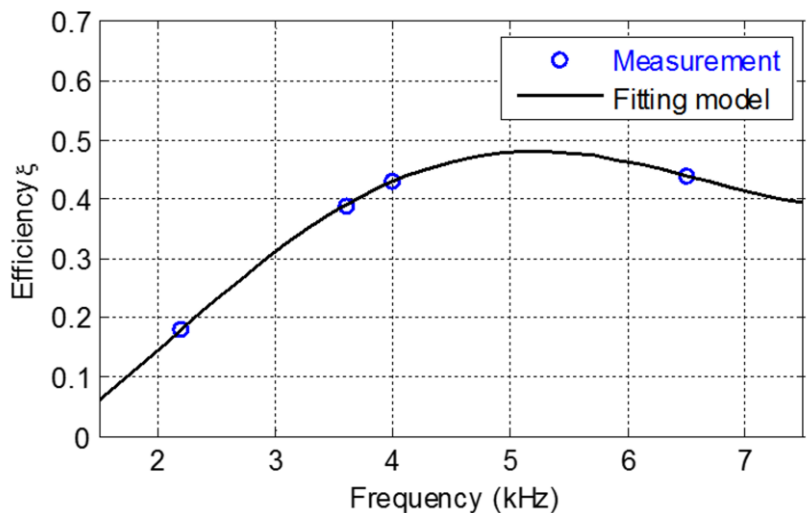

Figure 9: Piezo-electric efficiency versus resonance frequency with water rate 0.2 l/s with

propagating direction perpendicular to the piezo surface.

3.2.2. Dynamic wave harvesting test results

This leaf system topped by a variable speed drive motor allows us to create waves with a frequency of appearance of one wave every second at most one wave every five seconds.

During the present study, we attended to look at the different circuits that may be used in the future. It seems that signal rectification system is needed. It should be noted that the signal of a piezoelectric cell is a continuous signal that alternates sign according to the action performed on the cell. When a pressure is applied, the signal is positive and when the cell is relaxed, the signal is negative, so that the internal loads of the cell are rebalanced and are ready for use again.

We can therefore see that the direct addition of induced voltage by connecting two cells together in series has a lower efficiency than indirect addition. This finding is because of the fact that the two cells are independent of about 4 mV against 6 mV. But in terms of gross recovery, the indirect addition is not optimal for our system. Indeed, although there is an improvement, when performing an indirect additive assembly with six piezoelectric cells, we find that the growth curve of energy recovery takes the form of a logarithmic curve presented in Fig. 11.

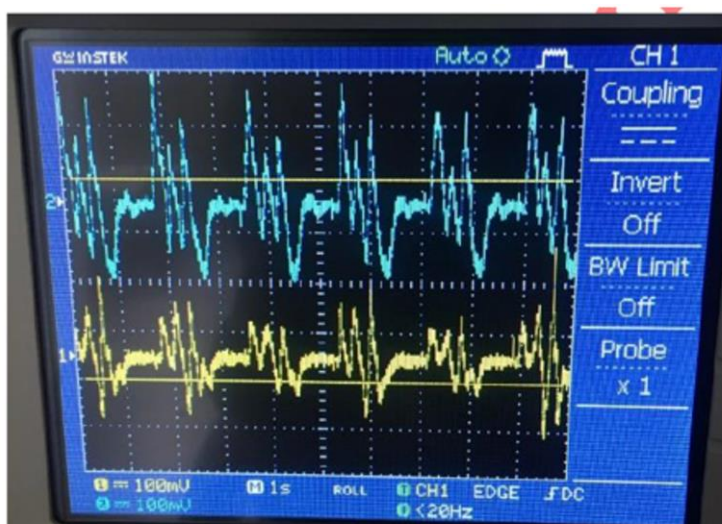

(a)

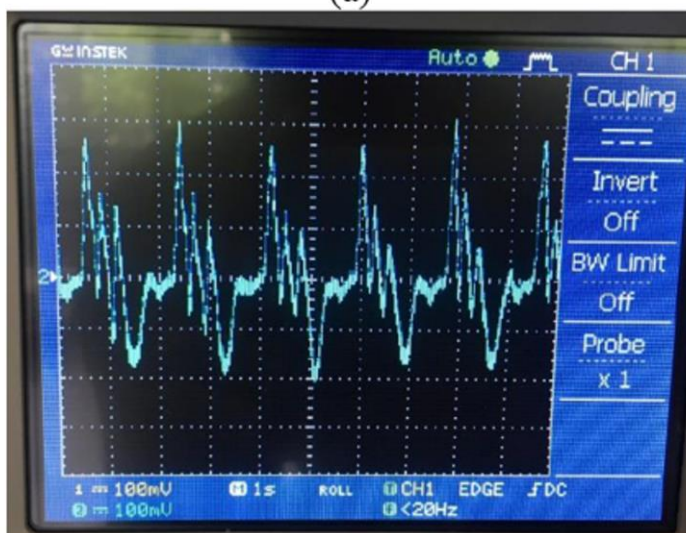

(b)

Figure 10: (a) Signals emitted by two piezoelectric cells (Signal 1: 150 mV Signal 2: 250 mV) and (b) the added signals (Signal 2: 300 mV).

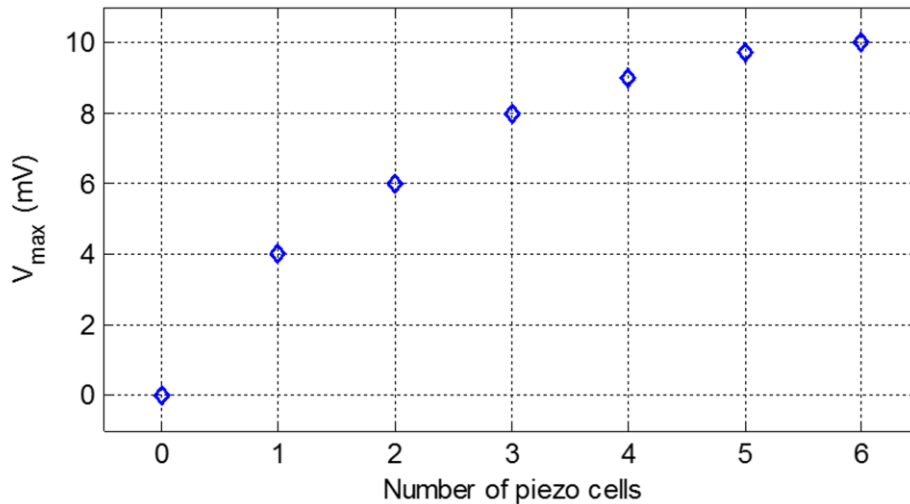

Figure 11: Generated electrical voltage average value in function of piezo-electric quantity.

3.2.3. Influence of water wave propagation and mini-boat orientation

This leaf system topped by a variable speed drive motor allows us to create waves with a frequency of appearance of one wave every second at most and one wave every five seconds. We have tried to map the efficiency of energy recovery as a function of the sensor position and the orientation of the boat. This will allow us to optimize the monitoring afterwards. (i.e. define predefined areas of analysis and monitoring on the hull). We studied empirically the influence of the boat's orientation on the energy recovery of the different positions.

In this experiment, we wanted to highlight the influence of the boat's orientation on the energy recovery of each position independently of each other.

The experimental protocol was to place the boat halfway between the bottom of the aquarium and the wave creating sash as explained by Fig. 12. Then, the boat was oriented according to the angles $\theta=\{0^\circ,$

45° 90° 135°, 180° 225°, 270°, 315°}. Table 3 presents the measured electric voltage maximal amplitude of each of the positions. The wave flow created is constant and regular and moves in the 0°-180° axis.

Table 3: Measured electric voltage maximal amplitude (in mV) in function of the mini-boat orientation.

	0°	45°	90°	135°	180°	225°	270°	315°
Position 1	180	150	200	300	200	220	300	200
Position 2	250	280	400	400	300	370	450	300
Position 3	40	50	60	60	50	80	80	50
Position 4	120	200	350	200	150	250	200	150
Position 5	300	320	500	300	300	420	380	350
Position 6	200	200	300	200	220	200	220	220

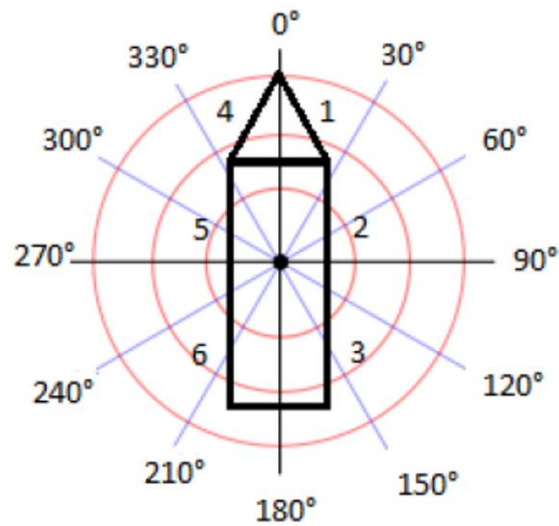

Figure 12: Mini-boat orientation reference.

For the better insight about the sensor efficiencies, the radar maps of the measured maximal voltage in function of water wave propagation direction and mini-boat orientation are shown in Fig. 13.

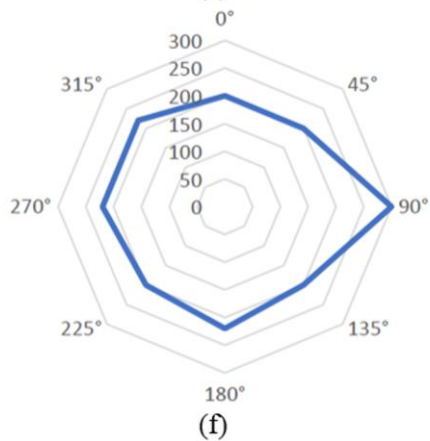
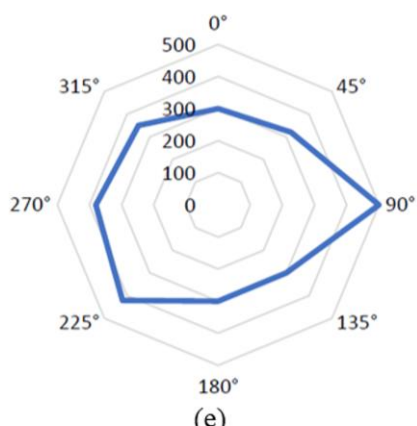
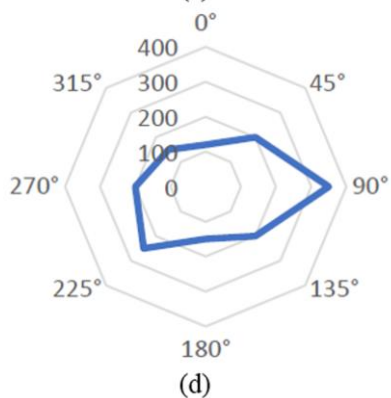
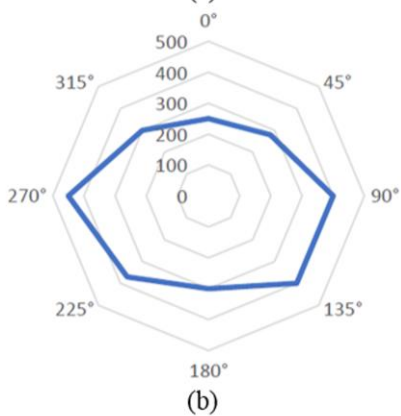
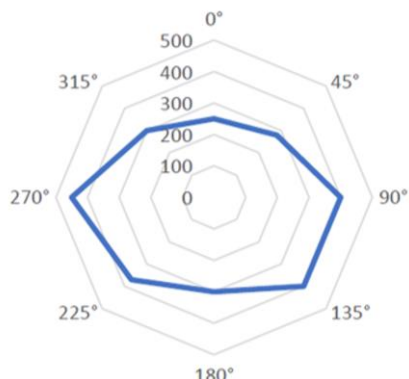
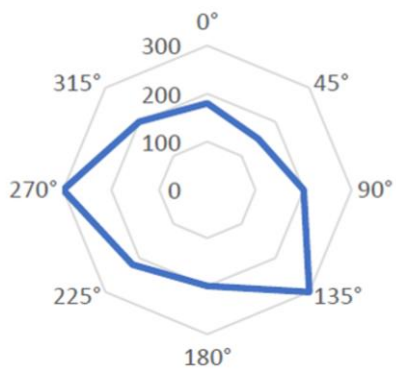

Figure 13: Radar maps of test results in function of water wave propagation direction and mini-boat orientation: (a) Position 1, (b) Position 2, (c) Position 3, (d) Position 4, (e) Position 5 and (f) Position 6.

4. Conclusions

An innovative harvesting technique of water wave electromechanical energy is investigated. The energy harvesting proof of concept was designed with a mini-boat placed in a water tank filled with water. The design method of the mini-boat prototype integrating piezo cells is described. The energy harvesting experimental setup is originally introduced.

The empirical test results were obtained under laboratory conditions, which implies low values and therefore limited analysis. The harvested electric power range depends on the piezoelectric technology performance. Further investigation is also performed to highlight the influence of the piezo cell positioning and the boat orientation. The amplitude of the harvested electric power is mapped in function of the board orientation compared to the wave propagation direction. We have determined which direction leads to the best performance.

In outlook of this research work, the proposed harvester will be transposed to more realistic conditions to be able to evaluate the higher amount of real recoverable energy. The present experimental investigation is prominent in the future for the development of energy storage technique in wider scale as in the marine environment.

Acknowledgements

Acknowledgement is made to the France Normandy Region for the “FIL HARMONIQUE” project grant no. 18E00151 2017-2019 support of this research work, research and publication of the present article.

The present research work was funded with the master internship student Sébastien Rigourd who was employed by Filix for the FIL HARMONIQUE project.

The authors declare that there is no conflict of interest regarding the publication of this paper.

References

- [1] A.-B. Zhang, C.-D. Kim, E. Yamada, F.G. Smith, The numerical investigation on the turbulent heat transfer, *Int. J. Heat Mass Transfer* 12: 345–365, 2010.
- [2] S.V. Patankar, *Numerical Heat Transfer and Fluid Flow*, Hemisphere Publishers, New York, 1980.
- [3] W.M. Kays, M.E. Crawford, *Heat transfer*, Wiley, New York, pp.256-258, 1990.
- [4] Y. Kawaguchi, T. Tsukahara, M. Motozawa, Experimental and numerical investigations of turbulent drag reduction phenomena by additives, *Proc. ASCHT09*, Jeju, Korea, pp. 23–32, 2009.
- [5] Available online: <https://5g-ppp.eu/>, Accessed Sept. 2018.
- [6] A. Nordmann, “Converging technologies – Shaping the future of European societies,” *Report Community Research* EUR 21357 2004.
- [7] A. Harb, Energy harvesting: State-of-the-art, *Renewable Energy* 36(10): 2641-2654, 2011.
- [8] Fujitsu, Fujitsu develops hybrid energy harvesting device for generating electricity from heat and light, 2010, Available online: <http://www.fujitsu.com/global/about/resources/news/press-releases/2010/1209-01.html>, Accessed Sept. 2018.
- [9] IDTechEx, Piezoelectric energy harvesting 2013-2023: Forecasts, Technologies, Players, 2014, Available online: <https://www.idtechex.com/>, Accessed Sept. 2018.
- [10] PowerWalk®, Available online: <http://www.bionic-power.com/>, Accessed on 2018.
- [11] R. Riemer, A. Shapiro, Biomechanical energy harvesting from human motion: theory, state of the art, design guidelines, and future directions, *J. Neuroeng. Rehabil.* 8(22): 1-13, 2011.

- [12] G. Bassani, A. Filippeschi, E. Ruffaldi, Human motion energy harvesting using a piezoelectric MFC patch, *Proc. 2015 37th Annual Int. Conf. of the IEEE Engineering in Medicine and Biology Society (EMBC)*, Milan, Italy, pp. 5070-5073, 2015.
- [13] C. Dagdeviren, B. D. Yang, Y. Su, P. L. Tran, P. Joe, E. Anderson, J. Xia, V. Doraiswamy, B. Dehdashti, X. Feng, B. Lu, R. Poston, Z. Khalpey, R. Ghaffari, Y. Huang, M. J. Slepian, J. A. Rogers, Conformal piezoelectric energy harvesting and storage from motions of the heart, lung, and diaphragm, *Proc. of the National Academy of Sciences (PNAS)* 111(5) 1927-1932, 2014.
- [14] Y.-M. Choi, M. G. Lee, Y. Jeon, Wearable biomechanical energy harvesting technologies, *Energies* 10(1483): 1-17, 2017.
- [15] S. Boisseau, G. Despesse, B. A. Seddik, "Electrostatic conversion for vibration energy harvesting," *InTech Open*, Chap. 5, Access Publisher, Rijeka, Croatia, 91-134, 2012.
- [16] T. D. Usher, K.R. Ulibarri, G. S. Camargo, Piezoelectric microfiber composite actuators for morphing wings, *Hindawi, Materials Science* 2013(189659) 1-8, 2013.
- [17] A. Kunadt, G. Pfeifer, W.-J. Fischer, Ultrasound flow sensor based on arrays of piezoelectric transducers integrated in a composite, *Procedia Materials Science* 2: 160–165, 2013.
- [18] X. Chen, S. Xu, N. Yao, Y. Shi, 1.6 V Nanogenerator for mechanical energy harvesting using PZT nanofibers, *Nano Lett.* 10(6): 2133–2137, 2010.
- [19] W. Hufenbach, F. Adama, W.-J. Fischer, A. Kunadt, D. Wecka, Effect of integrated sensor networks on the mechanical behaviour of textile-reinforced thermoplastics, *Procedia Materials Science* 2: 153–159, 2013.
- [20] F.-R. Fan, Z.-Q. Tian, Z. L. Wang, Flexible triboelectric generator, *Nano Energy* 1(2): 328-334, 2012.
- [21] L. Valentini, M. Cardinali, J. Kenny, Flexible triboelectric generator and pressure sensor based on poly[(R)-3-hydroxybutyric acid] biopolymer, *Journal of Polymer Science, Part B: Polymer Physics* 52(13): 859–863, 2014.

- [22] W. A. Hufenbach, P. Kostka, B. Maron, D. Weck, J. Ehlig, M. Gude, M. Zscheyge, Development and investigation of a textile-reinforced thermoplastic leaf spring with integrated sensor networks, *Procedia Materials Science* 2: 173–180, 2013.
- [23] P. Buckley, Woven piezoelectric yarns lead to 3D textile energy harvester, 2014, Available online: <http://www.eenewseurope.com/news/woven-piezoelectric-yarns-lead-3d-textile-energy-harvester>, Accessed Sept. 2018.
- [24] A. Y. Choi, C. J. Lee, J. Park, D. Kim, Y. T. Kim, Corrugated textile based triboelectric generator for wearable energy harvesting, *Scientific Reports* 7(45583): 1-6, 2017.
- [25] C. Castille, Etude de MEMS piézoélectriques libérés et microstructurés par sérigraphie. Application à la détection en milieu gazeux et en milieu liquide. Micro et nanotechnologies/Microélectronique (in French), *PhD thesis, Université Sciences et Technologies - Bordeaux I*, 2010.
- [26] B. Ravelo, F. Duval, S. Kane, B. Nsom, Demonstration of the triboelectricity effect by the flow of liquid water in the insulating pipe, *Journal of Electrostatic, Fundamentals, Applications and Hazards* 69(6): 473-478, 2011.
- [27] G. Zhu, Y. Su, P. Bai, J. Chen, Q. Jing, W. Yang, Z. L. Wang, Harvesting water wave energy by asymmetric screening of electrostatic charges on a nanostructured hydrophobic thin-film surface, *ACS Nano* 8 6: 6031-6037, 2014.
- [28] T. V. Papakostas, J. Lima, A large area force sensor for smart skin applications, *Proc. of IEEE Sensors 2002*, 2: 1620-1624, Orlando, FL, USA, USA, 2002.