



HAL
open science

Optimal Sizing of PV System Combined to Cooling Load Management Strategy towards Photovoltaic Self-Consumption in Buildings

van Binh Dinh, Hoang Anh Dang, Benoit Delinchant, Frederic Wurtz

► To cite this version:

van Binh Dinh, Hoang Anh Dang, Benoit Delinchant, Frederic Wurtz. Optimal Sizing of PV System Combined to Cooling Load Management Strategy towards Photovoltaic Self-Consumption in Buildings. International Journal of Electrical and Electronic Engineering & Telecommunications , 2018, pp.90–95. 10.18178/ijeetc.7.3.90-95 . hal-02278157

HAL Id: hal-02278157

<https://hal.science/hal-02278157v1>

Submitted on 22 Apr 2020

HAL is a multi-disciplinary open access archive for the deposit and dissemination of scientific research documents, whether they are published or not. The documents may come from teaching and research institutions in France or abroad, or from public or private research centers.

L'archive ouverte pluridisciplinaire **HAL**, est destinée au dépôt et à la diffusion de documents scientifiques de niveau recherche, publiés ou non, émanant des établissements d'enseignement et de recherche français ou étrangers, des laboratoires publics ou privés.

Optimal sizing of PV system combined to cooling load management strategy towards photovoltaic self-consumption in buildings

Van Binh. Dinh¹, Hoang Anh. Dang², Benoit. Delinchant¹, Frederic. Wurtz¹

1. Univ. Grenoble Alpes, CNRS, Grenoble INP, G2Elab, F-38000 Grenoble, France

2. Institute of technology, Hanoi University of Industry, Hanoi, Vietnam

Email: van-binh.dinh@g2elab.grenoble-inp.fr

Abstract—Renewable energy resources are becoming more and more important for the electricity production regarding the security problem of nuclear energy and the limit of fossil fuels. Among the renewable resources, solar power is an interesting candidate for buildings that are the biggest consumers of the electrical grid. Indeed, integrating photovoltaic power systems on the roof of commercial and office buildings is permitting to reduce significantly their electricity consumption from conventional local grid. This paper presents a sizing method of photovoltaic panels for maximizing the match between the building's load profile and the solar energy generation shape without battery in taking into account the investment profitability. A cooling load management strategy is also proposed thanks to optimization based on the thermal inertia of walls for improving the self-consumption of the building. These methods are applied for a university building in north of Vietnam, in which we show the feasibility of on-grid PV system investment with respect to cost scenarios.

Index Terms— PV optimal sizing, self-consumption, load management, renewable energy, energy and buildings, design optimization.

I. INTRODUCTION

With the aim of energy transition for climate change problem, many countries around the world are focusing on exploiting decarbonized renewable energy. In United State, renewable electricity represented 64% of electricity capacity added in 2015 that raised 12% from 2014 [1]. The European Union aimed by 2020 at sharing the energy consumption by 20% of renewable energy [2]. Compared to the other renewable energy sources, solar photovoltaic and wind power account still for a low installed capacity but their average annual growth rates have been especially high (46.2% and 24.3% respectively) since 1990 [3]. Vietnam is assessed as a country having significant renewable energy potential, in particular for producing photovoltaic electricity thanks to a high number of sunny hours. However, it couldn't develop this sector for different reasons consisting of low electricity prices and high initial investments of PV system [4]. Recently, regarding the downtrend of system investment price and national planning for renewable energy, photovoltaic systems are being taken into consideration

seriously for the country. PV systems for buildings have the potential to become the greatest producers of renewable energy thanks to their roofs exposure to sun. In addition, buildings are the biggest consumers of electricity grid, which use 40% of the world's primary energy [5]. This number is about 30% in Vietnam [4]. Therefore, improving self-sufficiency degree of buildings with photovoltaics is important factor for reducing problems of electricity grid and this is also essential for the energy transition. It is even more reasonable to do this in Vietnam as an important consumption load is due to the air conditioning, especially from non-residential buildings (office, commercial and university), which can be fitted with high energy production from the sun in summer.

The main purpose of this paper is, on the one hand, to propose a sizing method of photovoltaic panels without battery for optimizing the match between a grid-connected building's load profile and the solar energy generation shape, taking into consideration the total system cost over 30 years. Through this, the project's feasibility and time duration for the return on investment is shown. In this study, we are trying to increase the renewable energy production without impacting a lot the electricity grid stability. For that, photovoltaic production and electricity consumption must be synchronized. Battery packs could be a solution, but we are trying to avoid them due to their impact at the end of life cycle for environment. Moreover, operation time of building loads could be relatively close to photovoltaic production time. On the other hand, we also propose in operation phase a cooling load management strategy based on thermal inertia of the building for maximizing the photovoltaic self-consumption.

The remainder of the paper is organized as follows: Section 2 presents the case study and system modelling for the design and control. Optimal sizing method of PV panels is then detailed in section 3 while optimal management strategy of cooling load is described in section 4. Section 5 summarizes the main conclusions of this paper and evokes some future works.

II. SYSTEM MODELLING

A. Case Study and Building Model

Our case study is a university building including several classrooms to be constructed in north of Vietnam with a floor area of about 500m². Its walls are structured traditionally by burned bricks and plaster without insulation (Fig. 1).

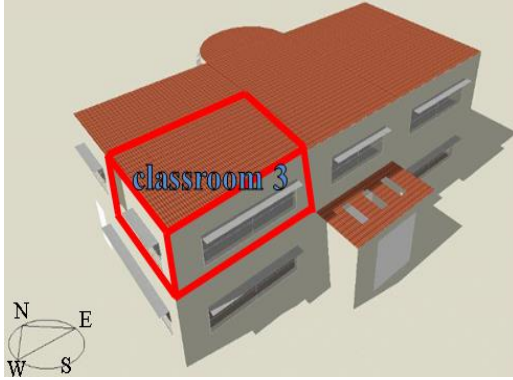

Figure 1. Overview of studied building.

In this study, one tries to optimize the size of photovoltaic panels that is installed on the roof of the building, and the operation of cooling load for maximizing the self-consumption of classroom 3 without battery. It permits a rapid analysis of the feasibility of PV investment for this room which can be further extrapolated to whole building regarding the similar load of classrooms. In order to reach this objective, an equivalent electrical model (Fig. 2) was built to observe the room internal temperature and to optimally control the air-conditioning with respect to the set-point in summer.

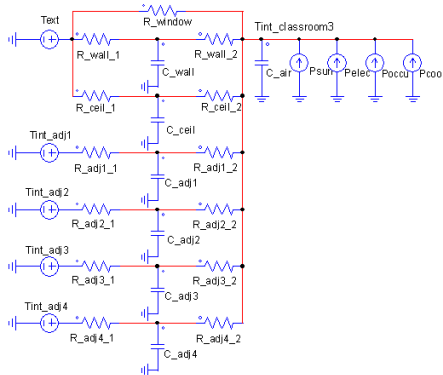

Figure 2. Equivalent electrical model of classroom 3.

This model considers that electrical components like voltage sources, current sources, resistors and capacitors are respectively corresponding to temperatures, heat gains, thermal resistances and capacitances. Thanks to Ohm and Kirchoff's laws, the model can be written by equation:

$$x'(t) = A.x(t) + B.u(t) \quad (1)$$

Where x is state vector of the internal temperature of classroom 3 and temperatures in the middle of walls. Vector u includes the input temperatures and heat gains. A and B are state matrices depending on the resistances and capacitances. The detailed construction of a building thermal equivalent electrical model is described in [6, 7].

B. Photovoltaic Panel Model

The model for calculating the hourly electricity power P_{PV} generated by photovoltaic panels is essential for the PV design and the energy management. According to Kaabeche et al. [8], P_{PV} (W) can be calculated by the equation:

$$P_{PV}(t) = \eta_{PV} \cdot S_{PV} \cdot I_{PV}(t) \quad (2)$$

η_{PV} is the system global efficiency; S_{PV} is the PV panel area (m²); I_{PV} represents the global incident solar radiation on the titled plane (W/m²), which is derived from weather data of horizontal direct solar radiation I_D and horizontal diffuse solar radiation I_d :

$$I_{PV}(t) = I_D(t) \cdot r_b(t) + I_d(t) \cdot \frac{1 + \cos(\beta)}{2} + [I_D(t) + I_d(t)] \cdot \rho \cdot \frac{1 - \cos(\beta)}{2} \quad (3)$$

β is tilted angle of panel plane (rad); ρ is the reflection coefficient of ground; r_b is ratio between the direct radiation on the titled plane and the horizontal direct radiation. This ratio is dependent on sun position, orientation and tilt of panels [9].

These equations allow determining easily that the photovoltaic generation for the studied location (latitude: 21°01'28" N and longitude: 105°50'28" E) is maximized for panels facing south with a tilt angle of 14°.

III. OPTIMAL SIZING METHOD OF PV SYSTEM TOWARDS SELF-CONSUMPTION IN THE BUILDING

A. Methodology

The power flow of consumption and production system in this study is described in Fig. 3.

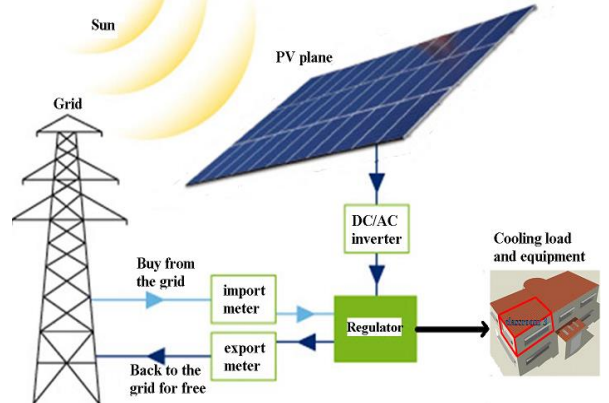

Figure 3. PV-grid-load system architecture.

Photovoltaic power system will be sized to be able to provide the electricity at best for building loads. In case if the solar power generation is smaller than the consumption, the lacked electricity will be bought from the grid. On the contrary, it is supposed that the electrical power can be sent back to the grid for free.

Our methodology aims at suggesting the optimal size of PV system for minimizing the total system cost over 30 years. The total cost is composed of 2 elements. The first one is related to the purchasing price of electricity from the grid over one year extrapolated to 30 years, due to the deficit at moments that load power is bigger than photovoltaic power. The second includes the initial investment of PV system (panels, inverter, cables...), maintenance and replacement cost of components. As a result, minimizing the total system cost has the same tone with maximizing the self-consumption of system (Fig. 4).

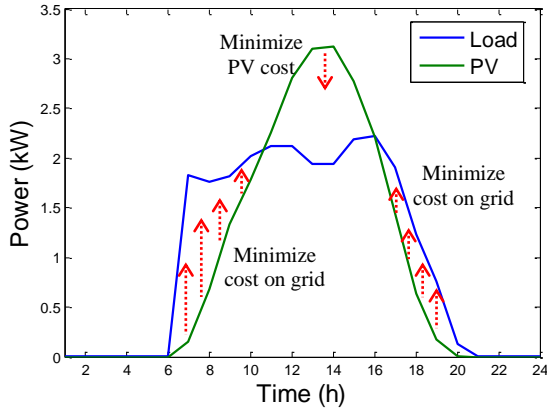

Figure 4. Optimal sizing method of PV system.

B. Optimization Problem Formulation

Objective function and design parameter:

As described in the methodology, the optimization objective is to determine the optimal area S_{PV} (m^2) of photovoltaic panels for minimizing the total system cost over 30 years. It can be formulated as follows:

$$\min \text{obj} = \min(c_{ost_{grid}} + c_{ost_{invPV}} + c_{ost_{rep_inverter}}) \quad (4)$$

In (4), the first term corresponds to the cost of electricity bought from the grid. The second stands for the initial investment cost of PV system while the last one represents the replacement cost of inverter. It is remarked that the maintenance cost is negligible to simplify the calculation since it accounts for only about 1 or 2% of the system cost. The inverter is considered to be equal to 10% of the global system investment cost, and needs to be replaced 2 times during 30 years. Meanwhile the life cycle of PV modules is supposed to be equal to the studied period (30 years). Each of these cost functions is expressed in equations (5), (6) and (7).

$$c_{ost_{grid}} = \left[\sum_{i=1}^{12} \frac{a_i}{1000} \cdot \sum_{t=1}^{t_{endmonth}} \max(P_{load}(t) - P_{PV}(t), 0) \right] \cdot \sum_{n=1}^{LC} \left(\frac{1+\tau_1}{1+\tau_2} \right)^n \quad (5)$$

$$c_{ost_{invPV}} = c_{unitPV} \cdot S_{PV} \quad (6)$$

$$c_{ost_{rep_inverter}} = c_{invInverter} \cdot \left[\left(\frac{1+\tau_1}{1+\tau_2} \right)^{10} + \left(\frac{1+\tau_1}{1+\tau_2} \right)^{20} \right] \quad (7)$$

$P_{load}(t)$ represents load power (W); $P_{PV}(t)$ is photovoltaic power (W) at hour t , which is dependent on the PV area according to the equation (2). $t_{endmonth}$ is the final hour of each month; a_i is electricity purchasing price by kWh (USD/kWh) which is fixed with respect to the level of energy consumed per month. τ_1 and τ_2 are annual inflation rate and real interest rate respectively; LC is the studied period (30 years). c_{invPV} is unit investment cost of $1m^2$ PV (USD/m^2). $c_{invInverter}$ is investment cost of an inverter AC/DC (10% of PV system investment cost).

Design scenario:

Performing the optimization problem requires scenarios of load profile and meteorological data of a typical year that are presented in Fig.5 and Fig. 6.

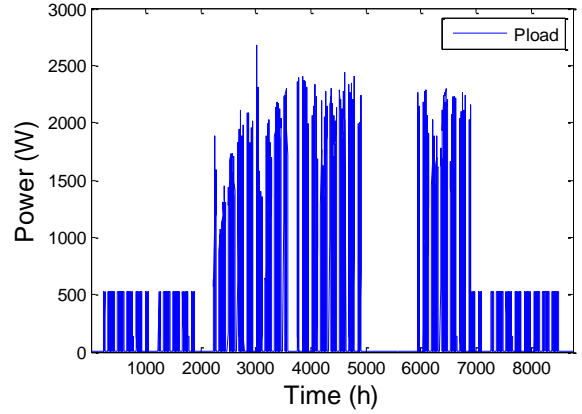

Figure 5. Building load profile in a typical year.

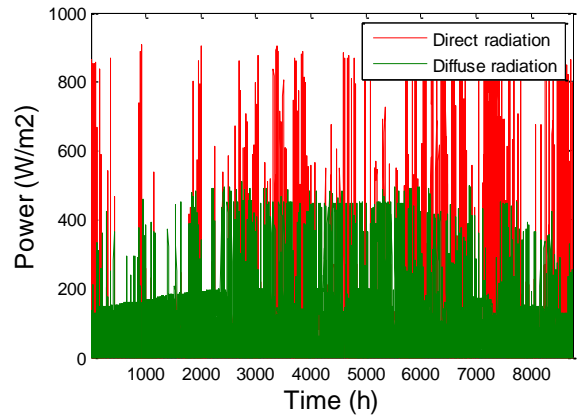

Figure 6. Meteorological data of horizontal solar radiation in a typical year.

The price for buying electricity from the grid is described in table 1, which increases together with amount of kWh consumed per month. Meanwhile, the unit investment cost of PV crystalline modules for Vietnam and Southeast Asia is about 470 USD/kW_p¹ corresponding to 94 USD/m² if the electricity generation efficient of PV panels is considered as 20%. However, the total installed cost of PV system (including inverter, cables, meters etc.) is estimated at twice this price. In our study, the total unit investment cost of PV system may vary between 300 USD/kW_p and 2000 USD/kW_p (between 60 USD/m² and 400 USD/m² respectively). Then we are studying the installation feasibility and optimal PV area for minimizing the objective function in (4) for each case of this cost. The optimization problem is solved in CADES software² using first order deterministic algorithm SQP (Sequential Quadratic Programming).

TABLE I. ELECTRICITY PURCHASING PRICE BY KWH

Monthly energy level (kWh)	Electricity price (USD/kWh)
0-50	0.065
51-100	0.067
101-200	0.079
201-300	0.099
301-400	0.110
> 401	0.114

<http://www.evn.com.vn>

C. Results and Analysis

Figure 7 shows 15 optimal results of photovoltaic panel's area for 15 cases of unit investment cost of PV system (between 60 USD/m² and 400 USD/m²). If we consider that the actual unit investment cost of PV system is 157 USD/m² (~800 USD/kW_p), the optimal PV area is obtained with 12 m² (case 5 in Fig. 7). When the unit investment cost decreases, the optimal PV area is between 15m² and 20m² (cases from 1 to 4 of figure 7). On the contrary, the optimal size of PV panels decreases when the PV unit investment cost is increasing. In other words, more expensive the technology cost is, smaller the optimal PV area to be installed is. When the investment cost exceeds 351 USD/m², optimal PV size is equal to 0 meaning that solar photovoltaic panels are no more profitable.

Fig. 8 depicts the moment for return on PV investment for 4 cases (1, 4, 5 and 6) of Fig. 7. Case 5 is the reference case (PV unit investment cost of 157 USD/m²) while case 1 corresponds to the scenario that PV unit investment cost is very cheap (60 USD/m²). Cases 4 and 5 represent scenarios with 15% less and more expensive respectively of PV unit investment cost than the reference case. The result in Fig. 8 indicates that the reference case needs 15 years for return on investment while case 6 is

profitable after 18 years. With the PV unit investment cost of 15% less than the reference case, the time for return on investment of case 4 is about 12 years. In case 1 with the cheapest investment cost, only 6 years are required for profitability. It is to note here that this study has not taken into account financial incentives of government and the income by sell back to the grid. Once policies and mechanisms for supporting the PV investment are attractive enough, the time duration for return on investment must be significant decreased.

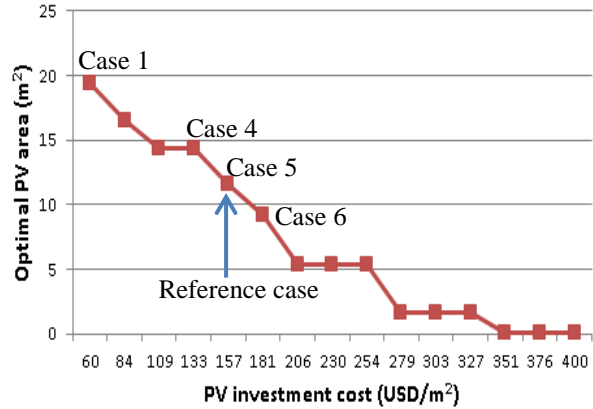

Figure 7. Optimal size of PV as a function of the unit investment cost of solar panels.

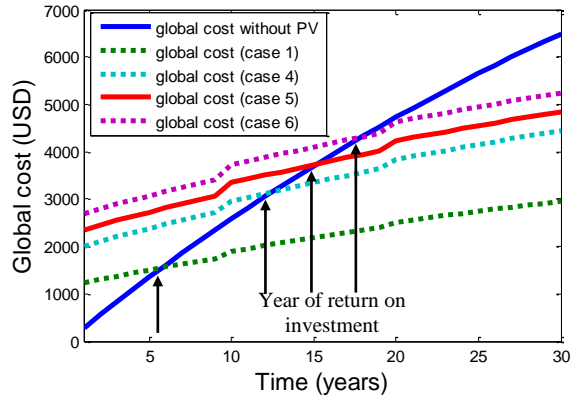

Figure 8. Time duration for return on PV investment.

IV. COOLING LOAD MANAGEMENT STRATEGY FOR IMPROVING SELF-CONSUMPTION IN THE BUILDING

In operation phase, it is also interesting to realize the optimal control of building's loads for improving its self-consumption. For the studied building, we focus on the optimal operation management of the air-conditioning such that the total consumption, consisted of cooling load $P_{cool}(t)$ and fixed electrical equipment load $P_{equip}(t)$, is close to the photovoltaic generation.

Actually, the cooling load is controlled to respect exactly the temperature set point, for example 23°C during occupation in summer days. In order to improve the building's self-consumption for reducing the

¹ <https://www.pv-magazine.com/features/investors/module-price-index/>

² <http://www.vesta-system.fr>

consumption on the grid, we are proposing a more flexible temperature set point: it can be less than or equal to 23°C instead of equal exactly to 23°C. This would allow exploiting the best of photovoltaic production at noon (in case of lots of sunshine) for cooling the room until fewer than 23°C (and not exceeding 20°C for example). The excess of coolness is accumulated in walls and later returned to the ambient air of the room in the evening thanks to thermal inertia of walls. As a consequence, cooling power can be reduced at the evening when the photovoltaic generation is limited. To quantify exactly the cooling power, the management strategy needs to be performed thanks to the optimization based on the PV and building models constructed in section 2. The optimization problem can be formulated by seeking to cooling power $P_{cool}(t)$ for minimizing the objective function in equation (8) with the constraint of room internal temperature $T_{int}(t)$ in (9).

$$\min f = \min \left[\sum_{t=1}^{24} \max(P_{cool}(t) + P_{equip}(t) - P_{PV}(t), 0) \right] \quad (8)$$

$$\text{Constraint: } 20 \leq T_{int}(t) \leq 23 \quad (9)$$

Figures from 9 to 11 present the optimization results. It is observed in Fig. 10 that optimal management of air-conditioning made the total load power (in green) closer to photovoltaic power (in purple) compared to the case without optimization (in red), in particular from 4pm to 7pm. This is due to, as expected, that the air-conditioning system benefits from the photovoltaic production to overcool the room from 11am to 3pm (Fig. 10) so that room temperature (in green of Fig. 9) went down to near 20°C. With the help of the thermal inertia (composition of walls weight and thermal insulation), the cooled heat was stored in walls and returned to the air later. That permitted to decrease 400Wh of the load power from 4pm to 7pm compared to the case without management. Another idea that we would like to present here is if the occupancy accepts a comfort temperature of 23.5°C (in blue of Fig. 9) instead of 23°C, the result of load management (cf optimal load power in blue curve of Fig. 10) is much better with 1.7kWh saved. We are talking about the behaviour of occupants who play an important role for improving the self-consumption. Fig. 11 presents the grid power derived from the Fig. 10. We see that the optimal management combined with tolerant behaviour of users brings significant advantages for the grid: decreasing the electricity injection to grid at noon and decreasing the consumption from the grid at the evening. It is to remark that these results can be even better if the thermal inertia is higher than the studied building which has only a weak inertia from walls without thermal insulation.

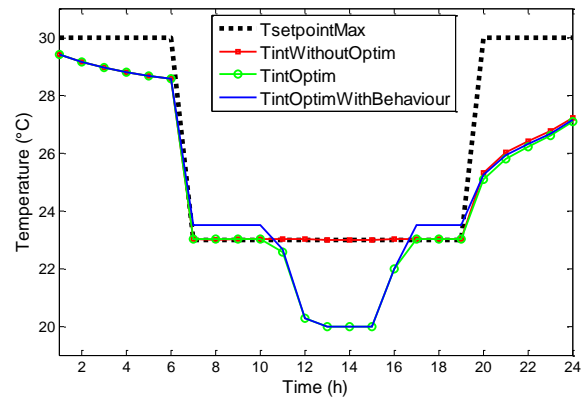

Figure 9. Controlled room temperature with and without optimal management.

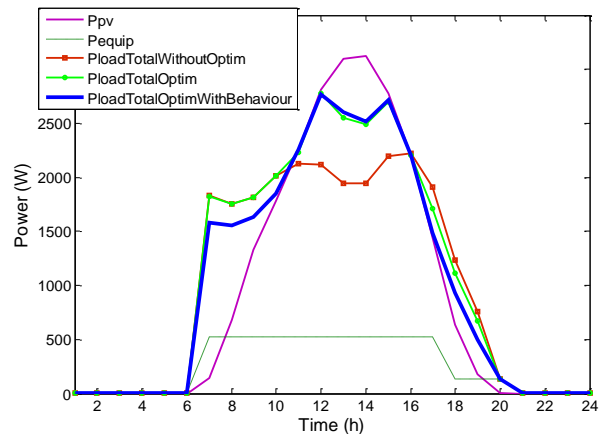

Figure 10. Controlled load power with and without management.

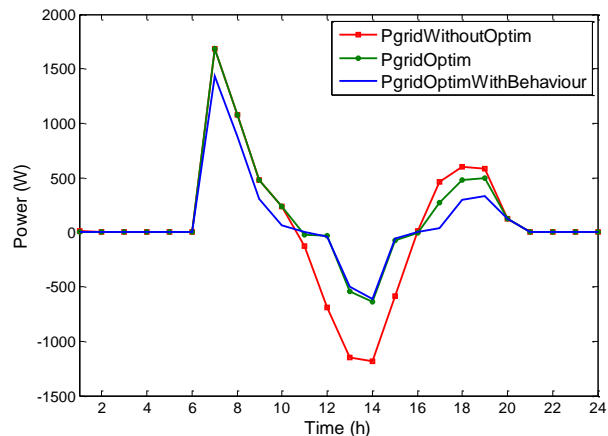

Figure 11. Grid power with and without management.

V. CONCLUSIONS

This paper has introduced the design and management methods for improving the self-consumption of buildings. The results showed the feasibility and detailed time for return on investment of PV system for the university building in Vietnam. The study of many price scenarios permits designers and investors to have a large vision on

the investment of renewable energy at the country not only for now but also for the future. Meanwhile, optimal load management strategy indicated the potential to obtain the self-sufficiency degree of buildings with photovoltaics in operation phase. It showed also that the user behaviour has an important role in this play. For future works, the proposed methods should be tested for the whole building, even a town and be integrated into real time energy management system. A detailed study of financial feasibility for supplementing the thermal insulation of building walls will be also interesting because the isolated walls allow reducing significantly the thermal loss in all seasons and also improving the thermal inertia for optimal management of air-conditioning.

REFERENCES

[1] P. Beiter and T. Tian, *2015 Renewable Energy Data Book*, edited by M. Meshed, U.S. Department of Energy's NREL Laboratory, p 3, 2015. Available: <https://www.nrel.gov/docs/fy17osti/66591.pdf>

[2] European Commission, *Europe 2020 Flagship Initiative Innovation Union*, Luxembourg: Publications Office of the European Union, 2011, ISBN: 978-92-79-17688-3, DOI: 10.2777/274972010.

[3] International Energy Agency, *Key Renewables Trends. Excerpt from renewables information*, p3, 2016. Available: <http://www.buildup.eu/en/practices/publications/renewables-information-2016-key-renewables-trends-excerpt-0>

[4] Danish Energy Agency, *Vietnam Energy Outlook Report 2017*, pp. 17-19, 2017. Available: https://ens.dk/sites/ens.dk/files/Globalcooperation/Official_docs/Vietnam/vietnam-energy-outlook-report-2017-eng.pdf

[5] A. Costa, M.M. Keane, "Building operation and energy performance: Monitoring, analysis and optimization toolkit," *Applied Energy*, vol. 101, pp. 310-316, 2013.

[6] H. A. Dang, B. Delinchant, F. Wurtz, "Toward building energy management: Electric analog modeling for thermal behavior simulation," *IEEE Trans. on Sustainable Energy Technologies*, pp. 246-250, 2016.

[7] V. B. Dinh, B. Delinchant, F. Wurtz, "The Importance of Derivatives for Simultaneous Optimization of Sizing and Operation Strategies: Application to Buildings and HVAC Systems," in *Proc. 3th IBPSA-England Conf. BSO*, Great North Museum, Newcastle, 12th-14th Sept, 2016.

[8] A. Kaabeche, M. Belhamel, R. Ibtouen, "Optimal sizing method for stand-alone hybrid PV/wind power generation," *Revue des Energies Renouvelables SMEE'10 Bou Ismail Tipaza*, pp. 205-213, 2010.

[9] M. J. Ahmad, G. N. Tiwari, "Estimation of luminous efficacy of daylight and illuminance for composite climate," *International journal of energy and environment*, vol. 1, pp. 257-276, 2010.

Van Binh. Dinh was born in Vietnam in 1989. He took his degree in Automatic control, Systems and Information Technology in 2013 at the Grenoble Institute of Technology in France. In 2016, he obtained his PhD degree in Electrical Engineering from Grenoble Alpes University. He is now a postdoctoral researcher at Grenoble Electrical Engineering Laboratory on modelling and optimization methods for design and operation of smart buildings and solar energy systems.

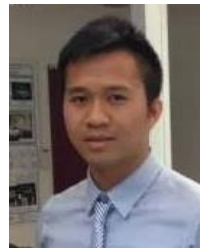

Firstname B. Lastname was born



Firstname D. Lastname

Firstname C. Lastname

