



HAL
open science

Fibred Pseudo Double Categories for Game Semantics

Clovis Eberhart, Tom Hirschowitz

► **To cite this version:**

Clovis Eberhart, Tom Hirschowitz. Fibred Pseudo Double Categories for Game Semantics. *Theory and Applications of Categories*, 2019, 34, pp.514 - 572. hal-02274815

HAL Id: hal-02274815

<https://hal.science/hal-02274815>

Submitted on 30 Aug 2019

HAL is a multi-disciplinary open access archive for the deposit and dissemination of scientific research documents, whether they are published or not. The documents may come from teaching and research institutions in France or abroad, or from public or private research centers.

L'archive ouverte pluridisciplinaire **HAL**, est destinée au dépôt et à la diffusion de documents scientifiques de niveau recherche, publiés ou non, émanant des établissements d'enseignement et de recherche français ou étrangers, des laboratoires publics ou privés.

FIBRED PSEUDO DOUBLE CATEGORIES FOR GAME SEMANTICS

CLOVIS EBERHART, TOM HIRSCHOWITZ

ABSTRACT. We unify previous constructions from our work on concurrent game semantics into a single categorical framework. From an operational description of positions and moves in some game, called a *signature*, we produce a pseudo double category, in which objects are positions and vertical morphisms are plays. The considered games are multi-player, so it makes sense to consider embeddings of positions: these are the horizontal morphisms. Finally, cells may be thought of as embeddings of plays preserving initial and final positions. In order to be suitable for game semantics, the obtained pseudo double category should enjoy a certain fibredness property. Under suitable hypotheses, we show that our construction actually produces such a *fibred* pseudo double category, from which we can define relevant categories of plays, and thus of strategies. We give a first necessary and sufficient criterion for this to hold and then a sufficient criterion that can be checked more easily.

Contents

1	Introduction	514
2	Preliminaries	518
3	Signatures for pseudo double categories	524
4	Fibredness	536
5	Conclusion	566
A	Miscellaneous properties of presheaf categories	569

1. Introduction

Game semantics has provided adequate models for a variety of (idealised) programming languages. Game models have arisen in several variants [19, 28, 1, 24, 25, 31, 5] which, despite their differences, all consider some notion of two-player game, from which they construct a category with games as objects and strategies as morphisms, and where composition of strategies is obtained through the standard pattern of ‘parallel composition plus hiding’.

In previous work [18, 9], we constructed models of process calculi, namely CCS [26] and the π -calculus [27], which have a lot in common with standard game models, but

Eberhart is supported by ERATO HASUO Metamathematics for Systems Design Project (No. JP-MJER1603), JST.

Received by the editors 2018-11-22 and, in final form, 2019-06-10.

Transmitted by Richard Garner. Published on 2019-06-14.

2010 Mathematics Subject Classification: 18C50, 03B70, 68Q55.

Key words and phrases: concurrent game semantics, pseudo double categories, factorisation systems.

© Clovis Eberhart, Tom Hirschowitz, 2019. Permission to copy for private use granted.

also a lot of differences. On the one hand, they feature a notion of game and programs are interpreted as strategies, but, on the other hand, the games are no longer two-player, and no attempt is made at constructing a category of games and strategies following the pattern of parallel composition plus hiding. More importantly, the very notions of positions and moves look completely different from the standard ones. Indeed, standardly, a game roughly consists of a collection of moves, and plays are sequences of moves (and there may not even be a notion of position). In our work, to start with, there is a rather elaborate notion of position, intuitively a hypergraph whose nodes model players and whose edges model communication channels. Moves are then introduced as higher-dimensional edges. Thus, plays are some kind of higher-dimensional hypergraphs. Part of the difficulty of our work was to organise plays over a given position X into a category $\mathbb{E}(X)$. A natural notion of strategy is then given by presheaves over this category: if σ is a presheaf over $\mathbb{E}(X)$ and u is a play over X , then $\sigma(u)$ represents all the ways σ has to accept u .

The complex nature of plays motivated the second author to axiomatise what is needed for them to yield sensible game models. This resulted in the notion of *playground* [18], which are pseudo double categories with lots of additional structure and properties.

However, in order to organise plays into categories $\mathbb{E}(X)$, without looking into, e.g., innocence, only a certain fibredness property is needed. This property holds in our first two models [18, 9], where it was proved by hand, in non-trivial, different ways. For our latest work in this area [8], we wanted to rely on a generic construction, hence the present paper¹.

Our main contribution is thus a generic construction of such *fibred* pseudo double categories (i.e., that satisfy the fibredness property) from more basic data. The kind of basic data we will use is the notion of *signature* defined in Section 3, where we construct a pseudo double category $\mathbb{D}(\mathbf{S})$ from any signature \mathbf{S} . In Section 4, we prove that, under suitable hypotheses on \mathbf{S} , $\mathbb{D}(\mathbf{S})$ is fibred. More precisely, we provide two results:

- Under a necessary and sufficient, but hard-to-verify condition, essentially saying that fibredness is satisfied for all “generators” (called *seeds*) in \mathbf{S} , we prove that $\mathbb{D}(\mathbf{S})$ is fibred (Theorem 4.3.14).
- We then exhibit sufficient, easier-to-verify conditions for the hard-to-verify condition above to hold (Theorem 4.4.20).

By plugging both results together, we obtain (Corollary 4.4.21) that any \mathbf{S} satisfying the given sufficient conditions yields a fibred $\mathbb{D}(\mathbf{S})$.

OVERVIEW. Let us briefly sketch how we create such graphical models and show that they are fibred. We start from a base category \mathbb{C} describing the operational semantics of a language. This base category comes with a notion of dimension. Objects of lower dimensions are called *players* and *channels* and describe *positions* of the game, which are basically graphs of players and channels. Players are the agents of the game and channels

¹This paper is based on the preprint [7], on which [8] actually relies.

are the means by which they can communicate. For example, in the π -calculus, a position simply represents the topology of communication between agents, as in:

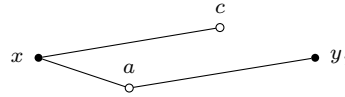

which represents a position with two players x and y who can communicate through the channel a , and x knows a private channel c . Objects of higher dimension describe the dynamics of the game. For example, in the π -calculus, a synchronisation where x sends c on a and y receives it is drawn as on the left below.

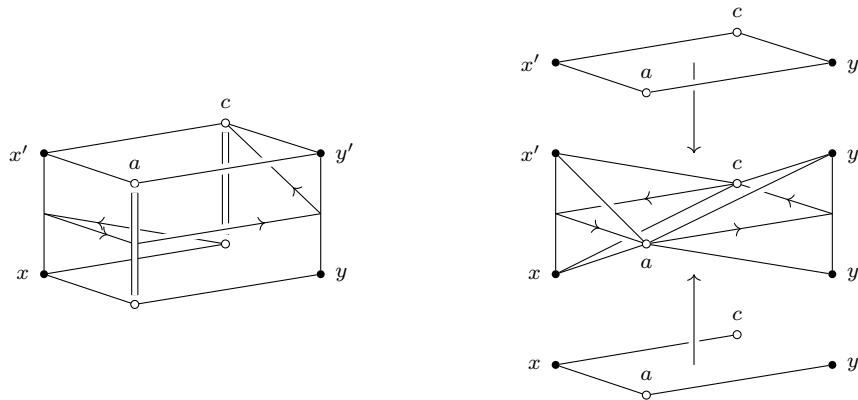

Here, the initial position of the synchronisation is drawn at the bottom, the final position at the top, and we can see that, in the final position, the avatar y' of y knows the channel c that x has sent them. For the π -calculus, synchronisation corresponds to an object of higher dimension in the category \mathbb{C} . Each object of higher dimension of \mathbb{C} is assigned such a graph, which we call a *move*. We further call the assignment of all these moves a *signature*. A *play* is a composite (pasting) of such moves. Formally, positions are presheaves over the first two dimensions of \mathbb{C} (the graphs represent the positions' *categories of elements*). Moves are cospans $Y \rightarrow M \leftarrow X$ of presheaves over \mathbb{C} , where X is the initial position, Y is the final position, and M represents the move. For example, the cospan corresponding to synchronisation in the π -calculus is drawn next to it, with X at the bottom, Y at the top, M in the middle, and the morphisms are inclusions.

From any signature S , we build a pseudo double category $\mathbb{D}(S)$, which, to simplify, is a gadget that has a set of *objects* (here, positions), and for all objects X and Y , a set of *horizontal morphisms* $X \rightarrow Y$ (here, inclusions of X into Y) and a set of *vertical morphisms* $Y \dashrightarrow X$ (here, plays starting from X and ending in Y). It also has, for all perimeters as below, a set of *cells* α (which here represents the fact that u embeds into u' in a certain sense).

$$\begin{array}{ccc}
 Y & \xrightarrow{k} & Y' \\
 \downarrow u & \xRightarrow{\alpha} & \downarrow u' \\
 X & \xrightarrow{h} & X'
 \end{array}$$

We then want to define a category $\mathbb{E}(X)$ of plays over a fixed position X whose morphisms $u \rightarrow u'$ would represent the fact that u' is an extension of u ($\mathbb{E}(X)$ depends on the signature S , but we leave the dependency implicit for readability). The natural definition of a morphism from $u: Y \twoheadrightarrow X$ to $u': Y' \twoheadrightarrow X$ is thus a tuple of an object Z , a vertical morphism $w: Z \rightarrow Y$, a horizontal morphism $h: Z \rightarrow Y'$, and a cell α as in:

$$\begin{array}{ccc}
 Z & \xrightarrow{h} & Y' \\
 \downarrow w & & \downarrow \\
 Y & \xrightarrow{\alpha} & \bullet u' \\
 \downarrow u & & \downarrow \\
 X & \xlongequal{\quad} & X.
 \end{array}$$

For this definition to yield a category, we need to be able to compose such morphisms, i.e., to canonically find a dashed part and a β to the solid part of:

$$\begin{array}{ccccc}
 Z'' & \dashrightarrow & Z' & \xrightarrow{h'} & Y'' \\
 \vdots & \xrightarrow{\beta} & \downarrow w' & & \downarrow \\
 Z & \xrightarrow{h} & Y' & & \downarrow \\
 \downarrow w & & \downarrow & \xrightarrow{\alpha'} & \bullet u'' \\
 Y & \xrightarrow{\alpha} & \bullet u' & & \downarrow \\
 \downarrow u & & \downarrow & & \downarrow \\
 X & \xlongequal{\quad} & X & \xlongequal{\quad} & X,
 \end{array}$$

so we need to be able to canonically restrict a play w' to a smaller position Z . This is the property we call *fibredness*: for all plays $u: Y \twoheadrightarrow X$ and morphisms $h: X' \rightarrow X$, there must exist a play $u': Y' \twoheadrightarrow X'$ and a cell α as below such that, for all commuting diagrams as the solid part of

$$\begin{array}{ccccc}
 Y'' & & & & \\
 \downarrow & \dashrightarrow k' & & & \\
 \bullet u'' & \dashrightarrow k'' & Y' & \xrightarrow{k} & Y \\
 \downarrow & \searrow \alpha'' & \downarrow & \searrow \alpha & \downarrow \\
 X'' & & \bullet u' & \xrightarrow{\alpha} & \bullet u \\
 \downarrow & \searrow h'' & \downarrow & \searrow h' & \downarrow \\
 & & X' & \xrightarrow{h} & X,
 \end{array}$$

there is a unique dashed arrow k'' and corresponding cell α'' (this basically means that u' is really a restriction of u along h and is necessary for composition in $\mathbb{E}(X)$ to be well defined).

To prove fibredness, we appeal to *factorisation systems* [12, 3]. This algebraic tool allows to factor all morphisms of a category as $r \circ l$, where l and r belong to fixed classes \mathcal{L} and \mathcal{R} that are *orthogonal*, which means that they have a certain lifting property. We build a factorisation system whose class \mathcal{L} is generated by the legs $X \rightarrow M$ for all cospans $Y \rightarrow M \leftarrow X$ in the signature (i.e., for all moves). This allows us to compute restrictions as follows.

Remember that a play $u: Y \dashrightarrow X$ is a cospan of presheaves $Y \rightarrow U \leftarrow X$, so we are actually faced with a situation like the solid part of the left-hand side diagram below, which we complete by factoring $l \circ h$ as $h' \circ l'$ (using the factorisation system) and then taking the pullback of f and h' .

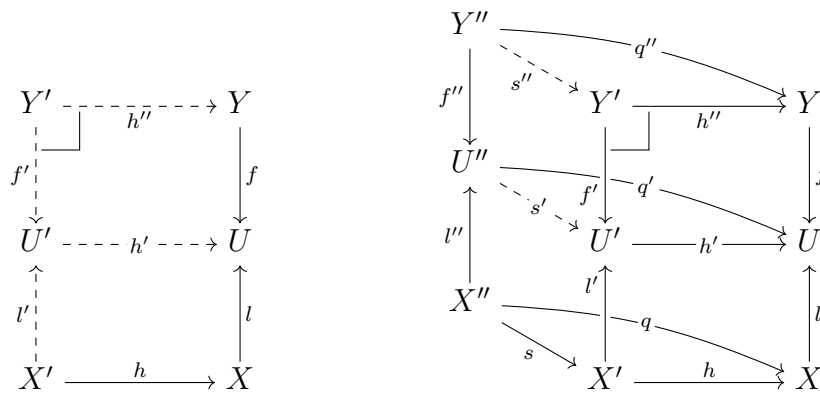

We then get the desired universal property by building s' and s'' in the right-hand side diagram: the former comes from the lifting property of our factorisation system (between l'' and h'), and the latter follows by universal property of pullback.

It then remains to show that $Y' \rightarrow U' \leftarrow X'$ is a play, which we prove by induction, under the hypothesis that it is the case for moves. We then give a sufficient criterion on \mathbb{C} for the restriction to be a play.

2. Preliminaries

In this section, we recall a few needed notions and constructions. In Section 2.1, we recall pseudo double categories, which will be at the heart of our construction. Factorisation systems are then recalled in Section 2.2. They will play a crucial role in showing that the pseudo double categories we produce are fibred. Finally, in Section 2.3, we introduce a variant of the π -calculus, tailored to our needs. Other useful, technical results from the literature about monos, pullbacks, and pushouts in \mathbf{Set} and presheaf categories are collected in Appendix A.

2.1. PSEUDO DOUBLE CATEGORIES. A *pseudo double category* [10, 11, 15, 16, 22, 13] \mathbb{D} consists of the following data.

- A set $\text{ob}(\mathbb{D})$ of *objects*.

- For each pair of objects X, X' in $\text{ob}(\mathbb{D})$, a set of *horizontal* morphisms $\mathbb{D}_h(X, X')$ and a set of *vertical* morphisms $\mathbb{D}_v(X, X')$. We distinguish both sets notationally by writing morphisms in \mathbb{D}_h with normal arrows and morphisms in \mathbb{D}_v with \rightarrow .
- For each square as below left, a set of *cells* $\mathbb{D}(h, h', u, u')$, pictured as on the right.

$$\begin{array}{ccc}
 X' & \xrightarrow{h} & Y' \\
 u \downarrow & & \downarrow u' \\
 X & \xrightarrow{h'} & Y
 \end{array}
 \qquad
 \begin{array}{ccc}
 X' & \xrightarrow{h} & Y' \\
 u \downarrow & \xRightarrow{\alpha} & \downarrow u' \\
 X & \xrightarrow{h'} & Y
 \end{array}$$

- Composition and identities for \mathbb{D}_h and \mathbb{D}_v .
- Horizontal composition and identities

$$\begin{array}{ccccc}
 A & \xrightarrow{h} & B & \xrightarrow{k} & E \\
 u \downarrow & \xRightarrow{\alpha} & \downarrow v & \xRightarrow{\beta} & \downarrow w \\
 C & \xrightarrow{h'} & D & \xrightarrow{k'} & F
 \end{array}
 \mapsto
 \begin{array}{ccc}
 A & \xrightarrow{k \circ h} & E \\
 u \downarrow & \xRightarrow{\beta \circ \alpha} & \downarrow w \\
 C & \xrightarrow{k' \circ h'} & F
 \end{array}
 \qquad
 \begin{array}{ccc}
 A & \xrightarrow{id_A} & A \\
 u \downarrow & \xRightarrow{id_u} & \downarrow u \\
 B & \xrightarrow{id_B} & B.
 \end{array}$$

- Vertical composition and identities

$$\begin{array}{ccccc}
 A & \xrightarrow{h} & B \\
 u \downarrow & \xRightarrow{\alpha} & \downarrow u' \\
 C & \xrightarrow{h'} & D \\
 v \downarrow & \xRightarrow{\beta} & \downarrow v' \\
 E & \xrightarrow{h''} & F
 \end{array}
 \mapsto
 \begin{array}{ccc}
 A & \xrightarrow{h} & B \\
 v \bullet u \downarrow & \xRightarrow{\beta \bullet \alpha} & \downarrow v' \bullet u' \\
 E & \xrightarrow{h''} & F
 \end{array}
 \qquad
 \begin{array}{ccc}
 A & \xrightarrow{h} & B \\
 id_A \downarrow & \xRightarrow{id_h} & \downarrow id_B \\
 A & \xrightarrow{h} & B.
 \end{array}$$

- For all vertical morphisms $A \xrightarrow{u} B \xrightarrow{v} C \xrightarrow{w} C$, cells

$$\begin{array}{ccc}
 A & & A \\
 w \bullet (v \bullet u) \downarrow & \left(\xRightarrow{\alpha_{u,v,w}} \right) & \downarrow (w \bullet v) \bullet u \\
 D & & B
 \end{array}
 \qquad
 \begin{array}{ccc}
 A & & A \\
 id_B \bullet u \downarrow & \left(\xRightarrow{\lambda_u} \right) & \downarrow u \\
 B & & B
 \end{array}
 \qquad
 \begin{array}{ccc}
 A & & A \\
 u \bullet id_A \downarrow & \left(\xRightarrow{\rho_u} \right) & \downarrow u \\
 B & & B
 \end{array}$$

(where trivial border means identity border).

These data are furthermore subject to the following conditions:

- Horizontal composition of morphisms and cells is associative and unital, i.e., vertical morphisms and cells form a category.

- Vertical composition of morphisms and cells is associative and unital up to the natural and coherent isomorphisms $\alpha_{u,v,w}$, λ_u , and ρ_u . Coherence is here a generalisation of coherence for monoidal categories, see Garner [13] for the full definition. In particular, \mathbb{D}_v forms a bicategory.
- The *interchange law* holds, in the sense that both ways of parsing the following diagram coincide:

$$\begin{array}{ccccc}
 X & \xrightarrow{l} & X' & \xrightarrow{l'} & X'' \\
 u \downarrow & \xrightarrow{\alpha} & \downarrow u' & \xrightarrow{\alpha'} & \downarrow u'' \\
 Y & \xrightarrow{k} & Y' & \xrightarrow{k'} & Y'' \\
 v \downarrow & \xrightarrow{\beta} & \downarrow v' & \xrightarrow{\beta'} & \downarrow v'' \\
 Z & \xrightarrow{h} & Z' & \xrightarrow{h'} & Z'' ,
 \end{array}$$

i.e., $(\beta' \circ \beta) \bullet (\alpha' \circ \alpha) = (\beta' \bullet \alpha') \circ (\beta \bullet \alpha)$.

2.1.1. NOTATION. We denote the vertical, resp. horizontal, domain and codomain maps by $\text{dom}_v(\alpha)$, $\text{cod}_v(\alpha)$, $\text{dom}_h(\alpha)$, and $\text{cod}_h(\alpha)$. E.g., in the first given cell α above, we have $u = \text{dom}_h(\alpha)$, $u' = \text{cod}_h(\alpha)$, $h = \text{dom}_v(\alpha)$, and $h' = \text{cod}_v(\alpha)$.

We denote by \mathbb{D}_H the category with vertical morphisms as objects and cells as morphisms, and by \mathbb{D}_V the bicategory with horizontal morphisms as objects and cells as morphisms. Domain and codomain maps extend to functors $\text{dom}_v, \text{cod}_v: \mathbb{D}_H \rightarrow \mathbb{D}_h$ and $\text{dom}_h, \text{cod}_h: \mathbb{D}_V \rightarrow \mathbb{D}_v$. We will refer to dom_v and cod_v simply as dom and cod , reserving subscripts for dom_h and cod_h .

The game semantical intuition of a double category is as follows. Objects are thought of as positions in a certain, potentially multiparty game, and horizontal morphisms as embeddings of positions. This means positions may be parts of global positions in the game, e.g., the immediate neighbourhood of a particular player. Vertical morphisms $X \twoheadrightarrow Y$, then, are thought of as plays with initial position Y and final position X (the direction is chosen to make fibredness look like taking pullbacks).

Some of our constructions will be based on the following example:

2.1.2. EXAMPLE. Starting from any category \mathcal{C} with pushouts, consider the pseudo double category $\text{Cospan}(\mathcal{C})$ with

- \mathcal{C} itself as horizontal category, i.e., $\text{Cospan}(\mathcal{C})_h = \mathcal{C}$,
- as vertical morphisms $X \twoheadrightarrow Y$ all cospans $X \rightarrow U \leftarrow Y$, and
- as cells all commuting diagrams

$$\begin{array}{ccc}
 X & \xrightarrow{k} & X' \\
 \downarrow & & \downarrow \\
 U & \xrightarrow{l} & U' \\
 \uparrow & & \uparrow \\
 Y & \xrightarrow{h} & Y' ,
 \end{array} \tag{1}$$

with $\text{dom}(k, l, h) = k$, $\text{dom}_h(k, l, h) = (X \rightarrow U \leftarrow Y)$, etc.

Composition in $\text{Cospan}(\mathcal{C})_v$ is defined by (some global choice of) pushout and composition in $\text{Cospan}(\mathcal{C})_V$ follows by universal property of pushout.

2.2. FACTORISATION SYSTEMS. Factorisation systems [12, 3] are a tool we will use to prove that the pseudo double categories we produce are fibred.

In any category \mathcal{C} , we say that $l: A \rightarrow C$ is *left orthogonal* to $r: B \rightarrow D$, or equivalently that r is *right orthogonal* to l , if and only if for all commuting squares as the solid part of

$$\begin{array}{ccc} A & \xrightarrow{u} & B \\ l \downarrow & \nearrow d & \downarrow r \\ C & \xrightarrow{v} & D, \end{array}$$

there exists a unique d as shown making both triangles commute.

2.2.1. NOTATION. We denote by $l \perp r$ the existence of a unique such d for all u and v , and extend the notation to sets of arrows by writing $\mathcal{L} \perp \mathcal{R}$ when $l \perp r$ for all $l \in \mathcal{L}$ and $r \in \mathcal{R}$. Similarly, \mathcal{L}^\perp denotes the class of all arrows that are right orthogonal to all arrows of \mathcal{L} , and symmetrically for ${}^\perp\mathcal{R}$.

2.2.2. DEFINITION. A factorisation system on a category \mathcal{C} consists of two classes of maps \mathcal{L} and \mathcal{R} such that $\mathcal{L} = {}^\perp\mathcal{R}$, $\mathcal{L}^\perp = \mathcal{R}$, and any morphism $f: C \rightarrow D$ factors as $C \xrightarrow{l_f} A_f \xrightarrow{r_f} D$ with $l_f \in \mathcal{L}$ and $r_f \in \mathcal{R}$.

2.2.3. NOTATION. In accordance with standard notation for epi-mono factorisation (see next example), arrows in \mathcal{L} are denoted with the special arrow tip \twoheadrightarrow , while arrows in \mathcal{R} are denoted with $\triangleright\rightarrow$.

2.2.4. EXAMPLE. The first example of a factorisation system is given by the classes Epi and Mono, respectively of surjections and injections, in **Set**. Indeed, it is well-known that all functions factor through their images as a surjection followed by an injection. Perhaps less well-known is that Epi and Mono are orthogonal. Indeed, take a commuting square

$$\begin{array}{ccc} X & \xrightarrow{u} & X' \\ l \downarrow & & \downarrow r \\ Y & \xrightarrow{v} & Y' \end{array}$$

with $l \in \text{Epi}$ and $r \in \text{Mono}$. Then the definition $d(l(x)) = u(x)$ indeed defines a function: any y in Y has an image through d because l is surjective, and the definition does not depend on the chosen x because, if $l(x_1) = l(x_2)$, then $r(d(l(x_1))) = r(u(x_1)) = v(l(x_1)) = v(l(x_2)) = r(u(x_2)) = r(d(l(x_2)))$, and r is injective. This is the only choice of function from Y to X' that makes both triangles commute because r is mono.

This extends to presheaf categories: for any small category \mathbb{C} , epi and monic natural transformations form a factorisation system on $\widehat{\mathbb{C}}$, which we also denote by $(\text{Epi}, \text{Mono})$.

The classes $(\text{Mono}, \text{Epi})$ do not form a factorisation system. For example,

$$\begin{array}{ccc} 0 & \longrightarrow & 2 \\ \downarrow & & \downarrow \\ 1 & \longrightarrow & 1 \end{array}$$

possesses two distinct diagonal fillers. (They in fact form a *weak factorisation system*, which means that the diagonal filler always exists, but may not be unique.)

The factorisation systems that we will be interested in will be *cofibrantly generated*. *Cofibrant generation* refers to the fact that \mathcal{L} and \mathcal{R} are defined from some generating set J , merely by the lifting property: $\mathcal{R} = J^\perp$ and $\mathcal{L} = {}^\perp\mathcal{R}$. In fact, in many useful cases, it is even a rather small set. In our case, it will be bounded by the cardinality of \mathbb{C} . Though it is not trivial – this uses the famous “small object” argument, we have:

2.2.5. THEOREM. [Bousfield [3]] *For any set J of maps in any locally presentable category \mathbb{C} , $({}^\perp(J^\perp), J^\perp)$ forms a factorisation system. We say this factorisation system is cofibrantly generated by J .*

2.2.6. EXAMPLE. The $(\text{Epi}, \text{Mono})$ factorisation system on Set is cofibrantly generated by the singleton $\{2 \rightarrow 1\}$. For any \mathbb{C} , the $(\text{Epi}, \text{Mono})$ factorisation system on $\widehat{\mathbb{C}}$ is cofibrantly generated by the set of all maps $\nabla_{y_c} : 2 \cdot y_c \rightarrow y_c$, for $c \in \text{ob}(\mathbb{C})$.

A crucial property of factorisation systems is the following:

2.2.7. LEMMA. *For any factorisation system $(\mathcal{L}, \mathcal{R})$, \mathcal{L} contains all isomorphisms and is stable under right cancellation, composition and pushout.*

Stability under right cancellation means that if some composite $h \circ g$ is in \mathcal{L} for $g \in \mathcal{L}$, then so is h .

Stability under pushout means that given any pushout square

$$\begin{array}{ccc} A & \xrightarrow{f} & B \\ \downarrow l & & \downarrow l' \\ C & \xrightarrow{g} & D, \end{array}$$

if $l \in \mathcal{L}$, then also $l' \in \mathcal{L}$.

Dually, \mathcal{R} contains all isomorphisms and is stable under left cancellation, composition and pullback (in the obvious dual sense to stability under right cancellation and pushout).

So in particular both classes determine identity-on-objects subcategories of \mathcal{C} .

2.3. THE π -CALCULUS. In this section, we introduce a variant of the π -calculus, that we will use as a running example. It is slightly unusual in the sense that:

- its terms are possibly infinite, which spares us the need to define constructors for replication or to put recursion in our language,
- the reduction of terms is done in terms of a *chemical abstract machine*, in the style of Berry and Boudol [2].

2.3.1. DEFINITION. Processes of the π -calculus are terms coinductively generated by the grammar

$$\frac{\gamma \vdash_{\mathbf{g}} P_1 \quad \dots \quad \gamma \vdash_{\mathbf{g}} P_n}{\gamma \vdash \sum_{i \in n} P_i} \quad \frac{\gamma \vdash P \quad \gamma \vdash Q}{\gamma \vdash P \mid Q}$$

$$\frac{\gamma, a \vdash P}{\gamma \vdash_{\mathbf{g}} \nu a.P} \quad \frac{\gamma \vdash P}{\gamma \vdash_{\mathbf{g}} \tau.P} \quad \frac{a \in \gamma \quad \gamma, b \vdash P}{\gamma \vdash_{\mathbf{g}} a(b).P} \quad \frac{a, b \in \gamma \quad \gamma \vdash P}{\gamma \vdash_{\mathbf{g}} \bar{a}(b).P},$$

where

- we have two judgements, \vdash for processes and $\vdash_{\mathbf{g}}$ for guarded processes;
- γ ranges over finite sets of natural numbers, and
- γ, a is defined if and only if $a \notin \gamma$ and then denotes $\gamma \uplus \{a\}$.

To define the reduction of our π -calculus, we first need to define the *configurations* of the chemical abstract machine:

2.3.2. DEFINITION. A configuration is a pair of a finite set of natural numbers γ and a finite multiset of processes $\gamma \vdash P_i$. We write such a configuration $\langle \gamma \parallel P_1, \dots, P_n \rangle$.

The notation below is a formal definition to make sense of the intuitive notation $P + Q$ when P is a guarded process and Q is a sum, and which does exactly what one would expect:

2.3.3. NOTATION. For any $\gamma \vdash_{\mathbf{g}} P$, $\gamma \vdash Q$ of the form $\sum_{i \in n} Q_i$, and injection $h: n \hookrightarrow n+1$, we denote by $P +_h Q$ the sum $\sum_{j \in n+1} P_j$, where $P_{h(i)} = Q_i$ for all $i \in n$ and $P_k = P$, for k the unique element of $(n+1) \setminus \text{Im}(h)$.

We finally define the reduction of configurations:

$$\overline{\langle \gamma \parallel a(b).P +_h R, \bar{a}(c).Q +_{h'} R' \rangle} \rightarrow \overline{\langle \gamma \parallel P[b \mapsto c], Q \rangle} \quad \overline{\langle \gamma \parallel P \mid Q \rangle} \rightarrow \overline{\langle \gamma \parallel P, Q \rangle}$$

$$\overline{\langle \gamma \parallel \tau.P +_h R \rangle} \rightarrow \overline{\langle \gamma \parallel P \rangle} \quad \overline{\langle \gamma \parallel \nu a.P +_h R \rangle} \rightarrow \overline{\langle \gamma, a \parallel P \rangle}$$

$$\frac{\langle \gamma_1 \parallel S_1 \rangle \rightarrow \langle \gamma_2 \parallel S_2 \rangle}{\langle \gamma_1 \parallel S \cup S_1 \rangle \rightarrow \langle \gamma_2 \parallel S \cup S_2 \rangle}$$

3. Signatures for pseudo double categories

In this section, we define the notion of signature and illustrate it with the example of the π -calculus. We start by generalising the method used in the previous sheaf models to define the notion of signature. We then abstractly give the construction of the pseudo double category $\mathbb{D}(\mathbf{S})$ associated to any signature \mathbf{S} . Finally, we define the relevant categories of plays from $\mathbb{D}(\mathbf{S})$, and introduce fibredness in passing, as a natural condition for composition to be well-defined in such categories.

Any signature \mathbf{S} will comprise a base category \mathbb{C} , and $\mathbb{D}(\mathbf{S})$ will be a sub-pseudo double category of $\mathbf{Cospan}(\widehat{\mathbb{C}})$ (as defined in Example 2.1.2). Very roughly, \mathbb{C} will be equipped with a notion of dimension, and \mathbf{S} will consist of a selection of cospans

$$Y \xrightarrow{s} M \xleftarrow{t} X \quad (2)$$

in $\widehat{\mathbb{C}}$ viewed as morphisms $Y \dashrightarrow X$ in $\mathbf{Cospan}(\widehat{\mathbb{C}})_v$, where X and Y have dimension at most 1 and M may have arbitrary dimension. We will call these cospans *seeds*. The intuition is that presheaves of dimension ≤ 1 model *positions* in a game (they are essentially graphs), while higher-dimensional presheaves model the dynamics of the game. Thus each cospan (2) models a *play*, starting in position X and ending in position Y , and M models *how* the play evolves from X to Y . Up to some technicalities, $\mathbb{D}(\mathbf{S})$ is the smallest sub-pseudo double category of $\mathbf{Cospan}(\widehat{\mathbb{C}})$ whose objects are positions and whose vertical morphisms contain seeds.

3.1. A SIGNATURE FOR THE π -CALCULUS. In this section, we define a signature \mathbf{S}_π for the π -calculus to explain and motivate the abstract notion of signature we will use in the rest of the paper.

Our method may be decomposed into two steps. In the first step, we first design a base category \mathbb{C} over which finitely presentable presheaves will model plays. This base category \mathbb{C} comes with a notion of dimension:

- objects of dimensions 0 and 1 are used to model positions in the game, they represent channels and players respectively, where channels are the communication channels players use to interact,
- objects of dimension ≥ 2 represent typical moves in the game.

We also pick a family of cospans in $\widehat{\mathbb{C}}$ that model typical moves: $Y \rightarrow M \leftarrow X$ will represent a move M whose initial position is X and whose final position is Y . We call such cospans the *seeds* of our game. The cospans we pick should satisfy some form of compatibility if we want our model to be fibred, so we actually pick a functor $\mathbf{S}: \mathbb{C}_{|\geq 2} \rightarrow \mathbf{Cospan}(\widehat{\mathbb{C}})_H$, where $\mathbb{C}_{|\geq 2}$ is the full subcategory of \mathbb{C} spanning the objects of dimension ≥ 2 . In the second step (see Section 3.3 for details), we construct the smallest sub-pseudo double category of $\mathbf{Cospan}(\widehat{\mathbb{C}})$

- whose objects are positions,

- whose vertical morphisms include all identities and seeds, and
- which contains all pushouts of the form

$$\begin{array}{ccc}
 id_Z^\bullet & \xrightarrow{id_h^\bullet} & id_{Z'}^\bullet \\
 \downarrow & & \downarrow \\
 S(\mu) & \xrightarrow{\quad} & M,
 \end{array}$$

for all moves μ in $\mathbb{C}_{\geq 2}$ and morphisms $h: Z \rightarrow Z'$ between positions.

The last point intuitively says that moves (modelled by seeds) may occur in context.

We will here produce our example signature S_π . The signature we get is exactly the one we used for our previous model of the π -calculus [9]. By then applying the second step to S_π , we get exactly the pseudo double category that our model of the π -calculus is built on. The model of CCS defined in [18] and the variant of HON games obtained in [8] are obtained by defining signatures for CCS and HON games and applying the same machinery.

Let us describe the game based on the operational description of our π -calculus given in Section 2.3. A *position* will be a finite hypergraph (i.e., a graph in which edges do not link two vertices but an arbitrary number of them). In a position, we call nodes *players* and edges *channels*. A player who is linked to n channels is a placeholder for a process $\gamma \vdash P$ with n free communication channels, i.e., where $|\gamma| = n$. A channel that is linked to n players is thought of as a communication channel that is shared by n processes. Our game is intrinsically multi-party in the sense that there are several players in a play.

3.1.1. EXAMPLE. The position below is a position with three players x, y_1 , and y_2 , and two channels c_1 and c_2 . The first channel c_1 is shared between all three players, while the second channel c_2 is private to x .

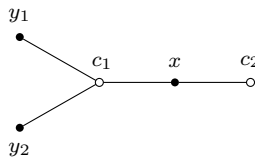

Formally, positions are presheaves over the following category:

3.1.2. DEFINITION. Let \mathbb{C}_1 have

- an object $*$,
- an object $[n]$ for each n in \mathbb{N} ,
- morphisms $s_1, \dots, s_n: * \rightarrow [n]$ for each n in \mathbb{N} .

The $*$ object represents channels, while $[n]$ objects represent n -ary players.

3.1.3. EXAMPLE. The informal position of Example 3.1.1 is modelled as the presheaf X with

$$X(*) = \{c_1, c_2\}, \quad X([1]) = \{y_1, y_2\}, \quad X([2]) = \{x\}, \quad X([n]) = \emptyset \text{ otherwise,}$$

and whose action on non-trivial morphisms is:

$$y_1 \cdot s_1 = c_1, \quad y_2 \cdot s_1 = c_1, \quad x \cdot s_1 = c_1, \quad \text{and } x \cdot s_2 = c_2.$$

The graphical representation we have given in Example 3.1.1 is a representation of the category of elements of X (the only information lost with that representation is the order of channels, i.e., whether $x \cdot s_1$ is c_1 or c_2).

Let us now describe moves in the game. They are typically given by the operational description of the language, which, in the case of the π -calculus, are the rules given in Section 2.3. Each rule in our calculus will correspond to a move in our game.

The move for parallel composition goes as follows: a player x may *fork* to turn into two new players who know the same channels as x . Graphically, if the player who plays the move is binary (i.e., they know two channels), this is pictured as:

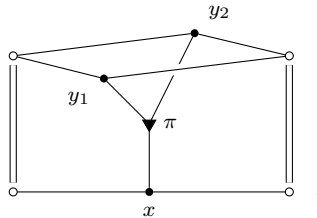

where the starting position is pictured at the bottom (it has one player x who knows two channels) and the final one at the top (it has two players y_1 and y_2 who know exactly the same channels as x). There is also something in the middle denoted by π that represents the action of forking itself, but we do not delve into details here, as we only give an informal presentation. This move is in accordance with the intuition that it should model the operational description of the rule for parallel composition: according to this rule, a process $\gamma \vdash P \mid Q$ turns into a pair of processes $\gamma \vdash P$ and $\gamma \vdash Q$ that know exactly the same channels (i.e., among the channels in γ).

Following the same intuition, we easily define moves for the silent τ action and channel creation. In the first case, a process $\gamma \vdash \tau.P +_h R$ turns into a process $\gamma \vdash P$, i.e., a process that knows exactly the same channels. In the second case, a process $\gamma \vdash \nu a.P +_h R$ turns into a process $\gamma, a \vdash P$, i.e., a process that knows exactly the same channels, plus a new, fresh channel a . They are depicted as below left and below right respectively, again in the case where the initial player is binary.

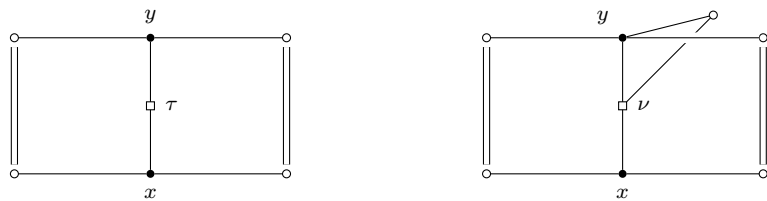

Finally, the synchronisation rule is slightly more complex, and the move reflects the intuition of message passing: when two processes $\gamma \vdash a(b).P +_h R$ and $\gamma \vdash \bar{a}(c).Q +_h R'$ synchronise and turn into $\gamma \vdash P[b \mapsto c]$ and $\gamma \vdash Q$, Q sends its channel c on a and P receives it and treats it as a fresh channel. Therefore, if $a(b).P$ knows n channels among the channels of γ , $P[b \mapsto c]$ knows $n + 1$ of these channels (there may be repetitions, e.g., if $a(b).P$ already knows c , then $P[b \mapsto c]$ knows c “twice”). Moreover, note that, for both processes to communicate, they need to share a common channel a . If we represent this move graphically, for a player x who knows two channels a and c and who sends c on a , and a player y who knows only one channel a , we obtain:

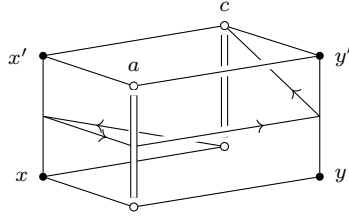

where the initial position is indeed again at the bottom, and in the final position, the two players have turned into x' and y' , and y' knows c . Just like in the other moves, there is something in the middle that represents the action of synchronising itself: the arrow that goes from c in the bottom position to c in the top position. Again, we do not dwell on details here, but intuitively, this arrow represents the path c 's name follows during the synchronisation: x first fetches it, then sends it on a , the message is received by y , who thus gains the knowledge of a new channel.

The congruence rule is not turned into a move in our game, as it is typically given by the fact that moves only have a local effect (i.e., when a player moves, the rest of the position is left untouched).

Following this description, we augment our base category \mathbb{C}_1 with new objects and morphisms that model moves.

3.1.4. DEFINITION. Let \mathbb{C} consist of \mathbb{C}_1 , plus, for all n, m in \mathbb{N} , a, b in n , and c, d in m :

- objects $\pi_n^l, \pi_n^r, \pi_n, \nu_n, \tau_n, \iota_{n,a}, o_{n,a,b}$, and $\sigma_{n,a,m,c,d}$,
- for all v in $\{\pi_n^l, \pi_n^r, \tau_n, o_{n,a,b}\}$, morphisms $s, t : [n] \rightarrow v$,
- morphisms $[n+1] \xrightarrow{s} \nu_n \xleftarrow{t} [n]$ and $[n+1] \xrightarrow{s} \iota_{n,a} \xleftarrow{t} [n]$,
- morphisms $\pi_n^l \xrightarrow{l} \pi_n \xleftarrow{r} \pi_n^r$ and $\iota_{n,a} \xrightarrow{\rho} \sigma_{n,a,m,c,d} \xleftarrow{\varepsilon} o_{m,c,d}$,

modulo the equations:

- $s \circ s_i = t \circ s_i$ in $\mathbb{C}(*, v)$, for all v in $\{\pi_n^l, \pi_n^r, \tau_n, \iota_{n,a}, o_{n,a,b}, \nu_n\}$ and i in n , with n in \mathbb{N} and a, b in n ,

- $l \circ t = r \circ t$ in $\mathbb{C}([n], \pi_n)$, for all n in \mathbb{N} ,
- $\rho \circ t \circ s_a = \varepsilon \circ t \circ s_c$ and $\rho \circ s \circ s_{n+1} = \varepsilon \circ s \circ s_d$, in $\mathbb{C}(*, \sigma_{n,a,m,c,d})$, for all n, m in \mathbb{N} , a in n , and c, d in m .

The reader may check that drawing the categories of elements of representable pre-sheaves on $\pi_n, \nu_n, \tau_n, \sigma_{n,a,m,c,d}$ look exactly like the intended graphs. We have not yet mentioned the other objects $\pi_n^l, \pi_n^r, \iota_{n,a}$, and $o_{n,a,b}$. The first two are technical artefacts related to the notion of *view* in innocent game semantics. They provide examples of non-trivial morphisms between plays (to π_n). The latter two are the restrictions of synchronisation to each one of the two players.

The pseudo double category describing the π -calculus will be a sub-pseudo double category of $\mathbf{Cospan}(\widehat{\mathbb{C}})$, entirely determined by the choice of a functor from $\mathbb{C}_{|\geq 2}$ to $\mathbf{Cospan}(\widehat{\mathbb{C}})_H$, where $\mathbb{C}_{|\geq 2}$ denotes the full subcategory of \mathbb{C} spanning the objects not in \mathbb{C}_1 . Intuitively, this functor chooses for all objects μ of $\mathbb{C}_{|\geq 2}$ a cospan which will be thought of as the basic play consisting of just μ . This choice of cospans should of course reflect the intuition given above, specifically, if we choose to model the move μ by a cospan $Y \xrightarrow{s} M \xleftarrow{t} X$, then X should represent μ 's initial position, Y its final position, and M should “represent” μ in some way. We thus pick the cospans as follows:

- for all v in $\{\pi_n^l, \pi_n^r, \tau_n, o_{n,a,b}\}$: $[n] \xrightarrow{s} v \xleftarrow{t} [n]$ (where v should really be y_v , but we keep the Yoneda embedding implicit for readability),
- for π_n : $[n] \mid [n] \xrightarrow{s'} \pi_n \xleftarrow{t=rt} [n]$, where $[n] \mid [n]$ is the following pushout, and s' is obtained by its universal property:

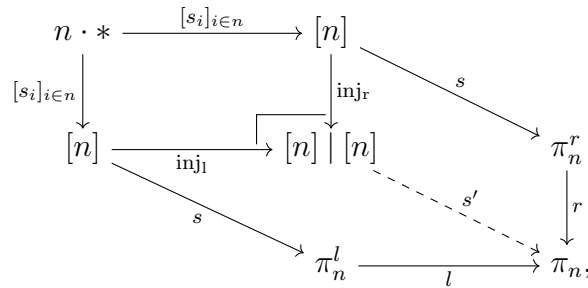

- for all v in $\{\nu_n, \iota_{n,a}\}$: $[n + 1] \xrightarrow{s} v \xleftarrow{t} [n]$,
- for $\sigma_{n,a,m,c,d}$: $[n + 1]_{a,n+1} \mid_{c,d} [m] \xrightarrow{s'} \sigma_{n,a,m,c,d} \xleftarrow{t'} [n]_a \mid_c [m]$, where $[n]_a \mid_c [m]$ is the following pushout and t' is obtained by its universal property:

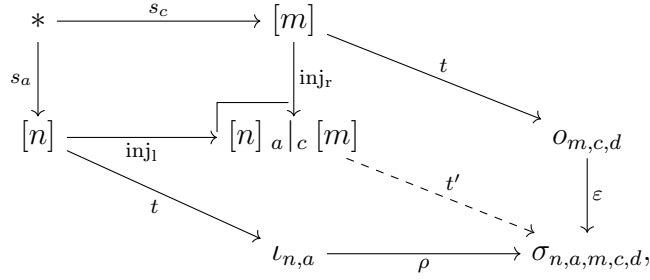

and similarly for $[n + 1]_{a,n+1} |_{c,d}$ and s' :

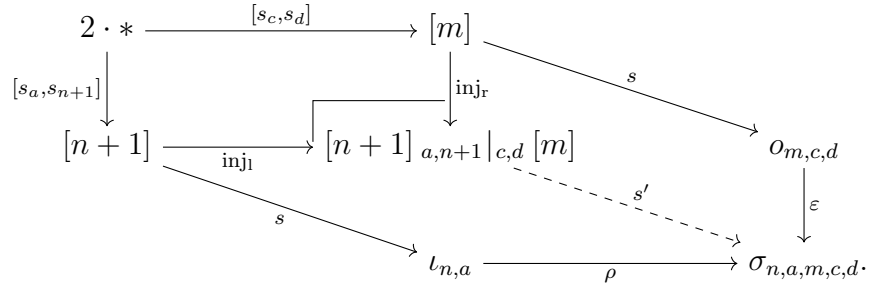

3.1.5. REMARK. The intuition behind these definitions actually comes from starting with spans to represent the moves (as is usually done in graph rewriting) and augmenting \mathbb{C}_1 by appealing to cocomma categories, as sketched in [6]. However, starting from spans makes the whole presentation unnecessarily more intricate (as the approach has to be refined for fibredness to hold), so we only gave the result here.

We finally need to define the functor on morphisms of $\mathbb{C}_{\geq 2}$, which is simple, since there are few non-trivial morphisms. In fact, all non-trivial morphisms are of one of the following forms: $l: \pi_n^l \rightarrow \pi_n$, $r: \pi_n^r \rightarrow \pi_n$, $\varepsilon: l_{n,a} \rightarrow \sigma_{n,a,m,c,d}$, or $\rho: O_{m,c,d} \rightarrow \sigma_{n,a,m,c,d}$. We summarise our choice of morphisms in the picture below:

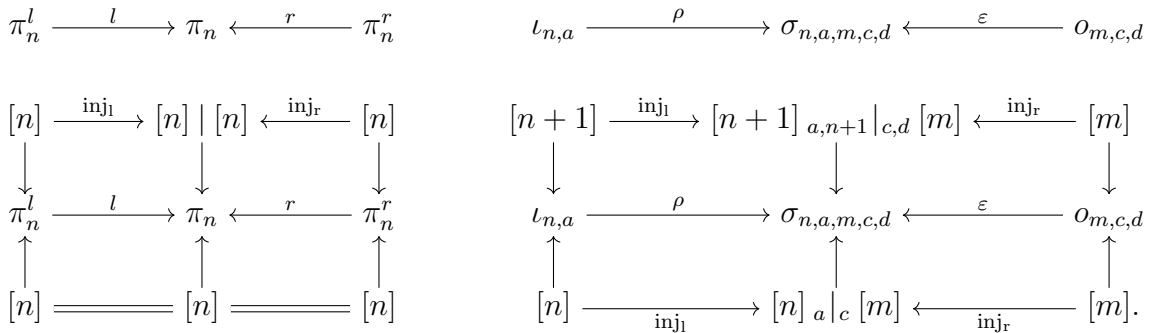

3.1.6. DEFINITION. Let $S_\pi: \mathbb{C}_{\geq 2} \rightarrow \text{Cospan}(\widehat{\mathbb{C}})_H$ denote the obtained functor. We call seeds *cospans in the image of this functor*.

We now need to construct our pseudo double category based on this. Before proceeding, as we intend to provide a generic construction, we reflect a bit on the properties of our functor S_π , which leads us to the notion of signature.

3.2. SIGNATURES. We now discuss a few elementary properties of the functor $S_\pi: \mathbb{C}_{|\geq 2} \rightarrow \mathbf{Cospan}(\widehat{\mathbb{C}})_H$ of Definition 3.1.6. We then abstract over these properties to define our notion of signature.

Our first observation is that the category \mathbb{C} enjoys a natural notion of dimension: $*$ has dimension 0, each $[n]$ has dimension 1, all $\tau_n, \nu_n, \pi_n^l, \pi_n^r, \iota_{n,a}$, and $o_{m,c,d}$ have dimension 2, and all π_n and $\sigma_{n,a,m,c,d}$ have dimension 3. In particular, \mathbb{C} forms a *direct* category in the sense of Garner [14], i.e., it comes equipped with a functor to the ordinal ω viewed as a category, which reflects identities. Presheaves X themselves inherit a dimension: the least n such that X is empty above dimension n . The dimension of any representable is thus that of the underlying object.

Let us make a few additional observations on our functor $S_\pi: \mathbb{C}_{|\geq 2} \rightarrow \mathbf{Cospan}(\widehat{\mathbb{C}})_H$:

- (a) the middle object of each $S_\pi(\mu)$ is y_μ ;
- (b) both legs of all selected cospans are monic;
- (c) all morphisms between those cospans have monic components;
- (d) for all such morphisms, top squares are pullbacks;
- (e) finally, all initial positions X are *tight*, in the sense that all channels $c \in X(*)$ are in the image of some $X(s_i)$.

So a first, naive notion of signature could consist of a direct category \mathbb{C} , equipped with a functor $\mathbb{C}_{|\geq 2} \rightarrow \mathbf{Cospan}(\widehat{\mathbb{C}})_H$ satisfying (a)–(e). However, some of the examples we have in mind require a bit more generality, so in our abstract definition we relax things a bit. We also need to add another, less obvious hypothesis for the proof of fibredness to hold. Let us explain in more details the changes that need to be made to this naive definition.

Even though, in many examples, morphisms between seeds have bottom squares that are pullbacks, we can see that the π -calculus does not. Indeed, consider the morphism $\rho: \iota_{n,a} \rightarrow \sigma_{n,a,m,c,d}$, the sent channel is present both in $\iota_{n,a}$ and the initial position of $\sigma_{n,a,m,c,d}$, but not in the initial position of $\iota_{n,a}$. However, we want to have a property close to that bottom square being a pullback for the proof of fibredness to hold. There are also relevant, though unpublished examples of base categories in which the top square of a morphism between seeds is not necessarily a pullback. Furthermore, we need the generated pseudo double category to accommodate morphisms of cospans whose components are non-injective. Let us thus change our tentative definition just enough to accommodate these needs. In short, we pass from injective maps to maps which are injective except perhaps on objects of dimension 0, and find an analogous generalisation for bottom squares being pullbacks. We also completely drop the requirement on top squares, as it proves useless in the definition.

Let us fix any small, direct category \mathbb{C} for the rest of this section. By analogy with the base category for π , we think of objects of dimension 1 as players in a game, which may communicate with each other through objects of dimension 0. Objects of dimensions > 1 are thought of as moves in the game. Accordingly, we use the following terminology:

3.2.1. **TERMINOLOGY.** *The dimension of any object of \mathbb{C} is its image in ω . A channel is an object of dimension 0, a player is an object of dimension 1, and a move is an object of dimension > 1 .*

3.2.2. **DEFINITION.** *Let a natural transformation of presheaves over \mathbb{C} be 1D-injective when all its components of dimensions > 0 are injective.*

A square in $\widehat{\mathbb{C}}$ is a 1D-pullback when it is a pullback in all dimensions > 0 .

3.2.3. **NOTATION.** We mark 1D-pullbacks with a dotted little square, as below.

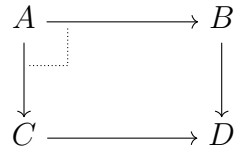

3.2.4. **DEFINITION.** *Let $\mathbb{D}^0(\mathbb{C})$ denote the sub-pseudo double category of $\text{Cospan}(\widehat{\mathbb{C}})$*

- *whose horizontal category $\mathbb{D}^0(\mathbb{C})_h$ is the subcategory of $\widehat{\mathbb{C}}$ consisting of positions, i.e., finitely presentable presheaves of dimension ≤ 1 , and 1D-injective morphisms between them,*
- *whose vertical morphisms are cospans with monic legs, and*
- *whose cells are those of $\text{Cospan}(\widehat{\mathbb{C}})$ with 1D-injective components and 1D-pullback bottom squares.*

3.2.5. **TERMINOLOGY.** *For any vertical $u: Y \twoheadrightarrow X$ in $\mathbb{D}^0(\mathbb{C})_v$, X and Y are respectively called the initial and final positions of u .*

Definition 3.2.4 only makes sense because:

3.2.6. **PROPOSITION.** $\mathbb{D}^0(\mathbb{C})$ *forms a sub-pseudo double category of $\text{Cospan}(\widehat{\mathbb{C}})$.*

This relies on the following direct corollary of Lemma A.2.1:

3.2.7. **COROLLARY.** *In $\widehat{\mathbb{C}}$, for any commuting cube*

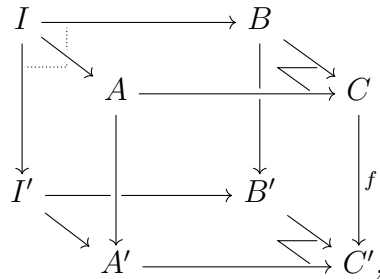

with the marked pushouts and 1D-pullback,

- *if $I' \rightarrow B'$ is 1D-injective then the front square is a 1D-pullback, and*
- *if all arrows except perhaps f are 1D-injective, then f also is.*

PROOF. By pointwise application of Lemma A.2.1. ■

PROOF OF PROPOSITION 3.2.6. The only non-trivial bit lies in showing that a vertical composite of componentwise 1D-injective cells with 1D-pullback bottom squares again has 1D-injective components and 1D-pullback bottom square. This is a simple consequence of Corollary 3.2.7 and the pullback lemma. ■

Let us finally give an abstract definition of tightness as given in (e) for π – though the presentation differs.

3.2.8. DEFINITION. For all presheaves U in $\widehat{\mathbb{C}}$, let us denote by $\text{pl}(U)$ the set of players of U , i.e., pairs (d, x) for all morphisms $x: d \rightarrow U$, where d is any representable of dimension

1. Let $\text{Pl}(U)$ denote the corresponding coproduct $\sum_{(d,x) \in \text{pl}(U)} d$ of representables.

A position X is tight if and only if the canonical morphism $\text{Pl}(X) \rightarrow X$ is epi.

3.2.9. DEFINITION. A signature consists of a small, direct category \mathbb{C} , together with a functor $\mathbf{S}: \mathbb{C}_{|\geq 2} \rightarrow \mathbb{D}^0(\mathbb{C})_H$ making the following square commute

$$\begin{array}{ccc}
 \mathbb{C}_{|\geq 2} & \xrightarrow{\mathbf{S}} & \mathbb{D}^0(\mathbb{C})_H \\
 \downarrow & & \downarrow \mathbf{m} \\
 \mathbb{C} & \xrightarrow{\mathbf{y}} & \widehat{\mathbb{C}},
 \end{array} \tag{3}$$

where \mathbf{m} denotes the middle projection functor, such that for all $\mu \in \mathbb{C}_{|\geq 2}$, the initial position of $\mathbf{S}(\mu)$ is tight.

3.2.10. DEFINITION. Cospans in the image of \mathbf{S} are called the seeds of \mathbf{S} .

Letting X, Y, Z, \dots range over positions, we get that any signature \mathbf{S} maps any move M to some cospan $Y \rightarrow M \leftarrow X$ which determines its initial and final positions.

3.2.11. EXAMPLE. The functor \mathbf{S}_π of Definition 3.1.6 is a signature. Indeed, all morphisms are evidently monic and all bottom squares are 1D-pullbacks (the only one that is not a pullback is the one that corresponds to $\rho: \iota_{n,a} \rightarrow \sigma_{n,a,m,c,d}$, and it is straightforwardly shown to be a 1D-pullback). Furthermore, all initial positions are clearly tight.

Here is an immediate, useful consequence of the definition:

3.2.12. LEMMA. The functor \mathbf{S} underlying any signature is fully faithful.

PROOF. Faithfulness holds by Yoneda and fullness follows from monicity of the legs of the involved cospans. ■

3.3. FROM SIGNATURES TO PSEUDO DOUBLE CATEGORIES. We now define and give an explicit description of the pseudo double category $\mathbb{D}(\mathbf{S})$ associated to any signature \mathbf{S} .

Let us start with the following observation:

3.3.1. PROPOSITION. *For any pushout square of the form*

$$\begin{array}{ccc}
 id_{Z_0}^\bullet & \xrightarrow{id_h^\bullet} & id_Z^\bullet \\
 k \downarrow & & \downarrow \\
 \mathbf{S}(\mu) & \xrightarrow{\quad} & P
 \end{array} \tag{4}$$

in $\mathbf{Cospan}(\widehat{\mathbb{C}})_H$, if $h \in \mathbb{D}^0(\mathbb{C})_h(Z_0, Z)$ and $k \in \mathbb{D}^0(\mathbb{C})_H(id_{Z_0}^\bullet, \mathbf{S}(\mu))$, i.e., h is 1D-injective and k has 1D-injective components and 1D-pullback bottom square, then the whole square in fact lies in $\mathbb{D}^0(\mathbb{C})$.

PROOF. Indeed, given h and $id_{Z_0}^\bullet \rightarrow \mathbf{S}(\mu)$ as above, the pushout $P = (Y \rightarrow M \leftarrow X)$ always exists in $\mathbf{Cospan}(\widehat{\mathbb{C}})_H$. It is computed by taking pushouts levelwise, as in

$$\begin{array}{ccccc}
 & & Y_0 & \xrightarrow{\quad} & Y \\
 & \nearrow & \downarrow & & \downarrow \\
 & & \mu & \xrightarrow{\quad} & M \\
 Z_0 & \nearrow & \uparrow & \searrow & \downarrow \\
 & & X_0 & \xrightarrow{\quad} & X
 \end{array} \tag{5}$$

where $\mathbf{S}(\mu) = (Y_0 \rightarrow \mu \leftarrow X_0)$ and the dashed arrows are obtained by universal property of pushout. Now, monos are stable under pushouts in \mathbf{Set} and colimits are pointwise in presheaf categories, so 1D-injectivity of all components follows from 1D-injectivity of all involved morphisms. Finally, both bottom squares are pullbacks, hence 1D-pullbacks as desired, either by Lemma A.1.1 or by the pushout lemma and Lemma A.1.4. ■

3.3.2. REMARK. In the proposition above, k necessarily has 1D-pullback bottom square. Indeed, both its top and bottom squares are pullback by Lemma A.1.1.

3.3.3. DEFINITION. *A move is any cospan M isomorphic to one obtained as a pushout of the form (4).*

3.3.4. DEFINITION. *The pseudo double category $\mathbb{D}(\mathbf{S})$ associated to any signature \mathbf{S} is the smallest sub-pseudo double category of $\mathbb{D}^0(\mathbb{C})$ such that*

- $\mathbb{D}(\mathbf{S})_h$ is $\mathbb{D}^0(\mathbb{C})_h$;
- $\mathbb{D}(\mathbf{S})_H$ is replete and contains all moves;
- $\mathbb{D}(\mathbf{S})$ is locally full, i.e., if a cell of $\mathbb{D}^0(\mathbb{C})$ has its perimeter in $\mathbb{D}(\mathbf{S})$, then it is in $\mathbb{D}(\mathbf{S})$.

3.3.5. REMARK. By Proposition 3.3.1, saying that $\mathbb{D}(\mathbf{S})$ contains all moves entails that all pushout squares defining moves lie inside $\mathbb{D}(\mathbf{S})$.

That $\mathbb{D}(\mathbf{S})$ is well-defined is easy: it is the intersection of all sub-pseudo double categories of $\mathbb{D}^0(\mathbb{C})$ that verify all three points above, and $\mathbb{D}^0(\mathbb{C})$ is obviously one such pseudo double category, so we are taking the intersection of a non-empty family.

It is still useful to give a concrete description of $\mathbb{D}(\mathbf{S})$. First, its horizontal category is just $\mathbb{D}^0(\mathbb{C})_h$. Regarding vertical morphisms, $\mathbb{D}(\mathbf{S})$ must contain all moves, and since it is stable under vertical composition, it must also contain all finite composites of moves. By repleteness, it should also contain all vertical morphisms isomorphic to such vertical composites. We thus define:

3.3.6. DEFINITION. A play is any vertical morphism isomorphic to some vertical composite of moves.

3.3.7. PROPOSITION. $\mathbb{D}(\mathbf{S})$ is precisely the locally full sub-pseudo double category of $\mathbb{D}^0(\mathbb{C})$ obtained by restricting vertical morphisms to plays.

PROOF. By construction, it is enough to show that the given data forms a sub-pseudo double category of $\text{Cospan}(\widehat{\mathbb{C}})$, which is easy. ■

3.4. FIBREDNESS AND CATEGORIES OF PLAYS. For a given pseudo double category \mathbb{D} , the categories of plays studied in previous work [18, 9, 8] come in several flavours. A first variant is based on the following category:

3.4.1. DEFINITION. Let \mathbb{E} denote the category

- whose objects are vertical morphisms of \mathbb{D} ,
- and whose morphisms $u \rightarrow u'$ are pairs (w, α) as below left, considered equivalent up to the equivalence relation generated by equating (w, α) with $(w', \alpha \circ (u \bullet \gamma))$, for all cells γ as below right:

$$\begin{array}{ccc}
 T & \xrightarrow{s} & Z' \\
 w \downarrow & & \downarrow \\
 Z & \xrightarrow{\alpha} & u' \\
 u \downarrow & & \downarrow \\
 Y & \xrightarrow{r} & Y'
 \end{array}
 \qquad
 \begin{array}{ccc}
 T' & \rightarrow & T & \xrightarrow{s} & Z' \\
 & \searrow & \downarrow & & \downarrow \\
 & & w & & u' \\
 & \nearrow & \downarrow & & \downarrow \\
 & & Z & \xrightarrow{\alpha} & \\
 & & u \downarrow & & \\
 & & Y & \xrightarrow{r} & Y'
 \end{array}
 \tag{6}$$

3.4.2. NOTATION. We denote the involved equivalence relation by \sim . Furthermore, in principle, \mathbb{E} depends on \mathbb{D} , which should appear in the notation. For readability, we will rely on context to disambiguate.

In order to define composition in this category, one needs to consider all diagrams of shape the solid part of

$$\begin{array}{ccccc}
 Z'' & \dashrightarrow & Z' & \xrightarrow{s'} & Y'' \\
 w'' \downarrow & \square \xrightarrow{\gamma} & w' \downarrow & & \downarrow \\
 Z & \xrightarrow{s} & Y' & & \downarrow \\
 w \downarrow & \xrightarrow{\alpha} & \downarrow & \xrightarrow{\beta} & \downarrow \\
 Y & & \downarrow u' & & \downarrow u'' \\
 u \downarrow & & \downarrow & & \downarrow \\
 X & \xrightarrow{r} & X' & \xrightarrow{r'} & X''
 \end{array}$$

Fibredness then comes in by requiring the existence of a cell γ as shown, which is canonical in a certain sense. This allows us to define the composite of (w, α) and (w', β) as the equivalence class of $(w \bullet w'', \beta \circ (\alpha \bullet \gamma))$.

To state the fibredness property, we first need to recall the definition of fibration.

3.4.3. DEFINITION. For any functor $p: \mathbb{E} \rightarrow \mathbb{B}$, a morphism $r: e' \rightarrow e$ in \mathbb{E} is cartesian when, as below, for all $t: e'' \rightarrow e$ and $k: p(e'') \rightarrow p(e')$ such that $p(r) \circ k = p(t)$, there exists a unique $s: e'' \rightarrow e'$ such that $p(s) = k$ and $r \circ s = t$:

$$\begin{array}{ccccc}
 e'' & & & & \\
 \downarrow & \searrow t & & & \\
 e' & \xrightarrow{r} & e & & \\
 \downarrow & \swarrow s & & & \\
 p(e'') & & & & \\
 \downarrow & \searrow k & & & \\
 p(e') & \xrightarrow{p(r)} & p(e) & & \\
 \downarrow & \swarrow p(t) & & & \\
 & & & &
 \end{array}$$

3.4.4. DEFINITION. A functor $p: \mathbb{E} \rightarrow \mathbb{B}$ is a fibration if and only if for all e in \mathbb{E} , any $h: b' \rightarrow p(e)$ has a cartesian lifting, i.e., a cartesian antecedent by p with codomain e .

Here is the fibredness property:

3.4.5. DEFINITION. A pseudo double category \mathbb{D} is fibred if and only if the codomain functor $\text{cod}: \mathbb{D}_H \rightarrow \mathbb{D}_h$ is a fibration.

Concretely, fibredness says that given any vertical morphism $u: X \rightarrow Y$ and horizontal morphism $h: B \rightarrow Y$, there exists a cartesian α as below, i.e., such that for all horizontal $l: D \rightarrow B$, vertical $w: C \rightarrow D$, and $\beta: w \rightarrow u$ as shown, there exists a unique filler $\gamma: w \rightarrow v$ with lower border l such that $\alpha \circ \gamma = \beta$.

$$\begin{array}{ccccc}
 C & & & & \\
 \downarrow w & \searrow & & & \\
 D & \xrightarrow{l} & B & \xrightarrow{h} & Y \\
 & & \downarrow v & & \downarrow u \\
 & & & \xrightarrow{\alpha} & \\
 & & & \xrightarrow{\beta} & \\
 & & & \xrightarrow{\gamma} &
 \end{array}$$

Fibredness is related to Grandis and Paré’s double categorical Kan extensions [17] and to Shulman’s *framed* bicategories [32].

3.4.6. PROPOSITION. *If \mathbb{D} is fibred, then \mathbb{E} is indeed a category.*

3.4.7. REMARK. In our concurrent game models [18, 9, 8], we do not directly use \mathbb{E} , but rather variants ‘localised’ at some position X . One such variant is the category $\mathbb{E}(X)$, for some position X , whose objects are plays $u: Y \dashrightarrow X$, and morphisms are those of \mathbb{E} , as on the left in (6) that have id_X as their lower border.

Our next goal is to give an abstract framework to show that, given some signature \mathbf{S} , $\mathbb{D}(\mathbf{S})$ is fibred. We want this framework to be abstract enough to be able to use it on the existing examples of CCS [18], the π -calculus [9], and our signature for HON games [8].

4. Fibredness

In this section, we study the fibredness property abstractly. In order to do that, we first define a candidate cartesian lifting of any morphism in $\mathbb{D}(\mathbf{S})_h$ using factorisation systems and show that it has all the good properties of cartesian liftings, except that it is unclear whether it lies inside $\mathbb{D}(\mathbf{S})_H$, which is proved in the rest of the section. We then recast the definitions of 1D-injectivity and 1D-pullbacks in terms closer to the defining properties of injective maps and pullbacks. We then give a necessary and sufficient condition for our candidate lifting to lie in $\mathbb{D}(\mathbf{S})_H$, hence for $\mathbb{D}(\mathbf{S})$ to be fibred. However, this condition is not very useful in practice, so, in the last part, we give a sufficient condition for $\mathbb{D}(\mathbf{S})$ to be fibred that is easier to verify.

4.1. FIBREDNESS THROUGH FACTORISATION SYSTEMS. Our main tool to prove that the pseudo double category $\mathbb{D}(\mathbf{S})$ generated by a signature \mathbf{S} is fibred will be cofibrantly generated factorisation systems. Let us explain the core idea of the proof. In the setting of Example 2.1.2, any factorisation system $(\mathcal{L}, \mathcal{R})$ on \mathcal{C} yields a fibred sub-pseudo double category of $\mathbf{Cospan}(\mathcal{C})$.

We are going to refine the pseudo double category $\mathbf{Cospan}(\mathcal{C})$ into a fibred pseudo double category. Let us consider $\mathbf{Cospan}_{\mathcal{L}, \mathcal{R}}(\mathcal{C})$, the locally full sub-pseudo double category of $\mathbf{Cospan}(\mathcal{C})$

- whose horizontal category is \mathcal{C} ,
- and whose vertical morphisms $Y \dashrightarrow X$ are cospans $Y \xrightarrow{s} U \xleftarrow{l} X$ with $l \in \mathcal{L}$ (recalling Notation 2.2.3).

4.1.1. PROPOSITION. *The pseudo double category $\mathbf{Cospan}_{\mathcal{L}, \mathcal{R}}(\mathcal{C})$ forms a sub-pseudo double category of $\mathbf{Cospan}(\mathcal{C})$ that is fibred if \mathcal{C} has pullbacks.*

PROOF. That $\mathbf{Cospan}_{\mathcal{L},\mathcal{R}}(\mathcal{C})$ forms a pseudo double category is a simple consequence of Lemma 2.2.7. To see that it is fibred, consider any vertical morphism $Y \xrightarrow{f} U \xleftarrow{l} X$ and horizontal morphism $X' \xrightarrow{h} X$. In order to construct a cartesian lifting of (f, l) along h , we factor the composite $X' \xrightarrow{h} X \xrightarrow{l} U$ as $X' \xrightarrow{l'} U' \xrightarrow{h'} U$, with $l' \in \mathcal{L}$ and $h' \in \mathcal{R}$, and then take the pullback of f and h' , as in the front face below:

$$\begin{array}{ccccc}
 Y'' & & & & \\
 \downarrow f'' & \dashrightarrow s'' & & & \\
 U'' & & Y' & \xrightarrow{h''} & Y \\
 \uparrow l'' & \dashrightarrow s' & \downarrow f' & & \downarrow f \\
 X'' & & U' & \xrightarrow{h'} & U \\
 & \searrow s & \uparrow l' & & \uparrow l \\
 & & X' & \xrightarrow{h} & X
 \end{array} \tag{7}$$

The obtained morphism (h, h', h'') is generally not cartesian in $\mathbf{Cospan}(\mathcal{C})_H$, but let us show that it is in $\mathbf{Cospan}_{\mathcal{L},\mathcal{R}}(\mathcal{C})$. For this, consider any morphism (q, q', q'') to U such that $q = hs$ as above; then since $l'' \in \mathcal{L}$ (by hypothesis) and $h' \in \mathcal{R}$ (by construction), we obtain by the lifting property a unique s' making everything in sight commute. But then the universal property of pullback gives the desired s'' . ■

Furthermore, in this situation, we may characterise cartesian cells as follows.

4.1.2. LEMMA. *A morphism in $\mathbf{Cospan}_{J_S}(\widehat{\mathbb{C}})_H$ is cartesian if and only if it has the shape of the front face of (7), i.e., its top square is a pullback and its middle morphism is in J_S^\perp .*

PROOF. The “if” direction follows from the proof of Proposition 4.1.1. For the converse, the considered properties are stable under composition with isomorphisms in $\mathbf{Cospan}_{J_S}(\widehat{\mathbb{C}})_H$. But any cartesian morphism $\alpha: \langle U \rangle \rightarrow \langle U' \rangle$ is uniquely isomorphic in $\mathbf{Cospan}_{J_S}(\widehat{\mathbb{C}})_H / \langle U' \rangle$ to the cartesian lifting of $\langle U' \rangle$ along $\text{cod}(\alpha)$ computed as in (7), hence the result. ■

For any signature \mathbf{S} over some base category \mathbb{C} , we will try to apply this construction to the pseudo double category of plays $\mathbb{D}(\mathbf{S})$ over \mathbf{S} , with the factorisation system cofibrantly generated (remember Theorem 2.2.5) by the set J_S of all “ t -legs”, i.e., the set of morphisms $X \xrightarrow{t} M$ for $Y \xrightarrow{s} M \xleftarrow{t} X$ spanning seeds. A map is then in J_S^\perp when no new move is added “forwards”, i.e., following the direction of time. Indeed, recalling that each M occurring in a seed should be representable, giving a square

$$\begin{array}{ccc}
 X & \xrightarrow{f} & U \\
 \downarrow t & & \downarrow r \\
 M & \xrightarrow{\mu} & V
 \end{array}$$

amounts by Yoneda to picking a move μ in V , whose initial position X is already available in U . The map r is then in \mathcal{R} when all such moves are also already in U .

Our goal now reduces to showing that $\mathbb{D}(\mathbf{S})$ is fibred as a sub-pseudo double category of $\mathbf{Cospan}_{\perp(J_S^{\perp}), J_S^{\perp}}(\widehat{\mathbb{C}})$ – which we henceforth abbreviate to $\mathbf{Cospan}_{J_S}(\widehat{\mathbb{C}})$. The difficulty is that, in a situation like (7), the factorisation system yields a cartesian lifting (h, h', h'') in $\mathbf{Cospan}_{J_S}(\widehat{\mathbb{C}})$, of which we will further need to prove that (1) it lies in $\mathbb{D}(\mathbf{S})_H$, and (2) it is also cartesian there. Point (2) reduces to proving that if (q, q', q'') is in $\mathbb{D}(\mathbf{S})_H$ then so is (s, s', s'') .

In fact, assuming that the candidate lifting is in $\mathbb{D}(\mathbf{S})$, its cartesianness follows from the fact that all mediating arrows, computed as in (7), are also in $\mathbb{D}(\mathbf{S})$. Indeed, we have:

4.1.3. LEMMA. $\mathbb{D}(\mathbf{S})_H$ has the left cancellation property: for all β and α in $\mathbf{Cospan}(\widehat{\mathbb{C}})$ such that $\beta \circ \alpha$ and β are in $\mathbb{D}(\mathbf{S})_H$, then also α is in $\mathbb{D}(\mathbf{S})_H$.

PROOF. By 1D-analogues of the pullback lemma and left cancellation for monomorphisms. ■

It thus remains to prove that the candidate lifting is a play, and that the morphism (h, h', h'') lies in $\mathbb{D}(\mathbf{S})_H$. Let us record this as:

4.1.4. LEMMA. Assume that in all situations like (7), if U is a play and h is 1D-injective, then U' is again a play and (h, h', h'') is in $\mathbb{D}(\mathbf{S})_H$. Then, $\mathbb{D}(\mathbf{S})$ is fibred.

We thus consider conditions for this to hold. In Section 4.3, we show that if it holds for seeds, then it extends to all plays. In Section 4.4, we investigate conditions for the result to hold for seeds.

This all relies on a few elementary facts about 1D-pullbacks, 1D-injectivity, and tightness, which we prove in Section 4.2.

4.2. 1D-PULLBACKS, 1D-INJECTIVITY, AND TIGHTNESS. This section is essentially a technical investigation, but in passing it also clarifies the notions of 1D-pullback, 1D-injectivity, and tightness. We first recast 1D-pullbacks and 1D-injectivity in terms of the restriction to objects of dimension ≥ 1 . We first recall the standard chain of adjunctions induced by restriction. Then, we give characterisations of 1D-notions in terms of their restrictions. We also establish 1D-variants of the standard defining properties for pullbacks and monicity, relative to objects of dimension ≥ 1 . Finally, we prove a 1D-variant of the universal property of pullbacks, but this time relative to tight positions, together with an easy consequence, roughly a 1D-pullback lemma relative to tight positions.

4.2.1. DEFINITION. Let $i_1: \mathbb{C}_{|\geq 1} \hookrightarrow \mathbb{C}$ denote the full subcategory spanning objects of dimension ≥ 1 .

We have the standard chain of adjunctions:

$$\widehat{\mathbb{C}}_{|\geq 1} \begin{array}{c} \xrightarrow{\Sigma_{i_1}} \\ \xleftarrow{\Delta_{i_1}} \\ \xrightarrow{\Pi_{i_1}} \end{array} \widehat{\mathbb{C}}, \tag{8}$$

where Δ_{i_1} , Σ_{i_1} and Π_{i_1} respectively denote restriction, left Kan extension and right Kan extension along the opposite of i_1 . We will not need Π_{i_1} here, and Σ_{i_1} essentially adds the necessary channels in a minimal way. Indeed, a short calculation from the well-known characterisation of left Kan extensions as coends leads to:

$$\sum_{i_1} (X)(c) = \begin{cases} X(c) & (\text{if } \dim(c) \geq 1) \\ \int^{\dim(d) \geq 1} X(d) \times \mathbb{C}(c, d) & (\text{otherwise}). \end{cases}$$

4.2.2. EXAMPLE. With \mathbb{C} as in Definition 3.1.4, in the case $\dim(c) = 0$, we thus have, e.g., n channels for each player of arity n . Furthermore, the coend ensures that, when two players are the source and target of some move, the needed equations are enforced (e.g., $s \circ s_i = t \circ s_i$).

In fact, because i_1 is fully faithful, the first adjunction is a coreflection:

4.2.3. PROPOSITION. The left adjoint Σ_{i_1} is fully faithful, and the comonad $\Sigma_{i_1} \circ \Delta_{i_1}$ is idempotent, so that $\widehat{\mathbb{C}}_{|\geq 1}$ is a coreflective, full subcategory of $\widehat{\mathbb{C}}$.

PROOF. It is well known [20, Proposition 4.23] that the unit of the adjunction is an isomorphism when we extend and restrict along a fully-faithful functor. Furthermore, it is also well-known [23] that if the unit of an adjunction is an isomorphism, then the left adjoint is full and faithful. The comultiplication of the induced comonad is then an isomorphism by construction. ■

There is an easy characterisation of 1D-injectivity and 1D-pullbacks in terms of Δ_{i_1} :

4.2.4. PROPOSITION. A morphism in $\widehat{\mathbb{C}}$ is 1D-injective if and only if its image by Δ_{i_1} is injective.

A square in $\widehat{\mathbb{C}}$ is a 1D-pullback if and only if its image by Δ_{i_1} is a pullback.

PROOF. By definition and the fact that limits are pointwise in presheaf categories. ■

Let us now establish a characterisation of 1D-injectivity and pullbacks analogous to the standard defining properties of monicity and pullbacks, though relative to objects of $\widehat{\mathbb{C}}_{|\geq 1}$.

4.2.5. PROPOSITION. A square in $\widehat{\mathbb{C}}$ as below left is a 1D-pullback if and only if for all $X \in \widehat{\mathbb{C}}_{\geq 1}$, u and v as below right making the outer diagram commute, there is a unique mediating morphism h as shown, such that $ph = u$ and $qh = v$:

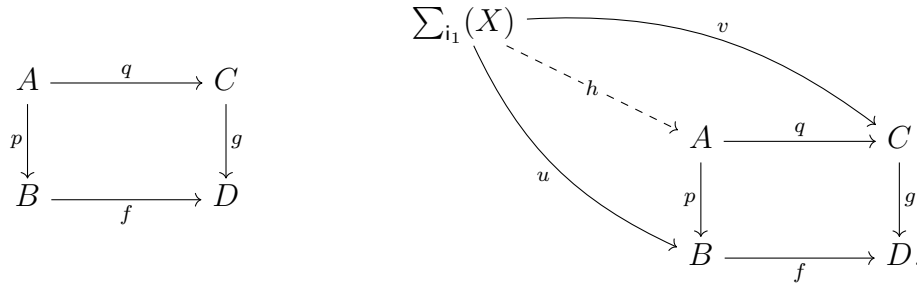

PROOF. This follows from the more general fact that for any full coreflection

$$L: \mathbb{C} \begin{array}{c} \longleftarrow \\ \perp \\ \longrightarrow \end{array} \mathbb{D} : R,$$

small category J , and functor $D: J \rightarrow \mathbb{D}$, if RD has a limit in \mathbb{C} , then $L(\lim_j RD(j))$ has the universal property of a limit of D relative to objects of \mathbb{C} , i.e., we have for all $X \in \mathbb{C}$:

$$\int_{j \in J} \mathbb{D}(LX, D(j)) \cong \mathbb{D}(LX, L(\lim_j RD(j)))$$

naturally in X . Indeed, we have

$$\int_{j \in J} \mathbb{D}(LX, D(j)) \cong \int_{j \in J} \mathbb{C}(X, RD(j)) \cong \mathbb{C}(X, \lim_j RD(j)) \cong \mathbb{D}(LX, L(\lim_j RD(j))),$$

where the last step is by full faithfulness of L . ■

4.2.6. PROPOSITION. Consider any morphism $m: X \rightarrow Y$ in $\widehat{\mathbb{C}}$. The following are equivalent:

1. m is 1D-injective;
2. for all $f, g: \sum_{i_1}(Z) \rightarrow X$, $mf = mg$ implies $f = g$;
3. the square

$$\begin{array}{ccc} X & \xlongequal{\quad} & X \\ \parallel & & \downarrow m \\ X & \xrightarrow{\quad m \quad} & Y \end{array} \tag{9}$$

is a 1D-pullback.

PROOF. By definition, these three items are respectively equivalent to

- (1') $\Delta_{i_1}(m)$ is monic,
- (2') for all $f, g: Z \rightarrow \Delta_{i_1}(X)$, $\Delta_{i_1}(m)f = \Delta_{i_1}(m)g$ implies $f = g$;
- (3') the image by Δ_{i_1} of the square (9) is a pullback.

But now these three are well-known to be equivalent. ■

Finally, we consider similar properties, but relative to tight positions. Let us first observe the following characterisation of tightness in terms of the adjunctions (8).

4.2.7. LEMMA. *For any position X , we have $\text{Pl}(X) \cong \sum_{i_1}(\Delta_{i_1}(X))$ (recalling Definition 3.2.8). In particular, X is tight if and only if $\varepsilon_X: \sum_{i_1}(\Delta_{i_1}(X)) \rightarrow X$ is epi.*

PROOF. By definition. ■

The adapted universal property of 1D-pullbacks relative to tight positions is then:

4.2.8. LEMMA. *For any commuting diagram as the solid part of*

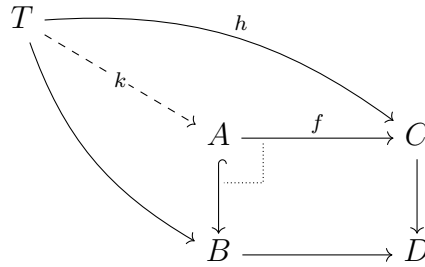

with the marked mono and 1D-pullback, and where T is a tight position, there exists a unique map k making the diagram commute.

PROOF. We construct in turn both dashed maps in

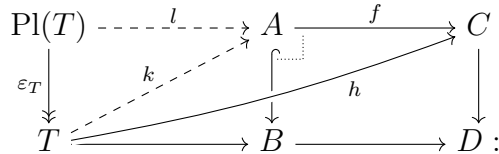

- l follows from universal property of 1D-pullbacks (Proposition 4.2.5), since $\text{Pl}(T) \cong \sum_{i_1}(\Delta_{i_1}(T))$ (Lemma 4.2.7),
- k then follows again by Lemma 4.2.7 (which ensures that ε_T is epi) and lifting in the (Epi, Mono) factorisation system.

The construction of k however does not *a priori* ensure that $f \circ k = h$, but $f \circ k \circ \varepsilon_T = f \circ l = h \circ \varepsilon_T$ which entails the result by tightness. ■

This yields an analogue of the pullback lemma:

4.2.9. LEMMA. *In any commuting diagram*

$$\begin{array}{ccccc}
 A & \xrightarrow{\quad} & B & \xrightarrow{\quad} & C \\
 \downarrow & \lrcorner & \downarrow & \dashv\!\!\dashv & \downarrow \\
 D & \xrightarrow{\quad} & E & \xrightarrow{\quad} & F
 \end{array}$$

with the marked mono, pullback and 1D-pullback, the outer rectangle has the universal property of pullbacks w.r.t. tight positions.

PROOF. Similar to the proof of the pullback lemma, using Lemma 4.2.8. ■

4.3. A NECESSARY AND SUFFICIENT FIBREDNESS CRITERION. In this section, we prove our first main result, namely that, under the hypothesis that seeds admit cartesian restrictions (which we investigate independently in the next section), $\mathbb{D}(\mathbf{S})$ is fibred. The idea for this is to prove that moves admit cartesian liftings, and that cartesian liftings compose vertically, so that one can compute the cartesian lifting of a play inductively for each of its moves. In fact, showing that moves admit cartesian liftings reduces to proving (Lemma 4.3.11) that pushing a play P along a horizontal morphism yields a play P' , such that the morphism $P \rightarrow P'$ is cartesian. This is in fact not completely accurate, as it does not directly make sense to push a play along a horizontal morphism. The point is that a position Z can be *invariant* in P , namely when there is a morphism $id_Z^\bullet \rightarrow P$. For any such invariant position Z and horizontal morphism $h: Z \rightarrow Z'$, one in fact pushes along $id_h^\bullet: id_Z^\bullet \rightarrow id_{Z'}^\bullet$.

In summary, we have a proof in four main steps:

- we prove that cartesian cells are stable under composition;
- we define invariant positions and prove that pushing plays along horizontal morphisms in the above sense yields cartesian morphisms;
- we deduce that moves admit cartesian restrictions if seeds do;
- finally, we prove by induction that the latter extends to plays.

Let us start with some notation:

4.3.1. NOTATION. The cospan underlying any play $u: Y \dashrightarrow X$ will be denoted by $Y \xrightarrow{s_u} U \xleftarrow{t_u} X$ (using capitalisation for the middle object). We will often denote cospans $Y \xrightarrow{s} U \xleftarrow{t} X$ simply by $\langle U \rangle$, leaving the context provide the missing information. Furthermore, pushouts exist in $\mathbf{Cospan}(\widehat{\mathbb{C}})_H$ (they are given by taking pushouts levelwise) and when we write pushouts of cospans, the notation means that they are cospans in $\mathbf{Cospan}(\widehat{\mathbb{C}})_H$. We will often take pushouts of cospans in $\mathbb{D}^0(\mathbb{C})_H$, but such pushouts are not necessarily pushouts in $\mathbb{D}^0(\mathbb{C})_H$ (the square itself does not necessarily lie in $\mathbb{D}^0(\mathbb{C})_H$).

Vertical composition of cartesian cells We first consider stability of cartesian cells under vertical composition. In order to prove this, by Lemma 4.1.2, we need in particular to show that the middle morphism of a vertical composite of cartesian cells is in J_S^\perp . The following result will prove useful for this.

4.3.2. LEMMA. *For any commuting diagram of 1D-injective maps of the form*

$$\begin{array}{ccccc}
 U & \xrightarrow{s_U} & W & \xleftarrow{s_V} & V \\
 \downarrow f_U & \dashrightarrow & \downarrow f & \dashrightarrow & \downarrow f_V \\
 U' & \xrightarrow{s_{U'}} & W' & \xleftarrow{s_{V'}} & V'
 \end{array}$$

with the marked 1D-pullbacks in $\widehat{\mathbb{C}}$, such that

- s_U and s_V are jointly surjective and both monic,
- $s_{U'}$ and $s_{V'}$ are jointly surjective and both monic,
- f_U and f_V are in J_S^\perp ,

we have that $f \in J_S^\perp$.

PROOF. Consider any morphism $T \rightarrow C$ in J_S and commuting square

$$\begin{array}{ccc}
 T & \longrightarrow & W \\
 \downarrow & & \downarrow \\
 C & \longrightarrow & W'.
 \end{array}$$

We want to show that there is a unique diagonal filler $C \rightarrow W$. By Proposition 4.2.6, uniqueness follows from 1D-injectivity of f and the fact that $C \cong \sum_{i_1} (\Delta_{i_1}(C))$, so we only need to show existence. Furthermore, by joint surjectivity and because C is a representable, $C \rightarrow W'$ factors either through U' or through V' (possibly both).

Both cases being symmetric, we only treat one. If $C \rightarrow W'$ factors through U' , then we get a commuting diagram as the solid part of

$$\begin{array}{ccccc}
 T & \xrightarrow{\quad} & & \xrightarrow{\quad} & W \\
 \downarrow & \dashrightarrow & \nearrow k & \dashrightarrow & \downarrow \\
 C & \xrightarrow{\quad} & U & \xrightarrow{\quad} & W' \\
 & \dashrightarrow & \downarrow & \dashrightarrow & \\
 & & U' & \xrightarrow{\quad} &
 \end{array}$$

hence a map k as indicated by Lemma 4.2.8, using monicity of s_U . By hypothesis, $U \rightarrow U'$ is in J_S^\perp , so there is a unique map $l: C \rightarrow U$ making both triangles commute. By composing it with $U \rightarrow W$, we get the desired diagonal filler. ■

We may now state the first crucial lemma of this section, which states that vertical composition in $\mathbb{D}^0(\mathbb{C})$ preserves $\text{Cospan}_{J_S}(\widehat{\mathbb{C}})$ -cartesianness.

4.3.3. LEMMA. *If any two vertically composable double cells of $\text{Cospan}(\widehat{\mathbb{C}})$ are both in $\mathbb{D}^0(\mathbb{C})$ and $\text{Cospan}_{J_S}(\widehat{\mathbb{C}})$, and are cartesian in the latter, then their vertical composite is again cartesian (in the latter).*

PROOF. Consider any two composable vertical morphisms $\langle U \rangle = (Y \rightarrow U \leftarrow X)$ and $\langle V \rangle = (Z \rightarrow V \leftarrow Y)$, and similarly $\langle U' \rangle$ and $\langle V' \rangle$, together with composable cartesian double cells $\alpha: \langle U \rangle \rightarrow \langle U' \rangle$ and $\beta: \langle V \rangle \rightarrow \langle V' \rangle$. To show that the composite is cartesian, it is enough by Lemma 4.1.2 to show that it has the shape of the front face of (7), i.e., that its top square is a pullback and that $U \bullet V \rightarrow U' \bullet V'$ is right-orthogonal to J_S .

Because $\langle U \rangle \rightarrow \langle U' \rangle$ is cartesian, by Lemma 4.1.2, the left face of

$$\begin{array}{ccccc}
 Y & \xrightarrow{\quad} & V & & \\
 \downarrow & \searrow & \downarrow & \searrow & \\
 & & U & \xrightarrow{\quad} & U \bullet V \\
 \downarrow & \searrow & \downarrow & \searrow & \downarrow \\
 Y' & \xrightarrow{\quad} & V' & & \\
 \downarrow & \searrow & \downarrow & \searrow & \\
 & & U' & \xrightarrow{\quad} & U' \bullet V'
 \end{array}$$

is a pullback, so by two applications of Corollary 3.2.7 and Corollary A.2.2 respectively, its front face is a 1D-pullback and its right one is a pullback. By Lemma 4.3.2, the obtained map $U \bullet V \rightarrow U' \bullet V'$ is thus in J_S^\perp . Since $\langle V \rangle \rightarrow \langle V' \rangle$ is cartesian, by Lemma 4.1.2, the left-hand square below is a pullback, hence so is the right-hand one by the pullback lemma:

$$\begin{array}{ccc}
 Z & \xrightarrow{\quad} & Z' \\
 \downarrow & & \downarrow \\
 V & \xrightarrow{\quad} & V'
 \end{array}
 \qquad
 \begin{array}{ccc}
 Z & \xrightarrow{\quad} & Z' \\
 \downarrow & & \downarrow \\
 U \bullet V & \xrightarrow{\quad} & U' \bullet V'
 \end{array}$$

which concludes the proof. ■

Invariant positions We now turn to defining invariant positions, and proving that pushing a play along a morphism of invariant positions yields a cartesian morphism of plays.

4.3.4. DEFINITION. *An invariant position of a play P is a morphism $id_Z^\bullet \rightarrow P$ in $\mathbb{D}(S)_H$.*

Consider the full embedding

$$\begin{array}{ccc}
 id^\bullet: \widehat{\mathbb{C}}_{|\leq 1} & \hookrightarrow & \text{Cospan}(\widehat{\mathbb{C}})_H \\
 X & \mapsto & id_X^\bullet
 \end{array}$$

of positions into general cospans given by vertical identities.

4.3.5. PROPOSITION. *The full embedding id^\bullet has a right adjoint given by (any choice of) pullbacks in $\widehat{\mathbb{C}}$, in the sense that the final invariant position of a cospan $Y \rightarrow U \leftarrow X$ (the final object among invariant positions of the cospan) is given by the pullback*

$$\begin{array}{ccc} Z & \xrightarrow{\quad} & Y \\ \downarrow & \lrcorner & \downarrow \\ X & \xrightarrow{\quad} & U \end{array}$$

PROOF. An invariant position is equivalently a cone to the given play, so we conclude by universal property of pullback. ■

The idea behind the definition of invariant positions $id_Z^\bullet \rightarrow \langle U \rangle$ is that they are parts of the initial position X that are left untouched by all moves of the play. The final invariant position is the biggest such subposition of X .

4.3.6. EXAMPLE. By their characterisation as a pullback of monic maps, final invariant positions are always subpositions of both the initial and final positions of the play.

In the case of the π -calculus, the final invariant position of all seeds $Y \xrightarrow{s} M \xleftarrow{t} X$ is $X(\star) \cdot \star$. Indeed, in any seed, for all channels in the initial position, there is a (necessarily unique, by monicity) corresponding channel in the final position. There may be other channels in the final position (e.g., in the case of $\iota_{n,a}$), but they are not part of the final invariant position (and thus of no invariant position). Finally, in all seeds, the images of s and t on players are disjoint, which completes the proof of this characterisation.

Let us show the following two results about invariant positions, which prepare for our second key intermediate result, Lemma 4.3.11.

4.3.7. LEMMA. *Any pushout in $\text{Cospan}(\widehat{\mathbb{C}})_H$ as below left, where Z is a position, may be factored as below right, where Z_0 is the final invariant position of U :*

$$\begin{array}{ccc} id_Z^\bullet \xrightarrow{\quad} \langle U \rangle & & id_Z^\bullet \xrightarrow{\quad} id_{Z_0}^\bullet \xrightarrow{\quad} \langle U \rangle \\ \downarrow & \lrcorner & \downarrow & \lrcorner & \downarrow \\ \langle V \rangle \xrightarrow{\quad} \langle W \rangle & & \langle V \rangle \xrightarrow{\quad} \langle V' \rangle \xrightarrow{\quad} \langle W \rangle \end{array}$$

If $\langle V \rangle$ is isomorphic to $id_{Z'}^\bullet$, for some position Z' , then $\langle V' \rangle$ is isomorphic to $id_{Z'_0}^\bullet$ for some position Z'_0 .

PROOF. The last point is a consequence of colimits being pointwise in presheaf categories. For the first, we get a map $Z \rightarrow Z_0$ such that $id_Z^\bullet \rightarrow \langle U \rangle = id_Z^\bullet \rightarrow id_{Z_0}^\bullet \rightarrow \langle U \rangle$ by adjunction. We can then define $\langle V' \rangle$ as the pushout of $\langle V \rangle$ along $id_Z^\bullet \rightarrow id_{Z_0}^\bullet$ and obtain a unique morphism $\langle V' \rangle \rightarrow \langle W \rangle$ by its universal property: this yields a diagram as desired, whose right-hand square is again a pushout by the pushout lemma. ■

4.3.8. LEMMA. *Final invariant positions are stable under pushout in the following sense: if Z is the final invariant position of the play $\langle U \rangle$ and*

$$\begin{array}{ccc} id_Z^\bullet & \longrightarrow & id_{Z'}^\bullet \\ \downarrow & & \downarrow \\ \langle U \rangle & \longrightarrow & \langle U' \rangle \end{array}$$

is a pushout, then Z' is the final invariant position of $\langle U' \rangle$.

PROOF. Let us first name the involved presheaves: $\langle U \rangle = (Y \rightarrow U \leftarrow X)$ and $\langle U' \rangle = (Y' \rightarrow U' \leftarrow X')$. Since Z is the final invariant position of $\langle U \rangle$, we may apply Corollary A.2.2 to

$$\begin{array}{ccccc} Z & \xrightarrow{\quad} & Y & & \\ \downarrow & \searrow & \downarrow & \searrow & \\ & Z' & \xrightarrow{\quad} & Y' & \\ \downarrow & \downarrow & \downarrow & \downarrow & \\ X & \xrightarrow{\quad} & U & & \\ & \searrow & \downarrow & \searrow & \\ & X' & \xrightarrow{\quad} & U' & \end{array}$$

to obtain that the front face is also a pullback. ■

We now turn to proving the second key intermediate result, Lemma 4.3.11, which, we recall, states that pushing plays along morphisms of invariant positions yields cartesian cells. We start by showing the following two technical results.

4.3.9. LEMMA. *In $\text{Cospan}(\widehat{\mathbb{C}})_H$, pushout squares are preserved by vertical composition. More explicitly, given two vertically composable pushouts as below left and centre, the composite square below right is again a pushout:*

$$\begin{array}{ccc} \langle U_0 \rangle \longrightarrow \langle U_1 \rangle & \langle V_0 \rangle \longrightarrow \langle V_1 \rangle & \langle U_0 \rangle \bullet \langle V_0 \rangle \longrightarrow \langle U_1 \rangle \bullet \langle V_1 \rangle \\ \downarrow & \downarrow & \downarrow \\ \langle U_2 \rangle \longrightarrow \langle U \rangle & \langle V_2 \rangle \longrightarrow \langle V \rangle & \langle U_2 \rangle \bullet \langle V_2 \rangle \longrightarrow \langle U \rangle \bullet \langle V \rangle \end{array}$$

PROOF. Let us first name the involved presheaves: $\langle U_i \rangle = (Y_i \rightarrow U_i \leftarrow X_i)$, $\langle V_i \rangle = (Z_i \rightarrow V_i \leftarrow Y_i)$, and similarly for $\langle U \rangle$ and $\langle V \rangle$. If we call Λ the posetal category with objects 0, 1, and -1 , and morphisms generated by $0 \rightarrow 1$ and $0 \rightarrow -1$ (the “walking span” category), we introduce a bifunctor from $\Lambda \times \Lambda$ to $\widehat{\mathbb{C}}$ through the following diagram:

$$\begin{array}{ccccc}
 V_1 & \longleftarrow & V_0 & \longrightarrow & V_2 \\
 \uparrow & & \uparrow & & \uparrow \\
 Y_1 & \longleftarrow & Y_0 & \longrightarrow & Y_2 \\
 \downarrow & & \downarrow & & \downarrow \\
 U_1 & \longleftarrow & U_0 & \longrightarrow & U_2.
 \end{array}$$

By computing its colimit first horizontally, then vertically, we get $\langle U \rangle \bullet \langle V \rangle$, which by interchange of colimits is the desired pushout. ■

4.3.10. LEMMA. *Consider any diagram*

$$\begin{array}{ccc}
 A & \xrightarrow{f} & B \\
 g \downarrow & \nearrow l & \downarrow k \\
 C & \xrightarrow{h} & D
 \end{array}$$

in $\widehat{\mathbb{C}}$ where only the outer square and the bottom right triangle are known to commute, i.e., $kf = hg$ and $kl = h$. If A is tight and k is 1D-injective, then also the top left triangle commutes.

PROOF. Post-composing with k , we have by hypothesis that $kf = hg = klg$, hence $kf\varepsilon_A = klg\varepsilon_A$. By 1D-injectivity of k and Proposition 4.2.6, we get $f\varepsilon_A = lg\varepsilon_A$. By tightness of A and Lemma 4.2.7, we finally obtain $f = lg$. ■

We may at last state the second key intermediate result:

4.3.11. LEMMA. *For any pushout*

$$\begin{array}{ccc}
 id_Z^\bullet & \xrightarrow{id_h^\bullet} & id_{Z'}^\bullet \\
 k \downarrow & & \downarrow \\
 P & \xrightarrow{\quad} & P'
 \end{array} \tag{10}$$

in $\text{Cospan}(\widehat{\mathbb{C}})_H$ where $h \in \mathbb{D}^0(\mathbb{C})_h(Z, Z')$ and $k \in \mathbb{D}(\mathbb{S})_H(id_Z^\bullet, P)$, P' is a play and $P \rightarrow P'$ is cartesian and lies in $\mathbb{D}^0(\mathbb{C})_H$ (hence also in $\mathbb{D}(\mathbb{S})_H$).

PROOF. The fact that $P \rightarrow P'$ lies in $\mathbb{D}^0(\mathbb{C})_H$ follows from 1D-injectivity of h , stability of monos under pushout in Set , and the fact that pushouts along monos are pullbacks by adhesivity of Set . Let us show the other properties by induction on the play.

We prepare the induction by treating the case of moves. Let us thus assume that $P = \langle M \rangle$ is a move. We know that any move $\langle M \rangle$ is a pushout of some seed $\langle M_0 \rangle$. By Lemma 4.3.7, we may assume that it is the pushout of $\langle M_0 \rangle$ along a morphism $Z_0 \rightarrow Z'_0$, where Z_0 is the final invariant position of $\langle M_0 \rangle$. Since Z_0 is the final invariant position of

$\langle M_0 \rangle$, by Lemma 4.3.8, we know that Z'_0 is the final invariant position of $\langle M \rangle$. Therefore, $id_Z^\bullet \rightarrow \langle M \rangle$ factors as $id_Z^\bullet \rightarrow id_{Z'_0}^\bullet \rightarrow \langle M \rangle$. Now, we define Z'' as the pushout below and $id_{Z''}^\bullet \rightarrow \langle P' \rangle$ by its universal property:

$$\begin{array}{ccc}
 id_Z^\bullet & \longrightarrow & id_{Z'}^\bullet \\
 \downarrow & & \downarrow \\
 id_{Z'_0}^\bullet & \longrightarrow & id_{Z''}^\bullet \\
 & \searrow & \dashrightarrow \\
 & & \langle P' \rangle
 \end{array}
 \quad
 \begin{array}{ccc}
 & & \langle M \rangle \longrightarrow \langle P' \rangle \\
 & & \uparrow \\
 & & id_{Z''}^\bullet
 \end{array}$$

Now, two applications of the pushout lemma give that

$$\begin{array}{ccc}
 id_{Z_0}^\bullet & \longrightarrow & id_{Z''}^\bullet \\
 \downarrow & & \downarrow \\
 \langle M_0 \rangle & \longrightarrow & \langle P' \rangle
 \end{array}$$

is a pushout, and since $Z_0 \rightarrow Z''$ is 1D-injective (as the composite of two 1D-injective maps), $\langle P' \rangle$ is a move, which we also call $\langle M' \rangle$.

Let us now show that the obtained morphism $\langle M \rangle \rightarrow \langle M' \rangle$ is cartesian, i.e., that it has the shape of the front face of (7), by Lemma 4.1.2. By the pushout lemma, the top square

$$\begin{array}{ccc}
 Y & \longrightarrow & Y' \\
 \downarrow & & \downarrow \\
 M & \longrightarrow & M'
 \end{array}$$

is a pushout along $Y \rightarrow M$, which is monic, so it is a pullback by adhesivity (Lemma A.1.4). Moreover, to show that $M \rightarrow M'$ is right-orthogonal to J_5 , we take any $T \rightarrow C$ in J_5 and commuting square as the solid part of

$$\begin{array}{ccc}
 T & \longrightarrow & M \\
 \downarrow & \nearrow & \downarrow \\
 C & \longrightarrow & M'
 \end{array}$$

Since $M \rightarrow M'$ is an isomorphism in dimensions > 1 and C is a representable of dimension > 1 , $C \rightarrow M'$ can be factored uniquely as shown above. Now, since T is tight and $M \rightarrow M'$ is 1D-injective, by Lemma 4.3.10, we get that the top-left triangle commutes as well, hence $C \rightarrow M$ is the desired diagonal filler.

Now that we have shown that moves are stable under pushouts of the desired form and that the resulting morphism is cartesian, we proceed to show that it is also the case for arbitrary plays by induction on $\langle P \rangle$.

If $Y \rightarrow P \leftarrow X$ contains zero moves, then the result is obvious. If $Y \rightarrow P \leftarrow X$ contains at least one move, we decompose it as $\langle M \rangle \bullet \langle U \rangle$, for some move $T \rightarrow M \leftarrow X$ and play $Y \rightarrow U \leftarrow T$ containing fewer moves than P .

Because the square below

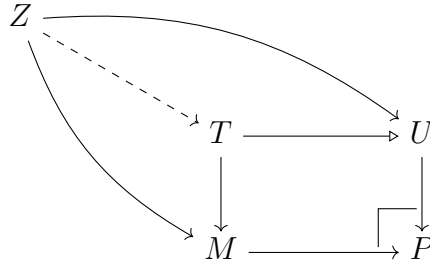

is a pushout along a monomorphism, hence a pullback, we obtain a unique dashed map as shown such that the diagram commutes. Thus, $id_Z^\bullet \rightarrow P$ factors as a vertical composite of two cells $id_Z^\bullet \rightarrow U$ and $id_Z^\bullet \rightarrow M$. By Lemma 4.3.9, the desired pushout (10) is the vertical composite of the following two pushouts:



Since $\langle U' \rangle$ and $\langle M' \rangle$ are plays by induction hypothesis, so is $\langle P' \rangle$. Moreover, by induction hypothesis again, $\langle U \rangle \rightarrow \langle U' \rangle$ and $\langle M \rangle \rightarrow \langle M' \rangle$ are cartesian, and therefore, so is $\langle P \rangle \rightarrow \langle P' \rangle$, by Lemma 4.3.3. ■

4.3.12. REMARK. The morphism $P \rightarrow P'$ thus computed is not opcartesian in general. To see this, consider the signature S_π of the π -calculus, and push the play $P = \langle o_{m,c,d} \rangle$ along $[m] \rightarrow [n]_a |_c [m]$ to get P' . Now, P clearly has a morphism to $\sigma_{n,a,m,c,d}$ (given by $S_\pi(\varepsilon)$), but P' does not, because its final position contains a player of type $[n]$, while the final position of $\sigma_{n,a,m,c,d}$ only contains two players of type $[n+1]$ and $[m]$ respectively.

From seeds to moves The preceding result now allows us to prove our third key intermediate result, namely:

4.3.13. LEMMA. *If seeds admit cartesian restrictions in $\mathbb{D}(\mathbf{S})$, then so do moves.*

PROOF. Consider any move as in (5) and horizontal morphism $h: X' \rightarrow X$. We start by forming the cube

$$\begin{array}{ccccc}
 Z'_0 & \xrightarrow{\quad} & Z' & & \\
 \downarrow & \dashrightarrow & \downarrow & \searrow & \\
 & X'_0 & \xrightarrow{\quad} & X' & \\
 \downarrow & \lrcorner & \downarrow & \downarrow & \\
 Z_0 & \xrightarrow{h_0} & Z & & X \\
 \downarrow & \lrcorner & \downarrow & \searrow & \\
 & X_0 & \xrightarrow{\quad} & X &
 \end{array} \tag{11}$$

where the dashed arrow is obtained by universal property of pullback. By the pullback lemma, the left-hand face is again a pullback. Now, by Lemma 4.3.7, we may assume that $Z_0 \rightarrow X_0$ is monic, so by adhesivity the top face of (11) is again a pushout.

By Lemma 4.3.11, the morphism $\langle \mu \rangle \rightarrow \langle M \rangle$ is cartesian. By hypothesis, we obtain a cartesian lifting of $\langle \mu \rangle$ along h_0 , say $Y'_0 \rightarrow U'_0 \leftarrow X'_0$. We get a morphism $Z'_0 \rightarrow U'_0$ by composing $Z'_0 \rightarrow X'_0$ and $X'_0 \rightarrow U'_0$, and then a morphism $Z'_0 \rightarrow Y'_0$ by universal property of pullback, remembering that, by Lemma 4.1.2, the square

$$\begin{array}{ccc}
 Y'_0 & \xrightarrow{\quad} & Y_0 \\
 \downarrow & \lrcorner & \downarrow \\
 U'_0 & \xrightarrow{\quad} & \mu
 \end{array}$$

is a pullback. We may thus push the obtained lifting along $id_{Z'_0}^\bullet \rightarrow id_{Z'}^\bullet$ to obtain a play $\langle U' \rangle$ and a cartesian morphism $\langle U'_0 \rangle \rightarrow \langle U' \rangle$ by Lemma 4.3.11. It also induces, by universal property of pushout, a morphism $\langle U' \rangle \rightarrow \langle M \rangle$ in $\text{Cospan}(\widehat{\mathbb{C}})_H$ as in

$$\begin{array}{ccccc}
 id_{Z'_0}^\bullet & \xrightarrow{\quad} & id_{Z'}^\bullet & & \\
 \downarrow & \searrow & \downarrow & \searrow & \\
 & \langle U'_0 \rangle & \xrightarrow{\quad} & \langle U' \rangle & \\
 \downarrow & \lrcorner & \downarrow & \downarrow & \\
 id_{Z_0}^\bullet & \xrightarrow{\quad} & id_Z^\bullet & & \langle M \rangle \\
 \downarrow & \lrcorner & \downarrow & \searrow & \\
 & \langle \mu \rangle & \xrightarrow{\quad} & \langle M \rangle &
 \end{array}$$

We want to show that $\langle U' \rangle$ is the cartesian restriction of $\langle M \rangle$ along h . In order to do that, we first need to show that $\langle U' \rangle \rightarrow \langle M \rangle$ is a morphism of plays, i.e., that it belongs to $\mathbb{D}(\mathbb{S})_H$.

Now consider the following cubes:

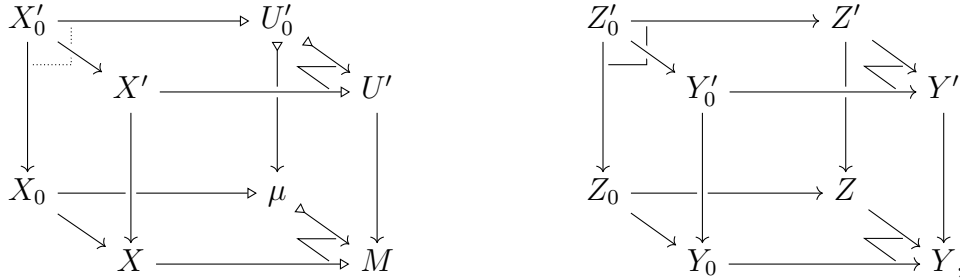

where, in the left-hand case, both pushouts are obtained by the pushout lemma. In the left-hand cube, by pointwise adhesivity and Corollary 3.2.7, we obtain that $U' \rightarrow M$ is 1D-injective and that the front face is a 1D-pullback. In the right-hand cube, Corollary 3.2.7 entails that $Y' \rightarrow Y$ is 1D-injective. This entails in particular that $\langle U' \rangle \rightarrow \langle M \rangle$ indeed is a morphism of plays.

It remains to show that $\langle U' \rangle \rightarrow \langle M \rangle$ is cartesian, for which by Lemma 4.1.2 it is sufficient to show that it has the shape of the front face of (7).

First, the upper square is a pullback by pointwise application of Lemma A.2.1 in

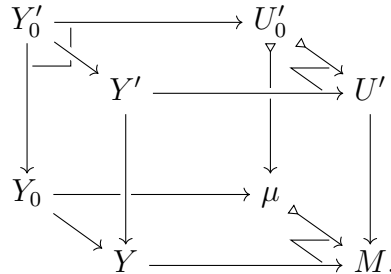

So the only point left to show is that $U' \rightarrow M$ lies in J_S^\perp . To show this, we consider any morphism $T \rightarrow C$ in J_S and commuting square

$$\begin{array}{ccc} T & \longrightarrow & U' \\ \downarrow & & \downarrow \\ C & \longrightarrow & M \end{array}$$

and show that there is a unique diagonal filler. Uniqueness follows from the fact that $U' \rightarrow M$ is 1D-injective and that $C \cong \Sigma_{i_1}(\Delta_{i_1}(C))$, so we only need to show that there exists such a diagonal filler.

First, since $\mu \dashv \rightarrow M$ is an isomorphism in dimensions > 1 and C is a representable of dimension > 1 , we know that $C \rightarrow M$ factors through $\mu \dashv \rightarrow M$ in a unique way. We now want to show that $T \rightarrow U'$ factors through $U'_0 \dashv \rightarrow U'$ in such a way that

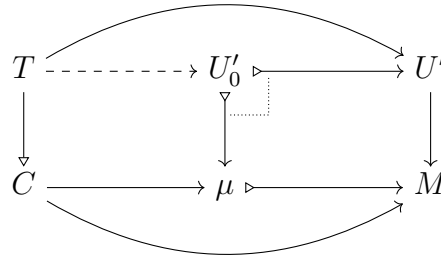

commutes.

Stepping back a little, let us recall a cube considered above, as below left

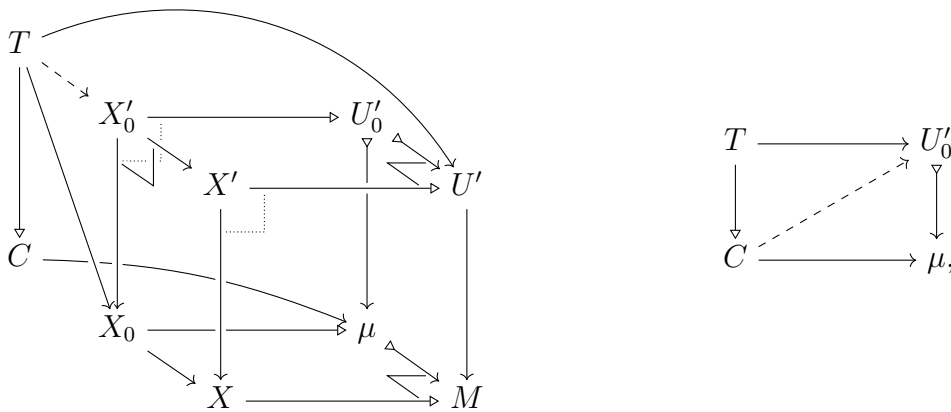

where we added the map $T \rightarrow X_0$ given by $S(C \rightarrow \mu)$. By Lemma 4.2.9 on the front face, using tightness of T , we obtain a unique arrow $T \rightarrow X'$, which further gives by universal property of pullback a unique dashed arrow $T \rightarrow X'_0$ making everything commute. In particular, we obtain a square as the solid part above right by composing the arrow $T \rightarrow X'_0$ we just obtained with $X'_0 \rightarrow U'_0$.

But now $U'_0 \rightarrow \mu$ is in J_S^\perp , so there is a unique dashed diagonal map as shown making both triangles commute, which gives rise to a map $C \rightarrow U'$ by composition, hence the result. ■

From moves to plays Finally, we state and prove our first fibredness result:

4.3.14. THEOREM. *If seeds admit cartesian restrictions in $\mathbb{D}(S)$, then $\mathbb{D}(S)$ is fibred.*

PROOF. Let us consider any play $Y \rightarrow P \leftarrow X$ and show that its cartesian restriction along $X' \rightarrow X$ in $\text{Cospan}_{J_S}(\widehat{\mathbb{C}})$ lies in $\mathbb{D}(S)$, which is enough by Lemma 4.1.4. We proceed by induction on $Y \rightarrow P \leftarrow X$. If it is the composite of 0 moves, then $X \rightarrow P$ and $Y \rightarrow P$ are isomorphisms and the result is obvious. If it is the composite of $n + 1$ moves, then it can be decomposed as $\langle M \rangle \bullet \langle U \rangle$ for some move $T \rightarrow M \leftarrow X$ and play $Y \rightarrow U \leftarrow T$. By Lemma 4.3.13, we know that $\langle M \rangle$ admits a cartesian restriction along $X' \rightarrow X$, say $T' \rightarrow V' \leftarrow X'$. Furthermore, by induction hypothesis, $\langle U \rangle$ admits a cartesian restriction along $T' \rightarrow T$, say $Y' \rightarrow U' \leftarrow T'$. By Lemma 4.3.3, the vertical composition of $\langle V' \rangle \rightarrow \langle M \rangle$ and $\langle U' \rangle \rightarrow \langle U \rangle$ is cartesian, hence the result. ■

4.4. CARTESIAN LIFTING OF SEEDS. In the previous section, we have shown that $\mathbb{D}(\mathbf{S})$ is fibred as soon as seeds admit cartesian restrictions in $\mathbb{D}(\mathbf{S})$. In this section, we exhibit sufficient conditions for the latter to be the case. I.e., possibly under additional hypotheses, in the setting of (7), if $\langle U \rangle$ is a seed, then its restriction $\langle U' \rangle$ is a play and (h, h', h'') is a morphism of plays.

The basic idea of our proof is that there are two possible cases: either X' “contains all of” X , or it does not. In more precise terms, either h is a retraction, or it is not. In both cases, for the given seed μ , we

- first construct a candidate restriction $\langle U' \rangle$,
- prove that it is indeed a play and that the morphism $\langle U' \rangle \rightarrow \langle \mu \rangle$ is a morphism of plays,
- and then finally show that it is a cartesian lifting of $\langle \mu \rangle$ along h by showing that it has the shape of the front face of (7).

The main difference between the two cases is that, in the first one, X can be thought of as a sub-position of X' , so we basically extend μ so that it is played from all of X' . By contrast, in the second case, X' does not contain X , so it is impossible to play μ from it, and the restriction consists of all the “pieces” of μ that can be played from X' .

Restrictions along retractions Let us make a first hypothesis that will be useful for the case where h is a retraction, but also for the other case. It is equivalent to asking that moves never erase channels, in the sense that, if a channel occurs in the initial position of a move, then it also does in its final position. The hypothesis is the following:

4.4.1. DEFINITION. A signature \mathbf{S} is persistent when for any seed $Y \rightarrow M \leftarrow X$, the morphism $Z \rightarrow X$ from its final invariant position is an isomorphism in dimension 0.

4.4.2. EXAMPLE. The signature \mathbf{S}_π of the π -calculus is persistent. Indeed, by tightness of initial positions, it suffices to show that, for all solid parts of the diagram below, the dashed part exists:

$$\begin{array}{ccc}
 [m] & \text{-----} & Y \\
 \uparrow & & \downarrow \\
 * & & M \\
 \downarrow & & \uparrow \\
 [n] & \text{-----} & X,
 \end{array}$$

where $Y \rightarrow M \leftarrow X$ is a seed. For example, let us take the seed $\mathbf{S}_\pi(\sigma_{n,a,m,c,d})$: if the channel $* \rightarrow X$ factors as $* \xrightarrow{s_i} [n] \rightarrow X$, then the dashed part is $* \xrightarrow{s_i} [n+1] \rightarrow Y$; otherwise, $* \rightarrow X$ factors as $* \xrightarrow{s_i} [m] \rightarrow X$, and the dashed part is $* \xrightarrow{s_i} [m] \rightarrow Y$.

A non-persistent signature is any signature that has a move in which a channel is erased, e.g., a move whose graphical depiction is:

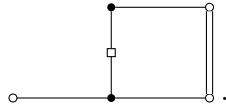

4.4.3. LEMMA. *The seeds of any persistent signature admit cartesian liftings along retractions.*

PROOF. Consider any such signature \mathbf{S} . By Lemma 4.1.3, it is enough to prove that the cartesian lifting in $\mathbf{Cospan}_{J_S}(\widehat{\mathbf{C}})$ lies in $\mathbb{D}(\mathbf{S})$. Consider any seed $Y \rightarrow M \leftarrow X$ and 1D-injective retraction $h: X' \rightarrow X$. Since h is a retraction, there is a section $h': X \rightarrow X'$ such that $hh' = id_X$. We call Z the final invariant position of $Y \rightarrow M \leftarrow X$ and define Z' as the pullback

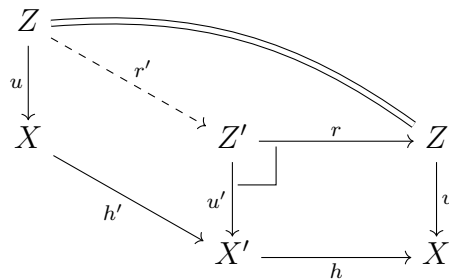

and $r': Z \rightarrow Z'$ by its universal property. As a section, r' is mono, so in particular 1D-injective. We know that u is an isomorphism in dimension 0 by persistence, and so is u' as a pullback of u , which entails by Lemma A.1.1 in the opposite category that the left-hand square above is a pushout in dimension 0. But in dimensions > 0 , h is an isomorphism, hence so are h' and r' (as a pullback of h'), so by the same argument, the left-hand square is also a pushout in dimensions > 0 . It is thus a pushout in all dimensions, hence a pushout in $\widehat{\mathbf{C}}$, since colimits are computed pointwise in presheaf categories.

We define the cospan $\langle M' \rangle$ as the pushout

$$\begin{array}{ccc}
 id_Z^\bullet & \xrightarrow{id_{r'}^\bullet} & id_{Z'}^\bullet \\
 \downarrow & & \downarrow \beta \\
 \langle M \rangle & \xrightarrow{\alpha'} & \langle M' \rangle \\
 & & \downarrow \alpha \\
 & & \langle M \rangle
 \end{array}
 \quad (12)$$

and $\alpha: \langle M' \rangle \rightarrow \langle M \rangle$ by its universal property. Now, if we define $(l, k, \tilde{h}) = \alpha$, $(l', k', \tilde{h}') = \alpha'$, and $(l'', k'', h'') = \beta$, we can assume without loss of generality that $h'' = u'$ and that

$\tilde{h}' = h'$, since both

$$\begin{array}{ccc}
 Z & \xrightarrow{r'} & Z' \\
 \downarrow u & & \downarrow u' \\
 X & \xrightarrow{h'} & X'
 \end{array}
 \quad \text{and} \quad
 \begin{array}{ccc}
 id_Z^\bullet & \xrightarrow{id_{r'}^\bullet} & id_{Z'}^\bullet \\
 \downarrow & & \downarrow \beta \\
 \langle M \rangle & \xrightarrow{\alpha'} & \langle M' \rangle
 \end{array}$$

are pushouts. Similarly, by the pushout lemma, we get that

$$\begin{array}{ccc}
 Z' & \xrightarrow{r} & Z \\
 \downarrow u' & & \downarrow u \\
 X' & \xrightarrow{h} & X
 \end{array}
 \quad \text{and} \quad
 \begin{array}{ccc}
 id_{Z'}^\bullet & \xrightarrow{id_r^\bullet} & id_Z^\bullet \\
 \downarrow \beta & & \downarrow \\
 \langle M' \rangle & \xrightarrow{\alpha} & \langle M \rangle
 \end{array}$$

are pushouts, so we can assume that $\tilde{h} = h$. By Lemma 4.3.11 in the left-hand square of (12), we get that $\langle M' \rangle$ is a play. Now, by Lemma 4.3.11 in the right-hand square, we get that α is cartesian, so $\langle M' \rangle$ is a lifting of $\langle M \rangle$ along h . ■

4.4.4. REMARK. The lemma above shows that, if a signature is persistent, then it admits cartesian liftings along retractions. The converse actually holds. Indeed, consider any signature \mathbf{S} that is not persistent. This means that there is some move m_0 in the base category \mathbb{C} whose seed $\langle M \rangle$ is such that the morphism from the final invariant position Z to X is not an isomorphism in dimension 0. Since that morphism is a monomorphism as the pullback of $Y \rightarrow M$, which is mono, it cannot be an epimorphism in dimension 0 (because all epi monos are isos in \mathbf{Set}). This implies that there is a channel $c: * \rightarrow M$ for some object $*$ of dimension 0 that is in the image of $X \xrightarrow{t} M$, but not in that of $Y \xrightarrow{s} M$.

Let us consider the move $\langle M \rangle$ and try to build its cartesian lifting along $* + X \xrightarrow{[c, X]} X$. If such a cartesian lifting $\langle U' \rangle \rightarrow \langle M \rangle$ exists, because it is cartesian, $id_{\langle M \rangle}$ must factor through it in a unique way, as in

$$\begin{array}{ccccc}
 Y & & & & \\
 \downarrow & \dashrightarrow & & & \\
 M & \xrightarrow{\quad} & Y' & \xrightarrow{\quad} & Y \\
 \uparrow & \dashrightarrow & \downarrow & & \downarrow \\
 X & \xrightarrow{\quad} & U' & \xrightarrow{\quad} & M \\
 & \searrow & \uparrow & & \uparrow \\
 & & * + X & \xrightarrow{\quad} & X
 \end{array}$$

Therefore, $U' \rightarrow M$ must be a retraction, but it is also 1D-injective so it is bijective in dimensions > 0 . In particular, $U'(m)$ is isomorphic to $M(m)$ for all moves m . Now, since U' must be isomorphic to m_0 in dimensions > 0 , it is necessarily the composite of a single m_0 move. But the only way to play m_0 from $* + X$ is to be isomorphic to

$* + Y \xrightarrow{**s} * + M \xleftarrow{**t} * + X$. So we want to find a pair of morphisms as the dashed arrows above when the front face has the form:

$$\begin{array}{ccc}
 * + Y & \xrightarrow{[g,g']} & Y \\
 \downarrow **s & & \downarrow s \\
 * + M & \xrightarrow{[f,f']} & M \\
 \uparrow **t & & \uparrow t \\
 * + X & \xrightarrow{[c,X]} & X.
 \end{array}$$

In particular, it must be that $tc = f = sg$. But we chose c such that tc is not in the image of s , so this is impossible, hence $\langle M \rangle$ has no cartesian lifting along $[c, X]$.

Restrictions along non-retractions When h is not a retraction, we need some more hypotheses to construct restrictions (and ensure that they are indeed cartesian). We will need three hypotheses. The first one, *monolithicity*, restricts the possible ways to model interactions between players. It is not necessary, but makes proofs much simpler. The second one, *fragmentation*, forces all interactions to have restrictions to single players. This condition is necessary for seeds to admit cartesian restrictions (otherwise, the seed corresponding to an interaction could be restricted along one of the players). The last condition, *separation*, states that, if a player is created by an interaction, then it is the avatar of a single one of the players involved in that interaction. This is related to the notion of view: to define the view of the created player, we take the view of the player it was created by. This condition is also necessary, otherwise a player created during an interaction could end up being created multiple times in a restriction, which would break 1D-injectivity.

First, we want to limit the possible interactions between moves:

4.4.5. DEFINITION. A signature is monolithic when for all morphisms of plays $\alpha: (Y \rightarrow M \leftarrow X) \rightarrow (Y' \rightarrow M' \leftarrow X')$ between any two seeds, if X is not a representable, then $M = M'$.

A signature is monolithic roughly when restricting a move $Y' \rightarrow M' \leftarrow X'$ describing an interaction to a strict sub-position X of X' cannot yield an interaction. In other words, interactions cannot be broken down into smaller interactions (e.g., an interaction between three players cannot be broken down into an interaction between only two of them). Though it is possible to relax this limitation, this would not only induce an explosion of the number of cases to analyse, but we would also need to put another kind of restriction, which would more difficult to check, which is why we decided to stick to a simple case. Moreover, such “partial interactions” do not appear to bring much expressiveness to our framework.

4.4.6. REMARK. Since the base category is direct, monolithicity ensures that, if there is a morphism α between seeds as above, and X is not a representable, then $\alpha = (id_Y, id_M, id_X)$.

4.4.7. **EXAMPLE.** The signature S_π of the π -calculus is monolithic. Indeed, since all seeds except $\sigma_{n,a,m,c,d}$ have representables as their initial positions, if $\alpha: (Y \rightarrow M \leftarrow X) \rightarrow (Y' \rightarrow M' \leftarrow X')$ is a morphism of plays between seeds and X is not a representable, then $(Y \rightarrow M \leftarrow X) = S_\pi(\sigma_{n,a,m,c,d})$, so in particular $M = y_{\sigma_{n,a,m,c,d}}$. We conclude by noticing that the only morphism in \mathbb{C} with domain $\sigma_{n,a,m,c,d}$ is the identity thereon, and thus $M' = M$.

To give an example of non-monolithic signature, let us consider a π -calculus whose output primitive broadcasts the name of a channel on another channel, i.e., more than one player may receive that name. This could be modelled by the same base category as that of our π -calculus, except that the synchronisation moves would be $\sigma_{[(n_i,a_i)]_{i \in k},m,c,d}$ with a list of receivers and a single sender. We give a graphical depiction of the initial and final positions of $\sigma_{[(1,1),(2,1)],3,1,2}$ (a player of arity 3 broadcasting the name of its second channel on its first one, received by two players of respective arities 1 and 2, both on their first channels) below:

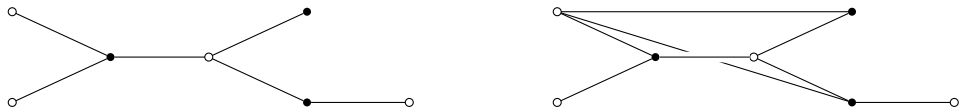

There are two natural choices for morphisms in the base category \mathbb{C} : either include $\sigma_{L,m,c,d}$ into $\sigma_{L',m,c,d}$ when L is a sublist of L' up to permutation, or not (and only include $\iota_{n,a}$ and $o_{m,c,d}$'s in $\sigma_{L,m,c,d}$). The first choice leads to a non-monolithic signature, e.g., because there is a morphism of plays $S(\sigma_{[(n,a)],m,c,d}) \rightarrow S(\sigma_{[(n,a),(n',a')],m,c,d})$ and the initial position of the former is not a representable (it contains two players). The second choice actually leads to a monolithic signature, so it is unclear what expressive power non-monolithicity gives in concrete examples.

A second hypothesis that we make says that there should exist a “biggest part” of any move from the point of view of any player involved in it. Basically, we want to ensure that any seed $Y \rightarrow \mu \leftarrow X$ has restrictions along all morphisms of positions $h: X' \rightarrow X$, and we prove this property by pasting together the “biggest part” of what each player in X' sees of μ when restricted along h . We here give a notion that entails the desired property, and basically amounts to asking that seeds admit cartesian restrictions along morphisms of the form $y_d \rightarrow X$ with respect to other seeds (as opposed to arbitrary plays):

4.4.8. **DEFINITION.** A signature is fragmented if and only if for all seeds $Y \xrightarrow{s} M \xleftarrow{t} X$ and players $x: d \rightarrow X$, there exists a seed $Y_{M,x} \xrightarrow{s_{M,x}} M_{|x} \xleftarrow{t_{M,x}} d$ and a morphism $f_{M,x}: M_{|x} \rightarrow M$ in \mathbb{C} such that:

- (a) the top square of $S(f_{M,x})$ is a pullback, and
- (b) for any seed $Y'' \rightarrow M'' \leftarrow X''$ and commuting diagram as the solid part below, there

is a map $M'' \rightarrow M_{|x}$ making the diagram commute.

$$\begin{array}{ccccc}
 & & M'' & & \\
 & & \swarrow & & \\
 & X'' & \xrightarrow{\quad} & M_{|x} & \xrightarrow{f_{M,x}} & M \\
 & \swarrow & & \uparrow & & \uparrow \\
 & & d & \longrightarrow & X
 \end{array} \tag{13}$$

4.4.9. REMARK. Since $f_{M,x}$ is 1D-injective and M'' is a representable of dimension > 1 , the morphism $M'' \rightarrow M_{|x}$ in the hypothesis above is necessarily unique.

4.4.10. EXAMPLE. The signature S_π of the π -calculus is fragmented. Indeed, if the intimal position X is a representable, then taking $M_{|x} = M$ defines the desired restriction, so the only case left is that of $\sigma_{n,a,m,c,d}$. There are two morphisms $d \rightarrow X$: $l: [n] \rightarrow X$ and $r: [m] \rightarrow X$, and $\iota_{n,a}$ and $o_{m,c,d}$ define the desired restrictions.

There are typically two ways to get a non-fragmented signature. There may be no candidates $M_{|x}$: this happens for example in the base category for the π -calculus without moves of the form $\iota_{n,a}$ and $o_{m,c,d}$. The other case is when $M_{|x}$ does not verify (b). For this case, consider a π -calculus in which a process can broadcast a channel name on all of its other channels. The initial and final positions of such a move could be depicted as below (for a ternary player broadcasting and a unary and a binary players receiving):



There are two natural ways to model this on the side of the sender: either by having a move that simultaneously models the broadcasting to all channels, or by having one $o_{n,a,b}$ move for each receiver. In the first case, the signature is fragmented: the synchronisation restricts to the sender as the single broadcasting move. In the second case, the signature is not fragmented: all $o_{n,a,b}$ moves are candidates for $M_{|x}$, but none of them verifies (b) (simply take $M'' = o_{n,a',b}$ for $a' \neq a$).

4.4.11. LEMMA. If the signature S is persistent, monolithic, and fragmented, then each morphism $S(f_{M,x})$ is a cartesian lifting of $\langle M \rangle$ along x in $\mathbb{D}(S)$.

This will rely on:

4.4.12. COROLLARY. For any seeds $Y \rightarrow M \leftarrow X$ and $S \rightarrow C \leftarrow T$, any commuting diagram as the solid part of

$$\begin{array}{ccccc}
 T & \xrightarrow{\quad} & U & \longrightarrow & X \\
 \downarrow & \searrow & \downarrow & \dashrightarrow & \downarrow \\
 C & & V & \longrightarrow & M
 \end{array}$$

(Note: A curved arrow also connects C to M, and a dashed line connects U to V.)

with the marked 1D-pullback, such that at least one of $U \rightarrow X$ and $U \rightarrow V$ is monic, may be completed as shown.

PROOF. Because M is a seed, the bottom square of $\mathbf{S}(C \rightarrow M)$ yields a morphism $T \rightarrow X$ making the diagram commute. We conclude by Lemma 4.2.8. ■

PROOF OF LEMMA 4.4.11. By Lemma 4.1.2, it is enough to prove that the top square of $\mathbf{S}(f_{M,x})$ is a pullback and that $f_{M,x}$ in J_S^\perp . The first point holds by (a). To prove the second one, consider any morphism $T \rightarrow C$ in J_S and commuting square

$$\begin{array}{ccc} T & \longrightarrow & M|_x \\ \downarrow & & \downarrow f_{M,x} \\ C & \longrightarrow & M. \end{array}$$

We need to show that there is a unique diagonal filler $C \rightarrow M|_x$. By Corollary 4.4.12, we obtain a unique morphism $T \rightarrow d$ making the diagram below left commute:

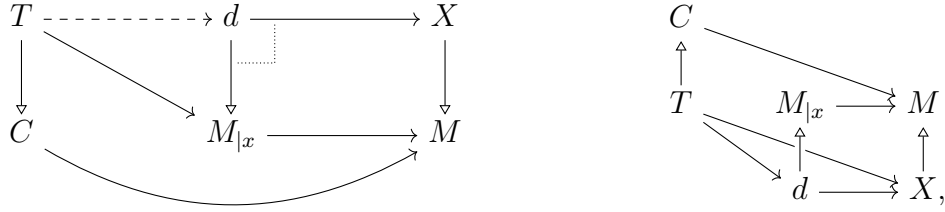

which may be arranged as on the right to have the shape of (13). We thus conclude by (b). ■

Lemma 4.4.11 exhibits cartesian liftings along players $d \rightarrow X$. Let us now consider more general cases, assuming a third property saying that each player involved in a *synchronisation* M (i.e., a seed whose initial position contains several players) is related to at most one of the “biggest parts” of M , in the sense of our above explanation of fragmentedness.

4.4.13. DEFINITION. A signature S is separated if it is fragmented and, for all moves $\mu \in \text{ob}(\mathbb{C}_{|\geq 2})$ with seed $\mathbf{S}(\mu) = (Y \rightarrow \mu \leftarrow X)$, players $d \in \text{ob}(\mathbb{C}_{|1})$, $x_1: d_1 \rightarrow X$ and $x_2: d_2 \rightarrow X$, and $y_1: d \rightarrow \mu|_{x_1}$ and $y_2: d \rightarrow \mu|_{x_2}$ making

$$\begin{array}{ccc} d & \xrightarrow{y_1} & \mu|_{x_1} \\ y_2 \downarrow & & \downarrow f_{\mu,x_1} \\ \mu|_{x_2} & \xrightarrow{f_{\mu,x_2}} & \mu \end{array}$$

commute, we have $x_1 = x_2$ (and hence $f_{\mu,x_1} = f_{\mu,x_2}$).

4.4.14. **REMARK.** Separation really only says something in the case where the diagonal $x: d \rightarrow \mu$ does not factor through X . Indeed, if it does, then by the properties of 1D-pullbacks, x also factors through x_1 and x_2 , hence by directedness of \mathbb{C} is in fact equal to x_1 and x_2 .

4.4.15. **REMARK.** Separation is related to the notion of *view* in game semantics (and indeed, in many of the cases we are interested in, separation is derived from what is called the axiom of views in [18]). It basically states that any player that is created in a move M is created by at most one player.

4.4.16. **EXAMPLE.** The signature S_π of the π -calculus is separated. Indeed, if the initial position X of μ is a representable, then there is only one morphism $x: d \rightarrow X$, so necessarily $x_1 = x_2$. Therefore, $\mu|_{x_1} = \mu|_{x_2}$, and for any diagram

$$\begin{array}{ccc}
 d & \begin{array}{c} \xrightarrow{y_1} \\ \xrightarrow{y_2} \end{array} & \mu|_{x_i} \\
 & & \xrightarrow{f_{\mu, x_i}} \mu,
 \end{array}$$

we conclude by 1D-injectivity of f_{μ, x_i} . The only non-trivial case is thus that of $\sigma_{n,a,m,c,d}$. So let us take $x_i: d_i \rightarrow X$ for $i \in \{1, 2\}$, with $x_1 \neq x_2$, we can assume without loss of generality that x_1 picks the player of arity n and x_2 that of arity m . But then $\sigma_{n,a,m,c,d}|_{x_1}$ is $\iota_{n,a}$ and $\sigma_{n,a,m,c,d}|_{x_2}$ is $o_{m,c,d}$, and there is no commuting diagram of the form

$$\begin{array}{ccc}
 d & \xrightarrow{y_1} & \sigma_{n,a,m,c,d}|_{x_1} \\
 y_2 \downarrow & & \downarrow f_{\sigma_{n,a,m,c,d}, x_1} \\
 \sigma_{n,a,m,c,d}|_{x_2} & \xrightarrow{f_{\sigma_{n,a,m,c,d}, x_2}} & \sigma_{n,a,m,c,d}
 \end{array}$$

hence the result.

To get an example of non-separated signature, imagine a calculus in which two processes who know of exactly the same channels may “fuse” into a new process, according to a rule such as $P, Q \rightarrow P + Q$. A natural way to model such a move is to have a move f whose graphical depiction is:

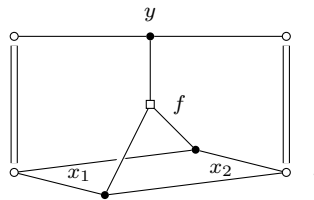

and two sub-moves f_l and f_r , respectively corresponding to its restrictions to x_1 and x_2 . Since the move is completely symmetric in P and Q , y should naturally be either in both restrictions or in none. Intuitively, this new player should “remember” everything x_1 and x_2 knew, which means that its view, in game semantical terms, should contain both those

of x_1 and x_2 . In the framework of fibred pseudo double categories, this translates to y being both in f_l and f_r , which makes the signature non-separated.

We have now introduced the three hypotheses we will need to build the restriction of a seed along a morphism h that is not a retraction. In this case, the restriction of a seed along h has a particular form that we call a *quasi-move*, which basically consists of several moves played “in parallel”, i.e., independently from one another.

4.4.17. DEFINITION. A quasi-move is any cospan that is isomorphic to a pushout of the form

$$\begin{array}{ccc} \sum_{i \in n} id_{Z_i}^\bullet & \xrightarrow{id_h^\bullet} & id_Z^\bullet \\ \downarrow & & \downarrow \\ \sum_{i \in n} \langle M_i \rangle & \longrightarrow & \langle U \rangle, \end{array}$$

in $\mathbb{D}^0(\mathbb{C})_H$, where the $\langle M_i \rangle$'s are seeds.

4.4.18. EXAMPLE. In $\mathbb{D}(\mathbf{S}_\pi)$, the play depicted on the left below is a quasi-move, while the play depicted on the right is not.

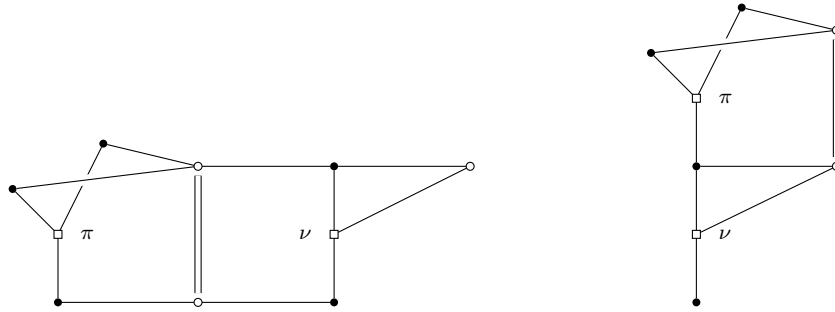

Indeed, the first one can be defined as the pushout

$$\begin{array}{ccc} id_*^\bullet + id_*^\bullet & \longrightarrow & id_*^\bullet \\ \downarrow & & \downarrow \\ \pi_1 + \nu_1 & \longrightarrow & \langle U \rangle. \end{array}$$

However, the second play cannot be expressed as a similar pushout. Indeed, if it were a quasi-move, it should at least contain π_1 , whose final invariant position is non-empty, so the final invariant position of the whole quasi-move would also be non-empty, but this play has an empty final invariant position.

4.4.19. LEMMA. Every quasi-move is a play.

PROOF. Let $\langle M_i \rangle = (Y_i \xrightarrow{s_i} M_i \xleftarrow{t_i} X_i)$ for all $i \in n$. By Lemma 4.3.11, it is enough to show that $\sum_i \langle M_i \rangle$ is a play. We proceed by induction on n . If $n = 0$, the result is trivial. Otherwise, we have

$$\sum_i \langle M_i \rangle \cong (\langle M_1 \rangle + \sum_{i>1} id_{X_i}^\bullet) \bullet (id_{Y_1}^\bullet + \sum_{i>1} \langle M_i \rangle).$$

By induction hypothesis, both components are plays, so by Lemma 4.3.9, the composite also is. ■

We can now exhibit the construction of the restriction of a seed $Y \xrightarrow{s} M \xleftarrow{t} X$ along a morphism $h: X' \rightarrow X$ that is not a retraction.

4.4.20. THEOREM. *The seeds of any persistent, monolithic, and separated signature \mathbb{S} admit cartesian liftings in $\mathbb{D}(\mathbb{S})$.*

PROOF. By Lemma 4.4.3, it is enough to deal with the case where h is not a retraction. We first build the candidate restriction. Let Z be the final invariant position of $\langle M \rangle$. By fragmentedness, we know that for each player $(d, x) \in \text{pl}(X)$, there exists a seed $Y_{M,x} \xrightarrow{s_{M,x}} M|_x \xleftarrow{t_{M,x}} d$ and a morphism $(l_{M,x}, f_{M,x}, x): \langle M|_x \rangle \rightarrow \langle M \rangle$ satisfying (a) and (b) of Definition 4.4.8. Letting $Z' = X' \times_X Z$, for any player $(d, x) \in \text{pl}(X')$ we may thus construct by universal property of pullback a map $r_{M,x}$ as in

(14)

where $Z_{M,hx} \rightarrow Z$ comes from the universal property of Z . We first want to show that

$$\begin{array}{ccc} \sum_{(d,x) \in \text{pl}(X')} Z_{M,hx} & \xrightarrow{[r_{M,x}]_{(d,x) \in \text{pl}(X')}} & Z' \\ \downarrow & & \downarrow \\ \sum_{(d,x) \in \text{pl}(X')} d & \xrightarrow{[x]_{(d,x) \in \text{pl}(X')}} & X' \end{array} \tag{15}$$

is a pushout and that all involved maps are 1D-injective. First, it is a pullback: by Lemma A.1.2, it suffices to show $Z_{M,hx} = d \times_{X'} Z'$ for each x , which follows by three consecutive applications of the pullback lemma in (14). Because it is a pullback of two 1D-injective maps, all of its maps are in fact 1D-injective. But then, recalling that the pullback of any isomorphism is in fact a pushout square, we have:

- in dimension 1, $\sum_{(d,x) \in \text{pl}(X')} d \rightarrow X'$ is an isomorphism and

- in dimension 0, $Z' \rightarrow X'$ is an isomorphism by persistence,

so the square is a pushout in all dimensions, hence a proper pushout.

We now define our candidate restriction $\langle U' \rangle$ as the quasi-move below, and $\langle U' \rangle \rightarrow \langle M \rangle$ by its universal property:

$$\begin{array}{ccccc}
 \sum_{(d,x) \in \text{pl}(X')} id_{Z'_{M,hx}}^\bullet & \xrightarrow{id_{[r_{M,x}]_{(d,x) \in \text{pl}(X')}}^\bullet} & id_{Z'}^\bullet & \xrightarrow{id_r^\bullet} & id_Z^\bullet \\
 \downarrow & & \downarrow & & \downarrow \\
 \sum_{(d,x) \in \text{pl}(X')} \langle M|_{hx} \rangle & \xrightarrow{(l',k',h')} & \langle U' \rangle & \xrightarrow{(l,k,\tilde{h})} & \langle M \rangle \\
 & \searrow [S(f_{M,hx})]_{(d,x) \in \text{pl}(X')} & & & \\
 & & & &
 \end{array}$$

First, $\langle U' \rangle$ is a quasi-move, and therefore a play by Lemma 4.4.19. Moreover, because (15) is a pushout, we can assume without loss of generality that it is the bottom square of the pushout defining $\langle U' \rangle$. Thus, $\tilde{h} = h$.

Furthermore, the morphism $[S(f_{M,hx})]_{(d,x) \in \text{pl}(X')}$ is in $\mathbb{D}(\mathbf{S})_H$. Indeed, that its bottom square is a 1D-pullback follows from Lemma A.1.2; 1D-injectivity of its bottom component is 1D-injectivity of $h \circ [x]_{(d,x) \in \text{pl}(X')}$; 1D-injectivity of its top component follows from that of its middle component. So let us consider an object c of dimension > 0 and two morphisms $f_1, f_2: c \rightarrow \sum_{(d,x) \in \text{pl}(X')} M|_{hx}$ that are equal when composed with $[f_{M,hx}]_{(d,x) \in \text{pl}(X')}$. Since c is a representable, f_1 and f_2 must factor through one of the coproduct injections, so $f_i = \text{inj}_{(d_i,x_i)} \circ f'_i$ for some $f'_1: c \rightarrow M|_{hx_1}$ and $f'_2: c \rightarrow M|_{hx_2}$. We thus have a commuting diagram

$$\begin{array}{ccc}
 c & \xrightarrow{f'_2} & M|_{hx_2} \\
 f'_1 \downarrow & & \downarrow f_{M,hx_2} \\
 M|_{hx_1} & \xrightarrow{f_{M,hx_1}} & M.
 \end{array}$$

We want to exhibit a square as above but with an object d of dimension 1 instead of c . If c is of dimension 1, we take $d = c$. Otherwise, by monolithicity, we know that $\mathbf{S}(c)$ must have a representable as its initial position, and since all initial positions must be tight, it must be a representable of dimension 1. We thus get a morphism $x: d \rightarrow c$ for some object d of dimension 1. We can now compose the diagram above with that morphism, which gives us a diagram on which we may apply the property of separation, which gives

us that $hx_1 = hx_2$. Now,

$$\begin{aligned} f_{M,hx_1} f'_1 &= [f_{M,hx}]_{(d,x) \in \text{pl}(X')} \text{inj}_{(d_1,x_1)} f'_1 \\ &= [f_{M,hx}]_{(d,x) \in \text{pl}(X')} f_1 \\ &= [f_{M,hx}]_{(d,x) \in \text{pl}(X')} f_2 \\ &= [f_{M,hx}]_{(d,x) \in \text{pl}(X')} \text{inj}_{(d_2,x_2)} f'_2 \\ &= f_{M,hx_2} f'_2 \\ &= f_{M,hx_1} f'_2. \end{aligned}$$

Therefore, since f_{M,hx_1} is 1D-injective and $c \cong \sum_{i_1} (\Delta_{i_1}(c))$, we have that $f'_1 = f'_2$ by Proposition 4.2.6, hence $f_1 = f_2$, so $[f_{M,x}]_{(d,x) \in \text{pl}(X')}$ is indeed 1D-injective.

We now want to show that the morphism $(l, k, h): \langle U' \rangle \rightarrow \langle M \rangle$ is in $\mathbb{D}(\mathbf{S})_H$, i.e., that all its components are 1D-injective. We know that $[r_{M,x}]_{(d,x) \in \text{pl}(X')}$ is bijective in dimensions > 0 , as the pullback of $[x]_{(d,x) \in \text{pl}(X')}$, which is by construction. Thus, the components of the map (l', k', h') are bijective in dimensions > 0 , which entails that $\langle U' \rangle \rightarrow \langle M \rangle$ is in $\mathbb{D}(\mathbf{S})_H$.

Finally, let us prove that $\langle U' \rangle$ is the restriction of $\langle M \rangle$ along h . To this end, let us first prove that k is in J_S^\perp : consider any $T \rightarrow C$ in J_S and commuting square

$$\begin{array}{ccc} T & \longrightarrow & U' \\ \downarrow & & \downarrow \\ C & \longrightarrow & M. \end{array}$$

By Corollary 4.4.12, we get a dashed map as in

$$\begin{array}{ccccc} T & \dashrightarrow & X' & \longrightarrow & X \\ \downarrow & \searrow & \downarrow & \dashrightarrow & \downarrow \\ C & & U' & \longrightarrow & M, \end{array}$$

which makes the diagram commute. If C were equal to M , then, since \mathbb{C} is direct, $C \rightarrow M$ would be an identity, and so would $T \rightarrow X$ by Lemma 3.2.12, which contradicts the hypothesis that h is not a retraction. Thus, C is different from M . Therefore, by monolithicity, we know that T is representable, and of dimension 1 by tightness. Hence, $T \rightarrow X'$ factors as $T = d_0 \rightarrow \sum_{(d,x) \in \text{pl}(X')} d \rightarrow X'$. We thus have the solid part of:

$$\begin{array}{ccccccc} T & \xlongequal{\quad} & d_0 & \xrightarrow{\text{inj}_{(d_0,x_0)}} & \sum_{(d,x) \in \text{pl}(X')} d & \xrightarrow{h'} & X' & \xrightarrow{h} & X \\ \downarrow & & \downarrow & & \downarrow & & \downarrow & & \downarrow \\ C & \dashrightarrow & M|_{hx_0} & \xrightarrow{\text{inj}_{(d_0,x_0)}} & \sum_{(d,x) \in \text{pl}(X')} M|_{hx} & \xrightarrow{k'} & U' & \xrightarrow{k} & M, \end{array} \tag{16}$$

which we can reorganise as the solid part of:

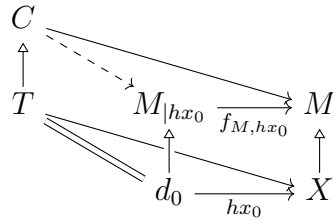

on which we can use fragmentedness to get a dashed map making both diagrams commute. Since (16) commutes, it is obvious that $C \rightarrow U'$ obtained as the composite $C \rightarrow M|_{hx_0} \rightarrow U'$ is a desired diagonal filler. Uniqueness of $C \rightarrow U'$ is given by Proposition 4.2.6, since k is 1D-injective, and $C \cong \sum_{i_1} (\Delta_{i_1}(C))$.

Lastly, we prove that the right-hand square below is a pullback:

$$\begin{array}{ccccc}
 Z' + \sum_{(d,x) \in \text{pl}(X')} Y_{M,hx} & \longrightarrow & Y' & \longrightarrow & Y \\
 \downarrow & & \downarrow & & \downarrow \\
 Z' + \sum_{(d,x) \in \text{pl}(X')} M|_{hx} & \longrightarrow & U' & \longrightarrow & M.
 \end{array} \tag{17}$$

By Lemma A.1.2, the outer square is a pullback because each of the squares below left (by fragmentedness) and the square below right (by Lemma A.1.1) are:

$$\begin{array}{ccc}
 Y_{M,x} & \longrightarrow & Y \\
 \downarrow & & \downarrow \\
 M|_x & \longrightarrow & M
 \end{array}
 \qquad
 \begin{array}{ccc}
 Z' & \longrightarrow & Y \\
 \parallel & & \downarrow \\
 Z' & \longrightarrow & M.
 \end{array}$$

Moreover, the left-hand square in (17) is also a pullback by Lemmas A.1.1, 4.3.11 (because we know that the top squares of cartesian liftings are pullbacks), and A.1.2. Since $Z' + \sum_{(d,x) \in \text{pl}(X')} M|_x \rightarrow U'$ is epi, Lemma A.1.3 entails that the desired square is a pullback. ■

4.4.21. COROLLARY. *For any persistent, monolithic, and separated signature \mathbb{S} , $\mathbb{D}(\mathbb{S})$ is fibred.*

PROOF. By Theorem 4.4.20 seeds admit cartesian restrictions, so the result follows by Theorem 4.3.14. ■

As an easy application, we get:

4.4.22. PROPOSITION. $\mathbb{D}(\mathbb{S}_\pi)$ is fibred.

PROOF. By Corollary 4.4.21, it suffices to verify that \mathbb{S}_π is persistent, monolithic, and separated, which is routine. ■

5. Conclusion

We have introduced a notion of signature for the sheaf-based approach to concurrent game semantics [18, 9]. We have shown how to, from such a signature, automatically build a pseudo double category of concurrent traces, which we interpret as plays in some sort of game. Finally, we have introduced the notion of fibredness, which allows us to build categories of plays from our pseudo double categories, and given two criteria to prove that a pseudo double category is fibred, one necessary and sufficient, the other simpler but only sufficient. The second criterion is still general enough to show that many interesting calculi yield fibred pseudo double categories, as illustrated by the example of the π -calculus, which can also be adapted to recover this property for previous constructions for CCS and HON games.

The link between the pseudo double category we construct and games is further explored in [8], where we build a signature for HON games and investigate the link between the categories of plays we obtain and more traditional categories of plays.

Unfortunately, there are constructions that we would like to be able to do but that do not fit in this framework. One limitation of this framework is that moves are defined as pushouts along any (1D-injective) map, but for some calculi, we would like to be able to restrict the class of morphisms along which we are allowed to push. For example, in a π -calculus with match and mismatch operators, there would be a move $\varepsilon_{n,a,b}$ that may only be played when channels a and b are equal, and a move $\delta_{n,a,b}$ that may only be played when a and b are different. The first move is not difficult to define, we simply add morphisms $s, t: [n] \rightarrow \varepsilon_{n,a,b}$, quotient maps by $ss_i = ts_i$ and $ts_a = ts_b$, and define its seed to be $[n]_{a=b} \xrightarrow{s'} \varepsilon_{n,a,b} \xleftarrow{t'} [n]_{a=b}$, where $[n]_{a=b}$ is the representable $[n]$ whose channels a and b have been identified, or, more formally, the coequaliser of

$$2 \cdot * \begin{array}{c} \xrightarrow{s_a} \\ \xrightarrow{s_b} \end{array} \rightrightarrows [n]$$

and s' and t' are given by universal property of coequaliser applied to s and t respectively. This is not perfect however, in the sense that the obtained signature is not fragmented. The clean solution to overcome this problem is to define another move $\varepsilon_{n,a,b}^0$, with morphisms $s, t: [n] \rightarrow \varepsilon_{n,a,b}^0$ and $\partial: \varepsilon_{n,a,b}^0 \rightarrow \varepsilon_{n,a,b}$ satisfying the obvious equations, and define its seed as $[n] \xrightarrow{s} \varepsilon_{n,a,b}^0 \xleftarrow{t} [n]$. Finally, there would be a special kind of plays (called *closed-world plays*) that do not contain any move built from $\varepsilon_{n,a,b}^0$.

However, defining $\delta_{n,a,b}$ is trickier. Indeed, the only restriction to be able to play this move is that a and b should be different. So we should model it as an object $\delta_{n,a,b}$ with maps $s, t: [n] \rightarrow \delta_{n,a,b}$, with the morphisms in \mathbb{C} quotiented by $ss_i = ts_i$, and define its seed to be $[n] \xrightarrow{s} \delta_{n,a,b} \xleftarrow{t} [n]$. However, since we are allowed to push along any morphism, nothing prevents us from building the move

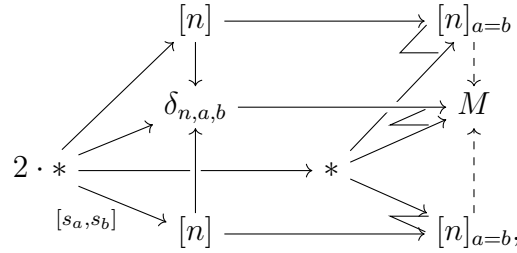

which is a move $\delta_{n,a,b}$ played by a player whose a and b channels are equal, exactly what we wanted to avoid! So, in this case, we would want to be able to push this move only along those morphisms that do not identify a and b . The only solution here is to allow only plays in which all moves m over $\delta_{n,a,b}$ are such that $m \cdot (ts_a) \neq m \cdot (ts_b)$ in closed-world plays. This is much more difficult in the sense that we are refusing plays based on the morphisms along which we push seeds, rather than simply forbidding some moves.

Another example where we do not want to be able to push along any morphism is that of HON games. Let us take the following position as a concrete example:

$$\xrightarrow{A} \underset{\bullet}{x} \xrightarrow{B} \underset{\bullet}{y} \xrightarrow{C} .$$

It consists of two players, x on the left and y on the right. The basic idea is that there are three kinds of moves in our calculus for HON games: Λ and $@$, which correspond to Opponent and Proponent moves, and β , which corresponds to the synchronisation of both moves. The Λ and $@$ moves should correspond to interacting with the environment, while the β moves should correspond to internal moves. Therefore, even though y is able to play $@$ on its own (by interacting with the environment), it should not be able to play it in the position drawn above, because such a move should be internal, and thus synchronised with a Λ move by x .

Moreover, the persistence property, which is necessary for our construction to admit restrictions along retractions, is sometimes too restrictive. Indeed, in the variant of HON games we define in [8], the notion of *view* differs from the notion of view that was given in previous models of CCS and the π -calculus based on the same techniques [18, 9]. In order to recover the standard notion of view, one would need to add a new move to the base category, together with a seed that does not verify persistence.

Some possible future work on this framework would thus be to generalise it to accept some or all of the examples above.

References

- [1] Samson Abramsky, Radha Jagadeesan, and Pasquale Malacaria. Full abstraction for PCF. *Information and Computation*, 163(2):409–470, 2000.
- [2] Gérard Berry and Gérard Boudol. The chemical abstract machine. In *Proc. 17th International Symposium on Principles of Programming Languages*, pages 81–94, 1990.

- [3] Aldridge K. Bousfield. Constructions of factorization systems in categories. *Journal of Pure and Applied Algebra*, 9(2-3):287–329, 1977.
- [4] Aurelio Carboni, Stephen Lack, and Robert F. C. Walters. Introduction to extensive and distributive categories. *Journal of Pure and Applied Algebra*, 84(2), 1993.
- [5] Simon Castellán, Pierre Clairambault, and Glynn Winskel. The parallel intensionally fully abstract games model of PCF. In *LICS*. IEEE, 2015.
- [6] Clovis Eberhart and Tom Hirschowitz. Presheaves for Processes and Unfoldings. <http://www.lama.univ-savoie.fr/~eberhart/ProcUnfold.pdf>, 2015. Online extended abstract for a talk at CALCO Early Ideas.
- [7] Clovis Eberhart and Tom Hirschowitz. Justified sequences in string diagrams: a comparison between two approaches to concurrent game semantics. Preprint, 2016.
- [8] Clovis Eberhart and Tom Hirschowitz. Justified sequences in string diagrams: a comparison between two approaches to concurrent game semantics. In Filippo Bonchi and Barbara König, editors, *Proc. 7th International Conference on Algebra and Coalgebra in Computer Science*, volume 72 of *LIPICs*, pages 10:1–10:16. Schloss Dagstuhl - Leibniz-Zentrum fuer Informatik, 2017.
- [9] Clovis Eberhart, Tom Hirschowitz, and Thomas Seiller. An intensionally fully-abstract sheaf model for π (expanded version). *Logical Methods in Computer Science*, 13(4), 2017.
- [10] Charles Ehresmann. Catégories structurées. *Annales scientifiques de l’Ecole Normale Supérieure*, 80(4):349–426, 1963.
- [11] Charles Ehresmann. *Catégories et structures*. Dunod, 1965.
- [12] P. J. Freyd and G. M. Kelly. Categories of continuous functors, I. *Journal of Pure and Applied Algebra*, 2:169–191, 1972.
- [13] Richard H. G. Garner. *Polycategories*. PhD thesis, University of Cambridge, 2006.
- [14] Richard H. G. Garner. A homotopy-theoretic universal property of Leinster’s operad for weak ω -categories. *Math. Proc. Camb. Phil. Soc.*, 147:615–628, 2009.
- [15] Marco Grandis and Robert Paré. Limits in double categories. *Cahiers de Topologie et Géométrie Différentielle Catégoriques*, 40(3):162–220, 1999.
- [16] Marco Grandis and Robert Paré. Adjoints for double categories. *Cahiers de Topologie et Géométrie Différentielle Catégoriques*, 45(3):193–240, 2004.
- [17] Marco Grandis and Robert Paré. Kan extensions in double categories (On weak double categories, Part III). *Theory and Applications of Categories*, 20(8):152–185, 2008.
- [18] Tom Hirschowitz. Full abstraction for fair testing in CCS (expanded version). *Logical Methods in Computer Science*, 10(4), 2014.
- [19] J. Martin E. Hyland and C.-H. Luke Ong. On full abstraction for PCF: I, II, and III. *Information and Computation*, 163(2):285–408, 2000.
- [20] G. Maxwell Kelly. *Basic concepts of enriched category theory*, volume 64 of *London Mathematical Society Lecture Note Series*. Cambridge University Press, 1982. Republished as: *Reprints in Theory and Applications of Categories 10* (2005).
- [21] Stephen Lack and Paweł Sobociński. Adhesive categories. In *Proc. 7th Foundations of Software Science and Computational Structures*, volume 2987 of *LNCS*, pages 273–288. Springer, 2004.
- [22] Tom Leinster. *Higher Operads, Higher Categories*, volume 298 of *London Mathematical Society Lecture Notes*. Cambridge University Press, Cambridge, 2004.

- [23] Saunders Mac Lane. *Categories for the Working Mathematician*. Number 5 in Graduate Texts in Mathematics. Springer, 2nd edition, 1998.
- [24] Paul-André Mellès. Asynchronous games 2: the true concurrency of innocence. In *Proc. 15th International Conference on Concurrency Theory*, volume 3170 of *LNCS*, pages 448–465. Springer, 2004.
- [25] Paul-André Mellès. Game semantics in string diagrams. In *Proc. 27th Symposium on Logic in Computer Science*, pages 481–490. IEEE, 2012.
- [26] Robin Milner. *A Calculus of Communicating Systems*, volume 92 of *LNCS*. Springer, 1980.
- [27] Robin Milner, Joachim Parrow, and David Walker. A calculus of mobile processes, I/II. *Information and Computation*, 100(1):1–77, 1992.
- [28] Hanno Nickau. Hereditarily sequential functionals. In *Proc. Logical Foundations of Computer Science*, volume 813 of *LNCS*, pages 253–264. Springer, 1994.
- [29] Robert Paré. Yoneda theory for double categories. *Theory and Applications of Categories*, 25(17):436–489, 2011.
- [30] Michal R. Przybyłek. The other pullback lemma. *ArXiv e-prints*, November 2013.
- [31] Silvain Rideau and Glynn Winskel. Concurrent strategies. In *Proc. 26th Symposium on Logic in Computer Science*, pages 409–418. IEEE, 2011.
- [32] Michael Shulman. Framed bicategories and monoidal fibrations. *Theory and Applications of Categories*, 13(9):147–163, 2008.

A. Miscellaneous properties of presheaf categories

We here collect a few basic results about pushouts, pullbacks and monos in presheaf categories, which we will consider to be second nature in the sequel. The well-known pullback and pushout lemmas are not recalled, though widely used throughout. Similarly, let us merely recall that epis are stable under pullback, and that monos are stable under pushout in presheaf categories.

A.1. MONOS, PULLBACKS, AND ADHESIVITY. Let us start with an easy result about pullbacks along monos:

A.1.1. LEMMA. *Any commuting square as below with j iso and m monic is a pullback.*

$$\begin{array}{ccc}
 A & \longrightarrow & B \\
 j \downarrow & & \downarrow m \\
 C & \longrightarrow & D
 \end{array}$$

PROOF. A simple diagram chase. ■

The second result is specific to sets:

A.1.2. LEMMA. *Any commuting square of the form below left is a pullback if each rectangle as below right is.*

$$\begin{array}{ccc}
 \sum_{i \in I} A_i & \xrightarrow{[f_i]_{i \in I}} & A \\
 \downarrow \Sigma_{i \in I} k_i & & \downarrow k \\
 \sum_{i \in I} B_i & \xrightarrow{[g_i]_{i \in I}} & B
 \end{array}
 \qquad
 \begin{array}{ccc}
 A_i & \xrightarrow{f_i} & A \\
 k_i \downarrow & & \downarrow k \\
 B_i & \xrightarrow{g_i} & B
 \end{array}$$

PROOF. Straightforward. ■

The third result is an instance of the other pullback lemma [30].

A.1.3. LEMMA. [Another pullback lemma] *In any presheaf category, for any commuting diagram as below with e epi, if the outer rectangle and the left-hand square are pullbacks, then so is the right-hand square.*

$$\begin{array}{ccccc}
 A & \longrightarrow & B & \longrightarrow & C \\
 \downarrow & & \downarrow & & \downarrow \\
 X & \xrightarrow{e} & Y & \longrightarrow & Z
 \end{array}$$

PROOF. An immediate consequence of [30, Theorem 1], given that, in any presheaf category, epimorphisms are stable under pullbacks and (Epi, Mono) is a factorisation system, so all epimorphisms are strong. ■

Let us continue by recalling the adhesivity properties of presheaf categories [21].

A.1.4. LEMMA. *In any presheaf category, any pushout along a mono is also a pullback. Explicitly, any pushout square*

$$\begin{array}{ccc}
 A & \xleftarrow{m} & B \\
 \downarrow & & \downarrow \\
 C & \longrightarrow & D
 \end{array}$$

with m mono is also a pullback.

A.1.5. LEMMA. [Adhesivity] *In any presheaf category, for any commuting cube*

$$\begin{array}{ccccc}
 I & \xrightarrow{\quad} & B & & \\
 \downarrow & \searrow & \downarrow & \searrow & \\
 A & \xrightarrow{\quad} & C & & \\
 \downarrow & & \downarrow & & \downarrow \\
 I' & \xrightarrow{\quad} & B' & & \\
 \downarrow & \searrow & \downarrow & \searrow & \\
 A' & \xrightarrow{\quad} & C' & &
 \end{array}$$

with the marked pullbacks, mono and pushout, all vertical faces are pullbacks if and only if the top face is a pushout.

PROOF. By [21, Example 6 and Proposition 8 (iii)]. ■

A.2. EXTENSIVITY. Let us finish with a similar-looking statement, which has in fact more to do with extensivity [4] of **Set** than with adhesivity.

A.2.1. LEMMA. *In **Set**, for any commuting cube*

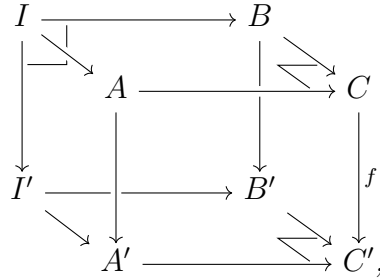

with the marked pushouts and pullback,

- if $I' \rightarrow B'$ is injective then the front square is a pullback, and
- if all arrows except perhaps f are injective, then f also is.

PROOF. The following proof is due to Paweł Sobociński (private communication). In **Set**, the map $m: I' \rightarrow B'$, being injective, may be written as a coproduct injection $m: I' \rightarrow I' + X'$. But, injective maps being stable under pullback and coproduct injections being stable under pushout, the whole cube may be written as

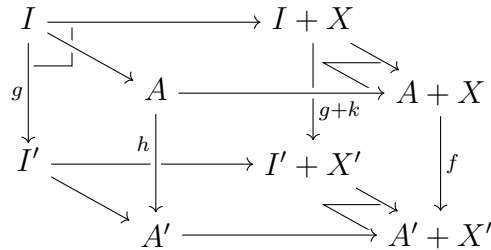

with $f = h + k$. This in particular shows that injectivity of h and k entails injectivity of f . Let us now show that the front face is a pullback. Indeed, it is the pasting of both left-hand squares below:

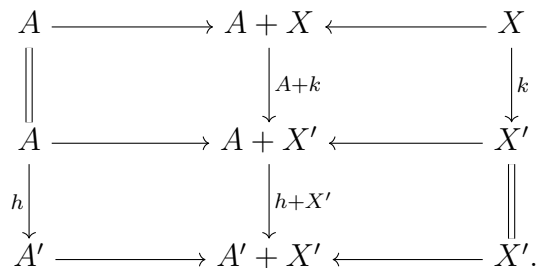

All rows being coproduct injections, by extensivity all squares are pullbacks, hence so is the face of interest by the pullback lemma. ■

A.2.2. COROLLARY. *For any commuting cube as in Lemma A.2.1 in any presheaf category with the marked pushouts and pullback,*

- *if $I' \rightarrow B'$ is monic then the front square is a pullback, and*
- *if all arrows except perhaps f are monic, then f also is.*

PROOF. Monos and pullbacks are pointwise in presheaf categories. ■

National Institute of Informatics, Japan

Univ. Grenoble Alpes, Univ. Savoie Mont Blanc, CNRS, LAMA, 73000 Chambéry, France

Email: clovis.eberhart@gmail.com, tom.hirschowitz@univ-smb.fr

This article may be accessed at <http://www.tac.mta.ca/tac/>

THEORY AND APPLICATIONS OF CATEGORIES will disseminate articles that significantly advance the study of categorical algebra or methods, or that make significant new contributions to mathematical science using categorical methods. The scope of the journal includes: all areas of pure category theory, including higher dimensional categories; applications of category theory to algebra, geometry and topology and other areas of mathematics; applications of category theory to computer science, physics and other mathematical sciences; contributions to scientific knowledge that make use of categorical methods. Articles appearing in the journal have been carefully and critically refereed under the responsibility of members of the Editorial Board. Only papers judged to be both significant and excellent are accepted for publication.

SUBSCRIPTION INFORMATION Individual subscribers receive abstracts of articles by e-mail as they are published. To subscribe, send e-mail to tac@mta.ca including a full name and postal address. Full text of the journal is freely available at <http://www.tac.mta.ca/tac/>.

INFORMATION FOR AUTHORS L^AT_EX₂ε is required. Articles may be submitted in PDF by email directly to a Transmitting Editor following the author instructions at <http://www.tac.mta.ca/tac/authinfo.html>.

MANAGING EDITOR. Robert Rosebrugh, Mount Allison University: rrosebrugh@mta.ca

T_EXNICAL EDITOR. Michael Barr, McGill University: michael.barr@mcgill.ca

ASSISTANT T_EX EDITOR. Gavin Seal, Ecole Polytechnique Fédérale de Lausanne: gavin_seal@fastmail.fm

TRANSMITTING EDITORS.

Clemens Berger, Université de Nice-Sophia Antipolis: cberger@math.unice.fr

Julie Bergner, University of Virginia: jeb2md@virginia.edu

Richard Blute, Université d' Ottawa: rblute@uottawa.ca

Gabriella Böhm, Wigner Research Centre for Physics: bohm.gabriella@wigner.mta.hu

Valeria de Paiva, Nuance Communications Inc: valeria.depaiva@gmail.com

Richard Garner, Macquarie University: richard.garner@mq.edu.au

Ezra Getzler, Northwestern University: getzler@northwestern.edu

Kathryn Hess, Ecole Polytechnique Fédérale de Lausanne: kathryn.hess@epfl.ch

Dirk Hoffman, Universidade de Aveiro: dirk@ua.pt

Pieter Hofstra, Université d' Ottawa: phofstra@uottawa.ca

Anders Kock, University of Aarhus: kock@math.au.dk

Joachim Kock, Universitat Autònoma de Barcelona: kock@mat.uab.cat

Stephen Lack, Macquarie University: steve.lack@mq.edu.au

F. William Lawvere, State University of New York at Buffalo: wlawvere@buffalo.edu

Tom Leinster, University of Edinburgh: Tom.Leinster@ed.ac.uk

Matias Menni, Conicet and Universidad Nacional de La Plata, Argentina: matias.menni@gmail.com

Ieke Moerdijk, Utrecht University: i.moerdijk@uu.nl

Susan Niefield, Union College: niefiels@union.edu

Robert Paré, Dalhousie University: pare@mathstat.dal.ca

Kate Ponto, University of Kentucky: kate.ponto@uky.edu

Jiri Rosicky, Masaryk University: rosicky@math.muni.cz

Giuseppe Rosolini, Università di Genova: rosolini@disi.unige.it

Alex Simpson, University of Ljubljana: Alex.Simpson@fmf.uni-lj.si

James Stasheff, University of North Carolina: jds@math.upenn.edu

Ross Street, Macquarie University: ross.street@mq.edu.au

Tim Van der Linden, Université catholique de Louvain: tim.vanderlinden@uclouvain.be

R. J. Wood, Dalhousie University: rjwood@mathstat.dal.ca