



HAL
open science

Hybrid Optimization Methodology (Exergy/Pinch) and Application on a Simple Process

Christelle Bou Malham, Zoughaib Assaad, Rodrigo Rivera-Tinoco, Thierry Schuhler

► **To cite this version:**

Christelle Bou Malham, Zoughaib Assaad, Rodrigo Rivera-Tinoco, Thierry Schuhler. Hybrid Optimization Methodology (Exergy/Pinch) and Application on a Simple Process. *Energies*, 2019, 12 (17), pp.3324. <10.3390/en12173324>. <hal-02273481>

HAL Id: hal-02273481

<https://hal.science/hal-02273481v1>

Submitted on 16 Dec 2019

HAL is a multi-disciplinary open access archive for the deposit and dissemination of scientific research documents, whether they are published or not. The documents may come from teaching and research institutions in France or abroad, or from public or private research centers.



L'archive ouverte pluridisciplinaire **HAL**, est destinée au dépôt et à la diffusion de documents scientifiques de niveau recherche, publiés ou non, émanant des établissements d'enseignement et de recherche français ou étrangers, des laboratoires publics ou privés.



HAL Authorization

Article

Hybrid Optimization Methodology (Exergy/Pinch) and Application on a Simple Process

Christelle Bou Malham ^{1,*}, Assaad Zoughaib ¹ , Rodrigo Rivera Tinoco ¹
and Thierry Schuhler ² 

¹ Mines ParisTech, Center of Energy Efficiency, PSL Research University, 91120 Palaiseau, France

² Total S.A., R&D Group, 92078 Paris La Defense, France

* Correspondence: christelle.bou_malham@mines-paristech.fr

Received: 5 July 2019; Accepted: 25 August 2019; Published: 28 August 2019



Abstract: In the light of the alarming impending energy scene, energy efficiency and exergy efficiency are unmistakably gathering momentum. Among efficient process design methodologies, literature suggests pinch analysis and exergy analysis as two powerful thermodynamic methods, each showing certain drawbacks, however. In this perspective, this article puts forward a methodology that couples pinch and exergy analysis in a way to surpass their individual limitations in the aim of generating optimal operating conditions and topology for industrial processes. Using new optimizing exergy-based criteria, exergy analysis is used not only to assess the exergy but also to guide the potential improvements in industrial processes structure and operating conditions. And while pinch analysis considers only heat integration to satisfy existent needs, the proposed methodology allows including other forms of recoverable exergy and explores new synergy pathways through conversion systems. A simple case study is proposed to demonstrate the applicability and efficiency of the proposed method.

Keywords: pinch analysis; exergy analysis; operating conditions optimization; structural optimization; heuristics; industrial processes

1. Introduction

Until the 19th century, mankind depended on biomass. However, after the industrial revolution, manual labor and organic sources were replaced by mechanization and fossil fuels which led to advancing the living standards of humans. Another fundamental snowballing consequence of the industrial revolution was the important population growth. Today, statistics estimate the world population to be over 7.6 billion people [1]. In order to fulfill the growing population needs, fossil fuels including oil, natural gas, and coal are representing nowadays 78% of the world primary energy consumption [2], with the industrial sector consuming 55% of all feedstock fuels [3].

With the global population swelling and industrialization on the rise, the environment is highly affected. Resources depletion is caused by the rising demands of finite resources reserves. Humans have consumed more natural resources than the earth can regenerate as of August 1, 2018, which is the earliest date since the 1970 [4]. In addition, the carbon dioxide emissions, resulting from fossil fuel burning, have dramatically increased to over 36 billion tons in the last 200 years [5]. In the light of the current greenhouse gas GHG emission scene, the earths' warming level is evaluated at 1.2 degrees which is more than halfway to the 2 degrees global warming limit set by the United Nations [6]. In this context, if no fundamental actions are implemented by 2050, the world economy expansion projects a 50% increase in GHG emissions leading to a global average temperature raise of 3 to 6 degrees by the end of the century [7].

Since the environmental problem is a planetary threat, implementing the solutions requires international efforts. In this scope, during the famous COP21, member nations agreed on limiting the GHG emissions to keep global warming below 1.5 degrees. France, for example, committed to increasing by 32% the share of renewable energy and reducing by half its energy consumption, in order to reduce 75% of its GHG [8]. The industrial sector, being an important contributor to the global energy consumption, is expected to reduce its GHG emissions by 24%. In order to ensure the industrial systems transition toward a sustainable functioning mode while curbing energy resources depletion and environmental anthropogenic footprints, industrial activities need to promote process efficiency improvement. Among efficient process design methodologies, literature suggests pinch analysis and exergy analysis as two powerful thermodynamic methods, each showing certain drawbacks, however.

Improving the efficiency addresses the mitigation of the final consumption by using less resources to provide the same outcome or, equivalently, providing an upgraded outcome for the same resources used. Thus, a literature review on the existing methods for process efficiency improvement is important in order to identify the strengths to adopt the points to develop and to ensure the novelty of the new proposed ideas.

2. Process Improvement Methods

2.1. The Principal Methods

The principal methods for reaching the maximum process efficiencies are classified into three extensive categories: thermodynamic methods, heuristic methods, and optimization methods [9]. Thermodynamic methods provide means for analyzing systems, while heuristic and optimization methods provide means for improvements. However, a solution is the most constructive, when all three methods are used conjointly.

2.1.1. Thermodynamic Methods

Thermodynamic approaches consist of evaluating a process quality according to the laws of thermodynamics. Heat integration and exergy analysis are the most powerful and frequently used thermodynamic approaches for process improvement [10].

Pinch analysis, is a method that aims to identify the possibilities of heat recovery in complex processes. This method was mainly developed in the early 1970s by Linnhoff and his colleagues [11] who developed a graphical method that enabled the calculation of the minimum energy required of a process and the design of its heat exchanger network HEN. The main tool employed in the pinch analysis was the composite curve graph showing simultaneously the hot streams and cold streams processes, the heat transfer potential between them, and the heat recovery bottleneck, as well as the external minimum energy supply required for heating noted HMER (hot minimal energy required) and for cooling CMER (cold minimal energy required). The purpose of energy integration was to take advantage of the potential interactions among the process units to maximize heat recovery and thus minimize the energy consumption; the HEN synthesis manifests as the key step to implement the identified synergies for a given process. It ensures economically optimal design that enables reaching the minimum energy targets computed by the pinch analysis [12].

Pinch analysis has been adopted by several researchers and engineers in different sectors. Beninca et al. [13] have optimized an olefin plant following the traditional pinch analysis to evaluate the possibilities of reducing heat requirements and to identify the network of heat exchangers that makes it possible to achieve these possibilities. In refining, attempts have been made to improve the thermodynamic efficiency and energy integration of the distillation sequence. Linnhoff and Dunford [14] applied the principles of the Pinch method to find the most appropriate heat recovery devices for a distillation column in a process.

Therefore, the pinch method is simple, visual, powerful, systematic, general, and capable of minimizing the overall heat consumption of the process by optimally matching the needs and the

availabilities in it. However, restricted to thermal flows and temperature parameters, this method presents a non-integrated approach between the HEN and the rest of the process (including pressures and compositions) [15]. Moreover, pinch analysis satisfies the thermal energy demand of a process by finding corresponding internal availabilities but it is unable of doing the inverse. This means that having certain energy availabilities in a process, pinch analysis cannot search for ways to valorize them in order to possibly improve the process.

The second powerful process improvement method is exergy analysis. The exergy concept is defined as the maximum amount of work achieved when a material is brought to a state of thermodynamic equilibrium with its surrounding by means of reversible processes [16]. Unlike the energy balance, based on the energy conservation law, the exergy balance is based on the energy quality degradation law stating that, even if there is a quantitative conservation, the quality between the various forms of energy varies [17]. The fundamentals of exergy analysis can be found in Moran and Shapiro's book [18]. The exergy invested in entering the system is partially destroyed internally because of the systems' irreversibility. The remaining available exergy is then split between the useful exergy and the lost, not valorized exergy.

The application of exergy analysis in energy systems and industrial processes has been widespread in recent decades because it provides the opportunity to reduce or eliminate sources of inefficiency. Among the works carried out, one quotes Khan et al. [19] who used the exergy analysis to locate the irreversibilities taking place in the unit operations of the cycle of the propane pre-cooling in a system of liquefaction of natural gas. Having underlined the importance of the operating conditions of the various stages of evaporation, its exergy study made it possible to determine the best operating scenario. Tchanche et al. [20] developed an approach to evaluate the performance of different organic Rankine cycle configurations using several exergy-based criteria. Tirandazi et al. [21] and Mehrpooya et al. [22] studied a multi-stage refrigeration cycle with propane as a refrigerant. They calculated the exergy efficiency and the losses in the main equipment of the cycle and showed that the heat exchanger and expansion produce the most losses. Similarly, Thengane et al. [23] conducted an exergy-efficient study of a hydrogen production process to compare and determine whether saving in chemical exergy or thermal exergy reduces exergy destruction in the process. They demonstrated through a case study that the recovery of chemical exergy is more beneficial. The exergy analysis may indicate only the potential for improvement of a given process, but it cannot indicate if this improvement is practically feasible or the means to achieve it. Indeed, the exergy analysis compares the actual performance with the ideal one. In reality, some exergy losses are inevitable and no improvement can reduce them. Feng and Zhu [24] proposed a new method that divides exergy losses into avoidable losses and unavoidable losses in order to identify practical and economic potentials for improvement.

This method is an auditing tool that analyzes industrial processes and evaluates them based on their exergy balance; it allows quantifying and tracking inefficiencies in order to improve them. In addition, this method takes into account all process variables, including temperatures, pressures, and compositions. On the other hand, the conventional exergetic analysis is criticized for serving only as an evaluation indicator and not as an improvement indicator. This approach lacks the systematic aspect and is dependent on the engineers reading and interpretation of exergy balance.

This limitation led to the development of an advanced exergy-based analysis by Tsatsaronis and his colleagues [25–28] in which the exergy destruction as well as the associated costs and environmental impacts are split into avoidable/unavoidable and endogenous/exogenous parts. Based on the avoidable parts and on the effect of parameter variations on component interactions, potential and strategies for improvement are revealed. The main role of an advanced exergy analysis is to provide engineers with accurate and additional information useful for improving the design and operation of energy conversion systems.

2.1.2. Heuristic Methods

By definition, a heuristic method is an approach that re-uses knowledge from previous experiences with comparable problems to find solutions. It is defined as an “aid to learning, discovery, or problem-solving by experimental and especially trial-and-error methods” [29]. These methods improve the conceptual exploration and allow reducing the solution time and cost. However, being drawn from practice, there is a risk that the knowledge will not be of use in the future, because there is no effective or structured way to access it. A number of previous works have embarked in the task of offering a structured approach towards the incorporation of heuristics in the product design process. SCAMPER [30] proposes a set of seven heuristics with the purpose of generating new alternatives from the reconfiguration of existing solutions. When it comes to using common sense guidelines based on the second law, Sama and his colleagues [31–34] introduced 21 rules reflecting a thermodynamicist’s perception to obtain the best structure of a process, minimizing the overall irreversibility. These rules are not replaced by a systematic methodology and it is left to the engineers’ knowledge to improve the structure.

More generally, the main inconvenience of using heuristic-based approach alone is that they may be restricted to typical and suboptimal solutions.

2.1.3. Optimization Methods

An optimization problem is the search for the minimum or maximum of a given function. Numerical optimization is used in energy and exergy efficiency process improvement methods in order to minimize the consumption or maximize the efficiency.

In the field of energy integration, and given the complexity of manually building the optimal network of heat exchangers for multiple process streams, numerical methods have been used to systematically solve the problem. Grossmann and his colleagues [35] developed a mathematical programming framework for the design of the HEN. This technique solved using numerical models, involves the development of a superstructure that incorporates all the connections possibilities that form potential candidates of the optimal design. The mixed integer linear programming MILP [36], allowed having the minimum number of heat exchangers assembly resulting in an optimal utility target. Zoughaib [37] scanned different simultaneous, sequential, linearization, and heuristic approaches to systematize the design of the exchanger network. He also introduced the CERES platform [38] used in this work and based on a MILP solver and a genetic algorithm optimizer, which optimizes heat recovery in industrial processes while implementing the pinch analysis.

Combined with exergy analysis, optimization-based researches are numerous. Lee et al. [39] used nonlinear programming to find optimal values of mixed refrigerant composition in a natural gas liquefaction process; afterward they used judgment and heuristics to modify flow and pressures. Shirazi et al. [40] constructed a MATLAB mathematical model of a peak-shaving production liquefaction plant and optimized it with a genetic algorithm using as variables the condensation, evaporation and intermediate pressures, flow and mixed refrigerant composition. Sanavandi et al. [41] similarly optimized the operating parameters in order to maximize the exergy efficiency of the C3MR process, but what distinguishes their approach from the others is that this preselects the parameters having the most influence on the objective function by performing a sensitivity study. This study highlights the important effect of mixed refrigerant composition and optimizes it, first time numerically according to sequential quadratic programming and second time by proposing 20,000 mixed refrigerant compositions and comparing each time the correspondence with the ideal case.

Mathematical optimization methods are systematic and reduce the computational time and solution space. However, used alone, they lack the comprehensive, practical, and feasible approach. When it comes to optimizing an objective function by varying the operating parameters, this approach is non-deterministic. The optimization of all operating parameters consumes time and does not necessarily give the best solutions. That is why, a sensitivity study is necessary to be able to prioritize the parameters by their importance and the influence they have on the objective function.

2.2. The Combined Methods

Hybridization efforts of pinch analysis and exergy analysis to combine their advantages have already been made and found in the literature.

For instance, “ExPaND” or “extended pinch analysis and design” [42] combines exergy analysis with the pinch method and uses process flows as working fluids. ExPaND decomposes the total exergy into temperature exergy and pressure exergy and exploits the possibility of transforming the exergy of pressure via compressors and expanders into exergy of temperature in order to integrate it with the thermal needs of the process. Gundersen et al. [43] used the ExPaND method to present rules that help the engineer to design the exchanger network. Among these rules, he presented fundamentals on how to properly place compressors and expanders to take advantage of pressure-based exergy. Marmolejo-Correa et al. [44] introduced a new diagram that uses a new energy quality parameter “exergy temperature.” This quality can be used to manipulate exergy changes caused by pressure adjustments.

In addition, the temperature is closely related to both pressure and power in most processes. The required energy (shaft work) and resulting duty are generally determined by the hot and cold temperature levels, which dictates the required pressure increase or decrease and thereby the need for shaft work. Large savings can be obtained by “shaft work targeting” which means integrating the hot and cold streams with the utility system in the best possible way. In this context, a combination of work integration and heat integration has been developed by Linnhoff and Dhole [45]. This combination introduces the exergy-saving aspect into pinch analysis, leading to optimal positioning of refrigeration utilities in processes where the work of the compressors has to be taken into consideration. By applying these graphical methodologies such as shaftwork targeting, ExPaND method, and the novel temperature exergy diagram for minimizing exergy requirement, Thasai [46] improved a complex LNG process with minimum work required.

This combination of the pinch method and the exergy was further developed with Feng and Zhu [24] introducing the exergy grand composite curve (EGCC) (energy level with respect to enthalpy) and representing the energy and exergy balances of the entire system, including rotating machinery and separation equipment. The area between the composite exergy curves represents exergy losses generated by heat transfer or work. In extension, these graphs also allowed to optimally design utilities and conversion systems around a process. In this context, a “preselect” algorithm that preselects and pre-designs different types of thermodynamic conversion systems using exergy analysis is presented by Thibault et al. [47]. These conversion systems include cogeneration, heat pumps, refrigeration and absorption systems placed and sized in order to improve the energy recovery in the process and consequently reduce the energy consumption.

The mentioned combined methods succeeded in applying the advantages of exergy and pinch methods together. However, these approaches do not surpass the separate limitations of each method.

2.3. Objectives

The objective of this work is to put forward a method that couples the exergy and pinch analysis in a way that copes with their separate limitations by proposing new concepts and criteria and integrating existing work. Exergy analysis should be employed as a guidance tool to propose potential process improvements. Conjointly, pinch analysis must be extended to all the systems parameters while turning the non-used exergy disposal into usable form and boost the process efficiency. In this context, an enhanced version of the exergy analysis using the Jacobian matrix of exergy destruction (ED) is proposed in order to detect the most influential operating parameters and to systematically give directions on their optimization. As for pinch analysis, introducing the “load influence matrix” (LIM) allows quantifying the influence of heating or cooling at any point in the process and selecting the promising added loads based on energy and exergy criteria. Moreover, heuristic rules and numerical optimization are braided with the exergy and pinch methods to advance a comprehensive methodology optimizing both process operational conditions and process architecture to attain the best valorizing solutions.

A hybrid pinch/exergy optimization methodology should be able to comprehensively improve an industrial process with reference to energy and exergy notions. Operating the process at optimal conditions has an important impact in managing the process' resources in order to reduce its energy consumption and exergy destruction. Moreover, the structural configuration of the system affects majorly the process' efficiency by influencing the energy distribution and consumption.

The guidelines of the proposed method are first presented. Then, they are applied on a simple industrial liquefaction process to prove the validity of the proposed methodology.

3. Proposed Hybrid Method

3.1. General Framework

The proposed method consists of three modules developed and connected to each other via a coded script in order to design a new systematic approach ensuring a global optimization of the industrial processes while coupling the exergy and energy integration approaches. According to Figure 1, the reference set of operating and design parameters is first modeled using a simulation software. PRO/II[®] [48] was used in this work. The interaction between the modules' units resides in controlling, decoding, and creating the different PRO/II[®] files via Python.

The simulation module is essential to establish a reliable and realistic representation of the reference case studied. The most important steps in the simulation module are the selection of the adapted thermodynamic model, the construction of the process flow diagram (PFD) to generate input files and the execution of the simulation to generate the output result files. Input text files consist of keywords with a specific format and order defining the unit operations and the input data of the process. Output text files include the information of all streams and unit operations.

Then, the simulated model is processed via the operating conditions optimization (OCO) module where the pinch method allows to design the optimal HEN of the process then establishes upon it the reference exergy and energy balances. Later, the evaluation of the Jacobian matrix of exergy destruction (ED) provides the most influencing variables in order to adjust them setting the minimization of both total exergy destructions and energy requirement of the process as objective functions. At the issue of the OCO module, a new simulation is provided representing an operationally optimized version of the initial simulation with fixed architecture apart from the exchange train, which is optimized. The resulting simulation enters the structural optimization (SO) module.

Based on the energy and exergy balances entry, the module sorts existing availabilities and existing needs. Besides existing demands, the module evaluates the load influence matrix (LIM) depicting non-existing loads that can potentially contribute to the process improvement and amasses them to the existing demands to form the propitious needs list. Later, synergy opportunities between the existing availabilities and the propitious needs are investigated via appropriate energy conversion systems or energy exchanging devices. In a parallel path, the library of predefined heuristic design modification is examined in the aim of finding potential design improvements. The execution of each design modification generates a different scenario that can be combined to other scenarios. The selected scenarios might undergo another methodological loop in order to optimize the operation conditions of the new architecture. It is noted that the user can intervene at any point of the sequence to interrupt the loop, omit certain design scenarios, or skip a module.

The proposed method develops new concepts in pinch and exergy analysis and combines them with subsisting bricks in the field while coupling both methods. The global formulation of the approach in a sequential interconnected numerical pattern allows the automation of the problem solution to reduce substantially the energy utilities requirements of the process and its total exergy destructions with the implementation of the structural enhancement scenarios and operational conditions optimization.

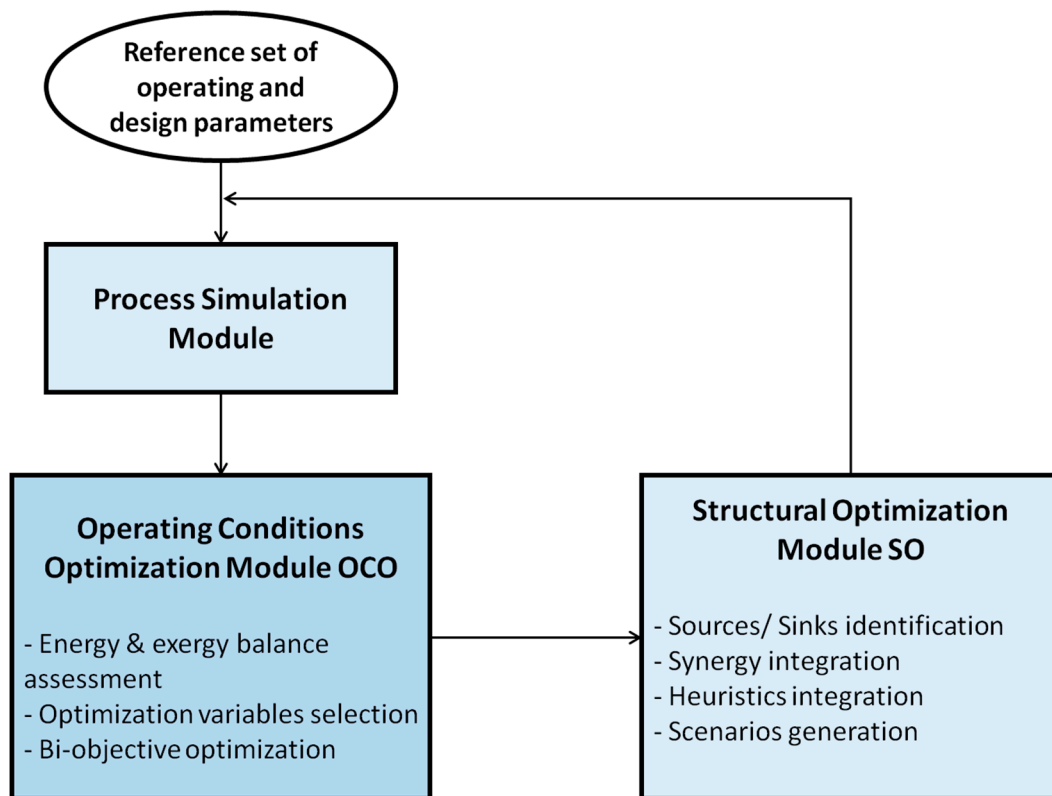

Figure 1. Global pattern of the proposed methodology.

3.2. Operating Conditions Optimization

The conventional exergy analysis method is reviewed for being only an evaluation indicator and not an improvement indicator. In this module, an enhanced version of the exergy analysis is introduced so that exergy is available to give directions on where and how to reduce the overall exergy expenditure in the process while taking into account the heat integration with the purpose of delivering a higher performance process. Ergo, the method proposes a new criterion, the Jacobian matrix of exergy destruction, as an improvement indicator guiding the improvement of the process. The Jacobian matrix consists of the first-order partial derivative of the vector function “total exergy destruction.” Its elements will therefore evaluate the total ED change relatively to the change of the process variables. Consequently, calculating the Jacobian matrix and interpreting its values and signs allows detecting the process variables contributing the most to the exergy degradation and gives instructions on the direction of their change in order to improve the process.

This segment of the proposed approach is implemented via the OCO module consisting of several inter-connected units, as seen in Figure 2. The module includes assessment units that evaluate the energy requirements of the process and perform exergy analysis. In addition, the Jacobian matrix is generated while considering the robustness and normalization in order to obtain a precise and reliable evaluation of the importance of the variables. After detecting the sovereign variables, adjusting them takes place in a bi-objective optimization unit to minimize both exergy expenditure and energy requirements of the process. As a result, an operationally optimized process yields from this module and forms the entry to the following structural optimization module in which additional synergy patterns are identified and implemented.

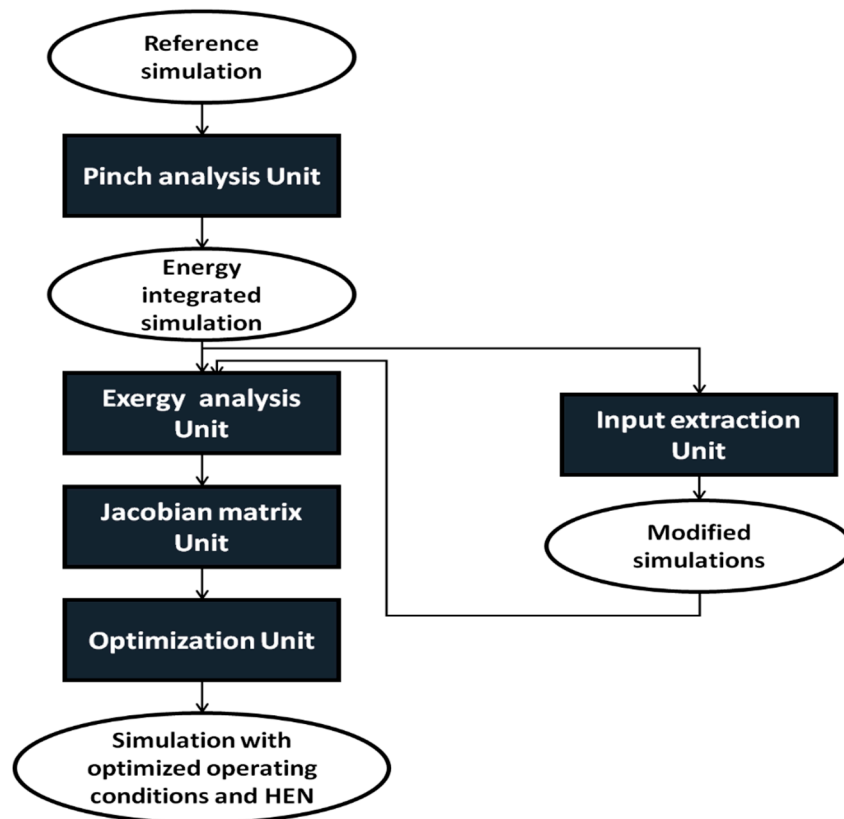

Figure 2. Framework of the operating conditions optimization (OCO) module.

3.2.1. Pinch Analysis Unit

Thermal integration provides a rigorous method for ensuring the best matching between all the thermal needs and availabilities in a process and optimizing the overall configuration of the installation. This takes place in two main steps, the first is defining the minimum energy requirement and the second is the synthesis of the minimum cost HEN respecting the MER defined during the first step. In the pinch analysis unit, the main steps consist of:

1. Process data extraction: The process data are first extracted including the inlet and outlet temperatures, heat loads, minimum temperature approaches, and heat exchange coefficients of the heat streams.
2. MER calculation: The pinch temperature and the minimum energy requirements (MER) of the studied process are calculated according to the problem table algorithm given by Linnhoff and Flower [49], which is the most intelligible and uncomplicated numerical method for determining the required properties. The MER represents the external heating and cooling utilities required in a process. It indicates the remaining duties to satisfy when maximum energy is recovered from the hot and cold streams of the process.
3. GCC drawing: The grand composite curve (GCC) of the process is drawn, representing the net energy need at each temperature level [12].
4. HEN design: If the calculated MER are less than the actual external consumption of the process, a new simulation with a less consuming HEN can be generated to replace the original HEN in the rest of the methodological pattern application [12].

3.2.2. Exergy Analysis Unit

Exergy represents the work that can be obtained from an amount of energy, under ideal conditions, using only the environment as a reservoir of heat and matter. In this unit, data concerning the enthalpy

and entropy of streams and the utilities data are extracted. Equations (1)–(7) are the basic equations behind the realized exergy analysis. The exergy of streams ex is calculated according to Equation (1) in terms of the enthalpy and entropy (h, s) of a system at equilibrium with its environment in a reversible process. Then, the calculated exergy streams values along with the utility data like heat duty and work are used in a coded calculator to perform an exergy analysis and to identify the consumed exergy, the exergy destructions and the lost exergy. The exergy destruction (ED) values are kept as data for the ED Jacobian matrix calculation unit.

$$ex = (h - h_0) - T_0(s - s_0) \quad (1)$$

Exergy consumptions of a process are defined as the incoming exergy to the system. As for the exergy destructions, it takes place in all systems operating on irreversible thermodynamic processes. Consider a steady state system with constant volume as shown in Figure 3, the first law of thermodynamics (energy balance) is expressed in Equation (2) as the difference between the streams' enthalpy rate $\dot{n}h$, heat transfer rate \dot{Q} and power \dot{W} entering (denoted 1) and leaving (denoted 2) the system. The second law of thermodynamics, known as the Clausius inequality, is shown in Equation (3) where $\dot{n}s$ stands for the streams' entropy rate and \dot{Q} stands for the heat transfer rate absorbed or rejected at temperature T . Combining Equations (2) and (3) after multiplying the last by the reference temperature T_0 , it is expressed as the difference between the incoming and the outgoing exergy as demonstrated in Equation (4). Consequently, Equation (5) represents the exergy destructions ΔEx of the energy system. On the component level, streams exiting are considered either part of the desired output or part of the exergy sources. The exergy destructions of various components are obtained by applying Equation (5) on every component as an energy system. The exergy destructions of different process components are given in Table 1. The total exergy destruction ED_{Total} of the process is the sum of the values of exergy destructions in each unit operation ED_j as in Equation (6).

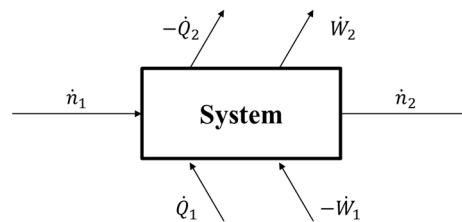

Figure 3. General balance of matter and energy on a general steady-state thermal system.

Exergy losses on the other hand are defined as the share of exergy leaving the system without being valorized. The losses of exergy in the process will be automatically detected in the following cases:

- Cng operations or heating operations: A process flow that is cooled by rejecting heat above the ambient temperature or heated at sub-ambient temperature represent respectively available hot and cold exergy rejected without being valorized.
- Effluents: Water, hot or cold gases released into the environment at high or low temperatures (for example, fumes from a heater) might contain a high thermal exergy. This exergy, if not valorized, will be lost.

$$\dot{n}_1 h_1 - \dot{n}_2 h_2 + \dot{Q}_1 + \dot{Q}_2 - \dot{W}_1 - \dot{W}_2 = 0 \quad (2)$$

$$\dot{n}_1 s_1 - \dot{n}_2 s_2 + \frac{\dot{Q}_1}{T_1} + \frac{\dot{Q}_2}{T_2} \leq 0 \quad (3)$$

$$\dot{n}_1 (h_1 - T_0 s_1) - \dot{n}_2 (h_2 - T_0 s_2) + \dot{Q}_1 \left(1 - \frac{T_0}{T_1}\right) + \dot{Q}_2 \left(1 - \frac{T_0}{T_2}\right) - \dot{W}_1 - \dot{W}_2 \geq 0, \quad (4)$$

$$\Delta Ex = \sum \dot{n}_{in} ex_{in} - \sum \dot{n}_{out} ex_{out} + \sum_i \dot{Q}_i \left(1 - \frac{T_0}{T_i}\right) + \sum -\dot{W}_j \geq 0 \quad (5)$$

$$ED_{Total} = \sum_{j=1}^{j=p} ED_j \text{ for } p = \text{total number of process unit operations} \tag{6}$$

$j = \text{unit operation number}$

Consequently, the exergy efficiency η_{ex} is defined in Equation (7) as the ratio of the exergy outputs $\sum Ex_{OUTPUT}$ to the exergy inputs $\sum Ex_{INPUT}$ of the system. The outputs represent the exergy obtained as desired output and the inputs are the expenses coming from an exergetic source that has been employed.

$$\eta_{ex} = \frac{\sum Ex_{OUTPUT}}{\sum Ex_{INPUT}} \tag{7}$$

Table 1. Exergy destructions of different process control volumes.

| Eipment | Exergy Destructions | Ey eiciency | |
|-----------------------------------------------------------|------------------------------------------------------------------------------------------------|------------------------------------------------------------------------------------------------------------------------------------------------------------------------------------------|----------------------------------------------------------------------------------------------------------------------------------------------------|
| Compressor | $\Delta Ex = \dot{n}(ex_{in} - ex_{out}) - \dot{W}_{compressor}$ | $\eta_{ex} = \frac{\dot{n}(ex_{out} - ex_{in})}{-\dot{W}_{compressor}}$ | |
| Turbine | $\Delta Ex = \dot{n}(ex_{in} - ex_{out}) - \dot{W}_{Turbine}$ | $\eta_{ex} = \frac{\dot{W}_{Turbine}}{\dot{n}(ex_{in} - ex_{out})}$ | |
| Valve | $\Delta Ex = \dot{n}(ex_{in} - ex_{out})$ | $\eta_{ex} = 0$ | |
| Mixer and splitter | $\Delta Ex = \sum \dot{n}_{in} ex_{in} - \sum \dot{n}_{out} ex_{out}$ | $\eta_{ex} = 0$ | |
| Two side exchanger (side 1 is cooling, side 2 is heating) | $\Delta Ex = \sum_{i=1}^n \dot{n}_i (ex_{i,in} - ex_{i,out})$ | $\eta_{ex} = \frac{\dot{n}_2 (ex_{2,out} - ex_{2,in})}{\dot{n}_1 (ex_{1,in} - ex_{1,out})}$ | |
| Condenser | $\Delta Ex = \dot{n}(ex_{i,in} - ex_{i,out}) + \dot{Q}_c \left(1 - \frac{T_0}{T_{int}}\right)$ | | |
| Evaporator | $\Delta Ex = \dot{n}(ex_{i,in} - ex_{i,out}) + \dot{Q}_e \left(1 - \frac{T_0}{T_{int}}\right)$ | | |
| Fired Heater | Heat exchanger combustion | $\Delta Ex = \sum \dot{n}_{in} ex_{in} - \sum \dot{n}_{out} ex_{out}$ $\Delta Ex = \dot{m}_{fuel} \times LHV + \dot{n} ex _{Air \text{ inlet}} - \dot{n} ex _{FG \text{ flame temp}}$ | $\eta_{ex} = \frac{\dot{n} ex _{FG \text{ flame T}}}{\dot{m}_{fuel} \times LHV + \dot{n} ex _{Air \text{ in}} - \dot{n} ex _{FG \text{ flame T}}}$ |

$\dot{W}_{compressor} < 0; \dot{W}_{Turbine} > 0; \dot{Q}_e > 0; \dot{Q}_c < 0$

3.2.3. Input Extraction Unit

In this unit the keyword input text file is analyzed to retrieve relevant information from data sources in a specific pattern. It draws out all the input data defined by the user composed of the unit operations specifications and the feed streams properties. Further data processing and keywords interpretation allows detecting the dependent variables defined in relation to each other and keeps the main variables v_i in order to reduce the number of extracted total input variables.

Some configurations in a process imply that a variable is impacted or controlled by another variable; for example, temperature in a heat exchanger is located after compression or expansion devices. In this case, the temperature of the exchanger is related to the pressure. The unit sends a warning when dependent variables are detected. Moreover, among the extracted input data, the user is capable of excluding certain variables considered as imposed and unalterable.

In addition, the input extraction unit goes through the values of each property in the reference output file, evaluates and returns the order of magnitude (OOM) of the extracted main variables properties according to the base-ten number system. This is applicable with any selected unit of measurements for all the properties except for the temperature where the absolute thermodynamic temperature, Kelvin (K), is imperative because the mathematical establishment of the methodology contains temperature-derived formulas.

3.2.4. Jacobian Matrix Calculation Unit

Exergy destruction values are quantitative parameters that allow evaluating the irreversibilities and subsequently locating the exergy destructive unitary operation. However, these values do not give indications on the potential improvement means of the system and therefore do not guide the optimization. To be able to systematize the optimization procedure, it is fundamental to find both a quantitative and indicative parameter of the system. This parameter must first give an indication on the variation of the exergy destructions in order to be able to develop the optimization approach in such a way as to propose possible improvements. In this study, a new parameter is introduced to guide the

improvement of the systems. This parameter is the derivative of the exergy destruction per operating parameter. The derivative of the exergy destruction function $\frac{dED}{dv_i}$ is the measure of the change rate of the exergy destruction with respect to the variation Δv_i of a variable v_i according to Equation (8). Consequently, to represent the influence of all the variables in the system on the exergy destruction and most importantly, to allow taking improvement actions upon this representation, the Jacobian matrix $\mathcal{J}_{ED_{TOTAL}}$ in Equation (9) is evaluated. This matrix represents all first-order derivatives of the vector function “total exergy destructions” (ED_{TOTAL}) with respect to the extracted variables in the input extraction unit.

$$\frac{dED}{dv_i} = \frac{ED(v_i + \Delta v_i) - ED(v_i)}{\Delta v_i} \tag{8}$$

$$\mathcal{J}_{ED_{TOTAL}} = \left[\frac{dED_{Total}}{dv_1} \quad \dots \quad \frac{dED_{Total}}{dv_m} \right] = \begin{pmatrix} t_{VED_{equip\ 1}} \\ t_{VED_{equip\ 2}} \\ \vdots \\ t_{VED_{equip\ l}} \end{pmatrix} = \begin{bmatrix} \frac{\Delta ED_{equip\ 1}}{\Delta v_1} & \dots & \frac{\Delta ED_{equip\ 1}}{\Delta v_m} \\ \frac{\Delta ED_{equip\ 2}}{\Delta v_1} & \dots & \frac{\Delta ED_{equip\ 2}}{\Delta v_m} \\ \vdots & \ddots & \vdots \\ \frac{\Delta ED_{equip\ l}}{\Delta v_1} & \dots & \frac{\Delta ED_{equip\ l}}{\Delta v_m} \end{bmatrix} \tag{9}$$

With $\frac{dED_{Total}}{dv_i} = \sum_{n=1}^l \frac{dED_{equip\ j}}{dv_i}$

From the exergy balance of the reference simulation and the exergy balances of the simulations with modified variables, the normalized mean derivatives of exergy destructions with respect to all the extracted variables are calculated and the ED Jacobian matrix is established. Each element of the matrix is interpreted according to its absolute value and its sign:

- The absolute value of the exergy destructions derivative $\left| \frac{dED}{dv_i} \right|$ quantifies the influence that the variable v_i has on the exergy destruction function. The more $\left| \frac{dED}{dv_i} \right|$ is important, the greater is the influence of the variable v_i on the exergy destructions and consequently a small change of this variable will bring a significant variation of the exergy destructions function and vice versa.
- The sign of the derivative $\frac{dED}{dv_i}$ indicates the direction of the variation of the exergy destructions with respect to the variable v_i . If $\frac{dED}{dv_i}$ is positive, this means that increasing the variable v_i will increase the exergy destruction. Conversely, a negative derivative $\frac{dED}{dv_i}$ means that increasing the variable v_i will decrease the exergy destructions.

Knowing that each variable has a different order of magnitude, the normalization of all the numerical derivatives is an important step to obtain a real measure of the influence of each variable on the exergy destruction function without being biased by its order of magnitude. Therefore, the values of the partial numerical derivatives $\frac{\Delta ED}{\Delta v_i}$ are calculated automatically as the ratio of the relative variation of the exergy destruction on the relative variation of the given variable, that is to say $\frac{\frac{\Delta ED}{ED_{in}}}{\frac{\Delta v_i}{v_i^0}}$.

Moreover, the construction of the final Jacobian matrix requires the analysis of the derivatives with respect to different variations of each variable generated in the modified simulations generation sub-unit. This will allow choosing and calculating the most representative derivative.

3.2.5. Modified Simulations Sub-Unit

An algorithm is developed in this unit to ensure the robust computation of the ED derivatives. This algorithm consists of modifying each main variable v_i extracted of a user-defined step α and a user-defined number of segments j before and after the initial value of the variable v_i^0 . The order of magnitude (OOM) of the extracted main variables properties is used according to the base-ten number system if its input value is zero.

$$\begin{aligned} v_i^j &= \left(1 + \frac{\alpha}{100}\right)v_i^0 \text{ if } v_i^0 \neq 0 \\ v_i^j &= \left(\frac{\alpha}{100}\right) \times OOM(pty(v_i^0)) \text{ if } v_i^0 = 0 \end{aligned} \tag{10}$$

With each variation v_i^j , respecting Equation (10), the unit composes a new keyword text file and replaces the initial value v_i^0 by v_i^j , executes the new input file, and extracts the total ED value for each modified variable. Note that, for robustness reasons, the derivative of ED with respect to each main variable is calculated as the average of the different ED for each modified main variable. In addition, each derivative is normalized to reduce the error because of different orders of input quantities.

3.2.6. Bi-Objective Optimization Unit

After the generation of the Jacobian matrix, its elements are ranked according to the descending order of their absolute values which grades the variables influence on the total exergy destruction function. Later, the number of variables to optimize among the most important values in the ranked matrix is specified by the user. Ranking and selecting the highest impact variables is important in order to reduce the time and the complexity of the optimization sequence in the following optimization unit of the methodology. This method applied on an academic LNG process showed that the choice of the optimization number is a compromise between computational time and optimization level. Increasing the number of optimization variables, minimizes more and more the objective function but increases the computational time to a greater extent [50].

After selecting the most influencing variables on the exergy destructions function and the direction of their modification, the module reaches the numerical optimization step. The numerical optimization should be a multi-objective one taking into account the total ED function, calculated in the exergy analysis unit in Equation (6), as well as the MER function calculated according to the problem table method in the pinch analysis unit (3.2.1). The PRO/II[®] optimizer is single-objective using successive linear programming to solve non-linear optimization problems. That is why; the multi-objective optimization is scalarized and formulated as a single-objective optimization problem such that optimal solutions to the single-objective optimization problem are Pareto optimal solutions to the multi-objective optimization problem. A general formulation for the scalarization of a multi-objective optimization considers the weighted sum method demonstrated in Equation (11).

$$\begin{aligned} \min \mathcal{F}(v_i) &= w_1 ED(v_i) + w_2 MER(v_i) \\ \text{with } w_1 > 0, w_2 > 0 \text{ and } w_1 + w_2 &= 1 \end{aligned} \quad (11)$$

At the end of this OCO module, a new process with optimized operating conditions and optimized HEN is simulated to serve as entry to the following module. One of the main advantages of this approach is time saving compared to holistic operating conditions improvement techniques. In addition, it allows transforming the exergy analysis method from an evaluation to a guidance tool by targeting the most important operating conditions to adjust and the direction of their adjustment.

3.3. Structural Optimization

The SO module is founded on the previously established exergy and energy balances that are systematically examined in the aim of detecting existent synergy patterns. However, limiting the synergy matches to the existing system streams in their form (e.g., internal heat recovery that can be identified by the pinch method) can yield to missing out on prospect synergies. These prospect synergies will be identified if the process is structurally modified in many cases that can be considered separately or combined together:

- Adding new heating or cooling requirements (changes in stream temperatures) that can be supplied directly by available excess heat or heating needs through the pinch method or through thermodynamic conversion systems;
- Looking for the best thermodynamic conversion systems options helping to convert the lost exergy into a useful form;
- Changing some unitary operations into equivalent ones destroying less exergy (e.g., replacing a valve by an expander)

The purpose of the SO module is to identify the best configuration change in the process helping to build the optimal pathway of the unrecovered energy and introduce better process operations. Its numerical formulation consists of assembling four units allowing the design of new integrated architectures. The energy and exergy balances as well as data of the previously optimized simulation enter the “sources/sinks identification unit” in which existing availabilities and needs along with profitable created needs are distributed and classified according to their heat load and temperature levels. This distribution is inserted in the “synergy integration unit” to assess the possible integrations scenarios, one by one. Synchronously, the energy and exergy balances as well as data of the previously optimized simulation enter to the “heuristic design modifications unit” where the application of potential design modifications generates new scenarios. At the issue of the “synergy integration unit” and the “heuristic design modifications unit,” a set of scenarios is obtained, each executing one structural enhancement. Afterward, the generated set of single-modification scenarios is given to the “combinatory scenarios evaluation unit.” As indicated by the name, this unit will create and evaluate new scenarios combining the structural enhancements of the single-modification scenarios. Scenarios representing competition in sharing an availability source revisit the synergy integration unit to assess the optimal energy distribution between conflicting sinks. As a result, the retained scenarios (from the synergy integration, the heuristic design modifications, and the combinatory scenarios evaluation units) are simulated in order to obtain their exergy and energy balances as well as the simulation files consisting the entry to the following OCO module. The units consisting the SO module are then further studied.

3.3.1. Sources/ Sinks Identification Unit

The optimized simulation coming from the OCO module is represented by a set of three elements ($HMER_0$, ED_0 , $CMER_0$) indicating, respectively, the theoretical heating minimum energy requirements, the total exergy destructions, and the theoretical cooling minimum energy requirement. These three elements become the SO module input simulation. The steps of the current unit are represented in Figure 4.

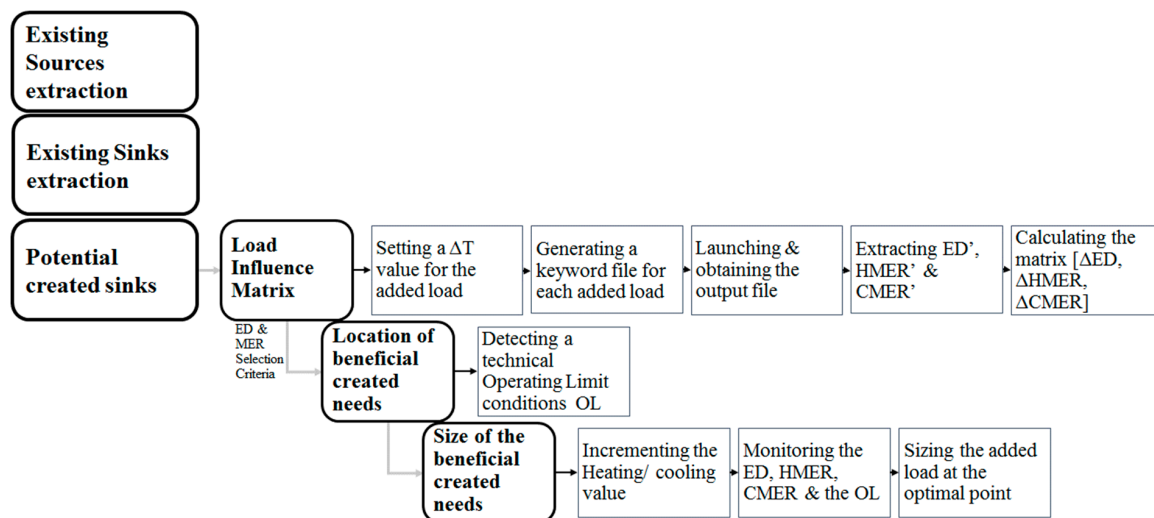

Figure 4. Steps of the sources/sinks identification unit.

Existing Sources and Sinks

The first step is to classify the existing energy sources and sinks provided by the energy and exergy balances along with data concerning the type of their heat exchange (heating/cooling), their inlet and outlet temperature values, their duty and their minimum temperature approach when exchanging with another flow. In fact, the input simulation contains energy sources and sinks that were not matched

in the pinch analysis unit of the OCO module. The existing sink forms the energy availability of the process. Valuable or not, they constitute waste energy at disposal originating from the heat rejection to the environment at different temperature levels. This availability is not valorized by the HEN design because of the non-conformity between their load, temperature levels value, and the remaining needs.

Potential Created Sinks

Nevertheless, since waste energy is at disposal, limiting to the demands required by the subsisting systems' heat flow confines the internal valorization potential. Adding heat loads at adequate locations and adequate temperature levels of the system can subsequently improve the overall process by decreasing its global consumed exergy while supplying the supplementary load from an existing wasted energy. These added loads are accordingly represented as propitiously created energy needs. Thus, the developed methodology proposes a sequential approach in order to determine and define the added heat loads that can improve the process. This approach will help guiding structural modifications that are not intuitively recognizable.

- Load Influence Matrix

The LIM is evaluated according to the following steps in order to spot the locations where a propitious energy need can be created:

- Specifying a value for the temperature change ΔT provoked by the added duty. To evaluate the heating influence, ΔT is positive. As for adding cooling loads, a negative ΔT is inserted.
- Generating new input process simulation files each altering the input version by introducing an energy load with the specified ΔT at a different location of the process. This is modelled by a simple heat exchanger increasing or decreasing the temperature of the flow at the studied location.
- Launching the generated files in order to simulate the influence of the added loads coded in each one on the global process behavior. The output file of each executed input file is obtained.
- Processing each output file to extract the needed data. In fact, the exergy and energy calculators being embedded in the input simulation, a new set is evaluated corresponding to adding a load at location.
- Calculating the elements of the "load influence matrix" according to Equation (12). Each line of the matrix quantifies the influence of the added load on the hot minimum energy requirements, the cold minimum energy requirements, and the total exergy destructions.

$$LIM = \begin{bmatrix} L_1 & HMER'_1 - HMER_0 & ED'_1 - ED_0 & CMER'_1 - CMER_0 \\ L_2 & HMER'_2 - HMER_0 & ED'_2 - ED_0 & CMER'_2 - CMER_0 \\ \vdots & \vdots & \vdots & \vdots \\ L_i & HMER'_i - HMER_0 & ED'_i - ED_0 & CMER'_i - CMER_0 \\ \vdots & \vdots & \vdots & \vdots \\ L_n & HMER'_n - HMER_0 & ED'_n - ED_0 & CMER'_n - CMER_0 \end{bmatrix} \quad (12)$$

- Location of the Propitious Needs

After calculating the LIM, exergy and energy criteria are used to select the appropriate locations to place a thermal load. In fact, decreasing the total exergy destructions of the process when adding an energy load is a necessary condition to classify it as beneficial. From a thermal energy point of view, interpreting the HMER and CMER variation signs gives indication on whether or not implementing the load is energetically interesting and on the possibly needed conversion system. To be also profitable from an energy point of view, the supplementary heat load should not create additional external utility requirements which means that the HMER should not increase. A heating scenario is judged as

propitious if heating provokes decrease in ED, while either reducing or keeping constant the HMER. If the sign combination in a set ($\Delta HMER'$, $\Delta ED'$, $\Delta CMER'$) verifies the selection criteria of Table 2, implementing the energy load at location Loc_i is immediately added to the beneficial needs list.

Table 2. Selection criteria for propitious added loads.

| Selection Criteria | ΔED | $\Delta HMER$ | $\Delta CMER$ |
|--------------------|-------------|---------------|---------------|
| Heating LIM | - | 0 | - |
| | - | - | - |
| Cooling LIM | - | - | 0 |
| | - | - | - |

When the locations of the interesting needs are identified, the process is investigated to identify if placing the load at the detected location impacts the operating conditions limits. For example, if a heat is added before a compressor, the following sizing step assures not violating the maximum operating temperature of the compressor. The operating condition limit (OL) is later used to frame the added load sizing process.

- Size of the Propitious Needs

Varying by ΔT the temperature at a certain location of a system gives an indication whether or not adding a load is beneficial. Thus, after finding the interesting spots in a system to add a heat or cooling load, the last step in identifying the propitious needs is sizing them to obtain their optimal load value and heating/cooling temperatures. To do so, the outlet temperature of the added load is gradually increased until the trend of the HMER function starts rising, designating that the internal availabilities of the process no longer suffice the supplementary heating need. Beyond this minima value, the CMER settles to its minimum value. The minimal point designates the optimal heating or cooling temperature of the added exchange and subsequently its load. It is notable that if the modified temperature value induces violation of an indicated operating condition limit before reaching the optimum point, the load is sized according to the extreme temperature that respects the operating limit.

3.3.2. Synergy Integration Unit

Exploiting and matching the existing and/or created sinks to the existing sinks identified in the previous list allows, in the current unit, discovering new synergy patterns by the mean of direct heat exchange or conversion systems. The identified synergies were undetectable by the initial HEN design of the pinch analysis alone.

The preselection algorithm proposed by Thibault and Zoughaib [47] is the core of this synergy integration unit as it is compatibly connected to the hybrid algorithm developed in the scope of this study. In the preselection algorithm, a MILP algorithm automatically preselects and predesigns utilities and conversion systems based on exergy criterion. The mathematical model of the preselecting algorithm consists of the following steps:

- Input Data: The algorithm uses the GCC as input data. It is automatically generated by software CERES [51] which applies the transshipment model.
- Conversion system modeling: This preliminary step of the algorithm aims at preselecting utilities that fit the best in the process for the exergy criteria. Simplified models based on thermodynamic laws have been developed. To pre-design utilities means finding the optimal operating temperature levels for technology. Figure 5 shows a GCC covering three zones, an endothermic zone requiring heat above the pinch temperature, an exothermic zone with excess heat between the ambient, and the pinch temperatures and a refrigeration zone below the ambient. The figure illustrates the applicable conversion systems with respect to their integration zone.

- Energy balance: Evaluating the total heat loads taken and provided at each temperature level after using the utilities.
 - GCC update: An updated GCC is rebuilt at this point of the algorithm and takes into account the effect of utilities on the process heat loads.
 - Electricity balance: When all utilities are set up, the electricity consumption and production has to be calculated in order to evaluate overall exergy destruction.
 - Restriction on utilities placement: The algorithm sets technological feasibility criterion in order to reduce the number of different technologies of utilities and accelerate the problem solving.
- Objective function: Energy levels [24] are used to calculate the total exergy destruction value. The last manifests as objective function to minimize.

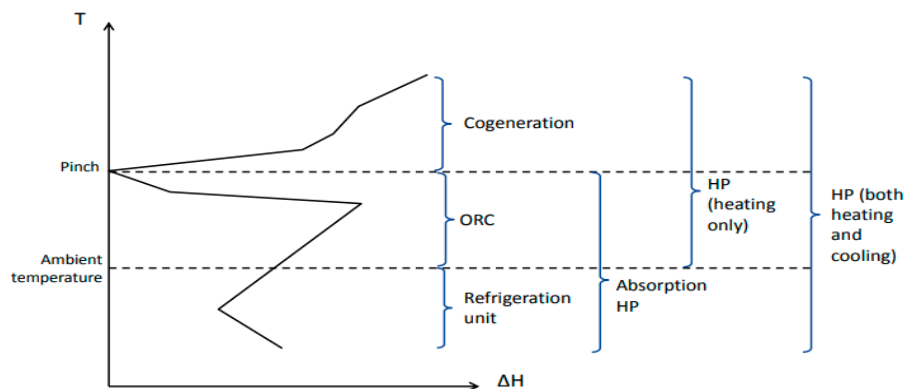

Figure 5. Zones for integrating heat conversion systems [52].

3.3.3. Heuristic Design Modification Unit

The present unit will also handle introducing new process designs, however based on technological enhancements possibilities. To do so, a library of design heuristics is predefined and is consulted in the SO module to check if the studied process verifies the conditions for integrating any of the proposed design technologies. In fact, the exergy and energy balances along with the output data file coming from the previous simulation are processed in order to verify if they validate any of the heuristics conditions. If they do, while improving the HMER, CMER, and ED conditions, each heuristic is implemented alone generating a separate scenario. Two design heuristics are investigated:

- Extended Pinch Analysis and Design Procedure

The ExPANd method focuses on sub-ambient processes and consists of relieving the flow under pressure by introducing one or more pressure expansions so that the pressure-based exergy is converted into exergy based on temperature. This makes it possible to produce cooling capacity and work simultaneously. At the level of a process, this action leads to a reduction in the need for cooling utilities. In the heuristic design unit, this case is implemented if in one or a series of sub ambient heat exchangers, the supply temperature of the cold stream at any point is greater than the final target temperature of the heat streams with a need for cold utility in the system. Temperature difference is constantly checked on the new cold streams' supply temperature side in order to prevent crossover.

- Valve Replacement

This heuristic is achieved by replacing the process' valves by an expander with an isentropic efficiency assumption and the same pressure drop value. If operating at temperatures above the ambience, this replacement will allow producing work. However, if the temperature change resulted increases the overall energy demands or the total exergy destructions, this heuristic is not considered. While at low temperatures, the main advantage of this replacement, also verified by the ExPANd

method, is therefore the production of additional cold when a stream displays temperatures below that ambient. The output of the work that can be used to generate electricity will be an additional advantage.

3.3.4. Combinatory Scenarios Unit

The purpose of this unit is to create and evaluate new scenarios combining the structural enhancements of the single-modification scenarios generated in the two previous units. Two combinatory situations may subsist:

- The combined scenario includes joining single-modification scenarios each using a different availability source: in this case, no competition between the single scenarios exists and they are added together as designed in the synergy integration or heuristic modification unit.
- The combined scenario includes joining single-modification scenarios sharing the same availability: In this situation, the availability and co-existing needs are assessed. If the availability suffices the new designs simultaneously, the latter are added together. However, if no disposed waste energy can provide all the single-scenarios, the combined scenario will revisit the synergy integration unit in order to redistribute optimally the disposed energy on the co-existing new designs.

At this point of the methodology, all or a number of the generated scenarios can be retained by the user in order to simulate them and construct a new PFD including the design modifications and evaluate the new exergy balance. Afterward, the user can also choose whether to perform another methodological sequence or revisit the OCO module to re-optimize the operating conditions of the new process.

4. Case Study

4.1. Description

The demonstration case study on which the hybrid method will be gradually applied consists of a steam generation within an industrial site, as well as four unitary operations representing a virtual process as depicted in Figure 6. This is an academic case study to highlight the methodology, it does not reflect the real technical aspect of the process. The steam boiler generates superheated steam at 20 bar_(g) and 500 K. A turbine T_1 , with 80% adiabatic efficiency, is used for expanding the steam's pressure to 12.7 bar_(g) and generates 122 kW of work. The steam, at the outlet of the turbine, is then used to supply heat to two heat consumers in HX₁ and HX₂, the first at 400 K and the second at 450 K where it condensates into liquid water at 467 K and then returns as feed water to the boiler. The total heat need is equal to 3.5 MW. Pumps P_1 is then needed to get the pressure back up with a 95% efficiency. On the process side, air at 333 K is compressed from 20 bar_(g) until 60 bar_(g). The process also manifests two cooling needs, the first HX3 is a chilled-water cooling need at 277 K provided by a refrigeration cycle (COP = 4) and the second HX4 consists of lowering the temperature of the compressed air to 360 K. The boiler is modelled with 30% air excess and with a fuel composed of 70% CH₄, 20% C₂H₆, 5% C₃H₈, 3% C₄H₁₀, and 2% C₅H₁₂. The required fuel flow is consequently 0.26 t/h. Exhaust gas leaves the combustion chamber at an adiabatic flame temperature of 1900 K, exchange heat with the water in the boiler and is rejected to the environment at 475 K, supposing an acid dew point temperature of 335K. The pressure losses in the heat exchangers, mixers, and splitters are assumed negligible. The isentropic efficiency of the air compressor is assumed to be 95%. The process is simulated with Peng–Robinson as a thermodynamic method.

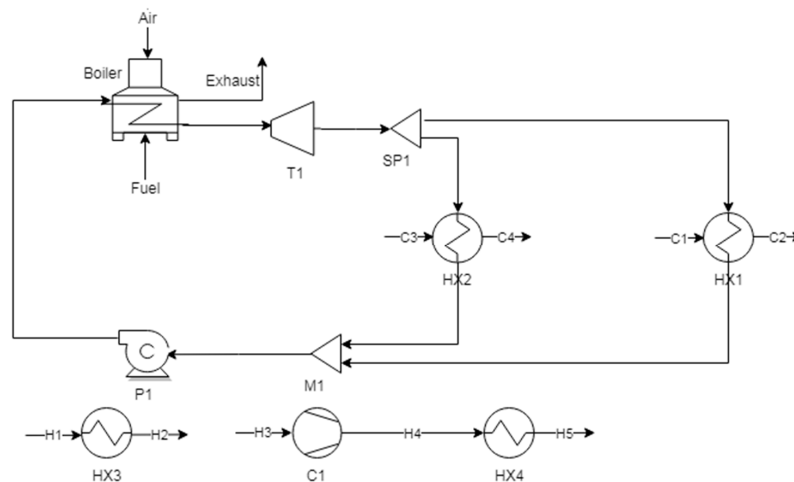

Figure 6. Steps of the sources/sinks identification unit.

4.2. OCO Module

4.2.1. Pinch Analysis

The first step of the module is verifying optimality of the HEN. To do so, the pinch analysis unit identifies the process streams and their data, shown in Table 3 and determines the energy requirements of the process. The process is found to optimally need 3.1 MW of heating requirements above the pinch temperature of 415 K and 0.88 MW of cooling utility requirements below this temperature and 0.31 MW of available cooling load in the exhaust stream. These results are obtained according to the problem table algorithm integrated in this unit. The calculated HMER and CMER are respectively less than the actual heating demand of 3.5 MW required by HX1 and HX2 and the actual cooling demand of 1.19 MW required by HX3 and HX4. This implies that the current heat exchangers configuration is not pinch-optimal and that it is possible to design another HEN that reduces external utilities by attaining the minimum energy requirement. In fact, the generated GCC of Figure 7 exhibits an auto-sufficient zone between the corrected temperatures 443 K and 415 K confirming the possibility of internal energy integration in order to reduce the overall energy consumption of the process.

Table 3. Process streams data of the base case study

| Stream | T _{in} (K) | T _{out} (K) | Load (MW) | ΔT _{min} /2 (K) |
|---------|---------------------|----------------------|-----------|--------------------------|
| C1-C2 | 400 | 404.6 | 1.75 | 15 |
| C2-C3 | 450 | 454.6 | 1.75 | 5 |
| H1-H2 | 277 | 273.6 | 0.13 | 5 |
| H4-H5 | 458.75 | 360 | 1.06 | 15 |
| Exhaust | 475.32 | 335 | 0.31 | 20 |

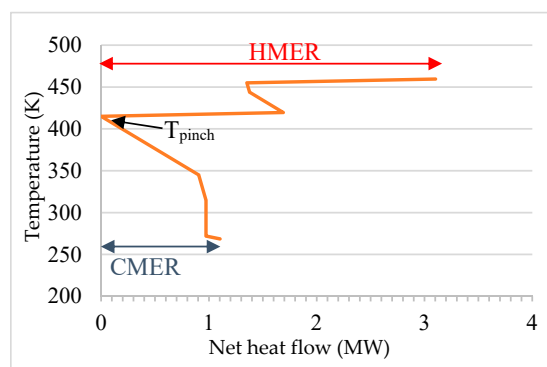

Figure 7. Pinch analysis of the base case study

Consequently, if the user chooses to design the optimal HEN, two recovery exchangers E1 and E2 are added to the train allowing to partially integrate the 400 K heating need respectively with the energy rejected in HX4 and the rejected combustion exhaust gas. With an assumption of 30 K minimal temperature approach in the added exchanger E1, the configuration of Figure 8 saves 0.31 MW of external utility requirement. In addition, 88 kW of the available energy in the exhaust gas are recovered with 40 K minimal temperature approach in E2. However, exchanging with exhaust gas at this location of the process is difficult to achieve and not cost-effective, especially that the heat load is relatively small. In this application, energy integration is only considered in exchanger E1 with a minimal energy requirement of 3.19 MW and the pinch analysis unit then adapts to the process model to correspond to Figure 8 and adopts it as the initial simulation for the rest of the application.

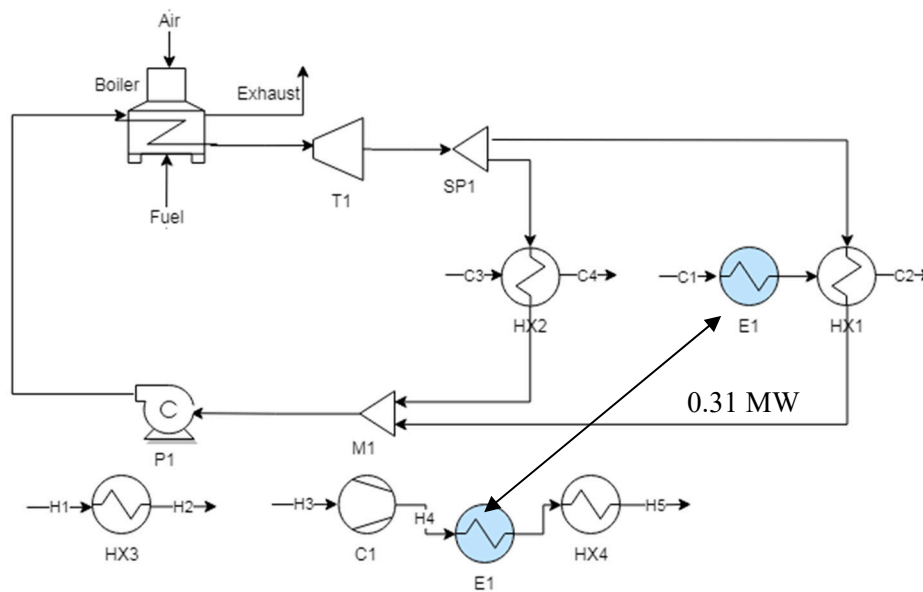

Figure 8. Flow diagram of the pinch-optimal HEN of the case study (case 1).

4.2.2. Exergy Analysis

Following the pinch analysis unit, the exergy analysis unit employed in the process of case 1 shows the exergy distribution in Table 4.

Table 4. Exergy balance for case 1.

| Exergy Input | Calculation Formula | MW | Exergy Destructions | MW |
|--------------------------------|---------------------------------------------|-----------------------|---------------------|------|
| Fuel exergy | $\dot{m}_{fuel} \times LHV$ | 3.91 | Combustion | 1.51 |
| Pump electricity exergy | | 0.15×10^{-2} | HX Boiler | 0.97 |
| Compressors electricity exergy | $\dot{W}_{C1} + \dot{Q}_{HX3}/COP$ | 1.31 | HX4 | 0.18 |
| | | | HX1 | 0.15 |
| Exergy Losses | | | C1 | 0.04 |
| Exhaust gas exergy | $ex_{exhaust} - ex_{350 K}$ | 0.19 | HX2 | 0.04 |
| | | | E2 | 0.02 |
| Exergy Output | | | T1 | 0.02 |
| Turbine work | | 0.12 | HX3 | 0.00 |
| Heat | $(ex_{C2} - ex_{C1}) + (ex_{C4} - ex_{C3})$ | 1.01 | P1 | 0.00 |
| Chilled water | $ex_{H2} - ex_{H1}$ | 0.01 | M1 | 0.00 |
| Compressed air | $ex_{H5} - ex_{H3}$ | 0.95 | SP1 | 00 |
| | | | Total | 2.94 |

$\eta_{ex} = 39.8\%$

It evaluates a total exergy consumption of 5.2 MW, mainly resulting from the fuel burning in the fired heater F-1 and electrical consumptions of the compressor C1 and of the refrigeration cycle for the chilled water cooling. The process destroys 2.9 MW of exergy distributed as shown in Figure 9. The highest exergy destruction resides in the fired heater F-1. This result is partially due to the degradation of the high value chemical exergy in the fuel in addition to the high temperature difference between the temperature profiles of the exhaust gas and the water in the steam generator. Considering rejecting heat to the ambience, exchanger HX4 is responsible of 0.18 MW of exergy destruction. The temperature approach in exchangers HX1 and HX2 between the heating needs temperature and the steam saturation temperature at the outlet pressure of T1, is also the reason behind the exergy destructions in these exchangers. As for the turbine T1, 0.02 MW of exergy is destroyed. For the rest of the components, their internal exergy destruction is negligible. Moreover, the energy rejected in HX4 and the energy of the hot gas released at 475 K is not valorized. Therefore, the last is accounted as lost exergy considering that exhaust gases can be cooled down to 350 K.

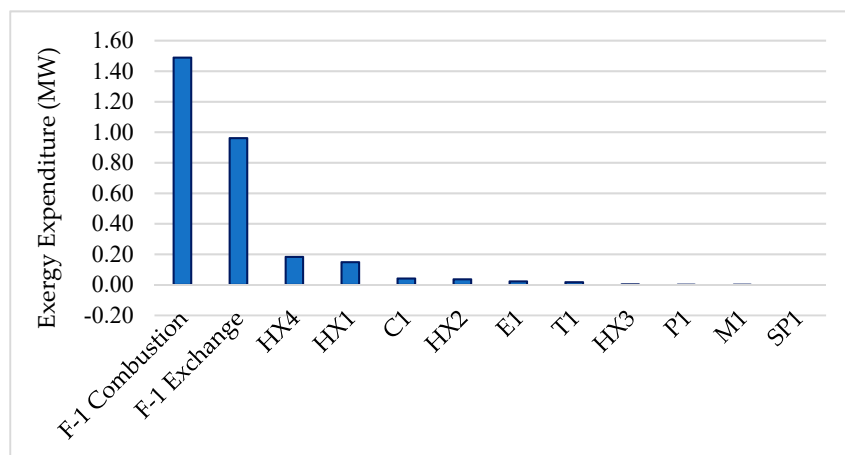

Figure 9. Exergy destruction and exergy losses distribution in the process case 1.

4.2.3. Input Extraction

After simulating the case 1, raw input data is extracted. It accounts for 30 user input variables including operation temperatures and pressures, flowrate distributions, fuel composition and equipment efficiencies. Out of those, specifications concerning the heaters model are considered as fixed and excluded from the input variables set. Likewise, the efficiencies of compressors and pumps and process streams specifications are set to be fixed. Also, the inlet pressure of pump P1, being defined relatively to the outlet pressure of turbine T1, is automatically excluded from the main variables set. The refinement process, Figure 10, curtails the raw input data to six main input variables used as entry for the following module unit. It also signals the dependences (P_{T1} , $MITA_{HX2}$) and (P_{T1} , $MITA_{HX2}$) since HX1 and HX2 are exchangers located after a pressure-changing device.

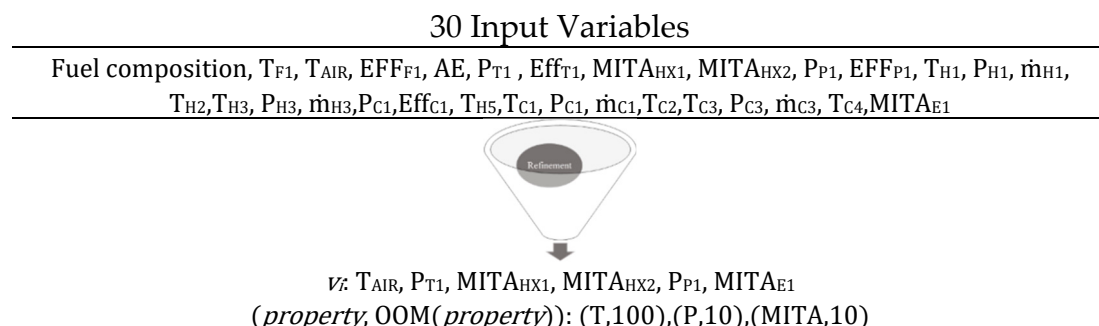

Figure 10. Main variables extraction.

4.2.4. Jacobian Matrix Calculation

To calculate the ED Jacobian matrix, two variations less and two variations greater than the initial value of each variable are generated. Consequently, four simulations will be created for every main input variable with a step $\alpha = 10$.

Calculating the Jacobian matrix ranks the detected variables as seen in Figure 11. The heater F-1 being an important exergy destruction source, the temperature of the combustion inlet air is found to have the most important influence on the total exergy destruction. Increasing this temperature at constant adiabatic flame temperature reduces the mass of fuel burned and therefore reduces the combustion exergy destruction in the heater as well as the total exergy destruction. However, this variable is detected as design variable whose modification requires a structural rearrangement. The steams' high pressure (HP) is the most influential variable in the process. Increasing the high-pressure increases the steams saturation temperature in F-1, and with a constant MITA, decreases the temperature approach between the exhaust gas and the steams' profiles reducing consequently the heat exchanger exergy destruction. The decrease of the steams' saturation temperature will have the same effect on HX1 and HX2 because of reducing the internal temperature approach between the steam and the heating needs. The turbines' work production is also increased even though its exergy destruction is increased because of entering with higher temperature and pressure values. The minimum temperature approach in exchanger E1 also has an important impact on the total exergy destruction of the process. Decreasing this variable implies a better heat integration in the HEN and consequently a reduction of the heaters' exergy destruction value thus reducing the total exergy destructions. On the other hand, decreasing the low pressure (LP) of the turbine T1 produces more mechanical work and decreases the steams' temperature in HX2 and therefore reduces the approach between the temperature profiles of its hot and cold streams.

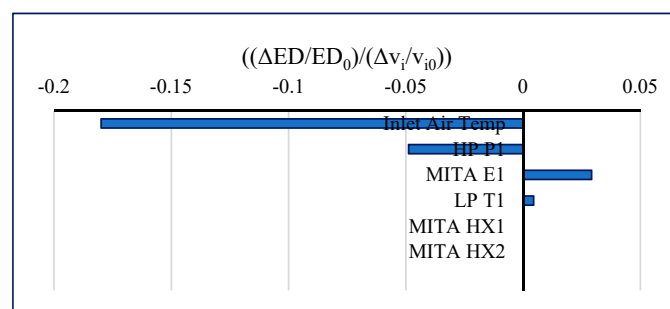

Figure 11. Jacobian matrix elements ranked according to their absolute value.

Since pressure and MITA properties have the same order of magnitude, Figure 12, showing the total exergy destruction function of the variation difference for each variable, validates the Jacobian matrix values. With bigger variation steps ($v-v_0$), it is depicted that the HP curve has the steepest slope, followed by the MITA E1, then the LP.

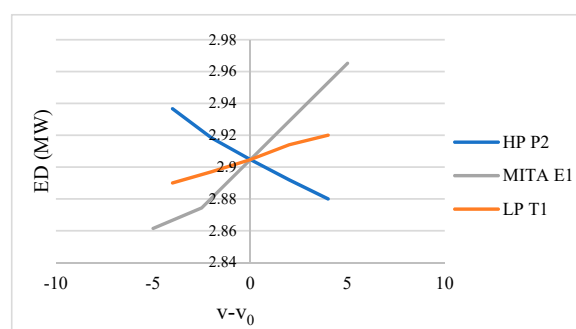

Figure 12. Exergy destruction variation with respect to step changes of variables v_i .

4.2.5. Bi-Objective Optimization

Since the number of influential variables is limited to three in the demonstrated case study, they are all selected as optimization variables in the following units.

The objective function $\mathcal{F} = w_1 ED + w_2 MER$ is optimized with seven weight sets (w_1, w_2) while respecting the following constraints:

- $MITA_{HX1} > 3$;
- $MITA_{HX2} > 3$;
- $T_{in-hot\ HX2} > T_{out-cold\ HX2} + Pinch_{HX2}$;
- $T_{in-hot\ HX1} > T_{out-cold\ HX1} + Pinch_{HX1}$;
- Liquid fraction of Pump inlet = 1.

In the case study, the optimal solution of the bi-objective weighted optimization is a single point solution, as shown in Figure 13, because the MER and ED functions are not conflicting. The optimal solution, identical for all weighted sets, is a minimum of 2.7 MW of ED and a minimum theoretical of 2.89 MW HMER. This solution is obtained for a HP of 43.65 bar_(g), a LP in the turbine equal to 11 bar_(g), and a 10 degree MITA in exchanger E1. The CMER is subsequently reduced to 0.68 MW as seen in Figure 14. The actual case without exhaust gas recovery consists of 2.98 MW of heating requirements. The optimized process is entitled “case 2”.

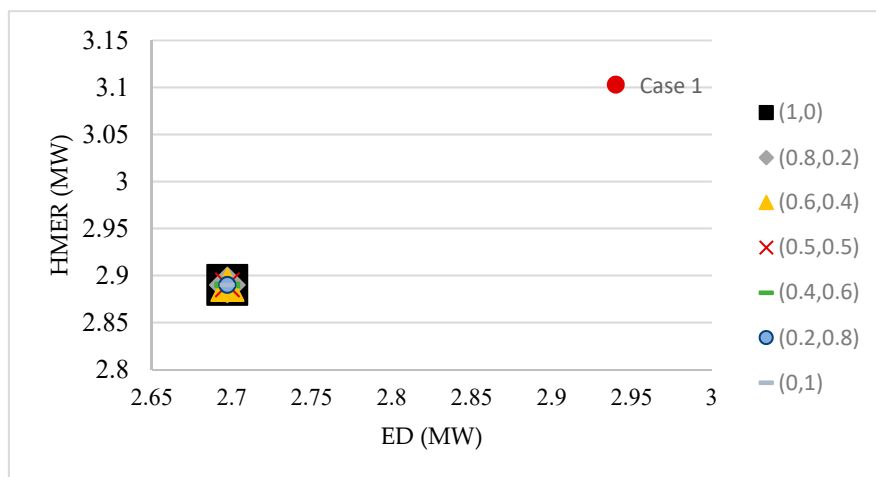

Figure 13. Optimal set of Pareto for the weighted bi-objective function including minimum energy requirements (MER) and exergy destructions function.

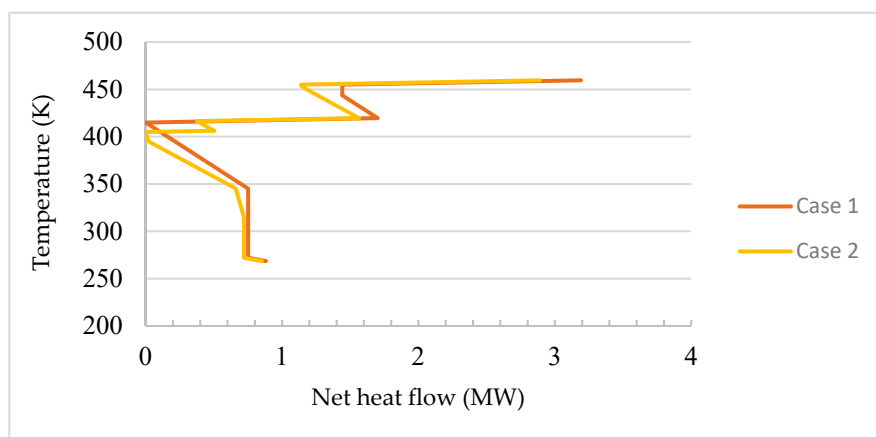

Figure 14. Grand composite curve (GCC) for case 1 and case 2.

To conclude the application of this module, the proposed approach allows reducing the theoretical HMER of the process by 17.4%, the actual HMER by 14.8%, and the total exergy destruction by 7%. The improvement was achieved by proposing a new HEN as well as by optimizing the operating conditions. One of the main advantages of this approach is time saving compared to holistic operating conditions improvement techniques. In addition, it allows transforming the exergy analysis method from an evaluation to a guidance tool by targeting the most important operating conditions to adjust and the direction of their adjustment.

4.3. SO Module

4.3.1. Sources/Sinks Identification

The exergy destruction in the new simulation, case 2, sums up to 2.7 MW. The configuration of the practical HEN with optimized parameters requires 2.98 MW of hot utility, which is greater than the theoretical hot energy requirements of 2.89 MW, if considering exhaust gas recovery. In the “sources/sinks identification unit,” the availabilities and requirement of Table 5 are detected.

Existing Requirements and Availabilities

The heat availabilities in the process are split between 0.27 MW of available exhaust gas at 468 K with a maximum cooling temperature to 335 K and 0.54 MW of heat rejection at 410 K in the compressors after cooler HX4. On the other hand, the existing needs are equivalent to process requirements that could not be met using the pinch method alone. After heat integration in the OCO module, no direct heat exchange scheme is possible between the remaining requirements and the disposed energy. The existing detected process demands consist of 0.13 MW of a chilled water-cooling need at 277 K and two heating needs in HX2 and HX1 at 450 K and 400 K respectively. The fulfillment of these needs is evidently beneficial because it allows to directly decrease the process external energy consumption.

Added Propitious Requirements: Location and Size

New needs are created and sorted in order to find the opportune ones to fulfill. The load influence matrix is calculated with a three degrees heating at each point of the process. The resulting values multiplied by 100 are presented in Equation (13).

$$\begin{bmatrix} \textit{Air} & 0 & -0.5 & -0.5 \\ \textit{C1} & 0 & 2.3 & 4.44 \\ \textit{C3} & 55 & -1.75 & 0 \\ \textit{H1} & 3.32 & -64.15 & -6.68 \\ \textit{H3} & 5.87 & -69.81 & -3 \\ \textit{Exhaust} & 9.5 & 0.22 & -17.5 \\ \textit{E1 cold out} & 3 & 0.92 & -54 \\ \textit{E1 hot out} & 3.2 & -72.44 & -6.8 \\ \textit{F1 cold in} & 1.23 & -0.86 & 0 \\ \textit{F1 cold out} & 2 & -0.80 & 0 \\ \textit{T1 out} & 23 & -12.58 & -1.36 \\ \textit{HX2 cold in} & 14 & -7.41 & -0.67 \\ \textit{HX2 cold out} & 189 & -206.51 & -0.27 \\ \textit{HX1 cold in} & 9 & -5.17 & -0 \\ \textit{HX1 cold out} & 132 & -84.98 & 0.5 \\ \textit{P1 out} & 0.5 & -0.35 & 0.5 \\ \textit{C1 in} & -4 & -2.34 & -3 \end{bmatrix} \quad (13)$$

In agreement with the MER and ED criteria, two possible spots for adding heat in the process are potentially beneficial: Heating the “air” stream (combustion air) and heating the compressors’ inlet stream “C1 in.” After determining the locations of the advantageous created demands, each one should be validated and sized separately.

- Added option 1: Heating “air” stream

Heating the “air” stream implies preheating the intake air for the combustion process. The load influence matrix shows that increasing the temperature of the combustion air is propitious because it is provided by internal heating availabilities and allows improving the process by reducing its total exergy destructions. This is interpreted by the negative change in the total exergy destruction value along with a reduction in the CMER and a constant HMER value. In fact, pre-heating the inlet combustion air alleviates the burner load and reduces its fuel consumption allowing to substantially reduce the chemical exergy degradation. Assuming a constant adiabatic flame temperature, the enthalpy increase of the air entering the furnace yields to increase the air to fuel combustion mass ratio and consequently reducing the fuel consumption.

Sizing the preheating need consists of finding the optimal preheating duty and its corresponding temperature levels in order to add it to the process requirements list. Figure 15 shows the behavior of the HMER, the CMER, and total ED with respect to air preheating temperatures (on two different scales). The optimal theoretical sizing is achieved by preheating the air to 385 K through internal heat recovery to keep a constant theoretical HMER equal to 2.89 MW. Before this temperature, the CMER is decreasing, designating the use of available energy in the process to heat the air. Exceeding a 385 K of inlet air temperature cannot be satisfied by the internal energy availabilities settling at their minimum value. Sizing the air preheating recovery exchanger takes into account respecting a minimum internal temperature difference of 10 °C.

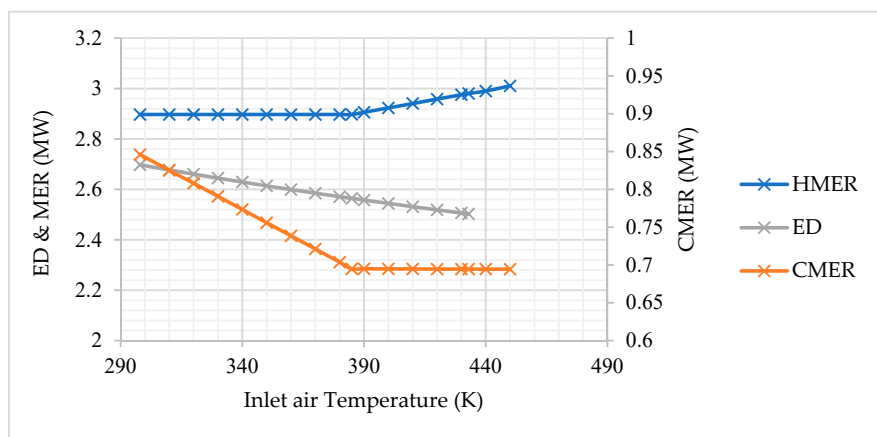

Figure 15. The hot minimal energy required (HMER), cold minimal energy required (CMER), and total exergy destruction (ED) of case 2 with respect to the combustion air intake temperature.

However, considering that the theoretical HMER is less than then actual HMER, the difference between the two is also available for recovery on the cold side. Since the total ED and the fuel consumption are constantly decreasing, pre-heating the air to the maximum is of interest. To do so, the preheating size requires meeting the actual HMER of 2.98 MW, which occurs at an air temperature of 429 K.

- Added option 2: Heating the compressors’ C1 inlet stream “C1 in”

The load influence matrix allows detecting that it is advantageous to place a heating duty at the inlet of compressor C1. Even though this modification yields to increase the compressors’ consumed

work, its global impact is found to be beneficial. In fact, entering the compressor at a higher temperature conducts to exiting it at a higher temperature also, which implies having more heat that is available for recovery in the compressors aftercoolers. With a fixed outlet temperature for the heating need in HX1, the recovery in exchanger E1 is increased and the duty required by the furnace is decreased. In this specific scenario, the compressor acts as an open cycle heat pump that transforms low-grade energy to high-level temperature energy by using only the process flows and without actually incorporating a heat pump equipment. Even though, this option invests in mechanical exergy to directly produce thermal exergy, the global gain is reflected in chemical exergy savings in the fired heater level. Therefore, the load influence matrix demonstrates the reduction in the process' hot energy requirements along with reducing the total ED and decreasing the rejected heat notably in exchanger HX4.

Similarly, as in option 1, the optimal heating load is sized by gradually increasing the outlet heating temperature up until the added load starts needing more than the available heat in the process and the HMER starts increasing. However, in this particular case, the unit signals the heating location to be before a compressor and adds to the sizing process an operating limit, which is the maximum compressor operating temperature equal to 500 K. Figure 16 shows that the operating limit is reached before attaining the optimal HMER value. The maximum preheating temperature respecting the compressors' operating temperature is 363K, reducing the theoretical HMER to 2.48 MW, the CMER to 0.5 MW, and the total ED to 2.63 MW.

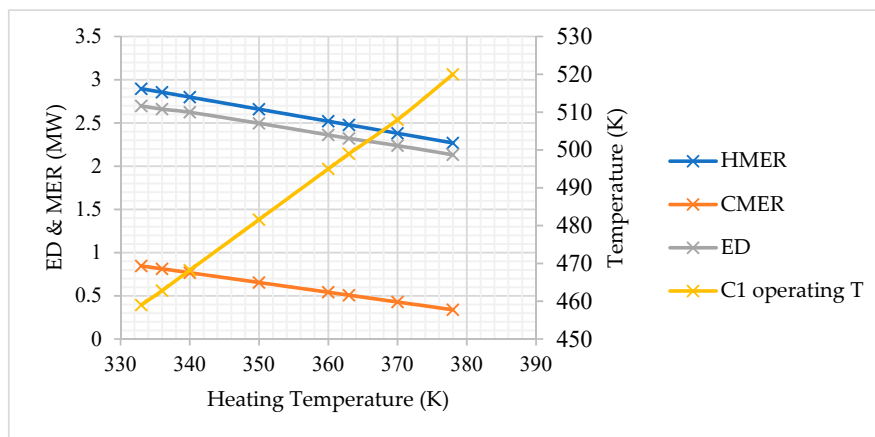

Figure 16. The HMER, CMER, and total ED of case 2 with respect to compressed air preheating temperature.

At the issue of the sizing of the second created potential need, a propitious invented requirement of 0.31 MW to be heated between 333 K and 363 K completes the requirements list shown in Table 5.

Table 5. Availabilities and needs lists.

| Availabilities & Requirements | Name | Type | T In (K) | T Out (K) | Load (MW) | Source |
|-------------------------------|----------------------|---------|----------|-----------|-----------|------------------|
| Availabilities | 1 | Heat | 468.78 | 335 | 0.27 | Exhaust |
| | 2 | Heat | 410 | 360 | 0.54 | HX4 |
| Requirements | A | Cooling | 277 | 273 | 0.13 | Chiller water |
| | Existing B | Heating | 450 | 454.6 | 1.75 | Heating need HX2 |
| | C | Heating | 401.4 | 404.6 | 1.23 | Heating need HX1 |
| | Propitious Created D | Heating | 298 | 429 | 0.23 | Combustion Air |
| | E | Heating | 333 | 363 | 0.31 | C1 Inlet Air |

4.3.2. Synergy Integration

After identification and quantification of the process' sources and sinks, the method finds, via the preselect algorithm, and assesses separately every potential synergy scenario ensuring the interchange between the systems' classified energy actors. The scenario considering integrating a heat pump machine to transfer heat from source 2 to sink C is not considered because scenario 3 is equivalent to it without actually placing the machine. The integration of the three proposed synergies is demonstrated below.

Scenario 1: Absorption Machine

An absorption machine is proposed as the first synergy scenario between the existing availabilities and the existing needs. It transforms the disposed heat in the compressors' after cooler to cooling energy capable of chilling the water. Figure 17 shows the specifications of the proposed absorption machine by the preselect module. In the regenerator, 0.24 MW of the available energy is applied so that the absorption solution is regenerated at 342.2 K. The refrigerant is later evaporated at 266 K while cooling the 277 K water by exchanging 0.13 MW, which is the entire cooling need. Consequently, the designed machine has a calculated COP of 0.54.

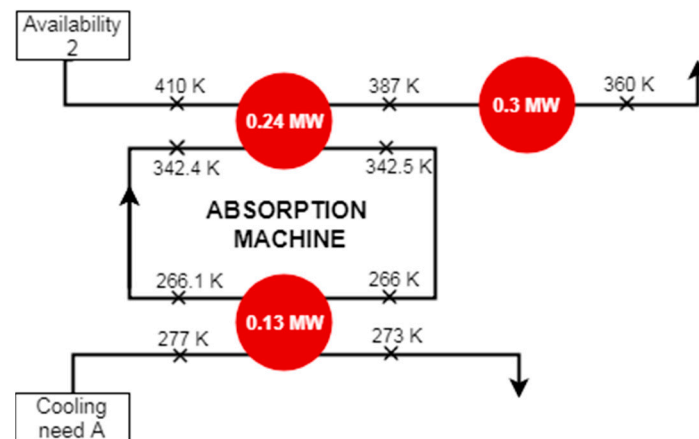

Figure 17. Absorption machine assessment.

Scenario 2: Combustion Air Preheater

This scenario aims at satisfying a heating need and since enough heating energy is available at the corresponding temperature levels, the completion of need D is achieved via a heat exchanger without any particular conversion systems. As seen in Figure 18, the combustion air entering at ambient temperature recovers 0.23 MW from the combustion exhaust gases and reaches the desired temperature of 429 K. The minimum temperature difference in the recovery heat exchanger is assumed 40 K. The remaining exhaust is rejected at 353 K.

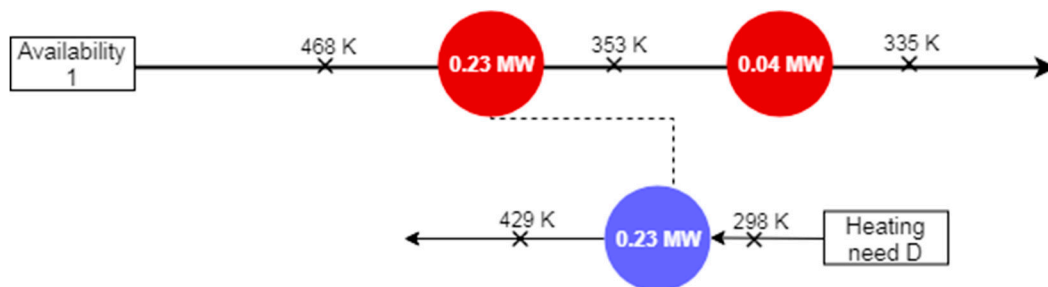

Figure 18. Combustion air preheating assessment.

Scenario 3: Compressors' Inlet Preheating

In a similar approach to preheating the combustion air, the implementation of this scenario is attained via a direct heat exchange as depicted in Figure 19. After recovery in E1, the remaining high-pressure air disposes 0.54 MW of heating energy. A total of 0.31 MW of it is used to increase the temperature of the compressors' inlet air from 333K until the calculated temperature of 363 K that allows respecting the compressors' operating temperature. A minimum temperature approach of 20K is taken in the recovery exchanger. This scenario increases the recovery in E1 up to 0.95 MW because of pumping heat at 500 K.

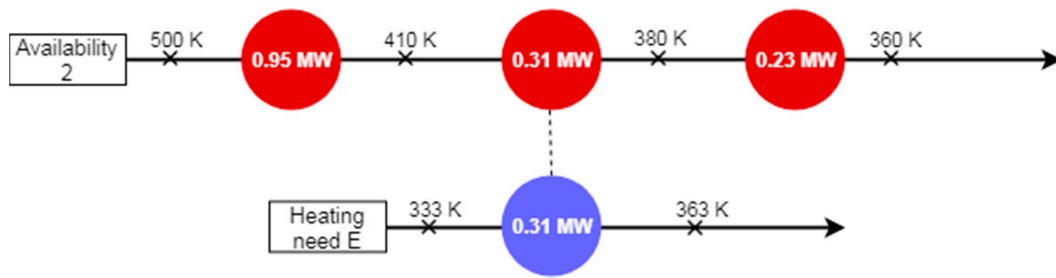

Figure 19. Compressors' C1 inlet air preheating assessment.

Figure 20 exposes the GCC resulting from the integration of each scenario alone. The initial case 2 and scenario 1 have the same HMER value equal to the optimal HEN value while the CMER in scenario 1 is reduced considerably because of the placement of an absorption machine removing heat below the pinch and removing cooling requirements. In scenario 2, the HMER is equal to the practical case because theoretical internal recovery was not considered because of its unfeasibility and using the exhaust gas to preheat the air allowed reducing the rejected heat below the pinch. As for scenario 3, generating higher temperature flows by the compressor trough with the recovery of the heating availabilities allows improving the internal recovery and reducing the HMER value and at the same time reducing the CMER.

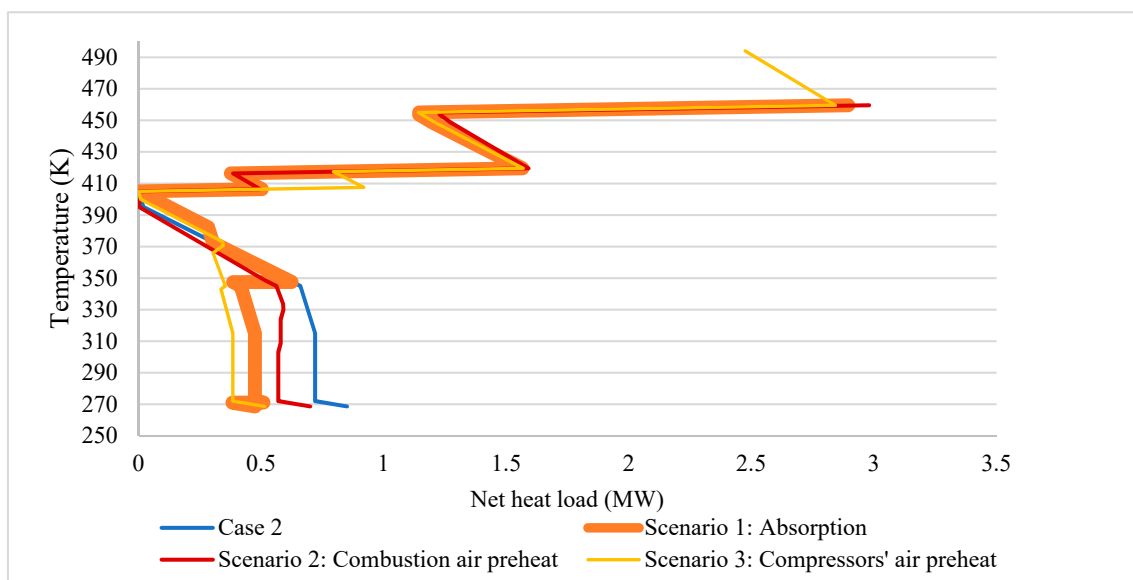

Figure 20. GCC of each synergy scenario.

4.3.3. Combinatory Scenarios Evaluation

Combining the combustion air-preheating to the absorption machine in scenario (1 + 2) or to the compressor inlet air preheating in scenario (1 + 3) does not show any competition between the fulfilled

needs since each one exchanges with a different availability. On the other hand, accumulating the absorption machine to the compressors' air preheating in scenario (1 + 3) or adding all three conversion systems in scenario (1 + 2 + 3) indicates coexisting demands sharing availability 2. The unit detects a competition between the coexisting demands because the availability load does not suffice both needs simultaneously. In this case, the method consists of judiciously redistributing energy between different sources and sinks and determining the optimal exchanges between the remaining heat excesses and the unmet needs.

In order to demonstrate the methodology, the combinatory scenario (1 + 2 + 3) implementing all three proposed conversion systems is chosen to be evaluated. The pre-select module is launched in order to resize the absorption machine or to find another integration possibility. Figure 21 shows that instead of resizing the absorption machine on the evaporator side, the synergy integration unit proposes another integration possibility by searching to absorb heat at a higher temperature level in the absorption machine. This will yield in improving the COP of the absorption machine and reducing its heat requirements on the regenerator side so it can produce a duty reserve for the air preheating and prevent the competition between the energy needs. In this scenario, 0.16 MW of the remaining energy in the compressed air is absorbed at 370 K in the absorption machine in order to provide, with a COP equal to 0.81, the 0.13 MW of cooling needed to chill the water. The remaining energy available in the compressed air will then be divided between preheating the air entering to the compressor and waste energy. The combustion air preheating takes place with the exhaust air independently from the rest of the network. The GCC of the scenario (1 + 2 + 3) combining all synergy scenarios is exhibited in Figure 22. The new structure of the process requires 2.57 MW for heating. Only 0.09 MW of heat remains in the process, which indicates the optimized structure proposed by the methodology.

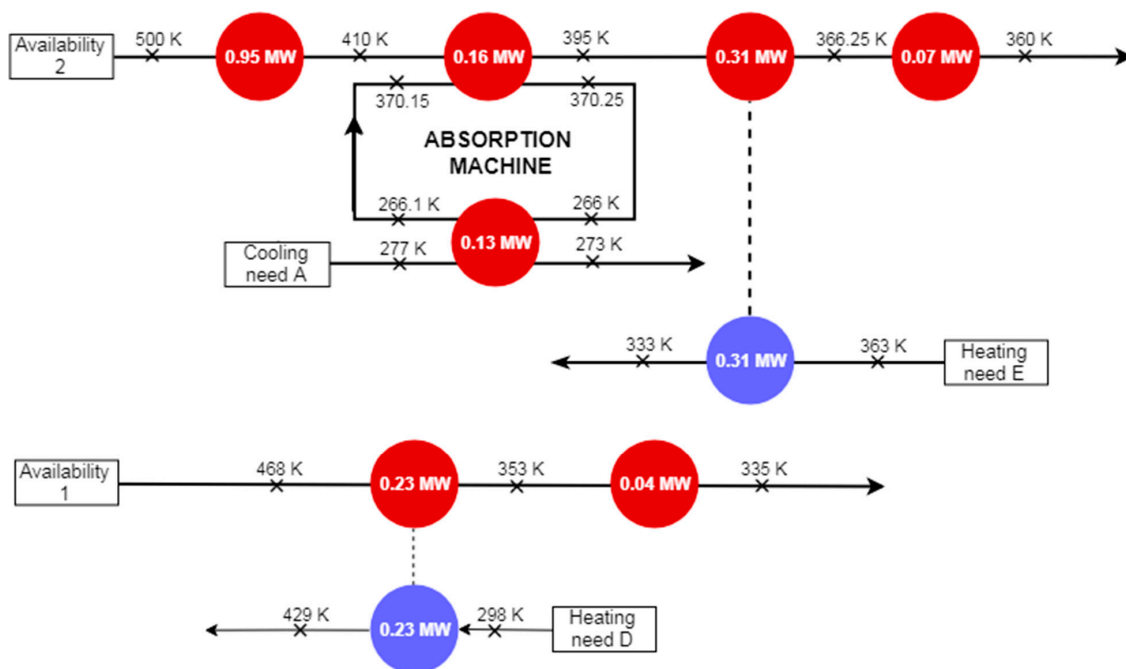

Figure 21. Scenario (1 + 2 + 3) design.

Figures 23 and 24 represent, on different y-axis scales, the ED distribution in the process' unitary operations and the total ED for the considered scenarios. The initial ED is decreasing in each of the single-scenarios and in the combinatory scenario. Interpreting the diagram allows concluding that in the scenarios exploiting the heat in the compressed after E1; the ED in exchanger HX4 is reduced caused by the load reduction of the exergy rejected. However, only in scenario 3 the recovery in E1 is increased because of the rise of the cold stream inlet temperature, which is reflected by an increase in the ED of the recovery exchanger E1 versus a consequential decrease in the ED of HX1 where utility

heating is required. In this scenario, it is also noticeable that even though the work of the compressor is increased, the local ED in C1 is increasing very slightly. In fact, the ED increase because of the supplementary work consumption, is largely compensated by the decrease in the flow exergy caused by the temperature change. This is justified by being close to the isentropic line with an assumed efficiency of 95% for the compressor. On the other hand, the combustion air-preheating scenario is the only one using the exergy of the exhaust gases therefore reduces the exergy destructions in the rejected streams. ED in HX3 is the ED generated by the water chilling, it is included in the calculation of the absorption machine in scenarios 1 and (1 + 2 + 3). Moreover, improving the COP of the absorption machine in scenario (1 + 2 + 3) is translated by a decrease in the ED of the machine.

The result of applying the SO module on the simple case study permitted exploring and evaluating three new conversion pathways. Combining all of them allowed reducing by 20% the total exergy destructions of the process conjointly to reducing the HMER by 11% and the CMER by 88% through intelligent use of the process' sources. Even though simple, this application showed interesting interactions between the ED and the MER functions and between the local and global ED variation. It allowed exploring design opportunities that were otherwise unattainable by classic pinch or exergy methods. Some of the solutions given were also not intuitively obvious nor provided by common sense.

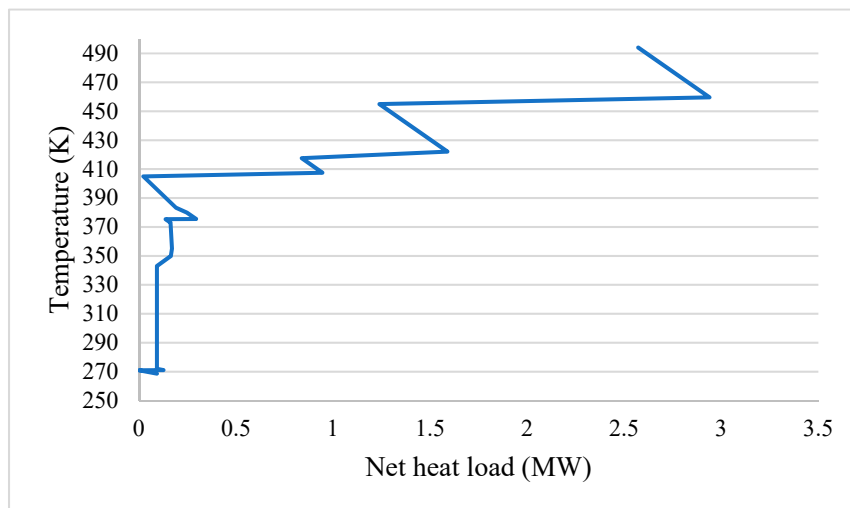

Figure 22. GCC of scenario (1 + 2 + 3).

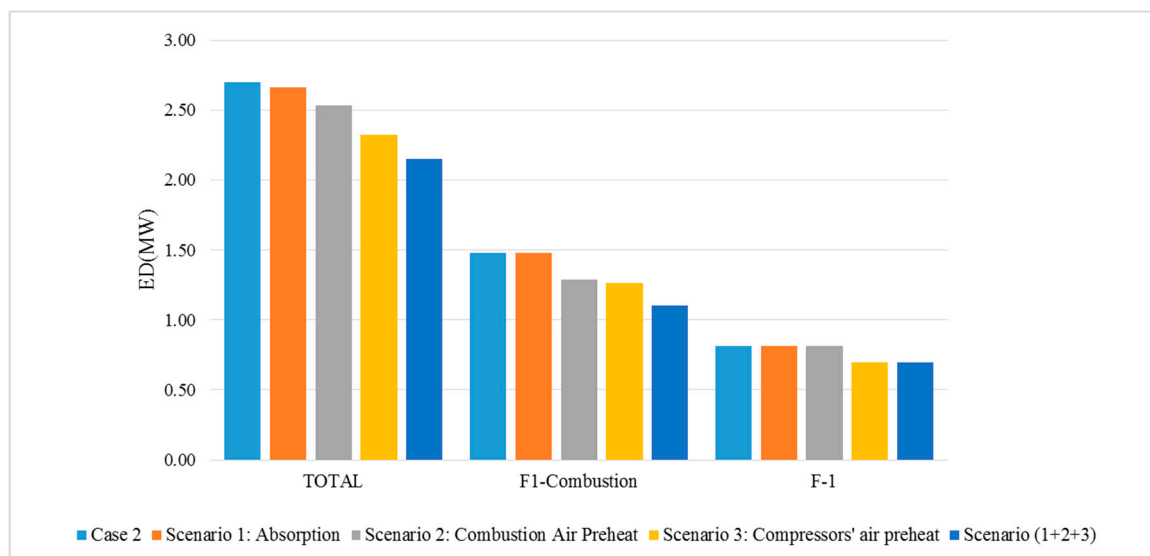

Figure 23. ED in the fired heater and total ED for the considered scenarios.

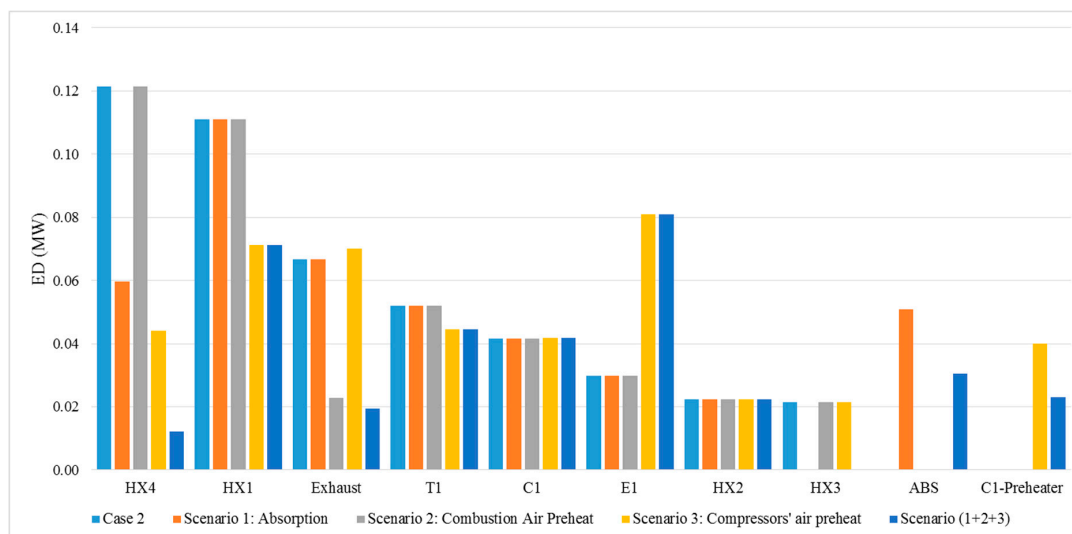

Figure 24. Unitary ED for the considered scenarios.

5. Conclusion

The proposed approach introduced new developed elements and existing bricks from the state-of-the-art to the conventional pinch and exergy approaches in order to extend their application and maximize their optimization potential. Consequently, the proposed methodological framework distinguished between an operating conditions optimization module and a structural optimization module, each improving the process based on methodology bricks from exergy and pinch analysis with the intervention of the user for certain decision-making situations. The proposed formulation of the OCO module succeeded in combining the pinch and exergy methods and overcoming some of their limitations. The introduction of the Jacobian matrix concept evolved the employment of the exergy analysis from an auditing tool to a decision-making tool giving indication on the target operating conditions and the direction of their modifications. Moreover, including the MER function in the bi-objective optimization exhibited the behavior of the process heat integration facing the optimization of all types of variables including pressure and flowrates and not only temperatures. As for the SO module, it achieved the extension of the traditional pinch analysis method so as to include designs with conversion systems investigating all prospect synergies in the process and therefore reducing the energy consumption. The proposed methodology is not bounded by searching the satisfaction of existing needs only but exceeds it by creating new needs and sorting them in order to find the opportune ones to fulfill.

In a case study demonstration, optimizing the process operating conditions according to the OCO module altered the process HEN as to introduce a new recovery exchanger, which allowed reducing by 9% the initial heating energy consumption. Later, targeting the three variables with the highest impact values, which are the steams' HP and LP, as well as the recovery exchanger MITA allowed further reduction of 14.8% in the heating energy requirements and a total of 7% decrease in the total ED of the process. In the SO module, one symbiosis pathway was detected in the existing systems' configuration. It consisted on valorizing the available heat in the process to provide existing cooling needs via an absorption machine. On the other hand, the load influence matrix contributed in detecting two interesting pathways, the first consisted of using the available heat in the process to preheat the air entering the fired heater and the second proposed using the available heat to preheat the inlet of an air compressor. Realizing the best feasible combination of conversion pathways allowed by 20% the total exergy destructions of the process conjointly to reducing the HMER by 11% and the CMER by 88%.

The proposed methodology showed to be time saving compared to the holistic approach by efficiently targeting the most influential operating condition to be optimized. Moreover, it demonstrated the potential of producing case-by-case solutions that otherwise require specific expertise. Future

development of the proposed methodology will consist of including other minimization criteria. In fact, the proposed approach is valid if the system has a constant desired exergy output but if the system has additional outputs or co-products leading to additional outputs, the ED criteria should be replaced by exergy efficiency. Moreover, cost functions and correlations can be added as part of the methodological pattern in order to generate cost and energy efficient solutions. In addition, future work will consider developing this methodology on another simulation platform with a multi-objective optimizer. Also, for more robustness and less computational time, formulating a mathematical approach for detecting any type of coupled variables should be considered for a more efficient input extraction process targeting directly the controlling variables. This can be done by calculating the influence matrix which is a numerical matrix assessing the influence of the change of each variable on all the other variables and spotting the ones that are related.

Author Contributions: Conceptualization, C.B.M., A.Z. and R.R.T.; methodology, C.B.M.; software, C.B.M.; validation, A.Z., R.R.T. and T.S.; resources, A.Z. and T.S.; writing—original draft preparation, C.B.M.; writing—review and editing, A.Z., R.R.T. and T.S.; supervision, A.Z.; project administration, C.B.M.; funding acquisition, T.S.

Funding: This research received no external funding.

Acknowledgments: Authors are thankful to Total R&D Group, Paris, France for support through its Energy Efficiency Programme.

Conflicts of Interest: The authors declare no conflict of interest.

Nomenclature

Latin letters

| | | |
|-------------------|----------------------------------------------|--------------------------------------|
| CMER | Cold minimal energy required | W |
| COP | Coefficient of performance | - |
| ΔT | Temperature change | ° |
| ΔT_{\min} | Minimum temperature difference | ° |
| ex | Specific exergy of a stream | J.mol ⁻¹ |
| ED | Exergy destruction | W |
| Ex_{OUTPUT} | The desired output exergy | W |
| Ex_{INPUT} | The input exergy expenses | W |
| Eff | Efficiency | - |
| Ex | Exergy | J |
| \mathcal{F} | Objective function | |
| h | Specific enthalpy at P, T | J.mol ⁻¹ |
| h_0 | Specific enthalpy at ambient P and T | J.mol ⁻¹ |
| HMER | Hot minimal energy required | W |
| LHV | Lower heating value | W.kg ⁻¹ |
| \dot{m} | Mass flowrate | kg.s ⁻¹ |
| MITA | Minimum internal temperature approach | ° |
| MER | Minimal energy required | W |
| N | Reference simulation | |
| N' | Optimized simulation | |
| \dot{n} | Mole flow rate | mol.s ⁻¹ |
| P | Pressure | bar/bar _(g) |
| \dot{Q} | Heat transfer rate | W |
| s | Specific entropy at P, T | J.K ⁻¹ .mol ⁻¹ |
| s_0 | Specific entropy at ambient P and T | J.K ⁻¹ .mol ⁻¹ |
| T | Temperature | K |
| T_0 | Ambient temperature | K |
| v_i | Variable of the exergy destruction function- | |
| v_i^j | Variation number j of variable v_i | - |
| \dot{W} | Power | W |
| w_1, w_2 | Weights for scalarized optimization | - |

Greek letters

| | |
|---------------|----------------------|
| α | Step variation value |
| ε | Infinitesimal value |
| η_{ex} | Exergy efficiency |

Subscripts and superscripts

| | |
|------------|------------|
| c | Condenser |
| e | Evaporator |
| i, j, n, m | index |
| min | Minimum |
| ut | utility |

Acronyms

| | |
|-------|------------------------------------------------------|
| CERES | Chemins énergétiques pour la récupération d'énergies |
| COP21 | 21st Conferences orties |
| C3MR | Propane and Mixed Refrigerant |
| EGCC | Exergy Grand Composite Curve |
| FG | |
| GCC | |
| GHG | |
| HEN | |
| HP | High pressure |
| LIM | Load influence matrix |
| LNG | Liquefied |
| LP | Low pressure |
| MILP | Mixed integer linear programming |
| OCO | Operating conditions optimization |
| OL | Operating limit |
| OOM | Order of magnitude |
| ORC | Organic Rankine Cycle |
| PFD | Process flow diagram |
| SSO | Structural optimization |

References

1. Max, R.; Hannah, R.; Esteban, O.-O. World population growth. *Our World in Data*. May 2019. Available online: OurWorldinData.org (accessed on 6 June 2019).
2. Statistics, B.P. *Statistical Review of World Energy*; BP p.l.c: London, UK, 2017.
3. International Energy Agency. *Key World Energy Statistics*; OECD/IEA: Paris, France, 2016.
4. Lin, D.; Hanscom, L.; Martindill, J.; Borucke, M.; Cohen, L.; Galli, A.; Lazarus, E.; Zokai, G.; Iha, K.; Eaton, D. Working Guidebook to the National Footprint Accounts. June 2018. Available online: www.footprintnetwork.org (accessed on 16 September 2018).
5. Hannah, R.; Roser, M. CO₂ and Greenhouse Gas Emissions. *Our World in Data*. 2017. Available online: Ourworldindata.org/co2-and-other-greenhouse-gas-emissions (accessed on 16 September 2018).
6. United Nations News. UN News. November 2015. Available online: <https://news.un.org/> (accessed on 16 September 2018).
7. OECD Environmental Outlook. *The Consequences of Inaction-Key Facts and Figures*; OECD: Paris, France, 2012; Available online: www.oecd.org/env/indicators-modelling-outlooks/oecdenvironmentaloutlookto2050theconsequencesofinaction-keyfactsandfigures.htm (accessed on 22 October 2018).
8. French Minister of Environment Energy and the Sea. Implementing the Paris agreement COP in action. In Proceedings of the Ministère de l'Environnement, de l'Energie et de la Mer, Paris, France, 30 November–12 December 2015.
9. Frangopoulos, C.; Von Spakovsky, M.R.; Sciubba, E. A Brief Review of Methods for the Design and Synthesis Optimization. *Int. J. Appl. Thermodyn.* **2002**, *5*, 151–160.
10. Abtin, A.; ChangKyoo, Y. Combined pinch and exergy analysis for energy efficiency optimization in a steam power plant. *Int. J. Phys. Sci.* **2010**, *5*, 1110–1123.
11. Linhoff, B.; Hindmarsh, E. The Pinch Design Method for Heat Exchanger Network. *Chem. Eng. Sci.* **1982**, *38*, 745–763. [[CrossRef](#)]
12. Kemp, I.C. *Pinch Analysis and Process Integration*; Elsevier: Amsterdam, The Netherlands, 2007.
13. Beninca, M.; Trierweiler, J. Heat integration of an Olefins Plant: Pinch Analysis and mathematical optimization working together. *Braz. J. Chem. Eng.* **2011**, *28*, 101–116. [[CrossRef](#)]
14. Linhoff, B.; Dunford, H.; Smith, R. Heat integration of distillation columns into overall processes. *Chem. Eng. Sci.* **1983**, *38*, 1175–1188. [[CrossRef](#)]
15. Feng, X.; Zhu, X.X. Combining Pinch and Exergy Analysis for Process modifications. *Appl. Therm. Eng.* **1997**, *17*, 249–261. [[CrossRef](#)]
16. Szargut, J. International progress in second law analysis. *Energy* **1980**, *5*, 709–718. [[CrossRef](#)]
17. Kotas, T. *The Exergy Method of Thermal Plant Analysis*; Krieger Publishing Company: Malabar, FL, USA, 1995.
18. Michael, M.J.; Howard, S.N. Exergy analysis. In *Fundamentals of Engineering Thermodynamics*, 5th ed.; Wiley: Hoboken, NJ, USA, 2006; pp. 272–325.
19. Khan, N.B.N.; Barifcani, A.; Tade, M.; Pareek, V. A case study: Application of energy and exergy analysis for enhancing the process efficiency of a three stage propane pre-cooling cycle of the cascade LNG process. *J. Nat. Gas Sci. Eng.* **2016**, *29*, 125–133. [[CrossRef](#)]
20. Tchanche, B.F.; Lambrinos, G.; Frangoudakis, A.; Papadakis, G. Exergy analysis of micro-organic Rankine powercycles for a small scale solar driven reverse osmosis desalination system. *Appl. Therm. Energy* **2010**, *87*, 1295–1306. [[CrossRef](#)]
21. Tirandazi, B.; Mehrpooya, M.; Vatani, A.; Moovasian, S.M.A. Exergy analysis of C2+ recovery plants refrigeration cycles. *Chem. Eng. Res. Des.* **2011**, *89*, 676–689. [[CrossRef](#)]
22. Mehrpooya, M.; Jarraghan, A.; Pishvaie, M.R. Simulation and exergy-method analysis of an industrial refrigeration cycle used in NGL recovery units. *Energy Res.* **2006**, *30*, 1336–1351. [[CrossRef](#)]
23. Thengane, S.K.; Hoadley, A.; Bhattacharya, S.; Mitra, S. Exergy efficiency improvement in hydrogen production process by recovery of chemical energy versus thermal energy. *Clean Technol. Environ. Policy* **2016**, *18*, 1391–1404. [[CrossRef](#)]
24. Feng, X.; Zhu, X.X.; Zheng, J.P. A practical exergy method for system analysis. In Proceedings of the Energy Conversion Engineering Conference, Washington, DC, USA, 11–16 August 1996.

25. Tsatsaronis, G.; Park, H. On Avoidable and Unavoidable Exergy Destructions and Investment Costs in Thermal Systems. *Energy Convers. Manag.* **2002**, *43*, 1259–1270. [[CrossRef](#)]
26. Morosuk, T.; Tsatsaronis, G. How to Calculate the Parts of Exergy Destruction in an Advanced Exergetic Analysis. In Proceedings of the 21st International Conference on Efficiency, Cost, Optimization, Simulation and Environmental Impact of Energy Systems, Cracow, Gliwice, Poland, 24–27 June 2008; pp. 185–194.
27. Tsatsaronis, G.; Morosuk, T. Advanced Exergoeconomic Evaluation and Its Application to Compression Refrigeration Machines. *ASME Conf. Proc.* **2007**, 859–868. [[CrossRef](#)]
28. Petrakopoulou, F.; Tsatsaronis, G.; Morosuk, T.; Carassai, A. Advanced Exergoeconomic Analysis Applied to a Complex Energy Conversion System. *ASME J. Eng. Gas Turbines Power* **2012**, *134*, 801–808. [[CrossRef](#)]
29. Merriam, W. *Heuristic Definition*; Encyclopedia Britannica: London, UK, 2014.
30. Eberle, R.F. Developing imagination through scamper. *J. Creat. Behav.* **1972**, *6*, 199–203. [[CrossRef](#)]
31. Sama, D. Looking at the True Value of Steam. *Oil Gas J.* **1980**, *78*, 103–119.
32. Sama, D. A Common-Sense 2nd Law Approach to Heat Exchanger Network Design. In Proceedings of the ECOS '92, Zaragoza, Spain, 15–18 June 1992; ASME: New York, NY, USA; pp. 329–338.
33. Sama, D.; Qian, S.; Gaggioli, R. A Common-sense Second Law Approach for Improving Process Efficiencies. In Proceedings of the TAIES'89, Beijing, China, 5–8 January 1989; Int.l Acad. Pub: Beijing, China, 1989; pp. 520–531.
34. Szargut, J.; Sama, D. Practical Rules of the Reduction of Energy Losses Caused by the Thermodynamic Imperfections of Thermal Processes. In Proceedings of the II International Thermal Energy Congress, Agadir, Morocco, 5–8 June 1995; Volume 2, pp. 782–785.
35. Papoulias, S.A.; Grossmann, I.E. A structural optimization approach in process synthesis—II. *Comput. Chem. Eng.* **1983**, *7*, 707–721. [[CrossRef](#)]
36. Grossmann, E. *Mathematical Methods for Heat Exchanger Network Synthesis*; Engineering Design Research Center, Carnegie Mellon University: Pittsburgh, PA, USA, 1992.
37. Zoughaib, A. *Méthode du Pincement.*; Techniques de l'ingénieur: Paris, France, 2015.
38. Center for Energy and Processes. Armines, Mines ParisTech. In *CERES-Chemins Énergétiques pour la Récupération d'Énergie dans les Systèmes Industriels*; Mines ParisTech: Paris, France, 2013.
39. Lee, G.C.; Smith, R.; Zhu, X.X. Optimal Synthesis of Mixed-Refrigerant Systems for Low-Temperature Processes. *Ind. Eng. Chem.* **2002**, *41*, 5016–5028. [[CrossRef](#)]
40. Shirazi, M.H.; Mowla, M. Energy optimization for liquefaction process of naturam gas in peak shaving plant. *Energy* **2010**, *35*, 2878–2885. [[CrossRef](#)]
41. Sanavandi, H.; Ziabasharhagh, M. Design and comprehensive optimization of C3MR liquefaction naturalgas cycle by considering operational constraints. *Nat. Gas Sci. Eng.* **2016**, *29*, 176–187. [[CrossRef](#)]
42. Aspelund, A.; Berstad, D.; Gundersen, T. *An Extended Pinch Analysis and Design Procedure Utilizing Pressure Based Exergy for Subambient Cooling*; Elsevier: Amsterdam, The Netherlands, 2007.
43. Gundersen, T.; Berstad, D.O.; Aspelund, A. *Extending Pinch Analysis and Process Integration into Pressure and Fluid Phase Considerations*; Sintef Energy Research: Trondheim, Norway, 2009. [[CrossRef](#)]
44. Marmolejo-Correa, D.; Gundersen, T. A new procedure for the design of LNG processes by combining Exergy and Pinch Analyses. In Proceedings of the Efficiency, Cost, Optimization, Simulation and Environmental Impact of Energy Systems, Perugia, Italy, 26–29 June 2012.
45. Linhoff, B.; Dhole, V. Shaft work targets for low temperature process design. *Chem. Eng. Sci.* **1992**, *47*, 2081–2091. [[CrossRef](#)]
46. Juthathip, T.; Kitipat, S. Combined Exergy-Pinch Analysis to Improve Cryogenic. *Chem. Eng. Trans. AIDIC* **2015**, *43*. [[CrossRef](#)]
47. Thibault, F.; Zoughaib, A.; Pelloux-Prayer, S. A MILP algorithm for heat integration in industrial processes. *ECOS* **2013**, *75*, 65–73.
48. Invensys Systems Inc. *PRO/II 9.3*; Lake Forest, Invensys Systems Inc.: Lake Forest, CA, USA, 1994–2014.
49. Flower, J.R.; Linhoff, B. Synthesis of heat exchanger networks: I. Systematic generation of energy optimal networks. *AIChE J.* **1978**, *24*, 633–642.
50. Bou Malham, C.; Rivera Tinoco, R.; Zoughaib, A.; Chretien, D.; Riche, M.; Guintrand, N. A Novel Hybrid Exergy/Pinch Process Integration Methodology. *Energy* **2018**, *156*, 586–596. [[CrossRef](#)]

51. Zoughaib, A.; Feidt, M.; Pelloux-Prayer, S.; Thibault, F. *Chemins Energétiques pour la Récupération d'énergies (CERES)*; Congrès Français de Thermique: Lyon, France, 2014.
52. Zoughaib, A. *From Pinch Methodology to Pinch-Exergy Integration of Flexible Systems*; ELSEVIER: Amsterdam, The Netherlands, 2017.



© 2019 by the authors. Licensee MDPI, Basel, Switzerland. This article is an open access article distributed under the terms and conditions of the Creative Commons Attribution (CC BY) license (<http://creativecommons.org/licenses/by/4.0/>).