



HAL
open science

Force-displacement relationship in micro-metric pantographs: experiments and numerical simulations

Francesco Dell'Isola, Emilio Turco, Anil Misra, Zacharias Vangelatos, Costas Grigoropoulos, Vasileia Melissinaki, Maria Farsari

► **To cite this version:**

Francesco Dell'Isola, Emilio Turco, Anil Misra, Zacharias Vangelatos, Costas Grigoropoulos, et al.. Force-displacement relationship in micro-metric pantographs: experiments and numerical simulations. *Comptes Rendus. Mécanique*, 2019, 347 (5), pp.397-405. <10.1016/j.crme.2019.03.015>. <hal-02269992>

HAL Id: hal-02269992

<https://hal.science/hal-02269992v1>

Submitted on 23 Aug 2019

HAL is a multi-disciplinary open access archive for the deposit and dissemination of scientific research documents, whether they are published or not. The documents may come from teaching and research institutions in France or abroad, or from public or private research centers.

L'archive ouverte pluridisciplinaire **HAL**, est destinée au dépôt et à la diffusion de documents scientifiques de niveau recherche, publiés ou non, émanant des établissements d'enseignement et de recherche français ou étrangers, des laboratoires publics ou privés.



HAL Authorization

Force-displacement relationship in micro-metric pantographs: experiments and numerical simulations

Francesco dell'Isola

Department of Structural and Geotechnical Engineering, University of Rome "La Sapienza", Italy

Emilio Turco*

Department of Architecture, Design and Urban planning, University of Sassari, Italy

Anil Misra

Department of Civil, Environmental and Architectural Engineering, The University of Kansas, USA

Zacharias Vangelatos, Costas Grigoropoulos

Department of Mechanical Engineering, University of California, Berkeley, USA

Vasileia Melissinaki, Maria Farsari

IESL-FORTH, Crete, Greece

Abstract

In this paper we reveal that the mathematical discrete model of Hencky-type, introduced in [1], is appropriate for describing the mechanical behavior of micro-metric pantographic elementary modules. This behavior does not differ remarkably from what has been observed for milli-metric modules, as we prove with suitably designed experiments. Therefore, we conclude that the concept of pantographic microstructure seems feasible for micro-metrically architected microstructured (meta)materials as well. These results are particularly indicative of the possibility of fabricating materials that can have an underlying pantographic microstructure at micrometric scale, so that its unique behavior can be exploited in a larger range of technological applications.

Keywords: Micro- and mini-pantographic lattices, Lagrangian models, Nonlinear analysis

1. Introduction

One of the frontiers of modern mechanics is the design of the so-called metamaterials or materials with architected properties. The scientific challenges are formidable, as competencies in a variety of fields of mechanical sciences are required. First,

the mathematical model which is the most convenient for the designed metamaterial must be established. The mechanical properties of potentially conceivable metamaterials can, then, be determined thoroughly. The established *a priori* mathematical model can, thus, be used to conceive the metamaterial of desired mechanical properties. The conceived metamaterials, with the *a priori* selected evolution equations, can then be fabricated by using either 3D printing or stereolithography. In other words, this stage includes the solution of the so called *synthesis problem*, see some details in [2, 3, 4, 5]. Finally, experiments must be designed to measure the relevant quantities and establish relationships which

*Corresponding author

Email addresses: francesco.dellisola@uniroma1.it (Francesco dell'Isola), emilio.turco@uniss.it (Emilio Turco), amisra@ku.edu (Anil Misra), zvangelatos@gmail.com (Zacharias Vangelatos), cgrigoro@berkeley.edu (Costas Grigoropoulos), melvas@iesl.forth.gr (Vasileia Melissinaki), mfarsari@iesl.forth.gr (Maria Farsari)

have been predicted theoretically.

In this paper we consider a metamaterial which preserves its elastic properties under relatively large deformations. We hypothesize that the mechanical behavior of such a metamaterial can be described by the discrete Hencky-type model introduced in [1] for pantographic modules. The numerical code developed in [6] was also adapted to serve as a guidance to the design of the experimental procedure in the presented study. A key point to consider relates to the smallest length scale at which the pantographic effect could be utilized. The question that needs to be elucidated is whether these geometries can be used as elementary substructures in 3D printed metamaterials. Through comparison of experimental measurements we show here that micro-metric pantographic elementary modules exhibit nearly the same pantographic effect as that shown by milli-metric modules. Images were captured using a Scanning Electron Microscope to reveal the deformation mechanism of the structure during the nanoindentation experiments. Comparison of these with similar images for milli-metric pantograph provide further evidence of the congruity in the behavior at the these disparate scales. What is even more remarkable is that the micro-metric elementary modules have been fabricated using a completely different 3D printing method in contrast to the milli-metric modules. We also show that the experimentally measured behavior of the micro-metric elementary modules can be efficiently described using the Hencky-type model.

On the basis of the presented results we can conclude that: *the concept of pantographic micro-structure, which allows for the design of metamaterials undergoing large elastic deformations, is also feasible to micro-structures having characteristic length of 50 micrometers.* Therefore, we are convinced that these elementary modules can be used for the microscopic architecture of novel metamaterials. The obtained results can undoubtedly pave the way to some interesting fields of research having relevant technological applications.

In the following sections we briefly describe the 3D printing process of micro-pantographs and their mechanical tests, see Sec. 2; then, in Sec. 3, we discuss the numerical results obtained from the Hencky-type numerical model introduced in [1, 6] comparing its results with those obtained from the corresponding experimental test. Finally, we discuss the key findings and their implications as part of the concluding remarks and future challenges in

Sec. 4.

2. 3D printing process of micro-pantographs

Micro-pantographs can be built by using the direct laser writing using multi-photon polymerization technology.¹ Figure 1 shows an image of the fabricated micro-metric pantograph elementary module obtained with the scanning electron microscope. With direct laser writing it is possible to print a 3D micro-pantograph using a beam of an ultrafast laser focused into the volume of a photo-sensitive material. A high-resolution 3D structure is obtained by moving the focus of the beam. After this printing, a proper solvent is used to dissolve the unscanned and the unpolymerized area revealing the 3D printed structure, see [8] for a detailed description of the complete process. All the chemicals used in this work were obtained from Sigma-Aldrich. The material used for the fabrication of the 3D structures is based on the organic-inorganic hybrid described in [9]. It has been produced by the addition of zirconium prop-oxide to methacryloxy-propyl trimethoxysilane. The monomer 2-(dimethylamino)ethyl methacrylate has been added as a quencher, and DMAEMA were used as the organic photopolymerizable monomers, while ZPO and the alkoxy-silane groups of MAPTMS served as the inorganic network forming moieties.

The experimental setup employed for 3D structure fabrication has been further described in [10, 11]. A FemtoFiber pro NIR laser (Ultrafast fiber laser, 78 nm, 80 MHz, <100 fs) was focused into the photopolymerizable composite using an objective lens (100, N.A.=1.4, Zeiss, Plan Aplanachromat). Sample movement was achieved using piezoelectric and linear stages, for fine and step movement, respectively (Physik Instrumente). The whole setup was computer-controlled using the customized software of A. Lemonis of IESL/FORTH. The average power used for the fabrication of the high-resolution structures was 2 mW, measured before the objective. The scanning speed was always set to 10 $\mu\text{m/s}$. To our knowledge, only the 2 photon polymerization technology can reach the resolutions needed to print the micro-metric structure shown in Fig. 1. In general, fabrication of such micro-scale structures is

¹See [7] for a prime on 3D printing technology of millimetric printing.

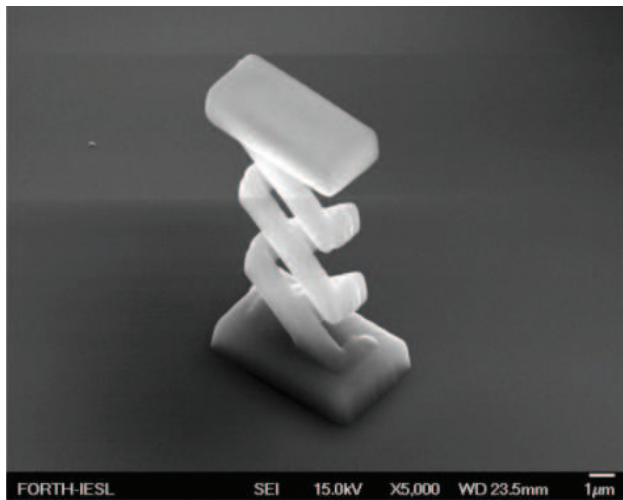

Figure 1: Micro-pantograph image obtained by a scanning electron microscope.

Table 1: Mechanical and geometrical parameters of the printed micro-pantograph (E in GPa, f , b , s , d and h in μm).

E	ν	f	b	s	d	h
0.5	0.45	7.49	0.72	1.7	2	0.8

not a trivial exercise although a number of printing approaches have been proposed, some of which are even commercially available. Nevertheless, the effort to realize such structures presented here amply demonstrates the feasibility of the approach.

The estimated mechanical and geometrical parameters of 3D printed micro-pantographs is reported in Table 1 (see also Fig. 2).

The printed micro-pantographs were subjected to compression loading using the Hysitron TI 950 TriboIndenter nano-indenter (Bruker.²)

The compression experiments were performed using displacement-control for a specific deformation profile. It was used so that any creep effects will be avoided while conducting the tests, see [14]. The deformation profile that was used is shown in Fig. 3. Force-displacement curves obtained testing two identical printed specimens are reported in Fig. 4.

²There is an alternative way to perform nano-indentation experiments by using an in-situ micro-indentation and Scanning Electron Microscope, see [12, 13].

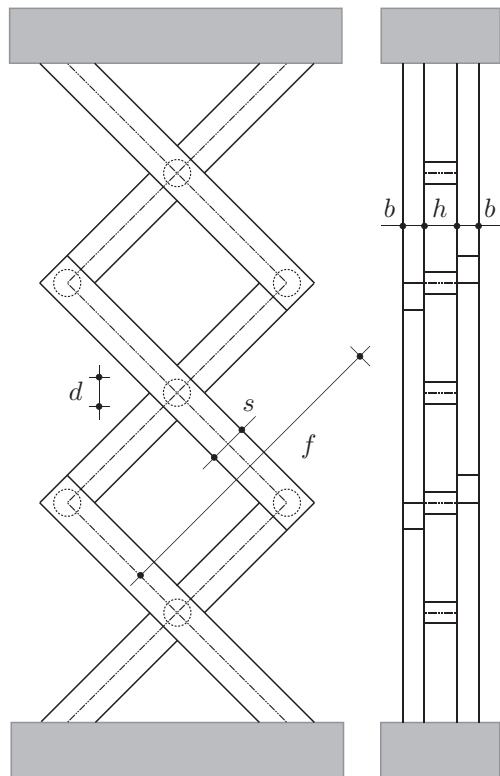

Figure 2: Schematic representation of the micro-pantograph geometry (frontal, on the left, and lateral, on the right, view).

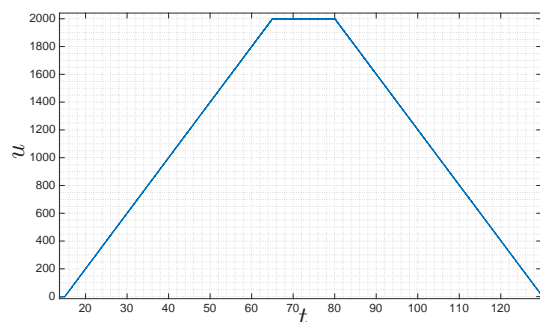

Figure 3: Displacement, u in μm , vs. time, t in s , plot.

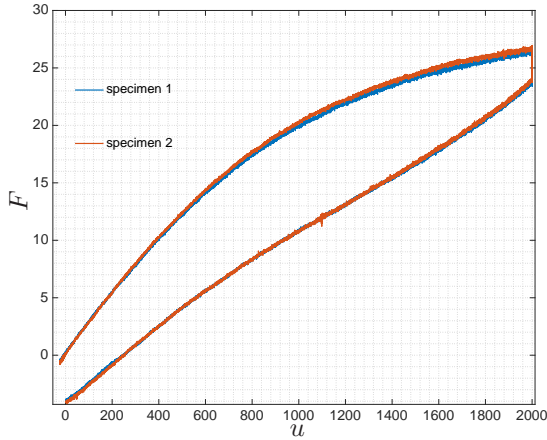

Figure 4: Force F in the direction of the longer side of the pantograph, in μN , vs. displacement u , in nm , for the compression test: experimental results for a pair of identical specimens.

3. Discrete model and numerical simulations

In a series of papers, see [1, 15, 16, 17, 18] we have shown that a very simple Lagrangian model can be used to predict accurately, and also with a very low computational cost in terms of memory engagement and computing time, the nonlinear mechanical behavior of pantographic structures.³ The same model was used to predict the first failure of specimen under shear test [21]⁴ and also to prove a relative insensitivity of the model to geometrical and mechanical imperfections, see [23].

We refer to [1] for a precise description of the Hencky-type model. Here we report only its key points: *i*) the pantograph is modeled as a plane lattice of beams connected by means of cylindrical pivots; *ii*) each beam is modeled as an extensible Euler beam by means of rigid links and elastic joints, extensional and rotational; *iii*) pivots are modeled as rotational elastic joints connecting the two sets of orthogonal beams. The ideas briefly sketched in the three key points above completely define the strain energy of each one elastic joint, and therefore of the whole pantographic lattice. Denoting a and b the extensional and flexural rigidity of the beams, respectively, and c the torsional rigidity of the pivots

³This is not the only practicable road, for example see the that proposed in [19, 20].

⁴See also the recent proposal concerning [22] for brittle materials.

strain energies are assumed as follows:

$$\begin{aligned} E_a &= \frac{1}{2}a(\ell - \ell_0)^2, \\ E_b &= b(\cos\beta + 1), \\ E_c &= \frac{1}{2}c\left(\gamma - \frac{\pi}{2}\right)^2, \end{aligned} \quad (1)$$

where ℓ and ℓ_0 are the current and reference length of the beam section in-between two consecutive elastic joints, respectively, β is the current angle between two consecutive rigid links of the same beam and γ is the current angle between two orthogonal beams which share the same pivot. This Hencky-type model was improved in [6, 24] refining the flexural part of the strain energy by simply adding an intermediate elastic joint for each beam section in-between two consecutive pivots. In [6] we compare the results of the numerical simulations with the experiments on milli-metric pantographs proving that, after an accurate identification of the rigidities, the results deriving from experiments and numerical simulations are closer, both in terms of deformations and predicted force relative to the imposed displacements. Naturally, to follow out-of-plane buckling phenomena a different kind of model is necessary, see, *e.g.*, the proposal reported in [25] for a continuum model or the 3D Hencky-type beam model [26] based on the suggestion reported in [27].

The simplistic, but very effective, model derived based upon the conjecture discussed in the preceding paragraphs along with an analysis strategy for solving the nonlinear equilibrium equations, see, *e.g.*, [6], has to be completed with a set of mechanical parameters, that is the rigidities of elastic joints, which have to be estimated by means of some physical or conceptual experiment. This identification has been performed in [6] for a millimetric pantographic lattice following the suggestions reported in [28, 29] using the results of an elongation test.

Here we use exactly the same methodology described in [6] to identify the rigidities of elastic joints used in the Lagrangian model of the pantographic lattice starting from the available data (the displacement-force plot reported in Fig. 4) obtaining a quick, surely improvable, guess of the elastic joint rigidities. Using the triplet $a = 300 \mu\text{N}/\mu\text{m}$, $b = 1 \mu\text{N}\mu\text{m}$ and $c = 100 \mu\text{N}\mu\text{m}$, the plot reported in Fig. 5 for the numerically obtained loading part of the displacement-force curve has been obtained (in order to make the comparison simple we have reported also the whole experimental curve for the specimen 2).

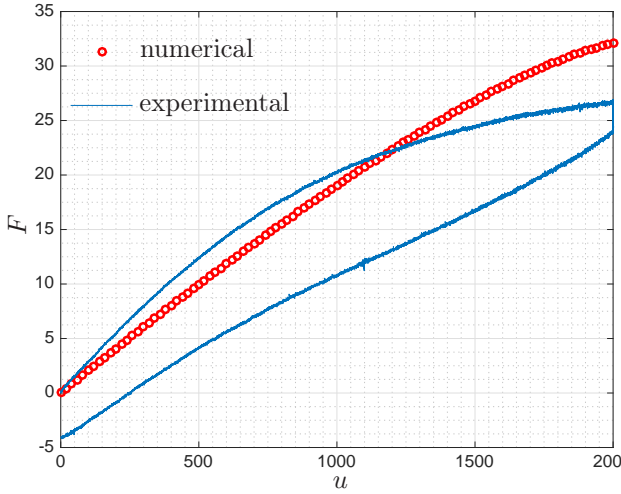

Figure 5: Force F in the direction of the longer side of the pantograph, in μN , vs. displacement u , in nm, for the compression test: numerical (in red) and experimental (in blue) results.

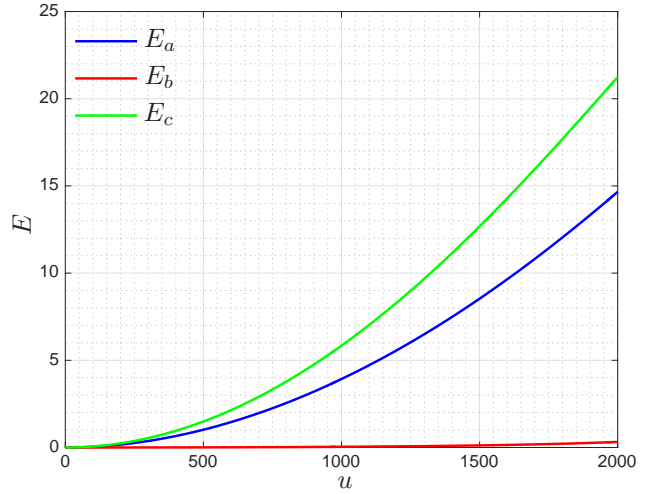

Figure 6: Strain energy, in $\mu\text{N}\mu\text{m}$, vs. the displacement u , in nm, for the compression test split in extensional E_a , bending E_b and shearing E_c part.

We remark that experimental and numerical curves, see Fig. 5, are closer, at least until values of given displacement u less than 1500 nm proving the quality of the simple Hencky-type model. In addition we observe that the numerical curve could be much more closer to the experimental one by changing the strain energy law (the law chosen for the Hencky-type model used to perform the calculation presented here is quadratic);

Figure 6 reports a plot of the strain energy as the imposed displacement u increases. The energy is split in the extensional E_a , the bending E_b and the shearing E_c (that referred to the torsion of pivots) part. It is remarked that for this case the extensional E_a and the shearing E_c part are similar. Conversely, the bending part E_b , which is referred to the beams, is negligible. This suggests, observing that the total volume of the beams is much less than the total volume of the pivots, that the energy density has its own peaks in the pivots.

Figure 7 reports the synopsis of the deformation history, that is the deformation corresponding to $u = 500, 1000, 1500$ and 2000 , along with the strain energy density plotted using a color scale on the beams.⁵ The energy density shows clearly the parts of the mini-pantograph which adsorb high level of strain energy.

⁵The energy referred to each one pivot is split in four equal contributions assigning each of these to the beams sharing the pivot.

At this stage we are unable to compare the deformation history obtained numerically with the experimental results due to non-availability of the measured deformation history. It is notable, however, that such a comparison may provide a further confirmation of the quality of the numerical results besides providing information useful for improving the identification of the rigidity parameters. Based upon our previous experience, we are confident that the results produced by numerical simulations obtained by the very simple model agree with the experimental ones. Our trust is supported by the comparison between experimental result on the mill-metric pantographic lattice (dimensions $13\text{ mm} \times 13\text{ mm}$) whose complete data are reported in the case of an elongation test in [6] under compression test and its numerical simulation. For reference we report here the comparison between the experimental and the numerically obtained deformations at the end of the loading process, see Fig. 8.

4. Concluding remarks and future challenges

The concept of pantographic structures as fundamental unit of novel metamaterials has been conceived in [30] from a purely theoretical point of view. The main features of conceived basic structures are the following: 1) at a lower length scale there are some elastic elements (*i.e.* the internal pivots, see Fig. 2) which offer an extremely weak resistance

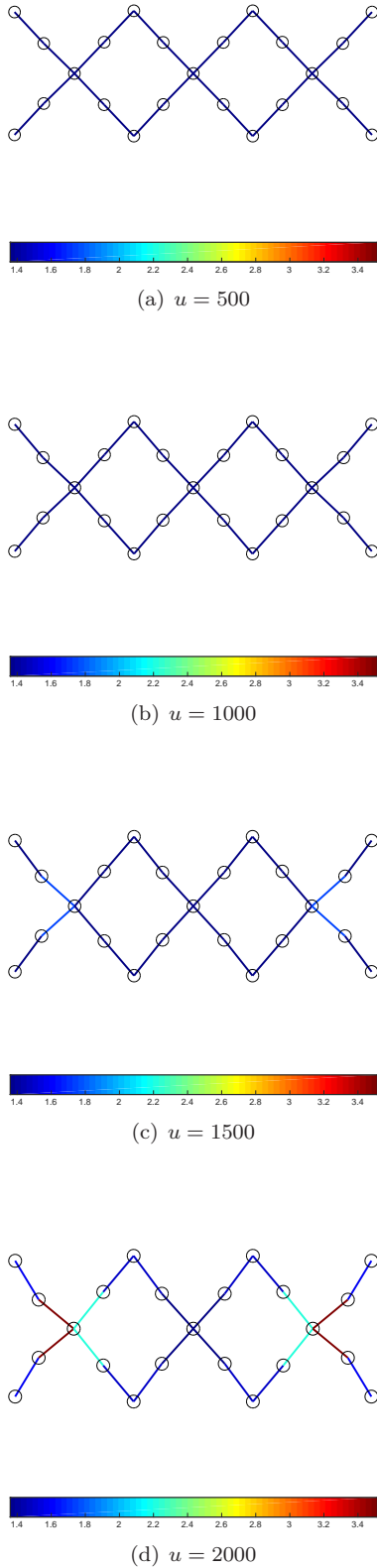

Figure 7: Compression test: synopsis of the deformation history for $u = 500, 1000, 1500$ and 2000 nm along with the strain energy density plotted using a color scale.

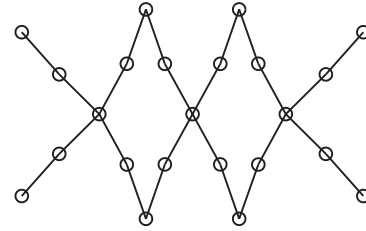

Figure 8: Compression test for a mini-pantograph (dimensions $13 \text{ mm} \times 13 \text{ mm}$): comparison between experimental (on the top) and numerical (on the bottom) deformation for an imposed displacement $u = 11.89 \text{ mm}$.

250 to some deformation, while the other elastic elements are capable to support external loads (*i.e.* the beams constituting the lattice whose bending and extensional stiffnesses are relatively stronger; 2) the lower scale structure allows for some macro-scale deformations at the expense of a relatively small deformation energy; 3) the most suitable macroscopic continuum model which is suitable for describing the novel metamaterial must include second gradient effects (see [31, 32]).

260 In [33] it has been proven that this concept has some potentialities as the specimens printed with 3D printing technology have shown a behaviour which is very close to the one forecast by the theoretical design analysis. However the lower length scale which has been considered up to now amounts to 1 millimetre and it has been questioned if smaller length scales could be exploited by keeping the desired macro-effects.

270 The results presented in this paper used a novel 3D printing technology which allowed us to produce pantographic specimens having length scale of one micrometer. The experimental apparatus which has been used is at the frontier of the present state-of-the-art and the obtained measurements were performed in a very precise and effective manner. In this paper it has been proven that micro-metric and milli-metric pantographic modules have a very similar behaviour. This is the result of the comparison among: *i)* numerical simulations with a Hencky-

280 type model; *ii*) experimental measurements with
 millimetres pantographs and *iii*) and experimental 335
 results obtained by using micrometric pantographs.
 As a consequence we believe that the design and
 construction of pantographic metamaterials having
 285 a microstructure whose length scale is 1 micrometer 340
 is a technologically feasible which offers avenues for
 novel and interesting engineering applications..

Going forward, the following research questions
 can be immediately recognized: 345

- 290 1. to get experimental measurements of the deforma-
 tion patterns of micro-pantographs and to
 compare the obtained measures with the avail- 350
 able numerical predictions;
- 295 2. to conceive a campaign of measurements in
 which the micrometric pantographs have dif- 355
 ferent geometrical properties; in particular the
 possibility to have internal pivots whose dimen-
 sions are different from the interconnected
 beams seems of a great relevance;
- 300 3. to start building larger specimens constituted 360
 by many micrometric pantographic modules.

More long term perspectives are very ambitious:
 to build a metamaterial undergoing large elastic de- 365
 formations which has a lower scale structure with
 characteristic dimensions of few micrometers. 305

References 370

- 310 [1] E. Turco, F. dell’Isola, A. Cazzani, and N. L. Rizzi.
 Hencky-type discrete model for pantographic structures:
 numerical comparison with second gradient continuum 375
 models. *Zeitschrift für Angewandte Math. und Physik*,
 67(4):1–28, August 2016.
- 315 [2] F. dell’Isola, D. Steigmann, and A. Della Corte. Synthe-
 sis of fibrous complex structures: Designing microstruc-
 ture to deliver targeted macroscale response. *Appl.*
Mech. Rev., 67(6):060804, 2015. 380
- [3] F. dell’Isola, T. Lekszycki, M. Pawlikowski, R. Gry-
 goruk, and L. Greco. Designing a light fabric
 metamaterial being highly macroscopically tough under
 directional extension: first experimental evi- 385
 dence. *Zeitschrift für angewandte Math. und Physik*,
 66(6):3473–3498, 2015.
- [4] U. Andreaus, F. dell’Isola, and M. Porfiri. Piezoelectric
 passive distributed controllers for beam flexural vibra-
 tions. *J. Vib. Control.*, 10(5):625–659, 2004. 390
- 325 [5] V. A. Eremeyev, F. dell’Isola, C. Boutin, and
 D. Steigmann. Linear pantographic sheets: Existence
 and uniqueness of weak solutions. *J. Elast.*, 132(2):175–
 196, 2018.
- 330 [6] E. Turco, A. Misra, R. Sarikaya, and T. Lekszycki.
 Quantitative analysis of deformation mechanisms in
 pantographic substructures: experiments and model- 395
 ing. *Continuum Mech. Thermodyn.*, in press, doi:
 10.1007/s00161-018-0678-y, 2018.
- [7] R. Golaszewski, M. and Grygoruk, I. Giorgio,
 M. Laudato, and F. di Cosmo. Metamaterials with
 relative displacements in their microstructure: tech-
 nological challenges in 3D printing, experiments and
 numerical predictions. *Continuum Mech. Thermodyn.*,
 Jun 2018.
- [8] I. Sakellari, E. Kabouraki, D. Gray, V. Purlys, C. Fo-
 takis, A. Pikulin, N. Bityurin, M. Vamvakaki, and
 M. Farsari. Diffusion-assisted high-resolution direct
 femtosecond laser writing. *ACS Nano*, 6(3):2302–2311,
 2012.
- [9] A. Ovsianikov, S. Z. Xiao, M. Farsari, M. Vamvakaki,
 C. Fotakis, and B. N. Chichkov. Shrinkage of mi-
 crostructures produced by two-photon polymerization
 of zr-based hybrid photosensitive materials. *Opt. Ex-
 press*, 17:2143–2148, 2009.
- [10] Frederik Claeyssens, Erol A. Hasan, Arune Gaiduke-
 viciute, Demetra S. Achilleos, Anthi Ranella, Carsten
 Reinhardt, Aleksandr Ovsianikov, Xiao Shizhou,
 Costas Fotakis, Maria Vamvakaki, Boris N. Chichkov,
 and Maria Farsari. Three-dimensional biodegradable
 structures fabricated by two-photon polymerization.
Langmuir, 25(5):3219–3223, 03 2009.
- [11] I. Sakellari, A. Gaidukeviciute, A. Giakoumaki, D. Gray,
 C. Fotakis, M. Farsari, M. Vamvakaki, C. Reinhardt,
 A. Ovsianikov, and B. N. Chichkov. Two-photon poly-
 merization of titanium-containing sol–gel composites
 for three-dimensional structure fabrication. *Appl. Phys.*
A, 100(2):359–364, 2010.
- [12] Lucas R. Meza, Satyajit Das, and Julia R. Greer.
 Strong, lightweight, and recoverable three-dimensional
 ceramic nanolattices. *Sci.*, 345(6202):1322–1326, 2014.
- [13] Lucas R. Meza, Gregory P. Philipot, Carlos M. Portela,
 Alessandro Maggi, Lauren C. Montemayor, Andre
 Comella, Dennis M. Kochmann, and Julia R. Greer.
 Reexamining the mechanical property space of three-
 dimensional lattice architectures. *Acta Materialia*,
 140:424 – 432, 2017.
- [14] S. Pathak, Z. G. Cambaz, S. R. Kalidindi, J. G.
 Swadener, and Y. Gogotsi. Viscoelasticity and high
 buckling stress of dense carbon nanotube brushes. *Car-
 bon*, 47(8):1969–1976, 2009.
- [15] E. Turco, M. Golaszewski, A. Cazzani, and N. L. Rizzi.
 Large deformations induced in planar pantographic
 sheets by loads applied on fibers: experimental valida-
 tion of a discrete Lagrangian model. *Mech. Res. Com-
 mun.*, 76:51–56, 2016.
- [16] E. Turco, K. Barcz, M. Pawlikowski, and N. L. Rizzi.
 Non-standard coupled extensional and bending bias
 tests for planar pantographic lattices. Part I: numeri-
 cal simulations. *Zeitschrift für Angewandte Math. und
 Physik*, 67(122):1–16, 2016.
- [17] E. Turco, K. Barcz, and N. L. Rizzi. Non-standard
 coupled extensional and bending bias tests for planar
 pantographic lattices. Part II: comparison with experi-
 mental evidence. *Zeitschrift für Angewandte Math. und
 Physik*, 67(123):1–16, 2016.
- [18] E. Turco, M. Golaszewski, I. Giorgio, and
 F. D’Annibale. Pantographic lattices with non-
 orthogonal fibres: experiments and their numerical
 simulations. *Compos. Part B: Eng.*, 118:1–14, 2017.
- [19] J. Niiranen, V. Balabanov, J. Kiendl, and S. B. Hosseini.
 Variational formulations, model comparisons and nu-
 merical methods for Euler–Bernoulli micro- and nano-
 beam models. *Math. Mech. Solids*, 24(1):312–335, 2019.

- [20] L. Greco and M. Cuomo. B-Spline interpolation of Kirchhoff–Love space rods. *Comput. Methods Appl. Mech. Eng.*, 256:251–269, 2013.
- [21] E. Turco, F. dell’Isola, N. L. Rizzi, R. Grygoruk, W. H. Müller, and C. Liebold. Fiber rupture in sheared planar pantographic sheets: numerical and experimental evidence. *Mech. Res. Commun.*, 76:86–90, 2016.
- [22] L. Placidi and E. Barchiesi. Energy approach to brittle fracture in strain-gradient modelling. *Proc. Royal Soc. A: Math. Phys. Eng. Sci.*, 474(20170878):1–19, 2018.
- [23] E. Turco and N. L. Rizzi. Pantographic structures presenting statistically distributed defects: numerical investigations of the effects on deformation fields. *Mech. Res. Commun.*, 77:65–69, 2016.
- [24] E. Turco, A. Misra, M. Pawlikowski, F. dell’Isola, and F. Hild. Enhanced Piola–Hencky discrete models for pantographic sheets with pivots without deformation energy: numerics and experiments. *Int. J. Solids Struct.*, 147:94–109, August 2018.
- [25] I. Giorgio, N. L. Rizzi, and E. Turco. Continuum modelling of pantographic sheets for out-of-plane bifurcation and vibrational analysis. *Proc. Royal Soc. A: Math. Phys. Eng. Sci.*, 473(20170636):1–21, November 2017.
- [26] E. Turco. Discrete is it enough? The revival of Piola–Hencky keynotes to analyze three-dimensional *Elastica*. *Continuum Mech. Thermodyn.*, 30(5):1039–1057, September 2018.
- [27] V. A. Eremeyev and H. Altenbach. *Shell-like Structures*. Springer International Publishing, 2017.
- [28] L. Placidi, U. Andreaus, A. Della Corte, and T. Lekszycki. Gedanken experiments for the determination of two-dimensional linear second gradient elasticity coefficients. *Zeitschrift für Angewandte Math. und Physik (ZAMP)*, 66(6):3699–3725, 2015.
- [29] I. Giorgio. Numerical identification procedure between a micro Cauchy model and a macro second gradient model for planar pantographic structures. *Zeitschrift für Angewandte Math. und Mech.*, 67(95):1–17, 2016.
- [30] J.-J. Alibert, P. Seppecher, and F. dell’Isola. Truss modular beams with deformation energy depending on higher displacement gradients. *Math. Mech. Solids*, 8(1):51–73, 2003.
- [31] J.-J. Alibert and A. Della Corte. Second-gradient continua as homogenized limit of pantographic microstructured plates: a rigorous proof. *Zeitschrift für Angewandte Math. und Physik*, 66(5):2855–2870, 2015.
- [32] J.-J. Alibert, A. Della Corte, I. Giorgio, and A. Battista. Extensional elastica in large deformation as Γ -limit of a discrete 1D mechanical system. *Zeitschrift für angewandte Math. und Physik*, 68(42), 2017.
- [33] F. dell’Isola, P. Seppecher, J. J. Alibert, T. Lekszycki, R. Grygoruk, M. Pawlikowski, D. J. Steigmann, I. Giorgio, U. Andreaus, E. Turco, M. Gólaszewski, N. Rizzi, C. Boutin, V. A. Eremeyev, A. Misra, L. Placidi, E. Barchiesi, L. Greco, M. Cuomo, A. Cazzani, A. Della Corte, A. Battista, D. Scerrato, I. Zurba Eremeeva, Y. Rahali, J.-F. Ganghoffer, W. Muller, G. Ganzosch, M. Spagnuolo, A. Pfaff, K. Barcz, K. Hoshcke, J. Negers, and F. Hild. Pantographic metamaterials: an example of mathematically driven design and of its technological challenges. *Continuum Mech. Thermodyn.*, 10.1007/s00161-018-0689-8, 2018.